

DT22

Dual Tuner with Sirius Capability



ELAN[®]
HOME SYSTEMS

 **WARNING** 
RISK OF ELECTRIC SHOCK
DO NOT OPEN!

CAUTION: TO REDUCE THE RISK OF ELECTRIC SHOCK, DO NOT REMOVE COVER (OR BACK). NO USER SERVICEABLE PARTS INSIDE. REFER SERVICING TO QUALIFIED SERVICE PERSONNEL.

CAUTION: RISK OF EXPLOSION IF BATTERY IS REPLACED BY AN INCORRECT TYPE. DISPOSE OF USED BATTERIES ACCORDING TO THE INSTRUCTIONS.



The lightning flash with arrowhead symbol within an equilateral triangle is intended to alert the user to the presence of uninsulated "dangerous voltage" within the product's enclosure that may be of sufficient magnitude to constitute a risk of electric shock to persons.



The exclamation point within an equilateral triangle is intended to alert the user to the presence of important operating and maintenance (servicing) instruction in the literature accompanying the appliance.

**WARNING: TO REDUCE THE RISK OF FIRE OR SHOCK,
DO NOT EXPOSE THIS APPLIANCE TO RAIN OR MOISTURE.**

 **CAUTION** 

Read Information—All the safety and operating information should be read before the appliance is operated.

Follow Information—All operating and use information should be followed.

Retain Information—The safety and operating information should be retained for future reference.

Heed Warnings—All warnings on the appliance and in the operating instructions should be heeded.

Wall Mounting—Mounting of this appliance should be done only by an authorized installer.

Ventilation—The appliances should be situated so that their location or position does not interfere with their proper ventilation. These appliances should never be placed near or over a radiator or heat register.

-These appliances should not be placed in a built-in installation such as a bookcase or cabinet that may impede the flow of air through the ventilation openings.

Non-Use Periods—Appliances that are left unattended and unused for long periods of time should be de-energized.

Grounding or Polarization—Do not defeat the safety purpose of the polarized or grounding-type plug. A polarized plug has two blades with one blade wider than the other blade. A grounding type plug has two blades and a third grounding prong. The polarized wide blade and the third prong are provided for your safety. If the provided plug does not fit your outlet, consult an electrician for replacement of the obsolete outlet.

Power Cord Protection—Protect the power cord from being walked on or pinched particularly at plugs, convenience receptacles and the point where they exit from the apparatus.

Water—Do not use the apparatus near water.



Cleaning—Unplug the apparatus from the power outlet before cleaning. Use only a dry cloth to clean the apparatus.

Power Lines—An outdoor antenna should be located away from power lines. When installing an outside antenna system, extreme care should be taken to avoid touching power lines or circuits, as contact with them may be fatal.

Object and Liquid Entry—Never insert objects of any kind through the openings of these appliances, as they may touch dangerous voltage points or short-out parts that could result in a fire or electric shock. Care should be taken so that objects do not fall and liquids are not spilled into the appliance through openings in the enclosure.

Servicing—Do not attempt to service these appliances yourself, as opening or removing covers may expose you to dangerous voltage or other hazards. Refer all servicing to qualified service personnel.

Damage Requiring Service—These appliances should be serviced by qualified service personnel when:

- A power supply connection or a plug has been damaged or
- If liquid has been spilled into the appliance or objects have fallen into the appliance or
- The appliance has been exposed to water or moisture or
- The appliance does not appear to operate normally or exhibits a marked change in performance or
- The appliance has been dropped or the enclosure damaged.

Replacement Parts—When replacement parts are required, be sure the service technician has used replacement parts specified by the manufacturer or that have the same characteristics as the original part. Unauthorized substitutions may result in fire, electric shock, or other hazards. The Master Control Unit battery should be replaced only after turning the power off and only by an authorized installer.

Safety Check—Upon completion of any service or repairs to this audio product, ask the service technician to perform safety checks to determine that the audio product is in proper operating condition.

Lightning Storms—Unplug this apparatus during lightning storms or when unused for long periods of time.

Attachments and Accessories—Use only attachments/accessories specified by the manufacturer.

Cart, Stand, Tripod, Bracket or Table—Use only with a cart, stand, tripod, bracket or table specified by the manufacturer, or sold with the apparatus. When a cart is used, use caution when moving the cart/apparatus combination to avoid injury from tip over.

Disconnect Device—Where the mains plug or an appliance coupler is used as the disconnect device, the disconnect device shall remain operable.

NOTE:

This equipment has been tested and found to comply with the limits for a Class B digital device, pursuant to part 15 of the FCC Rules. These limits are designed to provide reasonable protection against harmful interference in a residential installation. This equipment generates, uses and can radiate radio frequency energy and, if not in-stalled and used in accordance with the instructions, may cause harmful interference to radio communications. However, there is no guarantee that interference will not occur in a particular installation. If this equipment does cause harmful interference to radio or television reception, which can be determined by turning the equipment off and on, the user is encouraged to try to correct the interference by one or more of the following measures:

- Reorient or relocate the receiving antenna.
- Increase the separation between the equipment and receiver.
- Connect the equipment into an outlet on a circuit different from that to which the receiver is connected.
- Consult the dealer or an experienced radio/TV technician for help.

CAUTION:

Changes or modifications not expressly approved by Elan Home Systems could void the user's authority to operate the equipment.



Table of Contents

Intro	8
Highlights.....	10
Items in package.....	10
Front Panel (Hard Buttons).....	11
Front Panel LCD.....	12
Rear Panel	13
Rack Mounting.....	14
Connections	15
IR	15
RS-232.....	15
VIA!NET	16
Ethernet	17
RCA Audio	18
OPTICAL Audio	18
AM Loop Antenna.....	19
FM Antenna.....	19
Rear Panel Power Switch.....	22
Operation	22
Front Panel.....	23
Mode Menu.....	24
AM/FM	24
Preset/Direct	24
Stereo/Mono	25
Saving Presets.....	26
Deleting Presets.....	26
Override	27
Change Custom Text	27
Remove Custom Text.....	29
Changing Genre	30
Removing Genre Override.....	31
Details	32
System Configuration	33
Unit ID	33
LCD Settings.....	34

LCD Timeout.....	35
LCD Contrast	36
LCD Brightness.....	37
Front Panel IR.....	38
RS232.....	39
Baud Rate	39
Unsolicited Feedback	40
Ethernet	41
Configuration Type.....	41
Static Parameters.....	42
Show Current.....	45
ZNet Bridge.....	46
Region	47
Version Info	48
Restore Defaults	49
Remote Control Operation	50
Troubleshooting.....	52
Appendix A Specifications	56
Appendix B: Serial Protocol	57
Port Configuration	57
Messages.....	57
Unsolicited Feedback notifications.....	57
Query/Response Command Structure	57
Dump Command Structure	58
Status Command Structure	58
Command Structure.....	58
<COMMAND>.....	58
Power On/Off/Toggle.....	58
Select.....	59
Display On	59
Reboot	59
Config	60
Config RS232 Unsolicited Feedback On/Off.....	61
UFB On/Off (Unsolicited Feedback).....	62
Boot Version	63
Code Version.....	63

Mode: Direct/Preset	63
Digit	64
Enter	64
Cancel	64
Group.....	64
Preset.....	65
MDF (Metadata Feedback)	67
Signal.....	68
Scan.....	68
AM/FM Band	69
Tune	69
Seek.....	70
Stereo	70
Appendix C: Adding SIRIUS Radio Functionality.....	72
Connecting the SIRIUS Tuner Module	72
Displaying Signal Strength.....	72
Connecting Audio Outputs	72
Tuner Activation	72
Selecting the SIRIUS Tuner.....	73
Direct Mode Operation.....	73
Category Mode Operation	73
Preset Mode Operation	74
Recalling Presets	74
Displaying SIRIUS Firmware Version and Product ID.....	74
Viewing DT22 Firmware Version.....	74



Introduction

Thank you for choosing the ELAN DT22 Dual AM/FM Tuner. The ELAN DT22 Dual Tuner is two AM/FM digital tuners in one standard-sized audio component. Each tuner has its own audio output so that each may be listened to independently. The DT22 features a total of 396 AM/FM presets plus 396 SIRIUS presets per chassis. When used in conjunction with ELAN Touch Panels, the combination of Direct Access tuning and a plethora of Presets makes control of the DT22 easy and intuitive – from anywhere in your home.

The DT22 includes a front panel IR receiver, full function handheld remote, and rear panel control ports for IR, VIA!NET and serial control. Two-way feedback, including station call letters, frequency, genre, song name and artist, can be displayed on any ELAN Touch Panel or Olé Interactive Touchpad without the use of an SS1, SC1 or SC4.

With a 128 x 64 graphical LCD and front panel button access, the setup is easy. Through guided setup processes including Network and Ethernet to a full diagnostics menu that includes signal strength and SIRIUS signal detection the DT22 allows the installation to be intuitive. Even the programming of favorite stations by the user is guided to allow easy setup.

NOTE: The SCH1 (sold separately) is all that is needed to add SIRIUS Satellite Radio to an ELAN DT22 Dual Tuner. Refer to Appendix C for detailed setup and use information.

Package Contents

- A** SCH1 SIRIUS Connect Tuner
- B** Windowsill Antenna
- C** AC Power Adapter
- D** DIN Cable

A



C

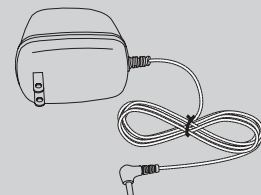

B

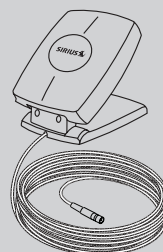

D

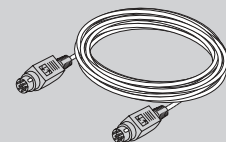

Listening to Satellite Radio

To listen to Satellite Radio, you'll need to connect a SIRIUS-Ready receiver. SIRIUS Satellite Radio is available to residents of the US (excluding Alaska and Hawaii) and Canada.

Satellite Radio delivers a variety of commercial-free music from categories ranging from Pop, Rock, Country, R&B, Dance, Jazz, Classical and many more plus coverage of all top professional and college sports including play by play games from select leagues and teams. Additional programming includes expert sports talk, uncensored entertainment, comedy, family programming, local traffic and weather and news from your most trusted sources.

Once you've purchased a Sirius tuner you'll need to activate it and subscribe to begin enjoying the service. Easy to follow installation and setup instructions are provided with the SIRIUS tuner. There are a variety of programming packages available, including the option of adding "The Best of XM" to the SIRIUS service enabling you to enjoy the most popular programming among both services. Family friendly packages are also available to restrict channels featuring content that may be inappropriate for children.

To subscribe to SIRIUS, U.S. and Canadian customers can call 1-888-539 SIRI (1-888-539-7474) or visit sirius.com (US) or siriuscanada.ca (Canada).



SIRIUS, XM and all related marks and logos are trademarks of SIRIUS XM Radio Inc. and its subsidiaries. All other marks and logos are the property of their respective owners. All rights reserved. SIRIUS subscription sold separately. Taxes and a one-time activation fee may apply. SIRIUS tuner required (sold separately) to receive the SIRIUS service. All programming and fees subject to change. It is prohibited to copy, decompile, reverse engineer, hack, manipulate or otherwise make available any technology or software incorporated in receivers compatible with the SIRIUS Satellite Radio System. **Service not available in Alaska or Hawaii.**

Product Highlights

- Two AM/FM Digital Tuners
- Satellite Radio Ready. Add one or two SIRIUS Tuner Modules (sold separately)
- Four Sets of independent Outputs for Multi-Room Listening
- Link Two DT22s to Provide Up to 4 AM/FM Tuners and 4 SIRIUS Tuners
- Preset or Direct Numeric Access
- 4 Preset Groups labeled A, B, C, and D for easy preset organization.
- 99 flexible presets in each group. Each preset can hold either an AM, FM, or SIRIUS station.
- 396 Presets shared across 2 AM/FM Tuners plus 396 Presets shared across 2 SIRIUS Tuners.
- Easy Setup and Diagnostics With Front Panel Buttons and Graphical LCD
- View Radio Station & “Now Playing” RDS information on ELAN User interfaces (EM version VIA! panels only)
- VIA!NET, Ethernet, Serial and IR Controllable.
- Use With Any ELAN Wireless Touch Panel, Olé Touch Pad, or EM version LCD Touch Panel.
- New ELAN SmartSource (Does not require a System SS1, SC1 or SC4 for Two-Way Feedback)
- Displays RDS (Radio Data System)
- cTUVus Certified, CE®, CB Scheme, FCC part 15, and C-tick

Items in package

- DT22 Tuner
- Rack Mount Brackets
- DT22 Remote Control
- AM Loop Antenna
- FM Antenna
- Installation Manual
- AC line cord
- SIRIUS Tuner Modules sold separately

Front Panel (Hard Buttons)

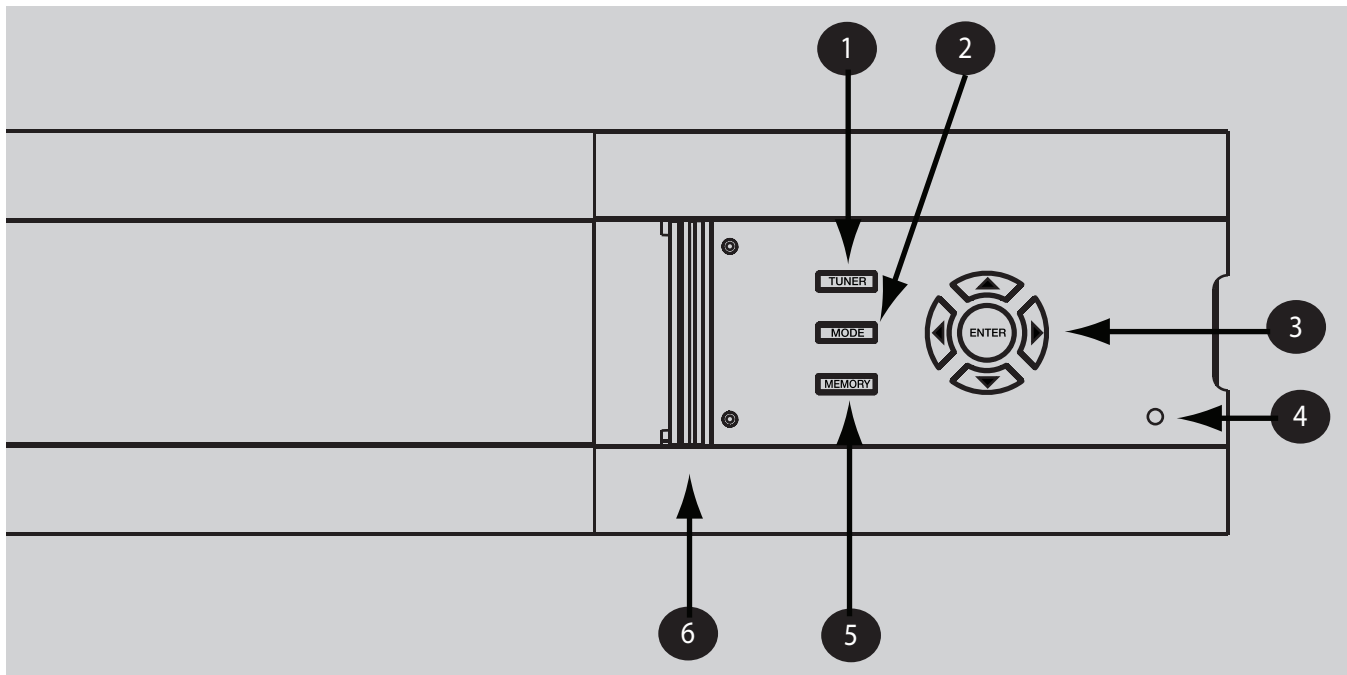

DT22 Front Panel Controls & Indicators

Item	Name	Item	Name
1	Tuner Select Button	4	Power LED
2	Mode Button	5	Memory Button
3	Navigation Arrows and Enter Button	6	Access Door (Shown Open)

Front Panel LCD

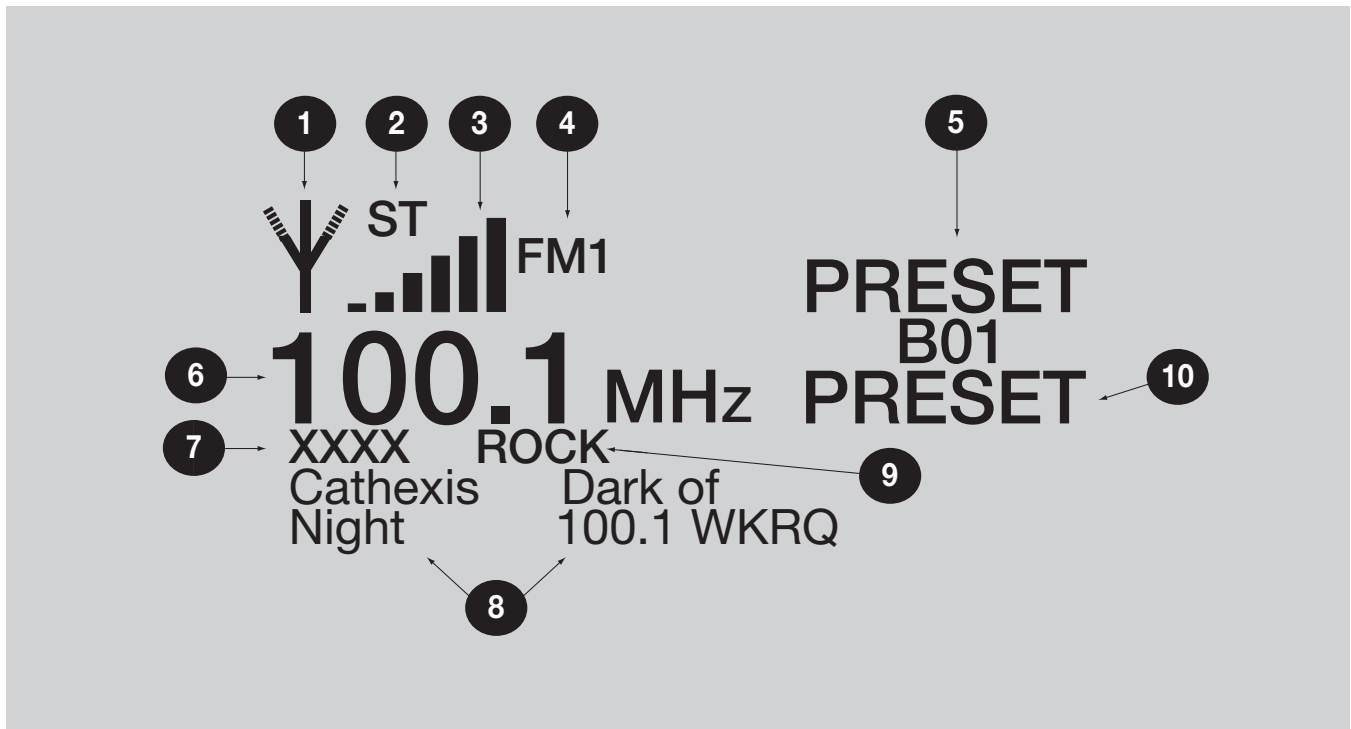

Graphical LCD

Item#	Function	Item#	Function
1	Signal Indicator	6	Station Frequency
2	Stereo Indicator	7	Custom Text
3	Signal Strength Indicator Bar	8	RDS Radio Text
4	Tuner Mode Indicator	9	Station Genre/Category
5	Current Tuned Preset	10	Preset/Direct/Category Mode

Rear Panel

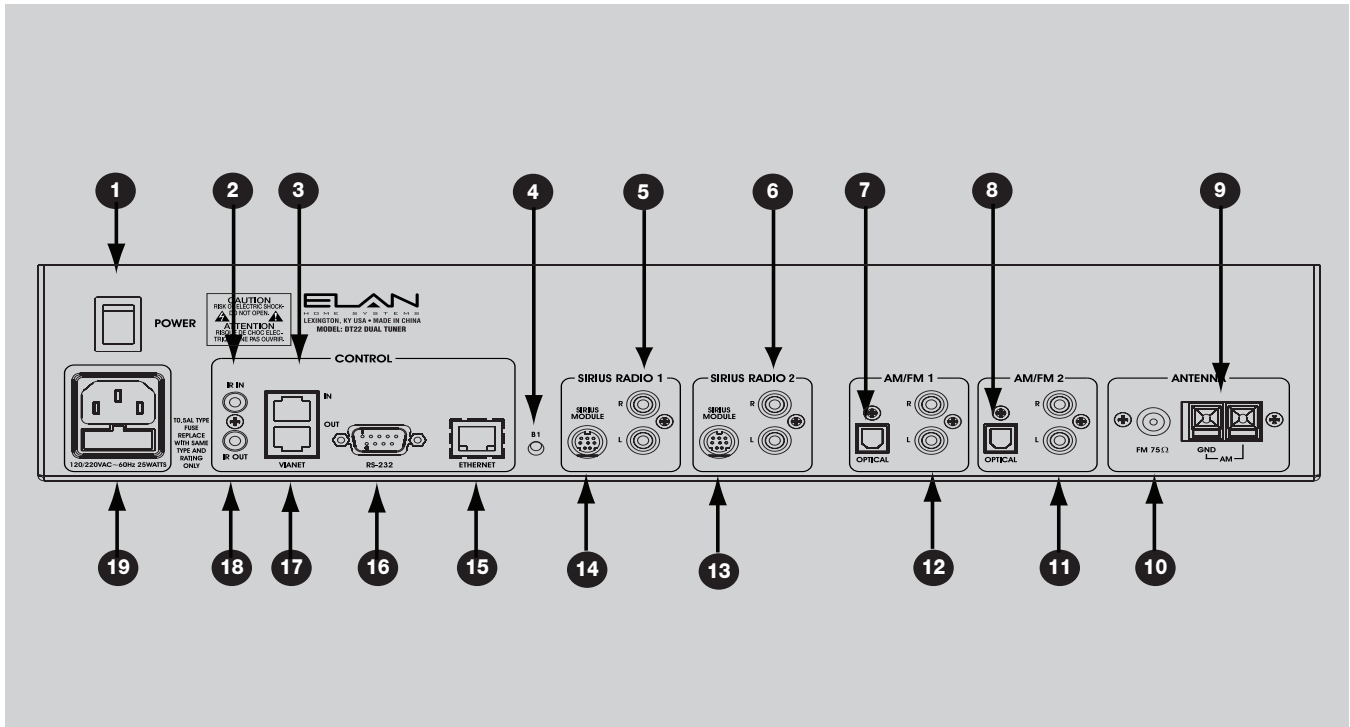

Rear Panel Connections

Item#	Function	Item #	Function
1	Power Switch	11	AM/FM 2 Analog RCA Output
2	IR IN	12	AM/FM 1 Analog RCA Output
3	VIA!NET Input	13	SIRIUS 2 Analog RCA Output
4	B1 Button	14	SIRIUS 1 Analog RCA Output
5	SIRIUS Tuner Module 1 Connection	15	Ethernet Port
6	SIRIUS Tuner Module 2 Connection	16	RS-232 Port
7	AM/FM 1 Digital Audio Output	17	VIA!NET Out
8	AM/FM 2 Digital Audio Output	18	IR OUT
9	AM Antenna Connector	19	Power Inlet/Fuse Holder
10	FM Antenna Connector		

Rack Mounting

When mounting the DT22 Tuner in an equipment rack, use the included Rack Mount Brackets for secure mounting and proper ventilation. The DT22 requires two rack spaces.

To install the DT22 into a standard 19" equipment rack:

1. Slide the rack mount brackets onto the DT22 chassis from the front as shown in **Figure 14-1**.

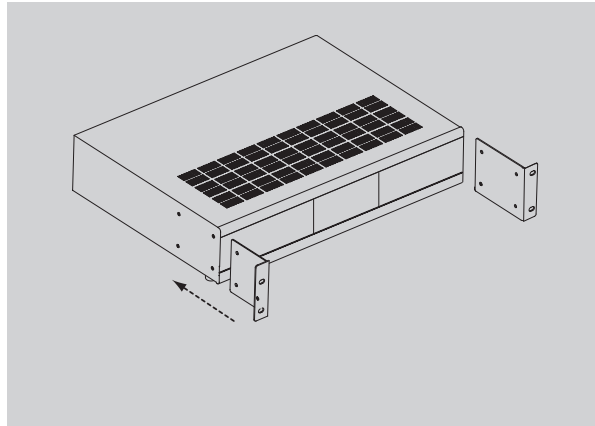

2. Ensure that the brackets are flush with the front of the unit. Install each of the eight screws (included) through the side mounting flanges into the holes in the sides of the unit as shown in **Figure 14-2**. Hand tighten screws! Over-tightening could cause damage to the DT22 Tuner.

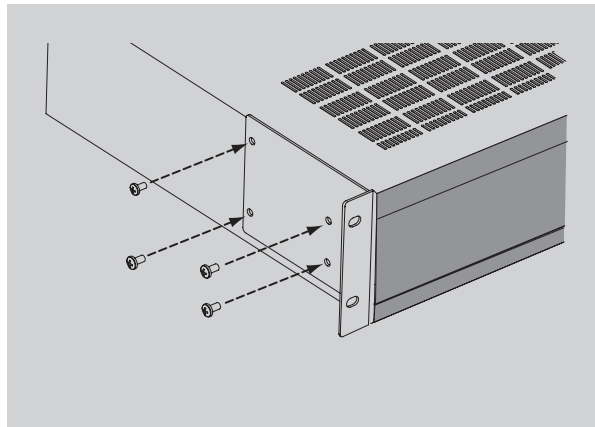

3. Once the brackets are securely mounted, install the entire assembly into a standard 19" equipment rack from the front using four rack screws (not included). Two rack spaces will be used. See **Figure 14-3**.

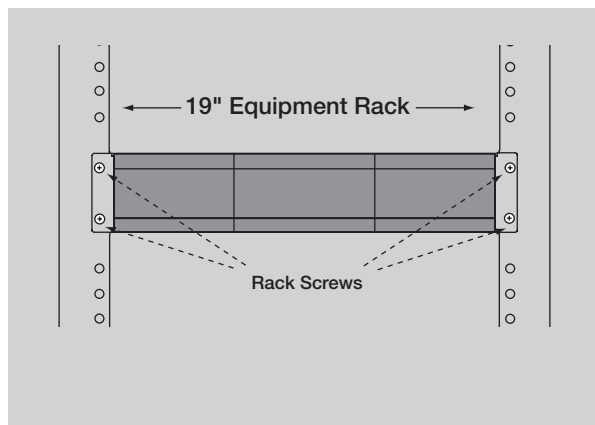

Connections

IR

The DT22 can be controlled using the 3.5mm ('mini') IR jack on the back panel. There is also an IR Loop Output jack included to connect to additional DT22s.

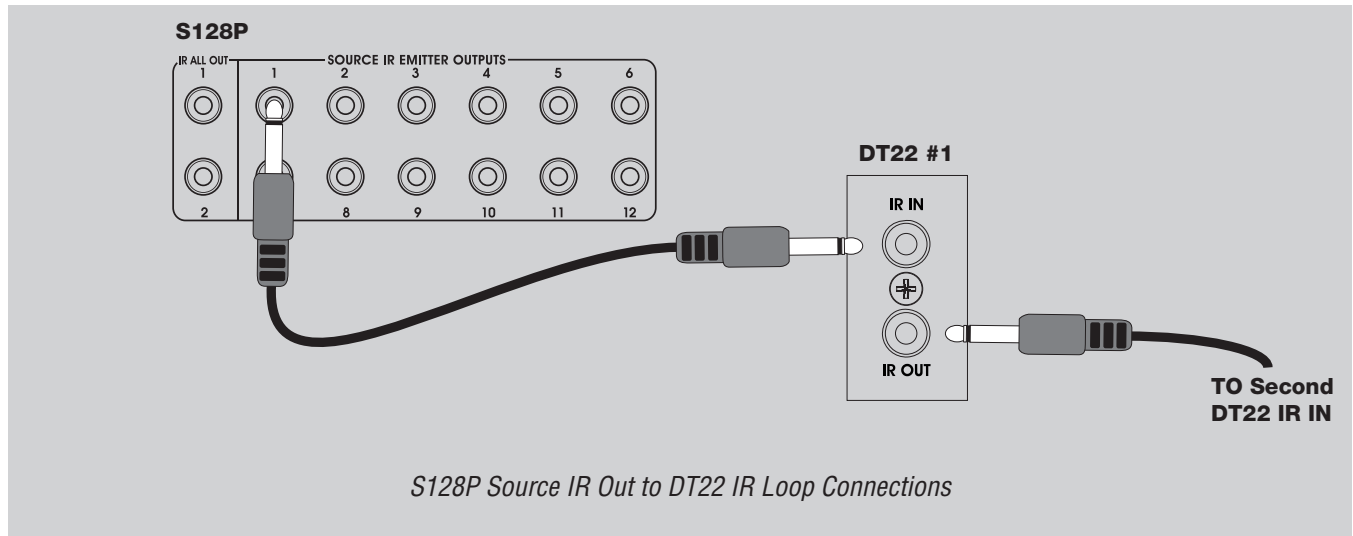

RS-232

The RS232 port on the back of the unit is used to connect the DT22 to a computer to facilitate firmware updates and download tuner configuration parameters for troubleshooting. It can also be used to control Direct and Preset features.

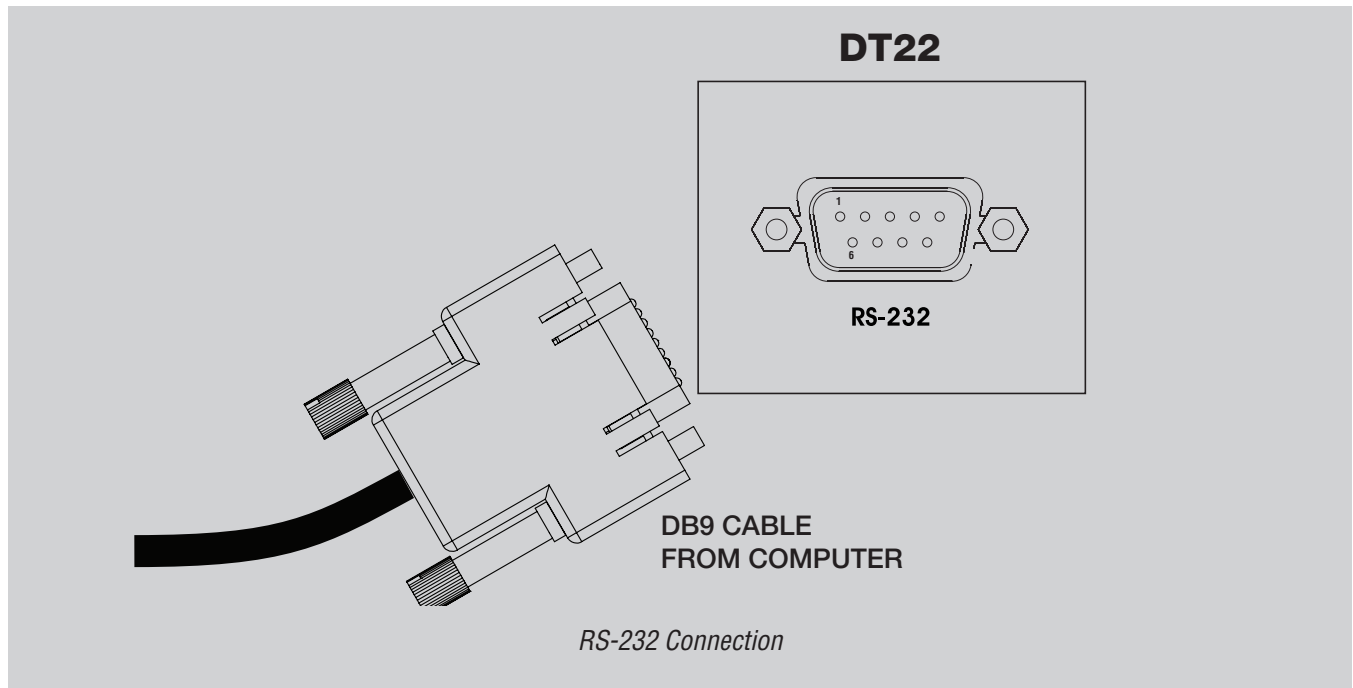

VIA!NET

Use the VIA!NET ports when controlling the DT22 with ELAN Touch Panels, SC-1 Serial Controller, SS1 System Station and/or other VIA!NET devices. The VIA!NET ports on the DT22 can be daisy-chained between chassis and other VIA!NET devices.

Use an RJ-45 to RJ-45 interconnect cable to make all VIA!NET connections.

Use the following diagram when connecting a S86A/S86P and not using an SPP.

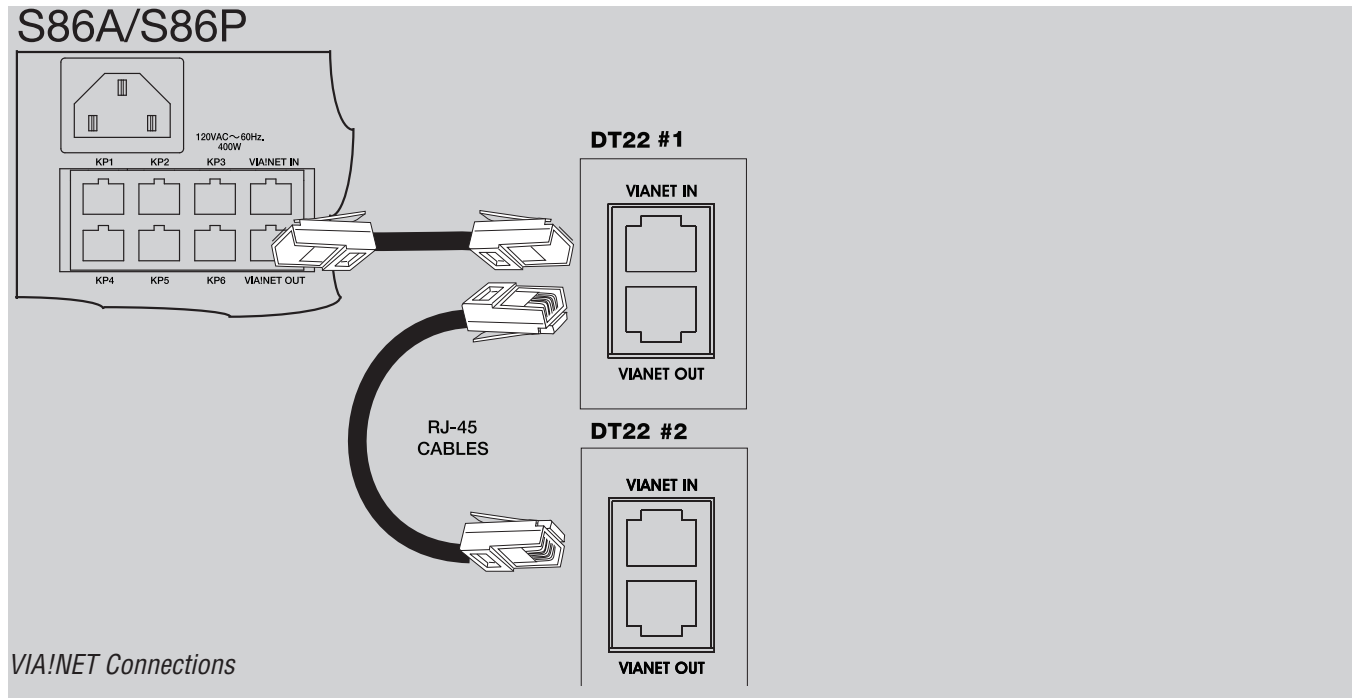

If there is not a System SS1 or System SC1 in the system, make the following connections.

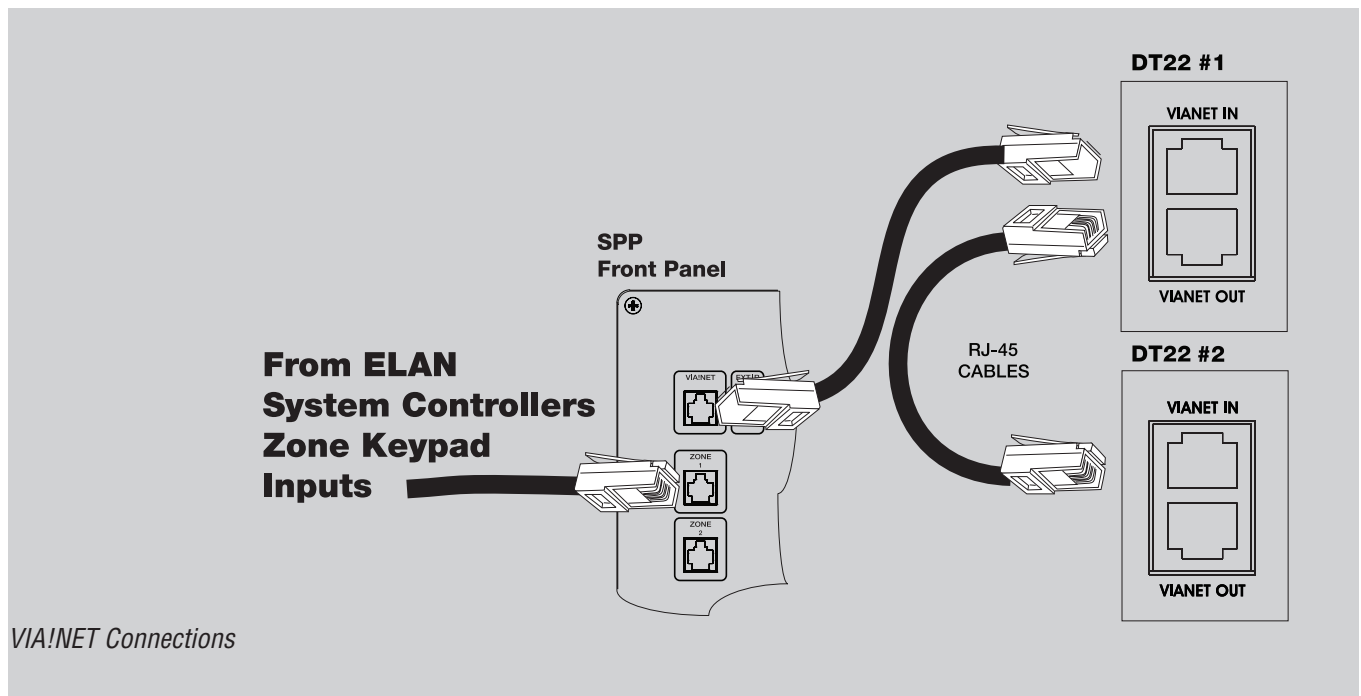

If a System SS1 or System SC1 is in the system, use the following connections.

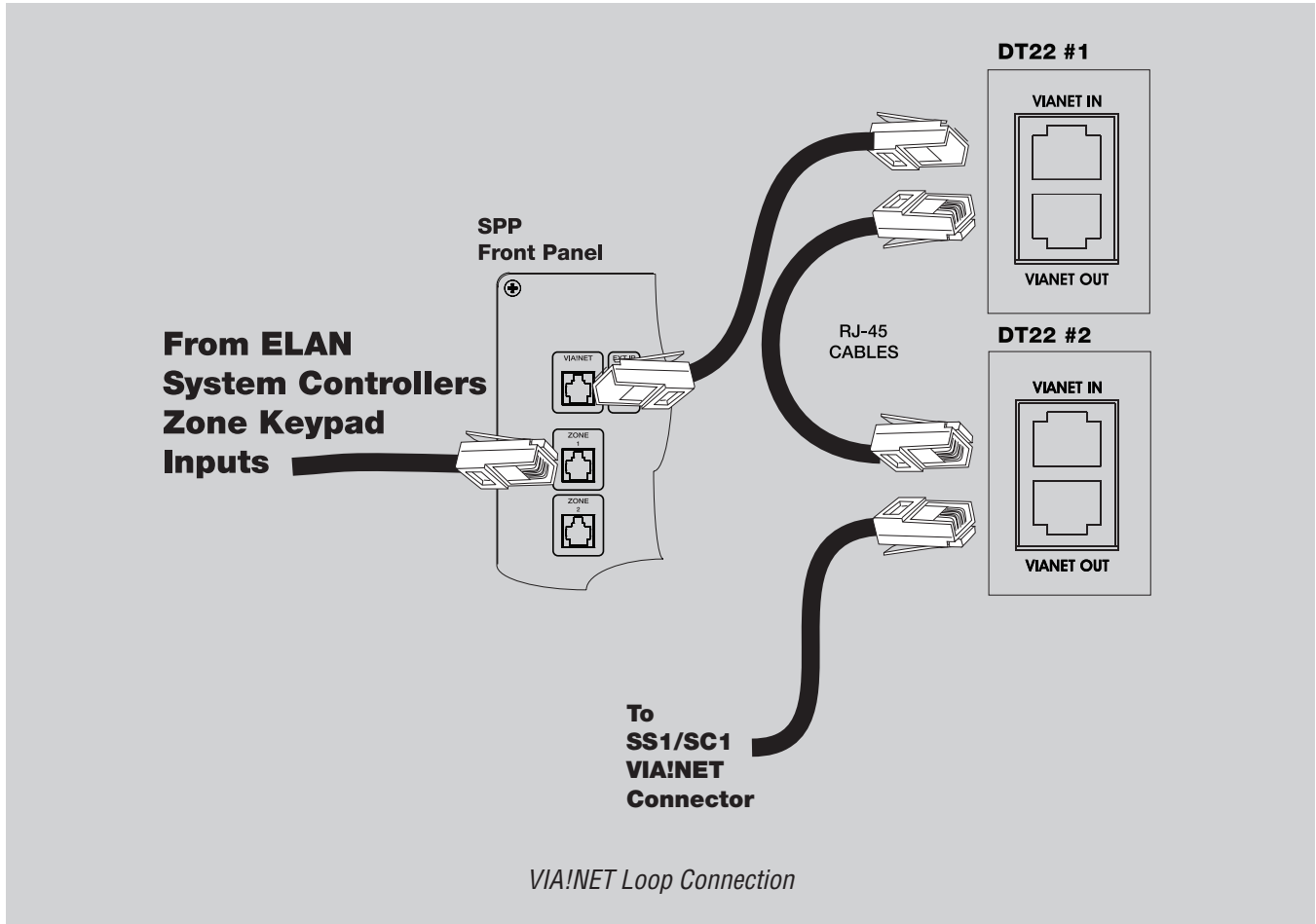

Ethernet

The **ETHERNET** port can be used to connect the DT22 to a LAN (Local Area Network) connection for Firmware Updates. It may also be used by supported software applications to communicate with the DT22. An Ethernet cable wired to T568A (or T568B) should be used in conjunction with this connection.

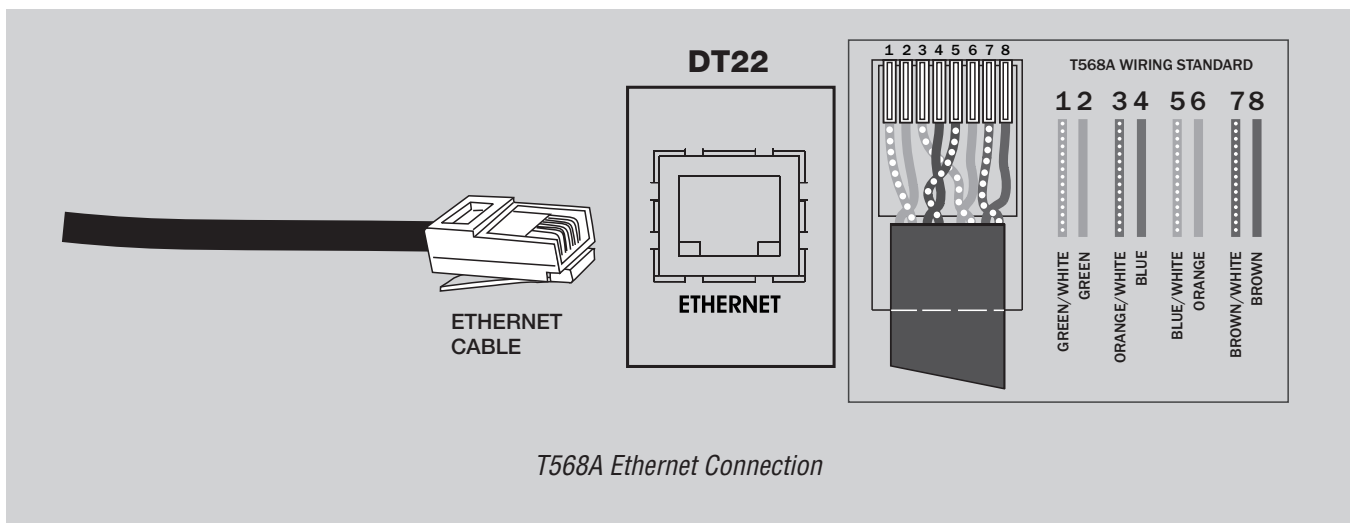

RCA Audio

Using RCA-type interconnect cables, connect all active tuner audio outputs to pairs of inputs on an ELAN preamp controller (e.g. S66A, S86A/P, S128P or to a stereo receiver). Make sure to connect Left channel outputs to Left channel inputs and Right channel outputs to Right channel inputs.

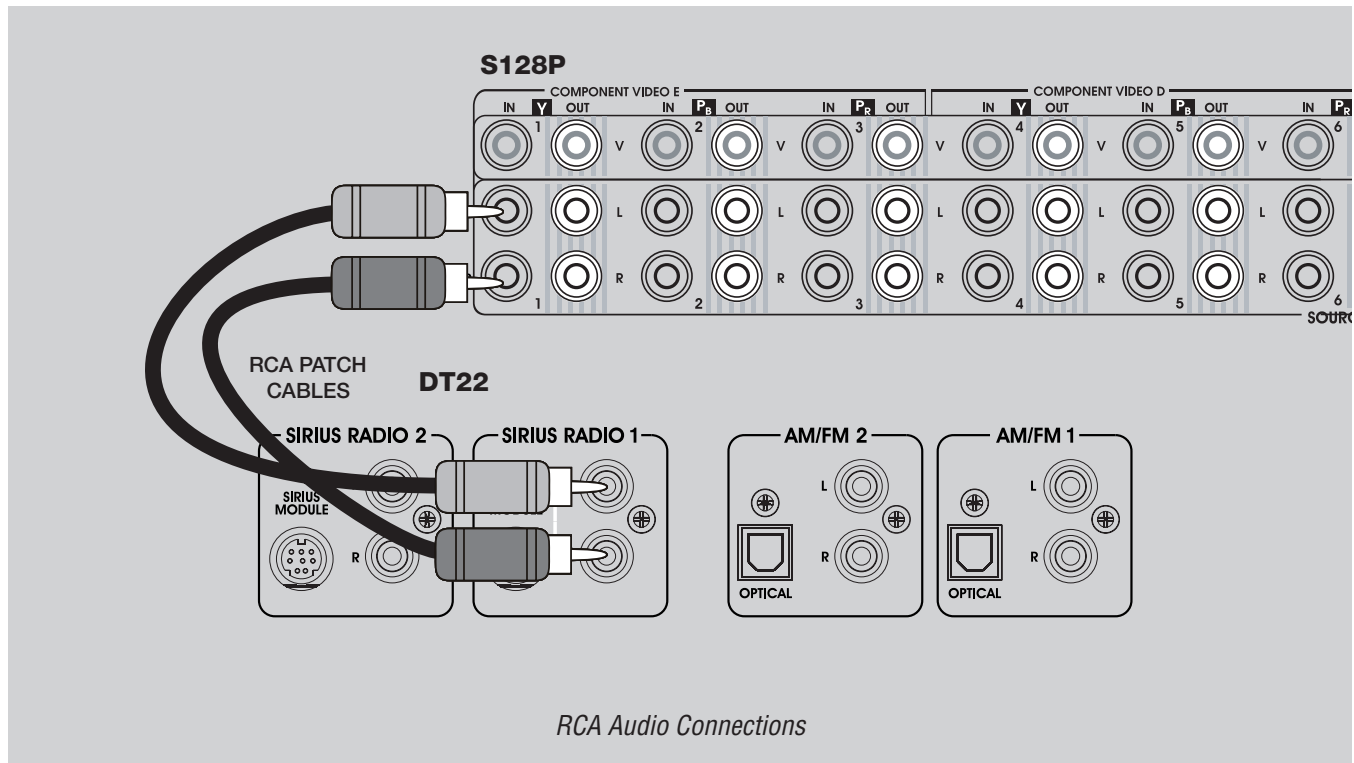

OPTICAL Audio

Using an Optical interconnect cable, connect TUNER 1 and/or TUNER 2 Optical output(s) to any Optical input(s) on a Stereo Receiver, Digital Audio Wallplate, or Home Theater Receiver.

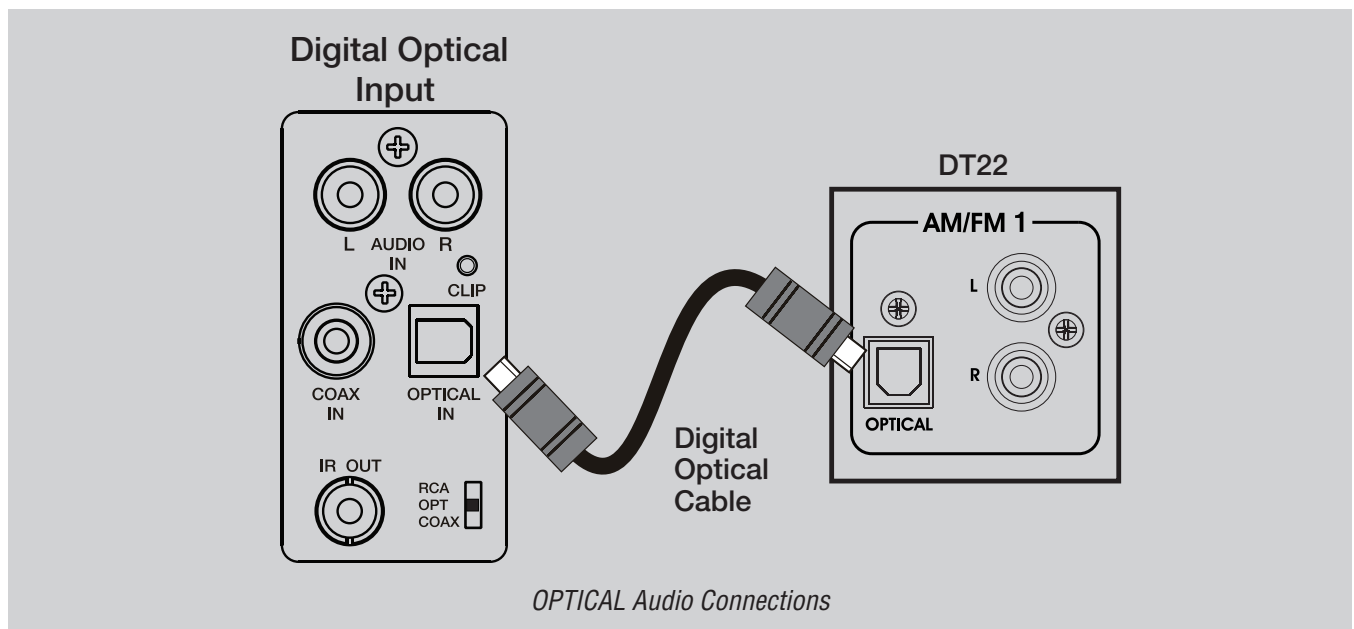

AM Loop Antenna

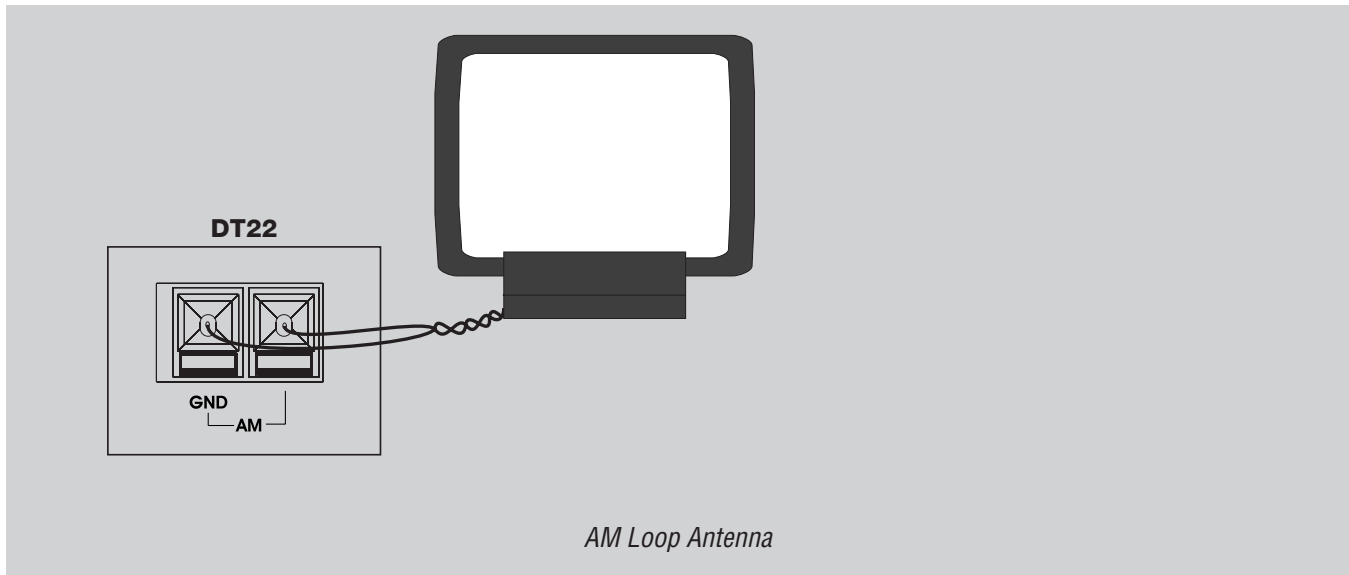

The AM antenna is connected to the terminals marked AM/GND. These connections are not polarity sensitive, so it does not matter which wire is connected to the GND or AM terminals.

To prevent unwanted noise, place the antenna as far away as possible from other electronics, speaker cords, power cords and amplifiers.

FM Antenna

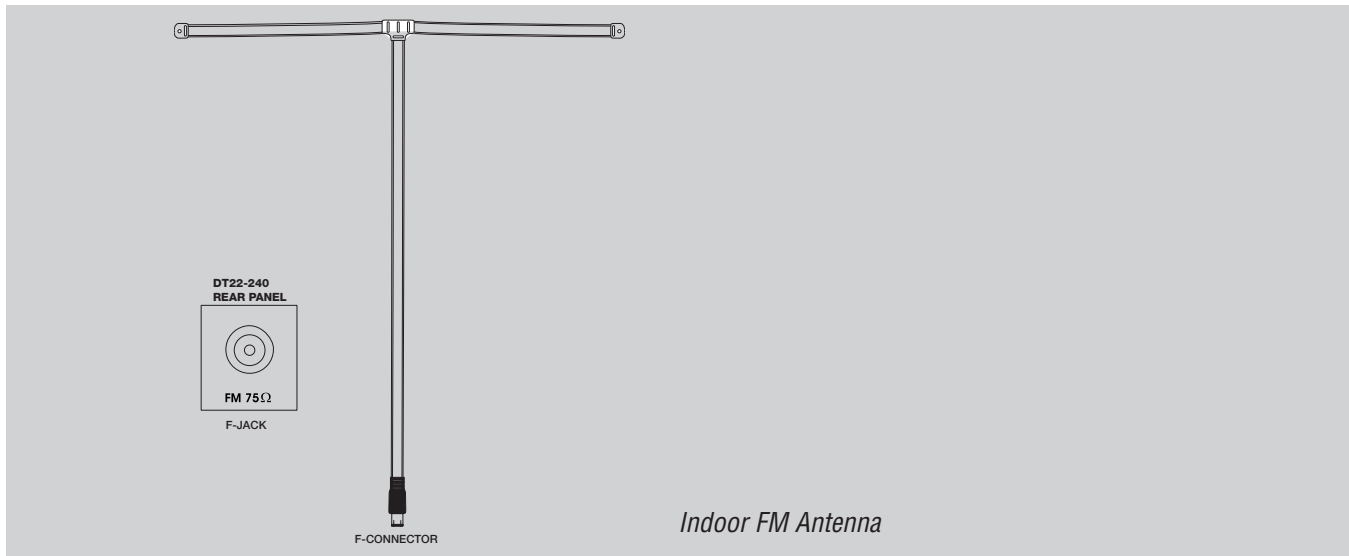

Connect the included FM antenna to the FM (coaxial) jack. Generally, a T-type twin lead antenna will be sufficient; if you live in an area where the FM signals are particularly weak, it may be necessary to install an outside or rooftop antenna.

If standard FM broadcast frequencies are available via your cable service, you may connect your 75 ohm FM antenna jack to your cable system. Please contact your cable service to discuss this option.

SIRIUS Tuner Module Connections

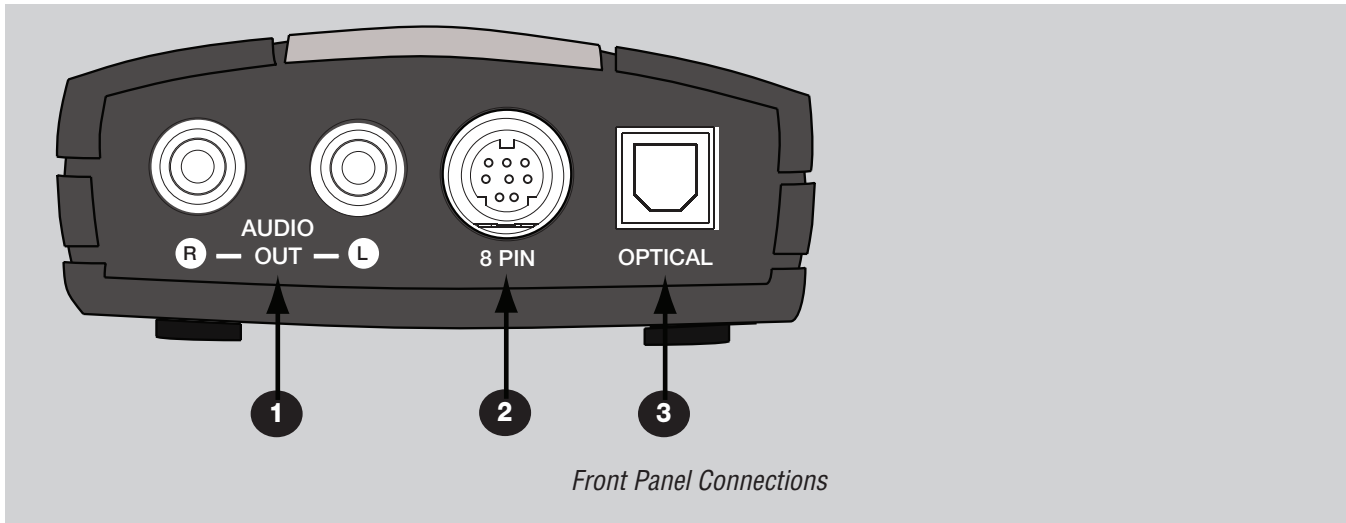

Item	Name
1	Analog Audio Out (not used)
2	8 Pin DIN -- Connects to DT22
3	Optical Connection

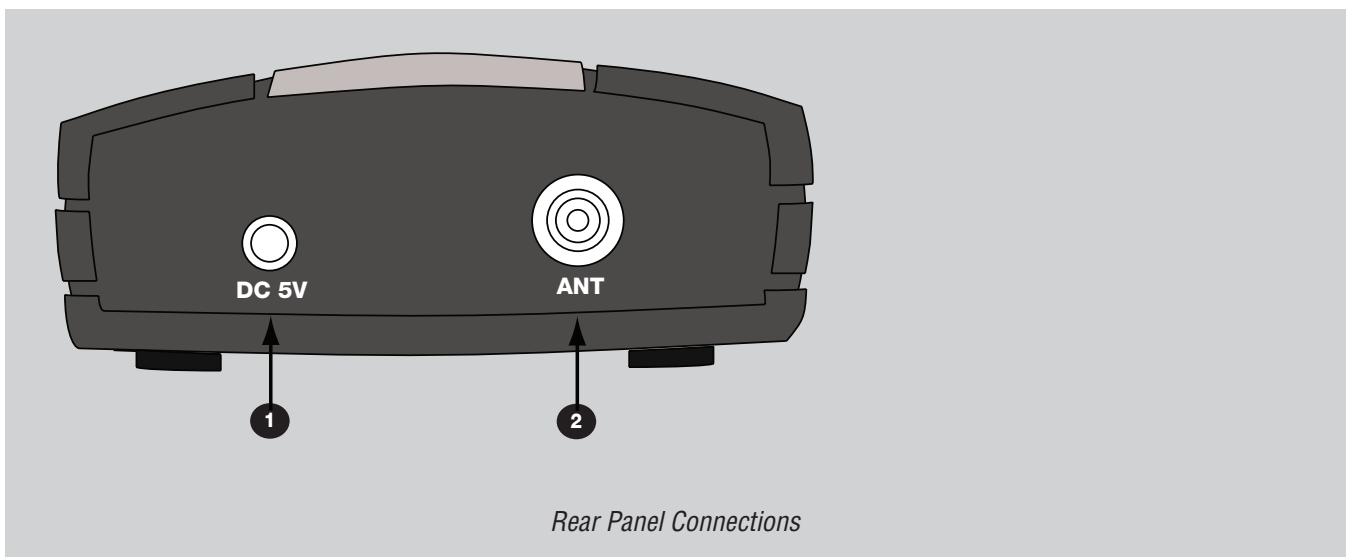

Item	Name
1	5 VDC power connection (not used)
2	Satellite Antenna Connection

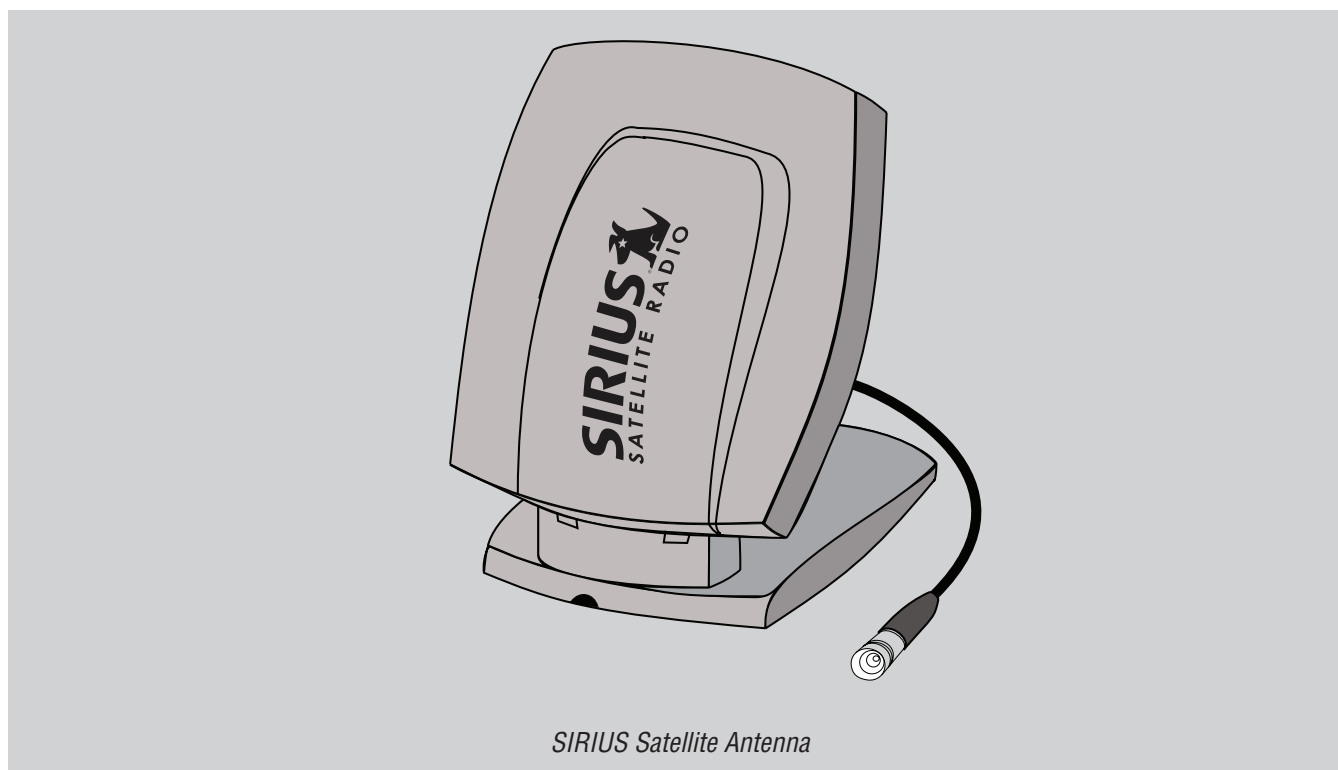

Positioning the Sirius Antenna

Prior to mounting the antenna or finding a permanent home for your DT22, you first want to validate the position of the antenna.

1. Power on DT22 to make sure the SIRIUS module has power.
You should see a startup screen with the ELAN logo, followed by the main display.
2. Power off DT22, and then connect the audio cables, IR, and RS232 control interfaces to the other components in your audio system.
3. Align the Antenna as follows:

For Indoor installation on a flat surface:

- a) Set antenna on its base on a flat horizontal surface.
- b) Turn the base of the antenna so that the SIRIUS logo is facing to the northwest if you are in the eastern half of the U.S. and to the north/northeast if you are in the western half.

Note: It will help to imagine that the SIRIUS satellites are in the sky above northern Minnesota. That's the optimal direction in which you need to aim the antenna.

- c) Use the "Signal Strength" screen, as described on page 74, to optimize antenna tilt angle and position.
- d) If necessary, experiment with different locations near a north-facing window or outside.

For outdoor installation or indoor wall mounting:

The antenna can also be attached vertically to an external or internal wall if that is more convenient than placing it on a horizontal surface.

- a) Holding your antenna up, find a wall location that ensures a strong signal.
 - b) Attach antenna to the wall using four screws.
 - c) Tilt the antenna fully back on the base, place the antenna base on the four screw heads with the antenna pivot at the top, and pull down approximately 1/4 inch until the base is firmly secured. Note that the SIRIUS logo will be upside down when the antenna is properly installed.
 - d) Tilt the antenna away from the wall/base until the signal strength is optimized.
4. Power on your sound system and turn the amplifier to a low volume.
 5. Power on DT22 and tune to channel 184, a free preview channel.

If the system is working, you will hear SIRIUS programming on this channel and can proceed to Step 6. If there is a problem with the antenna connection, the DT22's front panel display will read "Antenna Error". If the antenna does not have a clear path to the satellites, the front panel display will read "Acquiring Signal". Reposition the antenna until you hear music playing.

6. Finish installing DT22.
 - a) House DT22 in its permanent location. Follow the instructions in the section, "Appendix B: Rack Mounting".
 - b) Activate the unit following the "Activating SIRIUS radio" instructions.

Rear Panel Power Switch

The DT22 master power switch is located on the rear panel. The switch must be in the ON position to allow the tuner to operate. To reduce power consumption when away for extended periods of time, set the master switch to the OFF position. To return tuner to normal operation, set the switch to the ON position.

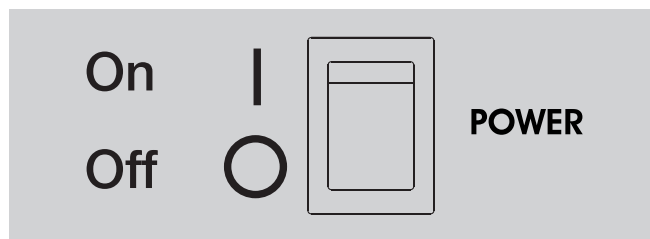

Rear Panel Power Switch

Operation

The DT22 provides intuitive control of its various functions via its front panel buttons (as shown on the next page), from ELAN Touch Panels and Olé Touchpads, the remote control, and its hard wired IR input. The DT22 is essentially two completely independent AM-FM radio tuners (add another DT22 for a total of four)—each of which can be tuned independently so that different audio channels play in different rooms.

From the interface within each zone you can:

- Change channels (either by preset or direct tuning)
- View RDS information (on supported panels)

Default Display

The default display, as shown below, provides information about the channel each tuner is currently tuned to, including category name, channel number, channel name, artist name, and song title.

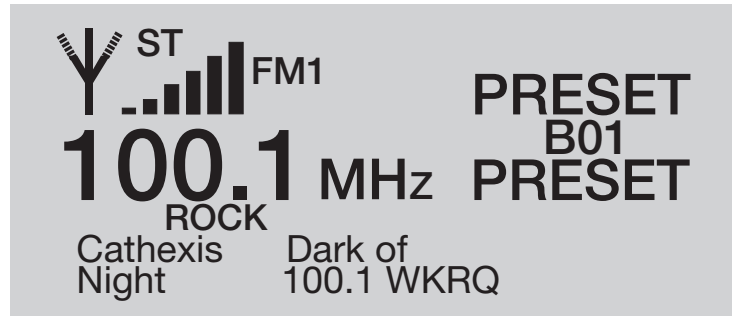

LCD Display

Front Panel

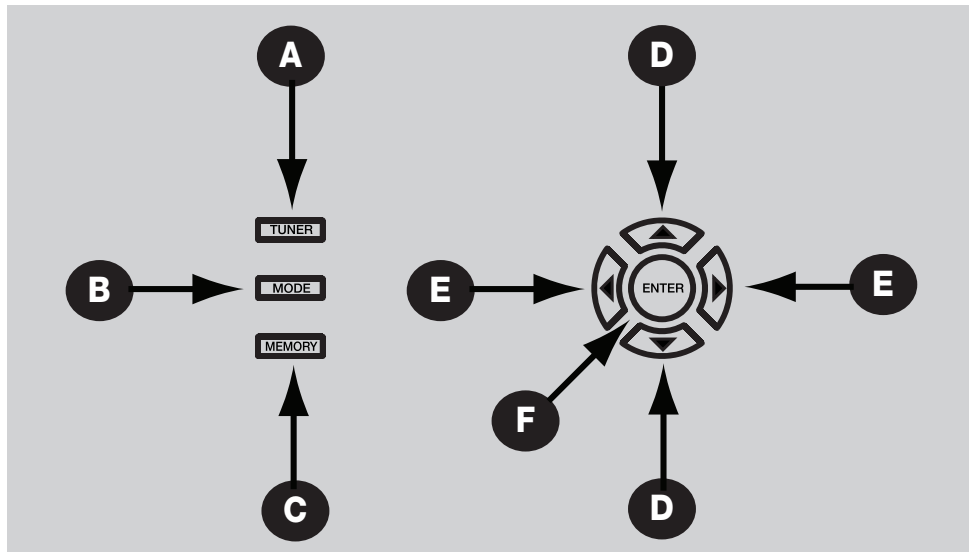

Front Panel Controls

A. TUNER

- Switches between Tuner 1, Tuner 2, SIRIUS 1 and SIRIUS 2.
- Press and Hold to turn the DT22 On or Off.

B. MODE

- Displays the Mode Menu on the LCD that allows settings - AM/FM, Preset/Direct/Stereo/Mono - to be changed using Arrow Up/Down buttons without the use of a remote.

C. MEMORY

- Displays the Memory Menu on the LCD that allows Presets to be either saved or deleted using Arrow Up/Down buttons without the use of a remote; each Group (A,B,C,D) has 99 presets.

D. ARROW Up/Down

- Use these buttons to Seek after the Tuner button is pressed, navigate the Mode On-Screen-Display after the Mode button is pressed or navigate the Memory On-Screen-Display after the Memory button is pressed.

E. ARROW Left/Right Buttons

- Use these buttons to Increment/Decrement or Step the frequency after the Tuner button is pressed, do nothing after the Mode button is pressed.

F. F ENTER Button

- Use this button to verify or confirm an intended operation or function.
- In AM/FM, the button is used to bring up overrides, details, exit, in SIRIUS it cycles through data

Mode Menu

Mode Menu submenus:

- AM/FM
- Preset/Direct
- Stereo/Mono

AM/FM

- 1) Toggle the **Band** from **AM** to **FM** or from **FM** to **AM**.
- 2) Press the **MODE** button.
- 3) Highlight **AM/FM** using the **UP** arrow or **DOWN** arrow buttons.
- 4) Press the **ENTER** button.

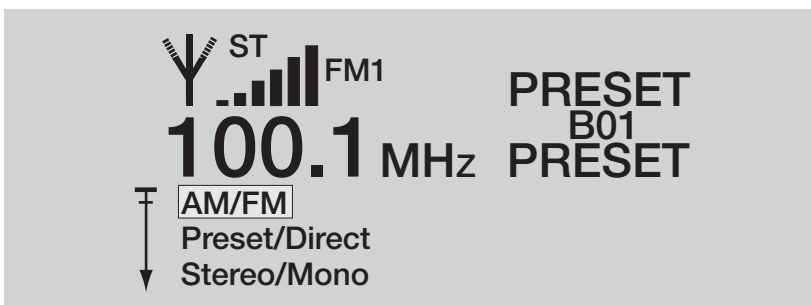

Preset/Direct

Places the Tuner in **Preset** or **Direct** mode.

Direct places the tuner in **Direct** mode.

Preset places the tuner in **Preset** with the current selected **Group** selected.

Preset Group A places the Tuner in Preset mode and changes the Tuner to **Group A**.

Preset Group B places the Tuner in Preset mode and changes the Tuner to **Group B**.

Preset Group C places the Tuner in Preset mode and changes the Tuner to **Group C**.

Preset Group D places the Tuner in Preset mode and changes the Tuner to **Group D**.

No preset exists for the tuned frequency if "--" is displayed after the group, like it is in the following image "B--".

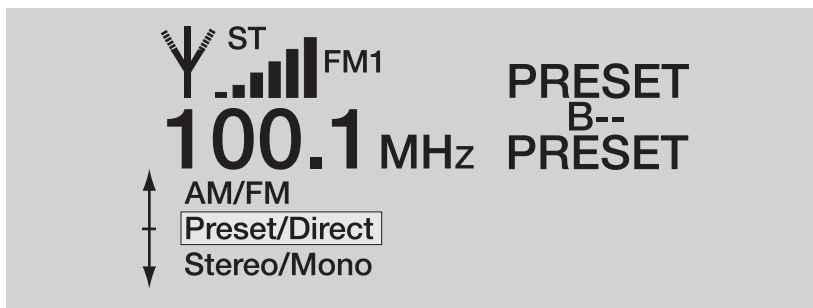

- 1) Press the **MODE** button.
- 2) Highlight **Preset/Direct** using the **UP** arrow or **DOWN** arrow buttons.
- 3) Press the **ENTER** button.

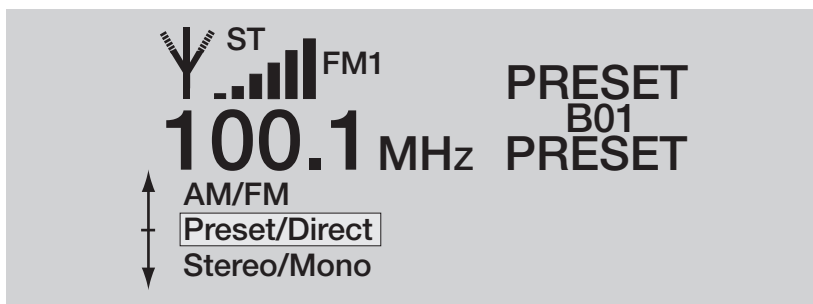

- 1) Highlight **Direct**, **Preset**, **Preset Group A**, **Preset Group B**, **Preset Group C**, or **Preset Group D** using the **UP** arrow or **DOWN** arrow buttons.
- 2) Press the **ENTER** button when done.

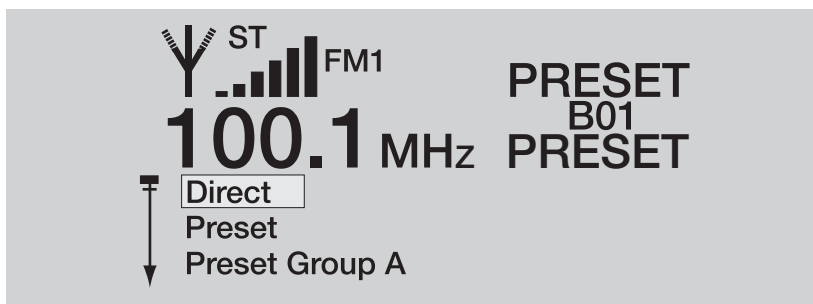

Stereo/Mono

This menu selection switches the FM signal between stereo and mono. Switching to mono mode can make weak FM signals sound clearer.

The **Stereo** icon will be displayed when in **Stereo** mode and absent when in **Mono** mode.

- 1) Press the **MODE** button.
- 2) Highlight **Stereo/Mono** using the **UP** arrow or **DOWN** arrow buttons.
- 3) Press the **ENTER** button.

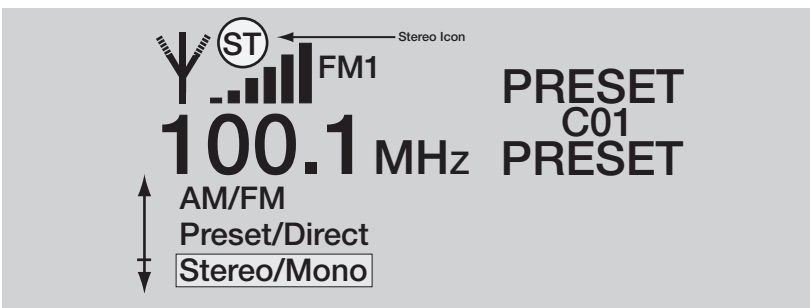

Saving Presets

Select one of the four **Preset Groups A-D**.

- 1) Tune to a station that is going to be saved.
- 2) Press the **MEMORY** button.
- 3) Highlight **Save Preset** using the **UP** arrow or **DOWN** arrow buttons.
- 4) Press the **ENTER** button.

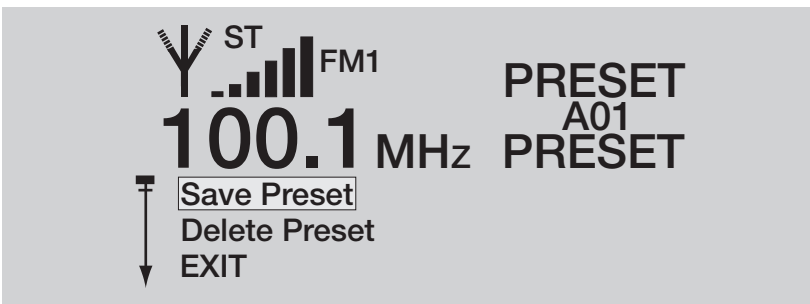

- 1) Press the **UP/DOWN** arrows to change the first **Preset** digit.
- 2) Press the **LEFT/RIGHT** arrows select the second **Preset** digit.
- 3) Press the **UP/DOWN** arrows to change the second **Preset** digit.
- 4) Press the **Enter** button when done.

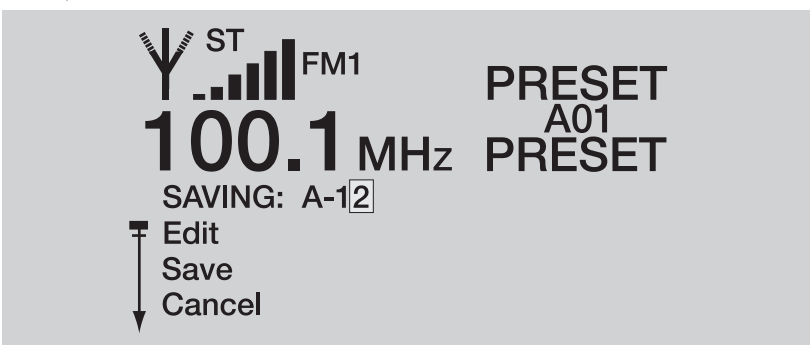

- 1) Highlight **Save** using the **UP** arrow or **DOWN** arrow buttons to save the change.
- 2) Highlight **Cancel** using the **UP** arrow or **DOWN** arrow buttons to revert to the previous setting.
- 3) Highlight **Edit** using the **UP** arrow or **DOWN** arrow buttons to change the preset digits.
- 4) Press the **ENTER** button to commit the selection **Edit**, **Save** or **Cancel**.

Deleting Presets

- 1) Select a preset that will be deleted.

- 2) Press the **MEMORY** button.
- 3) Highlight **Delete Preset** using the **UP** arrow or **DOWN** arrow buttons.
- 4) Press the **ENTER** button.

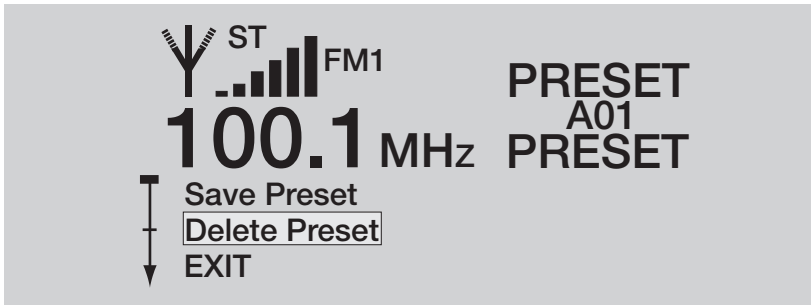

- 1) Highlight **Delete** using the **UP** arrow or **DOWN** arrow buttons to delete the preset.
- 2) Highlight **Cancel** using the **UP** arrow or **DOWN** arrow buttons to abort the delete.
- 3) Press the **ENTER** button to commit either **Delete** or **Cancel**.

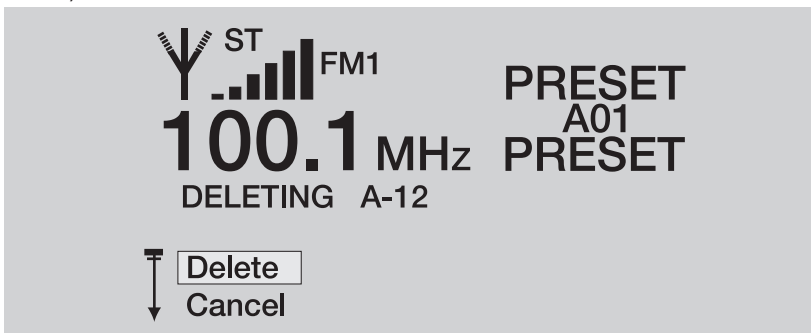

Override

Change Custom Text

The DT22 provides the ability to override a station's **Custom Text**.

- 1) Ensure the **Tuner** is **On**.
- 2) Select a station whose **Call Sign** you want to change.
- 3) Press the **ENTER** button.
- 4) Highlight **Override** using the **UP** arrow or **DOWN** arrow buttons.
- 5) Press the **ENTER** button.

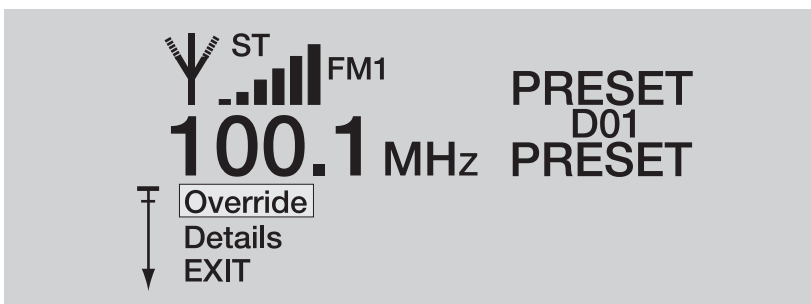

- 1) Highlight **Call Sign** using the **UP** arrow or **DOWN** arrow buttons.
- 2) Press the **ENTER** button.

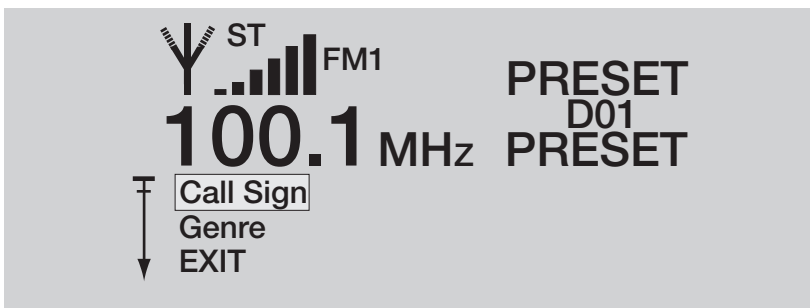

- 1) Highlight **Edit** using the **UP** arrow or **DOWN** arrow buttons.
- 2) Press the **Enter** button.

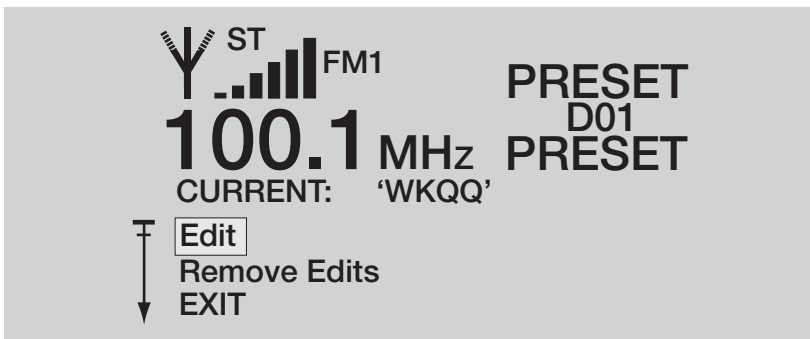

- 1) Press the **UP/DOWN** arrows to change the characters.
- 2) Press the **LEFT/RIGHT** arrows select the next character.
- 3) Press the **Enter** button when done.

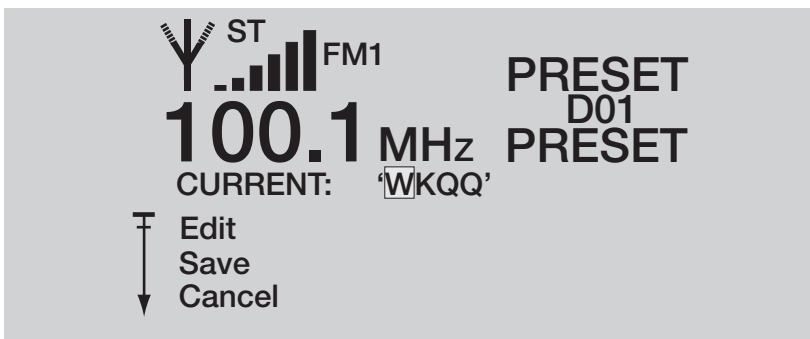

- 1) Highlight **Save** using the **UP** arrow or **DOWN** arrow buttons to save the change.
- 2) Highlight **Cancel** using the **UP** arrow or **DOWN** arrow buttons to revert the previous setting.
- 3) Highlight **Edit** using the **UP** arrow or **DOWN** arrow buttons to change the **Call Sign** characters.
- 4) Press the **ENTER** button to commit either **Edit**, **Save** or **Cancel**.

See next page for example

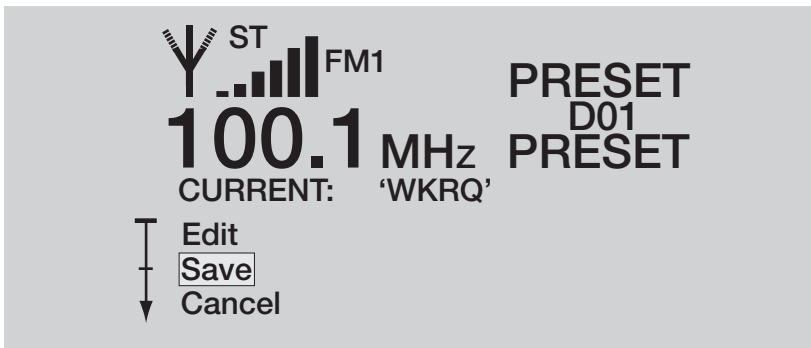

Remove Custom Text

- 1) Ensure the **Tuner** is **On**.
- 2) Select a station whose **Custom Text** you want to remove.
- 3) Press the **ENTER** button.
- 4) Highlight **Override** using the **UP** arrow or **DOWN** arrow buttons.
- 5) Press the **ENTER** button.

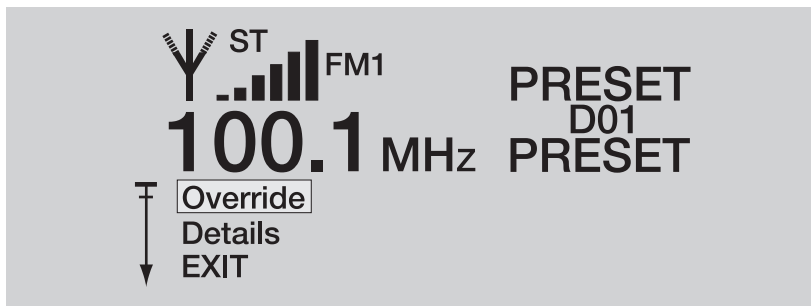

- 1) Highlight **Call Sign** using the **UP** arrow or **DOWN** arrow buttons.
- 2) Press the **ENTER** button.

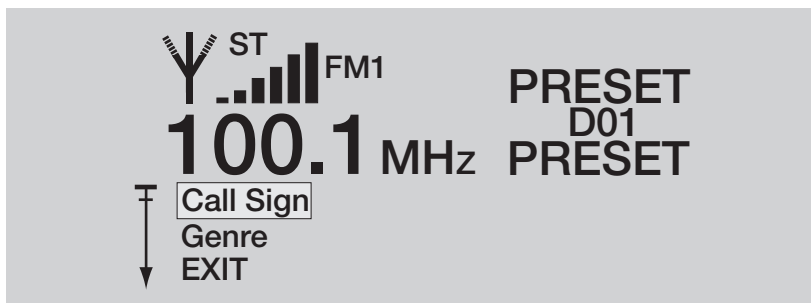

- 1) Highlight **Remove Edits** using the **UP** arrow or **DOWN** arrow buttons.
- 2) Press the **ENTER** button.

See next page for example

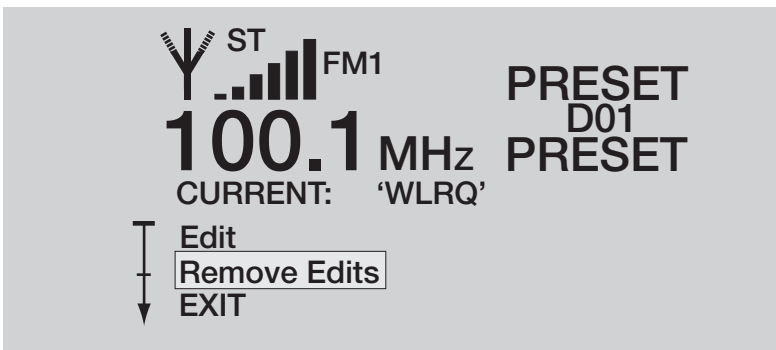

Changing Genre

The DT22 provides the ability to change a station's **Genre**.

- 1) Ensure the **Tuner** is **On**.
- 2) Select a station whose **Genre** you want to change.
- 3) Press the **ENTER** button.
- 4) Highlight **Override** using the **UP** arrow or **DOWN** arrow buttons.
- 5) Press the **ENTER** button.

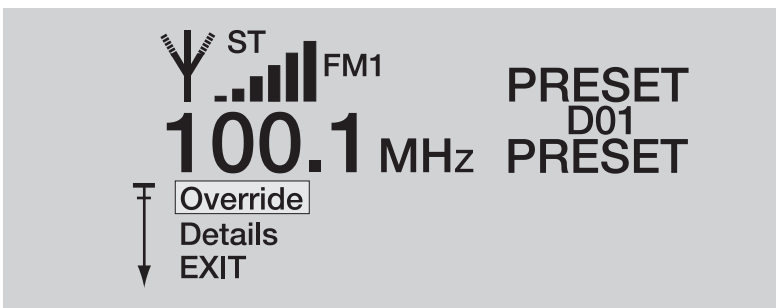

- 1) Highlight **Genre** using the **UP** arrow or **DOWN** arrow buttons.
- 2) Press the **ENTER** button.

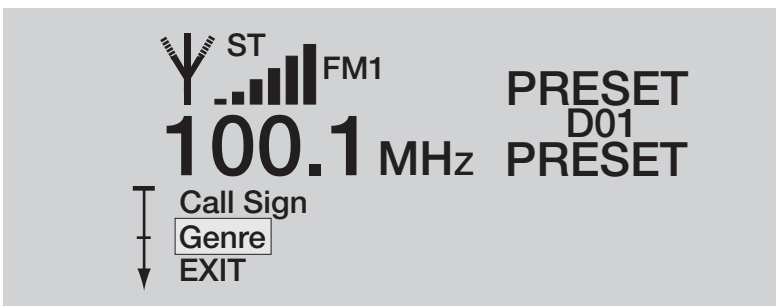

- 1) Highlight **Edit** using the **UP** arrow or **DOWN** arrow buttons.
- 2) Press the **ENTER** button.

See next page for example

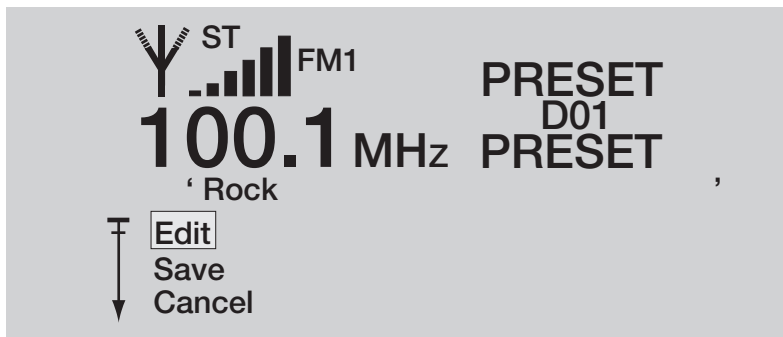

Press the **UP/DOWN** arrows to change the **Genre**.
Press the **ENTER** button when done.

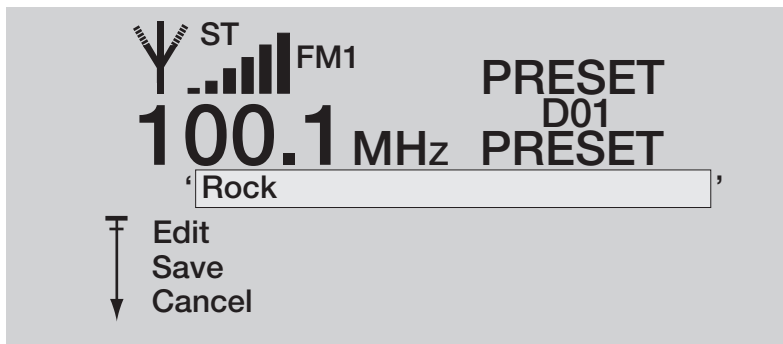

- 1) Highlight **Edit** using the **UP** arrow or **DOWN** arrow buttons to change the **Genre**.
- 2) Highlight **Save** using the **UP** arrow or **DOWN** arrow buttons to save the change.
- 3) Highlight **Cancel** using the **UP** arrow or **DOWN** arrow buttons to revert the previous setting.
- 4) Press the **ENTER** button to commit either **Edit**, **Save** or **Cancel**.

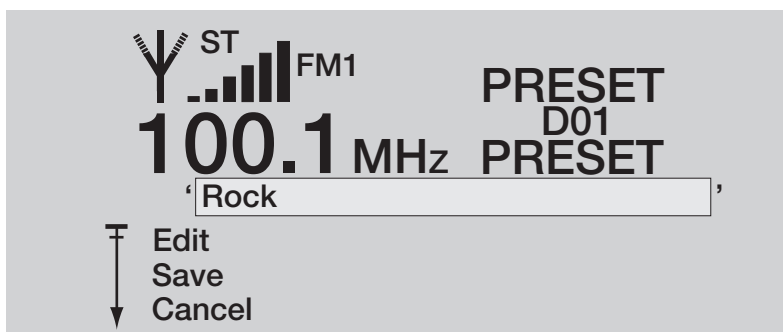

Removing Genre Override

The DT22 provides the ability to remove a station's **Genre Override**.

- 1) Ensure the **Tuner is On**.
- 2) Select a station whose **Genre Override** you want to remove.
- 3) Press the **ENTER** button.
- 4) Highlight **Override** using the **UP** arrow or **DOWN** arrow buttons.
- 5) Press the **ENTER** button.

See next page for example

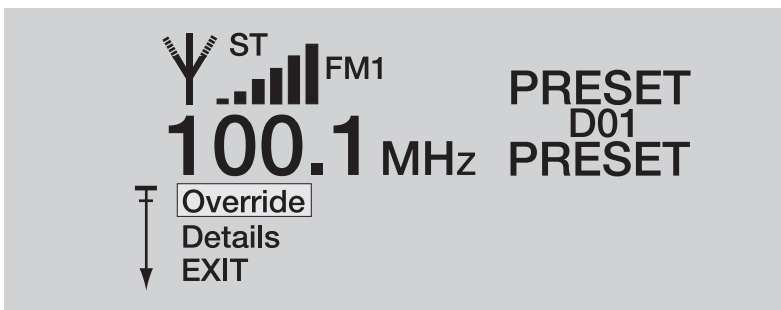

- 1) Highlight **Genre** using the **UP** arrow or **DOWN** arrow buttons.
- 2) Press the **ENTER** button.

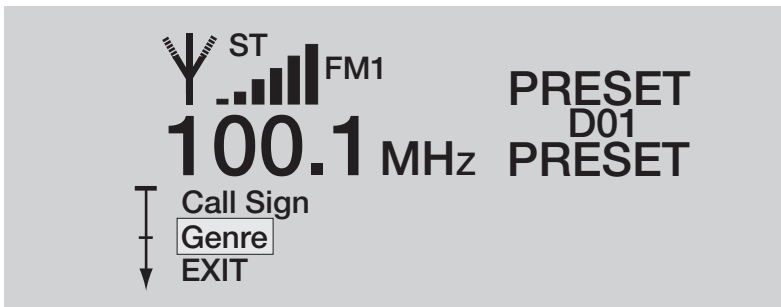

- 1) Highlight **Remove Edits** using the **UP** arrow or **DOWN** arrow buttons.
- 2) Press the **ENTER** button.

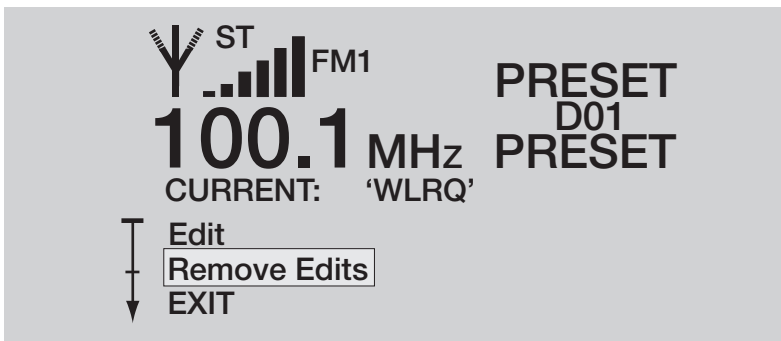

Once the **Enter** button is pressed, the associated **Genre Override** is removed.

Details

If it is suspected that the DT22 has tuner performance issues, a diagnostic tool is provided to give feedback to the installer in conjunction with a troubleshoot call with ELAN Technical Support.

- 1) Ensure the **Tuner is On**.
- 2) Select a station whose **Details** you want to see.
- 3) Press the **ENTER** button.
- 4) Highlight **Details** using the **UP** arrow or **DOWN** arrow buttons.
- 5) Press the **ENTER** button.

See next page for example

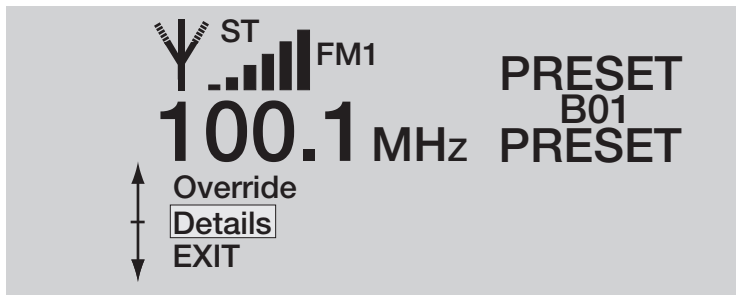

Details are listed for the selected station.

FM1	100.1	
Valid	:	TRUE
Soft Mute	:	off
Pilot	:	PRESENT
Blend	:	5%
RSSI	:	32 dBuV
SNR	:	19 dB
F Offset	:	-16 kHz

6) To **Exit** press any button.

System Configuration

If the **Unit** is **On**, turn it **Off**:

- 1) **Press** and **Hold** the **TUNER** button on the **Front Panel** to turn the unit **Off**.
or **Press** the **Off** button on the **Remote**.
- 2) Simultaneously **Press** and **Hold** both the **LEFT** and **RIGHT** front panel buttons.

Unit ID

The **DT22** can provide **Two-Way** feedback status over **VIA!NET** to **Elan Control Panels** without the use of a **SC1**, **SS1** or **SC4**. The DT22 must be assigned an **Unit ID** when connected to the VIA!NET so it can be identified. There can only be two DT22s connected to the VIA!NET.

By default the DT22 is shipped configured to Unit ID 1. For installations with only one DT22, this setting should not be changed. However, when adding a second DT22 this setting must be changed to 2 on the second unit

NOTE: The **VIA!NET** jack on the back of the **DT22** must be used.

- 1) Highlight **Unit ID** using the **UP** arrow or **DOWN** arrow buttons.
- 2) Press the **ENTER** button.

See next page for example

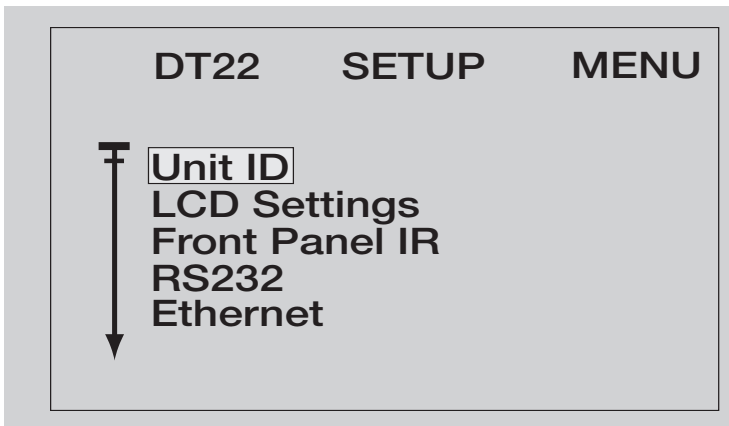

- 1) Highlight **Edit** using the **UP** arrow or **DOWN** arrow buttons.
- 2) Press the **ENTER** button.

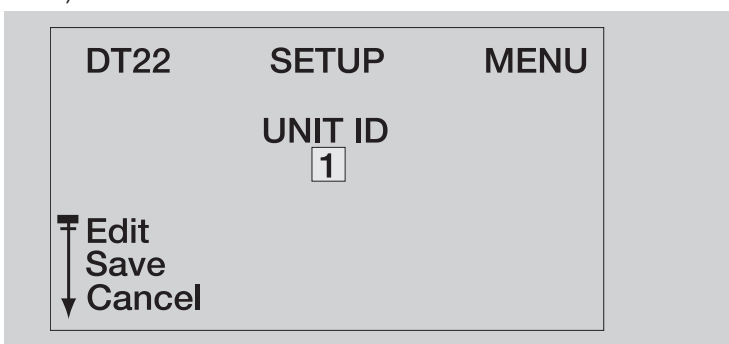

- 1) Press the **UP/DOWN** arrows to change the **Unit ID**.
- 2) Press the **Enter** button when done.
- 3) Highlight **Edit** using the **UP** arrow or **DOWN** arrow buttons to change the **Unit ID**.
- 4) Highlight **Save** using the **UP** arrow or **DOWN** arrow buttons to save the change.
- 5) Highlight **Cancel** using the **UP** arrow or **DOWN** arrow buttons to revert the previous setting.
- 6) Press the **ENTER** button to commit either **Edit**, **Save** or **Cancel**.

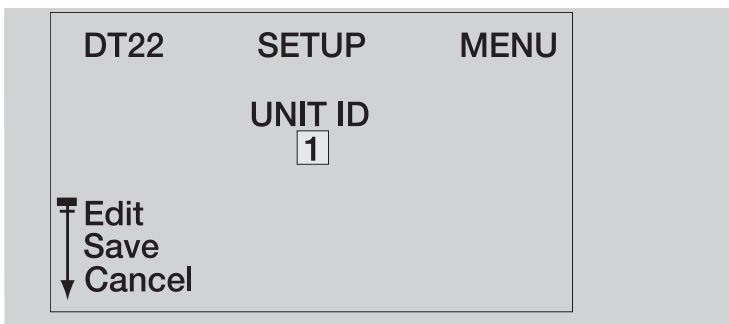

LCD Settings

LCD settings can be changed to provide optimum readability in various lighting conditions.

LCD Settings submenus:

- LCD Timeout
- LCD Contrast

- LCD Brightness

- 1) Highlight **LCD Settings** using the **UP** arrow or **DOWN** arrow buttons.
- 2) Press the **ENTER** button.

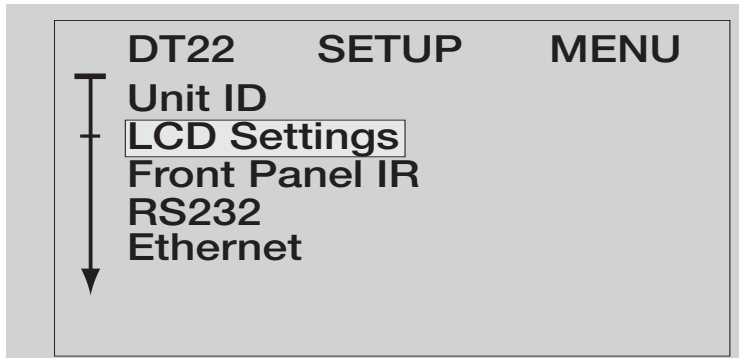

LCD Timeout

This is the amount of time that the front panel's LCD backlight is active after a Front Panel button press.

NOTE: It is possible to set the **LCD Timeout** value to '**DISABLED**'. This will prevent the LCD backlight from ever turning off. It is recommended to greatly decrease the LCD Brightness if this value is used. Otherwise the lifetime of the LCD backlight will be reduced.

- 1) Highlight **LCD Timeout** using the **UP** arrow or **DOWN** arrow buttons.
- 2) Press the **ENTER** button.

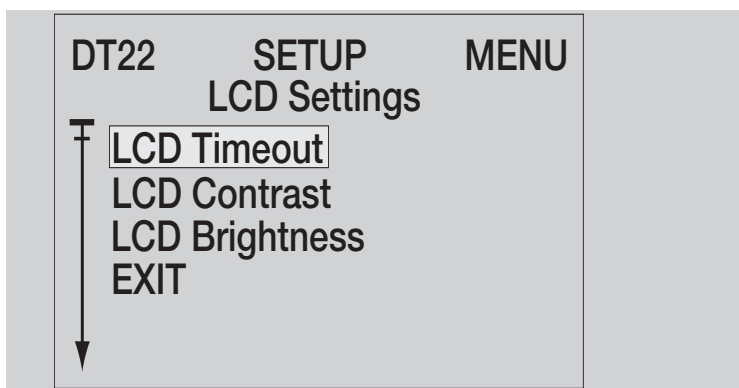

- 1) Highlight **Edit** using the **UP** arrow or **DOWN** arrow buttons.
- 2) Press the **ENTER** button.

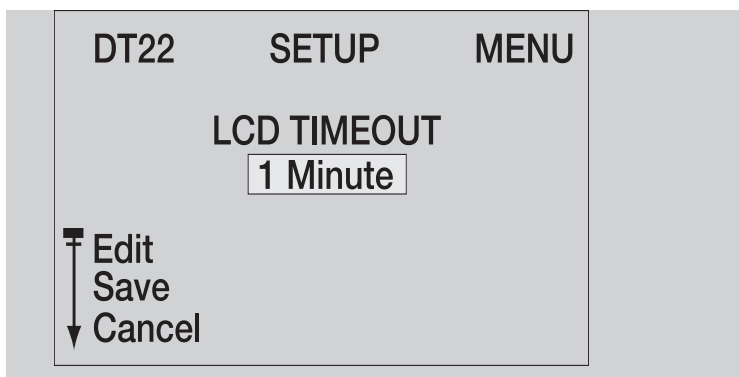

- 1) Press the **UP/DOWN** arrows to change the **LCD Timeout** time.
- 2) Press the **ENTER** button when done.

See next page for example

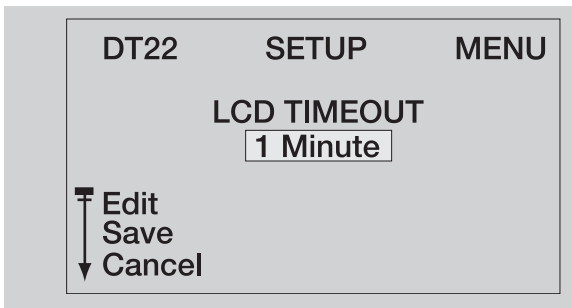

- 1) Highlight **Edit** using the **UP** arrow or **DOWN** arrow buttons to change the **LCD Timeout**.
- 2) Highlight **Save** using the **UP** arrow or **DOWN** arrow buttons to save the change.
- 3) Highlight **Cancel** using the **UP** arrow or **DOWN** arrow buttons to revert the previous setting.
- 4) Press the **ENTER** button to commit either **Edit**, **Save** or **Cancel**.

LCD Contrast

- 1) Highlight **LCD Contrast** using the **UP** arrow or **DOWN** arrow buttons.
- 2) Press the **ENTER** button.

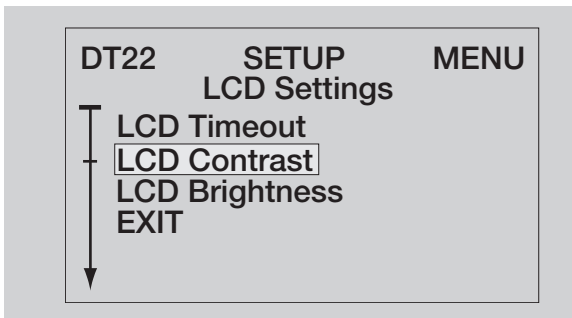

- 1) Highlight **Edit** using the **UP** arrow or **DOWN** arrow buttons.
- 2) Press the **ENTER** button.

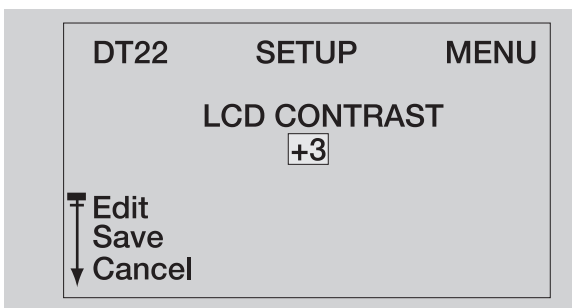

- 1) Press the **UP/DOWN** arrows to change the **LCD Contrast**.
- 2) Press the **ENTER** button when done.

See next page for example

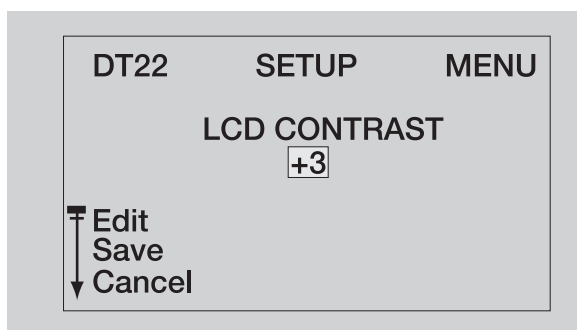

- 1) Highlight **Edit** using the **UP** arrow or **DOWN** arrow buttons to change the **LCD Contrast**.
- 2) Highlight **Save** using the **UP** arrow or **DOWN** arrow buttons to save the change.
- 3) Highlight **Cancel** using the **UP** arrow or **DOWN** arrow buttons to revert the previous setting.
- 4) Press the **ENTER** button to commit either **Edit**, **Save** or **Cancel**.

LCD Brightness

- 1) Highlight **LCD Brightness** using the **UP** arrow or **DOWN** arrow buttons.
- 2) Press the **ENTER** button.

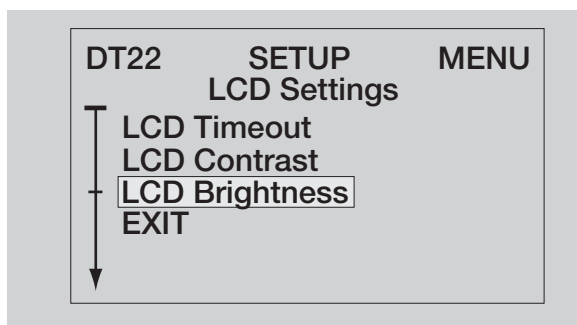

- 1) Highlight **Edit** using the **UP** arrow or **DOWN** arrow buttons.
- 2) Press the **ENTER** button.

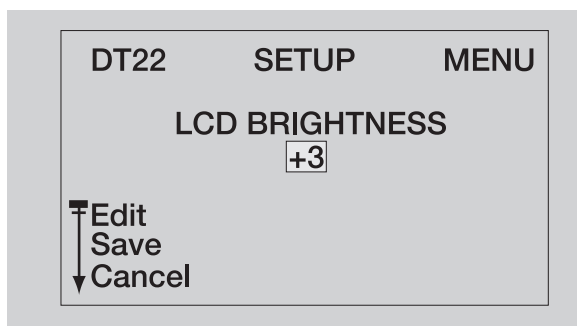

- 1) Press the **UP/DOWN** arrows to change the **LCD Brightness**.
- 2) Press the **ENTER** button when done.

See next page for example

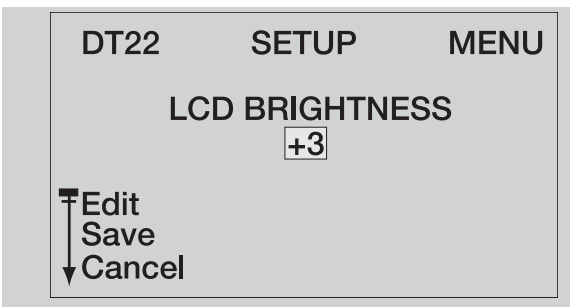

- 1) Highlight **Edit** using the **UP** arrow or **DOWN** arrow buttons to change the **LCD Brightness**.
- 2) Highlight **Save** using the **UP** arrow or **DOWN** arrow buttons to save the change.
- 3) Highlight **Cancel** using the **UP** arrow or **DOWN** arrow buttons to revert the previous setting.
- 4) Press the **ENTER** button to commit either **Edit**, **Save** or **Cancel**.

Front Panel IR

Enables or disables the IR receiver located on the front panel.
You may want to disable if you experience IR flooding of the front sensor.

- 1) Highlight **Front Panel IR** using the **UP** arrow or **DOWN** arrow buttons.
- 2) Press the **ENTER** button.

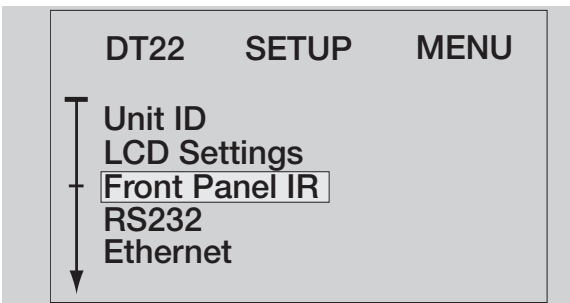

- 1) Highlight **Edit** using the **UP** arrow or **DOWN** arrow buttons.
- 2) Press the **ENTER** button.

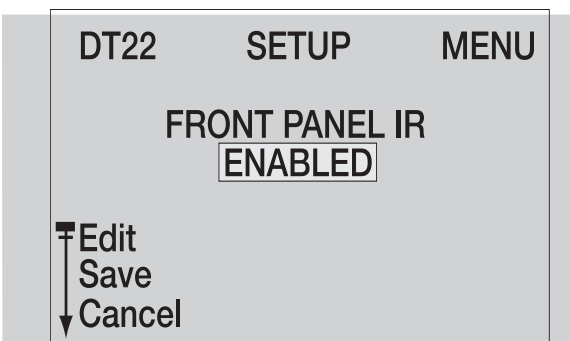

- 1) Press the **UP/DOWN** arrows to **Enable** or **Disable Front Panel IR**.
- 2) Press the **ENTER** button when done.

See next page for example

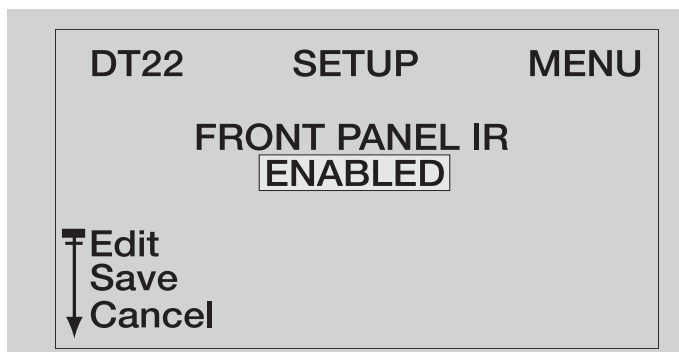

- 1) Highlight **Edit** using the **UP** arrow or **DOWN** arrow buttons to **ENABLE** or **DISABLE Front Panel IR**.
- 2) Highlight **Save** using the **UP** arrow or **DOWN** arrow buttons to save the change.
- 3) Highlight **Cancel** using the **UP** arrow or **DOWN** arrow buttons to revert the previous setting.
- 4) Press the **ENTER** button to commit either **Edit**, **Save** or **Cancel**.

RS232

RS232 Menu submenus:

- Baud Rate
- Unsolicited Feedback

- 1) Highlight **RS232** using the **UP** arrow or **DOWN** arrow buttons.
- 2) Press the **ENTER** button.

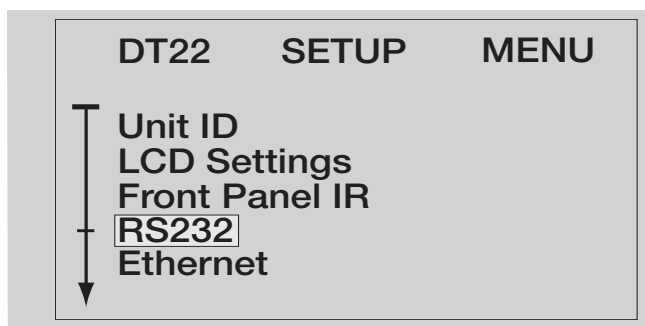

Baud Rate

- 1) Highlight **Baud Rate** using the **UP** arrow or **DOWN** arrow buttons.
- 2) Press the **ENTER** button.

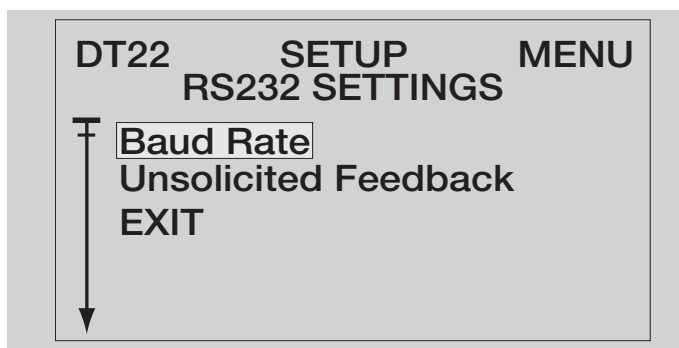

- 1) Highlight **Edit** using the **UP** arrow or **DOWN** arrow buttons.
- 2) Press the **ENTER** button.

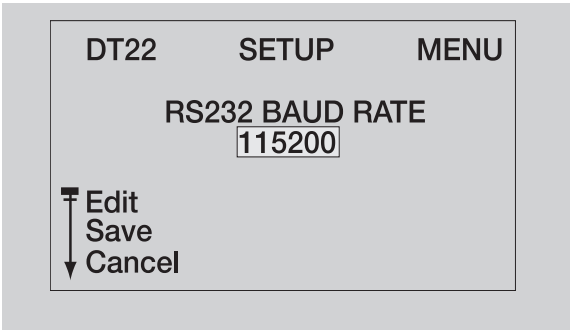

- 1) Press the **UP/DOWN** arrows to change the **Baud Rate**.
- 2) Press the **ENTER** button when done.

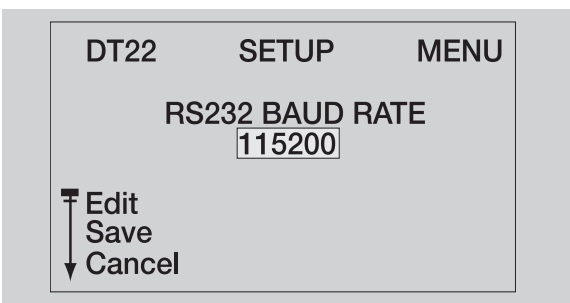

- 1) Highlight **Edit** using the **UP** arrow or **DOWN** arrow buttons to change the **Baud Rate**.
- 2) Highlight **Save** using the **UP** arrow or **DOWN** arrow buttons to save the change.
- 3) Highlight **Cancel** using the **UP** arrow or **DOWN** arrow buttons to revert the previous setting.
- 4) Press the **ENTER** button to commit either **Edit**, **Save** or **Cancel**.

Unsolicited Feedback

The DT22 can automatically send its status whenever its state changes. This is enabled by default.

- 1) Highlight **Unsolicited Feedback** using the **UP** arrow or **DOWN** arrow buttons.
- 2) Press the **ENTER** button.

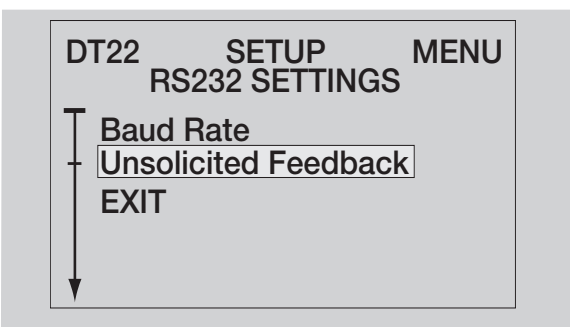

- 1) Highlight **Edit** using the **UP** arrow or **DOWN** arrow buttons.
- 2) Press the **ENTER** button.

See next page for example

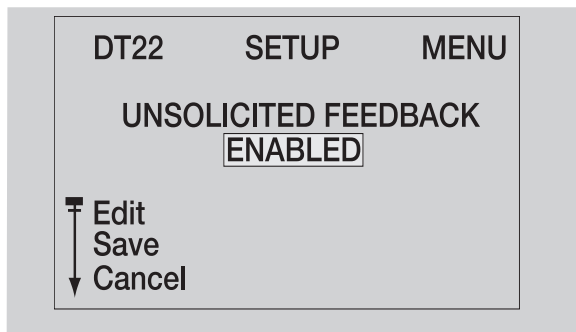

- 1) Press the **UP/DOWN** arrows to **Enable** or **Disable Unsolicited Feedback**.
- 2) Press the **ENTER** button when done.

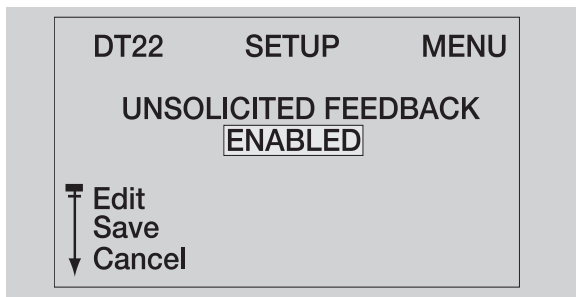

- 1) Highlight **Edit** using the **UP** arrow or **DOWN** arrow buttons to **ENABLE** or **DISABLE Unsolicited Feedback**.
- 2) Highlight **Save** using the **UP** arrow or **DOWN** arrow buttons to save the change.
- 3) Highlight **Cancel** using the **UP** arrow or **DOWN** arrow buttons to revert the previous setting.
- 4) Press the **ENTER** button to commit either **Edit**, **Save** or **Cancel**.

Ethernet

Ethernet Menu submenus:

- Configuration Type
- Show Current

To enter the **Ethernet** settings menu use the **DOWN** arrow to highlight **Ethernet** and press the **ENTER** button.

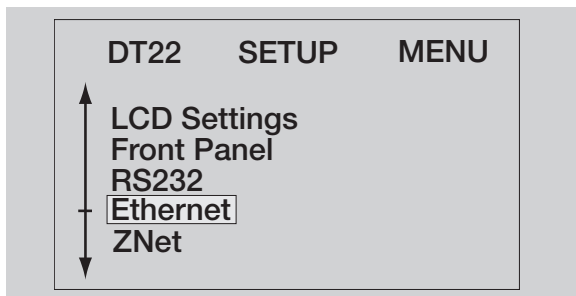

Configuration Type

The **Configuration Type** settings menu allows the DT22 to be set to **DHCP** or **Static** IP Address.

- 1) Highlight **Configuration Type** using the **UP** arrow or **DOWN** arrow buttons.
- 2) Press the **ENTER** button.

See next page for example

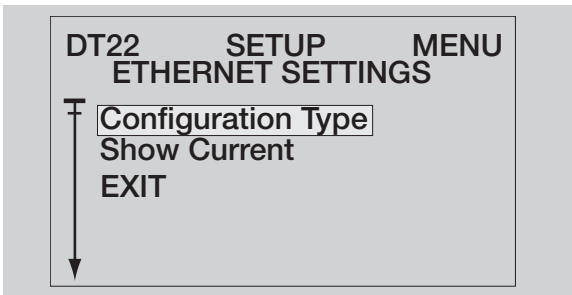

- 1) Highlight **Edit** using the **UP** arrow or **DOWN** arrow buttons.
- 2) Press the **ENTER** button.

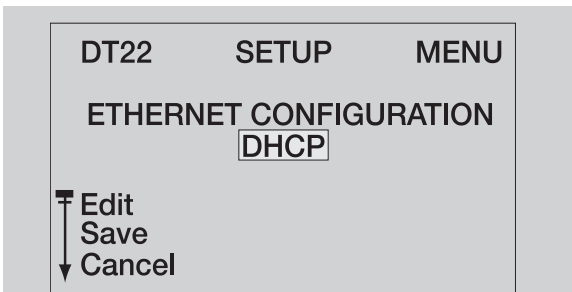

- 1) Press the **UP/DOWN** arrows to select **DHCP** or **Static**.
- 2) Press the **ENTER** button when done.

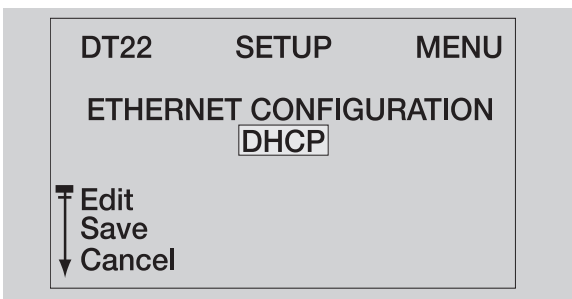

- 1) Highlight **Edit** using the **UP** arrow or **DOWN** arrow buttons to change **Configuration Type**.
- 2) Highlight **Save** using the **UP** arrow or **DOWN** arrow buttons to save the change.
- 3) Highlight **Cancel** using the **UP** arrow or **DOWN** arrow buttons to revert the previous setting.
- 4) Press the **ENTER** button to commit either **Edit**, **Save** or **Cancel**.

Static Parameters

Static Parameters Menu submenus:

- IP Address
- Netmask
- Gateway

When **STATIC** is selected as a configuration type a hidden menu selection called **Static Parameters** appears.

- 1) Highlight **Static Parameters** using the **UP** arrow or **DOWN** arrow buttons.
- 2) Press the **ENTER** button.

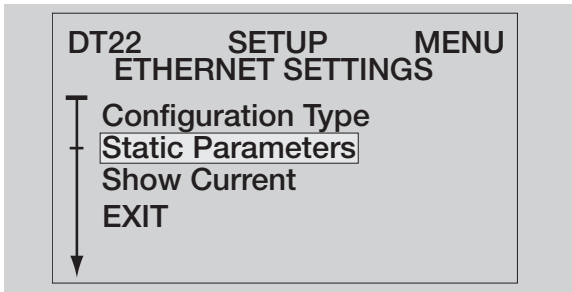

STATIC IP ADDRESS

- 1) Highlight **IP Address** using the **UP** arrow or **DOWN** arrow buttons.
- 2) Press the **ENTER** button.

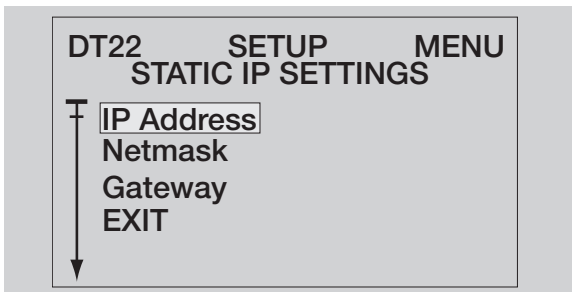

- 1) Highlight **Edit** using the **UP** arrow or **DOWN** arrow buttons.
- 2) Press the **ENTER** button.

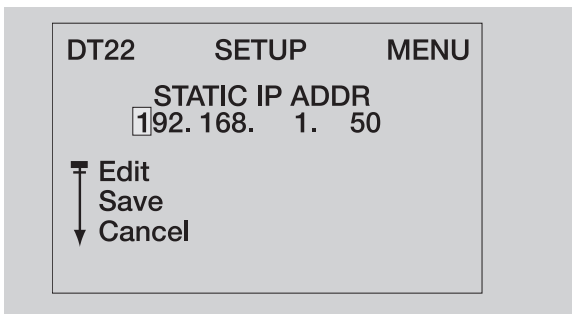

- 1) Press the **UP/DOWN** arrows to change the **IP Address** digit.
- 2) Press the **LEFT/RIGHT** arrows select the next **IP Address** digit.
- 3) Press the **ENTER** button when done.

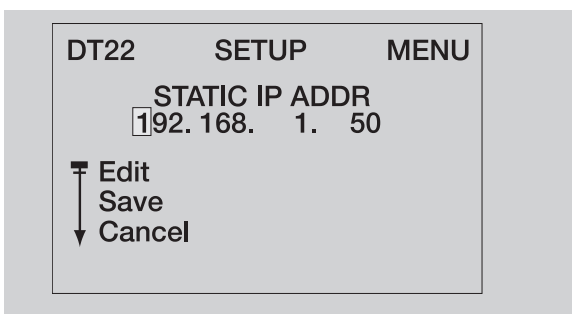

- 1) Highlight **Edit** using the **UP** arrow or **DOWN** arrow buttons to change **IP Address**.
- 2) Highlight **Save** using the **UP** arrow or **DOWN** arrow buttons to save the change.
- 3) Highlight **Cancel** using the **UP** arrow or **DOWN** arrow buttons to revert the previous setting.
- 4) Press the **ENTER** button to commit either **Edit**, **Save** or **Cancel**.

Static Netmask

- 1) Highlight **Netmask** using the **UP** arrow or **DOWN** arrow buttons.
- 2) Press the **ENTER** button.

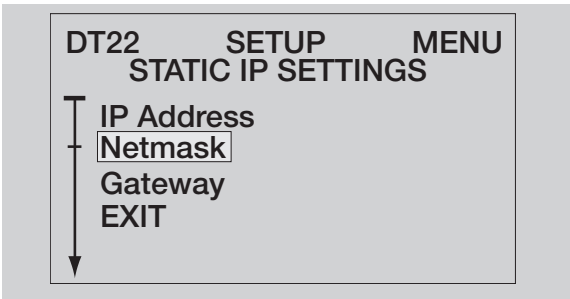

- 1) Highlight **Edit** using the **UP** arrow or **DOWN** arrow buttons.
- 2) Press the **ENTER** button.

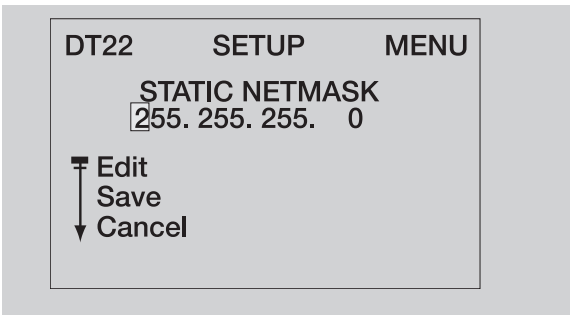

- 1) Press the **UP/DOWN** arrows to change the first **Static Netmask** digit.
- 2) Press the **LEFT/RIGHT** arrows select the next **Static Netmask** digit.
- 3) Press the **ENTER** button when done.

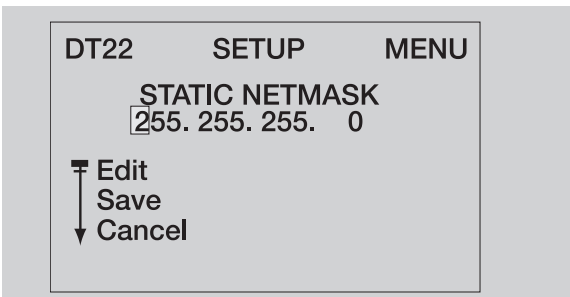

- 1) Highlight **Edit** using the **UP** arrow or **DOWN** arrow buttons to change **Static Netmask**.
- 2) Highlight **Save** using the **UP** arrow or **DOWN** arrow buttons to save the change.
- 3) Highlight **Cancel** using the **UP** arrow or **DOWN** arrow buttons to revert the previous setting.
- 4) Press the **ENTER** button to commit either **Save** or **Cancel**.

Static IP Gateway

- 1) Highlight **GATEWAY** using the **UP** arrow or **DOWN** arrow buttons.
- 2) Press the **ENTER** button.



- 1) Highlight **Edit** using the **UP** arrow or **DOWN** arrow buttons.
- 2) Press the **ENTER** button.

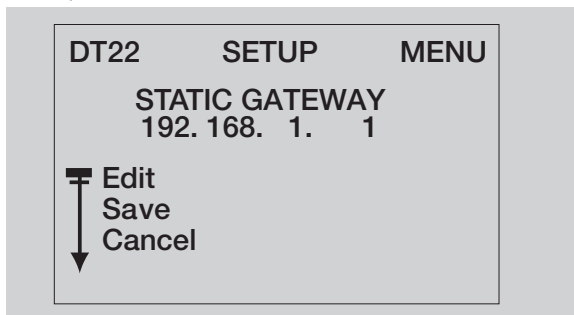

- 1) Press the **UP/DOWN** arrows to change the first **Static Gateway** digit.
- 2) Press the **LEFT/RIGHT** arrows select the next **Static Gateway** digit.
- 3) Press the **ENTER** button when done.

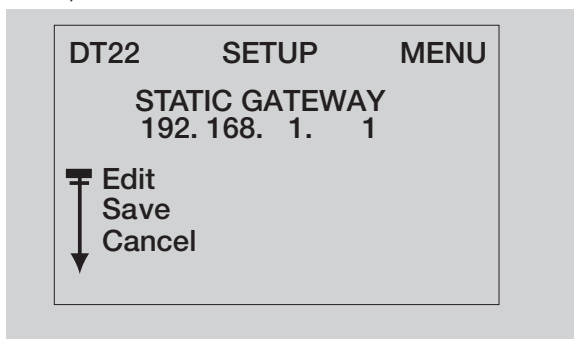

- 1) Highlight **Edit** using the **UP** arrow or **DOWN** arrow buttons to change **IP Gateway**.
- 2) Highlight **Save** using the **UP** arrow or **DOWN** arrow buttons to save the change.
- 3) Highlight **Cancel** using the **UP** arrow or **DOWN** arrow buttons to revert the previous setting.
- 4) Press the **ENTER** button to commit either **Edit**, **Save** or **Cancel**.

Show Current

Show Current displays the currently assigned **IP Address, Mask, and Gateway**.

- 1) Highlight **Show Current** using the **UP** arrow or **DOWN** arrow buttons.
- 2) Press the **ENTER** button.

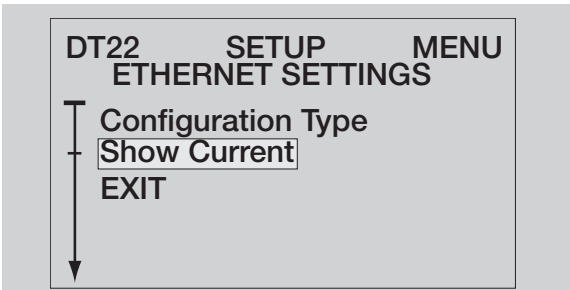

1) Press the **ENTER** button when done.

NOTE: The values shown will be different for your network. Also, these numbers will not be correct until after a reboot if the “Configuration Type” or “Static Parameters” values have been changed.

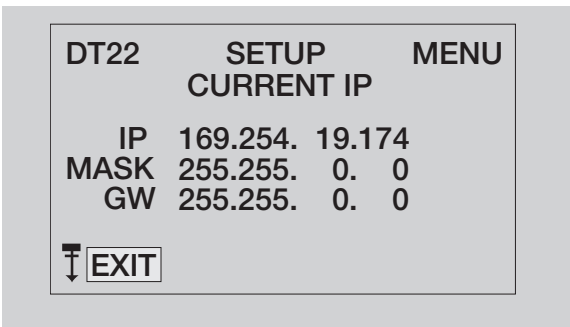

ZNet Bridge

The S66A, S128P, and Z630 ELAN multi-room controllers are not VIANet enabled devices. Instead these controllers use an older communication standard called ZNet. An Elan system containing at least one System SS1 or System SC1 will automatically convert the older ZNet feedback into VIANet feedback. However, in systems without a System SS1 or System SC1, the DT22 can provide this functionality, but must be manually enabled using this procedure.

- 1) Highlight **ZNet** using the **UP** arrow or **DOWN** arrow buttons.
- 2) Press the **ENTER** button.

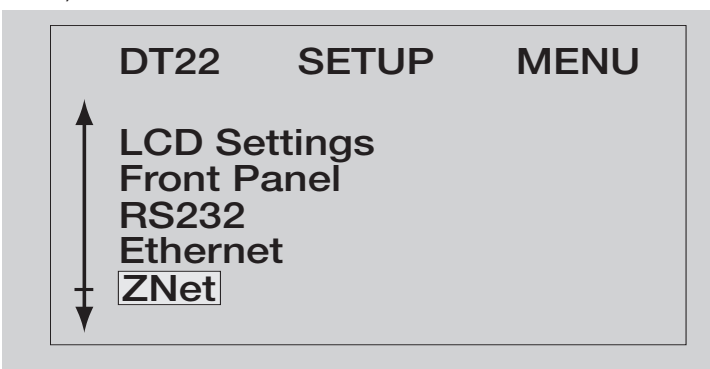

- 1) Highlight **Edit** using the **UP** arrow or **DOWN** arrow buttons.
- 2) Press the **ENTER** button.

See next page for example

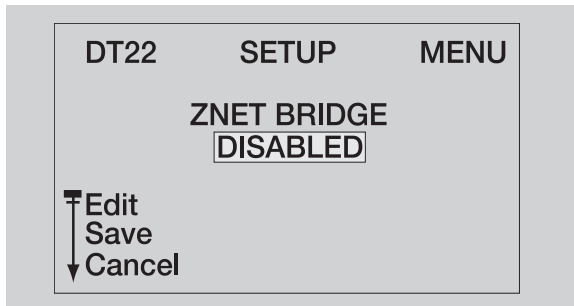

- 1) Press the **UP/DOWN** arrows to select the type of **ZNet Bridge**.
- 2) Press the **ENTER** button when done.

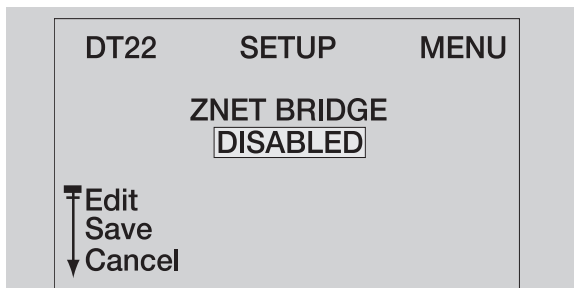

- 1) Highlight **Edit** using the **UP** arrow or **DOWN** arrow buttons to change the **ZNET BRIDGE**.
- 2) Highlight **Save** using the **UP** arrow or **DOWN** arrow buttons to save the change.
- 3) Highlight **Cancel** using the **UP** arrow or **DOWN** arrow buttons to revert the previous setting.
- 4) Press the **ENTER** button to commit either **Edit**, **Save** or **Cancel**.

Region

The DT22 can operate in the **United States/North America or Europe/Asia**.

- 1) Highlight **Region** using the **UP** arrow or **DOWN** arrow buttons.
- 2) Press the **ENTER** button.

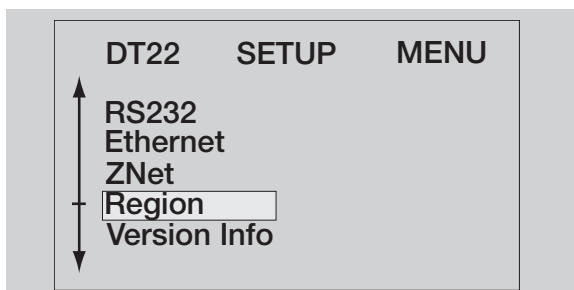

- 1) Highlight **Edit** using the **UP** arrow or **DOWN** arrow buttons.
- 2) Press the **ENTER** button.

See next page for example

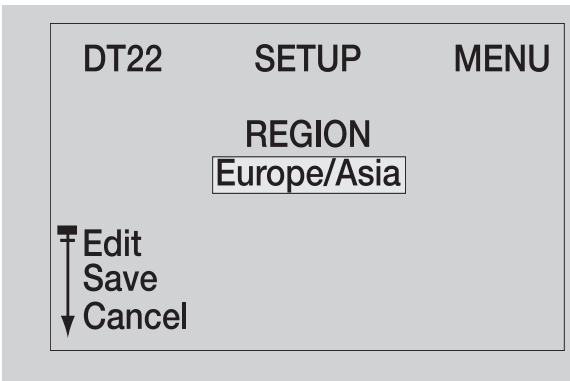

- 1) Press the **UP/DOWN** arrows to select the type of **Region**.
- 2) Press the **ENTER** button when done.

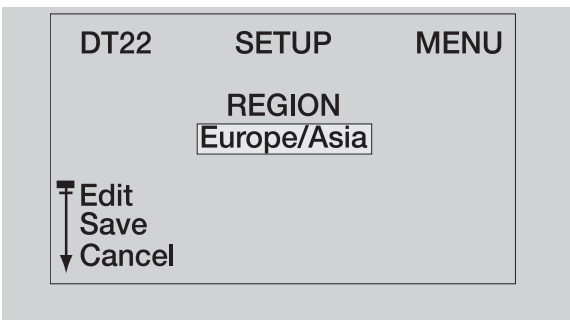

- 1) Highlight **Edit** using the **UP** arrow or **DOWN** arrow buttons to change the **Region**.
- 2) Highlight **Save** using the **UP** arrow or **DOWN** arrow buttons to save the change.
- 3) Highlight **Cancel** using the **UP** arrow or **DOWN** arrow buttons to revert the previous setting.
- 4) Press the **ENTER** button to commit either **Edit**, **Save** or **Cancel**.

Version Info

The **Version Info** screen shows what version of firmware the DT22 is currently running.

- 1) Highlight **Version Info** using the **UP** arrow or **DOWN** arrow buttons.
- 2) Press the **ENTER** button.

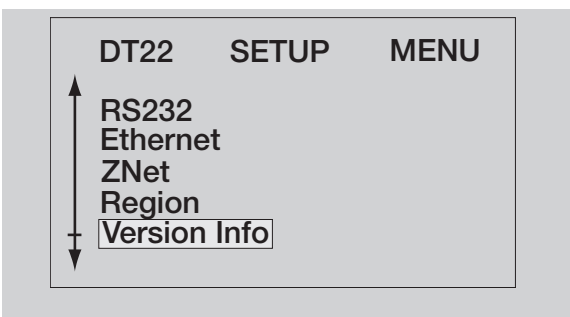

- 1) Press the **Enter** button when done.

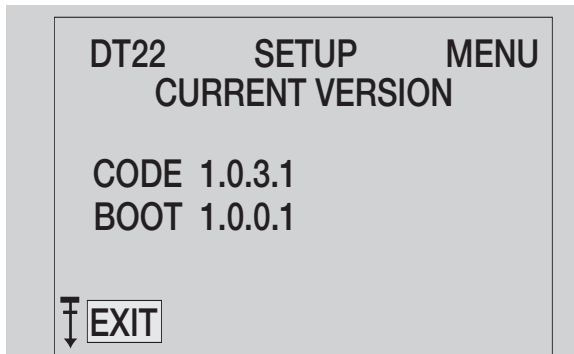

Restore Defaults

This resets all setup menu options back to the original factory values. This also clears all saved presets and overrides. This will not change the current firmware version.

- 1) Highlight **Restore Defaults** using the **UP** arrow or **DOWN** arrow buttons.
- 2) Press the **ENTER** button.

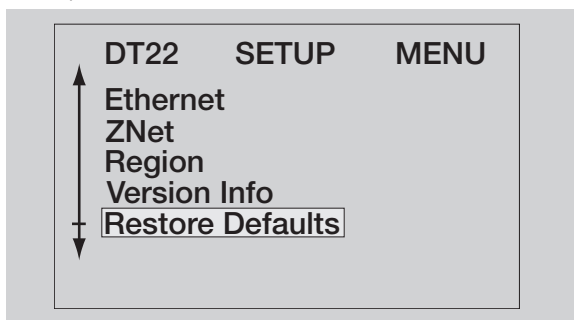

- 1) Press the **UP/DOWN** arrows to select the type of **Yes/Reboot** or **No/Cancel**.
- 2) Press the **ENTER** button when done.

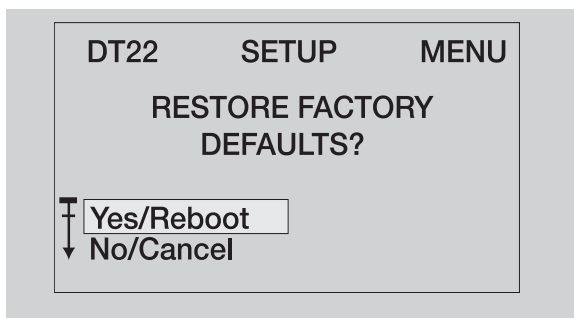

Remote Control Operation

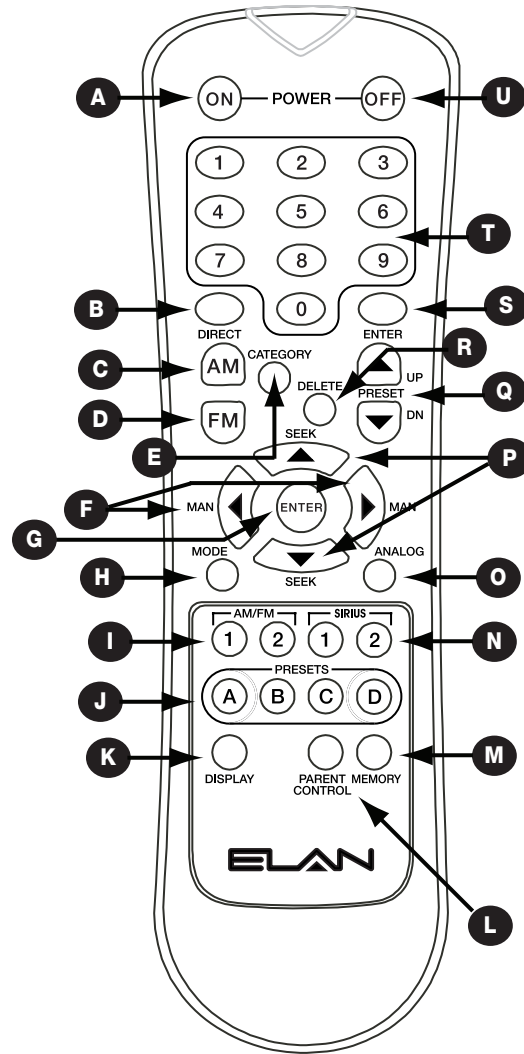

DT22 IR Remote Control

A. POWER ON

Turns the DT22 ON.

B. DIRECT Button

Places the DT22 into Direct mode, allowing the user to use the 0-9 numeric buttons to directly enter a channel's frequency.

C. AM Button

Selects AM on the selected tuner.

D. FM Button

Selects FM on the selected tuner.

E. Category Button

Selects Category mode on SIRIUS Tuner 1 or 2 (if equipped).

F. Manual Up/Down Tuning Buttons

Increments/Decrements the tuner selection manually.

G. Enter Button

Verify or confirm an intended operation or function. Also toggles SIRIUS display between Artist, Title, Composer, and channel name/category.

H. Mode Button

Toggles Stereo ON/OFF for FM stations.

I. AM-FM 1-2 (Tuner 1-2)

Selects AM/FM Tuner #1 or #2 on the unit's front panel.

J. Preset Buttons A-D

Pressing and releasing a preset button (A-D) will select the preset group indicated on the button and place the tuner into preset tune mode. The user can then tune to a specific preset in that group by pressing any two of the numeric buttons such as 01 or 99.

K. Display Button

Activates the front panel LCD and display the metadata for the channel that is currently active.

L. Parent Control Button

No function for this model.

M. Memory Button

Saves the current station selection to a preset. After pressing this button, the user can either press two numeric buttons to save to a specific preset, or press the enter button to save to the next available preset slot.

N. SIRIUS 1-2

Selects SIRIUS Tuner #1 or #2 (if equipped).

O. Analog Button

No function for this model.

P. Seek Up/Down Buttons

Increment/Decrement the tuner selection automatically to the next channel.

Q. Preset Up/Down Buttons

Increment/Decrement the Preset station selection to the next programmed Preset channel in memory.

R. Delete Button

Deletes a selected channel Preset from memory and is confirmed by pressing the Enter button.

S. Enter Button

Verify or confirm an intended operation or function.

T. 0-9 Numeric Buttons

These buttons are used for direct station access and recalling presets.

U. OFF Button

Turns the DT22 OFF.

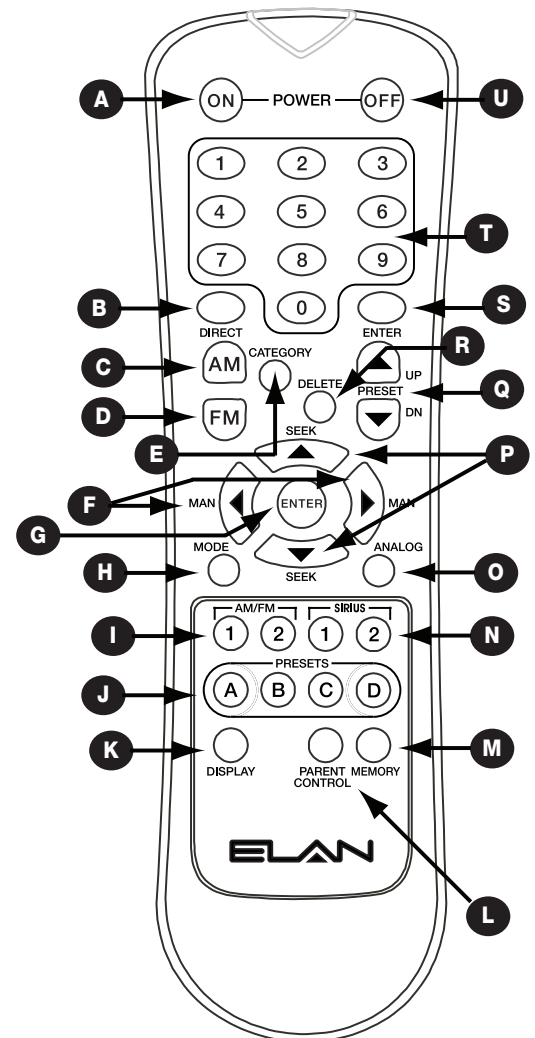

DT22 IR Remote Control

Troubleshooting

Audio Troubleshooting Procedures

Symptom	Possible Cause/s	What an authorized installer can do
No power up.	<ol style="list-style-type: none"> 1. No AC power. 2. Blown fuse. 	<ol style="list-style-type: none"> 1. a. Check Power switch. b. Connect Power Cord to AC outlet. c. Check AC circuit breaker. 2. Replace fuse w/ T2AL type fuse, 2A only.
No audio.	<ol style="list-style-type: none"> 1. See No power up Symptom. 2. Source on Receiver not selected. 3. Source selected in wrong zone. IR zone controller (keypad etc.) connected to wrong zone. 4. Output's volume turned all the way down. 5. Speakers or volume controls miswired or defective. 6. Zone audio output(s) connected to wrong amplifier input(s). 	<ol style="list-style-type: none"> 1. Press Play, tune station, turn on etc. 2. Select Source on Receiver. 3 a. Consult front panel display to determine Zone selection. b. Connect IR keypad or touch panel to correct zone. 4. Increase volume. 5. Test known good speaker/volume control at amplifier. 6. Verify connections.

Symptom	Possible Cause/s	What an authorized installer can do
No audio present in any zone.	<ol style="list-style-type: none"> 1. See above. 2. External amplifier powered down. 3. External amp in protect mode. 	<p>Perform steps above.</p> <p>Turn amp ON. Ensure that any remote turn on cables are connected at both ends.</p> <p>Find cause of amp's protection mode and correct. Miswired speakers or volume controls most likely cause.</p>

IR Control Troubleshooting Procedures

Symptom	Possible Cause/s	What an authorized installer can do
No source control from IR controller (keypad, hand-held remote, etc.). IR LED does NOT flash when button pressed.	<ol style="list-style-type: none"> 1. IR controller not programmed. 2. IR signal path wiring bad. 	<p>Program IR controller.</p> <p>Verify IR signal path wiring. Check keypads, IR sensors, IR distribution blocks, V8 IR Input jack, IR emitters, etc.</p>
Source not selected from IR controller (keypad, hand-held remote, etc.). IR LED DOES flash when button pressed.	Incorrect IR commands programmed.	Verify/correct IR programming.
Intermittant or no source or zone control from IR controller (keypad, hand-held remote, etc.). IR LED flickers or is lit constantly.	IR flooding.	Check IR receivers for ambient light or plasma TV flooding.

RS232 Control Troubleshooting Procedures

Symptom	Possible Cause/s	What an authorized installer can do
No source or zone selected from RS-232 controller.	1. RS-232 controller incorrectly programmed. 2. RS-232 signal path wiring bad.	Verify/correct programming. Verify RS-232 wiring. Check wire integrity and pin-out configuration.
Incorrect source and/or zone selected.	The system source select RS-232 commands were incorrectly programmed.	Verify/correct programming.
Acknowledgement ACK,xxx<CR> is not received within 200ms	1. The command was formatted incorrectly. 2. An error has occurred in the DT22. 3. Serial cable not connected or defective. 4. DT22 does not have power.	Verify/correct programming. Turn unit OFF, then back ON. Connect or replace serial cable. Connect power, check breakers.

VIA!NET Control Troubleshooting Procedures

Symptom	Possible Cause/s	What an authorized installer can do
No source or zone selected from VIA!NET controller (VIA! Touch Panel, etc.).	1. VIA!NET controller not programmed. 2. VIA!NET signal path wiring bad.	Program VIA!NET controller. Verify VIA!NET wiring.
Incorrect source and/or zone selected.	Incorrect system commands programmed.	Verify/correct programming.

ETHERNET Control Troubleshooting Procedures

Symptom	Possible Cause/s	What an authorized installer can do
Not able to download firmware update.	1. Ethernet I.P. address incorrect. 2. Router or DSL Modem not connected or powered up. 3. Ethernet signal path wiring bad.	Verify Ethernet I.P. address. Verify connectivity and Power status. Verify Ethernet wiring.

Signal Reception Control Troubleshooting Procedures

Symptom	Possible Cause/s	What an authorized installer can do
No signal reception, or poor signal reception	1. Antenna not plugged in to DT22. 2. Antenna signal path wiring bad.	Verify antenna connection. Verify antenna cable wiring

Technical Support

If, after carefully following the steps in the **Troubleshooting** section, you are unable to resolve issues with the installation or operation of the DT22, please call ELAN Technical Support at 1-800-622-ELAN (3526).

Appendix A Specifications

Table A-1 shows the equipment specifications for the DT22 Multi-Room Integrated Controller.

DT22 Specifications

Item	Description
Control Ports IR In/Out VIA!Net In/Out RS-232 Ethernet Analog Audio Outputs Digital Audio Outputs Antenna Inputs SIRIUS Ready Connectors	(2) 3.5mm jacks (2) RJ-45 (1) Female DB9 (DCE) (1) RJ-45 T568A (4 pr.) RCA Stereo (2) Optical TOS Link (1) Coax FM Antenna (1) AM Antenna Push Terminal (2) 8 Pin DIN
Audio: FM Tuning Frequencies Frequency Response Signal-to-Noise	76 ~ 108MHz 300Hz to 15kHz, +0/-3dB 63dB (Mono) / 58dB (Stereo)
Audio: AM Tuning Frequencies Signal-to-Noise	520 ~ 1710kHz 56dB
Power Requirements	120VAC, 35W / 240VAC 35W Fuse Value = 2A
Dimensions w/Feet (2U w/o Feet)	17 W x 3 1/2 H x 14 D (in.) 432 W x 89 H x 356 D (mm)
Weight	13.6 lbs/6 kgs

Appendix B: Serial Protocol

Port Configuration

8 data bit, no parity, 1 stop bit

Baud Rates:

- 115200: Default, lower speeds will cause increased lag in unsolicited notifications.
- 57600
- 38400
- 19200
- 9600

Messages

Incoming messages must be terminated with a carriage return (13 in decimal or 0x0d in hex.)

Carriage returns will be represented as <cr> in this document.

Incoming linefeeds, 10 in decimal or 0x0D in hex, will be ignored.

All responses and unsolicited notifications will be terminated by carriage return only.

Unsolicited Feedback notifications

This is feedback that the DT22 automatically transmits whenever its state changes.

The <COMMAND> section will state if a response will be sent unsolicited or not.

Query/Response Command Structure

Query commands ask the DT22 for information.

Each main body of the command structure is separated by a comma (44 in decimal or 0x2C in hex.)

Query

- &DT,<dd>,<COMMAND>,<SUBCOMMAND>,<?><cr>
- &DT will always precede the query
- <SUBCOMMAND> may or may not be used.
- Always end in ,?<cr> (comma, question mark, carriage return)

Response:

- *DT,<dd>,<COMMAND>,<SUBCOMMAND><cr>
- *DT will always precede the response
- <SUBCOMMAND> may or may not be used.
- Always end in <cr> (carriage return)

Dump Command Structure

Dump command structure is a query but does not follow the same response pattern as the Query command structure. The Query command structure Response started with a * (asterisk). Dump outputs information in XML.

Status Command Structure

Status command structure is a query but does not follow the same response pattern as the Query command structure. The Query command structure Response started with a * (asterisk). Status outputs information in formatted sentences.

Command Structure

Each main body of the command structure is separated by a comma (44 in decimal or 0x2C in hex.)

&DT,<dd>,<COMMAND>,<SUBCOMMAND><cr>

dd is the address of the command.

Valid addresses are:

- **CH**: DT22 chassis
- **ST**: Selected Tuner
- **R1**: First AM/FM radio
- **R2**: Second AM/FM radio
- **S1**: First SIRIUS module
- **S2**: Second SIRIUS module

&DT will always precede the Command:.

<SUBCommand> may or may not be used.

<cr> carriage return will always follow the command.

<COMMAND>

All commands will be acknowledged if they are successfully decoded.

Commands which are not understood will be ignored, and no response will be generated.

The **ACK** response will look like this: ***DT,dd,ACK<cr>**

Power On/Off/Toggle

Command:

&DT,CH,POWER,ON<cr>

Function:

Turns DT22 on.

Command:

&DT,CH,POWER,OFF<cr>

Function:

Turns DT22 off.

Command:

&DT,CH,POWER,TOGGLE<cr>

Function:

Toggles DT22 power state.

Query:

&DT,CH,POWER,?<cr>

Function:

Queries current power state.

This command is sent as unsolicited notifications.

Response:

*DT,CH,POWER,ON<cr>

or

*DT,CH,POWER,OFF<cr>

Select**Command:**

&DT,CH,SELECT,nn<cr>

nn = R1, R2, S1 or S2

Function:

Selects an AM/FM or SIRIUS radio to display on the LCD.

Query:

&DT,CH,SELECT,?<cr>

Function:

Queries the currently selected tuner.

This response is sent as unsolicited feedback.

Response:

*DT,CH,SELECT,R1<cr>

or

*DT,CH,SELECT,R2<cr>

Display On**Command:**

&DT,CH,DISPLAY,ON

Function:

Turns on the LCD backlight.

Reboot**Command:**

&DT,CH,REBOOT<cr>

Function:

Reboots the DT22.

Config

Status

Query:

&DT,CH,STATUS<cr>

Function:

Outputs the current operating conditions stored in the unit.
The information is in a sentence format.

Config Status

Query:

&DT,CH,CONFIG,STATUS<cr>

Function:

Outputs the current configuration stored in the unit.
The information is in a sentence format.

Config Preset Status

Query:

&DT,CH,CONFIG,PRESETS,STATUS<cr>

Function:

Outputs the current preset information stored in the unit.
The information is in a sentence format.

Config Overrides Status

Query:

&DT,CH,CONFIG,OVERRIDES,STATUS<cr>

Function:

Outputs the current override information stored in the unit.
The information is in a sentence format.

Config Dump

Query:

&DT,CH,CONFIG,DUMP<cr>

Function:

Outputs the current configuration stored in the unit.
The information is in an XML format.

Config Preset Dump

Query:

```
&DT,CH,CONFIG,PRESETS,DUMP<cr>
```

Function:

Outputs the current preset information stored in the unit.
The information is in an XML format.

Config Overrides Dump

Query:

```
&DT,CH,CONFIG,OVERRIDES,DUMP<cr>
```

Function:

Outputs the current override information stored in the unit.
The information is in an XML format.

Config Factory Reset

Command:

```
&DT,CH,CONFIG,FACTORY-RESET
```

Function:

Sets all configuration to the factory defaults.

Unit ID

Command:

```
&DT,CH,CONFIG,UNITID,x<cr>
```

x = 1, 2

Function:

Sets the unit ID of the DT22.
DT22 must be rebooted for change to take effect.

Query:

```
&DT,CH,CONFIG,UNITID,?<cr>
```

Function:

Queries the current ID of the DT22.

Response:

```
*DT,CH,CONFIG,UNITID,1<cr>
```

or

```
*DT,CH,CONFIG,UNITID,2<cr>
```

Config RS232 Unsolicited Feedback On/Off

Command:

```
&DT,CH,CONFIG,RS232,UFB,ON<cr>
```

Function:

Sets **DEFAULT** state of unsolicited feedback to the RS232 port to on.

Whenever power is turned off and on, unsolicited data is set to **On** if this command was sent to the **DT22** prior to turning off.

Use **UFB On/Off** command if unsolicited data needs to be changed during operation.

Unsolicited feedback is always **On** for Ethernet by default.

Command:

```
&DT,CH,CONFIG,RS232,UFB,OFF<cr>
```

Function:

Sets **DEFAULT** state of unsolicited feedback to the RS232 port to off.

Whenever power is turned off and on, unsolicited data is set to **Off** if this command was sent to the **DT22** prior to turning off.

Use **UFB On/Off** command if unsolicited data needs to be changed during operation.

Unsolicited feedback is always **On** for Ethernet by default.

Query:

```
&DT,CH,CONFIG,RS232,UFB,?<cr>
```

Function:

To query the state of unsolicited feedback.

Response:

```
*DT,CH,CONFIG,RS232,UFB,ON<cr>
```

or

```
*DT,CH,CONFIG,RS232,UFB,OFF<cr>
```

UFB On/Off (Unsolicited Feedback)

Command:

```
&DT,CH,UFB,ON<cr>
```

Function:

Turns on unsolicited feedback for the RS232 port if this command was received from the RS232 port.

Turns on unsolicited feedback for the Ethernet port if this command was received from the Ethernet port.

Command:

```
&DT,CH,UFB,OFF<cr>
```

Function:

Turns off unsolicited feedback for the RS232 port if this command was received from the RS232 port.

Turns off unsolicited feedback for the Ethernet port if this command was received from the Ethernet port.

Query:

```
&DT,CH,UFB,?<cr>
```

Function:

Queries the unsolicited feedback state during operation.

Default state of unsolicited feedback for RS232 is controlled by config value.

Default state of unsolicited feedback for Ethernet is ON.

Response:

*DT,CH,UFB,ON<cr>

or

*DT,CH,UFB,OFF<cr>

Boot Version**Query:**

&DT,CH,VERSION,BOOT,?<cr>

Function:

Queries current boot loader version.

Response:

*DT,CH,VERSION,BOOT,1.0.0.1<cr>

Code Version**Query:**

&DT,CH,VERSION,CODE,?<cr>

Function:

Queries current application version.

Response:

*DT,CH,VERSION,CODE,1.0.0.1<cr>

Mode: Direct/Preset/Category**Command:**

&DT,dd,MODE, xx<cr>

Function:

Puts the desired tuner in one of three modes.

dd = ST, R1, R2, S1, S2

xx = DIRECT, PRESET, CATEGORY (Category mode applies only to SIRIUS module)

Command:

&DT,dd,MODE,TOGGLE<cr>

dd = ST, R1, R2

Function:

Toggles the DT22 from **Preset** to **Direct** or from **Direct** to **Preset**.

Command:

&DT,dd,MODE,TOGGLE<cr>

dd = ST, S1, S2

Function:

Toggles the DT22 from **Preset** to **Category** or from **Category** to **Direct** or from **Direct** to **Preset**.

Query:

&DT,dd,MODE,?<cr>

dd = ST, R1, R2, S1, S2

Function:

Query the desired tuner's mode.
This response will also be sent as unsolicited feedback.

Response:

*DT,R1,MODE,DIRECT<cr> or
*DT,R1,MODE,PRESET<cr> etc.

Digit

Command:

&DT,**dd**,DIGIT,x<cr>
dd = ST, R1, R2, S1, S2
x = 0 - 9

Function:

Sends a digit to the desired tuner.

Enter

Command:

&DT,**dd**,ENTER<cr>
dd = ST, R1, R2, S1, S2

Function:

Sends the enter key to the desired tuner.

Cancel

Command:

&DT,**dd**,CANCEL<cr>
dd = ST, R1, R2, S1, S2

Function:

Used to cancel some actions.

Group

Command:

&DT,**dd**,GROUP,**g**<cr>
dd = ST, R1, R2, S1, S2
g = A, B, C, D

Function:

Selects a preset group on the desired tuner.
Changing preset groups will likely cause the current station to change.

Query:

&DT,**dd**,GROUP,?<cr>

dd = ST, R1, R2, S1, S2

Function:

Query the desired tuner's preset group.
This response will also be sent as unsolicited feedback.

Response:

*DT,R1,GROUP,A<cr>

or

*DT,R1,GROUP,B<cr>

or

*DT,R1,GROUP,C<cr>

or

*DT,R1,GROUP,D<cr>

Preset

Command:

&DT,**dd**,PRESET,UP<cr>

dd = ST, R1, R2, S1, S2

Function:

Go to next preset on the desired tuner.

Command:

&DT,**dd**,PRESET,DOWN<cr>

dd = ST, R1, R2, S1, S2

Function:

Go to previous preset on the desired tuner.

dd = ST, R1, R2, S1, S2

Query:

&DT,**dd**,PRESET,?<cr>

dd = ST, R1, R2, S1, S2

Function:

Query current preset of the desired tuner.
This response will also be sent as unsolicited feedback.

Response:

*DT,R1,PRESET,15<cr> (Tuned to preset 15 in current group)

or

*DT,R1,PRESET,0<cr> (Not tuned to a preset now)

Command:

&DT,**dd**,PRESET,**mm**<cr>

dd = ST, R1, R2, S1, S2

mm = 1 - 99

Function:

Tunes to preset **mm**.

Command:

&DT,**dd**,PRESET,SAVE<cr>

dd = ST, R1, R2, S1, S2

Function:

Begins saving the current station to a preset.

&DT,R1,PRESET,SAVE<cr> Preset number is specified using the **DIGIT** and **ENTER** command.

&DT,R1,DIGIT,1<cr>

&DT,R1,DIGIT,0<cr>

&DT,R1,ENTER<cr>

Current station is saved to current group's preset 10.

If two digits are given, **ENTER** is not required.

&DT,R1,PRESET,SAVE<cr>

&DT,R1,DIGIT,1<cr>

&DT,R1,DIGIT,7<cr>

Current station is saved to current group's preset 17.

Sending **ENTER** without any digits will save to the first open preset.

&DT,R1,PRESET,SAVE<cr>

&DT,R1,ENTER<cr>

Timeout is 5 seconds. Preset WILL be saved in case of timeout.

&DT,R1,PRESET,SAVE<cr>

&DT,R1,DIGIT,3<cr>

Wait 5 seconds...

Current station is saved to current group's Preset 3.

Send **CANCEL** or any other command to prevent saving of preset.

&DT,R1,PRESET,SAVE<cr>

&DT,R1,DIGIT,1<cr>

&DT,R1,CANCEL<cr>

No preset is saved.

Command:

&DT,**dd**,PRESET,SAVE,**mm**<cr>

dd = ST, R1, R2, S1, S2

mm = 1 - 99

mm = 0 will save to the first available preset.

Function:

Saves the current station to a given preset on currently active group.

Send **Group** command first to save to a specific group.

Command:

&DT,**dd**,PRESET,DELETE<cr>

dd = ST, R1, R2, S1, S2

Function:

Begins deleting the current tuned preset.

ENTER command is required to delete.

If no preset is tuned, nothing is deleted.

&DT,R1,PRESET,DELETE<cr>

&DT,R1,ENTER<cr>

Timeout is 5 seconds. Preset WILL NOT be deleted in case of timeout.

&DT,R1,PRESET,DELETE<cr>

Wait 5 seconds...

Current tuned preset is not deleted.

Send CANCEL or any other command to cancel a deletion.

&DT,R1,PRESET,DELETE<cr>

&DT,R1,CANCEL<cr>

Command:

&DT,dd,PRESET,DELETE,ENTER<cr>

dd = ST, R1, R2, S1, S2

Function:

Deletes the current preset immediately.

MDF (Metadata Feedback)

Query:

&DT,dd,MDF,G,?<cr>

dd = ST, R1, R2, S1, S2

Function:

Query the current Genre / Category / PTY.

This response will also be sent as unsolicited feedback.

Response:

*DT,R1,G,Rock<cr>

Query:

&DT,dd,MDF,S,?<cr>

dd = ST, R1, R2, S1, S2

Function:

Query the current short station / channel name / PI.

This response will also be sent as unsolicited feedback.

This is only available and valid for some North American radio stations.

Response:

*DT,R1,G,WKQQ<cr>

Query:

&DT,dd,MDF,L,?<cr>

dd = ST, R1, R2

Function:

Query the current long station / channel name / PS.

This response will also be sent as unsolicited feedback.

In North American this may duplicate RT data.

Response:

*DT,R1,L,98.1 The Bull - WKQQ<cr>

Query:

&DT,dd,MDF,A,?<cr>

dd = ST, S1, S2

Function:

Query the current artist name.

This response will also be sent as unsolicited feedback.

Response:

*DT,S1,A,Jeff Beck<cr>

Query:

&DT,dd,MDF,T,?<cr>

dd = ST, S1, S2

Function:

Query the current song title.

This response will also be sent as unsolicited feedback.

Response:

*DT,S1,T,Amanda<cr>

Query:

&DT,dd,MDF,R,?<cr>

dd = ST, R1, R2, S1, S2

Function:

Query the current RDS radio text / RT/Composer (for SIRIUS).

This response will also be sent as unsolicited feedback.

Response:

*DT,S1,MDF,R,Amadeus Mozart<cr>

Query:

&DT,dd,MDF,?<cr>

dd = ST, R1, R2, S1, S2

Function:

Query all metadata

Response:

One each of the MDF Responses listed above.

Signal

Query:

&DT,dd,SIGNAL,?<cr>

dd = ST, R1, R2, S1, S2

Function:

Query the current signal level.

Signal level from 0 to 100 percent.

This response will also be sent as unsolicited feedback.

Response:

*DT,R1,SIGNAL,100<cr>

Preset Scan**Command:**

&DT,dd,SCAN,UP<cr>

dd = ST, R1, R2, S1, S2

Function:

Begin scanning up through all presets in the current group.

Each preset is played for 10 seconds.

Send any other command to stop scanning.

Command:

&DT,dd,SCAN,DOWN<cr>

dd = ST, R1, R2,S1, S2

Function:

Begin scanning down through all presets in the current group.

Each preset is played for 10 seconds.

Send any other command to stop scanning.

AM/FM Band**Command:**

&DT,dd,BAND,AM<cr>

dd = ST, R1, R2

Function:

Switch to AM band on desired tuner.

This will also switch to the last AM station played on this tuner.

Command:

&DT,dd,BAND,FM<cr>

dd = ST, R1, R2

Function:

Switch to FM band on desired tuner.

This will also switch to the last FM station played on this tuner.

Query:

&DT,dd,BAND,?<cr>

dd = ST, R1, R2

Function:

Query the currently selected band of the desired tuner.

This response will also be sent as unsolicited feedback.

Response:

*DT,R1,BAND,AM<cr>

or

*DT,R1,BAND,FM<cr>

Tune

Command:

&DT,**dd**,TUNE,**ffff**<cr>

dd = ST, R1, R2

ffff = Desired Frequency

Function:

Tune to the given frequency.

FM: desired frequency divided by 10 kHz.

EXAMPLE: &DT,R1,TUNE,9810 (Tunes to 98.1 MHz)

AM: desired frequency divided by 1 kHz.

EXAMPLE: &DT,R1,TUNE,630 (Tunes to 630 kHz)

Not all values are valid. Valid values depend on band and region.

Command:

&DT,**dd**,TUNE,**ccc** <cr>

dd = ST, S1, S2

ccc = SIRIUS Channel Number (no leading zeros)

Function:

Tunes to specific SIRIUS channel.

EXAMPLE: &DT,S1,TUNE,8<cr> (Tunes to 80's channel)

Not all values are valid. Valid values depend on SIRIUS subscription.

Command:

&DT,**dd**,TUNE,UP<cr>

dd = ST, R1, R2, S1, S2

Function:

Step up one frequency step/channel number.

Actual step size depends on band, region and SIRIUS subscription.

Command:

&DT,**dd**,TUNE,DOWN<cr>

dd = ST, R1, R2, S1, S2

Function:

Step down one frequency step/channel number.

Actual step size depends on band, region and SIRIUS subscription.

Query:

&DT,**dd**,TUNE,?<cr>

dd = ST, R1, R2, S1, S2

Function:

Request the currently tuned frequency/channel number.

This response will also be sent as unsolicited feedback.

Response:

*DT,R1,TUNE,10010<cr> (In units of 10kHz for FM) or
*DT,R1,TUNE,1630<cr> (In units of 1kHz for AM) or
*DT,S1,TUNE,8<cr> (3 digit SIRIUS channel) etc.

Seek**Command:**

&DT,dd,SEEK,UP<cr>
dd = ST, R1, R2

Function:

Seek up to next valid station.

Command:

&DT,dd,SEEK,DOWN<cr>
dd = ST, R1, R2

Function:

Seek down to next valid station.

Stereo**Command:**

&DT,dd,STEREO,ON<cr>
dd = ST, R1, R2

Function:

Attempt to force stereo decoding on.
If a stereo signal is not present, this will do nothing.

Command:

&DT,dd,STEREO,OFF<cr>
dd = ST, R1, R2

Function:

Attempt to disable stereo decoding.
Switching stations will clear this request.

Command:

&DT,dd,STEREO,TOGGLE<cr>
dd = ST, R1, R2

Function:

Attempt to toggle stereo decoding on and off.
If stereo signal is not preset, this will do nothing.
Switching stations will clear this request.

Query:

&DT,dd,STEREO,?<cr>
dd = ST, R1, R2

Function:

Query whether current station is playing in stereo.

This response will also be sent as unsolicited feedback.

Response:

*DT,R1,STEREO,ON<cr>

*DT,R1,STEREO,OFF<cr>

Appendix C: Connecting Optional SIRIUS Tuner Modules

Connecting the Sirius tuner module to the DT22/DT11

- 1) Refer to the instructions included with the Sirius tuner module (sold separately) for detailed installation information.
- 2) Connect the Sirius tuner module to the DT22/11 using the 8 pin DIN cable supplied with the tuner.

Displaying the signal strength meter

Using the front panel buttons;

- 1) Turn the unit on by depressing the **TUNER** button for 2 seconds.
- 2) Select Sirius Tuner 1 by pressing the **TUNER** button.
- 3) Press and hold **MODE** button for 2 seconds.
- 4) Press **ENTER** to select **Signal Details**.
- 5) Satellite and Terrestrial signal strength bar graphs are displayed.
- 6) Adjust antenna for maximum signal levels.
- 7) Repeat process above for Sirius Tuner 2 (DT22 only).

Connecting RCA outputs to system

See the diagram on page 16

A note about activation of the tuner

SIRIUS Radio is a subscription service and each tuner must be activated. Tune your SIRIUS radio to station 184 and then;

Call 1-888-539-SIRIUS

-OR-

Contact SIRIUS on the Internet at: <https://activate.siriusradio.com/>

You'll need a credit card and the SIRIUS tuner module ID(s) you wish to activate. The 12 digit tuner ID can be found on the tuner module, module packaging or by tuning to channel 0.

Choosing Sirius tuner 1 or 2 (DT22 only) from the front panel

- 1) Press **TUNER** repeatedly until Sirius 1 or Sirius 2 is displayed

Choosing Sirius tuner 1 or 2 (DT22 only) from the remote control

- 2) Press the **SIRIUS 1** or **SIRIUS 2** button

Direct Mode Operation

The Direct mode of operation allows the user to choose any Satellite radio station.

Choosing direct mode from the front panel:

- 1) Press the **MODE** button, highlight **Direct** using the Up/Down arrows then press **Enter**
- 2) While in direct mode:
 - a. Left/Right arrows select the previous/next station
 - b. Up/Down arrows select the next/previous Category

Choosing direct mode from the Remote Control

- 1) Press the **DIRECT** button
- 2) While in direct mode:
 - a. Left/Right arrows select the previous/next station
 - b. Up/Down arrows select the next/previous Category
 - c. Use the number pad to enter the 3 digit station number and jump directly to that station (i.e. 0-0-8) or the 1 or 2 digits plus enter

Category Mode Operation

While in Category mode, the unit will only display channels that reside in the currently selected category (i.e. Pop, Rock, Country, etc.)

Choosing category mode from the front panel:

- 1) Press the **MODE** button,
- 2) Highlight **Category** using the Up/Down arrows then press **ENTER**

While in Category mode:

- a. Left/Right arrows select the previous/next station within the Category
- b. Up/Down arrows select the next/previous Category

Choosing Category mode from the Remote Control

- 1) Press the **CATEGORY** button

- 2) While in Category mode:
 - a. Left/Right arrows select the previous/next station within selected category
 - b. Up/Down arrows select the next/previous Category
 - c. Enter 3 digit station number to jump directly to that station (i.e. 0-0-8)

Preset Mode Operation

Choosing preset mode from the front panel:

- 1) Press the **MODE** button, highlight **Preset** using the Up/Down arrows then press **ENTER**
- 2) While in Preset mode:
 - a. Left/Right arrows select the previous/next station
 - b. Up/Down arrows select the next/previous Preset

Choosing Preset Mode from the remote control:

- 1) Press **PRESET A, B, C, or D**
- 2) While in Preset mode:
 - a. Pressing **PRESET** Up/Down arrows chooses the next/previous preset
 - b. Entering the 2 digit preset number (01-99) selects a preset station
 - c. Left/Right arrows select the previous/next station
 - d. Up/Down arrows select the previous/next station

Storing a preset (A,B,C,D)

The DT22 allows for up to 396 Sirius presets that are shared across both tuners. These presets are identified as A01 – A99, B01-B99, C01 – C99, and D01 – D99.

- 1) Using the front panel, press **MODE** then use Up/Down/Enter to select **Preset Group A, B, C, or D**. Tune to the Sirius station you wish to store. Press **MEMORY**, select **Save Preset**. Use Up/Down/Left/Right/Enter to select first and second digit of preset number. Press **ENTER** and then choose **Save**.
- 2) Using the remote control press **PRESET A, B, C, or D**. Select Sirius station to be stored. Press **MEMORY** button. Use the number pad to enter two digits for preset to be stored (01-99).

Recalling a preset (A,B,C,D)

- 1) Using the remote control, press **PRESET A, B, C, or D**. Use the number pad to enter the two digit preset number (01-99).

Displaying the Sirius Firmware Version and Product ID

- 1) Press and hold **MODE** for two seconds. Use Up/Down/Enter to select **Module info**.

Viewing the DT22/DT11 firmware version

- 1) Turn the unit off by depressing the TUNER button for 2 seconds. The firmware version will appear at the bottom of the front panel display (ex. Version 1.1.0.6)

NOTE:

This product uses the FreeRTOS.org real time kernel.

The FreeRTOS.org source code can be obtained by visiting <http://www.FreeRTOS.org>.

FreeRTOS LICENSING (from):

“The FreeRTOS source code is licensed by the GNU General Public License (GPL) with an exception.

The full text of the GPL is available here: <http://www.freertos.org/license.txt>.

The text of the exception is available on FreeRTOS official website: <http://www.FreeRTOS.org> - License and Warranty Page

The exceptions permits the source code of applications that use FreeRTOS solely through the API published on this WEB site to remain closed source, thus permitting the use of FreeRTOS in commercial applications without necessitating that the whole application be open sourced. The exception should only be used if you wish to combine FreeRTOS with a proprietary product and you comply with the terms stated in the exception itself.”

lwIP

Copyright (c) 2001-2004 Swedish Institute of Computer Science.

All rights reserved.

Redistribution and use in source and binary forms, with or without modification, are permitted provided that the following conditions are met:

1. *Redistributions of source code must retain the above copyright notice, this list of conditions and the following disclaimer.*
2. *Redistributions in binary form must reproduce the above copyright notice, this list of conditions and the following disclaimer in the documentation and/or other materials provided with the distribution.*
3. *The name of the author may not be used to endorse or promote products derived from this software without specific prior written permission.*

THIS SOFTWARE IS PROVIDED BY THE AUTHOR “AS IS” AND ANY EXPRESS OR IMPLIED WARRANTIES, INCLUDING, BUT NOT LIMITED TO, THE IMPLIED WARRANTIES OF MERCHANTABILITY AND FITNESS FOR A PARTICULAR PURPOSE ARE DISCLAIMED. IN NO EVENT SHALL THE AUTHOR BE LIABLE FOR ANY DIRECT, INDIRECT, INCIDENTAL, SPECIAL, EXEMPLARY, OR CONSEQUENTIAL DAMAGES (INCLUDING, BUT NOT LIMITED TO, PROCUREMENT OF SUBSTITUTE GOODS OR SERVICES; LOSS OF USE, DATA, OR PROFITS; OR BUSINESS INTERRUPTION) HOWEVER CAUSED AND ON ANY THEORY OF LIABILITY, WHETHER IN CONTRACT, STRICT LIABILITY, OR TORT (INCLUDING NEGLIGENCE OR OTHERWISE) ARISING IN ANY WAY OUT OF THE USE OF THIS SOFTWARE, EVEN IF ADVISED OF THE POSSIBILITY OF SUCH DAMAGE.

Limited Warranty

ELAN HOME SYSTEMS L.L.C. ("ELAN") warrants the DT22 Dual AM/FM Tuner to be free from defects in materials and workmanship for the period of two years (2 years) from date of purchase. If within the applicable warranty period above purchaser discovers that such item was not as warranted above and promptly notifies ELAN in writing, ELAN shall repair or replace the item at the company's option. This warranty shall not apply (a) to equipment not manufactured by ELAN, (b) to equipment which shall have been installed by other than an ELAN authorized installer, (c) to installed equipment which is not installed to ELAN's specifications, (d) to equipment which shall have been repaired or altered by others than ELAN, (e) to equipment which shall have been subjected to negligence, accident, or damage by circumstances beyond ELAN's control, including, but not limited to, lightning, flood, electrical surge, tornado, earthquake, or other catastrophic events beyond ELAN's control, or to improper operation, maintenance or storage, or to other than normal use of service. With respect to equipment sold by, but not manufactured by ELAN, the warranty obligations of ELAN shall in all respects conform to the warranty actually extended to ELAN by its supplier. The foregoing warranties do not cover reimbursement for labor, transportation, removal, installation or other expenses which may be incurred in connection with repair or replacement.

Except as may be expressly provided and authorized in writing by ELAN, ELAN shall not be subject to any other obligations or liabilities whatsoever with respect to equipment manufactured by ELAN or services rendered by ELAN.

THE FOREGOING WARRANTIES ARE EXCLUSIVE AND IN LIEU OF ALL OTHER EXPRESSED AND IMPLIED WARRANTIES EXCEPT WARRANTIES OF TITLE, INCLUDING BUT NOT LIMITED TO IMPLIED WARRANTIES OF MERCHANTABILITY AND FITNESS FOR A PARTICULAR PURPOSE.

ATTENTION: TO OUR VALUED CONSUMERS

To ensure that consumers obtain quality pre-sale and after-sale support and service, ELAN Home Systems products are sold exclusively through authorized dealers. ELAN products are not sold online. The warranties on ELAN products are NOT VALID if the products have been purchased from an unauthorized dealer or an online E-tailer. To determine if your ELAN reseller is authorized, please contact ELAN Home Systems at (859) 269-7760.
www.elanhomesystems.com



HOME SYSTEMS

www.elanhomesystems.com

Lexington, KY

P/N 9900974 REV A

Free Manuals Download Website

<http://myh66.com>

<http://usermanuals.us>

<http://www.somanuals.com>

<http://www.4manuals.cc>

<http://www.manual-lib.com>

<http://www.404manual.com>

<http://www.luxmanual.com>

<http://aubethermostatmanual.com>

Golf course search by state

<http://golfingnear.com>

Email search by domain

<http://emailbydomain.com>

Auto manuals search

<http://auto.somanuals.com>

TV manuals search

<http://tv.somanuals.com>