

D01.10
D1128.11

D1197.24

G2020

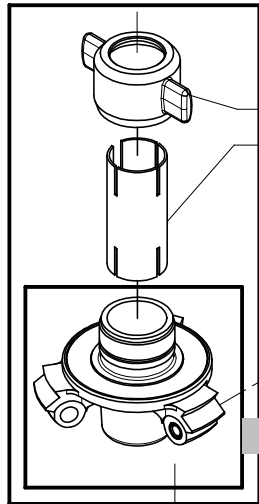

D1128.108

D1120.05

D106.19

D1128.16

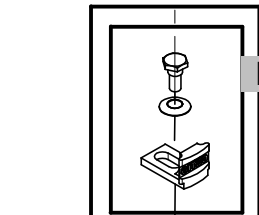

D1120.140

D1655

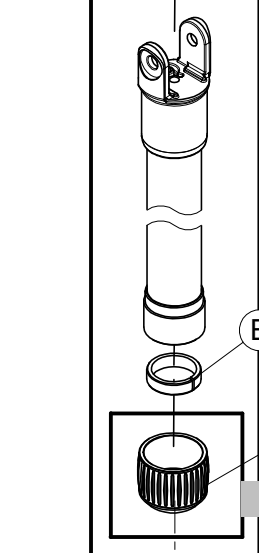

D1940.02

B

D1631

D04.24

D1940.04

D1197.C

D1651

D04.20

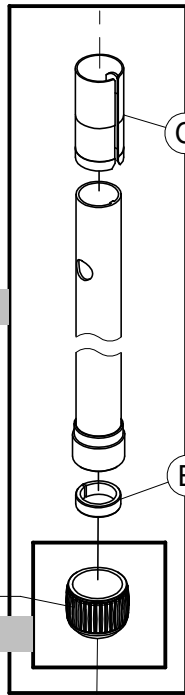

C

B

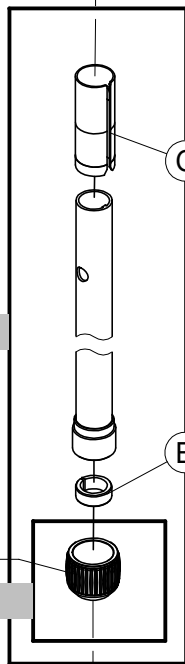

C

B

D1655

D04.16

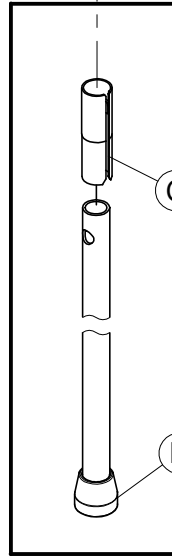

D1940.01

C

D

D

D1097.JP
complete tripod



C

D02.JG2
complete tripod

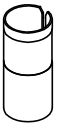

B

D03.JS
complete tripod



A

D1197.FJ
one leg

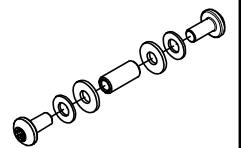

D06.13
quantity 2

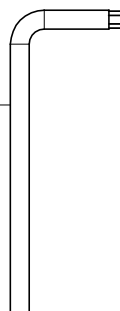

GT1940

D1940.JC

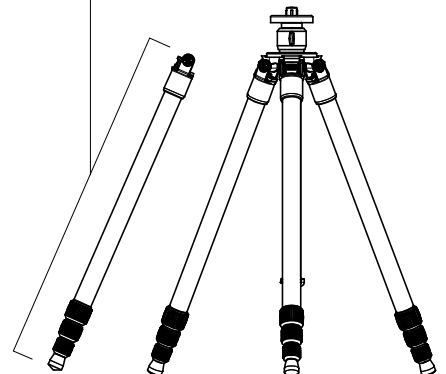

For serial numbers from G0077074

Free Manuals Download Website

<http://myh66.com>

<http://usermanuals.us>

<http://www.somanuals.com>

<http://www.4manuals.cc>

<http://www.manual-lib.com>

<http://www.404manual.com>

<http://www.luxmanual.com>

<http://aubethermostatmanual.com>

Golf course search by state

<http://golfingnear.com>

Email search by domain

<http://emailbydomain.com>

Auto manuals search

<http://auto.somanuals.com>

TV manuals search

<http://tv.somanuals.com>