



BR-6641

4WAN+1LAN Load Balancer Router



User Manual

Table of Contents

Chapter1 Quick Start	4
1.1 Preparation	4
1.2 Access to the Web-based UI	6
1.3 BR-6641 Web-based UI Overview.....	8
1.4 How to use BR-6641 Web-based UI.....	10
1.4.1 BR-6641 Operating Menu.....	10
1.4.2 BR-6641 Rule/Filter/Policy Table.....	11
Chapter 2 System.....	13
2.1 Summary.....	14
2.2 Traffic Statistics	16
2.3 Diagnostic Tools.....	17
2.4 Date&Time	20
2.4.1 Date&Time Setting.....	20
2.4.2 Busyhour Setting	21
2.5 Administration	22
Chapter3 Network.....	25
3.1 WAN Setting.....	26
3.1.1 Standard Mode	28
3.1.2 DHCP Mode.....	31
3.1.3 PPPoE Mode	33
3.1.4 PPTP Mode	35
3.1.5 Advanced Mode.....	37
3.2 LAN Setting.....	39
3.3 DHCP Setting.....	42
3.4 Host Names	45
3.5 Service Names.....	47
3.6 IP Grouping.....	49
3.7 Service Grouping	51
Chapter 4 Service.....	53
4.1 Firewall.....	54
4.2 Auto Routing	57
4.3 Virtual Server	60

4.4	QoS	62
4.5	Per IP Max Connection	66
4.6	Per IP Max Rate Control	68
4.7	Multihoming.....	70
4.8	Internal DNS	75
4.9	SNMP.....	77
4.10	UPnP.....	78
	Chapter 5 Log.....	79
5.1	View	80
5.2	Control	81
5.3	Notification	84



Copyright© by Edimax Technology Co, LTD. all rights reserved. No part of this publication may be reproduced, transmitted, transcribed, stored in a retrieval system, or translated into any language or computer language, in any form or by any means, electronic, mechanical, magnetic,optical, chemical, manual or otherwise, without the prior written permission of this company.

This company makes no representations or warranties, either expressed or implied, with respect to the contents hereof and specifically disclaims any warranties, merchantability or fitness for any particular purpose. Any software described in this manual is sold or licensed "as is". Should the programs prove defective following their purchase, the buyer (and not this company, its distributor, or its dealer) assumes the entire cost of all necessary servicing, repair, and any incidental or consequential damages resulting from any defect in the software. Further, this company reserves the right to revise this publication and to make changes from time to time in the contents hereof without obligation to notify any person of such revision or changes.

The product you have purchased and the setup screen may appear slightly different from those shown in this QIG. For more detailed information about this product, please refer to the User's Manual on the CD-ROM. The software and specifications subject to change without notice. Please visit our web site www.edimax.com for the update. All right reserved including all brand and product names mentioned in this manual are trademarks and/or registeredtrademarks of their respective holders.

Linux Open Source Code

Certain Edimax products include software code developed by third parties, including software code subject to the GNU General Public License ("GPL") or GNU Lesser General Public License ("LGPL"). Please see the **GNU** (www.gnu.org) and **L P G L** (www.gnu.org) Web sites to view the terms of each license.

The GPL Code and LGPL Code used in Edimax products are distributed without any warranty and are subject to the copyrights of their authors. For details, see the GPL Code and LGPL Code licenses. You can download the firmware-files at <http://www.edimax.com> under "Download" page.

Chapter1 Quick Start

At the first time using the product of BR-6641, you may be confronted with complicated settings which prevent you from starting well. This chapter will explain the basic functionalities of BR-6641 and how to operate and configure the system. It will also cover related subjects in network structures and hardware installation which will help you during your setup of BR-6641.

1.1 Preparation

Before you get started, there are a few things you need to know:

The position of the BR-6641 LAN Port: It has five network interfaces, the last port is LAN Port which is marked on the machine.

- The default IP address for LAN interface is 192.168.2.1
- Your IP addresses for computers in the LAN should be changed to 192.168.2.2 (or 192.168.2.x) in order to avoid conflicts with the default LAN port.
- Connect your computers in the LAN to the BR-6641 with a cross-over cable, which is a standard attachment.
- To access the web-based administration UI, open <http://192.168.2.1/> in your Internet Explorer 6.0.
- The default password for the administrator account is "1234", and "5678" for the monitor account. We strongly recommend you to modify the passwords at the first time you log into the web-based UI. It is also a wise idea to write down your changed passwords and keep them in a safe place in case you forget them.
- Check your network environment carefully before installing BR-6641. A well-designed network environment with the necessary information such as your network structure, IP addresses, and network segments information will

help you complete the setup of BR-6641 parameters.

- BR-6641 uses a web-based management user interface (Web-based UI). Due to internal design constraints, you have to use MS Internet Explorer 6.0 (IE 6.0), or higher to access the Web-based UI. A screen resolution of 800x600 or higher is recommended.
- Use a cross-over cable to access BR-6641 Web-based UI from the LAN port. BR-6641 is shipped with two types of network cable in the box; one is a cross-over and the other is a straight cable. Please use the cross-over cable to connect to the computer and LAN port of BR-6641, the LED of the plugged in port will turn on when properly connected.

1.2 Access to the Web-based UI

The Web-based UI enables you to easily perform every configuration task. Follow the steps below to access the Web-based UI.

1. Connect your PC Ethernet LAN interface to LAN port of BR-6641 with a cross-over cable. The default management LAN port of BR-6641 is LAN port.
2. After powering on BR-6641, the LED of LAN port will turn to orange. This indicates that it is on-line.
3. Assign your PC Ethernet LAN interface with IP 192.168.2.2, subnet mask 255.255.255.0.
4. Check that the proxy setting of your IE browser is turned off, no proxy server is required in order to access BR-6641's Web-based UI. Open MS IE 6.0, select **Internet Option** on the menu bar of **Tools**, click the **Connection** tab, and then click **LAN settings** to open **Local Area Network Settings** dialog box, under **Proxy server**, make sure proxy server is not selected.
5. In the URL of IE 6.0, type in <http://192.168.2.1> to access the Web-based UI.
6. BR-6641 provides two types of user accounts:
 - **Administrator** - Has privileges to monitor and modify system parameters.
 - **Monitor** - Has privileges to monitor only.

BR-6641 allows up to 1 administrator and 1 monitor to access concurrently.

Default password for Administrator and Monitor are 1234 and 5678, respectively. Please have your password change the first time you log in.

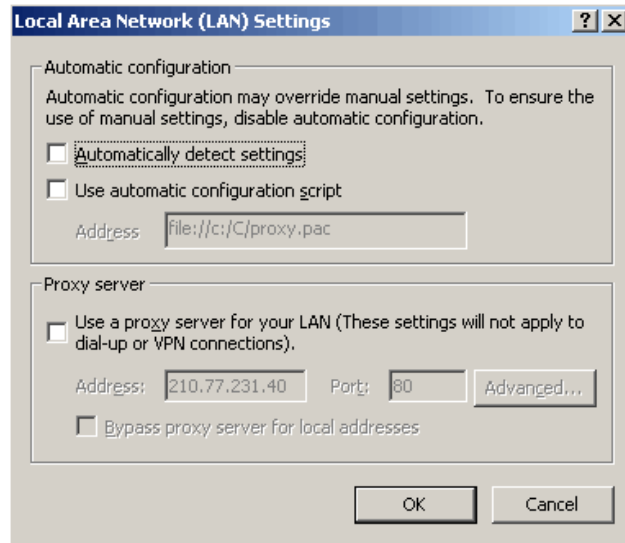

Cancel the Proxy Setting

1.3 BR-6641 Web-based UI Overview

After logging in, you will be able to start configuring or monitoring BR-6641 through the Web-based UI.

In order to help you to familiar with the basic operations, the explanations are as follows:

The Web-based UI tasks are grouped into four categories. The categories are located at the upper left-hand corner of Web-based UI task bar. These categories cover all the configuration possibilities in BR-6641. The four categories are:

- System
- Network
- Service
- Log

In the later chapters, we will introduce the functions of these four categories. On the first stage, you can login as Administrator in the Web-based UI and modify the Administrator or Monitor password by performing the following: (1) Click System and select Administration on task bar, (2) enter your new Administrator password or Monitor password, after the system confirmation, using the new password next time you log in.

What shall we do if we forget the new password?

If you forget your administrator password, use a Terminal (VT-100 compatible) to establish the connection between PC RS - 232 series port and BR-6641 Console interface, execute system reset to default.

Before you log into serial console, please complete following setting: Bits per

second: 9600, Data bits: 8, Parity: None, Stop bits: 8, Flow control: None. The serial console and Web-based UI use the same username and password pairs. By default, the password of "Administrator" is 1234, and the password of "Monitor" is 5678. If the password is changed via the Web-based UI, it will also be changed in the serial console. In case you lose your password, you can use the username "reset" and password "BR-6641_edimax" to log into serial console and reset the system to default.

Open the IE browser to access the Web-based UI

Note: Please remember the changed password , otherwise it is not possible to access the BR-6641 management interface.

1.4 How to use BR-6641 Web-based UI

This section describes the operations and arrangement of Web Based UI, figure 1-2 displays the operating menu of BR-6641 Web-based UI system.



BR-6641 Web Based UI Operating Menu Items

1.4.1 BR-6641 Operating Menu

The task bar of operating menu contains five categories, which are **System, Service, Network, Log**, each category has these own menu, “**System / Summary**” in figure 1-2 indicates the current working menu, while “**Administrator 192.168.2.1**” indicates login account is Administrator at system name of 192.168.2.1.

Select the “**Logout**” from up right corner to exit the system.

Apply, Reload, Help/Hide Help buttons are always displayed on the operating menu, the functions are as described below:

Button	Function
	After modifying the parameters of specific menu page, click this button to save your changes to memory, the old settings will also be saved.

Reload	Click this button to recover the old settings which apply has saved.
Help Hide Help	Click the Help button to display the on-line help of the current page, the on-line help information will automatically swap when you change the function page or language. Click Hide Help to hide the on-line help information.

Table 5.0 Buttons

Note: The Apply and Reload buttons here are active only on certain pages, any parameters modified without click Apply will not be saved to the memory. Remember to click Apply when you are ready to move to the next page menu or logout.

1.4.2 BR-6641 Rule/Filter/Policy Table

Orders of Rules/Filters/Policies

BR-6641 provides a rule table for you to perform the tasks like system parameter or service policies. Often you are required to add or delete rules of your own. In general, when you have multiple rules in a table, BR-6641 matches these rules from top to bottom. That is, the rules at the top of the table are given a higher precedence. Thus, to achieve the outcome of your desire, the more specific rules should be placed on top of the less specific rules.

You will see in this table a few icons and their meanings:

+	Add a new rule below the current rule.
↓	Move the current rule one row down.
↑	Move the current rule one row up.
-	Delete the current rule.

	Write a note for the current rule.
---	------------------------------------

Table 5.1 Operating Rules

When you add a new rule, the newly added rule will be placed right below the current rule. Moving the rule up or down will swap positions between the upper and lower rules.

Checkbox

It is quite common that you see the following checkboxes in some tables. These checkboxes indicate whether certain functions are enabled or not. A red check sign inside a checkbox stands for “enabled”, and an empty checkbox means “disabled”. For example, you can enable logging for a rule by checking its checkbox in the rule table.

<input type="checkbox"/>	The function is disabled.
<input checked="" type="checkbox"/>	The function is enabled.

Table 5.2 Check Box

So far, we have only mentioned the basic operations of the Web-based UI. In the next section, we will talk more on how to integrate BR-6641 into your present network environment.

Chapter 2 System

In this chapter, you will learn how to configure system settings. System settings are the fundamental configurations of the BR-6641 system. They have to be specific in order for the system to work properly. Examples are provided here to help you to fulfill the configuration.

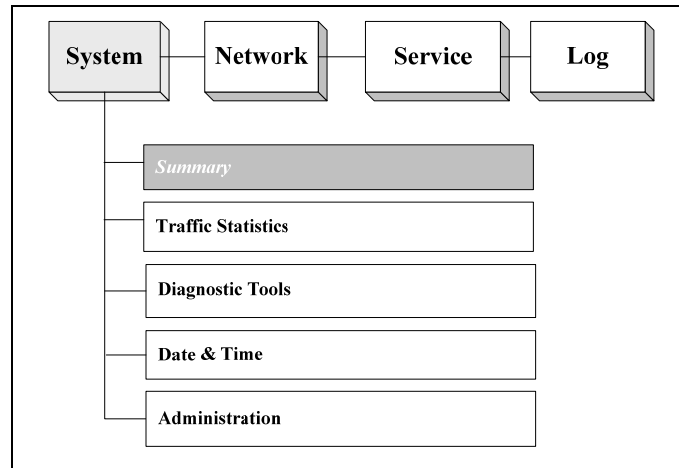

Figure 3.1 The Location of "System/Summary" on the Menu Bar

2.1 Summary

[Summary] is in the submenu of [System], which helps the Administrator to know the system information. While logging in the Web UI, System/Summary is the first page you see when you log into BR-6641's web-based UI.

[Summary] provide the following information:

System Information

Category	Field	Description
System Information	Version	The Firmware Version.
	Serial Number	The Serial number.
	Up Time	Time since the last reboot.
	Connections	Number of total connections.
	CPU Usage %	CPU usage in percentage.
	Packets/Second	Number of packets served per second.

Table 3.1 System Information

Note: Connections may jump up to over 100 when BR-6641 is starting up. This is due to many ICMP packets sent out by BR-6641 to test the network. It will drop back to normal there after.

WAN Link State

The section on WAN Link State shows the current status of each and every WAN link. Each WAN link is represented as a color-coded block with the following color coding scheme to indicate its status. The allowed number of WAN Link is also shown here.

- Green: Active WAN link.
- Red: Broken WAN link.
- Black: WAN link not in use.

2.2 Traffic Statistics

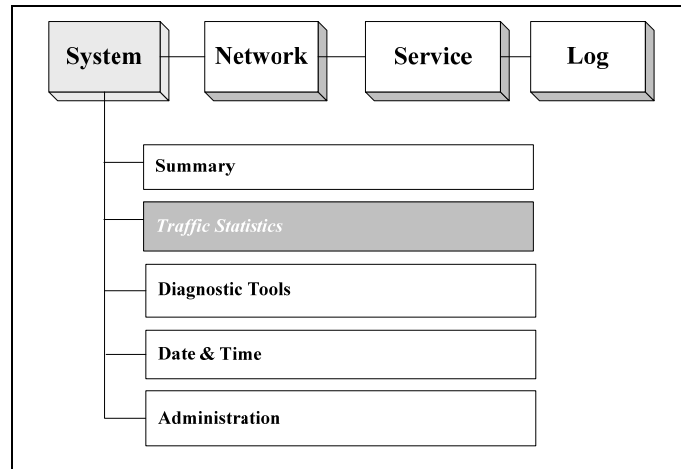

Figure 3.2 The Location of "System/Traffic Statistics" on the Menu Bar

In the traffic statistics page, you can inspect real-time traffic information sorted by traffic class over each WAN link. The statistics of traffic classes in the table is adjusted accordingly by your selection of traffic type - either inbound or outbound traffic.

Field	Value	Descriptions
Traffic Type	Inbound Outbound	The direction of traffic flow – either inbound traffic or outbound traffic.
Traffic Class		The names of the traffic classes defined on the QoS page. The rest of unclassified information is labelled as "Default Class".
WAN Link	1, 2...	The total number of WAN links you want to inspect.

Table 3.2 The Description of the fields on the Statistics/Traffic Page

2.3 Diagnostic Tools

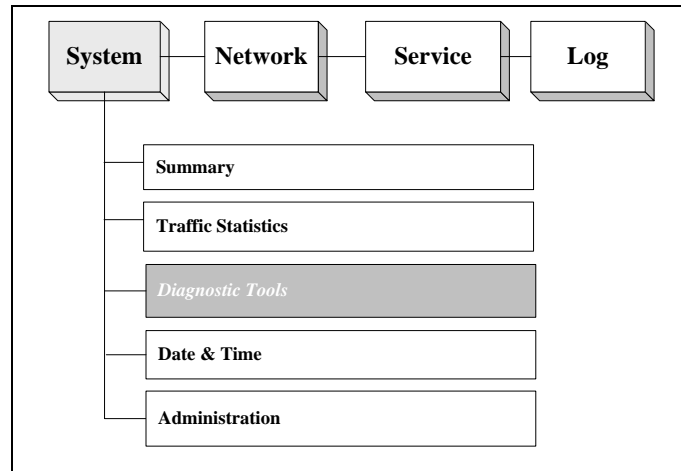

Figure 3.3 The Location of "System/Diagnostic Tools" on the Menu Bar

ARP Enforcement: ARP Enforcement updates ARP tables of servers and network devices around BR-6641.

When the Enforce button is pushed, BR-6641 sends out ARP packets to the surrounding servers or network devices to update their ARP tables. This is necessary only if certain equipments in DMZ cannot connect to the Internet properly after initial setup.

IP Conflict Test: IP Conflict Test helps you to detect if the location of any machines on the network conflicts with the DMZ/WAN settings of Network Setting category on BR-6641.

Push Test button to begin the test. The result of the test is one of the following:

- Everything is ok.
- BR-6641 discovers that a machine in DMZ conflicts with Network Setting on BR-6641. For example, a public IP address should be in WAN but is used by a machine in DMZ. An error message with the conflicting IP address and MAC address of the machine will be displayed.
- BR-6641 discovers that a machine in WAN conflicts with Network Setting on BR-6641. For example, a public IP address should be in DMZ but is used by a machine in WAN. An error message with the conflicting IP address and MAC address of the machine will be displayed.

Ping: Ping is used to detect network condition by sending ICMP packets to a target device.

You may specify a target device in the Target IP field. It accepts either an IP address or a host name. Select a network interface, WAN or LAN. If it is WAN, select WAN link number in Index field. As to the error message about ICMP, please refer to the concerned document.

Note: If a domain name is used to ping, a DNS server has to be specified in [Network]→[Host Names].

Trace Route: Trace route is used to detect network condition by showing the routing path from BR-6641 to the target device.

You may specify a target device in the Target IP field. It accepts either an IP address or a host name. Select a network interface, WAN or LAN. If it is WAN, select WAN link number in Index field. For ICMP related error messages, please

refer other materials.

You may specify a target device in the Target IP field. It accepts either an IP address or a host name.

You may specify a target device in the Target IP field. It accepts either an IP address or FQDN. Select a network interface, WAN or LAN. If it is WAN, select WAN link number in Index field.

Note: If a domain name is used to traceroute, a DNS server has to be specified in [Network] →[Host Names].

Arping: Arping is used to detect the MAC address of a computer.

You may specify a target device in the Target IP field. It accepts either an IP address or a host name. Select a network interface (WAN, LAN). If it is WAN, select WAN link number in Index field. For ARP related error messages, please refer other materials.

Note: If a host name is used in Target IP field, then a DNS server has to be specified in [Network]→[Host Names].

2.4 Date&Time

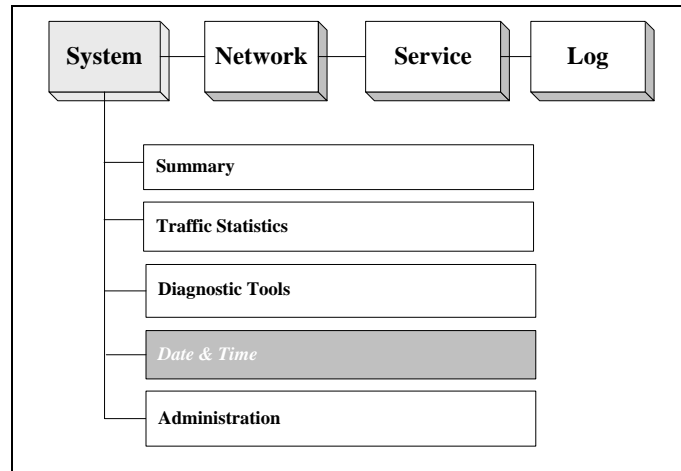

Figure 3.4 The Location of "System/Date/Time" on the Menu Bar

2.4.1 Date&Time Setting

In this page, you can set up time related configurations.

For time zone information, You should pick the region first and then the city you are located in (or a city of the same time zone as you). For example, if you are located in Hawaii, select "US" in the left list and then choose "Hawaii" in the right list.

BR-6641 can use the NTP protocol to get time from the Internet. You can select a time server from the list or add your preferred time server to the list. With NTP, BR-6641 automatically adjusts its time when necessary. On the other hand, you can push the Synchronize Time button to adjust time immediately.

2.4.2 Busyhour Setting

Busyhour Setting is very important from a MIS manager's point of view. It provides a tool for you to define two time segments: busy-hour and idle-hour. All other rule-based services such as bandwidth management and auto-routing can take advantage of this function. For example, you can define 9:00 am to 5:00 pm, Monday through Friday to be busy-hour. Then you can reserve bandwidth to business-related network traffic during busy-hour and relax the rule on idle-hour.

Field	Value	Description
Default Type	Idle Busy	Define default type to be either Idle or Busy hour.
Rule	-	You set the time segment rules in this table. They are matched in sequence on a first-match basis. If none of the rules match, the default type is used.
Weekday	Sunday Monday Tuesday Wednesday Thursday Friday Saturday Any Day	Day of the week.
From	<Hour/Minute>	The start time.
To	<Hour/Minute>	The end time.
Type	Busy Idle	If the current time matches the day of the week and in between From and To time, then Type field applies.

Table 3.3 Busyhour Setting

2.5 Administration

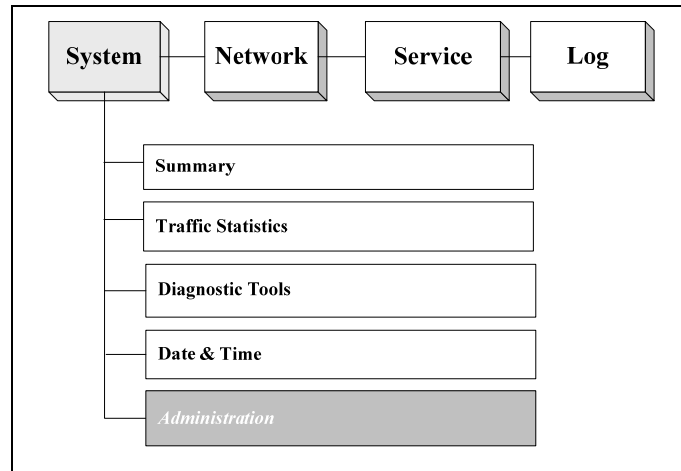

Figure 3.5 The Location of "System/Administration" on the Menu Bar

In this page, you can do a few administrative tasks. First, you can change the password of Administrator and Monitor accounts. Every BR-6641 comes with the same passwords initially. To avoid any security risks, it is absolutely necessary to change passwords before putting your BR-6641 on-line.

From time to time you might receive BR-6641 firmware updates from AscenVision or your system integrator. Just push the Update button and follow the instructions on the screen to update.

You can save your current configurations to a file and restore it later. We recommend that you save your working configuration before modifying the configuration. In case of configuration error (such as rules that block you from accessing BR-6641 anymore), you can always reset the machine to factory default state using the console command and quickly restore to your original configuration.

You can reset BR-6641 to its factory default state. In doing this, you will lose your entire customized configuration.

Finally, you can reboot BR-6641. Due to web interface limitations. There will not be any messages after you have rebooted the system. Wait two minutes or so and try to re-connect to BR-6641 using the browser.

Administrator Password:

Here, you can add, delete, or modify administrator's account and password.

Field	Value	Description
New Password		Enter the new password here.
Confirm		Enter the new password here again.
Set Password		Click the button to enable the new password.

Monitor Password:

Here, you can add, delete, or modify Monitor's account and password.

Field	Value	Description
Password		Enter the new password here.
Confirm		Enter the new password here again.
Set Password		Click the button to enable the new password.

Firmware Update:

Push the Update button and follow the following instruction to start the firmware update process.

Obtain the latest firmware pack from your SI or VAR

Log on to Web UI as the Administrator and go to function [System]→ [Administration].

Use [Browse...] to select the path to the new firmware image, then select [Upload].

The firmware update will take a while so be patient. During the update process BE SURE not to turn off the system or pull the power plug. You should also NOT click on [Upload] button.

Note: Update will succeed when the “Update succeeded” message appears. At this time please power off and then on again the system to restart BR-6641 with the new firmware.

Configuration File:

Push Save button to save current configuration into a file. Push Restore button to restore the configuration back from a saved configuration file. See Appendix 2 for more information.

Log into BR-6641 as Administrator. In the Web UI, go to [System]→ [Administration] and select [Configuration File] → [Save] to backup the Config File to your local machine/notebook.

To restore to the previously saved config file, go to [Configuration File] → [Restore], select [Browse...] to pick the saved config file and select [Upload]. Notice: DO NOT to turn off the power during the config file upload process, or repetitively select the [Upload] button.

Restart BR-6641 to effect the configuration.

Maintenance:

Push Factory Default button to reset BR-6641 configuration to its factory default. You can do the same operation using resetconfig command in console. Push reboot button to reboot BR-6641.

Chapter3 Network

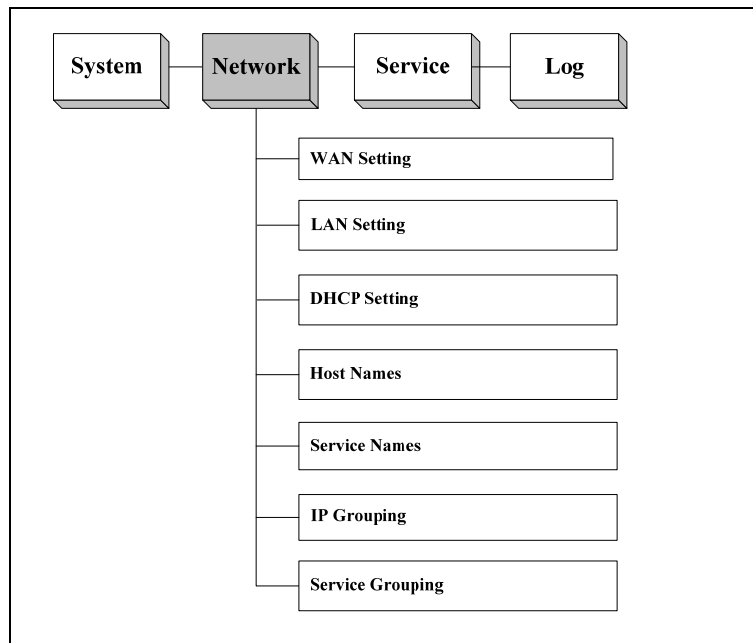

Figure 3.1 The Location of “Network” on the Menu Bar

3.1 WAN Setting

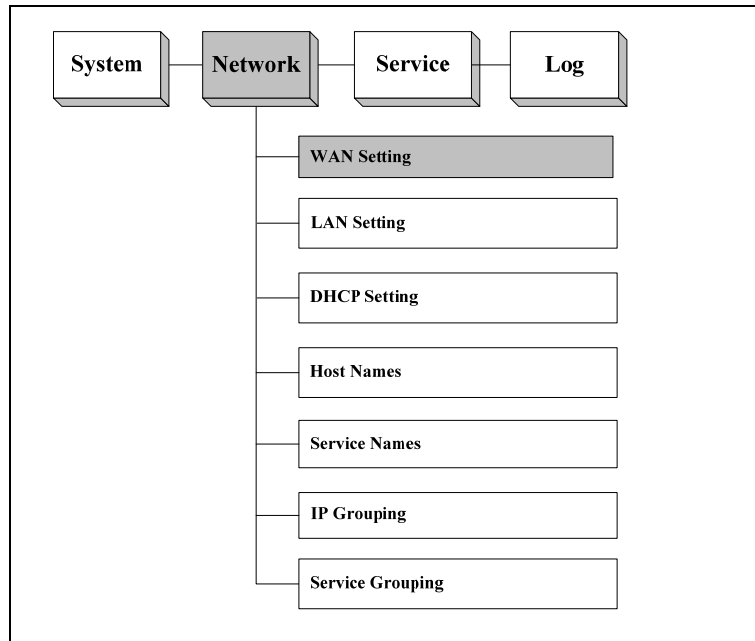

Figure 3.2 System / Network Setting

[WAN Setting] is quite important part for BR-6641. The relevant parameter is defined here.

The configuration is done one WAN link at a time. However, you can apply all the changes at once at the end. You can select a WAN link by selecting the link number in a WAN Link drop-down box. For each WAN link, you will fill out a few tables with correct information from its ISP.

The first thing you have to decide is the WAN type. The rest of the settings will change based on the WAN type you have selected. BR-6641 supports the following WAN types:

After connecting the WAN Link to the machine, WAN No. need to be defined in [Basic Setting]. WAN is to be different for different type of WAN. BR-6641 provide the following choices:

- Standard
- DHCP
- PPPoE
- PPTP
- Advanced

Basic Setting	
Enable	<input checked="" type="checkbox"/>
Mode	Standard
Downstream Bandwidth	Standard
Upstream Bandwidth	DHCP
	PPPOE
	PPTP
	Advanced

Figure 3.3 WAN Setting / Basic Setting

3.1.1 Standard Mode

■ Basic Setting:

Basic Setting			
Enable	<input checked="" type="checkbox"/>		
Mode	Standard		
Downstream Bandwidth	20480	Kbps	
Upstream Bandwidth	20480	Kbps	
Speed/Duplex	Auto		
Port Status	Broken		
MAC Address	00:11:a3:03:84:a6		
Wan Link Health Detection	Always		
	Host		
	<input type="button" value="+"/> <input type="button" value="-"/> <input type="button" value="↑"/> <input type="button" value="↓"/>	Protocol	Destination IP
	<input type="button" value="+"/> <input type="button" value="-"/> <input type="button" value="↑"/> <input type="button" value="↓"/>	ICMP	
<input type="button" value="+"/> <input type="button" value="-"/> <input type="button" value="↑"/> <input type="button" value="↓"/>	TCP		Port/Number of Hops
			Hops
			Port
Address	<input type="button" value="+"/> <input type="button" value="-"/> <input type="button" value="↑"/> <input type="button" value="↓"/>	IP Range	
	<input type="button" value="+"/> <input type="button" value="-"/> <input type="button" value="↑"/> <input type="button" value="↓"/>	192.168.1.1	
Gateway	192.168.1.254		
Subnet Mask	255.255.255.0		
IP(s) in DMZ	<input type="button" value="+"/> <input type="button" value="-"/> <input type="button" value="↑"/> <input type="button" value="↓"/>	IP Range	
	<input type="button" value="+"/> <input type="button" value="-"/> <input type="button" value="↑"/> <input type="button" value="↓"/>		

Figure 3.4 Standard Mode / Basic Setting

When you select Standard Mode as the WAN Type, you need to fill the parameters as in the Basic Setting table.

Basic Setting:

Field	Value	Description
Down Stream		The down stream (inbound) bandwidth of the WAN link, for example 25600 (Kbps).
Up Stream		The up stream (outbound) bandwidth of the WAN link, for example 25600 (Kbps).
Port Speed	Auto 10Mbps/Half duplex 10Mbps/Full duplex 100Mbps/Half duplex 100Mbps/Full duplex	The speed and duplex of WAN Port. You can set it manually or system can get it automatically.
Health Detection	Never Always Only when no packet is received	This function is used to configure the WAN link health detection mechanism for the specific WAN link.
Address	IP Address IP Range	Input the IP Address of BR-6641 in WAN. It can be: IP Address IP Range
Gateway		Input the predefined Gateway, e.g.: 211.21.40.254.
Subnet Mask		Input the Subnet Mask.
IP(s) in DMZ	IP Address IP Range	Input the IP Address of BR-6641 in DMZ. It can be: IP Address IP Range

Table 3.1 Standard Mode / Basic Setting

WAN Link Health Detection:

This function allows MIS to configure how WAN link health detection is performed. By fine-tuning certain parameters, an MIS can adjust BR-6641 to match a particular network structure and/or a particular ISP.

For WAN link health detection, BR-6641 sends out ICMP or TCP packets and monitors responses to determine the statuses of those links. In the WAN Link

Health Detection page, the following parameters are available:

The screenshot shows the 'Wan Link Health Detection' configuration interface. At the top, there is a dropdown menu currently set to 'Always'. Below this is a section titled 'Host' which contains a table with four columns: a control column with '+' and '-' icons, a 'Protocol' column with a dropdown menu, a 'Destination IP' column with an input field, and a 'Port/Number of Hops' column with an input field. The table contains seven rows, alternating between ICMP and TCP protocols. The first row is ICMP with 'Hops' in the final column, and the second row is TCP with 'Port' in the final column.

Figure 3.5 WAN Link Health Detection

Field	Description
Never	BR-6641 assumes a healthy WAN and stop monitoring ICMP and TCP packets.
Always	BR-6641 will always do the health detection according to the rules.
Only when no packet is received	If BR-6641 detects no inbound WAN traffic, it will start the health detection.
Protocol	Choose either ICMP or TCP as methods for WAN health detection.
Destination	Input the destination IP Address.
Port/Number of Hops	Set the Hops if ICMP is selected. Set the Port number if TCP is selected.

Table 3.2 The description of the field in WAN Link Health Detection

3.1.2 DHCP Mode

This model is enabled when BR-6641 is a client using DHCP to acquire a dynamic IP address from an ISP's DHCP server.

Basic Setting											
Enable	<input checked="" type="checkbox"/>										
Mode	DHCP										
Downstream Bandwidth	20480 Kbps										
Upstream Bandwidth	20480 Kbps										
Speed/Duplex	Auto										
Port Status	Broken										
MAC Address	00:11:a3:03:84:a6										
Wan Link Health Detection	Always										
	Host										
	<input type="checkbox"/>	<table border="1"> <thead> <tr> <th>Protocol</th> <th>Destination IP</th> <th>Port/Number of Hops</th> </tr> </thead> <tbody> <tr> <td>TCP</td> <td></td> <td>Port</td> </tr> <tr> <td>ICMP</td> <td></td> <td>Hops</td> </tr> </tbody> </table>	Protocol	Destination IP	Port/Number of Hops	TCP		Port	ICMP		Hops
	Protocol	Destination IP	Port/Number of Hops								
TCP		Port									
ICMP		Hops									
<input type="checkbox"/>											
Clone MAC	<input checked="" type="checkbox"/>										
MAC											

Figure 3.6 DHCP Mode / Basic Setting

Field	Value	Description
Down Stream		The down stream (inbound) bandwidth of the WAN link, for example 25600 (Kbps).
Up Stream		The up stream (outbound) bandwidth of the WAN link, for example 25600 (Kbps).
Port Speed	Auto 10Mbps/Half duplex 10Mbps/Full duplex 100Mbps/Half duplex	The speed and duplex of WAN Port. You can set it manually or system can got it automatically.

	100Mbps/Full duplex	
Health Detection	Never Always Only when no packet is received	This function is used to configure the WAN link health detection mechanism for the specific WAN link. Please refer to Chapter 3.2.1 WAN Link Health Detection.
Clone MAC		Normally DHCP will assign IP dynamically. Static IP, however, can be assigned to the WAN link via the DHCP server with MAC address binding. You can enable the 'Mac Cloning' option to force the DHCP server to assign the static IP according to the BR-6641's MAC address.
MAC	xx-xx-xx-xx-xx-xx	Input the Clone MAC Address.

Table 3.3 DHCP Mode

3.1.3 PPPoE Mode

PPPoE is a very popular bridging mode protocol for ADSL. You need to specify the ADSL account information to obtain IPs from the ISP PPPoE server.

Basic Setting				
Enable	<input checked="" type="checkbox"/>			
Mode	PPPOE			
Downstream Bandwidth	20480 Kbps			
Upstream Bandwidth	20480 Kbps			
Speed/Duplex	Auto			
Port Status	Broken			
MAC Address	00:11:a3:03:84:a6			
Wan Link Health Detection	Always			
	Host			
	<input type="checkbox"/>	Protocol	Destination IP	Port/Number of Hops
	<input type="checkbox"/> <input type="checkbox"/> <input type="checkbox"/> <input type="checkbox"/>	TCP		Port
<input type="checkbox"/> <input type="checkbox"/> <input type="checkbox"/> <input type="checkbox"/>	ICMP		Hops	
User Name				
Password				
Automatically Obtain IP Address	<input type="checkbox"/>			
Address				

Figure 3.7 PPPoE Mode / Basic Setting

Field	Value	Description
Down Stream		The down stream (inbound) bandwidth of the WAN link, for example 25600 (Kbps).
Up Stream		The up stream (outbound) bandwidth of the WAN link, for example 25600 (Kbps).
Port Speed	Auto	The speed and duplex of WAN Port. You can

	10Mbps/Half duplex 10Mbps/Full duplex 100Mbps/Half duplex 100Mbps/Full duplex	set it manually or system can get it automatically.
Health Detection	Never Always Only when no packet is received	This function is used to configure the WAN link health detection mechanism for the specific WAN link. Please refer to Chapter 3.2.1 WAN Link Health Detection.
User		Input the user's account assigned by ISP.
Password		Enter the password of the account.
Automatically Obtain IP Address		Enable this function, and ISP will provide IP Address, Gateway and Netmask. Note: If your ADSL is dynamic IP, check the checkbox. If it is static IP, please do not.
Address	x.x.x.x	Input the IP Address assigned by ISP.

Table 3.4 PPPoE Mode

3.1.4 PPTP Mode

This model is enabled when BR-6641 is access to PPTP server via Internet.

Basic Setting			
Enable	<input checked="" type="checkbox"/>		
Mode	PPTP		
Downstream Bandwidth	20480	Kbps	
Upstream Bandwidth	20480	Kbps	
Speed/Duplex	Auto		
Port Status	Broken		
MAC Address	00:11:a3:03:84:a6		
Wan Link Health Detection	Only When No Packet Is Received		
	Host		
	+	Protocol	Destination IP
	+ - ↑ ↓	TCP	Port
	+ - ↑ ↓	ICMP	Hops
User Name			
Password			
Connection ID			
Server IP			
My IP			
My Subnet mask			

Figure 3.8 PPTP Mode / Basic Setting

Field	Value	Description
Down Stream		The down stream (inbound) bandwidth of the WAN link, for example 25600 (Kbps).
Up Stream		The up stream (outbound) bandwidth of the WAN link, for example 25600 (Kbps).

Port Speed	Auto 10Mbps/Half duplex 10Mbps/Full duplex 100Mbps/Half duplex 100Mbps/Full duplex	The speed and duplex of WAN Port. You can set it manually or system can get it automatically.
Health Detection	Never Always Only when no packet is received	This function is used to configure the WAN link health detection mechanism for the specific WAN link. Please refer to Chapter 3.2.1 WAN Link Health Detection.
User		Input the user name for login VPN.
Password		Input the password for login VPN.
Connection ID		Input the ID for Connection through VPN.
Server IP	x.x.x.x	Input the PPTP Sever IP Address for VPN dialing.
My IP	x.x.x.x	Input the IP Address of the local machine.
My subnet mask		Input the Subnet Mask of the local machine.

Table 3.5 PPTP Mode

3.1.5 Advanced Mode

Advanced mode is used where BR-6641 is connected with a router via its private IP and its actual public IP deployed in DMZ.

WAN No.	WAN 1		
Basic Setting			
Enable	<input checked="" type="checkbox"/>		
Mode	Advanced		
Downstream Bandwidth	20480	Kbps	
Upstream Bandwidth	20480	Kbps	
Speed/Duplex	Auto		
Port Status	Broken		
MAC Address	00:11:a3:03:84:a6		
Wan Link Health Detection	Only When No Packet Is Received		
	Host		
	<input type="checkbox"/>	Protocol	Destination IP
	<input type="checkbox"/> <input type="checkbox"/> <input type="checkbox"/> <input type="checkbox"/>	TCP	
<input type="checkbox"/> <input type="checkbox"/> <input type="checkbox"/> <input type="checkbox"/>	ICMP		
Subnet in WAN			
Address	<input type="checkbox"/>	IP Range	
	<input type="checkbox"/> <input type="checkbox"/> <input type="checkbox"/> <input type="checkbox"/>		
Gateway			
Subnet Mask			
Public-IP Subnet in DMZ			
<input type="checkbox"/>	Subnet		
<input type="checkbox"/> <input type="checkbox"/> <input type="checkbox"/> <input type="checkbox"/>	IP		
	Subnet Mask		

Figure 3.9 Advanced Model / Basic Setting

Field	Value	Description
Down Stream		The down stream (inbound) bandwidth of the WAN link, for example 25600 (Kbps).
Up Stream		The up stream (outbound) bandwidth of the WAN link, for example 25600 (Kbps).
Port Speed	Auto 10Mbps/Half duplex 10Mbps/Full duplex 100Mbps/Half duplex 100Mbps/Full duplex	The speed and duplex of WAN Port. You can set it manually or system can get it automatically.
Health Detection	Never Always Only when no packet is received	This function is used to configure the WAN link health detection mechanism for the specific WAN link. Please refer to Chapter 3.2.1 WAN Link Health Detection.
Subnet in WAN		
Address	IP Address IP Range	Input the private IP address of BR-6641 connected with the router. There are two options available: IP Address IP Range
Gateway		Input the predefined Gateway, e.g.: 192.168.99.1.
Subnet Mask		Input the Subnet Mask.
Public-IP Subnet in DMZ		
IP		Input the public IP of BR-6641 in DMZ
Subnet Mask		Input the Subnet Mask.

Table 3.6 The description of the fields in Advanced Mode

3.2 LAN Setting

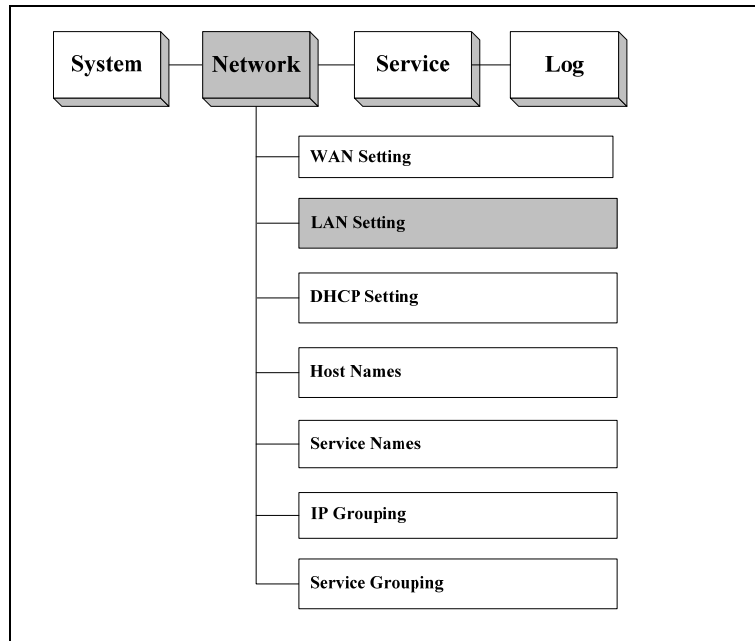

Figure 3.10 Network/LAN Setting

Basic Subnet

The table of Basic Subnet allows you to specify one or more private subnets that connect to BR-6641 directly.

Basic Subnet	
Address	192.168.0.1
Netmask	255.255.255.0
Port Setting	Auto <input type="button" value="v"/>

Figure 3.11 LAN Setting / Basic Subnet

Input the IP Address of LAN Port in [Basic Subnet] - [IP Address] and input the corresponding subnet mask in [Netmask]. Select the corresponding Speed/Duplex in [Port-Speed].

RIP Configuration

BR-6641 support RIP (Routing Information Protocols) for both version 1 and 2. RIP v1 is the basic definition while v2 has some functional enhancements. Please refer to IETF's official documents for the complete definition of RIP. If your private LAN subnet supports RIP, you need to also enable BR-6641's RIP function, by doing as follows:



RIP	<input checked="" type="checkbox"/>		
RIP v1	<input type="checkbox"/>	RIP v2	<input checked="" type="checkbox"/>
Password	<input type="text"/>		

Figure 3.12 LAN Private Subnet / RIP Configuration

If the router in LAN enable RIP v1, check the checkbox in front of RIP v1. If the router in LAN enable RIP v2, check the checkbox in front of RIP v2.

BR-6641 supports the transmission of RIP packets. If the authentication is enabled on RIP v2, password must be entered in [Authentication Password] field. If there is no predefined password, just leave the field blank.

Static Routing Subnet

If there is static routing subnet in LAN, you need to use Static Routing Subnet to fulfil the configuration. Static Routing Subnet means that a router route out a subnet from LAN, which is not connected to the BR-6641 directly.

Note: DMZ is virtual area, which is in the port with LAN. DMZ support the public IP Address. The public IP support only one IP range, which do not support multi-IP range Routing.

Example:

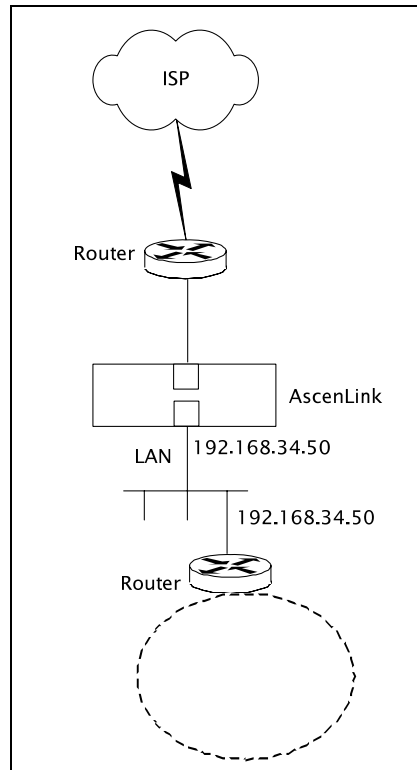

Figure 3.13 LAN Private Subnet / Static Routing Subnet

Static Routing Subnet			
+	Subnet	Subnet Mask	Gateway
+ - ↑ ↓			

Figure 3.14 LAN Private Subnet / Static Routing Subnet Setting

3.3 DHCP Setting

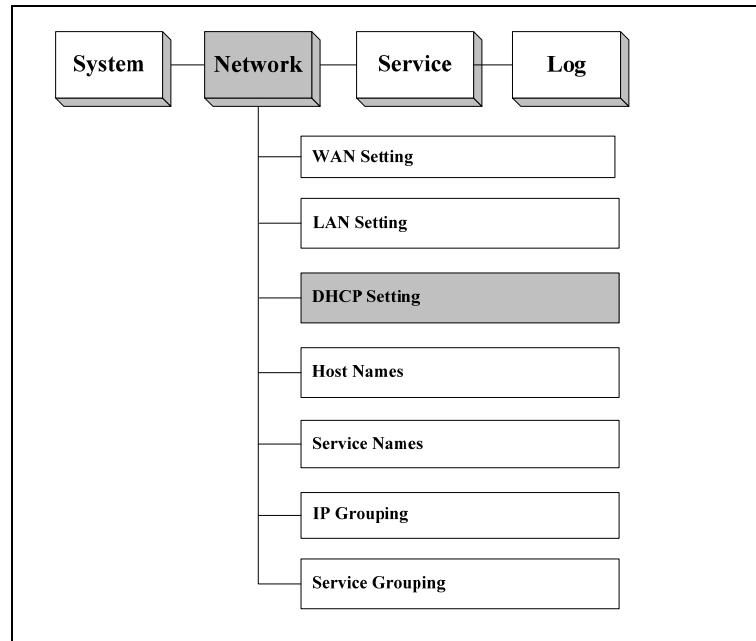

Figure 3.15 Network / DHCP Setting

Click on “Enable DHCP” to enable this function. BR-6641 is a client using DHCP to acquire a dynamic IP address from an ISP’s DHCP server. The following is an example of how you set it up.

DHCP Setting		
Lease Time	36000	sec.
Default Gateway	192.168.0.1	
Subnet Mask	255.255.255.0	
Domain Name		
+		
DNS Server		
+ - ↑ ↓		
+		
	Dynamic Range Start	Dynamic Range End
+ - ↑ ↓		
+ - ↑ ↓		
IP-MAC MAPPING		
+		
	IP Address	MAC Address
+ - ↑ ↓		

Figure 3.16 DHCP Setting

Field	Description
Lease Time	Input the Lease Time by hour.
Default Gateway	Input the Default Gateway. The Client will take this address as Gateway when DHCP is enabled. Note: This address should be in the subnet with LAN's
Subnet Netmask	Input the IP Address of DNS. The Client will take this address as DNS Server when DHCP is enabled.
Domain Name	Input the Domain Name of DHCP.
DNS	Input the IP Address of DNS.
Range Start -Range End	Input the dynamic Range Start and Range End assigned for LAN host, e.g. 192.168.10.53 -199.168.10.100.
IP -MAC Address	If the host in LAN require a stable IP Address, input IP Address and IP-MAC Address.

Table 3.7 DHCP Setting

3.4 Host Names

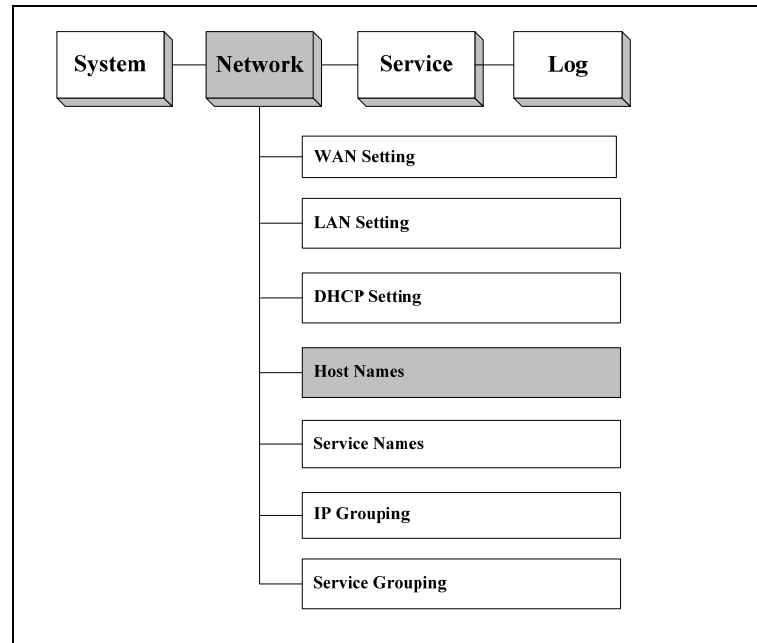

Figure 3.17 Network / DHCP Setting

This function is to define the the name for system, specific IP and IP group. These defined names will appear in sub-menu of source and destination in Firewall, Multihoming, etc.

System Name:

Field	Description
Name	Input the host name of the BR-6641.
Domain	Input the domain of the BR-6641.
DNS	Input the IP Address of DNS, BR-6641 will use it to resolve machine names to obtain IP addresses

Table 3.8 System Name

Named IP Addresses:

Field	Description
Name	Input the name which is to be substitute for the IP address.
Address	Specify the IP Address. It can be: IP Address IP Range

Table 3.9 System Name

3.5 Service Names

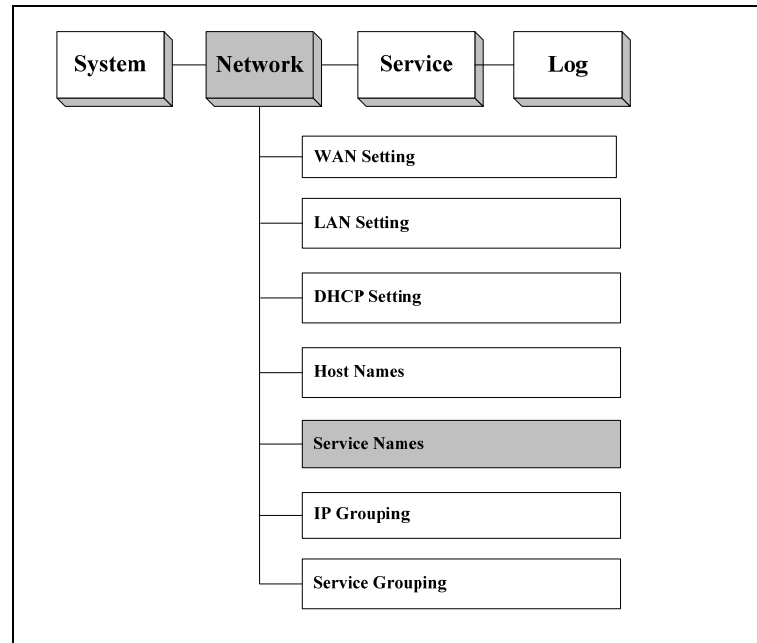

Figure 3.18 Network / Service Names

This function is to configure the name, protocol and other parameters of service. (BR-6641 has a default list of commonly used services.) These defined names will appear in sub-menu of service in Firewall, Multihoming, etc..

Service List:

Field	Value	Description
Name	-	Input the name of the service, e.g. PING,FTP...
Protocol	Protocol Number ICMP TCP UDP	Select protocol for service: Protocol Number, e.g. ICMP Protocol Number is "1", TCP is "6". For more information, please refer to concern document.

		ICMP: The service used ICMP, e.g. Ping. TCP: The service used TCP, e.g. FTP. UDP: The service used UDP.
Parameter	Number Type From...To	Specify the parameter for different Protocols. Number: Input Protocol Number. Type: Input the service type of ICMP. From..To: Input the Port Number of TCP/UDP. Single Port Number: A range of Port Number: Input the start port number in [From] and the end port number in [To].

Table 3.10 Service Name

3.6 IP Grouping

BR-6641 offers a variety of services. These services will be discussed in the next chapter. In order to help IT manager configure services efficiently, BR-6641 provides a few management tools. IP Grouping is one of them. This function allows you to assign a name to a group of IP addresses. Later on when you are asked to specify one or more IP addresses, you can use the name of an IP group instead. The name of this IP group will automatically show up in the IP address selection list if the IP group is enabled.

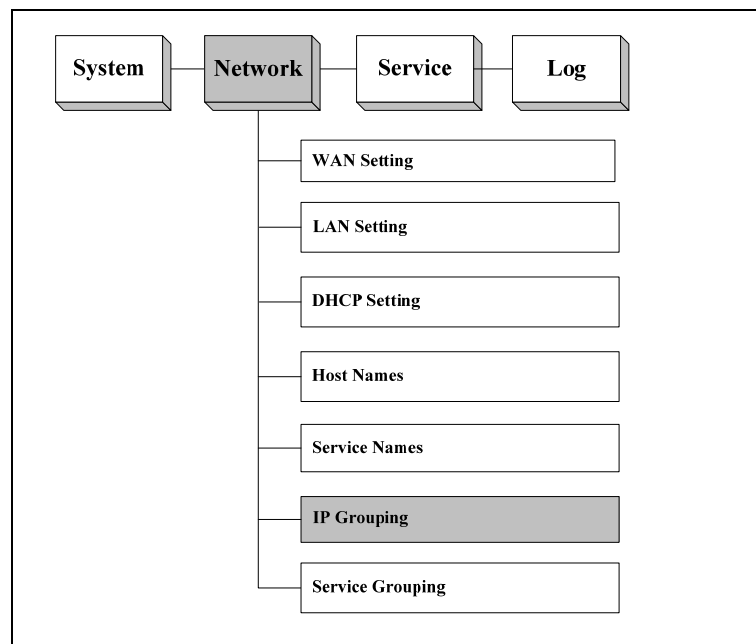

Figure 3.19 The Location of "System / IP Grouping" on the Menu Bar

IP Grouping:

Field	Description
Group Name	Input the name of the group, then it will appear in the service menu and the relevant options. Note: You can set at most 5 groups.

Table 3.11 IP Grouping

Rules Setting:

Field	Value	Description
IP address	<IP address>	Input IP address - One single IP address, or an IP address range in the format of xxx.xxx.xxx.xxx-yyy.yyy.yyy.yyy Or a subnet in the format of xxx.xxx.xxx.xxx/yyy.yyy.yyy.yyy
Group	belong to not belong to	Select the in group which the IP Address belongs to.

Table 3.12 Rules Setting

Note: The difference between the setting of and the setting of [Named IP Addresses] is that the format in [Named IP Addresses] can only be a range of IP Address, while [IP Group] provide several types of format. BR-6641 give more priority to the group in [Named IP Addresses]. It is recommended to use groups defined in [Host Name].

3.7 Service Grouping

This function allows you to assign a name to a group of TCP ports, UDP ports, and/or ICMP. Later on when you are asked to specify a port, you can use the name of the service group instead. The name of a service group will automatically show up in the port selection list if the service group is enabled.

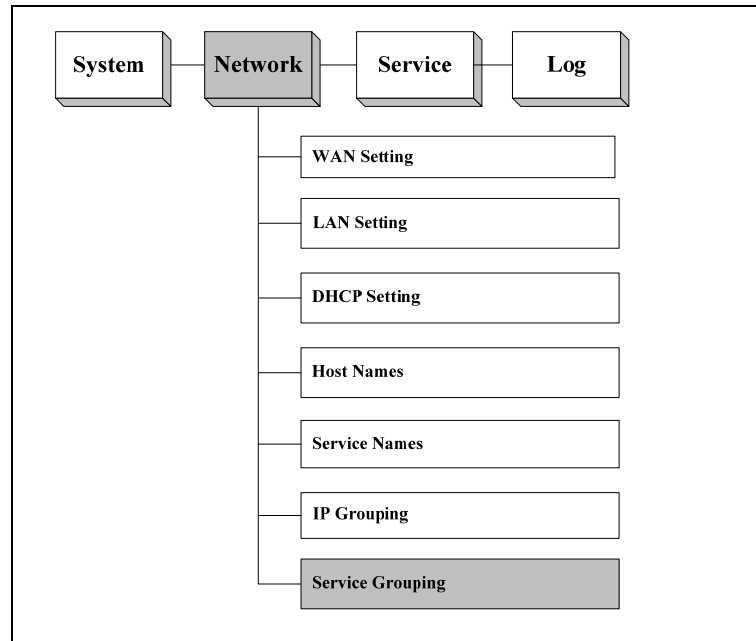

Figure 3.20 The Location of “System / Service Grouping” on the Menu Bar

Service Grouping:

Field	Value	Description
Group Name	<name>	Input the group name, e.g. MSN File Transfer, then it will appear in the service menu and relevant options. Note: You can set at most 5 groups.
Service	ICMP TCP@	Define the assigned TCP, UDP, and ICMP as a group for the usage in the

	UDP@	service menu. The format is port (xxx) for single Port and port (xxx-yyy) for a range of port, e.g. 6891-6900.
Group	belong to not belong to	Define if the the Port IPAddress in former Field belongs to the group.

Table 3.13 Service Grouping

For example, you can set up a service group called "MSN File Transfer". Its ports are TCP 6891 to 6900. You need to fill TCP@6891-6900 into Service field.

Chapter 4 Service

After having set up your network environment in the previous chapter, we will now look into the services provided by BR-6641.

These services can help you manage your network more efficiently and effectively. In figure 4.1, you can see a list of functions BR-6641 is capable of. These services play an important role in daily network administration. For example, Firewall protects your network from hacker attacks. It also improves your network security by filtering out unwanted service types. Routing policies can maximize the utilization of your network resources and assign routing paths accordingly based on the status of the network. QoS is another feature that you can set up to manage the traffic limit for a given TCP/UDP service (e.g. HTTP, FTP). This feature helps you allocate available bandwidth for each type of service and maximize the efficiency of your network. Multihoming provides a safeguard against failures in WAN links. Requests to the internal servers (e.g. WWW server) will be dispatched evenly on every live WAN link. If one of them fails, the internal servers can still be reached via other live links.

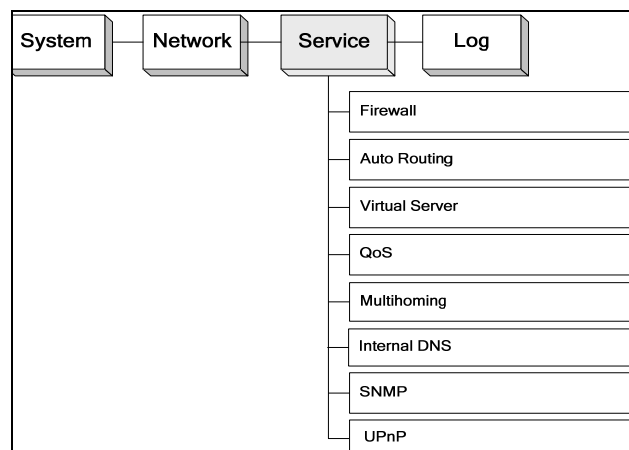

Figure 4.1 The Location of "System/Summary" on the Menu Bar

4.1 Firewall

[Summary] is in the submenu of [System], which helps the Administrator to know the system information. While logging in the Web UI, System/Summary is the first page you see when you log into BR-6641's web-based UI.

[Summary] provide the following information:

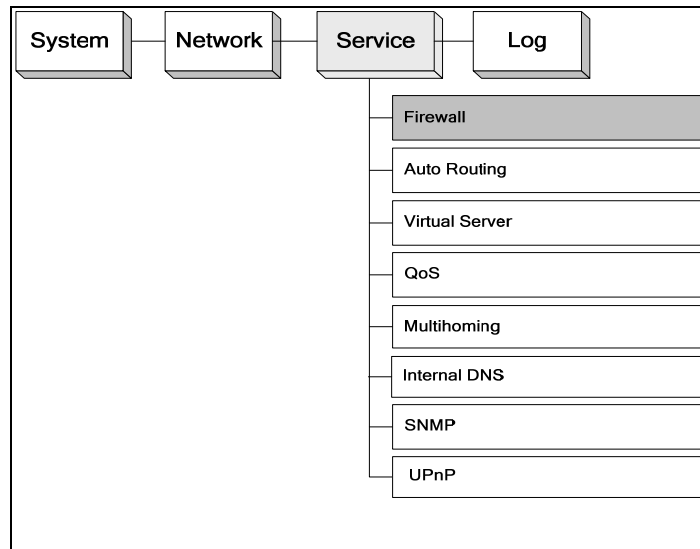

Figure 4.2 The Location of "Service/Firewall" on the Menu Bar

You can add as many rules as you like in the list. For each rule, you can enable or disable it individually. The rules are matched from top to down, that is, the rules listed at the top of the list are given higher precedence.

Field	Value	Description
When	Busy Idle All-Time	There are three options available: Busy hour, idle hour, and All-times. Please refer to Chapter 2 [System]→[Date/Time] for setting up the definition of busy or idle hours.

Source	Any address LAN WAN Localhost IP Address IP Range Subnet <Named addresses> < IP Grouping >	IP Packets sent from the specified source will be matched: Any Address: Match all packets regardless of its source. LAN: Match all packets that come from the LAN. WAN: Match all packets that come from the WAN. Localhost: Match all packets that come from BR-6641 Localhost. IP Address: Match packets from a single IP address. e.g. 192.168.1.4. IP Range: Match packets from a continuous range of IP addresses. e.g. 192.168.1.10-192.168.1.20 ° Subnet: Match packets that come from a subnet. e.g. 192.168.1.0/255.255.255.0 ° Named IP addresses: If you predefined IP groups in Chapter 3 [System]→[Named IP Grouping], their group names will be shown in the list. IP Grouping: If you predefined IP groups in Chapter 3 [System]→[IP Grouping], their Group Name will be shown in the list.
Destination	Any address LAN WAN Localhost IP Address IP Range Subnet <Named addresses> < IP Grouping >	IP Packets sent to specified destination will be matched. This field is the same as the "Source" field, except it matches packets with specified destination. Likewise, All IP groups setup in [System]→[IP Grouping] will be shown here.
Service	FTP(21) SSH (22) TELNET(23) SMTP(25) HTTP(80) POP3(110) H323 (1720) Protocol Number ICMP@ TCP@ UDP@ Any	IP The services, which are predefined in [Service Name], will be matched. For example: FTP(21): The packets, whose predefined TCP port number in [Service Name] is 21, are to be match. Protocol Number: Define the Protocol Number, then the packets with the Protocol Numbers are to be defined. ICMP @: Define the Type value, then the packets, whose ICMP take this Type value, will be defined. TCP/UDP @: The TCP/UDP service type to be matched. You can select the matching criteria from the publicly known service types (e.g. FTP), or you can choose the port number in TCP/UDP packet. To specify a range of port numbers, type starting port number plus hyphen "-" and ending port number. e.g. "TCP@123-234".

	< Service Grouping Name>	Group: The packets from the group which are predefined in [Service Grouping]. Any: All packets are to be matched. Note: The default value by BR-6641 is to neglect all the packets.
Action	Accept Deny	Accept: The firewall will let the matched packets pass through. Deny: The firewall will drop all the matched packets.
L	Enable Disable	Enable: The logging will be enabled. Whenever the rule is matched, the system will write the event to the log file. Disable: No log will be generated.

Table 4.1 The Description of the Fields on Firewall Page

4.2 Auto Routing

Auto Routing service allows administrators to specify how traffic is routed to WAN links. If you have only one WAN link, default configuration is ok.

If you have multiple WAN links, you may like to setup your routing rules in many situations. For example, an administrator can reserve a WAN link to a group of private IP addresses; or an administrator can force an application to take a particular WAN link depending on the traffic loads in each WAN links.

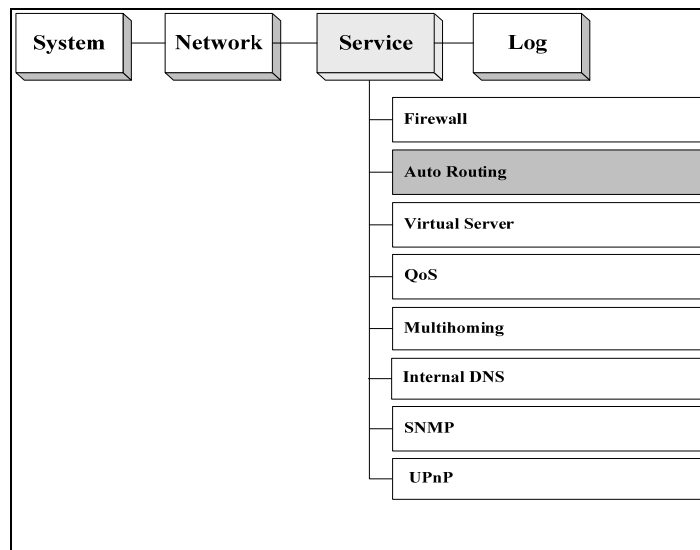

Figure 4.3 The Location of “Service /Auto Routing” on the Menu Bar

Auto Routing:

Field	Value	Description
When	Busy Idle All-Time	Select when the rule will be applied. There are three options available: Busy hour, idle hour, and All-time. All-time mean the rule will be applied for all the 24 hours a day. Please refer to Chapter 2 [System]->[Date&Time]->[Busyhour Setting] for setting up the definition of busy or idle hours.

Source	Any address LAN Local host IP Address IP Range Subnet <Named addresses> < IP Grouping >	Packets sent from the specified source will be matched: Any Address: Match all packets regardless of its source. LAN: Match all packets that come from the LAN. Localhost: Match all packets that come from BR-6641 Localhost. IP Address: Match packets from a single IP address. e.g. 192.168.1.4. IP Range: Match packets from a continuous range of IP addresses. e.g. 192.168.1.10-192.168.1.20 Subnet: Match packets that come from a subnet. e.g. 192.168.1.0/255.255.255.0 Named IP addresses: If you predefined IP groups in Chapter 3 [System]→[Named IP Grouping], their group name will be shown in the list. IP Grouping: If you predefined IP groups in Chapter 3 [System]→[IP Grouping], their Group Name will be shown in the list.
Destination	Any address WAN Local host IP Address IP Range Subnet <Named addresses> < IP Grouping >	Packets sent from the specified destination will be matched: Any Address: Match all packets regardless of its source. WAN: Match all packets that come from the WAN. Localhost: Match all packets that come from BR-6641 Localhost. IP Address: Match packets from a single IP address. e.g. 192.168.1.4. IP Range: Match packets from a continuous range of IP addresses. e.g. 192.168.1.10-192.168.1.20 Subnet: Match packets that come from a subnet. e.g. 192.168.1.0/255.255.255.0 Named IP addresses: If you predefined IP groups in Chapter 3 [System]→[Named IP Grouping], their group name will be shown in the list. IP Grouping: If you predefined IP groups in Chapter 3 [System]→[IP Grouping], their Group Name will be shown in the list.
Service	FTP(21) SSH (22) TELNET(23) SMTP(25) POP3(110) H323 (1720) Protocol Number ICMP@ TCP@	The services, which are predefined in [Service Name], will be matched. For example: FTP(21): The packets, whose predefined TCP port number in [Service Name] is 21, are to be match. Protocol Number: Define the Protocol Number, then the packets with the Protocol Number are to be defined. ICMP @: Define the Type value, then the packets, whose ICMP take this Type value, will be defined. TCP/UDP @: The TCP/UDP service type to be matched. You can select the matching criteria from the publicly known

	UDP@ < Service Grouping Name> Any	service types (e.g. FTP), or you can choose the port number in TCP/UDP packet. To specify a range of port numbers, type starting port number plus hyphen "-" and ending port number. e.g. "TCP@123-234". Group: The packets from the group which are predefined in [Service Grouping]. Any: All packets are to be matched
Algorithm	Fixed By Weight By Traffic	Algorithm for Auto Routing: 1. Fixed: Only route the connections on a fixed WAN link. 2. By Weight: Input the weight to route the connections to WAN link according to weight.. 3. By Traffic: Route the connection to the WAN link according to total traffic. Connection will be route to the link which has more remained bandwidth.
Parameter	<select WAN link(s) for the algorithm, or put a weight on each WAN link>	The type of parameter depends on the algorithm you choose. The number represents the number of WAN link. You can check, the check box under the number, telling BR-6641 to apply the algorithm to this WAN link.
L	Enable Disable	Enable: The logging will be enabled. Whenever the rule is matched, the system will write the event to the log file. Disable: No log will be generated.

Table 4.2 The Description of the Fields in the Auto Routing Policy Table

4.3 Virtual Server

Virtual Server is a feature to make your intranet (LAN) servers available to the Internet (WAN). Because the private IP addresses assigned to the intranet servers are invisible to the external environment. If you wish to make these services (provided on the servers) accessible to outsiders, you must tell BR-6641 to redirect these external requests to the right servers in the LAN or DMZ. Whenever an external request arrives at BR-6641, BR-6641 will look up the Virtual Server table and redirect the packet right to the corresponding server in the LAN or DMZ.

You can use this function to respond to the outside request with the server in the LAN or DMZ, when you don't want the private IP address to be public.

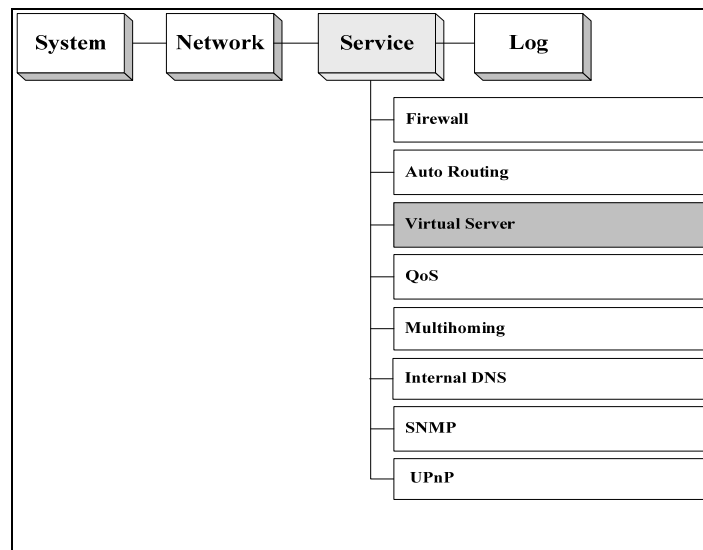

Figure 4.4 The Location of "Service/Virtual Server" on the Menu Bar

Virtual Server :

Field	Value	Description
When	Busy Idle All-Time	There are three options available: Busy hour, idle hour, and All-times. Please refer to Chapter 2 [System]→[Date/Time] for setting up the definition of busy or idle hours.
WAN IP	<WAN IP>	To the users from the Internet, your virtual server is visible as a public IP on the WAN port. This WAN IP is the “visible” IP for your virtual server in the external environment (Internet). You must specify a public IP if your WAN type is “Routing Mode”. If the WAN type is “Bridge Mode One Static IP”, your WAN IP in this field should be the public IP assigned from your ISP. Or, if your WAN type is none of the above, then choose “dynamic IP at WAN”.
Service	FTP(21) SSH (22) TELNET(23) H323 (1720) Protocol Number ICMP@ TCP@ UDP@ <Service Grouping Name> Any	The services, which are predefined in [Service Name], will be matched. For example: FTP(21): The packets, whose predefined TCP port number in [Service Name] is 21, are to be match. Protocol Number: Define the Protocol Number, then the packets with the Protocol Number are to be defined. ICMP @: Define the Type value, then the packets, whose ICMP take this Type value, will be defined. TCP/UDP @: The TCP/UDP service type to be matched. You can select the matching criteria from the publicly known service types (e.g. FTP), or you can choose the port number in TCP/UDP packet. To specify a range of port numbers, type starting port number plus hyphen “-”and ending port number. e.g. “TCP@123-234”. Group: The packets from the group which are predefined in [Service Grouping]. Any: All packets are to be matched
Server IP	<Server IP>	The original IP address of your virtual server. It can be a private IP in the LAN or a public IP in DMZ.
Server Port	Port Number	Input the Port Number of Server IP.
Log	Enable Disable	Enable: the logging will be enabled. Whenever the rule is matched, the system will write the event to the log file. Disable: No log will be generated.

Table 4.3 The Description of the Fields on Virtual Server Page

4.4 QoS

BR-6641 provides QoS towards both inbound and outbound traffic. It can ensure certain services which are allocated enough bandwidth to provide satisfactory quality. Because of the burst nature of voice/video/data traffic, sometimes the amount of traffic exceeds the speed of a link. This function is to manage the bandwidth so as to fine-tune your bandwidth utilization. Bandwidth Management (BM) in BR-6641 is separated by the direction of traffic flow – either inbound (from WAN to LAN) or outbound (from LAN to WAN).

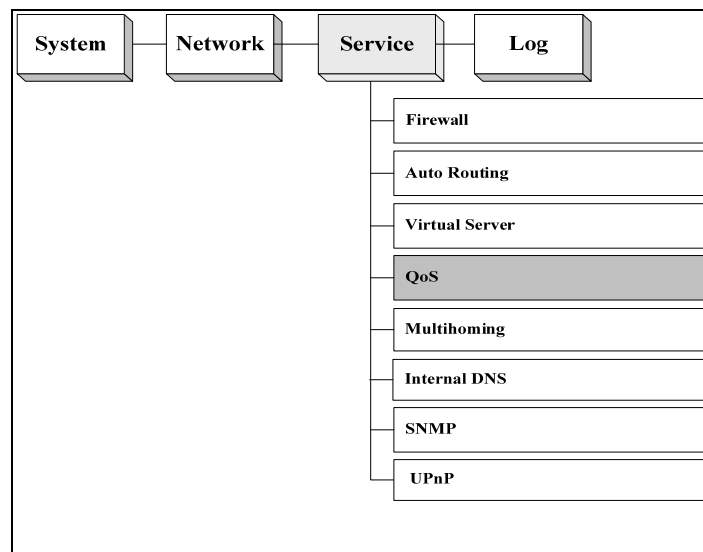

Figure 4.5 The Location of "Service/QoS" on the Menu Bar

The setting of QoS includes two parts: Classes and Filters.

Classes are to define the bandwidth classes that the rules are imposed on. The defining of the class can be according to Priority, Idle/Busy Hour.

You can configure your own bandwidth limit for each WAN link in Inbound Bandwidth Settings and Outbound Settings by collapse or expand them..

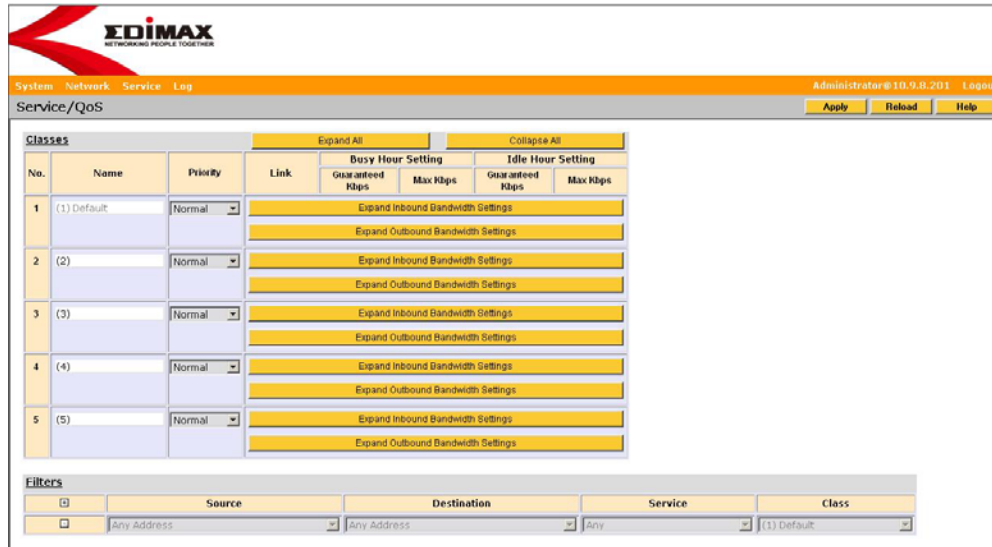

Figure 4.6 The Screenshot of Classes

Classes:

Field	Description	
Name	<Input name>	The name for this bandwidth class. We recommend you using a self-explanatory name so that you can understand it easily when it is used later in the filter table. For example, you can name your bandwidth class "HTTP" to manage the bandwidth of HTTP service.
Priority	Normal High Low	The priority of the connections on the WAN link. It can be High, Normal, or Low. The connections with higher priority are allocated with available bandwidth first.
Link	-	The WAN link which you want your bandwidth limit to apply.
Busy Hour Settings Note: Set Busy Hour in [System]→[Date Time].	Guaranteed Kbps	The guaranteed bandwidth for this class: This makes sure the connections through the WAN link will at least be allocated with the specified bandwidth. It is particularly useful when you want to ensure the quality of a certain type of service (e.g. VoIP).
	Max Kbps	This defines the maximum bandwidth allowed for the

		connections on the WAN link. Normally, we will set up maximum bandwidth for services like WWW or SMTP that have a high volume of traffic and may affect the quality of other services.
Idle Hour Settings Note: Set Idle Hour in [System]→[Date Time].	Guaranteed Kbps	The guaranteed bandwidth for this class: This makes sure the connections through the WAN link will be at least allocated with the specified bandwidth. It is particularly useful when you want to ensure the quality of a certain type of service (e.g. VoIP).
	Max Kbps	This defines the maximum bandwidth allowed for the connections on the WAN link. Normally, we will set up maximum bandwidth for services like WWW or SMTP that have high volume of traffic and may affect the quality of other services.

Table 4.4 The Description of the Fields in QoS Classes

Filters:

Field	Value	Description
Source	Any address LAN WAN Localhost IP Address IP Range Subnet <Named addresses> < IP Grouping >	<p>Packets sent from the specified source will be matched:</p> <p>Any Address: Match all packets regardless of its source.</p> <p>LAN: Match all packets that come from the LAN.</p> <p>WAN: Match all packets that come from the WAN.</p> <p>Localhost: Match all packets that come from BR-6641 Localhost.</p> <p>IP Address: Match packets from a single IP address. e.g. 192.168.1.4</p> <p>IP Range: Match packets from a continuous range of IP addresses. e.g. 192.168.1.10-192.168.1.20</p> <p>Subnet: Match packets that come from a subnet. e.g. 192.168.1.0/255.255.255.0</p> <p>IP Grouping: If you predefined IP groups in Chapter 3 [System]→[IP Grouping], their Group Name will be shown in the list.</p> <p>Named IP addresses: If you predefined IP groups in Chapter 3 [System]→[Named IP Grouping], their group name will be shown in the list.</p>
Destination	Any address LAN WAN Localhost IP Address	<p>Connections to the specified destination will be matched. This field is the same as the "Source" field, except it matches packets with the specified destination.</p> <p>In addition, the predefined IP groups will be shown in</p>

	IP Range Subnet <Named addresses> IP < IP Grouping >	the list as well. Please See [System]→[IP Grouping] for setting up your own IP groups.
Service	FTP(21) SSH (22) TELNET(23) SMTP(25) POP3(110) H323 (1720) Protocol Number ICMP@ TCP@ UDP@ <Service Name> Grouping Any	The services, which are predefined in [Service Name], will be matched. For example: FTP(21): The packets, whose predefined TCP port number in [Service Name] is 21, are to be match. Protocol Number: Define the Protocol Number, then the packets with the Protocol Number are to be defined. ICMP @: Define the Type value, then the packets, whose ICMP take this Type value, will be defined. TCP/UDP @: The TCP/UDP service type to be matched. You can select the matching criteria from the publicly known service types (e.g. FTP), or you can choose the port number in TCP/UDP packet. To specify a range of port numbers, type starting port number plus hyphen "-"and ending port number. e.g. "TCP@123-234". Group: The packets from the group which are predefined in [Service Grouping]. Any: All packets are to be matched.
Classes	<Name>	The bandwidth class to be imposed. These classes are defined in the bandwidth class table we mentioned earlier °

Table 4.5 The Description of the Fields in the Inbound BM Filter Table

4.5 Per IP Max Connection

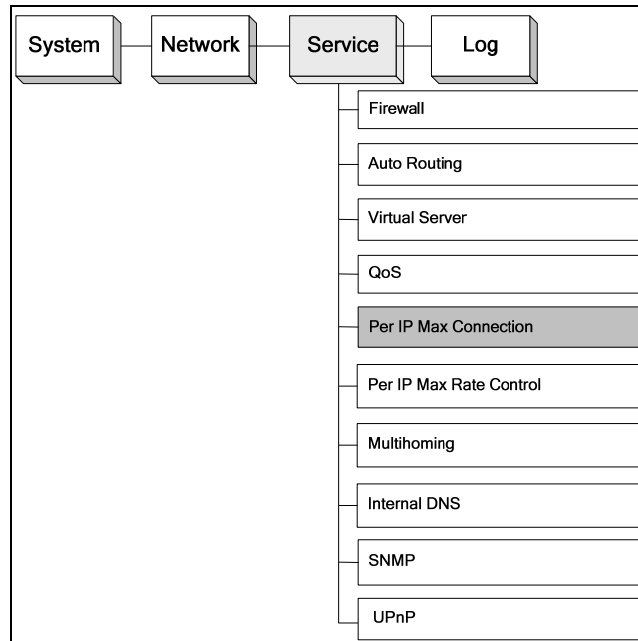

Figure 4.7 The Location of “Service / Per IP Max Connection” on the Menu Bar

This function is used to protect network against malicious attacks caused by virus or hackers. When the number of connections exceeds the preset value, BR-6641 will block the rest of connections and write the event to a log file if the check box of “Log” is ticked.

Log Interval 30 seconds

Rules			
	Source	Limit	Log
+	LAN	1000	<input checked="" type="checkbox"/>

Figure 4.8 The screenshot of Per IP Max Connection

Field	Value	Description
-------	-------	-------------

Log Interval	<in seconds>	The time interval used for system to write the event to the log file.
Source	<IP Address>	Connections established from the specified source will be matched, including Any Address, LAN, WAN, IP Address, IP Range, Subnet, and IP Group.
Limit	<value>	The maximum number of the connections allowed.
Log	Enable Disable	If the check box is ticked, whenever the rule is matched, the system will write the event to the log file.

Table 4.6 The Description of the fields in the Per IP Max Connection Table

4.6 Per IP Max Rate Control

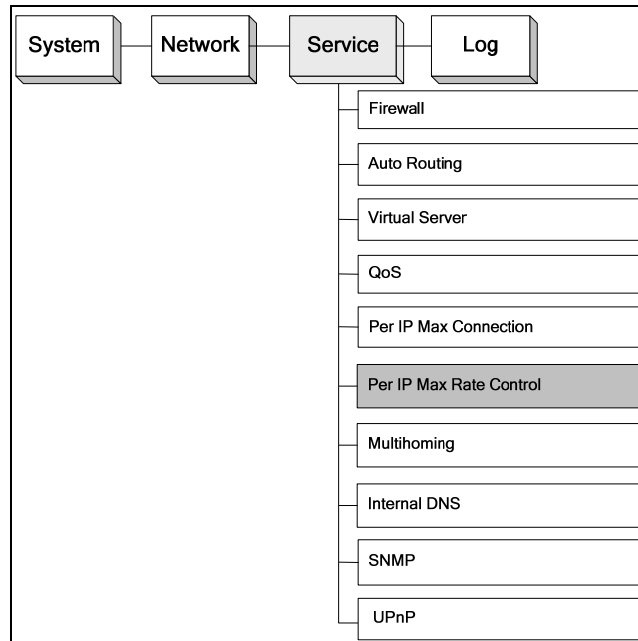

Figure 4.9 The Location of “Service / Per IP Max Rate Control” on the Menu Bar

This function is used to set the maximum bandwidth assigned to inbound and outbound traffic per IP in order to prevent network congestion from non-business application bandwidth consumption.

Rules			
□ □ □ □	IP	Bandwidth Limit	
		Inbound (Kbps)	Outbound (Kbps)
□ □ □ □	192.168.0.88	100	889
□ □ □ □	10.9.18.77-10.9.18.90	1234	789605
□ □ □ □	LAN	0	9
□ □ □ □	Group :	999999	0

Figure 4.10 The screenshot of Per IP Max Rate Control

Field	Value	Description
IP	<IP Address>	The IP where the packets come from will be matched, including LAN, IP Address, IP Range, IP Subnet, and specified IP Group.
Inbound (Kbps)	<value>	Maximum bandwidth assigned to inbound traffic per IP.
Outbound (Kbps)	<value>	Maximum bandwidth assigned to outbound traffic per IP.

Table 4.7 The Description of the fields in the Per IP Max Rate Control Table

4.7 Multihoming

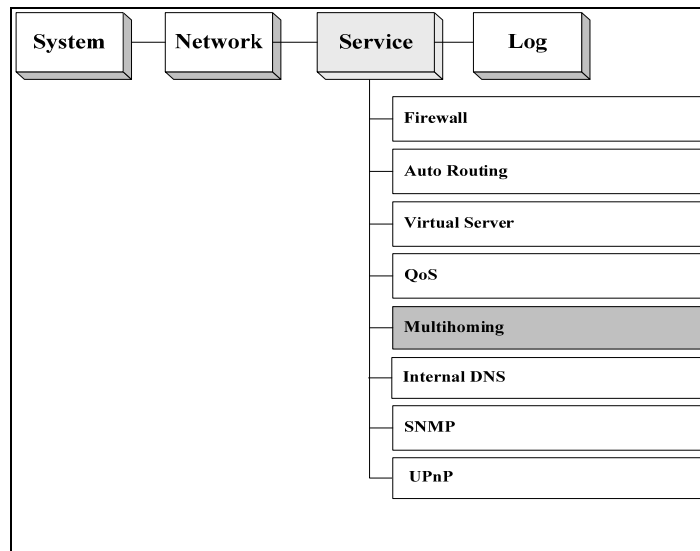

Figure 4.11 The Location of “Service / Multihoming” on the Menu Bar

BR-6641’s auto-routing service is a trunking technology that provides load balancing and fault tolerance for all outbound requests. But it does not apply to inbound requests. Based on a unique technology called SwiftDNS™, BR-6641 offers a Multihoming service for load balancing and fault tolerance for inbound requests. The minimum requirement for Multihoming is that you must have multiple WAN links and registered domain names for your publicly accessible servers. Whenever BR-6641 receives a DNS query; it answers the DNS query with a public IP address assigned to one of the WAN links according to the settings of your answering policies. Therefore, subsequent requests to your server will be sent the public IP of the WAN link based on BR-6641’s previous response. You can configure your answering policies with a weight for each WAN link so that the public IPs returned will be distributed evenly by weight. If one of your WAN links fails, BR-6641 will not return the public IP assigned to that failed link nevertheless your publicly accessible servers

are still reachable via other live WAN links.

In order to let your Multihoming function properly, you must make sure that the requirements listed below are met.

Prerequisites for Multihoming:

Multiple WAN links (at least two).

Registered domain names for your publicly accessible servers.

Your publicly accessible servers must be configured as virtual servers, or have public IP addresses.

By default, Multihoming is switched off. To use this service, check the check box to the right of "Enable Multihoming" on the top of the page. There are three tables for configuring your Multihoming settings. The first table lets you define the global parameters. The second table is used to configure your domain name settings.

■ **Global Setting**

Specify the PTR data in this field, including TTL, IP Address, and Host Name for reverse looking up the host name of corresponding IP Address.

Global Setting:

Field	Value	Description
TTL	<TTL>	Set DNS query response time.
IP Address	<IP Address>	Enter the reverse lookup IP address.
Host Name	<Link Number>	Enter the corresponding FQDN to the reverse IP.

Table 4.8 The Description of the Fields in Multihoming Global Setting

■ Domain Setting

In this table, you should configure your domain settings, including your multihoming domain names (can be more than one), the DNS servers for querying your domain names, and the answering policy to apply a given prefix of the domain name.

Domain Settings

Domain Settings			
<input type="text"/>	<input type="text"/>	Hide Details	
TTL	60		
Responsible Mail	<input type="text"/>		
Primary Name Server	IP Address		
<input type="text"/>	<input type="text"/>		
NS Record			
<input type="text"/>	Name Server	IP Address	
<input type="text"/>	<input type="text"/>	<input type="text"/>	
<input type="text"/>	<input type="text"/>	<input type="text"/>	
A Record			
<input type="text"/>	Host Name	Policy Type	Parameter
<input type="text"/>	<input type="text"/>	By Weight	Hide Details
			IP Weight

Figure 4.12 Domain Setting

Domain Setting:

Field	Description
Domain Name	Enter the domain names for Multihoming. To enter additional domain names, press +.
TTL	Assign DNS query response time.
Responsible Mail	Enter the domain administrator's email.
Primary Name Server	Enter the primary server name.
Source IP	The query IP address can be an IP address, IP range, subnet, or any address.
NS Record	
Name Server	Enter the prefix of the server name. For example, if a server's FQDN is nsl.abc.com, please enter "nsl".
IP Address	Enter the IP address corresponding to the name server.
A Record	
Host Name	Enter the prefix of the primary workstation's name. For example, if the name is www.abc.com, enter "www".

Policy Type	The algorithm for selecting WAN links, by Wight or by Traffic. By Weight: Answer DNS queries by the weight given to each link. By Total Traffic: Answer DNS queries by selecting the WAN link with the lightest total traffic.
Parameter-IP	Enter the IP address to answer DNS queries.
Parameter-Weight	Input the weight for each WAN Link.
CName Record	
Alias	Enter the alias of the domain name. For example, if you wish to use www1.abc.com as the alias of www.abc.com, (domain name), enter "www1" in this field.
Target	Enter the real domain name. For example, if you wish to use www1.abc.com as the alias for www.abc.com, enter "www".
MX Record	
Host Name	Enter the prefix of the mail server's domain name. For example, if the domain name is mail.abc.com, enter "mail".
Priority	Enter the priority of the mail servers. The higher the priority, the lower the number
Mail Server	Enter the IP address of the mail server.

Table 4.9 The Description of the Fields in Domain Setting

4.8 Internal DNS

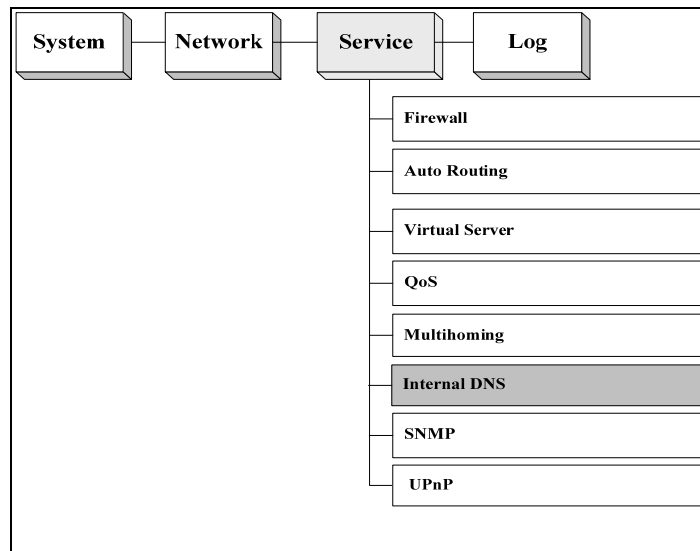

Figure 4.13 The Location of “Service / Internal DNS” on the Menu Bar

BR-6641 has a built-in DNS server function which can be activated by completing the fields in this page.

Global Settings:

Field	Value
Enable InternalDNS	Turn on/off internal DNS server.
PTR Record	
TTL	Set DNS query response time.
IP Address	Enter the reverse lookup IP address.
Host Name	Enter the corresponding FQDN to the reverse IP.

Table 4.10 The Description of the Fields in Global Setting

Domain Settings:

Field	Description
Domain Name	Enter the domain names for internal DNS. To enter additional domain names, press +.
TTL	Assign DNS query response time.
Responsible Mail	Enter the domain administrator's email.
Primary Name Server	Enter the primary server name.
IP Address	The query IP address can be an IP address, IP range, subnet, or any address.
NS Record	
Name Server	Enter the prefix of the server name. For example, if a server's FQDN is nsl.abc.com, please enter "nsl".
IP Address	Enter the IP address.
A Record	
Host Name	Enter the prefix of the primary workstation's name. For example, if the name is www.abc.com, enter "www".
IP Address	Input the IP Address of Localhost.
Cname Record	
Alias	Enter the alias of the domain name. For example, if you wish to use www1.abc.com as the alias of www.abc.com, (domain name), enter "www1" in this field.
Target	Enter the real domain name. For example, if you wish to use www1.abc.com as the alias for www.abc.com, enter "www".
MX Record	
Host Name	Enter the prefix of the mail server's domain name. For example, if the domain name is mail.abc.com, enter "mail".
Priority	Enter the priority of the mail servers. The higher the priority, the lower the number.
Mail Server	Enter the IP address of the mail server.

Table 4.11 The Description of the Fields in Domain Setting

4.9 SNMP

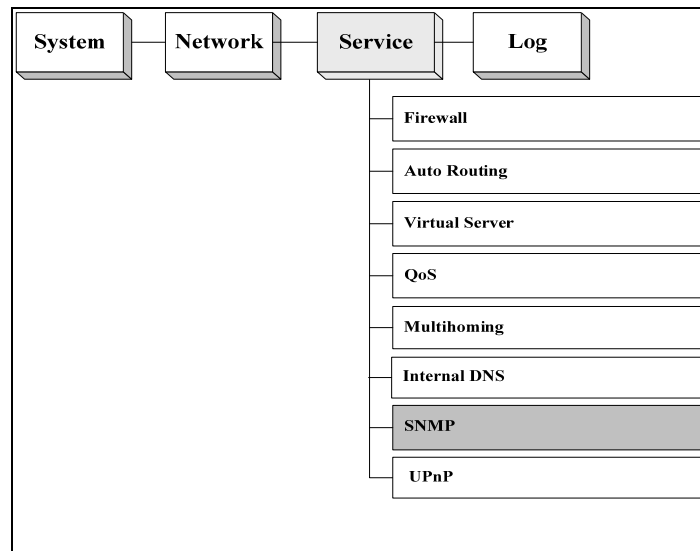

Figure 4.14 The Location of "Service /SNMP" on the Menu Bar

SNMP (Simple Network Management Protocol) can be used to manage networks by providing statistical data regarding network performance and security. It is often used in the management of TCP/IP networks.

SNMP Settings:

Field	Description
Enable SNMP	Enable/Disable SNMP.
Community	Enter the community which the SNMP belongs to. The default value is "public".
Description	Enter the description of the machine.
Contact Info	Enter the contact information of the machine.
Node Name	Enter the Node Name.
Location	Enter the location of the machine.

Table 4.12 The Description of the Fields in SNMP

4.10 UPnP

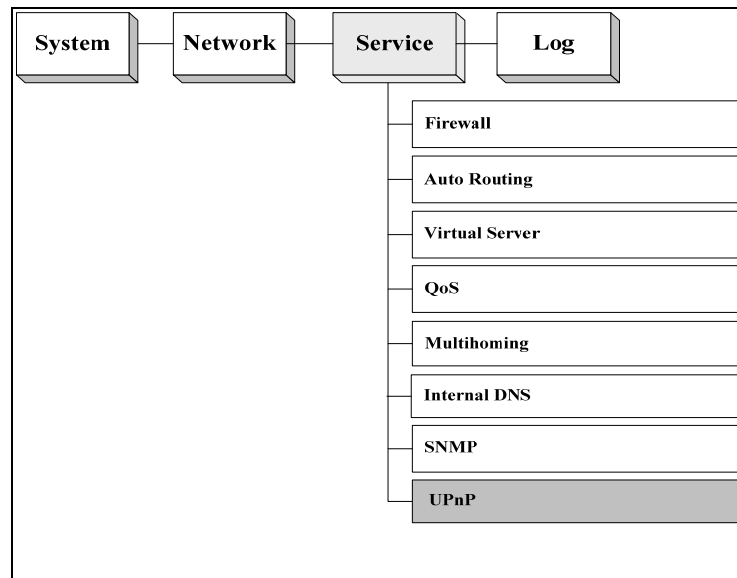

Figure 4.15 The Location of "Service / UPnP" on the Menu Bar

BR-6641 will detect the public UPnP (Universal Plug and Play) equipment in the network and automatically respond to its predefined IP Address.

Field	Value	Description
Enable UPnP	Enable Disable	Enable or disable the function.
WAN IP	<IP Address>	Input the WAN IP preserved for public UPnP, including dynamic IP address and open IP address.
Weight	E.g.:1,2...	Input the weight, the bigger number will be given the higher priority.

Table 4.13 The Description of the Fields in UPnP

Chapter 5 Log

In this Chapter, you can control BR-6641's logging activities with respect to various functionalities such as the System, Firewall, Routing, etc. Administrator can also either set up the log transmission methods to another server for purpose of archiving and further analyses, or control the event notifications settings via emails.

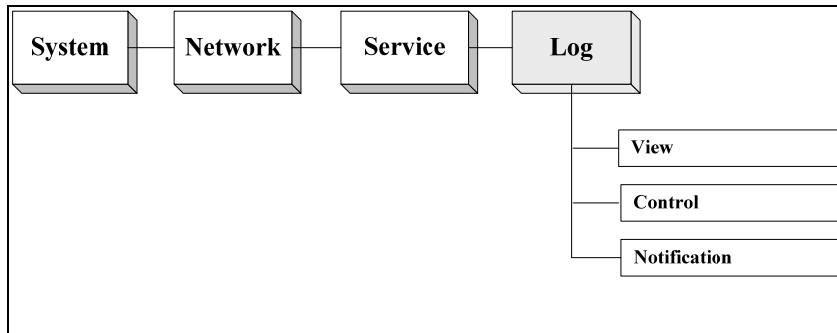

Figure 5.1 The Location of Log and its Function on the Menu Bar

5.1 View

In the 'View' Sub-menu, BR-6641 provides two types of comprehensive log records (see the table below). Administrator can pick the desired log type and the corresponding events for that type will be shown in the windows below. Press the 'refresh' button to get a copy of the latest log.

For log data pushing and archiving, see the 'control' sub-menu in next section. An FTP Server or Email Server or Syslog Server should be provided.

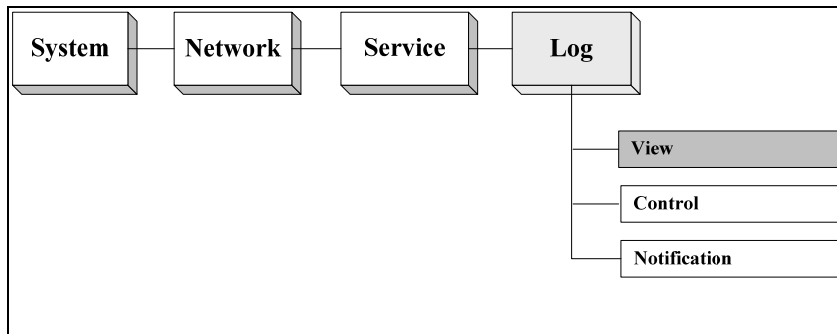

Figure 5.2 The Location of Log/View Page Menu Bar

Field	Value	Description
Log Type	System Log Traffic Log	You can pick the log type of your preferred events to be shown in the log viewing window.
Recent Event	-	Event log listed by order of timestamp
Refresh	-	Refresh to get the latest event log

Table 5.1 The Description of the Fields on Log/View Page

5.2 Control

With this sub-menu, you can set up how log data will be transmitted to other servers (out of BR-6641) for archiving and further analyses. Transmission methods include FTP, Email and Syslog. Each log type can have its own transmission method setting.

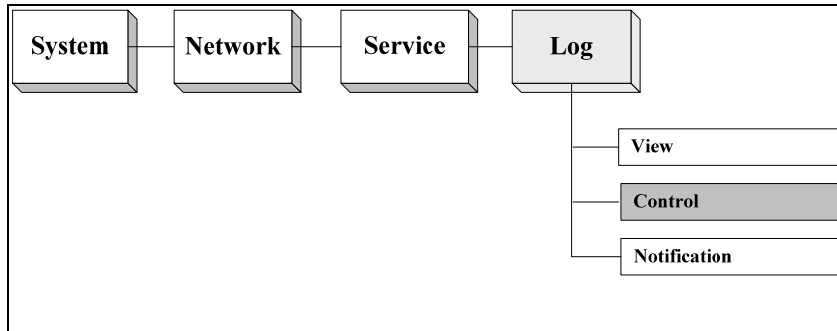

Figure 5.3 Location of Log/Control Page on the Menu Bar

Field	Value	Description
Log Control	System Log Traffic Log	Select the type of Log file to be pushed.
System Log		
Log Method	E-Mail FTP Syslog	See below.
Push Now		Use this button to start log pushing immediately.
Traffic Log		
Log Method	E-Mail FTP Syslog	See below.
Push Now		Use this button to start log pushing immediately.

Table 5.2 The Description of the Fields on Log/Control Page

Method

BR-6641 offers three types of log transmissions: FTP out to an external FTP server, Syslog out to a syslog server or send emails via SMTP to the administrator's mailbox.

■ E-mail

Field	Value	Description
SMTP Server	<IP> or <Domain Name>	SMTP server for the logs.
Account	<SMTP Account>	Authenticated account for mail server
Password	<Account's Password>	Authenticated password for mail server.
Mail From	<e-Mail address>	Sender of the Email.
Mail To	<e-Mail address>	Receiver of the Email.
Auto Push		Push this button to start log pushing automaticaly.
Scheduled Push		Turn on scheduled push.
Initial Time	<Year/Month/Day/Hour/Minute/Second>	Start time for the scheduled push.
Period	<Day/Hour/Minute>	Scheduled push duration.

Table 5.3 Method: E-mail

■ FTP

Field	Value	Description
Server	<IP> or <Domain Name>	FTP Server's IP or domain name.
Account	<FTP Account>	FTP user account.
Password	<Account's Password>	FTP user password.
Path	<Path>	FTP server path.
Auto Push		Push this button to start log pushing automatically.
Scheduled Push		Turn on scheduled push.
Initial Time	<Year/Month/Day/Hour/Minute/Second>	Start time for the scheduled push.
Period	<Day/Hour/Minute>	Scheduled push duration.

Table 5.4 Method: FTP

■ Syslog

Field	Value	Description
Syslog Server	<IP> or <Domain Name>	Syslog Server's IP or domain name.

Table 5.5 Method: Syslog

5.3 Notification

In this sub-menu, you can set up how email notifications are sent out for important system events. The setup is similar to previous section's email account settings.

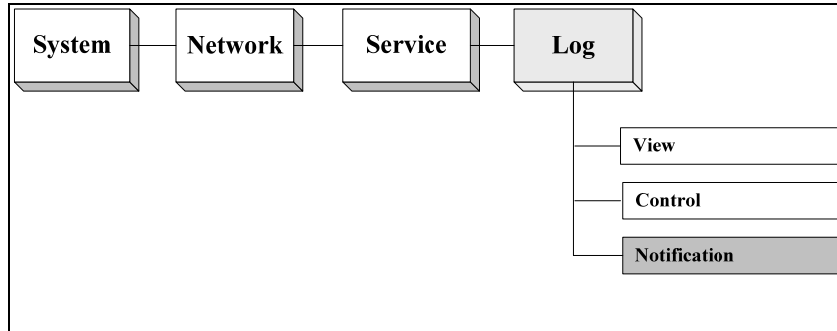

Figure 5.4 Location of Log/Notification Page on the Menu Bar

■ Notification

Field	Value	Description
SNMP Email		Select how Email notifications are sent out.
SNMP Settings		
Destination IP	<IP Address>	The SNMP managing device IP.
Community Name	<Community Name>	The community name.
Link Fail		Enable this function, system will notify administrator when a Link Fail happened.
Email Settings		
SMTP Server		SMTP Server.
Account		Authenticated account for mail server.
Password		Authenticated password for mail server.
Mail From		Sender.
Mail To		Receiver.

Link Fail		Enable this function, system will notify administrator when a Link Fail happened.
Admin Password Change		Enable this function, system will notify administrator when Administrator password is changed.

Table 5.6 The Description of the Fields on Log/Notification

Free Manuals Download Website

<http://myh66.com>

<http://usermanuals.us>

<http://www.somanuals.com>

<http://www.4manuals.cc>

<http://www.manual-lib.com>

<http://www.404manual.com>

<http://www.luxmanual.com>

<http://aubethermostatmanual.com>

Golf course search by state

<http://golfingnear.com>

Email search by domain

<http://emailbydomain.com>

Auto manuals search

<http://auto.somanuals.com>

TV manuals search

<http://tv.somanuals.com>