



Broadband Router

4 Port Switch Broadband Router

BR-6004

User's Manual

The logo for SigmaDIMAX features a red dot above the letter 'I' in "DIMAX". The Greek letter sigma (Σ) is positioned to the left of "DIMAX".

ΣDIMAX

Copyright

The contents of this publication may not be reproduced in any part or as a whole, stored, transcribed in an information retrieval system, translated into any language, or transmitted in any form or by any means, mechanical, magnetic, electronic, optical, photocopying, manual, or otherwise, without the prior written permission.

Trademarks

All product, company, brand names are trademarks or registered trademarks of their respective companies. They are used for identification purpose only. Specifications are subject to be changed without prior notice.

FCC Interference Statement

This equipment has been tested and found to comply with the limits for a Class B digital device pursuant to Part 15 of the FCC Rules. These limits are designed to provide reasonable protection against radio interference in a commercial environment. This equipment can generate, use and radiate radio frequency energy and, if not installed and used in accordance with the instructions in this manual, may cause harmful interference to radio communications. Operation of this equipment in a residential area is likely to cause interference, in which case the user, at his own expense, will be required to take whatever measures are necessary to correct the interference.

CE Declaration of Conformity

This equipment complies with the requirements relating to electromagnetic compatibility, EN 55022/A1 Class B, and EN 50082-1. This meets the essential protection requirements of the European Council Directive 89/336/EEC on the approximation of the laws of the member states relation to electromagnetic compatibility.

Table of Contents

Chapter 1	Introduction	4
1.1	Functions and Features	4
1.2	Packing List	5
Chapter 2	Hardware Installation.....	6
2.1.	Panel Layout	6
2.2.	Installation Requirements	7
2.3.	Procedure for Hardware Installation	7
Chapter 3	Network Settings and Software Installation.....	10
3.1	Make correct network settings of your computer	10
Chapter 4	Configuring IP Sharer	12
4.1	Start-up and Log in.....	12
4.2	Status	13
4.3	Toolbox.....	14
4.4	Primary Setup.....	15
4.5	DHCP Server.....	17
4.6	Virtual Server	18
4.7	Special AP.....	19
4.8	Access Control	20
4.9	Misc Items	21
Appendix A	Console Mode	22
Appendix B	TCP/IP Configuration for Windows 95/98.....	23
B.1	Install TCP/IP protocol into your PC.....	23
B.2	Set TCP/IP protocol for working with IP Sharer.....	24

Chapter 1 Introduction

Congratulations on your purchase of this outstanding Broadband Router. This product is specifically designed for Small Office and Home Office needs. It provides a complete SOHO solution for Internet surfing and office resources sharing, and it is easy to configure and operate for even non-technical users. Instructions for installing and configuring this product can be found in this manual. Before you install and use this product, please read this manual carefully for fully exploiting the functions of this product.

1.1 Functions and Features

Broadband modem and IP sharing

connects multiple computers to a broadband (cable or DSL) modem or an Ethernet router to surf the Internet.

Auto-sensing Ethernet Switch

equipped with a 4-port auto-sensing Ethernet switch.

VPN supported

supports multiple PPTP sessions and allows you to setup VPN server and VPN clients.

Firewall

all unwanted packets from outside intruders are blocked to protect your Intranet.

DHCP server supported

all of the networked computers can retrieve TCP/IP settings automatically from this product.

Web-based configuring

configurable through any networked computer's web browser using Netscape or Internet Explorer.

Access Control supported

allows you to assign different access right for different users.

Virtual Server supported

enables you to expose WWW, FTP and other services on your LAN to be accessible to Internet users.

User-Definable Application Sensing Tunnel

user can define the attributes to support the special applications requiring multiple connections, like Internet gaming, video conferencing, Internet telephony and so on, then this product can sense the application type and open multi-port tunnel for it.

DMZ Host supported

lets a networked computer to be fully exposed to the Internet; this function is used when special application sensing tunnel feature is insufficient to allow an application to function correctly.

1.2 Packing List

One broadband router unit

One power cord and power adapter

One user's manual

Two CAT-5 UTP Fast Ethernet cable

Chapter 2 Hardware Installation

2.1. Panel Layout

2.1.1. Front Panel

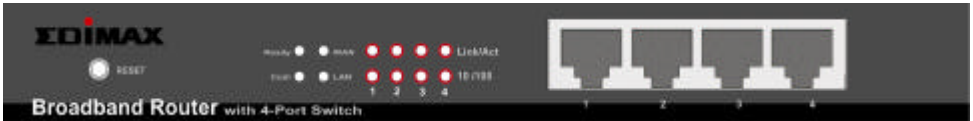

Figure 2-1 Front Panel

- RESET** When RESET is pushed, system settings will be set to factory defaults.
- Ready & Com** System status indicators, *Orange*. Ready is flashed once per second to indicate system is alive. When COM port is active, COM LED is lighted.
- WAN & LAN** Ethernet port indicators, *Green*. The LED flickers when LAN or WAN port is sending or receiving data.
- Link/Act.** Link status indicators, *Green*. The LED flickers when the corresponding port is sending or receiving data
- 10/100** 10/100 status indicators, *Green*. The LED flickers when the corresponding port is transmitting or receiving data in 10 or 100Mbps.
- Port 1 - 4** LAN port socket (RJ-45). These are where you will connect to device on your local area network, for example HUB and switch.

2.1.2. Rear Panel



Figure 2-2 Rear Panel

- WAN** WAN port socket (RJ-45). This is where you will connect to your cable (or DSL) modem or Ethernet router.
- COM** Serial port connector (9-pins D-type male). This is where you will connect your modem. This port is also a console port.

Power Power inlet. This is where you connect the included power adapter. *Note that, the included power adapter is DC 5V/1A. Using wrong type of power adapter may cause this product damage.*

2.2. Installation Requirements

This product can be positioned at any convenient place in your office or house. No special wiring or cooling requirements is needed. However, you should comply with the following guidelines to install:

Place this product on a flat horizontal plane.

Keep this product away from any heating devices.

Do not place this product in dusty or wet environment.

The recommended operational specifications of this product are:

Temperature	0 °C ~ 55 °C
Humidity	5 % ~ 90 %

In addition, remember to turn off the power, remove the power cord from the outlet, and keep your hands dry when you try to install the hardware of this product.

2.3. Procedure for Hardware Installation

- 1. Setup LAN connection:** connect an Ethernet cable from your computer's Ethernet port to one of the LAN ports of this product.

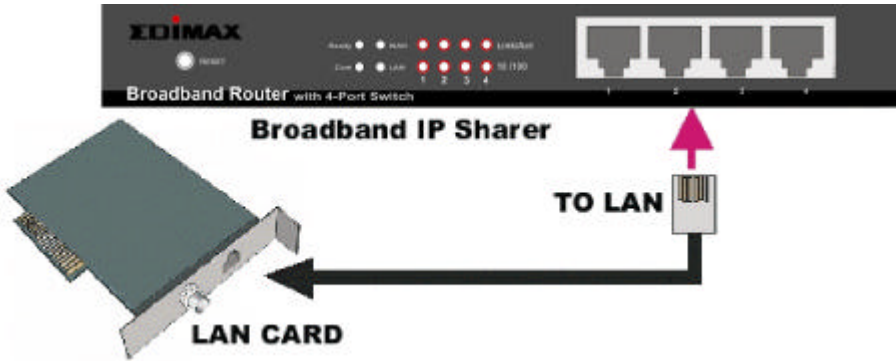

Figure 2-3 Setup of LAN connections for this product.

2. **Setup WAN connection:** prepare an Ethernet cable for connecting this product to your cable/xDSL modem or Ethernet backbone. Figure 2-4 illustrates the WAN connection.

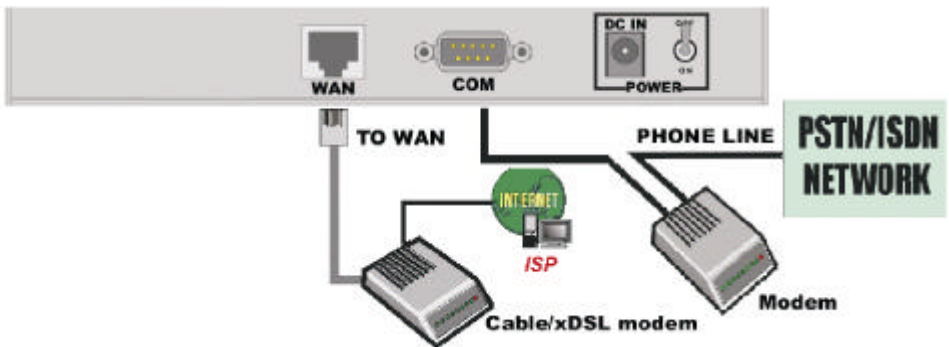

Figure 2-4 Setup of WAN connections for this product.

3. **Power on:**

Connecting the power cord to power inlet and turning the power switch on, this product will automatically enter the self-test phase. When it is in the self-test phase, the indicators Ready and COM will be lighted ON for about 5 seconds, and then Ready and COM will be flashed 3 times to indicate that the self-test operation has

finished. Finally, the M1 will be continuously flashed once per second to indicate that this product is in normal operation.

Chapter 3 Network Settings and Software Installation

To use this product correctly, you have to properly configure the network settings of your computers and install the attached setup program into your MS Windows platform (Windows 95/98/NT).

3.1 Make correct network settings of your computer

The default *IP address* of this product is 192.168.123.254, and the default *subnet mask* is 255.255.255.0. These addresses can be changed on your need, but the default values are used in this manual. If the TCP/IP environment of your computer has not yet been configured, you can refer to *Appendix B* to configure it. For example,

1. configure *IP* as 192.168.123.1, *subnet mask* as 255.255.255.0 and *gateway* as 192.168.123.254, or more easier,
2. configure your computers to load TCP/IP setting automatically, that is, via DHCP server of this product.

After installing the TCP/IP communication protocol, you can use the *ping* command to check if your computer has successfully connected to this product. The following example shows the ping procedure for Windows 95 platforms. First, execute the *ping* command

```
ping 192.168.123.254
```

If the following messages appear:

```
Pinging 192.168.123.254 with 32 bytes of data:
```

```
Reply from 192.168.123.254: bytes=32 time=2ms TTL=64
```

a communication link between your computer and this product has been successfully established. Otherwise, if you get the following messages,

```
Pinging 192.168.123.254 with 32 bytes of data:
```

```
Request timed out.
```

there must be something wrong in your installation procedure. You have to check the following items in sequence:

1. *Is the Ethernet cable correctly connected between this product and your computer?*

Tip: The LAN LED of this product and the link LED of network card on your computer must be lighted.

2. *Is the TCP/IP environment of your computers properly configured?*

Tip: If the IP address of this product is 192.168.123.254, the IP address of your computer must be 192.168.123.X and default gateway must be 192.168.123.254.

Chapter 4 Configuring IP Sharer

This product provides Web based configuration scheme, that is, configuring by Netscape Communicator or Internet Explorer. This approach can be adopted in any MS Windows, Macintosh or UNIX based platforms.

4.1 Start-up and Log in

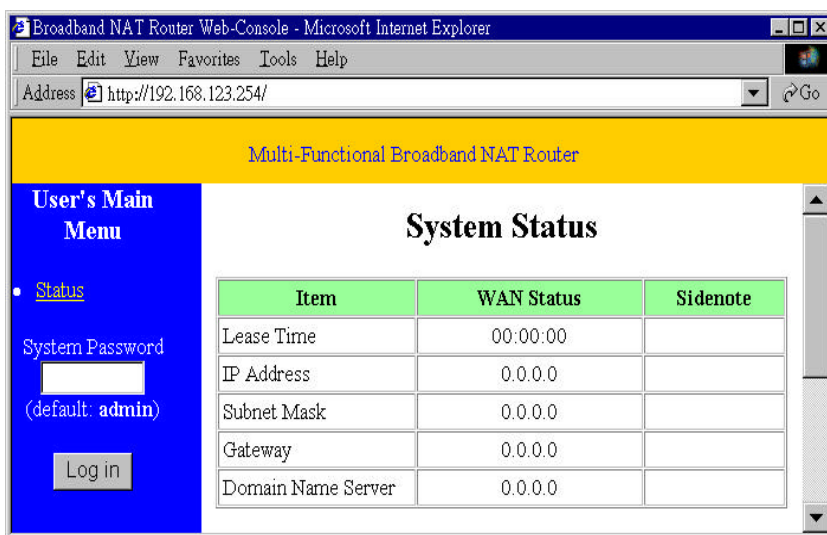

Activate your browser, and *disable the proxy* or *add the IP address of this product into the exceptions*. Then, type this product's IP address in the *Location* (for Netscape) or *Address* (for IE) field and press ENTER. For example: ***http://192.168.123.254***.

After the connection is established, you will see the web user interface of this product. There are two appearances of web user interface: *for general users* and *for system administrator*.

To log in as an administrator, enter the system password (the factory setting is "admin") in the *System Password* field and click on the *Log in* button. If the password is correct, the web appearance will be changed into administrator configure mode. As listed in its main menu, there are several options for system administration.

4.2 Status

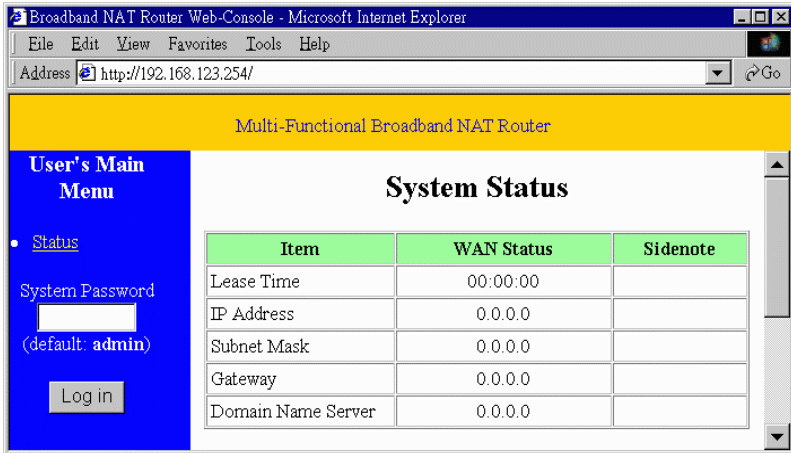

This option provides the function for observing this product's working status:

A. WAN Port Status.

If the WAN port is assigned a dynamic IP, there may appear a "Renew" or "Release" button on the *Sidenote* column. You can click this button to renew or release IP manually.

B. Modem Status.

4.3 Toolbox

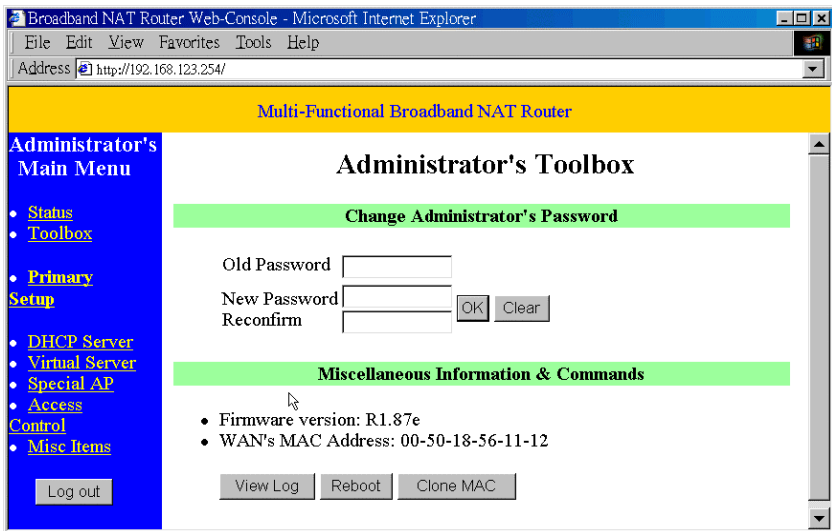

This option enables you change the administrator password. Besides, you can get the information about *Firmware version* and *WAN's MAC Address*.

You can also reboot this product by clicking the **Reboot** button.

Note: we strongly recommend you to change the system password for security reason. If you forgot the system password, please refer to Appendix A to reset a new one.

4.4 Primary Setup

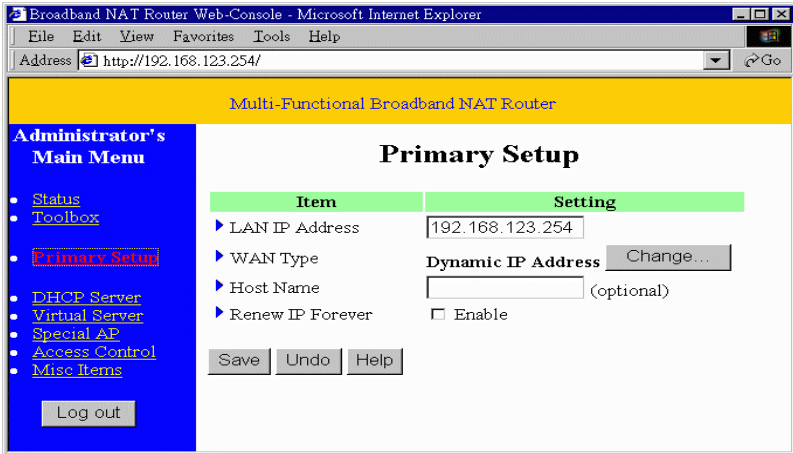

This option is primary to enable this product to work properly. The setting items and the web appearance depend on the WAN type. Choose correct WAN type before you start.

1. **LAN IP Address:** this product's IP address. The default address is 192.168.123.254. You can change it on your need.
2. **WAN Type:** WAN connection type of your ISP. You can click **Change** button to choose a correct one from the following four options:
 - A. *Static IP Address:* ISP assigns you a static IP address.
 - B. *Dynamic IP Address:* Obtain an IP address from ISP automatically.
 - C. *PPP over Ethernet:* Some ISPs require the use of PPPoE to connect to their services.
 - D. *Dial-up Network:* To surf the Internet via PSTN/ISDN.

4.4.1 Static IP Address

WAN IP Address, Subnet Mask, Gateway, Primary and Secondary DNS: enter the proper setting value provided by your ISP.

4.4.2 Dynamic IP Address

1. *Host Name:* optional. Required by some ISPs, for example, @Home.
2. *Renew IP Forever:* this feature enable this product renew IP address automatically when the lease time is being expired even the system is in idle state.

4.4.3 PPP over Ethernet

1. *PPPoE Account and Password:* the account and password your ISP assigned to you. If you don't want to change the password, keep it empty.
2. *PPPoE Service Name:* optional. Input the service name if your ISP requires it.
3. *Maximum Idle Time:* the time of no activity to disconnect your PPPoE session. Set it to 0 will disable this feature.

4.4.4 Dial-up Network

1. *Dial-up Telephone, Account and Password:* assigned by your ISP. If you don't want to change the password, keep it empty.
2. *Primary and Secondary DNS:* automatically assigned if they are configured as "0.0.0.0."
3. *Maximum Idle Time:* the time of no activity to disconnect your dial-up session.
4. *Baud Rate:* the communication speed between this product and your MODEM or ISDN TA.
5. *Extra Setting:* needed to optimize the communication quality between the ISP and your MODEM or ISDN TA

4.5 DHCP Server

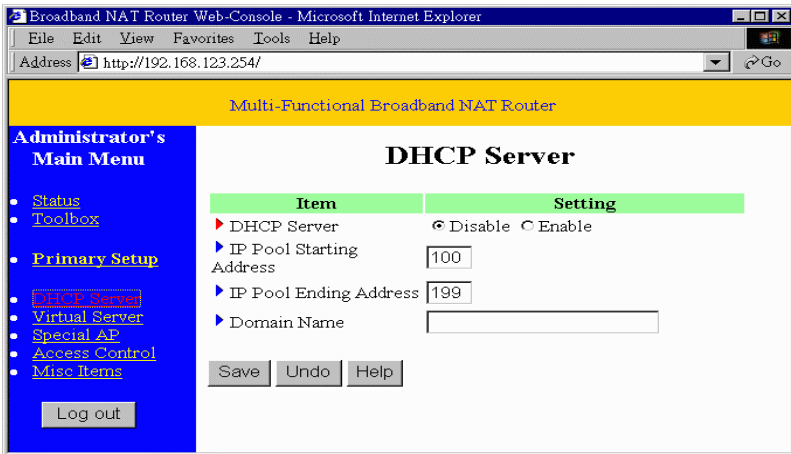

The settings of TCP/IP environment include Host IP, Subnet Mask, Gateway, and DNS configurations. It is not a simple task to correctly configure all the computers in your LAN environment. Fortunately, DHCP provides a rather simple approach to handle all these settings. This product supports the function of DHCP server. If you enable this product's DHCP server and configure your computers as "automatic IP allocation" mode, then when your computer is powered on, it will automatically load the proper TCP/IP settings from this product. The settings of DHCP server include the following items:

1. **DHCP Server:** Choose "Disable" or "Enable."
2. **Range of IP Address Pool:** Whenever there is a request, the DHCP server will automatically allocate an unused IP address from the *IP address pool* to the requesting computer. You must specify the starting and ending address of the IP address pool.
3. **Domain Name:** Optional, this information will be passed to the client.

4.6 Virtual Server

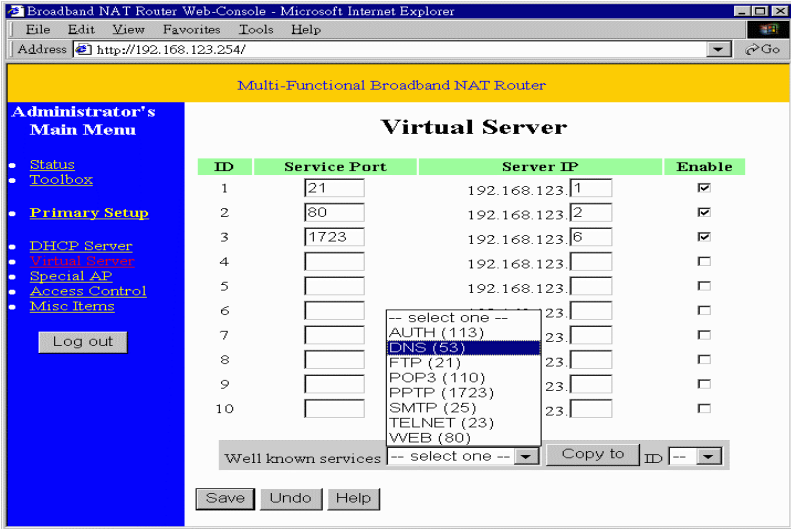

This product's NAT firewall filters out unrecognized packets to protect your Intranet, so all hosts behind this product are invisible to the outside world. If you wish, you can make some of them accessible by enabling the *Virtual Server Mapping*.

A virtual server is defined as a **Service Port**, and all requests to this port will be redirected to the computer specified by the **Server IP**.

For example, if you have an FTP server (port 21) at 192.168.123.1, a Web server (port 80) at 192.168.123.2, and a VPN server at 192.168.123.6, then you need to specify the following virtual server mapping table:

Service Port	Server IP	Enable
21	192.168.123.1	V
80	192.168.123.2	V
1723	192.168.123.6	V

4.7 Special AP

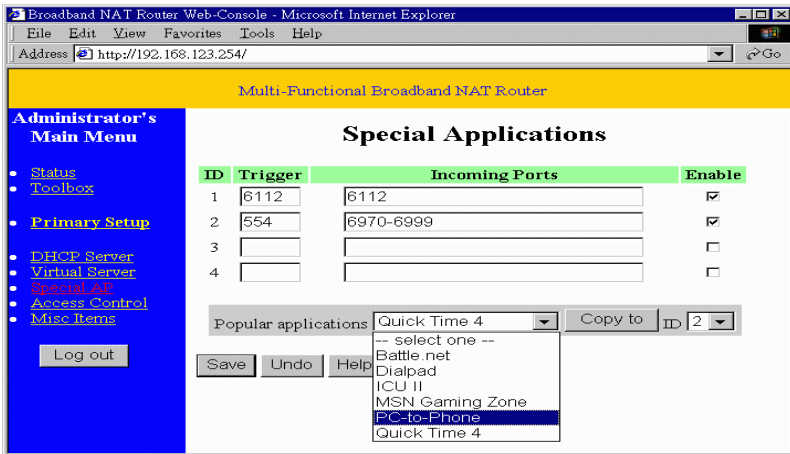

Some applications require multiple connections, like Internet games, Video conferencing, Internet telephony and so on. Due to the firewall function, these applications can not work with pure NAT router. Special Applications makes some of these applications to work with NAT router. If Special Applications is still insufficient to allow an application to function correctly, try DMZ host in the *Misc Items* options.

1. **Trigger**: the outbound port number the application issued first.
2. **Incoming Ports**: when the trigger packet is detected, the inbound packets to the specified port numbers are allowed to pass the firewall.

This product provides some predefined settings in the gray pad on the bottom of the web page. Choose the **Popular application** and click **Copy** to copy the predefined setting.

Note! At any time, only one PC can use each Special Application tunnel.

4.8 Access Control

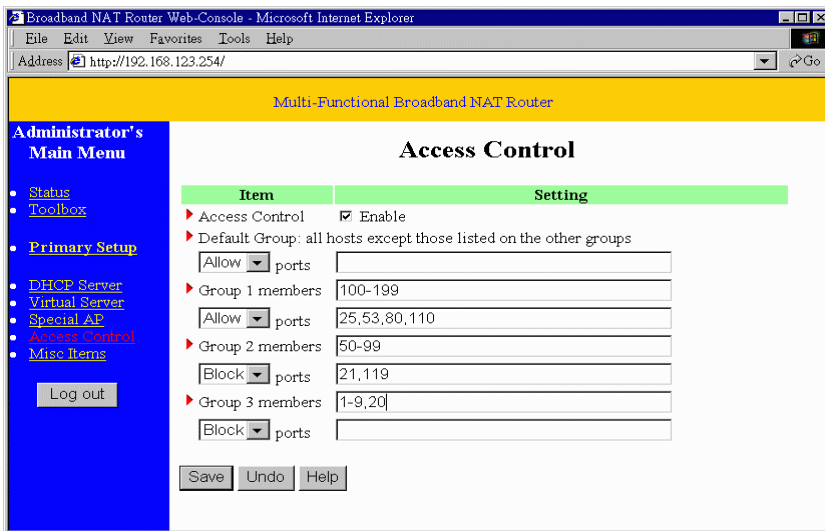

Access Control allows you to assign different access right for different users. First, you have to divide users into different groups. Users are identified by their IP addresses. You can assign the members of Group 1, 2 and 3. The others are all members of Default Group. Second, you have to assign the access right of each group. Access right can allow or block users to access specified TCP and UDP ports. For example:

Group	Members	Access Right	Comments
Default	-	Allow ()	No access right (allow nothing)
Group 1	100-199	Allow (25,53,80,110)	Can browse(80), receive(110) and send(25) email only
Group 2	50-99	Block (21,119)	Cannot read net news(119) and FTP(21) only
Group 3	1-9,20	Block ()	Fully access (block nothing)

4.9 Misc Items

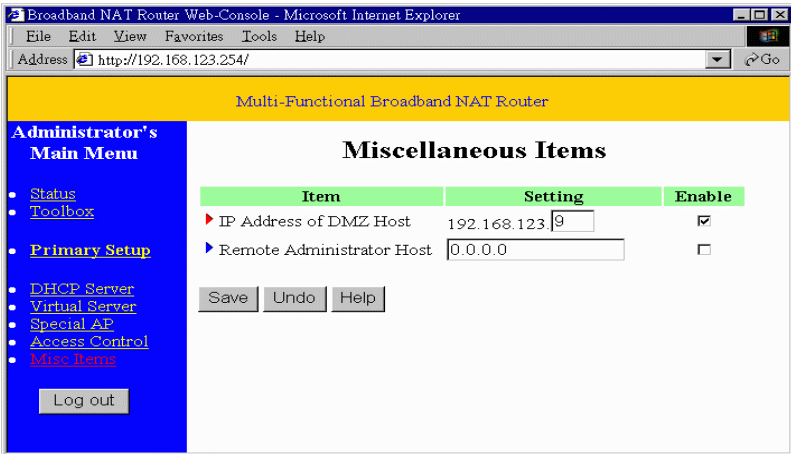

1. **IP Address of DMZ Host:** DMZ (DeMilitarized Zone) Host is a host without the protection of firewall. It allows a computer to be exposed to unrestricted 2-way communication. Note that, this feature should be used only when needed.
2. **Remote Administrator Host:** In general, only Intranet user can browse the built-in web pages to perform administration task. This feature enables you to perform administration task from remote host. If this feature is enabled, only the specified IP address can perform remote administration. If the specified IP address is 0.0.0.0, any host can connect to this product to perform administration task. When this feature is enabled, the web port will be shifted to 88.

Appendix A Console Mode

When you forget the system password or the IP address of this product, you need enter console mode to reset them.

Before invoking the console program, be sure to find a null modem cable and use it to connect from this product's COM port to your computer's COM port. Then, execute a terminal program, such as the *Hyper Terminal* of MS Windows 95. The connection parameters should be set to **19200 8-N-1**. And, reboot this product. When the M1 indicator starts flashing regularly, you can press the "**Enter**" key of the keyboard several times, there should be some messages and console prompt ">" appeared in the terminal.

In the console mode, you may reset the IP address and the system password of this product. Please remember to execute the **SR** command to save the changes you have made.

For example,

```
IP 192.168.123.254
```

```
PW admin
```

```
SR
```

Appendix B TCP/IP Configuration for Windows 95/98

This section introduces you how to install TCP/IP protocol into your personal computer. And suppose you have been successfully installed one network card on your personal computer. If not, please refer to your network card manual. Moreover, the Section B.2 tells you how to set TCP/IP values for working with this IP Sharer correctly.

B.1 Install TCP/IP protocol into your PC

1. Click **Start** button and choose **Settings**, then click **Control Panel**.
2. Double click **Network** icon and select **Configuration** tab in the Network window.
3. Click **Add** button to add network component into your PC.
4. Double click **Protocol** to add TCP/IP protocol.

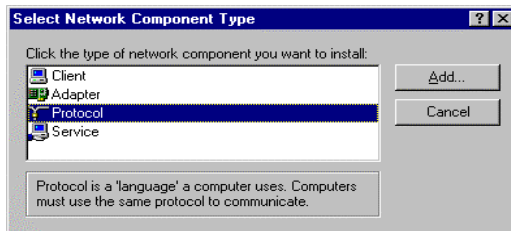

5. Select **Microsoft** item in the *manufactures* list. And choose **TCP/IP** in the *Network Protocols*. Click **OK** button to return to Network window.

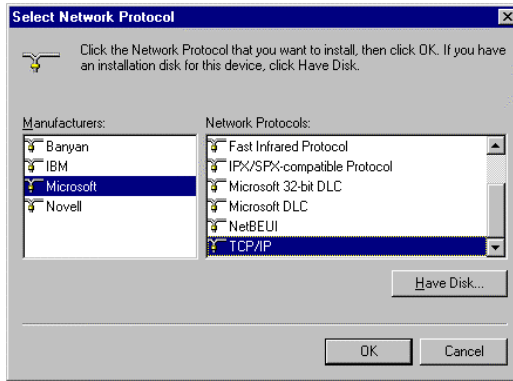

6. The TCP/IP protocol shall be listed in the Network window. Click **OK** to complete the install procedure and restart your PC to enable the TCP/IP protocol.

B.2 Set TCP/IP protocol for working with IP Sharer

1. Click **Start** button and choose **Settings**, then click **Control Panel**.

2. Double click **Network** icon. Select the TCP/IP line that has been associated to your network card in the **Configuration** tab of the Network window.

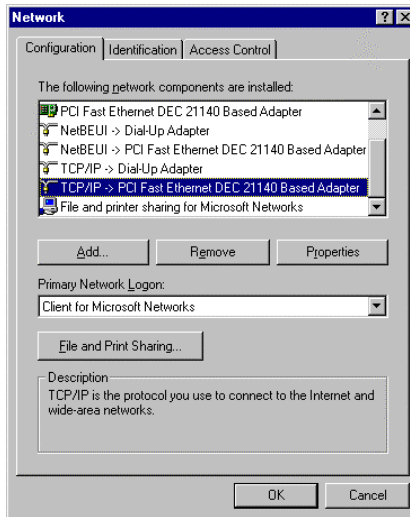

3. Click **Properties** button to set the TCP/IP protocol for this IP Sharer.
4. Now, you have two setting methods:
 - A. Get IP via DHCP server

- a. Select *Obtain an IP address automatically* in the *IP Address* tab.

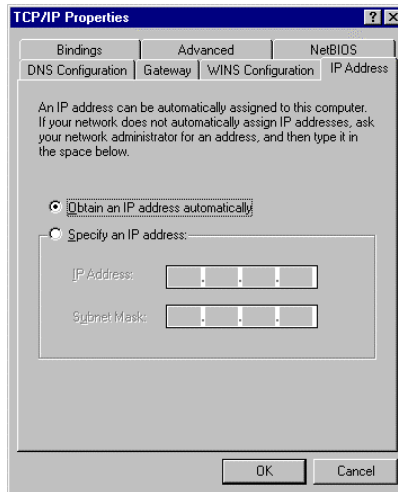

- b. Don't input any value in the *Gateway* tab.

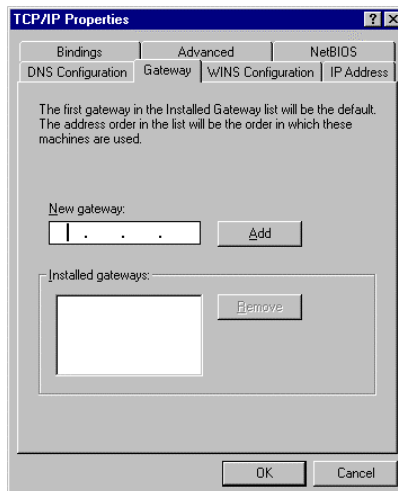

- c. Choose *Disable DNS* in the *DNS Configuration* tab.

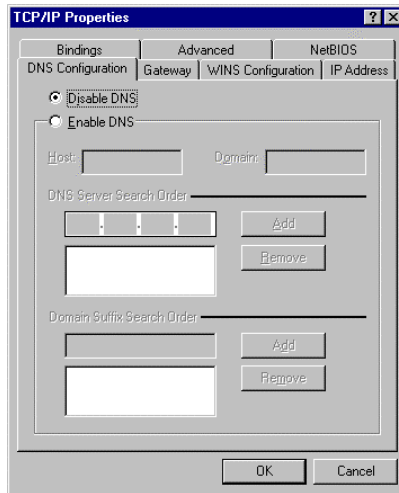

B. Configure IP manually

- a. Select ***Specify an IP address*** in the *IP Address* tab. The default IP address of this product is 192.168.123.254. So please use 192.168.123.xxx (xxx is between 1 and 253) for *IP Address* field and 255.255.255.0 for *Subnet Mask* field.

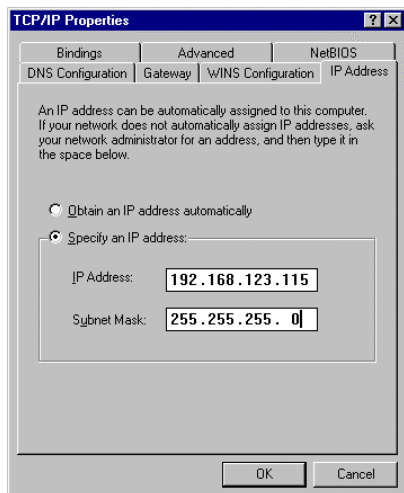

- b. In the *Gateway* tab, add the IP address of this product (default IP is 192.168.123.254) in the *New gateway* field and click **Add** button.

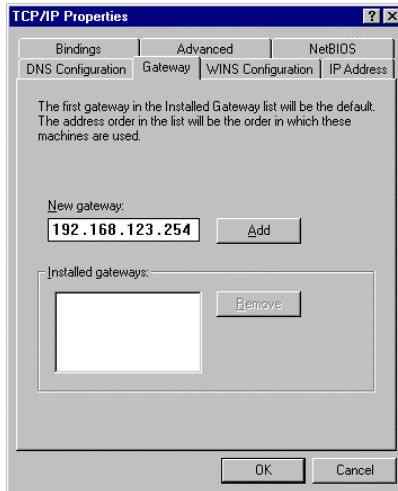

- c. In the *DNS Configuration* tab, add the DNS values which are provided by the ISP into *DNS Server Search Order* field and click **Add** button.

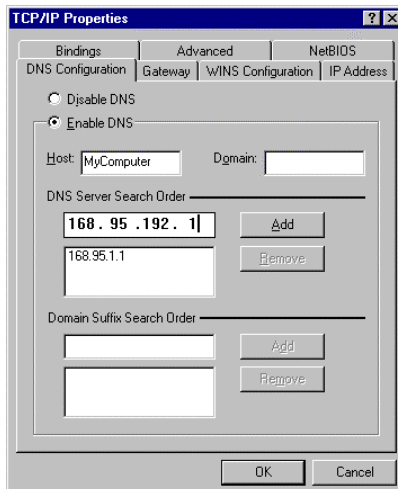

Free Manuals Download Website

<http://myh66.com>

<http://usermanuals.us>

<http://www.somanuals.com>

<http://www.4manuals.cc>

<http://www.manual-lib.com>

<http://www.404manual.com>

<http://www.luxmanual.com>

<http://aubethermostatmanual.com>

Golf course search by state

<http://golfingnear.com>

Email search by domain

<http://emailbydomain.com>

Auto manuals search

<http://auto.somanuals.com>

TV manuals search

<http://tv.somanuals.com>