

RP80

MODELING
GUITAR
PROCESSOR

 **Digitech**[®]
The Power to Create



User's Guide

Download from www.Somanuals.com. All Manuals Search And Download.

DECLARATION OF CONFORMITY

Manufacturer's Name: DigiTech
Manufacturer's Address: 8760 South Sandy Parkway
Sandy, Utah 84070 USA

declares that the product:

Product name: RP80

Product option: all (requires Class II power adapter that conforms to the requirements of EN60065, EN60742, or equivalent.)

conforms to the following Product Specifications:

Safety: IEC 60065 (1998)

EMC: EN 55013 (1990)
EN 55020 (1991)

Supplementary Information:

The product herewith complies with the requirements of the Low Voltage Directive 73/23/EEC and the EMC Directive 89/336/EEC as amended by Directive 93/68/EEC.

Vice-President of Engineering
8760 S. Sandy Parkway
Sandy, Utah 84070, USA
Date: January 23, 2004

European Contact: Your local DigiTech Sales and Service Office or

Harman Music Group
8760 South Sandy Parkway
Sandy, Utah 84070 USA
Ph: (801) 566-8800
Fax: (801) 568-7583

Warranty

We at **DigiTech** are very proud of our products and back-up each one we sell with the following warranty:

1. The warranty registration card must be mailed within ten days after purchase date to validate this warranty.
2. DigiTech warrants this product, when used solely within the U.S., to be free from defects in materials and workmanship under normal use and service.
3. DigiTech liability under this warranty is limited to repairing or replacing defective materials that show evidence of defect, provided the product is returned to DigiTech WITH RETURN AUTHORIZATION, where all parts and labor will be covered up to a period of one year. A Return Authorization number may be obtained from DigiTech by telephone. The company shall not be liable for any consequential damage as a result of the product's use in any circuit or assembly.
4. Proof-of-purchase is considered to be the burden of the consumer.
5. DigiTech reserves the right to make changes in design, or make additions to, or improvements upon this product without incurring any obligation to install the same on products previously manufactured.
6. The consumer forfeits the benefits of this warranty if the product's main assembly is opened and tampered with by anyone other than a certified DigiTech technician or, if the product is used with AC voltages outside of the range suggested by the manufacturer.
7. The foregoing is in lieu of all other warranties, expressed or implied, and DigiTech neither assumes nor authorizes any person to assume any obligation or liability in connection with the sale of this product. In no event shall DigiTech or its dealers be liable for special or consequential damages or from any delay in the performance of this warranty due to causes beyond their control.

NOTE: The information contained in this manual is subject to change at any time without notification. Some information contained in this manual may also be inaccurate due to undocumented changes in the product or operating system since this version of the manual was completed. The information contained in this version of the owner's manual supersedes all previous versions.

Introduction

Getting Acquainted

Congratulations on your purchase of the RP80. You now have the flexibility and power to produce sonic creations never before thought possible. Although the RP80 is so user friendly you may not even need to read this manual, we recommend that you become better acquainted with us, and what we have to offer by going through this User's Guide with your RP80 in front of you. It is your key to unlocking the potential within the RP80.

Included Items

Before you get started, please make sure that the following items have been included:

- **RP80**
- **PS200R Power Supply**
- **This Owner's Manual**
- **Warranty Card**

The Front Panel

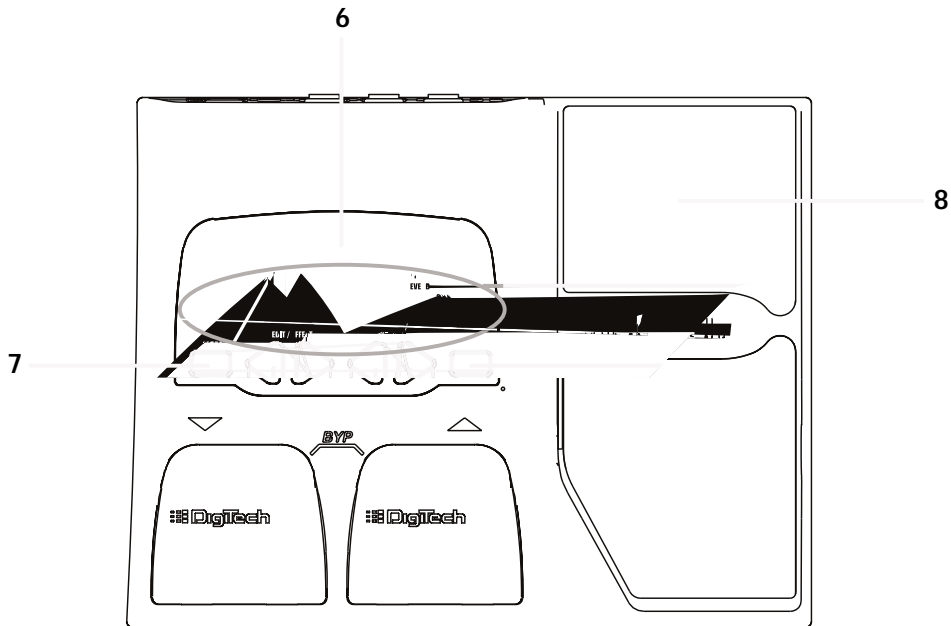

- 1. Footswitches** - These 2 Footswitches are used to select presets, access the Tuner, or bypass the RP80. The Up Footswitch increments, and the Down Footswitch decrements through the presets. Pressing both Footswitches simultaneously bypasses the selected preset. Pressing and holding both Footswitches accesses the Tuner.
- 2. Value/Volume Buttons** - The Value Buttons perform various value adjustment functions for the RP80. These buttons are used to control the RP80's Master Level, adjust a selected effect, and also change the Pattern, Tempo, and Level of the Drum machine when it is turned on. When the Tuner is enabled, these buttons select the tuning reference.
- 3. Effect/Edit Buttons** - Pressing either Edit buttons enters Edit mode and selects the individual effects to be edited. Press the left and right Edit buttons to move through the effects. Each effect LED will light to indicate which effect you are editing.
- 4. Drums** - The Drums button is used to turn on and off the RP80's drum machine. When the Drums feature is active, the Drums LED lights and the selected drum pattern plays continuously.
- 5. Effect LEDs** - The Effect LEDs provide information regarding the current preset. In Edit mode, the LEDs indicate the effect selected for editing. In Tuner mode, the LEDs indicate whether the note played is sharp, flat, or in tune.

6. **Display** - The Display provides information for different functions depending on the selected mode. In Play mode, the display shows the selected preset number. In Edit mode, the display shows the value of the parameter being adjusted. When the Tuner is enabled, the display shows the note played.
7. **Store** - The Store button saves your custom edits to the user presets.
8. **Expression Pedal** - The Expression Pedal adjusts RP80's Volume or the assigned Effect Parameter in real time. Almost every Parameter is available for Expression Pedal control.

Rear Panel

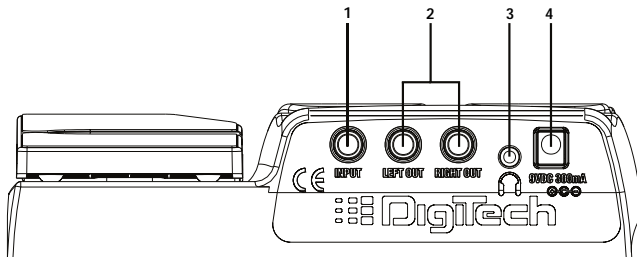

1. Input - Connect your instrument to this jack.

2. 1/4" Outputs - Connect these outputs to your amplifier or direct to a mixing console that accepts 1/4" unbalanced connections. Use the Left Output for all mono applications.

Note: When using the RP80 direct into a mixer or recording device, or when using it with headphones, you can enable the Global Cabinet Modeling feature to emulate speaker simulation on each of the RP80's presets. (See Page 23 for more on Global Cabinet Modeling.)

3. Headphone Output - Connect a pair of stereo headphones to this 1/8" jack.

4. Power Input - Connect only the DigiTech PS200R power supply to this jack.

Download from [Www.Somanuals.com](http://www.Somanuals.com). All Manuals Search And Download.

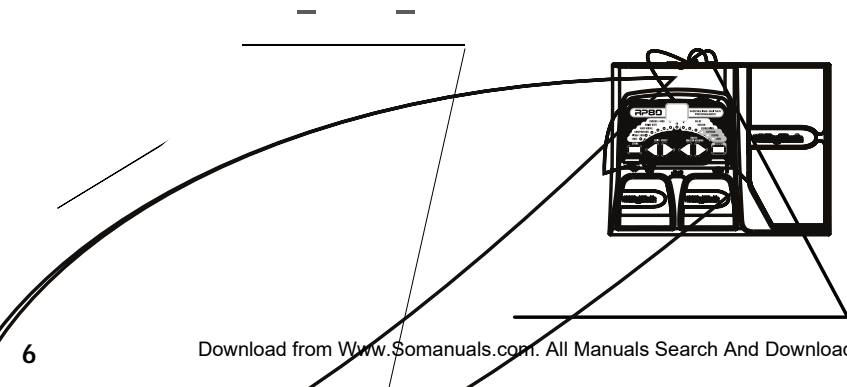

Stereo Operation

For stereo operation connect your guitar to the Input of the RP80. Connect from the RP80's Left/Mono Output to the input of one amplifier or to a channel input of a mixing console. Connect from the RP80's Right Output to a second amplifier, or to a second channel of a mixing console. If connecting to a mixing console, set the pan controls of the mixer hard left and right to retain stereo separation. To emulate a guitar cabinet sound when using the RP80 with a mixer or headphones, you can enable Global Cabinet Modeling (see page 23).

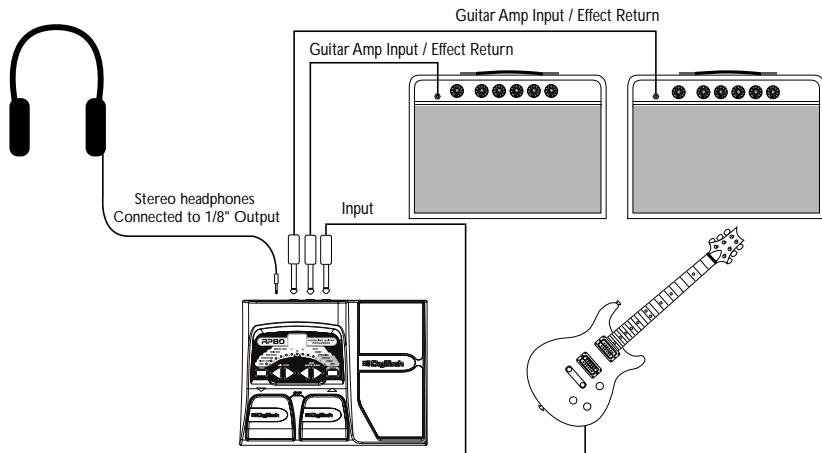

Applying Power

There are two options for powering the RP80: battery power, and the included PS200R DC power supply. Before applying power to anything, set your amp(s) to a clean tone and set the tone controls to a flat EQ response (on most amps, this would be 0 or 5 on the tone controls).

Battery Power

The RP80 can be run for more than 15 hours on 6 AA batteries. The battery compartment is located on the bottom of the RP80. The following diagram shows how to install the batteries.

Note: Pay close attention to the battery polarity when installing batteries as polarity changes direction for each pair.

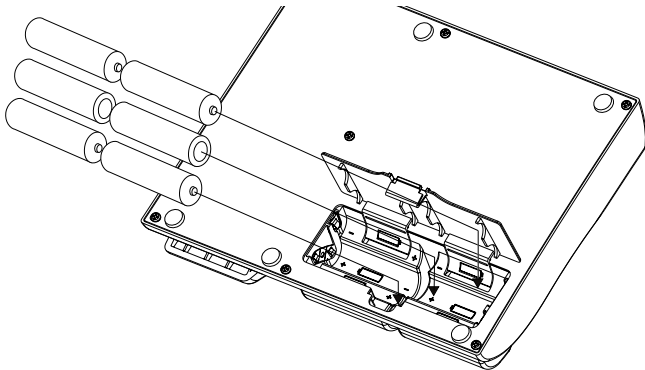

Connecting a cable to the Input applies power to the RP80. Disconnecting your instrument from the Input of the RP80 disconnects the battery power. Turn your amplifier(s) on and adjust the volume(s) to a normal playing level. To prolong the battery life, disconnect your instrument from the RP80's Input when not in use .

AC Power

The RP80 can also be powered with the included PS200R power supply. Connect the plug of the PS200R power supply to the power jack on the rear panel of the RP80. Connect the other end of the PS200R power supply to an AC outlet. Turn your amplifier(s) on and adjust the volume(s) to a normal playing level.

About the RP80

The Presets

Presets are numbered locations of programmed sounds. Presets are recalled with the Footswitches. The RP80 comes with 40 User Presets (Presets 1-40) and 40 Factory Presets (Presets 41-80). The User Presets are locations where you may store presets you create. The Factory Presets may not be saved over. From the factory, the 40 User Presets are exact duplicates of the 40 Factory Presets. This lets you make your own presets without the worry of losing any Factory Presets.

Tuner

The Tuner in the RP80 lets you quickly tune or check the tuning of your guitar. Enter the Tuner by pressing and holding both Footswitches simultaneously. The $E\sqcup$ briefly displays indicating that you are in Tuner mode. To begin tuning, play a note on your guitar (the neck pickup usually works best). The display shows the note being played. The Effect LEDs indicate whether the note is sharp or flat. The right 6 red LEDs indicate the note is sharp and should be tuned down. The left 6 red LEDs indicate the note is flat and should be tuned up. The center Green LED indicates the note is in tune. Output is muted in Tuner mode but you can rock the Expression Pedal to unmute and adjust the guitar volume.

The display shows the note played.

LEDs to the left
of the EQ LED
indicate the note is flat.

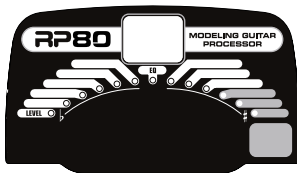

LEDs to the right
of the EQ LED
indicate the note is sharp.
10

When the Tuner is enabled, you can change your tuning reference. The default factory setting is A=440 Hz. (displayed as 40). Press the Value Buttons to select alternate dropped tunings. Alternate tunings are A = Ab (displayed as $\bar{A}b$), A = G (displayed as \bar{G}), and A = Gb

The Effect LEDs

When editing a preset, the Effect LEDs are used to indicate which effect is selected for editing. The Edit buttons move you through the Effect modules. The LEDs light indicating which effect group is selected. Each effect has multiple settings to select from. The Value buttons are used to change the value for the selected effect. As a button is pressed, the value or status is shown in the display.

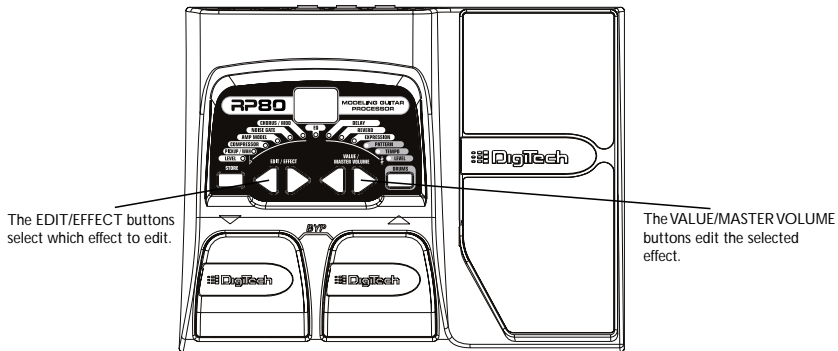

When the stored value of an effect is changed, the lower right decimal point in the display lights indicating you need to store the changes. Changing presets, or turning the power off before storing any changes will erase any changes made and revert to the stored values for the preset.

Storing/Copying a Preset

Once the preset has been modified, you may store your settings to one of the 40 User Preset locations (Presets 1-40). The following steps outline how to store changes to a preset or copy a preset to a different location:

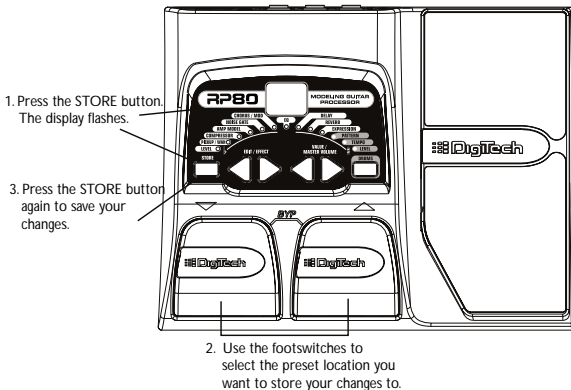

1. Press the **STORE** button once. The current preset location flashes in the display.
2. Press the **FOOTSWITCHES** to select the User Preset location.
- 3 Press the **STORE** button again to save the changes.

Effect Definitions

The RP80 can be thought of as several different “virtual” amplifiers, and individual hi-tech effects. Each effect within the RP80 can be programmed to suit your personal application. Understanding how these effects alter the sound helps you achieve the sound you are looking for. The following overview of the RP80’s effects outlines what each effect does.

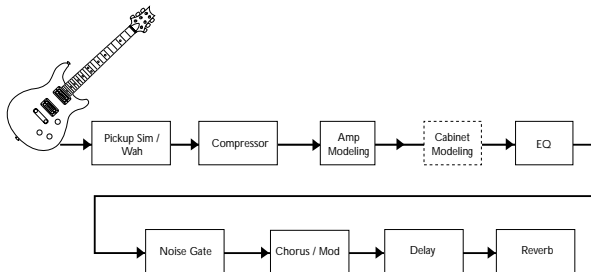

Preset Level

Controls the individual level for each preset. Because this setting is individual to each preset, you may adjust the volume when using louder or softer amp models.

Pickup/Wah

The Pickup Simulator gives the thick tone of a humbucker pickup from a guitar with single coil pickups, or the bright edgy sound of a single coil pickup from a guitar with a humbucker. Wah is an effect controlled by an expression pedal making the guitar sound as if it’s saying “Wah.”

Pickup/Wah Type - The Value buttons select the Pick Up or Wah type that is simulated.

0F - Turns the Pickup Simulator / Wah module off.

5H - Gives a single coil pick up the warm tone of a humbucker.

H5 - Gives a humbucker the unique sound of a single coil.

Cr - Cry Wah is a traditional sounding Wah.

b0 - Boutique Wah is a wider sweeping Wah with a more modern sound.

Fr - Full Range Wah sweeps the entire spectrum of audible frequencies.

Compressor

A Compressor is used to automatically limit the dynamic level of the guitar signal.

1 to *15* - Controls the amount of compression (ratio and sustain) and ranges from 1 (slight compression) through infinity (maximum sustain) or turns the compression effect off.

Amp/Cabinet Modeling

Amp Modeling is a technology that applies the tones of several popular modern and vintage amps and acoustic guitar simulation. Values 1-9 increase the amp's gain and level.

b 1-b9 - Based on a Blackface

0 1-09 - Based on Boutique

r 1-r9 - Based on a Rectifier

H 1-h9 - Based on a Hot Rod

t 1-t9 - Based on a Classic Tweed

l 1-l9 - Based on a British Combo

c 1-c9 - Based on a Clean Tube amp

S 1-S9 - Based on a British Stack

U 1-U9 - A nice crunchy tube combo

G 1-G9 - Based on High Gain tube amp

F 1-F9 - A vintage fuzz distortion

AC - A flat top acoustic guitar

EQ

Equalization is used to shape the tonal response of your guitar signal. The EQ in the RP80 is similar to the tone knobs on an amplifier. Values 1-4 cut the level of each band, 5 is flat (no cut or boost), and values 6-9 boost the level of each band.

Bass (b 1- b9) - The Value buttons adjust the amount of low end enhancement (Bass).

Mid (d 1- d9)- The Value buttons adjust the amount of mid range enhancement.

Treble (t 1- t9)- The Value buttons adjust the amount of high end enhancement (Treble).

Noise Gate

A Noise Gate is designed to eliminate noise while you are not playing. The AutoSwell setting creates a volume pedal effect automatically with varying attack times. Different guitars and pickups require different threshold settings. Choose a setting that fully mutes the sound when you are not playing for the lowest setting.

0F. G 1- G9 - Selects the Silencer™ Noise Gate. Settings 1-9 select the threshold. 0F turns the gate effect off.

S 1- S9 - Selects the Auto Swell volume swell effect. Settings 1-9 select the attack time.

Chorus/Mod

The Chorus/Mod module is a multi-function module that lets you select the following effects: Chorus, Flanger, Phaser, Tremolo, Panner, Vibrato, Rotary Speaker, YaYa™, AutoYa™, Envelope, Detune, Pitch Shift, and Whammy™ effects. When the Chorus/Mod module is selected, the Value buttons are used to choose the type of effect. Only one of the effects in this row can be used at a time. The following list describes each effect and their parameters in more detail.

Chorus (C 1-C9)

A Chorus adds a short delay to your signal. The delayed signal is modulated in and out of tune and then mixed back with the original signal to create a thicker sound, and stereo image. Use the Value buttons to select one of the nine Chorus settings.

Flange (F 1-F9)

A Flanger uses the same principle as a Chorus but uses a shorter delay time and adds regeneration (or repeats) to the modulating delay. This results in an exaggerated up and down sweeping motion to the effect. Use the Value buttons to select one of the nine Flanger settings.

Phaser (P 1-P9)

A phaser splits the incoming signal, and changes the phasing of the signal. The signal is taken in and out of phase and mixed back in with the original signal. As the phasing changes, different frequencies get canceled resulting in a warm sort of twisting sound. Use the Value buttons to select one of the nine Phaser settings.

Tremolo (T 1-T9)

A Tremolo effect modulates the volume of the signal at an even rate. Use the Value buttons to select one of the nine predetermined settings.

Panner (n 1-n9)

An Auto Panner modulates the sound from left to right at an even rate. Use the Value buttons to select one of the nine Panner settings.

Vibrato (b 1-b9)

A Vibrato effect modulates the pitch of the incoming signal at an even rate. Use the Value buttons to select one of the nine Vibrato settings.

Rotary Speaker (r 1-r9)

Rotary Speaker is an emulation of a device that included a spinning horn and woofer. The rotation of these two speakers produces an interesting combination of sound panning from side to side with a slight pitch change produced from the speed of the sound coming towards, and then going away from the listener. Use the Value buttons to select one of the nine Rotary Speaker settings.

YaYa™ (y 1-y9)

The YaYa™ is another effect exclusive to DigiTech products. Like the AutoYa™, it combines the characteristics of a wah and a flanger together providing a unique talk box type of effect, but is controlled by the Expression Pedal.

AutoYa™ (A 1-A9)

An AutoYa™ combines the characteristics of a Wah and a Flanger together creating an almost human vowel characteristic as if the guitar were saying "Yah." The AutoYa™ provides animation to the sound based on string attack. Use the Value buttons to select one of the nine AutoYa™ settings.

Envelope Filter (E 1-E9)

The Envelope Filter is a dynamic Wah effect that alters your sound based upon how hard you play. Use the Value buttons to select one of the nine Envelope Filter settings.

Detune (d 1-d9)

A Detuner makes a copy of your incoming signal, takes the copied signal slightly out of tune from the original, and mixes the two signals together. The result is a doubling type of effect as if two guitars were playing the same part together. Use the Value buttons to select one of the nine Detuner settings.

Pitch Shift (H 1-H9)

The Pitch Shifting copies the incoming signal, and shifts the pitch of the copy to a different note. The shifted note is mixed back with the original signal sounding as if two guitars were playing different notes. Use the Value buttons to select one of the nine Pitch Shift settings. The Pitch Shift settings are as follows:

H 1= -12 semitones	H 4= -4 semitones	H 7= +5 semitones
H 2= -7 semitones	H 5= +3 semitones	H 8= +7 semitones
H 3= -5 semitones	H 6= +4 semitones	H 9= +12 semitones

Whammy™ (h 1-h9)

Whammy™ is an effect that uses an Expression Pedal to bend the pitch of the incoming signal, or add a bendable harmony with the original signal. As the Pedal is moved, the note bends either up or down. Use the Value buttons to select one of the nine Whammy™ settings. **W** denotes Whammy bends and **H** denotes harmony bends. The Whammy settings are as follows:

h 1= W Octave Up	h 4= W 2 Octaves Down	h 7= H 3rd/4th Up
h 2= W 2 Octaves Up	h 5= H m3rd/Maj 3rd Up	h 8= H Octave Up
h 3= W Octave Down	h 6= H 2nd/Maj 3rd Up	h 9= H Octave Down

Delay

The RP80 has 3 different delay types, Mono (d), Analog (A), and Ping Pong (P), each with 2 seconds of delay time available. There are two different parameters used to program the delay, Delay Variation and Time. The first parameter of the delay effect is Delay Type/Variation, which selects the delay type to be used and varies the amount of feedback (number of repeats) and level. The second delay parameter is Delay Time. This is indicated by a value 1-99 (10ms-990ms), 1.0 and 2.0 (1 and 2 seconds respectively) in the display when the Delay LED is lit. Delay settings are as follows:

d, A, P 1=5% fback, level 15	d, A, P 4=5% fback, level 30	d, A, P 7=5% fback, level 50
d, A, P 2=25% fback, level 15	d, A, P 5=25% fback, level 30	d, A, P 8=25% fback, level 50
d, A, P 3=50% fback, level 15	d, A, P 6=50% fback, level 30	d, A, P 9=50% fback, level 50

Reverb

Using reverb in recorded program material gives the listener a sense that the material is being performed in an actual room or hall. It is this similarity to actual acoustic spaces that makes reverberation a useful tool in recorded music. Use the Value buttons to select one of the nine predetermined settings. The higher numbers indicate there is more reverb level. The reverb settings are as follows:

r 1-F9 = Room	□ 1-□9=Church
H 1-H9 - Hall	A 1-A9 = Arena
P 1-P9 - Plate	S 1-S9 - Spring

Other Functions

Expression Pedal

The Expression Pedal on the RP80 can be assigned to control the Volume, Wah, Whammy™, Ya Ya™, or one of several other parameters in real time with your foot. When a parameter has been assigned to the Expression Pedal, a programmable minimum and maximum value can also be assigned. The procedure for assigning a parameter to the Expression Pedal is as follows:

1. Press the Right **EDIT/EFFECT** button until the Expression LED in the Effects Row flashes. An effect LED will also light indicating which effect the expression pedal is currently assigned to.
2. Press either one of the **VALUE/MASTER VOLUME** buttons until your desired effect's LED is lit in the Effects Row. The Expression LED will continue to flash during your selection and the Display will show a two-digit mnemonic character value to describe the effect parameter that the expression pedal is assigned to. Your choices include:

No Assignment	--	
Volume*	OL	(Output Level)
Wah	RH	(Expression Pedal acts as a Wah pedal)
Amp	GR	(Expression Pedal controls the Amp Gain)
Chorus	SP	(Speed) LE (Level)
Flanger	SP	(Speed) LE (Level)
Phaser	SP	(Speed) LE (Level)
Tremolo	SP	(Speed) dP (Depth)

- * The Volume assignment makes the Expression Pedal behave like a true volume pedal, meaning any preset linked to volume will have its output level updated automatically depending on the pedal's position when the preset is selected.

Panner	<i>SP</i> (Speed)	<i>dP</i> (Depth)
Vibrato	<i>SP</i> (Speed)	<i>dP</i> (Depth)
Rotary	<i>SP</i> (Speed)	<i>dP</i> (Depth)
YaYa™	<i>Pd</i> (Expression Pedal acts as a YaYa Effect when engaged)	
AutoYa™	<i>SP</i> (Speed)	<i>dP</i> (Depth)
Envelope Filter	<i>ES</i> (Sensitivity)	
Detune	<i>LE</i> (Level of the Detuned signal)	
Pitch Shift	<i>LE</i> (Level of the Pitch Shifted signal)	
Whammy™	<i>hH</i> (Expression Pedal acts as a Whammy pedal)	
Delay	<i>dL</i> (Delay Level)	<i>dF</i> (Delay Feedback - 99 = Infinite Repeat*)
Reverb	<i>rL</i> (Reverb Level)	

3. After selecting the parameter to be linked to the pedal, you can set the minimum and maximum control range for that parameter. A newly assigned parameter's default range will be 1 to 99. To modify this range, do the following:

- A. Press the Right **EDIT/EFFECT** button. The Display will flash between *HE* (heel) and the current maximum value. Select the desired value for the heel back position by pressing either of the left or right **VALUE/ MASTER VOLUME** buttons.
- B. Press the Right **EDIT/EFFECT BUTTON** once more and the Display will flash between *ED* (toe) and the current maximum value. Select the desired value for the toe down position by pressing either the left or right **VALUE/MASTER VOLUME** buttons. (The value range for all assignable parameters is 1-99)

4. Store your Expression Pedal assignment values to your Preset. Storing a preset also saves the current pedal position. See page 13 for information on the storing procedure.

* Infinite Repeat creates a playback loop of whatever signal was played into the delay.

Download from [Www.Somanuals.com](http://www.Somanuals.com). All Manuals Search And Download.

Drum Machine

The RP80 includes several sampled drum patterns that are useful for developing a good sense of timing. Press the **DRUMS** button to enter Drums mode and start playback of the drum loop (except when in Store or Bypass mode). In Drums mode, the Edit buttons selects the drum Pattern, Tempo, and Level of the drum loop. Press the Drums button again to stop playback of the drum loop.

Global Cabinet Modeling

The RP80 includes cabinet modeling that can be enabled on all presets when running it into a mixer, recording device, or when using it with headphones. This feature emulates a speaker cabinet connected to each of the amp models in all presets. Each amp model has a specific cabinet model that optimizes its sound when using the RP80 in this manner. To enable Cabinet Modeling:

1. Press and hold the **DRUMS** button when applying power to the RP80. Wait until the display reads $\text{CAB} \text{ ON}$. Release the **DRUMS** button.

Cabinet Modeling is now enabled for all amp models in all presets. The following lists what cabinet accompanies each model:

- b** 1-b9 – Blackface – 2x12 Cabinet
- o** 1-o9 – Boutique – Vintage 4x12 Cabinet
- r** 1-r9 – Rectifier – Vintage 4x12 Cabinet
- H** 1-H9 – Hot Rod – British 4x12 Cabinet
- t** 1-t9 – Classic Tweed – 2x12 Cabinet
- C** 1-C9 – British Combo – 2x12 Cabinet

- C 1-C9 – Clean Tube – British 4x12 Cabinet
- S 1-S9 – British Stack – British 4x12 Cabinet
- U 1-U9 – Crunch – Vintage 4x12 Cabinet
- G 1-G9 – High Gain Tube – British 4x12 Cabinet
- F 1-F9 – Fuzz – British 4x12 Cabinet

Factory Reset

This function resets the RP80 to its original factory settings. This procedure erases all custom user presets. **Performing this function erases all user-programmed data. All such data will be lost forever!**

The procedure for performing a Factory Reset is as follows:

1. Disconnect the power supply from the RP80 (AC Power) or unplug the guitar from the input jack (battery power).
2. Press and hold the left **EDIT** button while re-connecting the power or plugging your guitar into the RP80's input.
3. When the display reads --, release the button and press the **STORE** button. The display reads rE. The RP80 is now restored to its factory settings.

Expression Pedal Calibration

The Expression Pedal on the RP80 needs to be recalibrated for use after a factory reset has been performed. This calibration procedure is automatically entered after a factory reset procedure. In the event the Pedal's calibration fails, or if the Pedal does not function properly, it can be re-calibrated using the Pedal Calibration procedure. This will not erase the User Presets. The procedure for Calibrating the Expression Pedal is as follows:

1. Disconnect the PS200R power supply from the power jack on the RP80.
2. Press and hold the **Down Footswitch** while re-connecting the power.
3. Continue to hold the **Down Footswitch** until the **Display** reads E_C .
4. Rock the **Expression Pedal** back to the toe up position (**Display** will read UP).
5. Press the **Up Footswitch** and the **Display** now shows dn .
6. Rock the **Expression Pedal** forward to the toe down position.
7. Press the **Down Footswitch**. The RP80 will return to the last selected Preset and the Expression Pedal is now calibrated.

Note: If the Display shows E_r , an error has occurred and steps 4 through 7 should be repeated.

Appendix

Specifications:

Input: 1/4" input

Outputs: (2) 1/4" (unbalanced)

Headphone Output: 1/8" stereo output

A/D/A: 24 bit Delta Sigma

Power Supply: 6 AA Batteries or DigiTech PS200R (9VDC) power supply

Power Consumption: 5 Watts Maximum (w/ PS200R power supply)

Battery Life: >15 hours with continuous useage

Memory: 40 User/40 Factory Presets

Effects: Pickup Simulator, Wah, Compressor, 11 Amp Models, Acoustic Guitar Simulator, 3 band EQ, Noise Gate, Cabinet Modeling, Chorus, Flange, Phaser, Tremolo, Panner, Vibrato, Rotary Speaker, Ya Ya™, Auto Ya™, Envelope Filter, Pitch Shift, Detune, Whammy™, Delay, and Reverb

Drum Machine: 30 Patterns

Simultaneous Effects: up to 9

Dimensions: 6.3" L x 8.125" W x 2.0"H (2.82"H with pedal in up position)

Weight: 1.34 lbs. (1.98 lbs. w/ power supply)

Preset List (User/Factory)

1/41	Stacked	21/61	Bad Dog
2/42	Recto Delay	22/62	Steely Phase
3/43	Clean Chorus	23/63	Rhythm Crunch
4/44	Octave Drive	24/64	Metal Scoop
5/45	Classic Blackface	25/65	Slap Rhythm
6/46	Crunchy Phase	26/66	20 Fathoms
7/47	Fuzz Church	27/67	Electro-Sitar
8/48	Grindy Detune	28/68	Smooth Drive
9/49	Big Boutique	29/69	Fuzzboy
10/50	Acoustic Chorus	30/70	Surfin'
11/51	Sustainium	31/71	Clean Flange
12/52	Rotary Blues	32/72	Thickerer
13/53	Wahtch It	33/73	Pedal Steel
14/54	Power Flange	34/74	Short Stack
15/55	Campfire Tremolo	35/75	Dirt Combo
16/56	Detune Tube	36/76	Triplet Chunk
17/57	Whammy Time	37/77	Roto Jazz
18/58	Mr. Guts	38/78	Acoustic 5ths
19/59	Ottowah	39/79	Ya Ya Sure
20/60	Volume Swell	40/80	Octavian

DigiTech
8760 South Sandy Parkway
Sandy, Utah 84070
PH (801) 566-8800
FAX (801) 566-7005

DigiTech® is a registered trademark
of the Harman Music Group Inc.

Copyright - Harman Music Group
Printed 1/2004

Made in USA

RP80 Modeling Guitar Processor
User's Guide 18-0277-A

Please visit DigiTech
on the World Wide Web at:
www.digitech.com

 A Harman International Company

Free Manuals Download Website

<http://myh66.com>

<http://usermanuals.us>

<http://www.somanuals.com>

<http://www.4manuals.cc>

<http://www.manual-lib.com>

<http://www.404manual.com>

<http://www.luxmanual.com>

<http://aubethermostatmanual.com>

Golf course search by state

<http://golfingnear.com>

Email search by domain

<http://emailbydomain.com>

Auto manuals search

<http://auto.somanuals.com>

TV manuals search

<http://tv.somanuals.com>