

DENSO

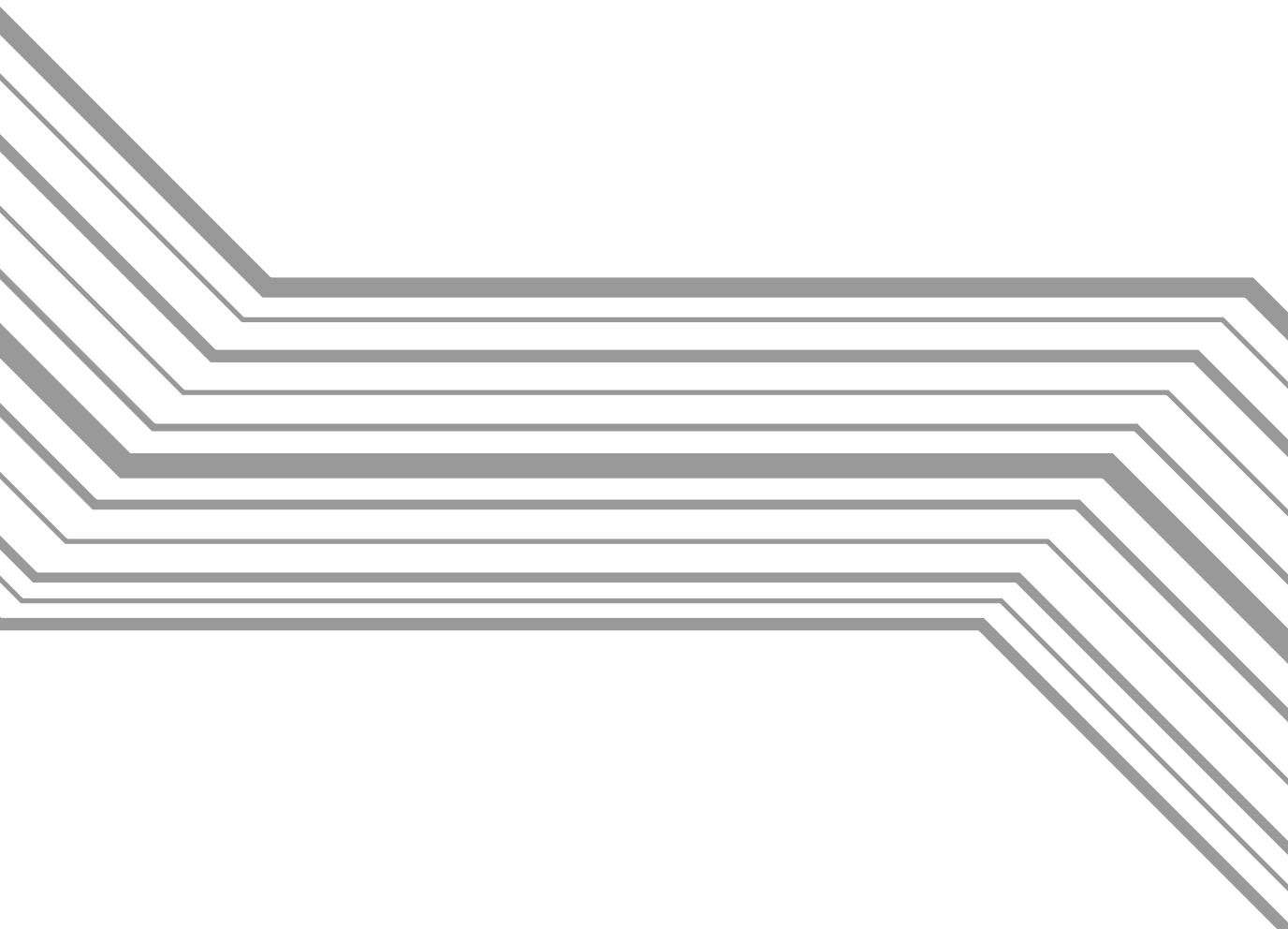

Bar Code Handy Terminal

BHT-7000

User's Manual

Copyright © DENSO, 2000

All rights reserved. No part of this publication may be reproduced in any form or by any means without permission in writing from the publisher.

Specifications are subject to change without prior notice.

All products and company names mentioned are trademarks or registered trademarks of their respective holders.

Preface

Please READ through these operating instructions carefully. It will enable you to operate your BHT-7000 correctly.

After you have finished reading the instructions, keep this manual handy for speedy reference.

How this book is organized

This manual is made up of five chapters and appendices.

Chapter 1. Quick Guide

Describes the basic operating method of the BHT-7000 and the related notes.

Chapter 2. Getting Started the BHT-7000 and System Mode

Summarizes the BHT-7000 system configuration and describes the operation including preparation and System Mode (which is required for the efficient use of application programs).

Chapter 3. Communications Operations of BHT-7000

Describes the communications operations of the BHT-7000--the RS-232C interface specifications, the basic communications specifications, and the communications protocols--for data transmission with the host computer or other devices.

Chapter 4. Error Messages

Lists the error messages which will appear on the LCD if some error occurs in the BHT-7000.

Chapter 5. Handling the CU-7000 (Option)

Describes the handling procedure of the CU-7000, the interfacing with the host computer, and the charging of the battery cartridge.

Appendix A: Specifications

Appendix B: Communications Protocol Details

Appendix C: A Typical Basic Operation

■ Technical Terms Used in This Manual

Source Program and Object Program (User Program)

Generally, a source program is translated into an object program by a compiler. This manual calls an object program a user program.

BHT-BASIC

This manual expresses BHT-BASIC3.0 and BHT-BASIC3.5 as BHT-BASIC.

■ Related Publications

BHT-BASIC Programmer's Manual

Transfer Utility Guide

Ir-Transfer Utility C Guide

Ir-Transfer Utility E Guide

■ Screen Indication

The lettering in the screens in this manual is a little different from that in the actual screens. File names used are only for description purpose, so they will not appear if you have not set files having those names.

SAFETY PRECAUTIONS

Be sure to observe all these safety precautions.

- Please READ through this manual carefully. It will enable you to use the BHT-7000 and CU-7000 correctly.
- Always keep this manual nearby for speedy reference.

Strict observance of these warning and caution indications are a MUST for preventing accidents which could result in bodily injury and substantial property damage. Make sure you fully understand all definitions of these terms and related symbols given below, before you proceed to the text itself.



WARNING

Alerts you to those conditions which could cause serious bodily injury or death if the instructions are not followed correctly.



CAUTION

Alerts you to those conditions which could cause minor bodily injury or substantial property damage if the instructions are not followed correctly.

Meaning of Symbols



A triangle (\triangle) with a picture inside alerts you to a warning of danger. Here you see the warning for electrical shock.



A diagonal line through a circle (\otimes) alerts you to something you should not do; it may or may not have a picture inside. Here you see a screwdriver inside the circle, meaning that you should not disassemble.



A black circle (\bullet) with a picture inside alerts you to something you MUST do. This example shows that you MUST unplug the power cord.

WARNING

Handling the battery cartridge

- Never disassemble or heat the battery cartridge, nor put it into fire or water; doing so could cause battery-rupture or leakage of battery fluid, resulting in a fire or bodily injury.



- Do not carry or store the battery cartridge together with metallic ball-point pens, necklaces, coins, hairpins, etc.

Doing so could short-circuit the terminal pins, causing the batteries to rupture or the battery fluid to leak, resulting in a fire or bodily injury.

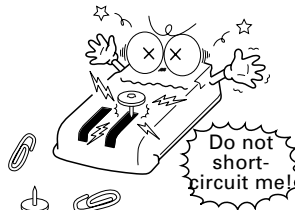

- Avoid dropping the battery cartridge or letting it undergo any shock or impact.

Doing so could cause the batteries to break, generate heat, rupture or burn.



- Only use the dedicated charger (CU-7000, C-700, or C-750) for charging the battery cartridge.

Using a different type of charger could cause battery-rupture or leakage of battery fluid and result in a fire, bodily injury, or serious damage to property.

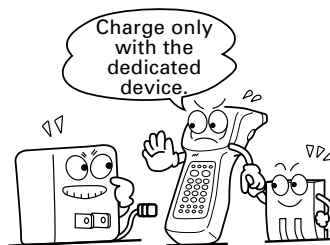

Undedicated

- Never charge the lithium-ion battery cartridge where any inflammable gases may be emitted; doing so could cause fire.



Handling the BHT

- The BHT-7000 uses a laser light for indicating the scanning range. The intensity of the laser light might be too low to inflict bodily injury. However, do not look into the laser beam.

The BHT-7000 complies with Laser Safety Standard, Class II of 21 CFR Chapter 1, Subchapter J.

The BHT-7000 does not mount beam attenuator and laser radiation emission indicator required by this standard. Instead, the software-controlled Magic keys (see Section 2.3 "Components and Functions") function as them because the laser light is not enabled without the Magic keys pressed.



CAUTION



LASER LIGHT-DO NOT STARE INTO BEAM

1mW MAXIMUM OUTPUT; 650nm LASER

CLASS II LASER PRODUCT

WARNING

- Do not look into the laser beam source through the reading window or point the reading window towards the eyes.

The laser beam emitted through the reading window is harmful to the eyes.

- Use of controls or adjustments or performance of procedures other than those specified herein may result in hazardous radiation exposure.

Handling the CU

- If smoke, abnormal odors or noises come from the CU, immediately unplug the AC adapter from the wall socket and contact your nearest dealer.

Failure to do so could cause fire or electrical shock.

- If foreign material or water gets into the CU, immediately unplug the AC adapter from the wall socket and contact your nearest dealer.

Failure to do so could cause fire or electrical shock.

- If you drop the CU so as to damage its housing, immediately unplug the AC adapter from the wall socket and contact your nearest dealer.

Failure to do so could cause fire or electrical shock.

- Never use the CU for charging anything other than the specified battery cartridges.

Doing so could cause heat, battery-rupture, or fire.

- Never bring any metals into contact with the output terminals.

Doing so could produce a large current through the CU, resulting in heat or fire, as well as damage to the CU.

- Use the dedicated AC adapter only. Failure to do so could result in fire.

- Never use the CU on the line voltage other than the specified level. Doing so could cause the CU to break or burn.

- If the power cord of the AC adapter is damaged (e.g., exposed or broken lead wires), stop using it and contact your nearest dealer.

Failure to do so could result in a fire or electrical shock.



CAUTION

Basic handling tips

- Never put the BHT in places where there are excessively high temperatures, such as inside closed-up automobiles, or in places exposed to direct sunlight.

Doing so could affect the housing or parts, resulting in a fire.

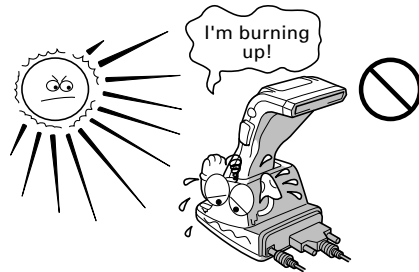

- Avoid using the BHT in extremely humid or dusty areas, or where there are drastic temperature changes.

Moisture or dust will get into the BHT, resulting in malfunction, fire or electrical shock.

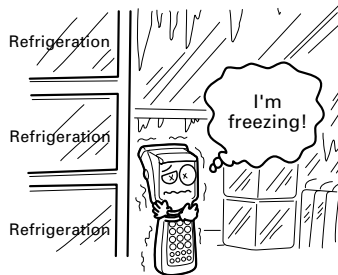
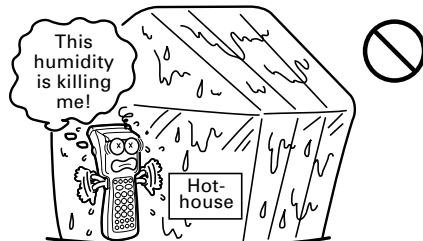

- Never disassemble or modify the BHT; doing so could result in an accident such as break or fire.



Handling the battery cartridge

- Never charge a wet or damp the lithium-ion battery cartridge.

Doing so could cause the batteries to break, generate heat, rupture, or burn.

Handling the BHT

- If smoke, abnormal odors or noises come from the BHT, immediately turn off the power, pull out the battery cartridge, and contact your nearest dealer.

Failure to do so could cause smoke or fire.



- If foreign material or water gets into the BHT, immediately turn off the power, pull out the battery cartridge, and contact your nearest dealer.

Failure to do so could cause smoke or fire.

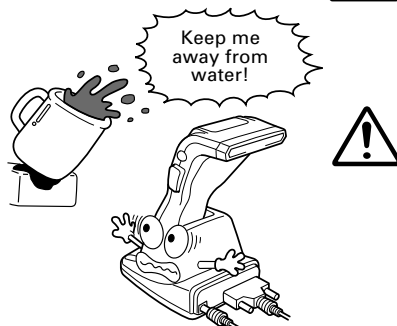

CAUTION

- If you drop the BHT so as to damage its housing, immediately turn off the power, pull out the dry batteries or the battery cartridge, and contact your nearest dealer.

Failure to do so could cause smoke or fire.



- For those machines using the dry battery cartridge, do not mistake the plus and minus marks when loading dry batteries into the cartridge.

Failure to do so could cause battery-rupture or leakage of battery fluid, resulting in bodily injury, fire, or property damage.



- For those machines using the dry battery cartridge, do not use anything other than the specified type of batteries, nor use new and old batteries together.

Doing so could cause battery-rupture or leakage of battery fluid, resulting in bodily injury, fire, or property damage.



- Do not use batteries or power sources other than the specified ones; doing so could generate heat or cause malfunction.



- In environments where static electricity can build into significant charges (e.g., if you wipe off the resin plate with a dry cloth), do not operate the BHT. Doing so will result in malfunction or machine failure.



- When connecting or disconnecting the direct-connect interface cable to/from the BHT, do not plug or unplug it at an angle and do not pull the cable strongly. Doing so will result in a machine failure.









- If the BHT has been stored in a hot (50°C to 60°C, 122°F to 140°F) and humid place, allow it to sit at room temperature and humidity for at least one day before use. Using the BHT with its inside being hot will fail to scan or result in a machine failure.



CAUTION

Handling the CU

- If you will not be using the CU for a long time, be sure to unplug the AC adapter from the wall socket for safety.
Failure to do so could result in a fire. 
- When caring for the CU, unplug the AC adapter from the wall socket for safety.
Failure to do so could result in an electrical shock. 
- Never cover or wrap up the CU or AC adapter in a cloth or blanket.
Doing so could cause the unit to heat up inside, deforming its housing, resulting in a fire.
Always use the CU and AC adapter in a well-ventilated area. 
- Do not place the CU anywhere where it may be subjected to oily smoke or steam, e.g., near a cooking range or humidifier.
Doing so could result in a fire or electrical shock. 
- Keep the power cord away from any heating equipment.
Failure to do so could melt the sheathing, resulting in a fire or electrical shock. 
- Do not insert or drop foreign materials such as metals or anything inflammable through the openings or vents into the CU.
Doing so could result in a fire or electrical shock. 

- DENSO WAVE INCORPORATED does not assume any product liability arising out of, or in connection with, the application or use of any product, circuit, or application described herein.

■ Intellectual Property Precaution

DENSO WAVE INCORPORATED ("DENSO WAVE") takes reasonable precautions to ensure its products do not infringe upon any patent or other intellectual property rights of other(s), but DENSO WAVE cannot be responsible for any patent or other intellectual property right infringement(s) or violation(s) which arise from (i) the use of DENSO WAVE's product(s) in connection or in combination with other component(s), product(s), data processing system(s) or equipment or software not supplied from DENSO WAVE; (ii) the use of DENSO WAVE's products in a manner for which the same were not intended nor designed; or (iii) any modification of DENSO WAVE's products by other(s) than DENSO WAVE.

■ Proper Care of the BHT and CU

Clean the housing and the battery cartridge terminals with a dry, soft cloth. Before cleaning, be sure to power off the BHT and unplug the AC adapter of the CU.

- Never use benzene, alcohol, or other organic solvents. The housing may be marred or the paint may come off.
- Never rub or strike the liquid crystal display (LCD) with anything hard. The LCD surface will be easily scratched or broken.
- When cleaning the keypad, do not scrub the surface too hard, and do not pull on the keys. Doing so may break the keys or cause the keypad to dislocate.
- If the BHT or CU becomes smudged, moisten a soft cloth with neutral detergent and wring it out thoroughly. Wipe the BHT or CU with the cloth and then go over it again with a dry cloth.



Dust or dirt accumulating on the clear plate of the bar-code reading window will affect reading performance. If you use the BHT in dusty areas, therefore, periodically check the clear plate of the bar-code reading window and clean it if dusty.

- To clean the plate, first blow the dust away with an air brush. Then wipe the plate with a cotton swab or the similar soft one gently.
- If sand or hard particles have accumulated, never rub the plate; doing so will scratch or damage it. Blow the particles away with an air brush or a soft brush.

■ Limited Warranty on Software Products

In no event will DENSO WAVE be liable for direct, indirect, special, incidental, or consequential damages (including imaginary profits or damages resulting from interruption of operation or loss of business information) resulting from any defect in the software or its documentation or resulting from inability to apply the software or its documentation.

FCC Regulations

This device complies with Part 15 of the FCC Rules.

Operation is subject to the following two conditions:

- (1) this device may not cause harmful interference, and
- (2) this device must accept any interference received, including interference that may cause undesired operation.

NOTE: This equipment has been tested and found to comply with the limits for a Class A digital device, pursuant to Part 15 of the FCC Rules. These limits are designed to provide reasonable protection against harmful interference when the equipment is operated in a commercial environment. This equipment generates, uses, and can radiate radio frequency energy and, if not installed and used in accordance with the instruction manual, may cause harmful interference to radio communications. Operation of this equipment in a residential area is likely to cause harmful interference in which case the user will be required to correct the interference at his own expense.

FCC WARNING: Changes or modifications not expressly approved by the party responsible for compliance could void the user's authority to operate the equipment.

Canadian Interference-Causing Equipment Regulations

This Class A digital apparatus complies with Canadian ICES-003.

Cet appareil numérique de la classe A est conforme à la norme NMB-003 du Canada.

Labeling

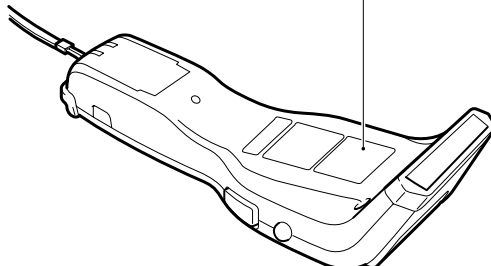
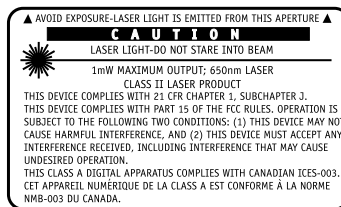

Content Overviews

Preface	i
How this book is organized	ii
SAFETY PRECAUTIONS	iv
Chapter 1. Quick Guide	1
1.1 Reading Bar Codes	2
1.2 Setting and Using the Hand Strap	3
1.3 Setting the Backlight	4
1.4 Using the Keypad	5
1.5 Communicating via the Optical Interface	6
Chapter 2. Getting Started the BHT-7000 and System Mode	7
2.1 BHT-7000 System Configuration	8
2.2 Infrared Communications	13
2.3 Components and Functions	15
2.4 Preparation	18
2.4.1 Setting-up 1: Loading the Battery Cartridge	18
2.4.2 Setting-up 2: Setting the Calendar Clock	22
2.4.3 Adjusting the LCD Contrast & Beeper Volume, Switching the Beeper & Vibrator, and Checking the Battery Voltage Level	24
2.4.4 Battery Replacement Notes	27
2.5 Initializing the BHT-7000 System	29
2.6 Operating in System Mode	33
2.6.1 Starting System Mode	33
2.6.2 Operating in System Mode	37
2.6.3 Detailed Description of the Functions in System Mode	39
Chapter 3. Communications Operations of BHT-7000	85
3.1 RS-232C Interface Specifications	86
3.2 Basic Communications Specifications and Parameters	88
3.2.1 Basic Communications Specifications	88
3.2.2 Communications Parameters	90
3.3 Communications Protocols	91
3.3.1 BHT-protocol	91
3.3.2 BHT-Ir Protocol	97

Chapter 4. Error Messages	103
4.1 System Errors	104
4.2 Errors in System Mode	110
Chapter 5. Handling the CU-7000 (Option)	115
5.1 Functions of the CU-7000	116
5.2 Components and Functions	116
5.3 Applying Power to the CU-7000	117
5.4 Communicating with the Host Computer.....	118
5.4.1 Setting the Transmission Speed of the CU-7000	118
5.4.2 Interface Cable Connection	118
5.4.3 Interfacing with the Host Computer	119
5.5 Charging the Lithium-ion Battery Cartridge (using the CU-7001)	120
5.6 RS-232C Interface Specifications	122
Appendices	125
Appendix A. Specifications	126
A.1 BHT-7000	126
A.2 CU-7000	131
Appendix B. Communications Protocol Details	133
B.1 BHT-protocol	133
B.2 BHT-lr protocol	143
Appendix C. A Typical Basic Operation	154

Chapter 1. Quick Guide —

Chapter 2. Getting Started the BHT-7000 and System Mode —

Chapter 3. Communications Operations of BHT-7000 —

Chapter 4. Error Messages —

Chapter 5. Handling the CU-7000 (Option) —

Appendices —

Chapter 1

Quick Guide

This chapter describes the basic operating method of the BHT-7000 and the related notes.

1.1	Reading Bar Codes	2
1.2	Setting and Using the Hand Strap	3
1.3	Setting the Backlight	4
1.4	Using the Keypad	5
1.5	Communicating via the Optical Interface	6

1.1 Reading Bar Codes

Turn on the BHT power, bring the bar-code reading window to the bar code to be scanned, and press the trigger switch. The BHT emits a laser light to indicate the scanning range and turns on the illumination LED to scan the bar code. Keep the BHT in a position where the bar code lies within the scanning range indicated by the laser light (marker).

When the BHT has read the bar code successfully, the indicator LED will illuminate in green.

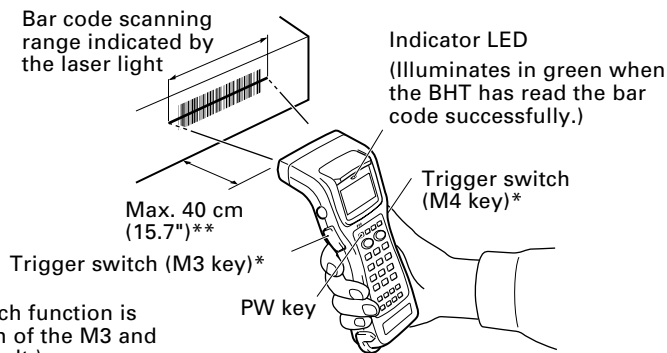

* The trigger switch function is assigned to both of the M3 and M4 keys by default.)

- If the BHT fails to read due to specular effects or other factors, change the scanning angle of the reading window or the distance from codes as shown at right, and try it again. (Specular effects occur when the reflection of the light from the bar code becomes excessively strong. This can easily happen when the reflecting surface is polished or covered with vinyl.)

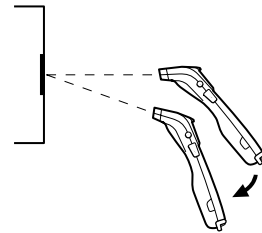

- The laser light indicates the scanning range as a guide. The indicated scanning range will deviate a little bit from the actual one. Keep the BHT so that the laser light comes to almost the center of the bar code height.
- The BHT can read bar codes at a maximum distance of 40 cm (15.7'')** from the bar-code reading window. (**For details about the scanning conditions, refer to the Appendix A.)

NOTE

- Before reading bar codes, clean those labels if stained.
- Avoid using the BHT in direct sunlight. The BHT might fail to read correctly.
- To read bar codes on curved surfaces, apply the BHT to the target bar code so that the code comes to the center of the scanning range indicated by the laser beam.
- When you pull the bar-code reading window away from the bar codes, the actual scanning range will become narrower than the range covered by the laser beam.

TIP

- The light intensity of the laser light or illumination LED will vary depending upon the scanning conditions and variation of their elements.

1.2 Setting and Using the Hand Strap

■ Setting the hand strap

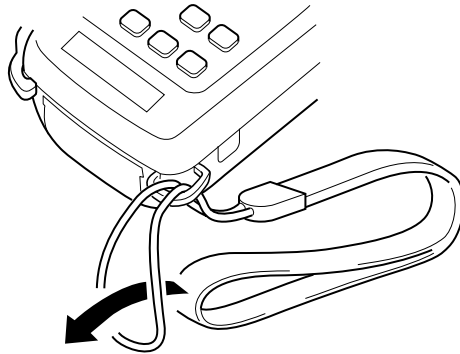

■ Using the hand strap

Put your hand through the hand strap and hold the BHT as shown below. This will prevent you from dropping the BHT accidentally.

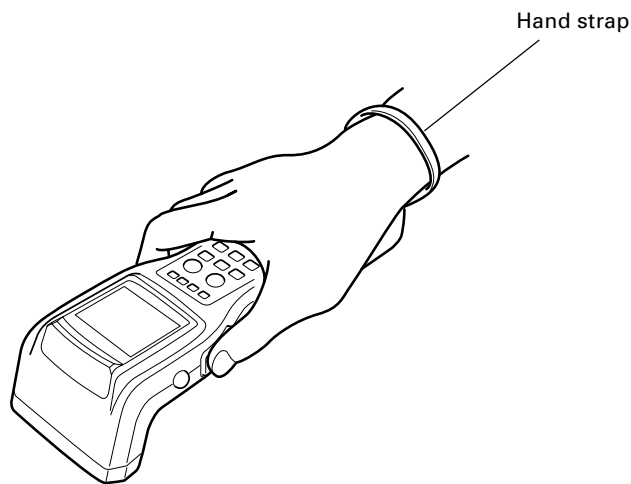

1.3 Setting the Backlight

Pressing the **M1** key while holding down **SF** (Shift) key activates or deactivates the backlight function.

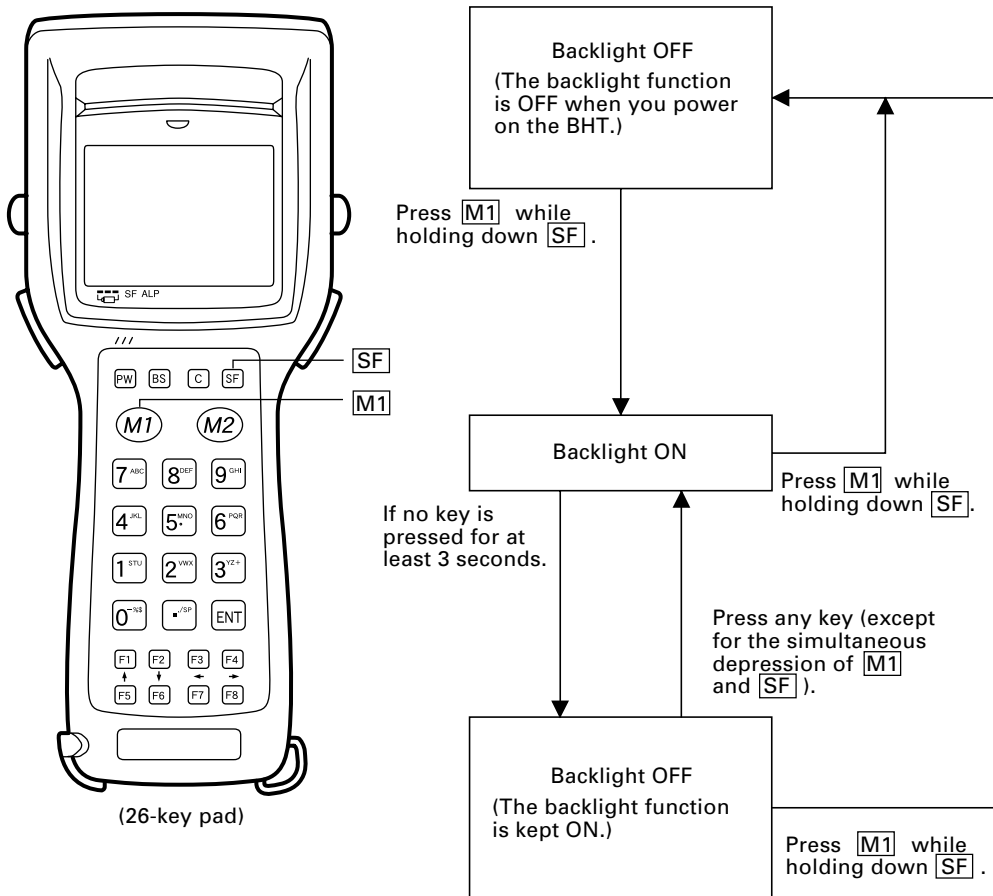

NOTE

In user programs, you can select the key to be used for activating or deactivating the backlight function (instead of the initial setting: combination of **SF** and **M1**), as well as modifying the ON-duration of the backlight before the automatic turning-off.

1.4 Using the Keypad

■ Entering Numerical Data

To enter numerical data, e.g., the quantity of goods, use the ten numerical keys and the **ENT** key.

For example, to enter the number "120," press the **1**, **2** and **0** keys and then press the **ENT** key.

26-key pad: If you key in any wrong value, press the **C** key or **BS** key and then enter the correct one.

32-key pad: If you key in any wrong value, press the **C** key or **SF**+**C** keys and then enter the correct one.

■ Selecting Tasks

If the LCD shows the selection items (xxx) prefixed by numerals (e.g., 1: xxx, 2: xxx), use the numerical keys to select a desired item and press the **ENT** key to execute.

If a YES/NO screen (e.g., 1: YES, 2: NO) appears, press the **1** key for YES response and **2** key for NO response.

■ Entering Alphabetic Characters

The BHT-7000 supports the alphabet input function which allows you to enter alphabetic characters, space, and symbols from the keypad during execution of a user program. For the alphabet input procedure, refer to the "BHT-BASIC Programmer's Manual."

1.5 Communicating via the Optical Interface

■ Optical Communications with the BHT-7000

The BHT-7000 communicates using an IR beam, so make sure that there is no obstruction in the light path between the BHT-7000 and any target stations.

In the IrDA communications mode, you need to keep the BHT-7000 and any target stations within the effective light emission range, usually 10 to 80 cm (3.94 to 31.50").

■ Communicating with the CU-7000

The optional CU-7000 is an IrDA-compliant communications unit. For optical communications, put the BHT-7000 directly on the CU-7000 as shown below.

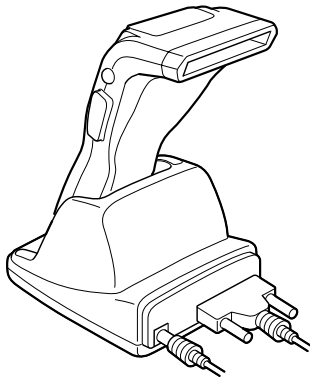

■ Communicating with other IrDA-compliant equipment

You can also have the BHT-7000 communicate with other IrDA-compliant equipment just by aligning their IR ports with each other. The effective IR range and IR port angle may differ depending upon the target equipment, so observe the instructions given in manuals furnished with such equipment.

If transfer using the BHT-7000 fails, bring it closer to the target station or change the IR port angle, and try again.

NOTE

Communications failures might be caused by highly intensive light emitted from ceiling (inverter-driven fluorescent) lamps or direct sunlight. Take care to prevent such interference light from coming into the optical interface ports of the BHT-7000 and IrDA-compliant equipment, including the CU-7000.

NOTE

Do not use any TV remote control in the vicinity of the IR communications system. Doing so may interfere with the communications.

Chapter 2

Getting Started the BHT-7000 and System Mode

This chapter summarizes the BHT-7000 system configuration and describes the operation including preparation and System Mode (which is required for the efficient use of application programs).

2.1	BHT-7000 System Configuration	8
2.2	Infrared Communications	13
2.3	Components and Functions	15
2.4	Preparation	18
2.4.1	Setting-up 1: Loading the Battery Cartridge	18
2.4.2	Setting-up 2: Setting the Calendar Clock	22
2.4.3	Adjusting the LCD Contrast & Beeper Volume, Switching the Beeper & Vibrator, and Checking the Battery Voltage Level	24
[1]	Adjusting the LCD Contrast & Beeper Volume and Switching the Beeper & Vibrator	24
[2]	Checking the Battery Voltage Level	26
2.4.4	Battery Replacement Notes	27
2.5	Initializing the BHT-7000 System	29
2.6	Operating in System Mode	33
2.6.1	Starting System Mode	33
2.6.2	Operating in System Mode	37
[1]	Calling up the desired set screen	37
[2]	Selecting a desired setting	38
2.6.3	Detailed Description of the Functions in System Mode	39
[1]	Program Execution	39
[2]	Downloading	40
[3]	Uploading	44
[4]	System Environment Setting	47
[5]	Testing	62
[6]	System Information	74
[7]	Deleting Files	75
[8]	Downloading/Uploading the BHT System Parameter File	76
[9]	Setting the Remote Wakeup	80
[10]	Downloading/Uploading the System Message File	81

2.1 BHT-7000 System Configuration

The BHT-7000 barcode data collection system requires the following hardware as well as the BHT-7000 Bar Code Handy Terminal (which reads bar codes and accepts keypad entry) as illustrated below:

- **Host computer:** Allows you to edit, manage and download programs and data, as well as downloading extension programs.

For host computers without IrDA interface ports, the optional CU-7000 optical communications unit and RS-232C interface cable are available.

- **CU-7000 (option):** Exchanges programs and data with the BHT-7000 optically and with the host computer via the RS-232C interface.
- **RS-232C interface cable:** Connects the CU-7000 and the host computer. (option)

Optional software includes the BHT-BASIC Extension Library, BHT-BASIC Compiler, Ir-Transfer Utility C, Ir-Transfer Utility E, and Transfer Utility.

System Configuration

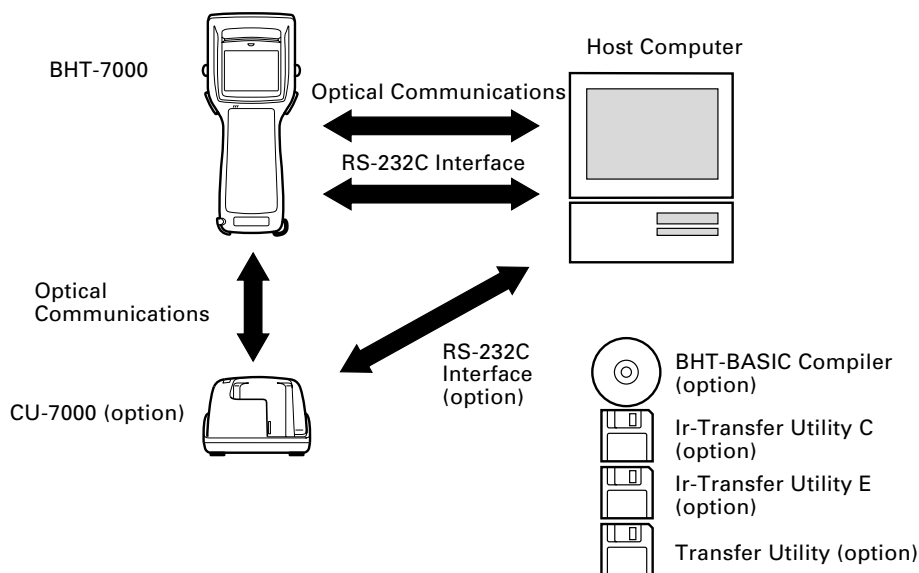

■ Host Computer

Models: PC/AT, PS/2

Optional application programs and OSes

OS \ Applications	MS-DOS	Windows version 3.1	Windows 95/98	WindowsNT 3.51/4.0
BHT-BASIC Compiler	BHT-BASIC3.0 (MS-DOS-based)	BHT-BASIC3.0 (Windows3.1-based)	BHT-BASIC3.5	BHT-BASIC3.5
Ir-Transfer Utility C	MS-DOS-based	—	Windows95-/98-/NT-based	Windows95-/98-/NT-based
Ir-Transfer Utility E	—	—	Windows95-/NT-based	Windows95-/NT-based
Transfer Utility	MS-DOS-based	Windows3.1-based	Windows95-/98-/NT-based	Windows95-/98-/NT-based

■ CU-7000 and RS-232C Interface Cable (option)

The CU-7000 is an IrDA-compliant communications unit which is required when your host computer is not equipped with an IrDA interface port. The CU-7000 exchanges data and programs with the BHT-7000 optically, and with the host computer via the RS-232C interface cable.

You may directly connect two BHT-7000s with each other by using a commercially available metal cable having 3-pole mini stereo plugs (as a direct-connect interface cable). You also connect the BHT-7000 directly with the host computer or with the modem by using the direct-connect interface cable compatible with the target equipment. (NOTE: The direct-connect interface port of the BHT-7000 is not designed to stand frequent connecting/disconnecting. You are, therefore, recommended to use the CU-7000 where you expect to do a lot of connecting and disconnecting of the BHT-7000 to/from a host computer.)

■ BHT-BASIC Compiler (option)

This Compiler compiles a source program written in BHT-BASIC by an editor of the host computer running the MS-DOS, into the object program (user program) which can be used in the BHT-7000. The compiled and linked program file is named "XXX.PD3." (XXX: File name you can set arbitrarily under the MS-DOS rules) You should download it to the BHT-7000 by using Ir-Transfer Utility C/Ir-Transfer Utility E/Transfer Utility.

■ Ir-Transfer Utility C (option)

Running on the host computer, this utility transfers files between the BHT-7000 and the host computer. For its file transfer control procedure, the utility uses the BHT-Ir protocol. (For the details about the BHT-Ir protocol, refer to Chapter 3, Subsection 3.3.2.)

To transfer files under any of the following conditions, use Ir-Transfer Utility C:

- At transmission speeds of 115200 or 57600 bps (This may be impossible depending upon the host computer type.)
- Via the CU-7000
- When transferring via the direct-connect interface of the BHT-7000

■ Ir-Transfer Utility E (option)

Running on the host computer, this utility transfers files between the BHT-7000 and the host computer. For its file transfer control procedure, the utility uses the BHT-Ir protocol. (For the details about the BHT-Ir protocol, refer to Chapter 3, Subsection 3.3.2.)

To transfer files under any of the following conditions, use Ir-Transfer Utility E:

- Via an external IR transceiver
- Via an IR port integrated in a computer

■ Transfer Utility (option)

Running on the host computer, this utility transfers files between the BHT-7000 and the host computer. It uses the BHT-protocol as a file transfer control procedure. (For the details about the BHT-protocol, refer to Chapter 3, Subsection 3.3.1.)

To transfer files under any of the following conditions, use Transfer Utility:

- When the BHT-7000 is placed on the CU-7000
- Via the direct-connect interface of the BHT-7000

Software Structure

System Program and JIS Level 1 & Level 2 fonts are resident in the system area and user area, respectively.

To use extension programs and user programs, you should download the program files into the user area.

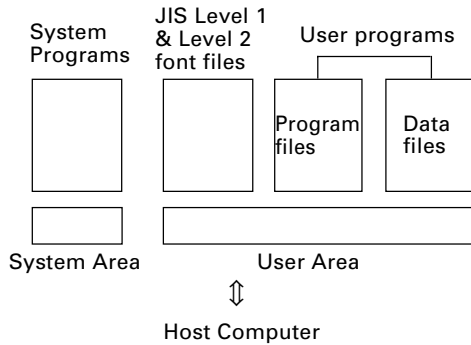

■ System Programs

The system programs include the following three sets of programs:

Drivers

Drivers is a set of programs that directly controls the BHT-7000 hardware. It may be called up by the BHT-BASIC Interpreter or System Mode.

BHT-BASIC Interpreter

The interpreter interprets and executes instructions in user programs written in BHT-BASIC.

System Mode

System Mode is a system program exclusively designed for the effective use of user programs in the BHT-7000. It sets up the execution environments for those programs; e.g., it prepares downloading/uploading conditions, sets the calendar clock, and tests the BHT-7000 components including the LCD, beeper, and keypad. Shown below is the System Mode menu (SYSTEM MENU).

```
SYSTEM MENU
1:EXECUTE PROGRAM
2:DOWNLOAD
3:UPLOAD
4:SET SYSTEM
5:TEST
6:VERSION
```

■ JIS Level 1 and Level 2 Font Files

These files contain font data required for displaying Kanji characters on the LCD.

The BHT-7000 can display the Kanji characters not only in the conventional standard-size font (16 dots wide by 16 dots high) but also in the small-size font (12 dots wide by 12 dots high) in application programs. It can also display the double-width Kanji characters of those 16-dot and 12-dot fonts in application programs.

TIP

If you do not need to display Kanji characters, you may delete these JIS font files. After deletion, the memory area which was occupied by these files can be used as a user area. For the deleting procedure, refer to Section 2.5, “Initializing the BHT-7000 System” or Subsection 2.6.3, “[7] Deleting Files.”

The names of the JIS font files are:

FNT16J1.FN3	(JIS Level 1 font, 16-dot)
FNT16J2.FN3	(JIS Level 2 font, 16-dot)
FNT12J1.FN3	(JIS Level 1 font, 12-dot)
FNT12J2.FN3	(JIS Level 2 font, 12-dot)

■ User Programs

You can develop application programs to meet individual job requirements by using the BHT-BASIC Compiler. To download those user programs to the BHT-7000, use Ir-Transer Utility C/Ir-Transfer Utility E/Transfer Utility.

2.2 Infrared Communications

The BHT-7000 has an integrated infrared (IR) communications device which enables wireless transfer of programs and data between the BHT-7000 and the host computer and between the BHT-7000s, instead of the conventional wire transfer.

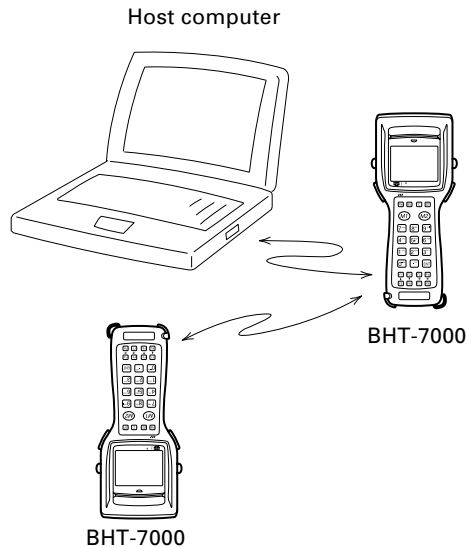

The IR communications device features the following:

- Wireless communications
- Small and lightweight design
- High transmission speed
- Freedom from the codes/regulations and licenses which differ from country to country, unlike radio devices

The BHT-7000's IR communications device is IrDA-compliant. IrDA stands for Infrared Data Association, which has defined hardware (IrDA Serial Infrared Physical Layer Link) and communications protocols for IR communications.

The BHT-7000's physical layer complies with the IrDA1.0, with a maximum transfer distance of 0.8 m and maximum transmission rate of 115.2 kbits per second.

The BHT-7000 adopts the exclusive BHT-Ir protocol which allows you to develop user programs for IR communications in BHT-BASIC, as can be done with conventional wire communications.

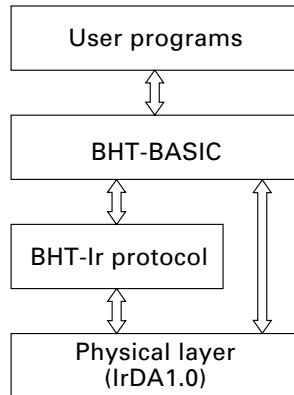

2.3 Components and Functions

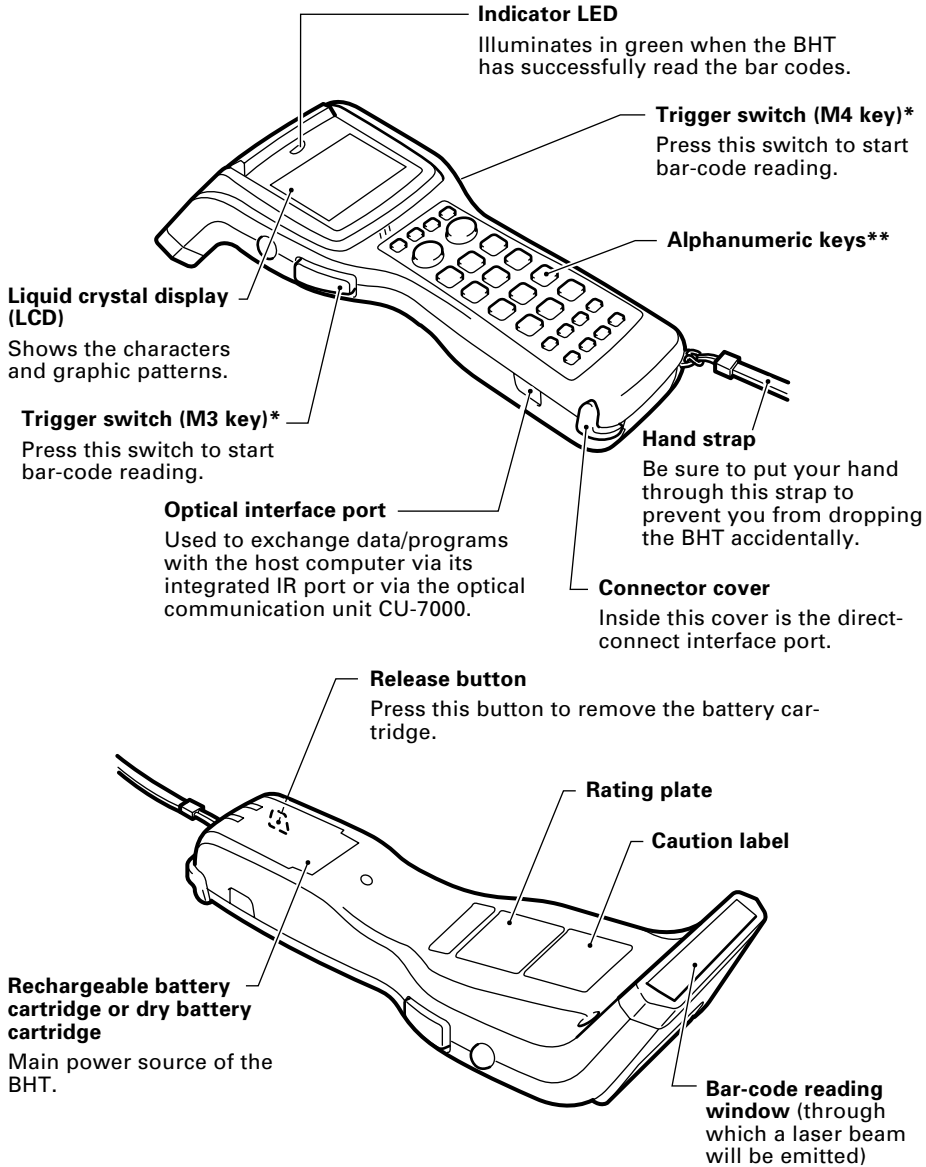

* The trigger switch function is assigned to both of the M3 and M4 keys by default.

** The keypad is available in two types: 32-key pad and 26-key pad.

The functions of the keys may be set by user programs. Shown below is a set of sample functions.

32-key pad

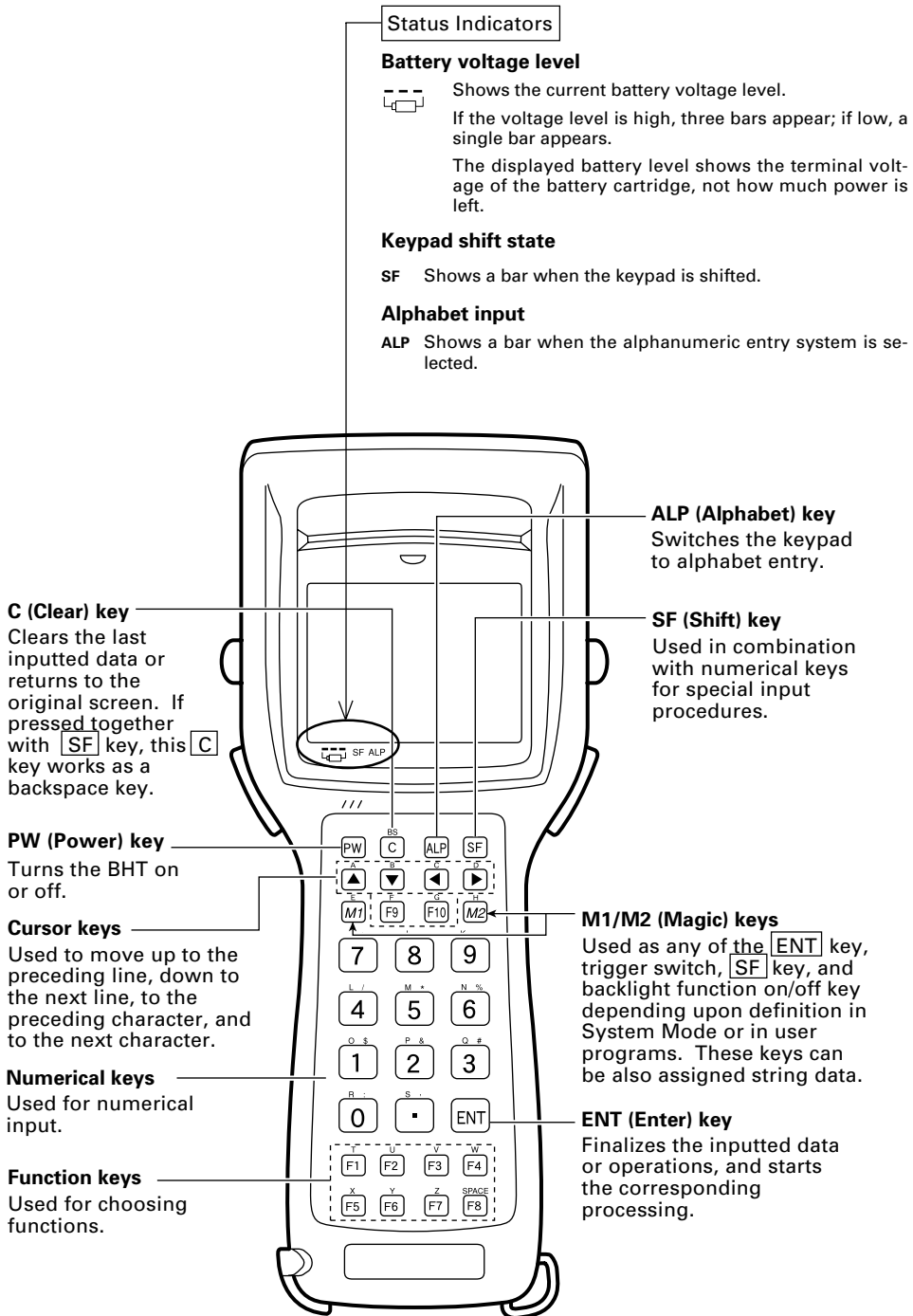

26-key pad

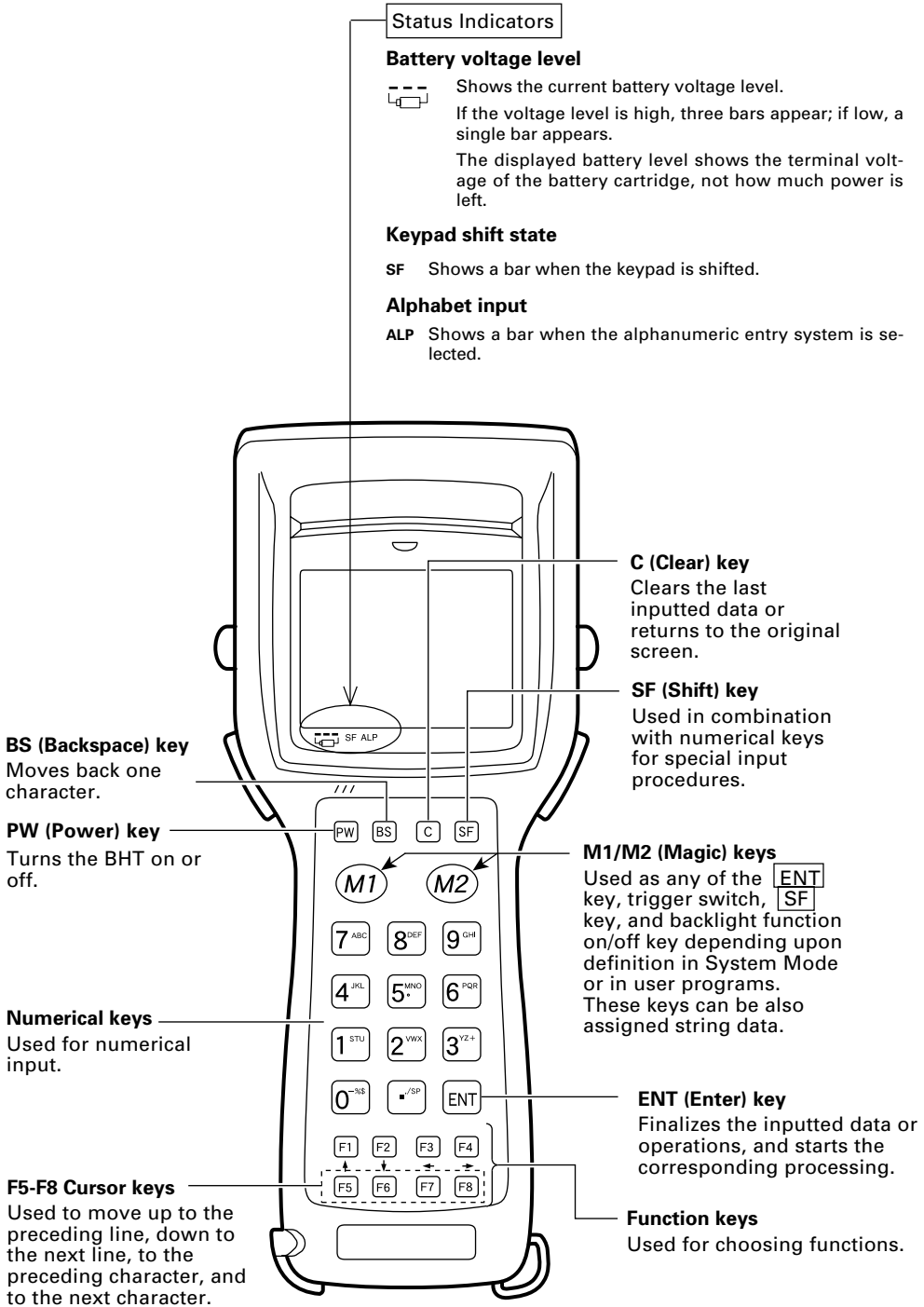

2.4 Preparation

2.4.1 Setting-up 1: Loading the Battery Cartridge





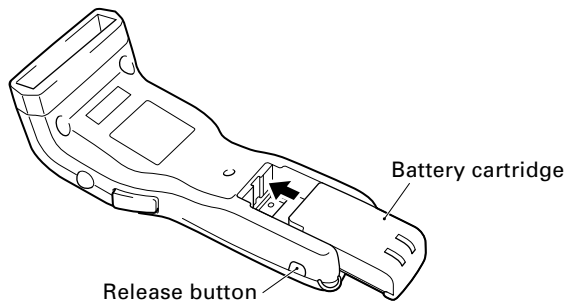

Before the first use of the BHT-7000, be sure to load the battery cartridge as shown below. The battery cartridge is not loaded in the BHT-7000 when shipped from the factory.

- (1) To use the rechargeable battery cartridge, charge it. (Refer to Chapter 5, Section 5.5.)

To use the dry battery cartridge, set two dry batteries into the cartridge. (Refer to the "Dry Battery Cartridge User's Manual" that comes with the dry battery cartridge.)

- (2) Turn the BHT-7000 upside down.
- (3) As shown below, slide the battery cartridge into the BHT until it clicks into place. (To remove it, press the release button.)



 WARNING	<ul style="list-style-type: none">• Never disassemble or heat the battery cartridge, nor put it into fire or water; doing so could cause battery-rupture or leakage of battery fluid, resulting in a fire or bodily injury.• Do not carry or store the battery cartridge together with metallic ball-point pens, necklaces, coins, hairpins, etc. Doing so could short-circuit the terminal pins, causing the batteries to rupture or the battery fluid to leak, resulting in a fire or bodily injury.• Avoid dropping the battery cartridge or letting it undergo any shock or impact. Doing so could cause the batteries to break, generate heat, rupture or burn.• Never charge the battery cartridge where any inflammable gases may be emitted; doing so could cause fire.	   
 CAUTION	<ul style="list-style-type: none">• Do not use batteries or power sources other than the specified ones; doing so could generate heat or cause malfunction.	

NOTE

Never charge the dry battery cartridge.

TIP

The BHT-7000 has an integrated backup power source which backs up the memory and calendar clock in the BHT-7000 when no battery cartridge is loaded or the voltage level of the battery cartridge drops below the specified level. The backup power source is automatically charged by the battery cartridge.

NOTE

When you first load the battery cartridge after purchase or you load it after leaving the BHT-7000 unused for a long time, do not remove the battery cartridge for 10 minutes or more after that loading. This is for charging the memory backup source integrated in the BHT-7000.

NOTE

Be sure to power off the BHT-7000 before battery replacement. Replace the battery cartridge quickly. Load a charged battery cartridge within 3 minutes from the removal of the cartridge in order to avoid data loss.

After battery replacement, power on the BHT-7000 and check its operation.

NOTE

If you leave the BHT-7000 with no battery cartridge loaded for a long time, the memory contents will no longer be backed up so that the message "Contact your administrator. Note the error number. (XXXX)" or "Set the current date and time." may appear on the LCD.

If you will not be using the BHT-7000 for a long time, follow the instructions given in Subsection 2.4.4, "Battery Replacement Notes."

NOTE

When disposing of the battery cartridge, cover the terminal pins with vinyl tape to prevent short-circuit.

NOTE

Avoid storing the battery cartridge in a hot place. The battery capacity may be decreased.

NOTE

Do not touch the charge terminals of the battery cartridge by hand or stain those terminals. Doing so could result in a charging failure.

■ Checking the Battery Voltage Level

The battery voltage level is always displayed on the status indicator line.

(For details, refer to Subsection 2.4.3, "Adjusting the LCD Contrast & Beeper Volume, Switching the Beeper & Vibrator, and Checking the Battery Voltage Level," [2].)

■ Low Battery Indication

Low battery indication—Level 1

If the battery output voltage drops below a specified lower level limit while the BHT-7000 is in operation, the BHT-7000 displays the following level 1 message for approx. 2 seconds and beeps three times. After that, it will resume previous regular operation.

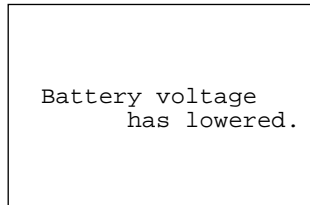

Battery voltage
has lowered.

The service life of the battery cartridge will expire soon. If the BHT-7000 is driven by the lithium-ion battery cartridge, recharge or replace it; if it is driven by the dry battery cartridge, replace the dry batteries.

Low battery indication—Level 2

If you continue to use the BHT-7000 without recharge or battery replacement after the level 1 message appears, the BHT-7000 displays the following level 2 message, beeps five times, and then turns itself off.

(When driven by the lithium-ion battery cartridge)

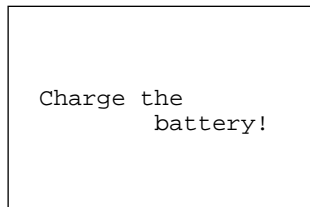

Charge the
battery!

(When driven by the dry battery cartridge)

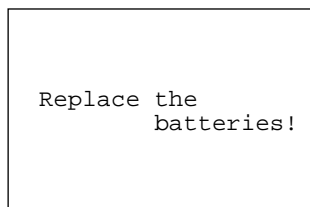





Replace the
batteries!

If the BHT-7000 is driven by the lithium-ion battery cartridge, recharge or replace it; if it is driven by the dry battery cartridge, replace the dry batteries.

NOTE

- Before battery replacement, be sure to power the BHT-7000 off. Within three minutes from the removal of the battery cartridge, load the battery cartridge to avoid data loss. After battery replacement, power the BHT-7000 on and check its operation.
- When replacing dry batteries, always replace both of them with new alkaline manganese batteries (LR6).
- You may charge the lithium-ion battery cartridge with the optional CU-7000 communications unit or optional C-700/C-750 charger. For the charging procedure using the CU-7000, refer to Chapter 5. For that using the C-700/C-750, refer to the "C-700 User's Manual"/"C-750 User's Manual."
- If the "Charge the battery!" or "Replace the batteries!" message appears after the BHT-7000 undergoes any shock or impact, turn the power off and on and then check the battery output level. The battery may not have run out.

 WARNING	<p>Only use the dedicated charger (CU-7000, C-700, or C-750) for charging the lithium-ion battery cartridge. </p> <p>Using a different type of charger could cause battery-rupture or leakage of battery fluid and result in a fire, bodily injury, or serious damage to property.</p>
 CAUTION	<p>Never charge a wet or damp battery cartridge. </p> <p>Doing so could cause the batteries to break, generate heat, rupture or burn.</p>

2.4.2 Setting-up 2: Setting the Calendar Clock

Power on the BHT-7000 by pressing the **[PW]** key.

The following message will appear.

```
Set the current
date and time.

00/01/01 00:00
_ / / :
```

In the following cases, the above message will appear. In such instances, it is necessary to set the date and time.

- The BHT-7000 is first powered on from the time of purchase.
- The BHT-7000 is powered on after the memory back up power source is completely discharged.

NOTE

It is recommended that you upload font files beforehand for such cases that you would mistakenly delete font files or a memory storage error would cause font files to be erased.

```
SYSTEM MENU
1: EXECUTE PROGRAM
2: DOWNLOAD
3: UPLOAD
4: SET SYSTEM
5: TEST
6: VERSION
```

- (1) While holding down the **[SF]** and **[1]** keys, press the **[PW]** key to start System Mode. The SYSTEM MENU shown at left will appear.

```
SET SYSTEM
1: EXECUTE PROGRAM
2: DISPLAY
3: DATE/TIME
4: BARCODE
5: COMMUNICATION
6: KEY
7: RESUME
```

- (2) Press the **[4]** key to select the "SET SYSTEM" on the SYSTEM MENU and then press the **[ENT]** key, and the screen shown at left will appear.

(To return to the immediately preceding screen during this setting procedure, press the **[C]** key.)

```
SET DATE/TIME

00/01/01 00:00
_ / /      :
```

- (3) Press the **3** key on the SET SYSTEM screen to select the "DATE/TIME" and then press the **ENT** key, and the screen shown at left will appear.
- (4) Use the numerical keys to enter the year (only the last two digits), month, day, hour, and minute in this order. If the data is in one digit, add a 0 (zero) preceding the data.

NOTE For the year, be sure to enter the last two digits of the year. For the hour, enter it in the 24-hour format.

If any of the year, month, day, hour, and minute is not entered, the **ENT** key will be deactivated.

If you make a wrong entry, press the backspace key to delete it and then enter the correct data.

[Example] To set 1999, August 19, at 4:00 p.m.

Press **9**, **9**, **0**, **8**, **1**, **9**, **1**, **6**, **0**, and **0**.

```
SET DATE/TIME

00/01/01 00:00
99/08/19 16:00_
```

- (5) Press the **ENT** key to register the above setting.

```
SET DATE/TIME

99/08/19 16:00
_ / /      :
```

- (6) Press the **C** key to return to the SET SYSTEM screen.

2.4.3 Adjusting the LCD Contrast & Beeper Volume, Switching the Beeper & Vibrator, and Checking the Battery Voltage Level

[1] Adjusting the LCD Contrast & Beeper Volume and Switching the Beeper & Vibrator

While holding down the **[M1]** or **[M4]** key, press the **[PW]** key, and any of the following screens will appear on the LCD. This screen will disappear if you press the **[ENT]** key or no keys for five seconds.

When the beeper is selected (default)

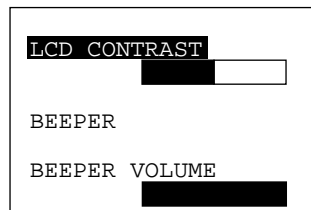

When the vibrator is selected

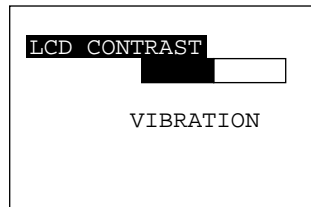



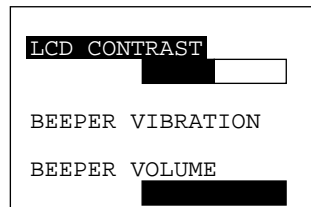

When both the beeper and vibrator are selected



(The current selection is highlighted.)





Adjusting the LCD contrast

You can adjust the LCD brightness to 8 contrast levels.

- 1) Use the * or * keys to select the LCD CONTRAST line.
- 2) To decrease the contrast, press the * key; to increase it, press the * key.





Switching the beeper & vibrator

You may choose any of three ways—beeping only, vibrating only, or beeping & vibrating as a confirmation of completion of bar-code reading.









- (1) Use the * or * key to select the BEEPER or VIBRATION.
- (2) Press the * key twice, and the BEEPER will become highlighted.
To choose beeping only, press no key. To choose vibrating only, press the * key twice. To choose beeping & vibrating, press the * once.
Make sure that your selection is highlighted.

Adjusting the beeper volume

You can adjust the beeper volume to four levels--High, Medium, Low, and OFF.

- 1) Use the * and * keys to select the BEEPER VOLUME line.
- 2) To turn down the volume, press the * key; to turn it up, press the * key.

After making the above setting, either press the  key or press no key for five seconds, and the new setting will be fixed and the above screen will disappear.

* For BHT-7000s having a 26-key pad, use , ,  and  keys instead of , , , and  keys, respectively

[2] Checking the Battery Voltage Level

The battery voltage level is always displayed on the status indicator line (bottom line).

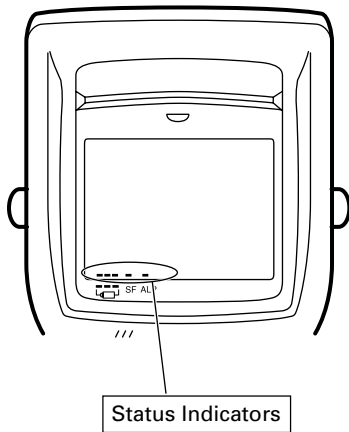

Battery voltage level

 Shows the current battery voltage level.

If the voltage level is high, three bars appear; if low, a single bar appears.

TIP

The displayed battery level shows the terminal voltage of the battery, not how much power is left.

The battery voltage level varies depending upon the operation of the BHT-7000, so the displayed level also may vary.

2.4.4 Battery Replacement Notes

■ When is battery replacement needed?

If the "Charge the battery!" or "Replace the batteries!" appears on the LCD, replace the battery cartridge with a fully charged one or replace the dry batteries with new ones, respectively.

If you leave the BHT-7000 without replacing the battery cartridge, the integrated calendar clock or data will no longer be backed up so that the calendar clock will stop or the "Contact your administrator. Note the error number. (XXXX)" will appear on the LCD.

NOTE

Be sure to power off the BHT-7000 before battery replacement.

Replace the battery cartridge quickly. Load a charged battery cartridge or new dry batteries within 3 minutes after the removal in order to avoid data loss.

After battery replacement, power on the BHT-7000 and check its operation.

■ If you will use the BHT-7000 more than one time per month:

Keep the battery cartridge loaded in the BHT-7000.

■ If you will not be using the BHT-7000 for more than one month:

Remove the battery cartridge from the BHT-7000 and then store the BHT. To do so, be sure to follow the procedure given below.

(1) When removing the battery cartridge:

Press the **PW** key for more than 3 seconds to power off the BHT-7000.

The following message will appear on the LCD and the BHT will start backing up data. After completion of the backup operation so that the message disappears, remove the battery cartridge.

(The backup operation may take several tens of seconds depending upon the volume of data to be backed up.)

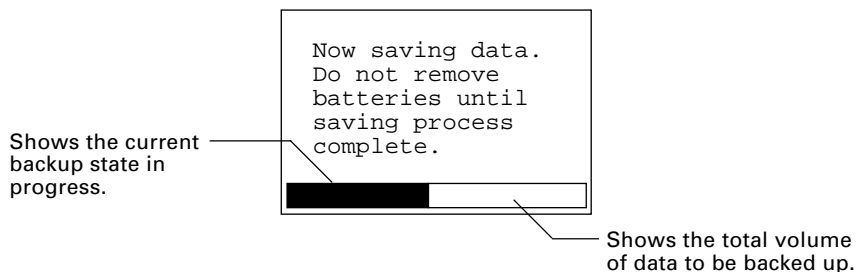

(2) When powering on the BHT after storage with no battery cartridge loaded:

Even after removal of the battery cartridge, the calendar clock will work with the backup power source for a while.

If the calendar clock backup has stopped, loading the battery cartridge and powering on the BHT will display the following message, prompting you to set the current date and time.

Set the calendar clock according to the procedure given in Subsection 2.4.2.

(The indication "00/01/01 00:00" will vary depending upon the calendar clock state.)

```
Set the current
date and time.

00/01/01 00:00
_ / /      :
```

2.5 Initializing the BHT-7000 System

Initializing the system will lose program files and data files stored in the user area and the system settings will revert to the factory defaults.

TIP You may delete font files by selecting the whole user area to be initialized.

You need to initialize the system when:

- (1) you want to delete all of the program files and data files.
- (2) the following message appears.

```
Contact your
      administrator.
Note the error
      number.
(2XXX)
```

On the following pages is an initialization procedure.

(1) Selecting the memory area to be initialized

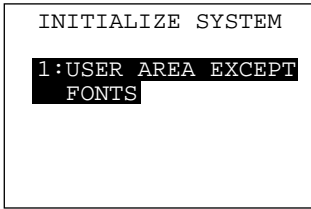

Press the **PW** key while holding down the **SF**, **M1** and **0** keys together.

The screen shown at left will appear.

To initialize the user area except for the font file area, press the **ENT** key. The screen switches to the confirmation display given in step (3) below.

To initialize the whole user area including the font file area, press the **2** key while holding down the **SF** key. The area selection screen will appear.

(Area selection screen)

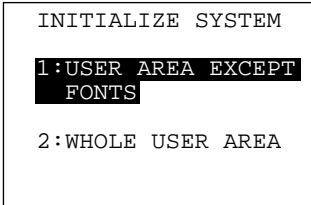

1 USER AREA EXCEPT FONTS:

Initializes the user area except for the font file area.

2 WHOLE USER AREA:

Initializes the whole user area including the font file area.

TIP

If the message "Contact your administrator. Note the error number. (2XXX)" appears on the LCD, you need to select "2: WHOLE USER AREA" to initialize the whole user area.

Select an area to be initialized by using the numerical keys, then press the **ENT** key.

(2) Selecting the English or Japanese message version

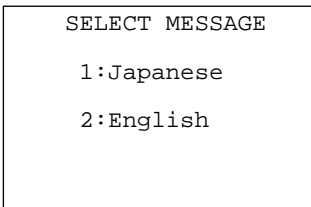

Preceding the execution of initialization, the message version selection screen will appear as shown at left.

1 Japanese : Switches the message version to Japanese.

2 English : Switches the message version to English.

Select a desired item by using the numerical keys, then press the **ENT** key.

(3) Confirming the memory area selected for initialization

```
INITIALIZE SYSTEM

      OK?
    1:Yes  2:No
```

Selecting the "USER AREA EXCEPT FONTS" in step (1) above will call up the confirmation screen shown at left.

1 Yes : Starts initialization.

2 No : Cancels initialization and turns the power off.

Select a desired item by using the numerical keys, then press the **ENT** key.

Pressing the **C** key will switch the screen back to the area selection screen.

```
INITIALIZE SYSTEM

      OK?
    1:Yes  2:No
Warning
Initializing the
whole user area will
lose the font files.
```

Selecting the "WHOLE USER AREA" in step (1) above will call up the screen shown at left.

1 Yes: Starts initialization.

2 No: Cancels initialization and turns the power off.

Select a desired item by using the numerical keys, then press the **ENT** key.

Pressing the **C** key will switch the screen back to the area selection screen.

(4) During initialization

```
INITIALIZE SYSTEM

** Initializing **
```

During initialization, the screen shown at left is displayed.

(5) Completion of initialization

```
INITIALIZE SYSTEM

** Completed **
```

Upon completion of the initialization, the BHT-7000 displays the screen shown at left for a second and turns itself off automatically.

NOTE

Do not power off the BHT-7000 until the above initialization completion screen appears. A too-early powering-off will interrupt initialization, requiring you to initialize the BHT-7000 again.

If the message "Contact your administrator. Note the error number. (2XXX)" appears although the initialization has completed, initialize the BHT-7000 again.

If you initialize the BHT-7000 after downloading user programs and data, all of those programs and data stored in the target memory area will be lost. Download them again if necessary.

Initialization will restore the LCD contrast level (refer to Subsection 2.4.3), communications conditions and other settings to the default values, so modify them if necessary. After initialization, be sure to set the calendar clock (refer to Subsection 2.4.2).

2.6 Operating in System Mode

System Mode is an operating software exclusively designed for the effective use of the BHT-7000, which includes various functions as shown on the following pages.

2.6.1 Starting System Mode

To start up System Mode, power on the BHT-7000 while holding down the **[SF]** and **[1]** keys. This operation calls up the SYSTEM MENU on the LCD as shown below.

SYSTEM MENU	
1	EXECUTE PROGRAM
2	DOWNLOAD
3	UPLOAD
4	SET SYSTEM
5	TEST
6	VERSION

The function selected is highlighted (white-on-black) with the cursor. To select a desired item in System Mode, press the corresponding numerical key and then press the **[ENT]** key.

The keys below are so designed that the function of each key is consistent in every screen.

Numerical keys	Pressing a numerical key corresponding with a desired menu number selects the desired item displayed on the screen.
[ENT] key	Pressing this key registers the selected item and executes the corresponding function.
[▲] and [▼] keys on the 32-key pad ([F5] and [F6] keys on the 26-key pad)	Pressing the [▲] and [▼] keys ([F5] and [F6] keys) moves the cursor up and down, respectively, to select a desired item.
[◀] and [▶] keys on the 32-key pad ([F7] and [F8] keys on the 26-key pad)	Pressing the [◀] and [▶] keys ([F7] and [F8] keys) moves the cursor to the left and right, respectively, to select a desired setting.

The **[C]** key is inoperative on the SYSTEM MENU. On other screens, pressing the **[C]** key returns to the immediately preceding screen.

The power-on default is "EXECUTE PROGRAM" which is highlighted. Once any other item is selected, the selected item will become highlighted with the cursor when you turn back to the SYSTEM MENU.

■ Structure of System Mode

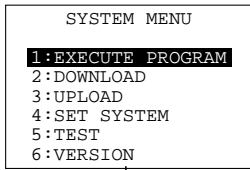

SYSTEM MENU ← Press the **[PW]** key while holding down the **[SF]** and **[1]** keys.

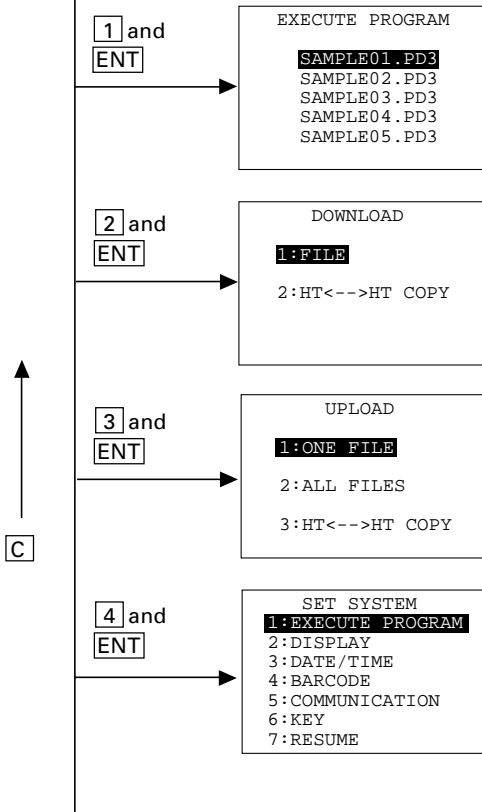

Program Execution

Allows you to select a desired user program to be executed immediately. (Refer to Subsection 2.6.3, [1].)

Downloading

Transfers user program files or data files from the host computer to the memory integrated in the BHT-7000. Downloading between the BHTs is also possible. (Refer to Subsection 2.6.3, [2].)

Uploading

Transfers user program files and data files stored in the memory of the BHT-7000 to the host computer. (Refer to Subsection 2.6.3, [3].)

System Environment Setting

Sets a variety of environmental conditions—an execution program, message version (English or Japanese), calendar clock, special bar-code scanning parameters, interface port, communications parameters, shift-key & magic key functions, and resume function (Refer to Subsection 2.6.3, [4].)

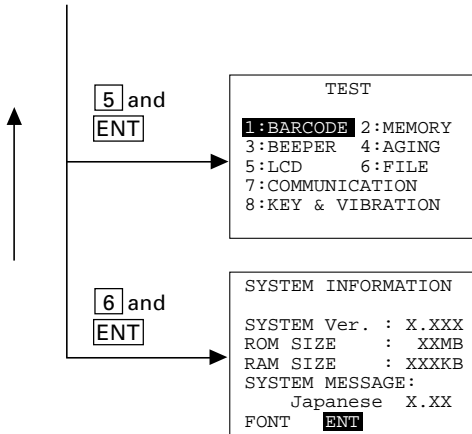

Testing

Used for the bar-code reading test, memory test, beeper test, aging test, LCD indication test, indicator LED test, communications test, key-entry test, vibrator test, and file test.

(Refer to Subsection 2.6.3, [5].)

System Information

Shows the system program version, memory size, system message version, and font type and version

(Refer to Subsection 2.6.3, [6].)

In addition to the functions given on the previous page, System Mode has these four functions: Deleting files, Downloading/uploading the BHT system parameter file, Setting the remote wake-up parameters, and Downloading/uploading the system message file.

To call up these functions, press the **[0]**, **[3]**, **[4]** or **[6]** key, respectively, while holding down the **[SF]** key when the SYSTEM MENU is displayed.

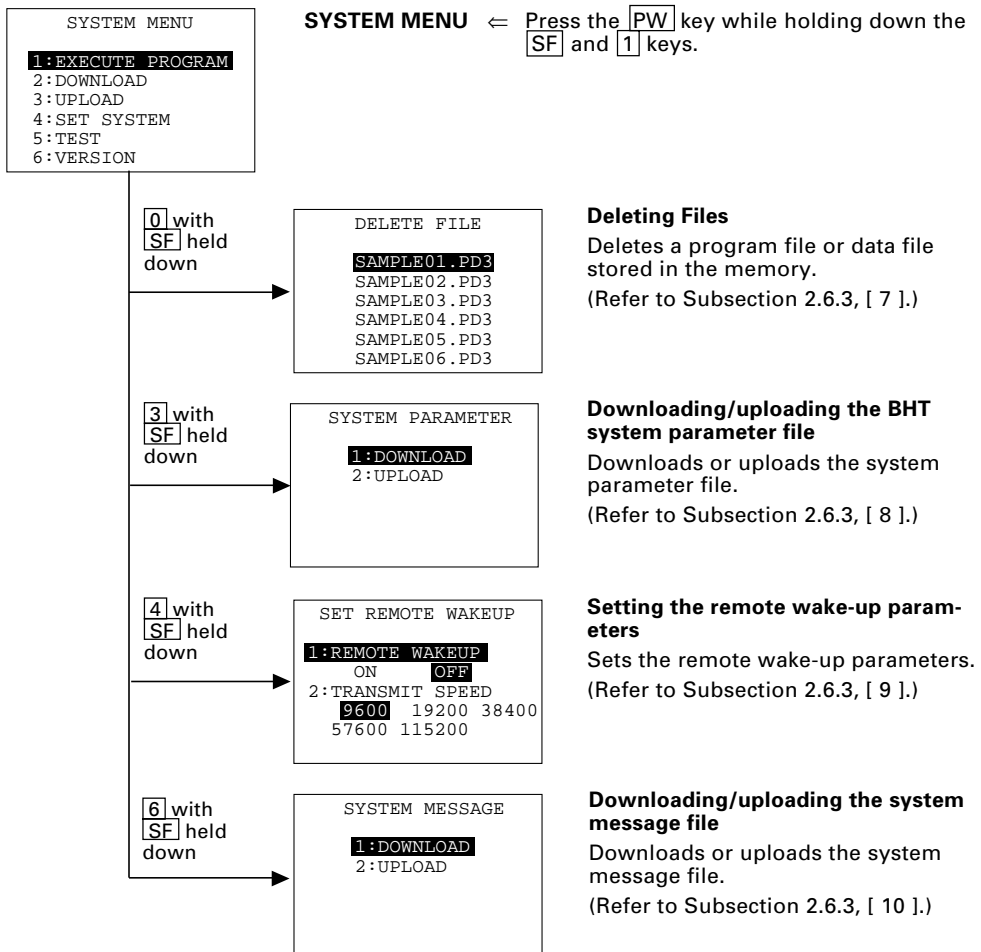

2.6.2 Operating in System Mode

Some functions in System Mode require several screens to be shifted, as shown in the example below.

[1] Calling up the desired set screen

First, select a desired item on the current screen by using the numerical key or the cursor keys (▲* and ▼*) so as to highlight the desired item.

Press the **ENT** key to establish the selected item and proceed to the subsequent screen.

To return to the preceding screen, press the **C** key.

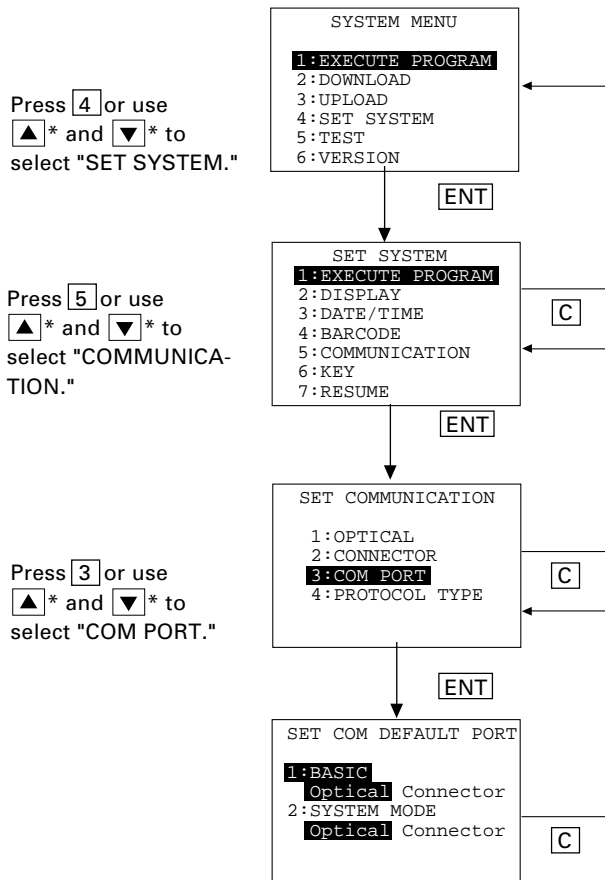

* For BHT-7000s having a 26-key pad, use **F5**, **F6**, **F7** and **F8** keys instead of ▲, ▼, ◀, and ▶ keys, respectively

[2] Selecting a desired setting

First, select a desired item on the current screen by using the numerical key or the cursor keys (▲* and ▼*) so as to highlight the desired item.

Use the ◀* and ▶* keys to select a desired setting and then press the **ENT** key. The screen returns to the previous selection screen.

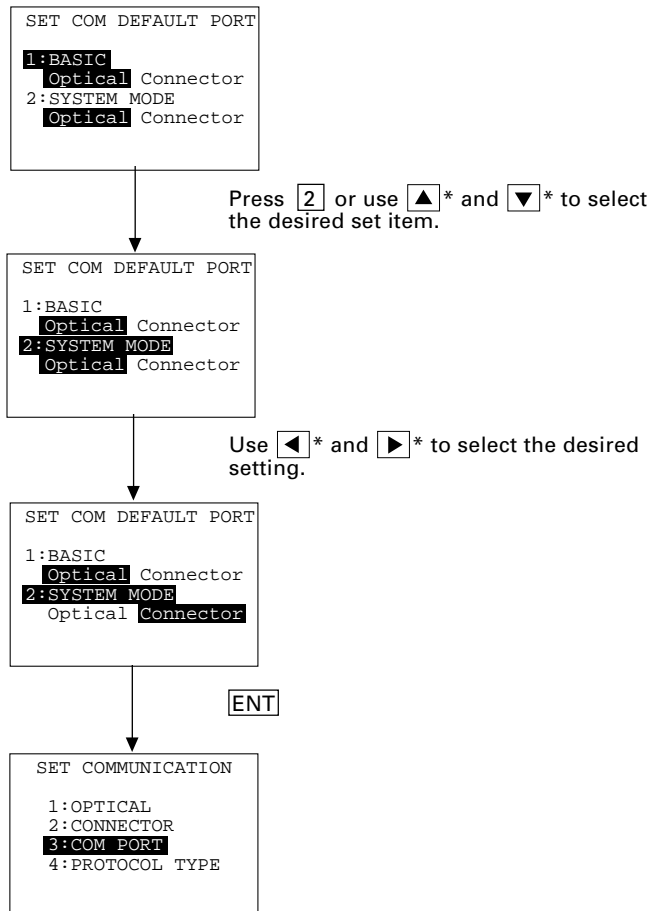

* For BHT-7000s having a 26-key pad, use **F5**, **F6**, **F7** and **F8** keys instead of ▲, ▼, ◀, and ▶ keys, respectively

2.6.3 Detailed Description of the Functions in System Mode

[1] Program Execution

```
EXECUTE PROGRAM
SAMPLE01.PD3
SAMPLE02.PD3
SAMPLE03.PD3
SAMPLE04.PD3
SAMPLE05.PD3
SAMPLE06.PD3
```

Selecting "1:EXECUTE PROGRAM" on the SYSTEM MENU shows the screen shown at left.

If more than one program has been downloaded to the user area of the target memory, use the * and * keys to move the cursor to a target program, and then press the key.

To return to the SYSTEM MENU, press the key.

```
EXECUTE PROGRAM
SAMPLE01.PD3
SAMPLE02.PD3
SAMPLE03.PD3
SAMPLE04.PD3
SAMPLE05.PD3
SAMPLE06.PD3
```

If more than five programs have been downloaded, you may need to scroll the screen with the * key.

```
EXECUTE PROGRAM
SAMPLE02.PD3
SAMPLE03.PD3
SAMPLE04.PD3
SAMPLE05.PD3
SAMPLE06.PD3
SAMPLE07.PD3
```

```
EXECUTE PROGRAM
SAMPLE18.PD3
SAMPLE19.PD3
SAMPLE20.PD3
SAMPLE21.PD3
SAMPLE22.PD3
SAMPLE23.PD3
```

In the example shown at left, 23 programs are downloaded.

```
EXECUTE PROGRAM
*****
* NO FILE EXISTS *
*****
```

If no program file is downloaded, the message shown at left will appear.

To return to the SYSTEM MENU, press the key.

* For BHT-7000s having a 26-key pad, use , , and keys instead of , , , and keys, respectively

[2] Downloading

NOTE

If you download a file having the same name as one already used in the user area of the target memory in the BHT-7000, the newly downloaded file replaces the old one.

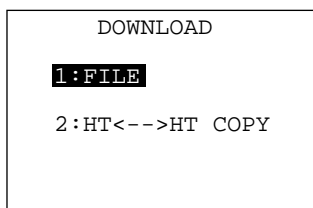

Selecting "2: DOWNLOAD" on the SYSTEM MENU calls up the screen shown at left.

1 FILE : Downloads a user program file or data file to the user area of the BHT-7000.

2 HT<-->HT COPY : Downloads all of the files, system parameters, and calendar clock data stored in the connected BHT-7000.

This function enables copying between the BHT-7000s.

For the preparation to be made preceding the start of this function, refer to NOTE below.

Select a desired item by using the numerical keys or **▲*** and **▼*** keys, and the selected item becomes highlighted. Then press the **ENT** key.

To return to the SYSTEM MENU, press the **C** key.

NOTE Preparation for Copying between the BHTs

Before downloading to the BHT-7000 from another BHT-7000, make the following preparation:

- At each BHT-7000, set the interface port. The default is an optical interface (Optical).

Interface setting procedure: Starting on the SYSTEM MENU, select "4:SET SYSTEM," "5:COMMUNICATION," and "3:COM PORT." On the SET COM DEFAULT PORT screen, select the optical interface (Optical) or direct-connect interface (Connector) of "2:SYSTEM MODE."

- When using the direct-connect interface, pull out the connector cover on each BHT-7000 to expose the direct-connect interface port. Connect the BHT-7000s via those ports with the direct-connect interface cable (having 3-pole mini stereo plugs). For the details about the cable, refer to Chapter 3, Section 3.1.
- On the uploading BHT-7000, run System Mode and select "3:UPLOAD" and "3:HT<-->HT COPY."

* For BHT-7000s having a 26-key pad, use **F5**, **F6**, **F7** and **F8** keys instead of **▲**, **▼**, **◀**, and **▶** keys, respectively

Download screens

```

DOWNLOAD FILE

** Waiting **
    
```



```

DOWNLOAD FILE

** Loading **
    
```



```

DOWNLOAD FILE

XXXXXXXXX.XXX
** Loading **

XXXXXX/YYYYY
    
```



```

DOWNLOAD FILE

XXXXXXXXX.XXX
** Completed **
    
```

With this screen displayed, the BHT-7000 waits for a file to be downloaded.

If you select "2:HT<-->HT" on the DOWNLOAD menu, the "HT<-->HT" will appear in the center of the 2nd line. If you select "1:FILE," nothing will appear on the 2nd line.

The screen at left shows that "1:FILE" has been selected.

Upon start of optional Ir-Transfer Utility C/Ir-Transfer Utility E/Transfer Utility or equivalent program (upon receipt of an ENQ code from the host computer), the BHT-7000 displays the screen shown at left.

(Refer to the "Ir-Transfer Utility C Guide"/"Ir-Transfer Utility E Guide"/"Transfer Utility Guide.")

While the downloading operation is in progress, the screen shown at left is displayed indicating the file name and the number of received records/the total number of records.

To abort the downloading operation, press the key. The screen will switch back to the DOWNLOAD menu.

Upon completion of downloading, the number of received records becomes equal to the total number of records and the beeper beeps once. Press the key to return to the DOWNLOAD menu.

If the host computer downloads another new file (if the BHT-7000 receives an ENQ code) when this screen is displayed, the BHT-7000 starts receiving it.

(Refer to the "Ir-Transfer Utility C Guide"/"Ir-Transfer Utility E Guide"/"Transfer Utility Guide.")

If you have selected "2: HT<-->HT COPY" on the DOWNLOAD menu, a sequence of the above screens will be repeated by the number of files to be downloaded.

If an error occurs during downloading

If some error occurs during downloading, the BHT-7000 beeps three times and shows one of the following screens with the prompt "Retry?":

To retry the download, press the **[1]** and **[ENT]** keys; to abort it, press the **[2]** and **[ENT]** keys.

```
DOWNLOAD FILE
XXXXXXXXX.XXX
Out of memory!!
Retry?
  1:Yes 2:No
```

■ Problem

The memory is insufficient for storing files to be downloaded.

■ Solution

Press the **[2]** key to return to the SYSTEM MENU, then delete unnecessary files in the memory or decrease the size of the file to be downloaded. (Refer to Subsection 2.6.3, [7] and [2].)

```
DOWNLOAD FILE
XXXXXXXXX.XXX
Too many files!!
Retry?
  1:Yes 2:No
```

■ Problem

The current download will exceed the maximum of 80 files in the memory.

■ Solution

Press the **[2]** key to return to the SYSTEM MENU. Delete unnecessary files in memory or decrease the number of files to be downloaded if you attempted to download more than one file (Refer to Subsection 2.6.3, [7] and [2].)

```
DOWNLOAD FILE
XXXXXXXXX.XXX
Communication error!!
Retry?
  1:Yes 2:No
```

■ Problem

Downloading has failed.

■ Solution

To retry downloading, press the **[1]** key.

To return to the SYSTEM MENU, press the **[2]** key. Check the interface port and communications parameters in the SET SYSTEM menu or perform the communications test in the TEST menu. (Refer to Subsection 2.6.3, [4.5] and [5.7].)

It is also necessary to check the communications parameters setup of the host computer.

```
DOWNLOAD FILE
XXXXXXXXX.XXX
Program file error!!

Retry?
  1:Yes 2:No
```

■ **Problem**

You attempted to download an invalid program file.

■ **Solution**

Check whether the program file you attempted to download is available to your BHT model. If it is not available, download the appropriate program.

[3] Uploading

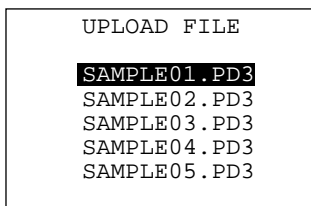
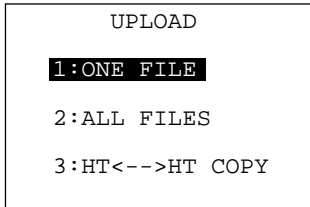

Selecting "3: UPLOAD" on the SYSTEM MENU calls up the screen shown at left.

- 1 ONE FILE : Uploads a user program file or data file stored in the memory.
- 2 ALL FILES : Uploads all user program files (object programs) and all data files stored in the memory.
- 3 HT<-->HT COPY : Uploads all of the files, system parameters, and calendar clock data stored in the BHT-7000, to another BHT-7000.

This function enables copying between the BHT-7000s. At the receiving BHT-7000, select "2: DOWNLOAD" and "2: HT<-->HT COPY" in System Mode.

For the preparation to be made preceding the start of this function, refer to NOTE given on page 40.

Select a desired item by using the numerical keys or * and * keys, and the selected item becomes highlighted. Then press the key.

To return to the SYSTEM MENU, press the key.

If you select "1:ONE FILE" on the UPLOAD menu, the file selection screen as shown at left will appear, listing all of the program files and data files stored in the memory. Select a file(s) you want to upload and press the key.

If you select "2:ALL FILES" or "3:HT<-->HT COPY" on the UPLOAD menu, the "ALL" or "HT<-->HT" will appear in the center of the 2nd line, respectively.

* For BHT-7000s having a 26-key pad, use , , and keys instead of , , , and keys, respectively

```
      UPLOAD FILE

*****
* NO FILE EXISTS *
*****
```

If you select "1:ONE FILE" or "2:ALL FILES" on the UPLOAD menu when no files are stored in the memory, the message shown at left will appear.

Pressing the **C** key returns to the UPLOAD menu.

Upload screens

```
      UPLOAD FILE

** Waiting **
```

If you select "1:ONE FILE" and choose a file to be uploaded or if you select the "2:ALL FILES" or "3:HT<-->HT COPY" on the UPLOAD menu, then the screen shown at left will appear.

If you select "2:ALL FILES" or "3:HT<-->HT COPY," the "ALL" or "HT<-->HT" will appear in the center of the 2nd line, respectively.

Showing this screen, the BHT-7000 waits for a file(s) to be uploaded.



```
      UPLOAD FILE

** Loading **
```

Upon start of optional Ir-Transfer Utility C/Ir-Transfer Utility E/Transfer Utility or equivalent program (upon receipt of an ACK code from the host computer), the BHT-7000 displays the screen shown at left.

(Refer to the "Ir-Transfer Utility C Guide"/"Ir-Transfer Utility E Guide"/"Transfer Utility Guide.")



```
      UPLOAD FILE

SAMPLE01.PD3
** Loading **

XXXXX/YYYYY
```

While the uploading operation is in progress, the screen shown at left is displayed indicating the file name and the number of sent records/the total number of records.

To abort the uploading operation, press the **C** key. The screen will switch back to the UPLOAD menu.

```
UPLOAD FILE
SAMPLE01.PD3
** Completed **
```

Upon completion of uploading, the number of sent records becomes equal to the total number of records and the beeper beeps once. Press the **C** key to return to the UPLOAD menu.

If you have selected "2:ALL FILES" or "3:HT<-->HT COPY" on the UPLOAD menu, a sequence of the above screens will be repeated by the number of files to be uploaded.

If an error occurs during uploading

If some error occurs during uploading, one of the following screens will appear and the beeper beeps three times.

To retry the uploading operation, press the **1** and **ENT** keys; to abort it, press the **2** and **ENT** keys.

```
UPLOAD FILE
File error!!
Upload?
  1:Yes 2:No
```

■ Problem

The file you attempted to upload is damaged.

■ Solution

To upload the damaged file as is, press the **1** key.

```
UPLOAD FILE
XXXXXXXXX.XXX
Communication error!!
Retry?
  1:Yes 2:No
```

■ Problem

Uploading has failed.

■ Solution

To retry uploading, press the **1** key.

To return to the SYSTEM MENU, press the **2** key. Check the interface port and communications parameters in the SET SYSTEM menu or perform the communications test in the TEST menu. (Refer to Subsection 2.6.3, [4.5] and [5.7].)

It is also necessary to check the communications parameters setup of the host computer.

[4] System Environment Setting

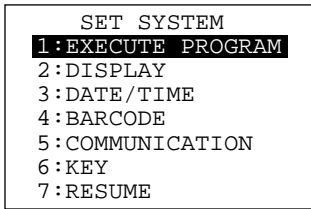

Selecting "4: SET SYSTEM" on the SYSTEM MENU calls up the screen shown at left.

- 1 EXECUTE PROGRAM : Sets an execution program to be run when the power is turned on.
- 2 DISPLAY : Sets the message version (English or Japanese).
- 3 DATE/TIME : Sets the calendar clock (date and time).
- 4 BARCODE : Sets the special barcode scanning parameters (the black-and-white inverted label reading and the decoding level) and the minimum number of digits to be read for bar codes (ITF, STF and CODA-BAR).
- 5 COMMUNICATION : Sets the communications environments (interface port and communications parameters).
- 6 KEY : Defines the functions of the shift key and magic keys.
- 7 RESUME : Sets the resume function.

Select a desired item by using the numerical keys or **▲*** and **▼*** keys, and the selected item becomes highlighted. Then press the **ENT** key.

Press the **C** key to return to the SYSTEM MENU.



* For BHT-7000s having a 26-key pad, use **F5**, **F6**, **F7** and **F8** keys instead of **▲**, **▼**, **◀**, and **▶** keys, respectively

[4.1] Setting an execution program

```
SET EXECUTE PROGRAM
SAMPLE01.PD3
SAMPLE02.PD3
SAMPLE03.PD3
SAMPLE04.PD3
```

Selecting "1: EXECUTE PROGRAM" on the SET SYSTEM menu calls up the screen shown at left.

Highlighted is the current setting.

Use the * and * keys to move the cursor to a desired execution program to be run when the power is applied, and then press the  key.

To return to the SET SYSTEM menu, press the  key.

```
SET EXECUTE PROGRAM
*****
* NO FILE EXISTS *
*****
```

If no program files are stored in the memories, the screen shown at left will appear.

To return to the SET SYSTEM menu, press the  key.



[4.2] Setting the message version

```
SET DISPLAY
MESSAGE
English Japanese
```

Selecting "2: DISPLAY" on the SET SYSTEM menu calls up the screen shown at left.









Highlighted is the current setting.

MESSAGE: Switches the message version to English or Japanese for system error messages and indications on the LCD contrast, beeper volume, beeper & vibrator switching, and battery voltage level screens. (The default is the message version that you selected in the initializing sequence.)

Select a desired setting by using the * and * keys.

Press the  key.

To return to the SET SYSTEM menu, press the  key.

* For BHT-7000s having a 26-key pad, use , ,  and  keys instead of , , , and  keys, respectively

[4.3] Setting the calendar clock

```
SET DATE/TIME  
  
00/01/01 00:00  
_ / / :
```



```
SET DATE/TIME  
  
00/01/01 00:00  
99/08/19 16:00_
```



```
SET DATE/TIME  
  
99/08/19 16:00  
_ / / :
```

Selecting "3: DATE/TIME" on the SET SYSTEM menu calls up the screen shown at left.

Use the numerical keys to enter the year (only the last two digits), month, day, hour, and minute in this order, and then press the **ENT** key. If the data is in one digit, add a 0 (zero) preceding the data.

NOTE

For the year, be sure to enter the last two digits of the year. For the hour, enter it in the 24-hour format.

If any of the year, month, day, hour, and minute is not entered, the **ENT** key will be deactivated.

If you make a wrong entry, press the backspace key to delete it and then enter the correct data.

To return to the SET SYSTEM menu, press the **C** key.

[Example] To set 1999, August 19, at 4:00 p.m.

Press **9**, **9**, **0**, **8**, **1**, **9**, **1**, **6**, **0**, and **0**.

Press the **ENT** key to register the above setting.

[4.4] Setting the special bar-code scanning parameters

SET BARCODE	
1: INVERT	ON OFF
2: DECODE LEVEL	X
MINIMUM DIGITS	
3: ITF	XX
4: STF	XX
5: CODABAR	XX
6: MARKER	X

Selecting "4: BARCODE" on the SET SYSTEM menu calls up the screen shown at left.

Highlighted is the current setting.

- 1 INVERT : Activates or deactivates the black-and-white inverted label reading function.
- 2 DECODE LEVEL : Sets the decode level.
- 3 ITF : Sets the minimum number of digits to be read for ITF.
- 4 STF : Sets the minimum number of digits to be read for STF.
- 5 CODABAR : Sets the minimum number of digits to be read for CODABAR.
- 6 MARKER : Sets the marker ON/OFF mode.

Select a desired item by using the numerical keys or \blacktriangle * and \blacktriangledown * keys, and then select a desired setting by using the \blacktriangleleft * and \blacktriangleright * keys.

To increase the decode level, press the \blacktriangleright * key; to decrease it, press the \blacktriangleleft * key.

To increase the number of digits to be read for ITF, STF and CODABAR, press the \blacktriangleright * key; to decrease it, press the \blacktriangleleft * key.

Press the ENT key.

To return to the SET SYSTEM menu, press the C key.

Black-and-white inverted label reading function (INVERT)

This function makes it possible to read white bars on a black background.

NOTE Activating this function might increase the frequency of bar-code reading errors. This function can usually be set to OFF.

DECODE LEVEL

You may set the decode level. Decreasing the level value increases the bar-code reading efficiency, but the BHT-7000 might misread low-quality bar codes (split or stained). To the contrary, increasing the level value decreases the bar-code reading efficiency, but it will diminish the possibility of misreading.

The setting range of the level value is from 1 to 9 and the default is 4.

* For BHT-7000s having a 26-key pad, use F5 , F6 , F7 and F8 keys instead of \blacktriangle , \blacktriangledown , \blacktriangleleft , and \blacktriangleright keys, respectively

Minimum number of digits to be read for ITF, STF, or CODABAR (MINIMUM DIGITS)

You may determine the minimum number of digits to be read for ITF, STF, and CODABAR. Setting a small number of digits increases the frequency of digit-missing reading or misreading depending upon how to scan bar codes or the quality of bar codes. On the other hand, setting a large number will diminish the possibility of those errors.

The setting range is from 2 to 20 for ITF, from 1 to 20 for STF, and from 3 to 20 for CODABAR. The default is 4 for ITF and CODABAR, and 2 for STF.

MARKER

You may select either of the following ON/OFF modes of a laser beam (marker) which indicates the scanning range:

- 0: Normal mode (in which the laser and illumination LED come on at the same time at the time of scanning)
- 1: OFF mode (in which no laser comes on)

TIP

Even if the MARKER is set to 0 (Normal mode), the marker will not come on when the read mode is set to the alternate switching mode or continuous reading mode.

[4.5] Setting the communications environments

After the BHT-7000 is initialized, the interface port and communications parameters are set as listed in the default table below. Do not access them unless necessary.

Interface port	Optical (Optical interface port)
Communications protocol	BHT-protocol
Communications parameters for the optical interface port	Defaults
TRANSMIT SPEED	9600 bps
PROTOCOL (Protocol options)	SERIAL No.: ON (Adds serial numbers to data blocks.)
	H. PARITY: ON (Adds a horizontal parity.)
	LINKUP TIME: 30 seconds
	FIELD SPACE: Ignore

Listed below are the default communications parameters for the direct-connect interface.

Communications parameters for the direct-connect interface port	Defaults
TRANSMIT SPEED	19200 bps
PARITY BIT (Vertical parity)	None
DATA BIT (Character length)	8 bits
STOP BIT	1 bit
PROTOCOL (Protocol options)	SERIAL No.: ON (Adds serial numbers to data blocks.)
	H. PARITY: ON (Adds a horizontal parity.)
	LINKUP TIME: 30 seconds
	FIELD SPACE: Ignore

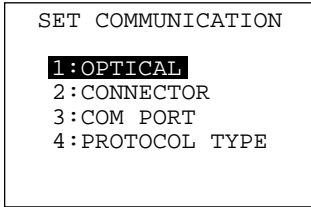

Selecting the "5: COMMUNICATION" on the SET SYSTEM menu calls up the screen shown at left.

- 1 OPTICAL: Switches to the communications parameters setting screen *for the optical interface*.
- 2 CONNECTOR: Switches to the communications parameters setting screen *for the direct-connect interface*.
- 3 COM PORT: Switches to the interface port setting screen.
- 4 PROTOCOL TYPE: Switches to the communications protocol type setting screen.

Select a desired screen by using the numerical keys or ▲* and ▼* keys, and then press the ENT key.

To return to the SET SYSTEM menu, press the C key.

[4.5-1] Setting the communications parameters for the optical interface

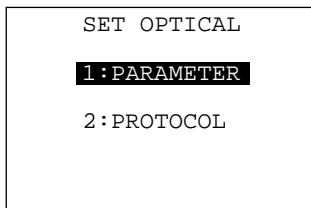

Selecting "1:OPTICAL" on the SET COMMUNICATION menu calls up the screen shown at left.

- 1 PARAMETER: Switches to the communications parameters setting screen.
- 2 PROTOCOL: Switches to the communications protocol option screen.

Select a desired screen by using the numerical keys or ▲* and ▼* keys, and then press the ENT key.

To return to the SET COMMUNICATION menu, press the C key.

* For BHT-7000s having a 26-key pad, use F5, F6, F7 and F8 keys instead of ▲, ▼, ◀, and ▶ keys, respectively

(1) Communications parameters setting screen

```
SET PARAMETER
< OPTICAL >
1:TRANSMIT SPEED:
 2400 9600 19200
38400 57600 115200
```

Selecting "1:PARAMETER" on the SET OPTICAL screen calls up the screen shown at left.

Highlighted is the current setting.

Select the desired transmission speed by using the numerical keys or ◀* and ▶* keys, and then press the **ENT** key.

To return to the SET OPTICAL screen, press the **C** key.

(2) Communications protocol option screen

```
SET PROTOCOL
< OPTICAL >
1:SERIAL No. : ON OFF
2:H.PARITY   : ON OFF
3:LINKUP TIME:
  None 30 60 90 120
4:FIELD SPACE:
  Ignore Data
```

Selecting "2: PROTOCOL" on the SET OPTICAL screen calls up the screen shown at left.

Highlighted is the current setting.

1 SERIAL No.: Selects whether or not the system will add serial numbers to data blocks.

2 H. PARITY: Selects whether or not the system will add a horizontal parity.

3 LINKUP TIME: Selects the timeout length (in seconds) to be applied when a link is to be established.

4 FIELD SPACE: Selects whether space codes in the tail of a data field will be ignored or handled as data.

Select a desired item by using the numerical keys or ▲* and ▼* keys. Then select a desired setting by using the ◀* and ▶* keys.

To return to the SET OPTICAL screen, press the **C** key.

NOTE

If the BHT-Ir protocol has been selected, the serial number and horizontal parity settings will be ignored.

* For BHT-7000s having a 26-key pad, use **F5**, **F6**, **F7** and **F8** keys instead of ▲, ▼, ◀, and ▶ keys, respectively

[4.5-2] Setting the communications parameters for the direct-connect interface

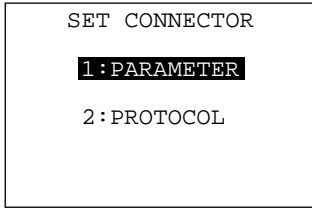

Selecting "2:CONNECTOR" on the SET COMMUNICATION menu calls up the screen shown at left.

- 1** PARAMETER: Switches to the communications parameters setting screen.
- 2** PROTOCOL: Switches to the communications protocol screen.

Select a desired screen by using the numerical keys or **▲*** and **▼*** keys, and then press the **ENT** key.

To return to the SET COMMUNICATION menu, press the **C** key.

(1) Communications parameters setting screen

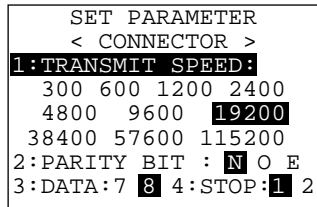

Selecting "1:PARAMETER" on the SET CONNECTOR screen calls up the screen shown at left.

Highlighted is the current setting.

- 1** TRANSMIT SPEED: Sets the transmission speed.
- 2** PARITY BIT: Sets the vertical parity: none, odd, or even.
- 3** DATA: Sets the character length.
- 4** STOP: Sets the stop bit length.

Select a desired item by using the numerical keys or **▲*** and **▼*** keys. Then select a desired setting by using the **◀*** and **▶*** keys.

To return to the SET CONNECTOR screen, press the **C** key.

NOTE If the BHT-Ir protocol has been selected, the parity bit, character length, and stop bit length settings will be ignored.

* For BHT-7000s having a 26-key pad, use **F5**, **F6**, **F7** and **F8** keys instead of **▲**, **▼**, **◀**, and **▶** keys, respectively

(2) Communications protocol option menu

```
SET PROTOCOL
< CONNECTOR >
1:SERIAL No. : ON OFF
2:H.PARITY   : ON OFF
3:LINKUP TIME :
  None 30 60 90 120
4:FIELD SPACE:
  Ignore Data
```

Selecting "2:PROTOCOL" on the SET CONNECTOR screen calls up the screen shown at left.

Highlighted is the current setting.

- 1 SERIAL No.: Selects whether or not the system will add serial numbers to data blocks.
- 2 H. PARITY: Selects whether or not the system will add a horizontal parity.
- 3 LINKUP TIME: Selects the timeout length (in seconds) to be applied when a link is to be established.
- 4 FIELD SPACE: Selects whether space codes in the tail of a data field will be ignored or handled as data.

Select a desired item by using the numerical keys or **▲*** and **▼*** keys. Then select a desired setting by using the **◀*** and **▶*** keys.

To return to the SET CONNECTOR screen, press the **C** key.

NOTE

If the BHT-Ir protocol has been selected, the serial number and horizontal parity settings will be ignored.

* For BHT-7000s having a 26-key pad, use **F5**, **F6**, **F7** and **F8** keys instead of **▲**, **▼**, **◀**, and **▶** keys, respectively

[4.5-3] Setting the interface port

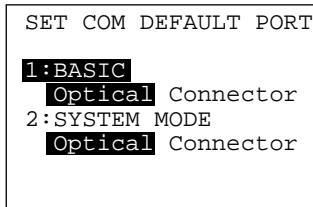

Selecting the "3:COM PORT" on the SET COMMUNICATION menu calls up the screen shown at left.

Highlighted is the current setting.

- 1 BASIC: Selects the optical or direct-connect interface port to be used for user programs written in BHT-BASIC (OPEN "COM:" or XFILE statement).
- 2 SYSTEM MODE: Selects the optical or direct-connect interface port to be used for downloading or uploading files in System Mode.

Select a desired item by using the numerical keys or * and * keys, and then select a desired setting by using the * and * keys.

To return to the SET COMMUNICATION menu, press the key.

* For BHT-7000s having a 26-key pad, use , , and keys instead of , , , and keys, respectively

[4.5-4] Setting the communications protocol type

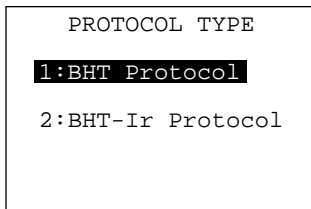

Selecting the "4:PROTOCOL TYPE" on the SET COMMUNICATION menu calls up the screen shown at left.

Highlighted is the current setting.

1 BHT Protocol: Selects the BHT-protocol for downloading or uploading files in System Mode or for the execution of XFILE statement in BHT-BASIC.

This protocol should be selected for file transmission with Transfer Utility.

2 BHT-Ir Protocol: Selects the BHT-Ir protocol for downloading or uploading files in System Mode or for the execution of XFILE statement in BHT-BASIC.

This protocol should be selected for file transmission with Ir-Transfer Utility C/Ir-Transfer Utility E.

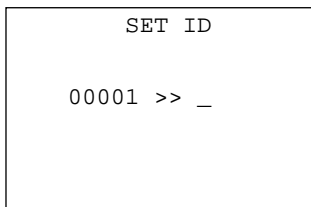

Select a desired item by using the numerical keys or **▲*** and **▼*** keys, and then press the **ENT** key.

To return to the SET COMMUNICATION menu, press the **C** key.

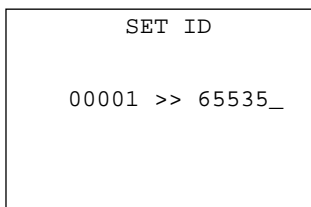

Selecting the "2:BHT-Ir Protocol" on the PROTOCOL TYPE screen calls up the screen shown at left.

Enter the ID number of the BHT-7000 by using the numerical keys, and then press the **ENT** key. If you do not need to modify the current setting, press the **ENT** key only.

NOTE An ID number should be five-digit decimal character string. The entry range is from 00001 to 65535. If the entry value is less than five digits, the **ENT** key will be deactivated.

If you make a wrong entry, press the **BS** key to delete it and then enter the correct data.

To return to the SET COMMUNICATION menu, press the **C** key.

* For BHT-7000s having a 26-key pad, use **F5**, **F6**, **F7** and **F8** keys instead of **▲**, **▼**, **◀**, and **▶** keys, respectively

[4.6] Defining the functions of the shift key and magic keys

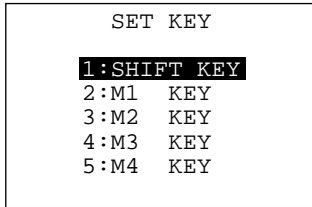

Selecting the "6:KEY" on the SET SYSTEM menu calls up the screen shown at left.

Highlighted is the current setting.

- 1 SHIFT KEY: Switches to the shift key definition screen.
- 2 M1 KEY: Switches to the M1 key definition screen.
- 3 M2 KEY: Switches to the M2 key definition screen.
- 4 M3 KEY: Switches to the M3 (left-hand trigger switch) key definition screen.
- 5 M4 KEY: Switches to the M4 key (right-hand trigger switch) definition screen.

Select a desired screen by using the numerical keys or ▲* and ▼* keys, and then press the ENT key.

To return to the SET SYSTEM menu, press the C key.

Defining the function of the shift key

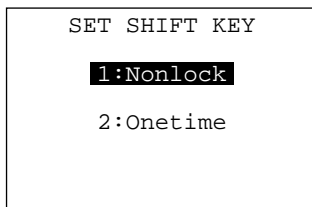

Selecting the "1:SHIFT KEY" on the SET KEY menu calls up the screen shown at left.

Highlighted is the current setting.

- 1 Nonlock: Shifts the keypad only when the SF key is held down.
- 2 Onetime: Shifts only one key pressed immediately after the SF key is pressed. (The following keys will not be shifted.)

Select a desired setting by using the numerical keys or ▲* and ▼* keys, and then press the ENT key. The screen returns to the SET KEY menu.

* For BHT-7000s having a 26-key pad, use F5, F6, F7 and F8 keys instead of ▲, ▼, ◀, and ▶ keys, respectively

Defining the function of **M1**, **M2**, **M3** (left-hand trigger switch), or **M4** (right-hand trigger switch) key

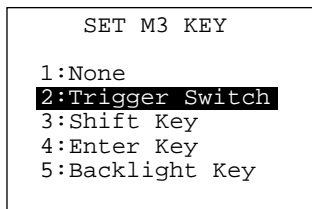

Selecting the "2:M1 KEY," "3:M2 KEY," "4:M3 KEY" or "5:M4 KEY" on the SET KEY menu calls up the screen as shown at left. (This example appears when the "4:M3 KEY.")

Highlighted is the current setting.

The **M1**, **M2**, **M3** or **M4** key can function as listed below.

- | | |
|--------------------------|---------------------------------------|
| 1 None: | The key entry will be ignored. |
| 2 Trigger Switch: | As the trigger switch. |
| 3 Shift Key: | As the SF key. |
| 4 Enter Key: | As the ENT key. |
| 5 Backlight Key: | As the backlight function on/off key. |

Select a desired setting by using the numerical keys or **▲*** and **▼*** keys, and then press the **ENT** key. The screen returns to the SET KEY menu.

Magic keys

The **M3** and **M4** keys are assigned the trigger switch function by default. You can make them function as the **SF** key, **ENT** key, or backlight function on/off key.

If you define the **M1** key as the backlight function on/off key, pressing the **M1** key activates or deactivates the backlight function.

In user programs, a string data also can be assigned to these magic keys.

NOTE

The backlight function on/off key can be assigned only to any one of **M1** through **M4** keys. The key defined more recently will act as the backlight function on/off key and one defined earlier will be ignored.

That is, if you define the **M1** and **M2** keys as the backlight function on/off key in this order, the **M2** key will work as the backlight function on/off key and the **M1** key's entry will be ignored.

* For BHT-7000s having a 26-key pad, use **F5**, **F6**, **F7** and **F8** keys instead of **▲**, **▼**, **◀**, and **▶** keys, respectively

[4.7] Setting the resume function

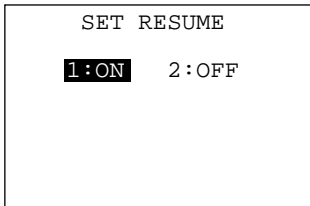

Selecting "7: RESUME" on the SET SYSTEM menu calls up the screen shown at left.

Highlighted is the current setting.

1 ON : Activates the resume function which resumes whatever display was shown before the power was turned off, when the BHT-7000 is powered up.

2 OFF : Deactivates the resume function.

Select a desired item by using the numerical keys or **▲*** and **▼*** keys, and then press the **ENT** key.

To return to the SET SYSTEM menu, press the **C** key.



* For BHT-7000s having a 26-key pad, use **F5**, **F6**, **F7** and **F8** keys instead of **▲**, **▼**, **◀**, and **▶** keys, respectively

[5] Testing

TEST	
1: BARCODE	2: MEMORY
3: BEEPER	4: AGING
5: LCD	6: FILE
7: COMMUNICATION	
8: KEY & VIBRATION	

Selecting "5: TEST" on the SYSTEM MENU calls up the screen shown at left.

- 1 BARCODE : Selects the bar-code reading test.
- 2 MEMORY : Selects the RAM read/write test.
- 3 BEEPER : Selects the beeper scale test.
- 4 AGING : Selects the aging test.
- 5 LCD : Selects the LCD and indicator LED tests.
- 6 FILE : Selects the file checksum test.
- 7 COMMUNICATION : Selects the communications test.
- 8 KEY & VIBRATION : Selects the key entry, beeper and vibrator tests.





Select a desired setting by using the numerical keys or * and * keys, and then press the **ENT** key. The selected test will start.

Highlighted is the currently selected item.

To return to the SYSTEM MENU, press the **C** key.

NOTE

If an error occurs in any of the above tests, contact your nearest dealer.

* For BHT-7000s having a 26-key pad, use **F5**, **F6**, **F7** and **F8** keys instead of , , , and  keys, respectively

[5.1] Bar-code reading test

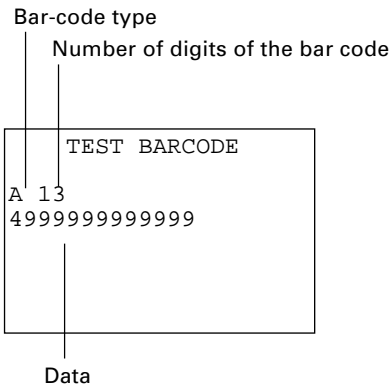
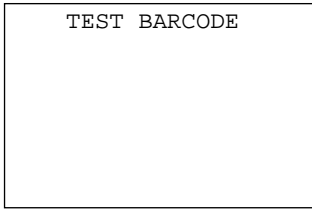

Selecting "1: BARCODE" on the TEST menu calls up the screen shown at left.

Actually read bar codes with the BHT-7000 and check the read data displayed on the LCD.

Upon completion of bar-code reading, the BHT-7000 beeps, turns on the indicator LED in green, and displays the read data together with the bar-code type and the number of data digits.

Up to 64-digit data can be shown and the excess will be discarded.

To return to the TEST menu, press the key.

Listed below is a table showing the relationship between the bar-code types and the identifier letters to be displayed on the LCD.

Bar-code Type	ID Letters
EAN-13, UPC-A	A
EAN-8	B
UPC-E	C
Standard 2 of 5 (STF)	H
Interleaved 2 of 5 (ITF)*	I
CODABAR	N
CODE39	M
CODE93	L
CODE128	K
EAN-128	W

* The BHT-7000 can read only those ITF bar codes having 4 digits or more in length.

[5.2] Memory test

```
TEST MEMORY
** Testing **
XXXXX/YYYYY
```

Selecting "2:MEMORY" on the TEST menu calls up the screen shown at left, and then starts writing and reading onto/from all areas of the RAM as well as checking the address.

XXXXX: Tested RAM capacity (unit: kilobytes)

YYYYY: Total RAM capacity (unit: kilobytes)

```
TEST MEMORY
** Test NG **
XXXXX/YYYYY
Address : ZZZZZZZZ
Write   : AAAAAAAA
Read    : BBBBBBBB
```

If any error is detected, the BHT-7000 beeps three times, shows the message as shown at left, and terminates the test.

Where,

ZZZZZZZZ: Address where an error has occurred.

AAAAAAA: Data to write.

BBBBBBB: Data read out from the RAM.

To return to the TEST menu, press the C key.

```
TEST MEMORY
** Test OK **
YYYYY/YYYYY
```

Upon normal completion of the RAM test, the BHT-7000 beeps once, shows the message as shown at left, and returns to the TEST menu.

[5.3] Beeper scale test

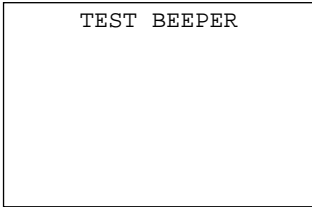

Selecting "3:BEEPER" on the TEST menu calls up the screen shown at left and makes the beeper sound at three octaves listed below.

Upon completion of this test, the BHT-7000 automatically returns to the TEST menu.

To stop this test while in progress, turn the power off and on.

Scale	Frequency (Hz)			
do	523	1046	2093	4186
re	587	1174	2349	-
mi	659	1318	2637	-
fa	698	1396	2793	-
sol	783	1567	3135	-
la	880	1760	3520	-
ti	987	1975	3951	-

[5.4] Aging test

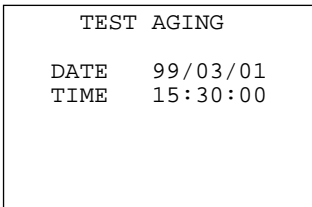

Selecting "4:AGING" on the TEST menu proceeds to the aging test while showing the current date and time on the LCD. (This test is intended for personnel which check the BHT-7000 in the factory.)

NOTE

Once this test is selected, the automatic powering-off function becomes disabled. Be sure to turn the power off or press the **[C]** key to return to the TEST menu.

[5.5] LCD and indicator LED tests



[BS] key ↑ ↓ [ENT] key

Selecting "5:LCD" on the TEST menu calls up the test pattern shown at left on the LCD and turns on the indicator LED in green.

Each time the [ENT] key is pressed, the screen shifts to the next test pattern. To return to the previous screen, press the [BS] key.

To stop this test while in progress, press the [C] key.

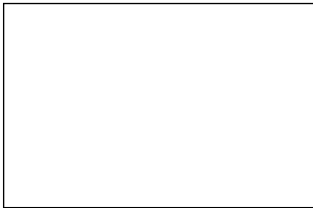

[BS] key ↑ ↓ [ENT] key

As shown at left, everything disappears and the indicator LED lights in red.

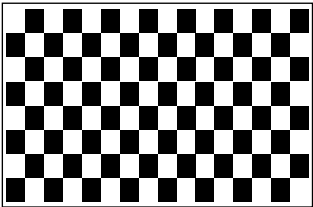

[BS] key ↑ ↓ [ENT] key

The checker pattern shown at left appears and the indicator LED goes off.

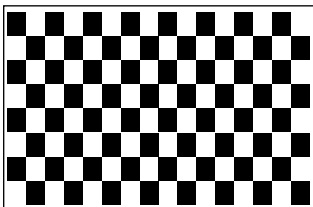

[BS] key ↑ ↓ [ENT] key

The checker pattern is reversed.



An outline with a width of one dot appears.

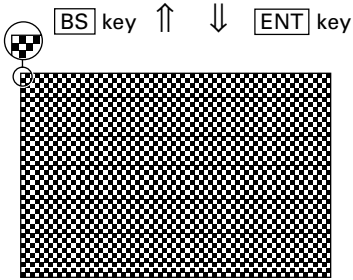

The fine checker pattern appears.

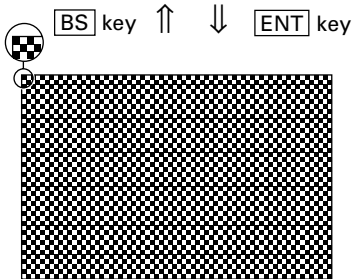

The fine checker pattern is reversed.

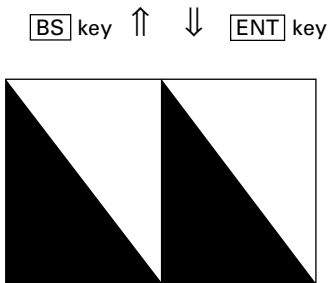

Two right-angled triangles appear.



Press the **ENT** key, and the BHT-7000 beeps once and returns to the TEST menu.

[5.6] File test

```
TEST FILE
SAMPLE01.PD3
SAMPLE02.PD3
SAMPLE03.PD3
SAMPLE04.PD3
SIZE:XXXXX
FREE:YYYYY
```

Selecting "6:FILE" on the TEST menu calls up the screen shown at left.

If any of the files stored in the memory is defective, an asterisk (*) will be prefixed to the name of the defective file(s).

If you select a file on this screen by using the * and * keys, the file size and the test result will appear. If there are more than four files, the screen will scroll.

Highlighted is the currently selected file.

Press the  key to return to the TEST menu.

```
TEST FILE
SAMPLE01.PD3
00004096 bytes
OK
SIZE:XXXXX
FREE:YYYYY
```

The file name, file size, and test result (OK or NG) appear as shown at left.









```
TEST FILE
SAMPLE01.PD3
00004096 bytes
NG
SIZE:XXXXX
FREE:YYYYY
```

Press the  key to return to the file selection screen.

NOTE

If a defective file is found, delete it or overwrite it with the same name file.

Even defective, the file can be uploaded on the UPLOAD menu. It is, therefore, recommended that important files be uploaded before deleted.

* For BHT-7000s having a 26-key pad, use , ,  and  keys instead of , , , and  keys, respectively

[5.7] Communications test

In System Mode, you may test the optical interface port and direct-connect interface port.

■ Preparation for the optical interface test

Arrange two BHT-7000s, one as a master station and the other as a slave station (to be tested) with their IR ports facing each other as illustrated below. In this test, the slave BHT-7000 transmits data to the master BHT-7000 and receives the data sent back from the master BHT-7000.

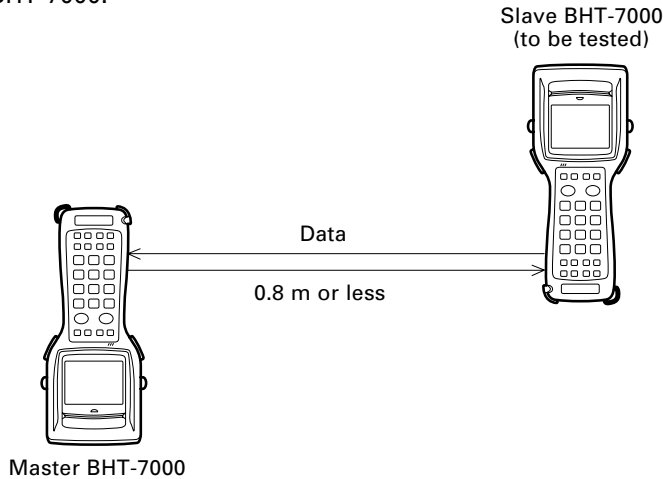

■ Preparation for the direct-connect interface test

Arrange the 3-pole mini stereo plug as illustrated below and connect it to the direct-connect interface port on the BHT-7000.

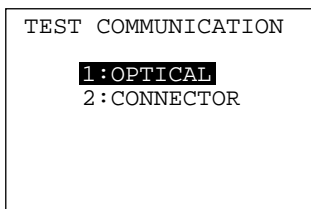
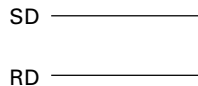

Selecting the "7:COMMUNICATION" on the TEST menu calls up the screen shown at left.

- 1 OPTICAL : Switches to the MASTER/SLAVE selection screen for the optical interface test.
- 2 CONNECTOR : Tests the direct-connect interface port.

Select a desired item by using the numerical keys or ▲* and ▼* keys, then press the ENT key.

* For BHT-7000s having a 26-key pad, use F5, F6, F7 and F8 keys instead of ▲, ▼, ◀, and ▶ keys, respectively

Testing the optical interface port

```
TEST COMMUNICATION
< OPTICAL >

1:SLAVE
2:MASTER
```

Selecting the "1:OPTICAL" on the TEST COMMUNICATION menu calls up the screen shown at left.

At the slave BHT-7000 to be tested, select the "1:SLAVE" and at the master BHT-7000, select the "2:MASTER."

```
TEST COMMUNICATION
< OPTICAL >

** Testing **
```

During the test, the screen shown at left is displayed.

```
TEST COMMUNICATION
< OPTICAL >

** Test NG **
(XX)
```

If any error occurs, the tested slave BHT-7000 beeps three times and shows the screen at left.

In parentheses are error codes which have the following meanings:

(X X)

- 1: The received data is different from the sent data.
- 2: A timeout has occurred during standby for data reception.

- 1: 2400 bps
- 2: 9600 bps
- 3: 115200 bps

Press the **[C]** key to return to the TEST COMMUNICATION menu.

The master BHT-7000 will automatically return to the TEST COMMUNICATION menu after 10 seconds from the occurrence of an error.

```
TEST COMMUNICATION
< OPTICAL >

** Test OK **
```

Upon normal completion of the test, the tested slave BHT-7000 beeps once and shows the screen at left.

Press the **[C]** key to return to the TEST COMMUNICATION menu.

The master BHT-7000 will automatically return to the TEST COMMUNICATION menu.

Testing the direct-connect interface port

```
TEST COMMUNICATION
< CONNECTOR >

** Testing **
```

Selecting the "2:CONNECTOR" on the TEST COMMUNICATION menu displays the screen shown at left and then starts testing the direct-connect interface port.

```
TEST COMMUNICATION
< CONNECTOR >

** Test NG **
  (XX)
```

If any error occurs, the BHT-7000 beeps three times and shows the screen at left.

In parentheses are error codes which have the following meanings:

(X X)

- 1: The received data is different from the sent data.
- 2: A timeout has occurred during standby for data reception.

- 1: 300 bps
- 2: 115200 bps

```
TEST COMMUNICATION
< CONNECTOR >

** Test OK **
```

Upon normal completion of the test, the BHT-7000 beeps once and shows the screen at left.

Press the **[C]** key to return to the TEST COMMUNICATION menu.

[5.8] Key entry & beeper test

TEST KEY & BEEPER
& VIBRATION

Selecting "8:KEY & VIBRATION" on the TEST menu calls up the screen shown at left and makes the BHT-7000 ready for entry from the keypad.

Pressing individual keys displays the identifier letters in the positions pre-assigned to those keys on the LCD as well as sounding the beeper or running the vibrator. (As long as the individual key is held down, the BHT-7000 continues beeping or vibrating.)

Pressing the same key again erases the displayed letter.

The table below shows the relationship between the keys, the identifier letters to be displayed on the LCD, and the frequencies (Hz) of the beeper.

32-key pad

Key	Letter	Beeper (Hz)	Key	Letter	Beeper (Hz)	Key	Letter	Beeper (Hz)
C	I	174	M3	T	(Note)	0	0	1567
ALP	J	195	M4	U	(Note)	.	.	1760
SF	K	220	7	7	659	ENT	=	1975
▲	L	246	8	8	698	F1	A	2093
▼	M	261	9	9	783	F2	B	2349
◀	N	293	4	4	880	F3	C	2637
▶	O	329	5	5	987	F4	D	2793
M1	P	349	6	6	1046	F5	E	3135
F9	Q	391	1	1	1174	F6	F	3520
F10	R	440	2	2	1318	F7	G	3951
M2	S	493	3	3	1396	F8	H	4186

26-key pad

Key	Letter	Beeper (Hz)	Key	Letter	Beeper (Hz)	Key	Letter	Beeper (Hz)
BS	I	261	9	9	659	ENT	=	1567
C	J	293	4	4	698	F1	A	1760
SF	K	329	5	5	783	F2	B	1975
M3	N	(Note)	6	6	880	F3	C	2093
M1	L	391	1	1	987	F4	D	2349
M2	M	440	2	2	1046	F5	E	2637
M4	O	(Note)	3	3	1174	F6	F	2793
7	7	523	0	0	1318	F7	G	3135
8	8	587	.	.	1396	F8	H	3520

(Note) Only when the **M3** (left-hand trigger switch) or **M4** key (right-hand trigger switch) is pressed, the vibrator works.

32-key pad

```
TEST KEY & BEEPER  
& VIBRATION  
  
IJKLMNO  
PQRSTU  
7894561230.=  
ABCDEFGH
```

After all keys are pressed and displayed on the LCD, this test automatically ends and the screen returns to the TEST menu.

To stop this test, turn the power off.

26-key pad

```
TEST KEY & BEEPER  
& VIBRATION  
  
IJK  
NLMO  
7894561230.=  
ABCDEFGH
```

[6] System Information

```
SYSTEM INFORMATION
SYSTEM Ver. : X.XXX
ROM SIZE   : XXMB
RAM SIZE   : XXXKB
SYSTEM MESSAGE:
           Japanese X.XX
FONT       ENT
```

BS key ↑ ↓ ENT key

```
SYSTEM INFORMATION
FONT       :
JIS1(16)  X.XX
JIS2(16)  X.XX
JIS1(12)  X.XX
JIS2(12)  X.XX
```

Selecting the "6:VERSION" on the SYSTEM MENU calls up the screen shown at left, displaying the system program version, ROM and RAM sizes, system message version, and font types and their versions.

Press the **C** key to return to the SYSTEM MENU.

The following font types are displayed:

JIS1 (16):	JIS Level 1 font, 16-dot
JIS2 (16):	JIS Level 2 font, 16-dot
JIS1 (12):	JIS Level 1 font, 12-dot
JIS2 (12):	JIS Level 2 font, 12-dot

[7] Deleting Files

You may delete a program file or data file stored in the memory.

File selection screen

```

DELETE FILE
SAMPLE01.PD3
SAMPLE02.PD3
SAMPLE03.PD3
SAMPLE04.PD3
SAMPLE05.PD3
SAMPLE06.PD3
    
```

Pressing the **[0]** key while holding down the **[SF]** key on the SYSTEM MENU calls up the screen shown at left.

Use the **[▲]*** and **[▼]*** keys to move the cursor to the file to be deleted, then press the **[ENT]** key.

Press the **[C]** key to return to the SYSTEM MENU.

```

DELETE FILE

*****
* NO FILE EXISTS *
*****
    
```

If no file is resident in the memory, the message shown at left appears.

Press the **[C]** key to return to the file deletion menu.

Deletion confirmation screen

```

DELETE FILE

SAMPLE01.PD3

Delete?
  1:Yes 2:No
    
```

Selecting a file to be deleted and then pressing the **[ENT]** key calls up the confirmation screen shown at left.

[1] Yes : Deletes the selected file.

[2] No : Cancels deletion and returns to the previous file selection screen.

Select a desired item by using the numerical keys, then press the **[ENT]** key.

Deletion completion screen

```

DELETE FILE

** Completed **
    
```

Upon completion of deletion, the screen shown at left appears.

Press the **[C]** key to return to the file selection screen.

* For BHT-7000s having a 26-key pad, use **[F5]**, **[F6]**, **[F7]** and **[F8]** keys instead of **[▲]**, **[▼]**, **[◀]**, and **[▶]** keys, respectively

[8] Downloading/Uploading the BHT System Parameter File

SYSTEM PARAMETER
transfer menu

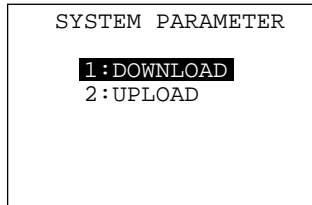

Pressing the **[3]** key while holding down the **[SF]** key on the SYSTEM MENU calls up the screen shown at left.

[1] DOWNLOAD: Downloads the BHT system parameter file to the user area of the BHT-7000.

[2] UPLOAD: Uploads the BHT system parameter file stored in the BHT-7000.

Select a desired item by using the numerical keys or **[▲]*** and **[▼]*** keys, then press the **[ENT]** key.

Press the **[C]** key to return to the SYSTEM MENU.

[8.1] Downloading the BHT system parameter file

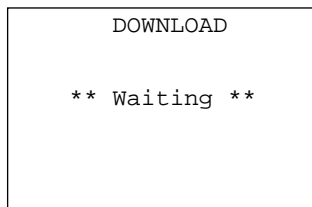

Selecting "1:DOWNLOAD" on the SYSTEM PARAMETER menu calls up the screen shown at left. With this screen displayed, the BHT-7000 waits for the BHT system parameter file to be downloaded.

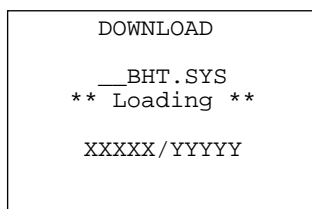

While the downloading operation is in progress, the screen shown at left is displayed indicating the file name and the number of received records/the total number of records.

To abort the downloading operation, press the **[C]** key. The screen will switch back to the SYSTEM PARAMETER menu.

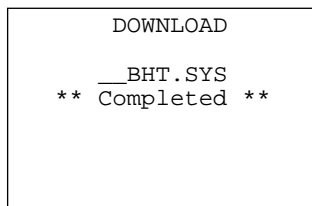

Upon completion of downloading, the BHT-7000 displayed the screen shown at left and beeps once.

Press the **[C]** key to return to the SYSTEM PARAMETER menu.

* For BHT-7000s having a 26-key pad, use **[F5]**, **[F6]**, **[F7]** and **[F8]** keys instead of **[▲]**, **[▼]**, **[◀]**, and **[▶]** keys, respectively

If an error occurs during downloading

If some error occurs during downloading, the BHT-7000 beeps three times and shows one of the following screens with the prompt "Retry?":

To retry the download, press the **[1]** and **[ENT]** keys; to abort it, press the **[2]** and **[ENT]** keys.

To return to the SYSTEM PARAMETER menu, press the **[C]** key.

```

DOWNLOAD

Out of memory!!

Retry?
  1:Yes 2:No
    
```

■ Problem

The memory is insufficient for storing the BHT system parameter file to be downloaded.

■ Solution

Press the **[2]** key to return to the SYSTEM MENU, then delete unnecessary files in the memory. (Refer to Subsection 2.6.3, [7].)

```

DOWNLOAD

File mismatch!!

Retry?
  1:Yes 2:No
    
```

■ Problem

You attempted to download a file other than the BHT system parameter file.

■ Solution

Check whether the file you attempted to download is the BHT system parameter file.

```

DOWNLOAD

Too many files!!

Retry?
  1:Yes 2:No
    
```

■ Problem

The current download will exceed the maximum of 80 files in the memory.

■ Solution

Press the **[2]** key to return to the SYSTEM MENU, then delete unnecessary files in the memory. (Refer to Subsection 2.6.3, [7].)

```

DOWNLOAD

__BHT/SYS
Communication error!!

Retry?
  1:Yes 2:No
    
```

■ Problem

Downloading has failed.

■ Solution

To retry downloading, press the **[1]** key.

To return to the SYSTEM MENU, press the **[2]** key. Check the interface port and communications parameters in the SET SYSTEM menu or perform the communications test in the TEST menu. (Refer to Subsection 2.6.3, [4.5] and [5.7].)

It is also necessary to check the communications parameters setup of the host computer.

[8.2] Uploading the BHT system parameter file

```
UPLOAD
** Waiting **
```



```
UPLOAD
  _BHT.SYS
** Loading **
XXXXX/YYYYY
```



```
UPLOAD
  _BHT.SYS
** Completed **
```

Selecting "2:UPLOAD" on the SYSTEM PARAMETER menu calls up the screen shown at left. With this screen displayed, the BHT-7000 waits for the BHT system parameter file to be uploaded.

While the uploading operation is in progress, the screen shown at left is displayed indicating the file name and the number of sent records/the total number of records.

To abort the uploading operation, press the **C** key. The screen will switch back to the SYSTEM PARAMETER menu.

Upon completion of uploading, the BHT-7000 displayed the screen shown at left and beeps once.

Press the **C** key to return to the SYSTEM PARAMETER menu.

If an error occurs during uploading

If some error occurs during uploading, one of the following screens will appear and the beeper beeps three times.

To retry the uploading operation, press the **[1]** and **[ENT]** keys; to abort it, press the **[2]** and **[ENT]** keys.

Press the **[C]** key to return to the SYSTEM PARAMETER menu.

```

      UPLOAD

      Out of memory!!
  
```

■ Problem

The memory is insufficient for setting up the BHT system parameter file to be uploaded.

■ Solution

Press the **[C]** key to return to the SYSTEM MENU, then delete unnecessary files in the memory. (Refer to Subsection 2.6.3, [7].)

```

      UPLOAD

      Too many files!!
  
```

■ Problem

The memory has already contained 80 files, so the BHT system parameter file cannot be set up.

■ Solution

Press the **[C]** key to return to the SYSTEM MENU, then delete unnecessary files in the memory. (Refer to Subsection 2.6.3, [7].)

```

      UPLOAD

      __BHT.SYS
      Communication error!!

      Retry!
      1:Yes 2:No
  
```

■ Problem

Uploading has failed.

■ Solution

To retry uploading, press the **[1]** key.

To return to the SYSTEM MENU, press the **[2]** key. Check the interface port and communications parameters in the SET SYSTEM menu or perform the communications test in the TEST menu. (Refer to Subsection 2.6.3, [4.5] and [5.7].)

It is also necessary to check the communications parameters setup of the host computer.

[9] Setting the Remote Wakeup

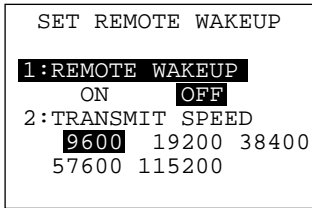

Pressing the **[4]** key while holding down the **[SF]** key on the SYSTEM MENU calls up the screen shown at left.

[1] REMOTE WAKEUP: Activates or deactivates the remote wakeup function.

[2] TRANSMIT SPEED: Sets the transmission speed for the remote wakeup.

Select a desired item by using the numerical keys or **[▲]*** and **[▼]*** keys. Then select a desired setting by using the **[◀]*** and **[▶]*** keys.

To return to the SYSTEM MENU, press the **[C]** key.

* For BHT-7000s having a 26-key pad, use **[F5]**, **[F6]**, **[F7]** and **[F8]** keys instead of **[▲]**, **[▼]**, **[◀]**, and **[▶]** keys, respectively

[10] Downloading/Uploading the System Message File

SYSTEM MESSAGE transfer menu

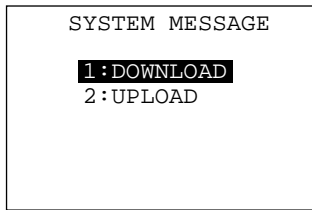

Pressing the **[6]** key while holding down the **[SF]** key on the SYSTEM MENU calls up the screen shown at left.

[1] DOWNLOAD: Downloads the system message file to the user area of the BHT-7000.

[2] UPLOAD: Uploads the system message file stored in the BHT-7000.

Select a desired item by using the numerical keys or **[▲]*** and **[▼]*** keys, then press the **[ENT]** key.

Press the **[C]** key to return to the SYSTEM MENU.

[10.1] Downloading the system message file

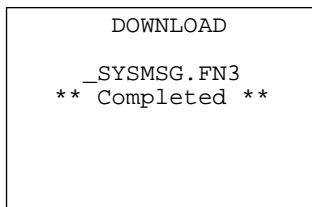
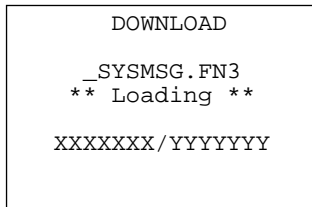
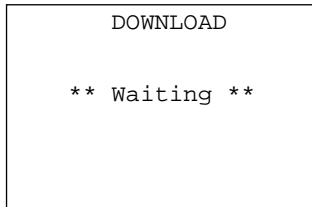

Selecting "1:DOWNLOAD" on the SYSTEM MESSAGE menu calls up the screen shown at left. With this screen displayed, the BHT-7000 waits for the system message file to be downloaded.

While the downloading operation is in progress, the screen shown at left is displayed indicating the file name and the number of received records/the total number of records.

To abort the downloading operation, press the **[C]** key. The screen will switch back to the SYSTEM MESSAGE menu.

Upon completion of downloading, the BHT-7000 displays the screen shown at left and beeps once.

Press the **[C]** key to return to the SYSTEM PARAMETER menu.

NOTE

When the BHT-7000 downloads the system message file, it creates a temporary file named "_SYSMSG.FN3" in the user area. If the user area is insufficient for creating the temporary file, therefore, an error will result.

The created temporary file will be automatically deleted after completion of downloading.

* For BHT-7000s having a 26-key pad, use **[F5]**, **[F6]**, **[F7]** and **[F8]** keys instead of **[▲]**, **[▼]**, **[◀]**, and **[▶]** keys, respectively

If an error occurs during uploading

If some error occurs during downloading, the BHT-7000 beeps three times and shows one of the following screens with the prompt "Retry?":

To retry the download, press the **[1]** and **[ENT]** keys; to abort it, press the **[2]** and **[ENT]** keys.

To return to the SYSTEM MESSAGE menu, press the **[C]** key.

```
DOWNLOAD

Out of memory!!

Retry?
 1:Yes 2:No
```

■ Problem

The memory is insufficient for storing the system message file to be downloaded.

■ Solution

Press the **[2]** key to return to the SYSTEM MENU, then delete unnecessary files in the memory. (Refer to Subsection 2.6.3, [7].)

```
DOWNLOAD

File mismatch!!

Retry?
 1:Yes 2:No
```

■ Problem

You attempted to download a file other than the system message file.

■ Solution

Check whether the file you attempted to download is the system message file.

```
DOWNLOAD

Too many files!!

Retry?
 1:Yes 2:No
```

■ Problem

The current download will exceed the maximum of 80 files in the memory.

■ Solution

Press the **[2]** key to return to the SYSTEM MENU, then delete unnecessary files in the memory. (Refer to Subsection 2.6.3, [7].)

```
DOWNLOAD

_SYSMSG.FN3
Communication error!!

Retry?
 1:Yes 2:No
```

■ Problem

Downloading has failed.

■ Solution

To retry downloading, press the **[1]** key.

To return to the SYSTEM MENU, press the **[2]** key. Check the interface port and communications parameters in the SET SYSTEM menu or perform the communications test in the TEST menu. (Refer to Subsection 2.6.3, [4.5] and [5.7].)

[10.2] Uploading the system message file

```

UPLOAD

** Waiting **
    
```



```

UPLOAD

 _SYSMSG.FN3
** Loading **

XXXXXXXX/YYYYYYY
    
```



```

UPLOAD

 _SYSMSG.FN3
** Completed **
    
```

Selecting "2:UPLOAD" on the SYSTEM MESSAGE menu calls up the screen shown at left. With this screen displayed, the BHT-7000 waits for the system message file to be uploaded.

While the uploading operation is in progress, the screen shown at left is displayed indicating the file name and the number of sent records/the total number of records.

To abort the uploading operation, press the **[C]** key. The screen will switch back to the SYSTEM MESSAGE menu.

Upon completion of uploading, the BHT-7000 displayed the screen shown at left and beeps once.

Press the **[C]** key to return to the SYSTEM PARAMETER menu.

NOTE

When the BHT-7000 uploads the system message file, it creates a temporary file named "_SYSMSG.FN3" in the user area. If the user area is insufficient for creating the temporary file, therefore, an error will result.

The created temporary file will be automatically deleted after completion of uploading.

If an error occurs during uploading

If some error occurs during uploading, one of the following screens will appear and the beeper beeps three times.

To retry the uploading operation, press the **[1]** and **[ENT]** keys; to abort it, press the **[2]** and **[ENT]** keys.

Press the **[C]** key to return to the SYSTEM MESSAGE menu.

```
      UPLOAD
      Out of memory!!
```

■ Problem

The memory is insufficient for setting up the system message file.

■ Solution

Press the **[C]** key to return to the SYSTEM MENU, then delete unnecessary files in the memory. (Refer to Subsection 2.6.3, [7].)

```
      UPLOAD
      Too many files!!
```

■ Problem

The memory has already contained 80 files, so the BHT system message file cannot be set up.

■ Solution

Press the **[C]** key to return to the SYSTEM MENU, then delete unnecessary files in the memory. (Refer to Subsection 2.6.3, [7].)

```
      UPLOAD
      _SYSMSG.FN3
      Communication error!!
      Retry!
      1:Yes 2:No
```

■ Problem

Uploading has failed.

■ Solution

To retry uploading, press the **[1]** key.

To return to the SYSTEM MENU, press the **[2]** key. Check the interface port and communications parameters in the SET SYSTEM menu or perform the communications test in the TEST menu. (Refer to Subsection 2.6.3, [4.5] and [5.7].)

It is also necessary to check the communications parameters setup of the host computer.

Chapter 3

Communications Operations of BHT-7000

This chapter describes the communications operations of the BHT-7000--the RS-232C interface specifications, the basic communications specifications, and the communications protocols--for data transmission with the host computer or other devices.

3.1 RS-232C Interface Specifications	8 6
3.2 Basic Communications Specifications and Parameters....	8 8
3.2.1 Basic Communications Specifications	8 8
3.2.2 Communications Parameters.....	9 0
3.3 Communications Protocols	9 1
3.3.1 BHT-protocol	9 1
[1] Overview.....	9 1
[2] Control Characters	9 2
[3] Basic Format of Transmission Messages	9 4
[4] Text Format	9 5
3.3.2 BHT-Ir Protocol.....	9 7
[1] Overview.....	9 7
[2] Control Characters	9 8
[3] Basic Format of Transmission Messages	1 0 0
[4] Text Format	1 0 1

3.1 RS-232C Interface Specifications

[1] Interface Connector and Pin Assignment

The BHT-7000 has a direct-connect interface port which is connectable to the 3-pole mini stereo plug (ø2.5 mm or 0.1") and supports a subset of the RS-232C interface as shown below.

Using a direct-connect interface cable having the mini stereo plugs makes it possible to connect the BHT-7000 to a host computer (or another BHT-7000) directly without any routing through the CU-7000.

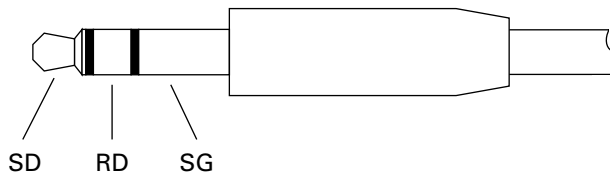

3-pole Mini Stereo Plug (ø2.5 mm or 0.1")

The poles of the plug are assigned as listed below.

Signal Name	Function	Signal Input/Output	
		BHT-7000	External device
SD	Send data	→	
RD	Receive data	←	
SG	Signal ground		

The input/output voltage threshold for the logical valued signal is listed below.

Logical Value	Input Voltage Threshold	Output Voltage Threshold
	(RD)	(SD)
0	3V min.	5V min.
1	-3V max.	-5V max.

NOTE

The direct-connect interface port is not designed to stand frequent connecting/disconnecting. Do not plug and unplug basically more than one time a day; otherwise, the service life of the plug will shorten. To connect the BHT-7000 to a host computer having no IR port (or another BHT-7000) frequently, use the CU-7000.

NOTE

Allow the specified signals only to enter the direct-connect interface port. Entry of other signals will result in a failure or malfunction of the BHT-7000.

[2] Interface Cable Connection

Connect the BHT-7000 directly to a host computer, a modem, or a printer with a direct-connect interface cable as illustrated below.

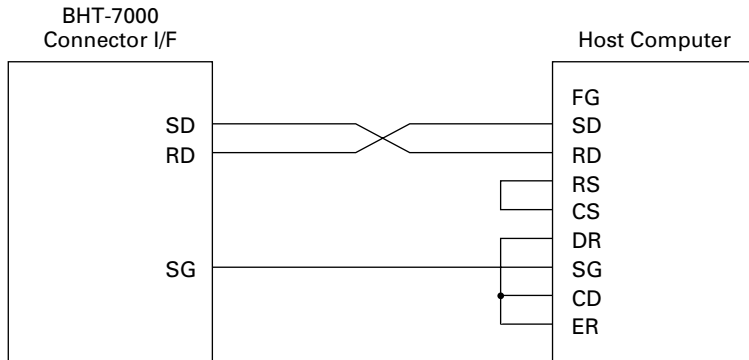

Cable Connection between BHT-7000 and Host Computer

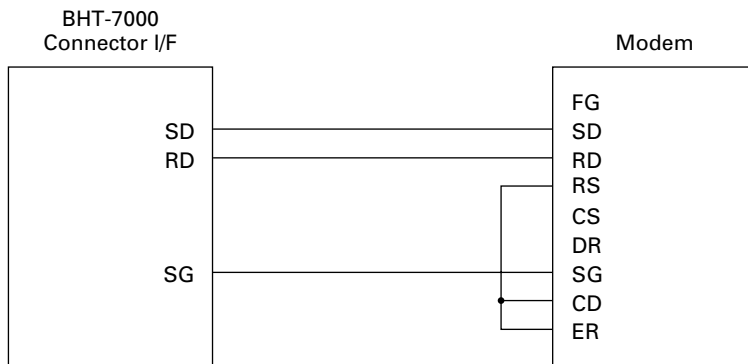

Cable Connection between BHT-7000 and Modem

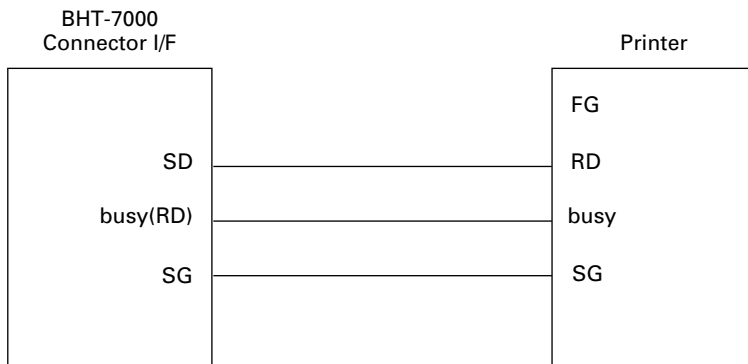

Cable Connection between BHT-7000 and Printer

3.2 Basic Communications Specifications and Parameters

3.2.1 Basic Communications Specifications

Listed below are the communications specifications when the BHT-7000 exchanges data with a host computer through the CU-7000 (optical interface) or direct-connect interface cable.

	Optical Interface	Direct-connect Interface
Synchronization	Start-stop	
Transmission Speed	2400, 9600, 19200, 38400, 57600, or 115200 bps	300, 600, 1200, 2400, 4800, 9600, 19200, 38400, 57600, or 115200 bps
Transmission Code	JIS 8-bit codes	JIS 7- or 8-bit codes
Transmission Bit Order	LSB (Least significant bit) first	
Vertical Parity	None	Even, odd, or none

■ Synchronization

For accurate data transaction, it is very important to synchronize the transmission between the sender and receiver. To do this, it is required to previously define the bit order and position, the character length, and the beginning and end of the character to be transmitted.

The start-stop synchronization is an asynchronous system which synchronizes each character as a unit; that is, it externally adds start and stop bits to the leading and trailing bit positions of the character to be transmitted, respectively. A clock starts counting on receiving the start bit and it falls into a non-communication state on receiving the stop bit. The number of the stop bits is selectable (1 or 2 bits).

■ Transmission Speed

Maximum number of bits to be transmitted per second. Expressed in bps (bits per second).

■ Optical Interface Communications Range

The optical interface's maximum effective range is 80 cm (31.5 in.) with the IR beam within a 10° angle of divergence.

■ Switching Time between Sending and Receiving on Optical Interface

The optical interface should satisfy the following requirements in switching between sending and receiving:

- (1) Within 10 ms from completion of sending, the optical interface should become ready to receive.
- (2) After 10 ms or more from completion of receiving, the optical interface should start sending.

■ **Transmission Code and Bit Order**

All characters should be coded to 7- or 8-bit code for data transmission. The standard data exchange code of the BHT-7000 is JIS 7- or 8-bit code. The transmission bit order is LSB (Least significant bit) first.

What follows is an example for transmitting character A (41h, 01000001b) coded to JIS 8-level code with an even parity and a single bit each for start and stop bits.

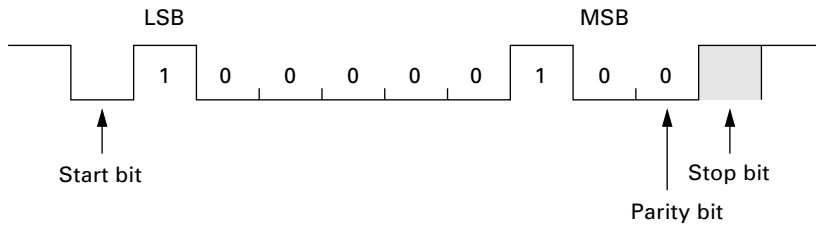

■ **Vertical Parity**

A vertical parity bit is a redundancy bit which is added to every character to be transmitted in order to check that data has been transmitted accurately. The parity bit should be set to "1" or "0" depending upon the parity parameter setting, to make the number of set bits in the character even or odd. The receiver counts the number of set bits in the transmitted character code to make sure that it has the selected number (even or odd) of set bits.

The vertical parity bit is positioned immediately following the MSB (Most significant bit) as shown below.

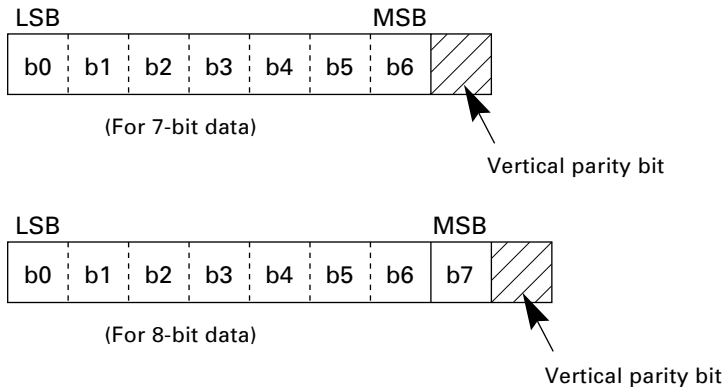

3.2.2 Communications Parameters

In System Mode and user programs written in BHT-BASIC, you may set the communications parameters listed below.

Communications Port	Optical interface	Direct-connect interface
Transmission Speed	2400, 9600, 19200, 38400, 57600, or 115200 bps	300, 600, 1200, 2400, 4800, 9600, 19200, 38400, 57600, or 115200 bps
Character Length	8 bits	7 or 8 bits
Vertical Parity	None	Odd, even, or none
Stop Bit Length	1 bit	1 or 2 bits

In System Mode

Refer to Chapter 2, Subsection 2.6.3, [4.5], "Setting the communications environments."

In BHT-BASIC

To set the transmission speed, character length, vertical parity, and stop bit length (To set the transmission speed only for the optical interface), use the `OPEN "COM: "` statement in BHT-BASIC.

<code>OPEN "COM: ... "</code>	Opens the interface port selected in System Mode.
<code>OPEN "COM1: ... "</code>	Opens the optical interface port for data transmission routing through the CU-7000, irrespective of the setting in System Mode.
<code>OPEN "COM2: ... "</code>	Opens the direct-connect interface port for data transmission, irrespective of the setting in System Mode.

Note that it is impossible to open both the optical interface port and the direct-connect interface port concurrently.

Through the interface port opened by the `OPEN "COM: "` statement, the `XFILE` statement transmits a designated file.

3.3 Communications Protocols

The BHT-7000 supports both the BHT-protocol and the BHT-Ir protocol for file transmission.

3.3.1 BHT-protocol

[1] Overview

The BHT-protocol is the communications procedure used to transmit files between the BHT-7000 and a host (or between the BHT-7000s). It adopts the response method using ACK/NAK codes.

The BHT-protocol is composed of a defined set of the control character sequences including the following three phases:

Phase 1: Establishment of data link

The sending station confirms that the receiving station is ready to receive data.

Phase 2: Data transmission

The sending station transmits data to the target receiving station.

Phase 3: Release of data link

The sending station confirms whether or not all of the transmitted data has been correctly received by the receiving station. If yes, the sending station terminates the data transmission and releases the data link.

For details about the transmission control sequences and horizontal parity checking, refer to Appendix B, B.1, "BHT-protocol."

[2] Control Characters

The control characters are classified into two groups: transmission control characters and text control characters.

(1) Transmission control characters

The transmission control characters listed below are used to compose transmission control sequences in phases 1 through 3.

Symbol	Value	Meaning	Function
EOT	04h	End Of Transmission	Releases a data link (Phase 3). Requests abort of transmission (Phase 2).
ENQ	05h	Enquiry	Requests establishment of a data link (Phase 1). Prompts the receiver to respond to the sent text (Phase 2).
ACK	06h	Acknowledge	Acknowledgment response to ENQ (Phase 1). Acknowledgment response to text (Phase 2). Acknowledgment response to EOT (Phase 3).
NAK	15h	Negative Acknowledge	Negative acknowledgment response to ENQ (Phase 1). Negative acknowledgment response to text (Phase 2).

■ Transparency

The BHT-7000 uses the non-transparent mode which handles the control characters and codes (e.g., STX, ETX, and SOH) as starting or ending markers and does not allow them to be transmitted as normal data in the transmission texts.

(2) Text control characters

The text control characters are used to format transmission texts. In the BHT-protocol, they include the following headers and a terminator.

Symbol	Value	Meaning	Function
SOH	01h	Start Of Heading	Indicates the start of heading text (Phase 2).
STX	02h	Start Of Text	Indicates the start of data text (Phase 2).
ETX	03h	End Of Text	Indicates the end of data text (Phase 2).

You may designate headers and a terminator with the protocol functions in BHT-BASIC. If you designate none of them in a user program, the BHT-7000 may apply those as listed above. Refer to the "BHT-BASIC Programmer's Manual."

[3] Basic Format of Transmission Messages

Basically, the BHT-7000 transmits data as units of a file. First, it transmits a heading text which includes the attribute information of a file (e.g., file name and the number of data texts) to be transmitted. Following the heading text, it transmits the data text in the file. A heading text and data text comprise a text.

In actual text transmission, the text is divided into several blocks, then a header and terminator are added to each block. If the serial number management or error checking by BCC (Block Check Character) is required, the serial number or BCC is also added to each block, respectively. This procedure forms a transmission block. A set of transmission blocks makes up one transmission message.

Shown below is an example of a transmission message formed with the BHT-protocol.

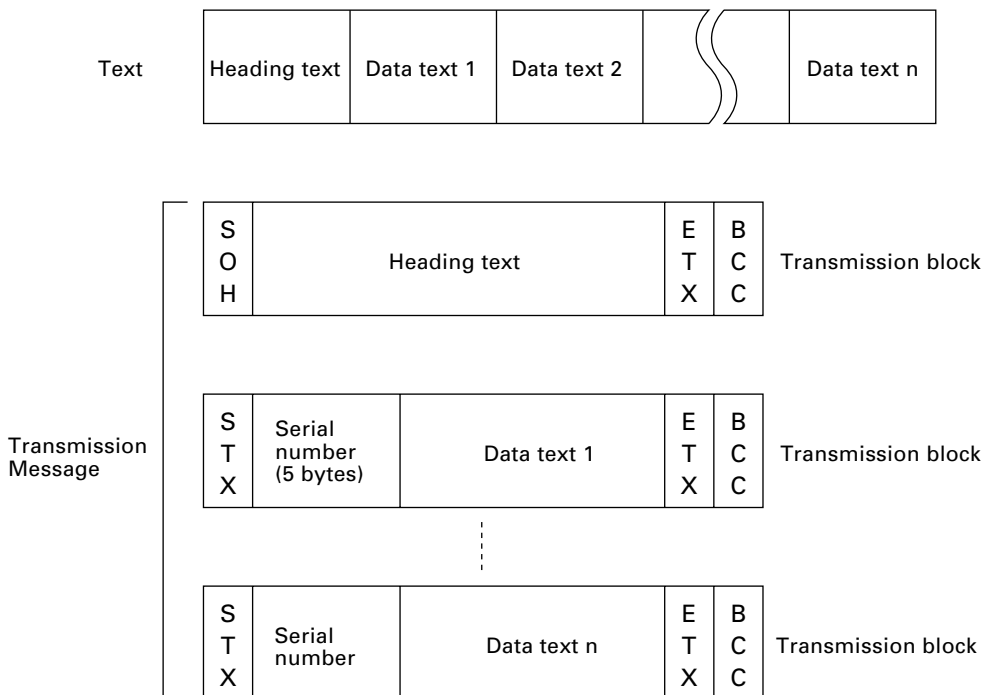

In the above figure, SOH, STX, and ETX are text control characters as described in [2] Control Characters, (2). A serial number is expressed by a five-digit decimal number, starting from 00001 to 32767, and identifies transmitted data texts. For the BCC, refer to Appendix B, B.1, "BHT-protocol," [3].

[4] Text Format

Text should be formatted according to the standard of the BHT-protocol before transmission. Shown below are two types of the standard text formats for program files and data files.

■ Program Text Format

(1) Heading text

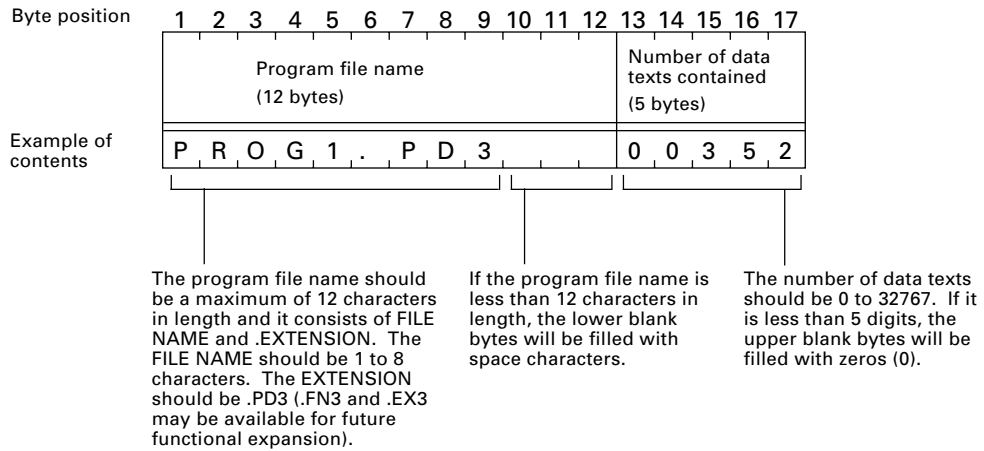

(2) Data text

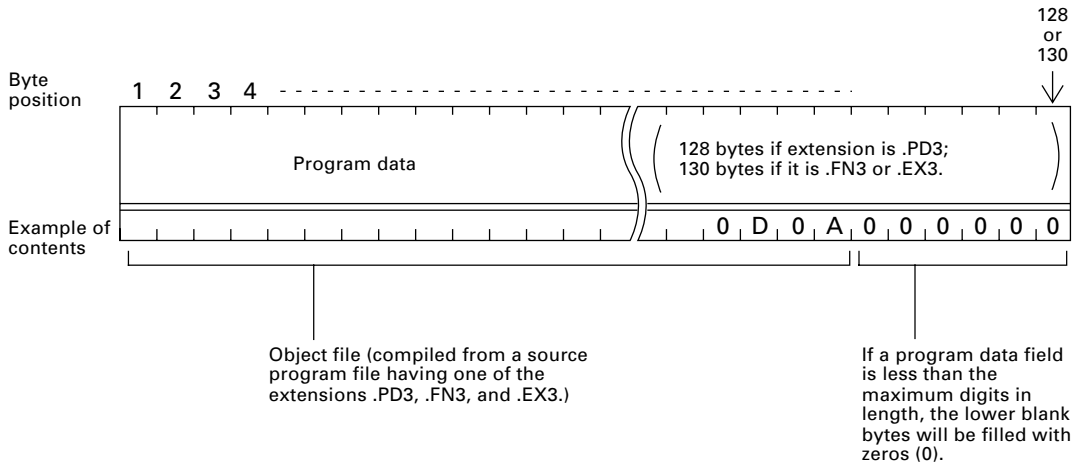

■ Data Text Format

(1) Heading text

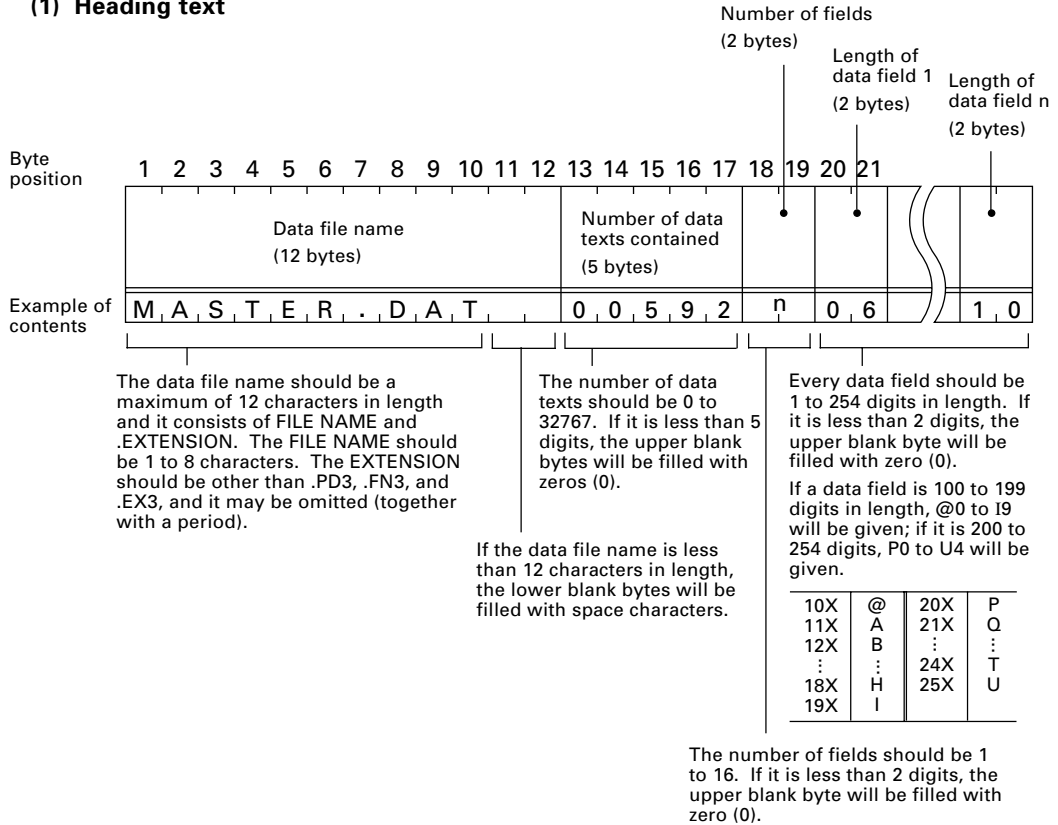

NOTE

To transfer a data file containing a data field(s) of 100 digits or more, use the Windows-based Transfer Utility. The MS-DOS-based Transfer Utility does not support transmission of data fields exceeding 99 digits.

(2) Data text

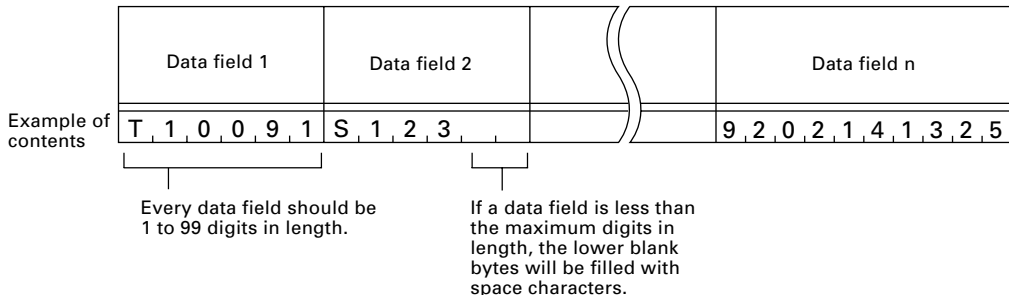

NOTE

The total length of all data fields plus the number of the character count bytes (= the number of the fields) should be 255 bytes or less.

When you transfer five 50-digit (50-byte) fields, for example, the total length of all data fields is 250 (50 x 5) bytes and the number of the character count bytes is 5. Accordingly, the total is 255, so you can transfer the file.

3.3.2 BHT-Ir Protocol

[1] Overview

The BHT-Ir protocol is the communications procedure for the serial infrared link, which is used to transmit files between the BHT-7000 and a host (or between the BHT-7000s). It adopts the response method using ACK/NAK codes. The BHT-Ir protocol can be used also for communications through the direct-connect interface.

The BHT-Ir protocol is composed of a defined set of the control character sequences including the following three phases:

Phase 1: Establishment of data link

The sending station confirms that the receiving station is ready to receive data.

Phase 2: Data transmission

The sending station transmits data to the target receiving station.

Phase 3: Release of data link

The sending station confirms whether or not all of the transmitted data has been correctly received by the receiving station. If yes, the sending station terminates the data transmission and releases the data link.

For details about the transmission control sequences and CRC, refer to Appendix B, B.2, "BHT-Ir protocol."

[2] Control Characters

The control characters are classified into two groups: transmission control characters and text control characters.

(1) Transmission control characters

The transmission control characters listed below are used to compose transmission control sequences in phases 1 through 3.

Symbol	Value	Meaning	Function
DLE EOT	1004h	End Of Transmission	Releases a data link (Phase 3). Requests abort of transmission (Phase 2).
DLE ENQ	1005h	Enquiry	Requests establishment of a data link (Phase 1). Prompts the receiver to respond to the sent text (Phase 2).
DLE ACK	1006h	Acknowledge	Acknowledgment response to DLE ENQ (Phase 1). Acknowledgment response to text (Phase 2). Acknowledgment response to DLE EOT (Phase 3).
DLE NAK	1015h	Negative Acknowledge	Negative acknowledgment response to DLE ENQ (Phase 1). Negative acknowledgment response to text (Phase 2).
WACK	103Bh	Wait for Acknowledge	Requests suspension of data reception during erasure of the flash memory.

■ Transparency

The BHT-7000 uses the transparent mode which allows the control characters and codes (e.g., STX, ETX, SOH, and DLE) to be transmitted as normal data in the transmission texts.

To transmit a DLE as normal data, type DLE DLE per DLE.

(2) Text control characters

The text control characters are used to format transmission texts. In the BHT-Ir protocol, they include the following headers and a terminator.

Symbol	Value	Meaning	Function
DLE SOH	1001h	Start Of Heading	Indicates the start of heading text (Phase 2).
DLE STX	1002h	Start Of Text	Indicates the start of data text (Phase 2).
DLE ETX	1003h	End Of Text	Indicates the end of data text (Phase 2).

In the BHT-Ir protocol, you cannot change the values of the headers and terminator with the protocol functions in BHT-BASIC.

[3] Basic Format of Transmission Messages

Basically, the BHT-7000 transmits data as units of a file. First, it transmits a heading text which includes the attribute information of a file (e.g., file name and the number of data texts) to be transmitted. Following the heading text, it transmits the data text in the file. A heading text and data text comprise a text.

In actual text transmission, the text is divided into several blocks, then a header, terminator, serial number, receiver station's ID, and CRC-16 (Cyclic Redundancy Check) are added to each block. This procedure forms a transmission block. A set of transmission blocks makes up one transmission message.

Shown below is an example of a transmission message formed with the BHT-Ir protocol.

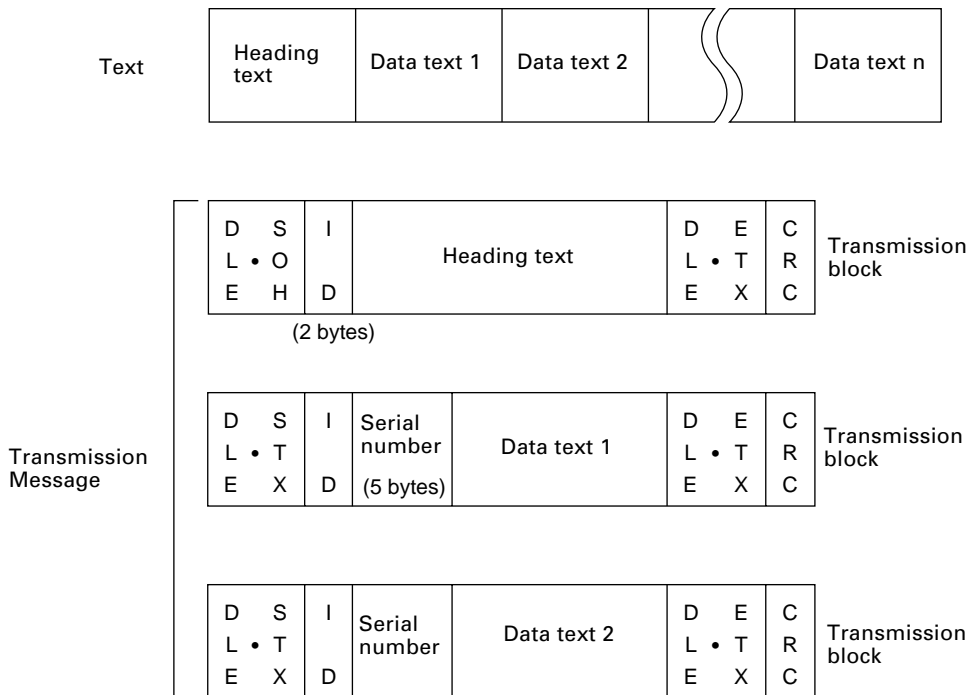

In the above figure, DLE SOH, DLE STX and DLE ETX are text control characters as described in [2] Control Characters, (2). An ID denotes the ID number of the receiver station, expressed by two bytes. A serial number is expressed by a five-digit decimal number, starting from 00001 to 32767, and identifies data texts. For the CRC-16, refer to Appendix B, B.2, "BHT-Ir protocol," [3].

TIP You can use the control characters for expressing IDs, serial numbers, or text data.

[4] Text Format

Text should be formatted according to the standard of the BHT-Ir protocol before transmission. Shown below are two types of the standard text formats for program files and data files.

■ Program Text Format

(1) Heading text

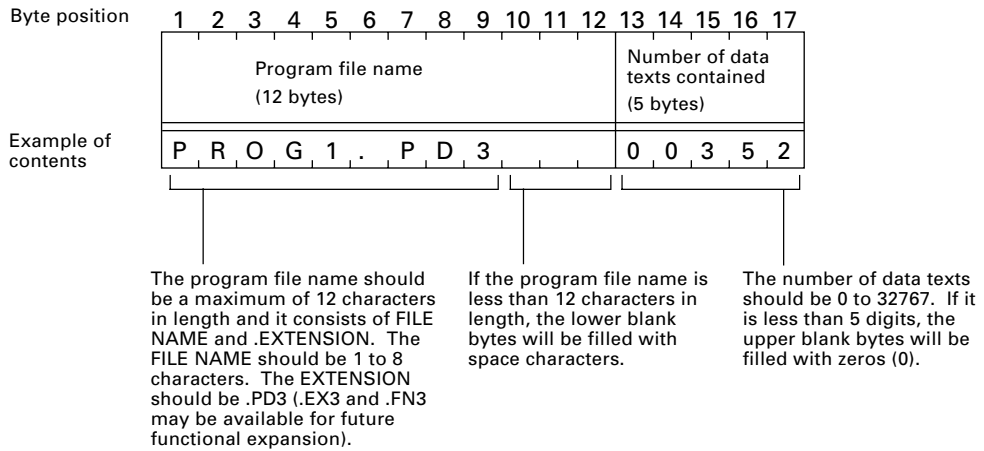

(2) Data text

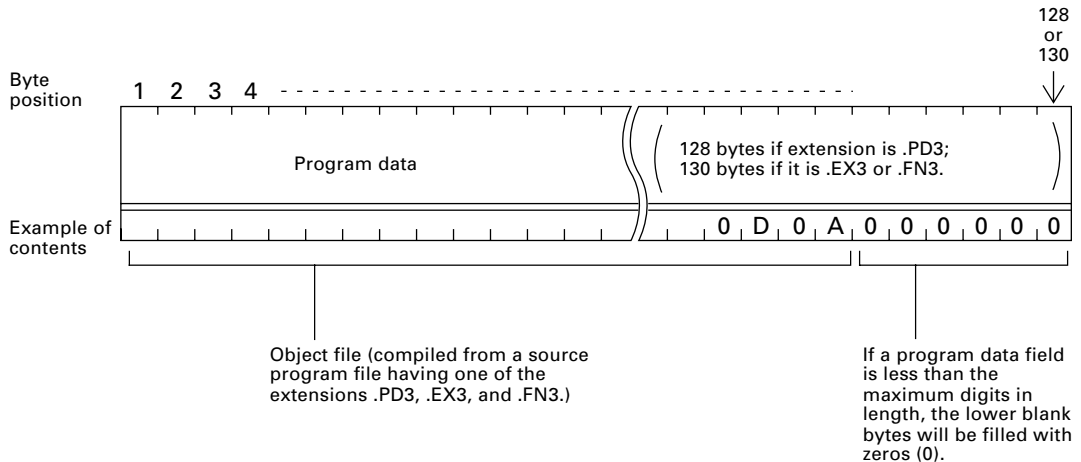

■ Data Text Format

(1) Heading text

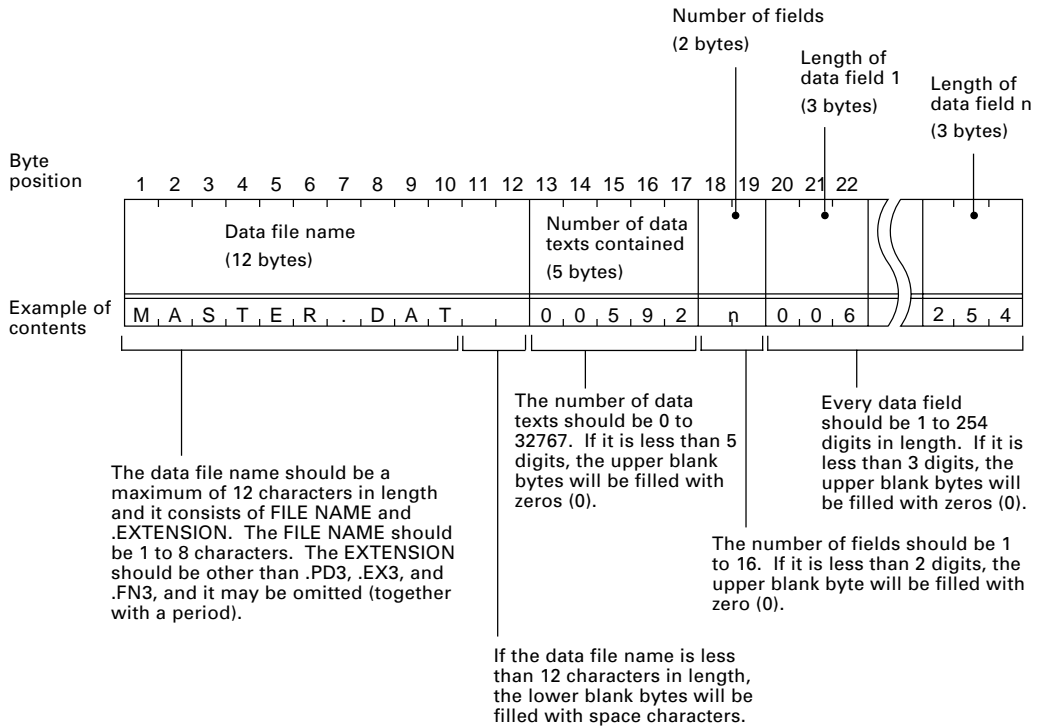

(2) Data text

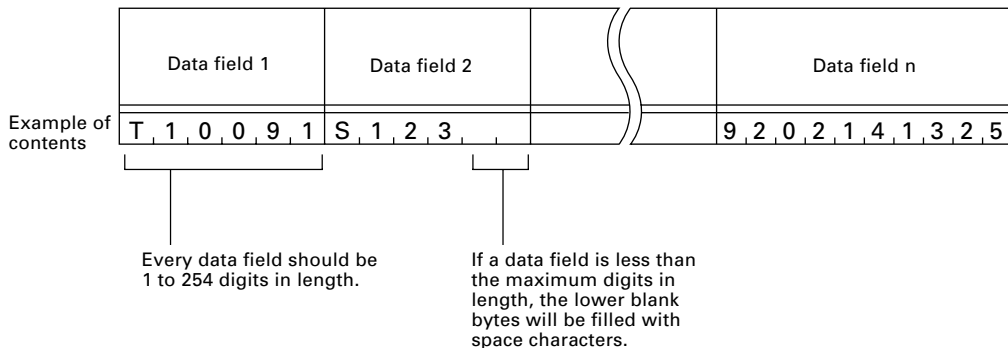

NOTE

The total length of all data fields plus the number of the character count bytes (= the number of the fields) should be 255 bytes or less.

When you transfer five 50-digit (50-byte) fields, for example, the total length of all data fields is 250 (50 x 5) bytes and the number of the character count bytes is 5. Accordingly, the total is 255, so you can transfer the file.

This chapter lists the error messages which will appear on the LCD if some error occurs in the BHT-7000.

4.1	System Errors	104
4.2	Errors in System Mode	110

Chapter 4

Error Messages

4.1 System Errors

If some error occurs when the power is turned on or during program execution, one of the following error messages will appear on the LCD.

```
*****  
** No System! **  
*****
```

```
Battery voltage  
has lowered.
```

System Program error

■ Problem

A System Program error has occurred.

NOTE If this error occurs, the BHT-7000 beeps five times (for 0.1 second per beep) and then turns itself off.

■ Solution

Contact your nearest dealer.

Low battery indication—Level 1

■ Problem

When the power is turned on or off or during execution of program (System Mode or application), the battery output level has dropped below a specified lower level limit.

NOTE If low battery is detected, the BHT-7000 displays this message for approx. 2 seconds and beeps three times (for 0.1 second per beep). After that, it will resume previous regular operation.

■ Solution

The service life of the battery cartridge will expire soon, requiring replacement or recharge.

If the BHT-7000 is loaded with the rechargeable battery cartridge, replace or charge it. (For the charging procedure, refer to Chapter 5, Section 5.5.)

If the BHT-7000 is loaded with the dry battery cartridge, replace the dry cells.

(When the rechargeable battery cartridge is loaded)

```
Charge the
battery!
```

(When the dry battery cartridge is loaded)

```
Replace the
batteries!
```

Low battery indication—Level 2

■ Problem

When the power is turned on or during execution of program (System Mode or application), the battery output level has lowered.

NOTE

If lower battery is detected, the BHT-7000 beeps five times (for 0.1 second per beep) and then turns itself off. Depending upon the battery level, the beeper may not sound five times.

■ Solution

If the BHT-7000 is loaded with the rechargeable battery cartridge, replace or charge it. (For the charging procedure, refer to Chapter 5, Section 5.5.)

If the BHT-7000 is loaded with the dry battery cartridge, replace the dry cells.

```
Set the current
date and time.

00/01/01 00:00
_ / / :
```

Calendar clock stopped

■ Problem

The calendar clock integrated in the BHT-7000 has stopped because:

- The battery cartridge had been removed for a long time,
- The rechargeable battery cartridge had not been recharged for a long time, or
- The dry batteries in the dry battery cartridge had not been replaced.

NOTE The indication of 00/01/01 00:00 will change depending upon the calendar clock state.

■ Solution

Set the calendar clock (refer to Chapter 2, Subsection 2.4.2).

```
Reload the battery
to restart!

XXXXXXXXX 01
```

System Program malfunction

■ Problem

During execution of System Program, the System Program has attempted to write onto the write-protected area of the memory.

(XXXXXXXX: Error address)

NOTE If this error occurs, the BHT-7000 beeps five times (for 0.1 second per beep).

■ Solution

Unload and reload the battery cartridge, then turn on the power.

```
Reload the battery
to restart!

tskid:XXXXXXXX
ercd :XXXXXXXX
addr :XXXXXXXX 02
```

■ Problem

During execution of System Program, the System Program has received an invalid command code.

(XXXXXXXX: Error address)

NOTE If this error occurs, the BHT-7000 beeps five times (for 0.1 second per beep).

■ Solution

Unload and reload the battery cartridge, then turn on the power.

No execution
program selected.
Contact your
administrator.

Execution program not selected

■ Problem

No user program has been selected as an execution program to be run when the power is turned on.

NOTE If this error occurs, the BHT-7000 beeps five times (for 0.1 second per beep) and then turns itself off.

■ Solution

Run System Mode and select an execution program in the SET SYSTEM menu. (For the selecting procedure, refer to Chapter 2, Subsection 2.6.3, [4.1].)

Resume data saving error

■ Problem

When the power was turned off, the system failed to save resume data although the resume function had been set to ON.

NOTE The BHT-7000 displays this error message for three seconds and automatically runs the execution program from the point of start-up.

Resume failure!
Program restarts
automatically.

Your settings in
System Mode
have been lost.

Will reset
to defaults.

Error in System Mode settings

■ Problem

Your settings made in System Mode contain an error.

NOTE If this error occurs, the System Mode settings revert to the factory defaults.

NOTE The BHT-7000 displays this error for three seconds and then displays the "No execution program selected..." message.

■ Solution

Make your settings in System Mode again.

System down error

■ Problem

An error has occurred during execution of System Program.

NOTE If this error occurs, the BHT-7000 beeps five times (for 0.1 second per beep).

■ Solution

Unload and reload the battery cartridge, then turn on the power.

If this error occurs frequently, make a note of the message and codes on the LCD and contact your nearest dealer.

Reload the battery
to restart!

E:xxxxxxxx-F:xxxxxxxx
1:xxxxxxxx-2:xxxxxxxx
P:xxxxxxxx-R:xxxxxxxx

Contact your
administrator.
Note the error
number.
(XXXX)

System administrator to be called

■ Problem

Any of the following errors has occurred:

- (1) Hardware error or calendar clock error: (1010)
Flash memory error: (1020)
- (2) Memory storage error (20XX)
- (3) Execution program error (3010)
(XXXX: Error code)

TIP

If any of the above errors occurs, the BHT-7000 beeps five times (for 0.1 second per beep) and then turns itself off.

■ Solution

Turn on the power again.

If error (1) above occurs frequently, contact your nearest dealer.

If error (2) occurs frequently, initialize the BHT-7000 System (the whole user area including the font file area).

If error (3) occurs frequently, delete the execution program file that causes this error or download the original execution program file to overwrite the current one.

4.2 Errors in System Mode

If some error occurs during operation in System Mode, one of the following error messages will appear on the LCD.

```
EXECUTE PROGRAM

*****
* NO FILE EXISTS *
*****
```

```
SET EXECUTE PROGRAM

*****
* NO FILE EXISTS *
*****
```

```
UPLOAD FILE

*****
* NO FILE EXISTS *
*****
```

When selecting a program file or data file

■ Problem

You attempted to execute a user program in the EXECUTE PROGRAM menu, even though no user program files had been stored in the memories.

■ Solution

Press the key to return to the SYSTEM MENU screen, then download user programs. (Refer to Chapter 2, Subsection 2.6.3, [2].)

■ Problem

In the SET SYSTEM menu, you attempted to select a user program file as an execution program to be run when the power is applied, even though no user program files had been stored in the memories.

■ Solution

Press the key to return to the SYSTEM MENU screen, then download user programs. (Refer to Chapter 2, Subsection 2.6.3, [2].)

■ Problem

You attempted to select "ONE FILE" or "ALL FILES" for uploading in the UPLOAD menu, even though no data files had been stored in the memory.

■ Solution

Press the key to return to the SYSTEM MENU screen.

```

DELETE FILE

*****
* NO FILE EXISTS *
*****

```

■ Problem

You have deleted all of the files stored in the memory in the DELETE FILE menu.

■ Solution

Press the **C** key to return to the SYSTEM MENU screen.

During downloading of a program file, data file, BHT-7000 system parameter file, or system message file

```

DOWNLOAD FILE

XXXXXXXXX.XXX
Out of memory!!

Retry?
1:Yes 2:No

```

■ Problem

The memory is insufficient for storing files to be downloaded.

■ Solution

Press the **2** key to return to the SYSTEM MENU, then delete unnecessary files in the memory or decrease the size of the file to be downloaded. (Refer to Chapter 2, Subsection 2.6.3, [7], [2], [8], and [10].)

```

DOWNLOAD

File mismatch!!

Retry?
1:Yes 2:No

```

■ Problem

In the SYSTEM PARAMETER transfer menu, you attempted to download a file other than the BHT-7000 system parameter file. Or in the SYSTEM MESSAGE transfer menu, you attempted to download a file other than the system message file.

■ Solution

Check the file you attempted to download and then download the file in the appropriate menu (DOWNLOAD menu, SYSTEM PARAMETER transfer menu, or SYSTEM MESSAGE transfer menu).

```
DOWNLOAD FILE
XXXXXXXXX.XXX
Too many files!!
Retry?
  1:Yes 2:No
```

■ Problem

The current download will exceed the maximum of 80 files in the memory.

■ Solution

Press the **2** key to return to the SYSTEM MENU, then delete unnecessary files in the memory (or decrease the number of files to be downloaded if you attempted to download more than one file in the DOWNLOAD menu.)

(Refer to Chapter 2, Subsection 2.6.3, [7], [2], [8], and [10].)

```
DOWNLOAD FILE
XXXXXXXXX.XXX
Communication error!!
Retry?
  1:Yes 2:No
```

■ Problem

Downloading has failed.

■ Solution

To retry downloading, press the **1** key.

To return to the SYSTEM MENU, press the **2** key. Check the interface port and communications parameters in the SET SYSTEM menu or perform the communications test in the TEST menu. (Refer to Chapter 2, Subsection 2.6.3, [4.5] and [5.7].)

It is also necessary to check the communications parameters setup of the host computer.

```
DOWNLOAD FILE
XXXXXXXXX.XXX
Program file error!!
Retry?
  1:Yes 2:No
```

■ Problem

You attempted to download an invalid program file.

■ Solution

Check whether the program file you attempted to download is available to your BHT model. If it is not available, download the appropriate program.

During uploading of a program file, data file, BHT system parameter file, or system message file

```

UPLOAD FILE

File error!!

Upload?
  1:Yes 2:No

```

■ Problem

The file you attempted to upload is damaged.

■ Solution

To upload the damaged file as is, press the **[1]** key.

```

UPLOAD

Out of memory!!

```

■ Problem

The memory is insufficient for setting up the BHT system parameter file or system message file to be uploaded.

■ Solution

Press the **[C]** key to return to the SYSTEM MENU and delete unnecessary files. (Refer to Chapter 2, Subsection 2.6.3, [7].)

```

UPLOAD

Too many files!!

```

■ Problem

The memory has already contained 80 files, so the BHT system parameter file or system message file cannot be set up.

■ Solution

Press the **[C]** key to return to the SYSTEM MENU and delete unnecessary files. (Refer to Chapter 2, Subsection 2.6.3, [7].)

```

UPLOAD FILE

XXXXXXXXX.XXX
Communication error!!

Retry?
  1:Yes 2:No

```

■ Problem

Uploading has failed.

■ Solution

To retry uploading, press the **[1]** key.

To return to the SYSTEM MENU, press the **[2]** key. Check the interface port and communications parameters in the SET SYSTEM menu or perform the communications test in the TEST menu. (Refer to Chapter 2, Subsection 2.6.3, [4.5] and [5.7].)

It is also necessary to check the communications parameters setup of the host computer.

This chapter describes the handling procedure of the CU-7000, the interfacing with the host computer, and the charging of the lithium-ion battery cartridge.

5.1	Functions of the CU-7000	117
5.2	Components and Functions	117
5.3	Applying Power to the CU-7000	117
5.4	Communicating with the Host Computer	119
5.4.1	Setting the Transmission Speed of the CU-7000	119
5.4.2	Interface Cable Connection	119
5.4.3	Interfacing with the Host Computer	119
5.5	Charging the Lithium-ion Battery Cartridge (using the CU-7001) ..	121
5.6	RS-232C Interface Specifications	123
	[1] Interface Connector and Pin Assignment	122
	[2] Interface Cable Connection	123

Chapter 5

Handling the CU-7000 (Option)

5.1 Functions of the CU-7000

The optical communications unit CU-7000 is available in two models: CU-7001 and CU-7002. The CU-7001 has both of functions (1) and (2) given below; the CU-7002 has only function (1).

(1) Data exchange function

The CU-7001/CU-7002 exchanges data and programs between the BHT-7000 and the host computer. It interfaces with the BHT-7000 via the optical interface and with the host computer via the RS-232C interface.

(2) Battery cartridge charging function

The CU-7001 charges the lithium-ion battery cartridge.

5.2 Components and Functions

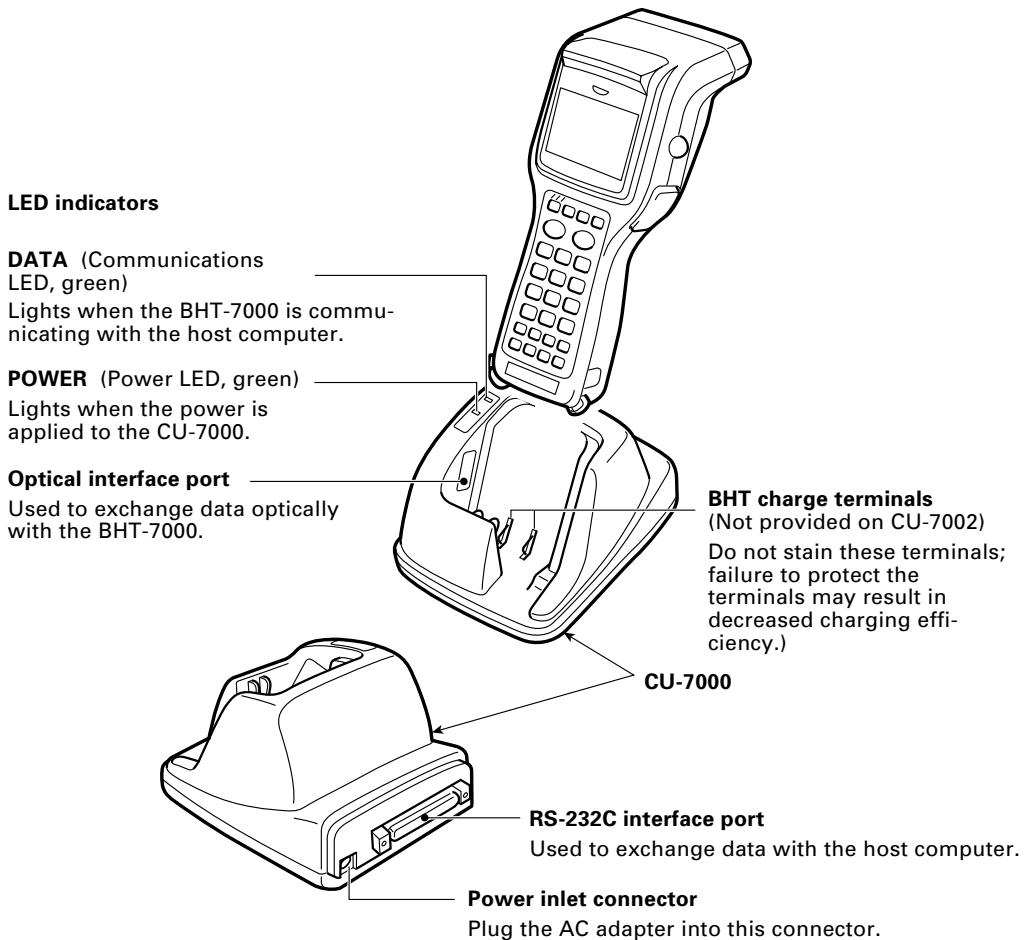

5.3 Applying Power to the CU-7000

Apply power to the CU-7000 by connecting it to the wall socket via the dedicated AC adapter according to the steps given below.

Connect the outlet plug of the AC adapter to the power inlet connector of the CU-7000, then plug the other end of the AC adapter into the wall socket.

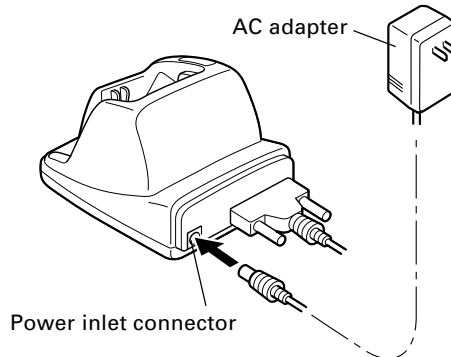

WARNING

- If smoke, abnormal odors or noises come from the CU, immediately unplug the AC adapter from the wall socket and contact your nearest dealer. Failure to do so could cause fire or electrical shock.
- If foreign material or water gets into the CU, immediately unplug the AC adapter from the wall socket and contact your nearest dealer. Failure to do so could cause fire or electrical shock.
- If you drop the CU so as to damage its housing, immediately unplug the AC adapter from the wall socket and contact your nearest dealer. Failure to do so could cause fire or electrical shock.
- Use the dedicated AC adapter only. Failure to do so could result in a fire.
- Never use the CU on the line voltage other than the specified level. Doing so could cause the CU to break or burn.
- If the power cord of the AC adapter is damaged (e.g., exposed or broken lead wires), stop using it and contact your nearest dealer. Failure to do so could result in a fire or electrical shock.



CAUTION

- If you are not using the CU for a long time, be sure to unplug the AC adapter from the wall socket for safety. Failure to do so could result in a fire.
- When caring for the CU, unplug the AC adapter from the wall socket for safety. Failure to do so could result in an electrical shock.
- Never cover or wrap up the CU or AC adapter in a cloth or blanket. Doing so could cause the unit to heat up inside, deforming its housing, resulting in a fire. Always use the CU and AC adapter in a well-ventilated area.
- Keep the power cord away from any heating equipment. Failure to do so could melt the sheathing, resulting in a fire or electrical shock.



5.4 Communicating with the Host Computer

5.4.1 Setting the Transmission Speed of the CU-7000

Set the transmission speed of the CU-7000 to the same value as that of the BHT-7000 and the host computer, by using the DIP switch provided on the bottom of the CU-7000.

- (1) Turn the CU-7000 upside down.
- (2) Remove the protection sheet of the DIP switch from the CU-7000.
- (3) Set the selectors of the DIP switch as shown below.

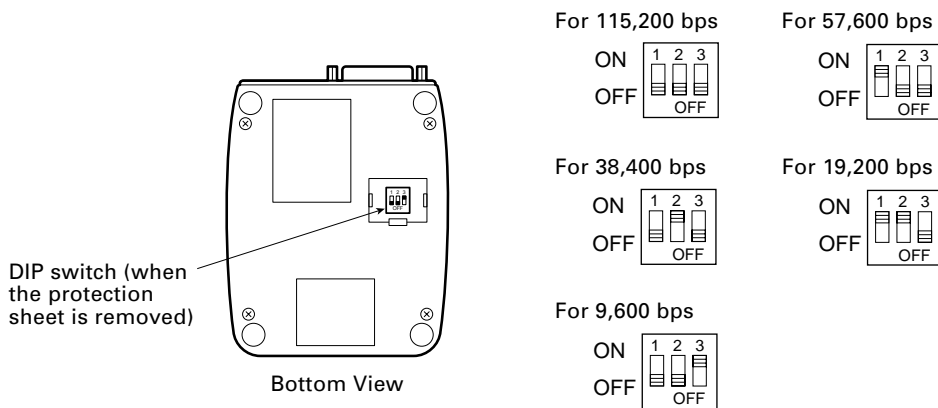

- (4) Reinstall the protection sheet.

NOTE

Do not set the DIP switch to any configurations other than one of the five shown above.

5.4.2 Interface Cable Connection

- (1) Unplug the AC adapter of the CU-7000 from the wall socket.
- (2) Make sure that the host computer is turned off.
- (3) Connect the 25-pin plug (Dsub-25P) of the interface cable to the RS-232C interface port of the CU-7000.

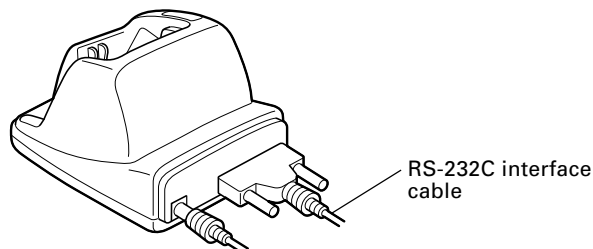

- (4) Connect the other end of the interface cable to the RS-232C port of the host computer.

5.4.3 Interfacing with the Host Computer

This section describes how to start communication with the host computer in System Mode. The same may apply when you use a user program.

- (1) Power on the host computer.
- (2) Plug the AC adapter of the CU-7000 into the wall socket.
- (3) Make sure that the BHT-7000 is powered off, then set it on the CU-7000.

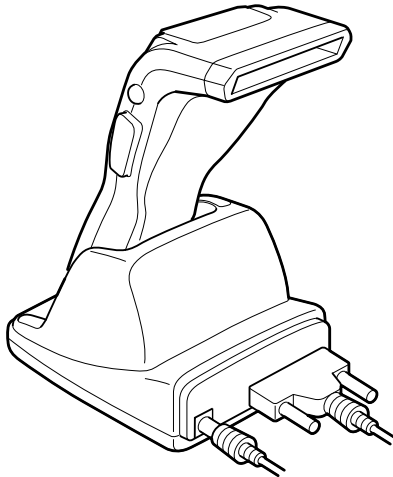

- (4) Power on the BHT-7000 and run System Mode. Set the communications environments (communications protocol, interface port, communications parameters, and protocol options).

Regarding the communications protocol: When using Ir-Transfer Utility C/Ir-Transfer Utility E on the host computer, select the BHT-Ir protocol; when using Transfer Utility, select the BHT-protocol.

Regarding the interface port: Select the optical interface port.

- (5) On the host computer, initiate a communications program (e.g., Ir-Transfer Utility C/Ir-Transfer Utility E/Transfer Utility, or equivalent).
- (6) To transfer data stored in the BHT-7000 to the host computer, select "3: UPLOAD" on the SYSTEM MENU in System Mode. To transfer data from the host computer to the BHT-7000, select "2: DOWNLOAD." (For details, refer to Chapter 2, Section 2.5.)

The BHT-7000 and the host computer will start communications with each other via the CU-7000. The DATA LED will come on upon start of communications. After completion of communications, the LED will go off.

- (7) Unplug the AC adapter of the CU-7000 from the wall socket.

5.5 Charging the Lithium-ion Battery Cartridge (using the CU-7001)

You may charge lithium-ion battery cartridges loaded in the BHT-7000.

NOTE

Service Life of Lithium-ion Battery Cartridge:

Lithium-ion batteries used in the battery cartridge will gradually deteriorate during the repeated cycles of charging and discharging due to its properties, even under normal use. When the battery service period becomes shortened due to its deterioration even if it has been charged for the specified hours, replace the battery cartridge with a new one. Generally, it is necessary to replace the battery cartridge after it has undergone approx. 300 cycles of charging and discharging operation.

- (1) Plug the AC adapter of the CU-7001 into the wall socket.

The POWER LED on the CU-7001 comes on.

- (2) Place the BHT-7000 loaded with a battery cartridge onto the CU-7001.

The BHT-7000 turns on the indicator LED in red and starts charging. The charging time is approx. 4 hours.

Upon completion of charging, the indicator LED turns green.

- (3) Take the BHT-7000 off the CU-7001.

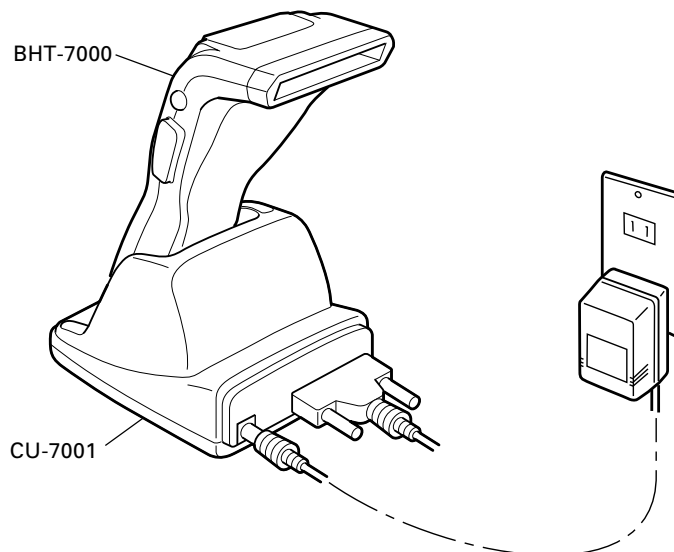

TIP

The charging time is approx. 4 hours if the "Charge the battery!" message is displayed on the BHT-7000. The battery cartridge not discharged so much will be fully recharged in shorter time.

■ Charging Operation and LED Indication

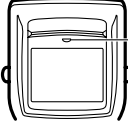
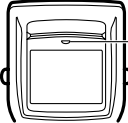
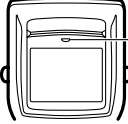
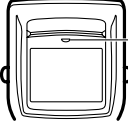
Operator's Action	CU-7001 Status	Indicator LED on the BHT-7000
	On standby ↓	 OFF
Place the BHT-7000 on the CU-7001. ↓	Normal charging ↓	 ON (in red)
After approx. 4 hours ↓	Charging completed ↓	 ON (in green)
Remove the BHT-7000.	On standby	 OFF

5.6 RS-232C Interface Specifications

[1] Interface Connector and Pin Assignment

The CU-7000 has an RS-232C interface port (Dsub-25S).

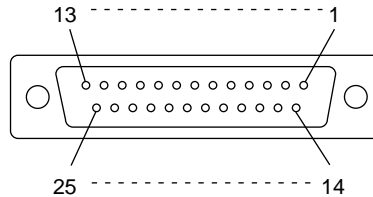

RS-232C interface port (Dsub-25S) on the CU-7000

Pin No.	Signal	Functions	Signal Input/Output	
			CU-7000	External device
1	FG	Frame ground	—	—
2	SD	Send data	→	→
3	RD	Receive data	←	←
4	RS	Request to send	—	—
5	CS	Ready to send	—	—
6	DR	Data set ready	—	—
7	SG	Signal ground	—	—
8	CD	Carrier detect	—	—
20	ER	Data terminal equipment ready	—	—

The input/output voltage threshold for the logical valued signal is listed below.

Logical Value	Input Voltage Threshold	Output Voltage Threshold
0	3V min.	5V min.
1	-3V max.	-5V max.

[2] Interface Cable Connection

As illustrated below, connect the CU-7000 (on which the BHT-7000 is put) to a host computer with a cross-mode cable. To connect it to a modem, use a straight-mode cable.

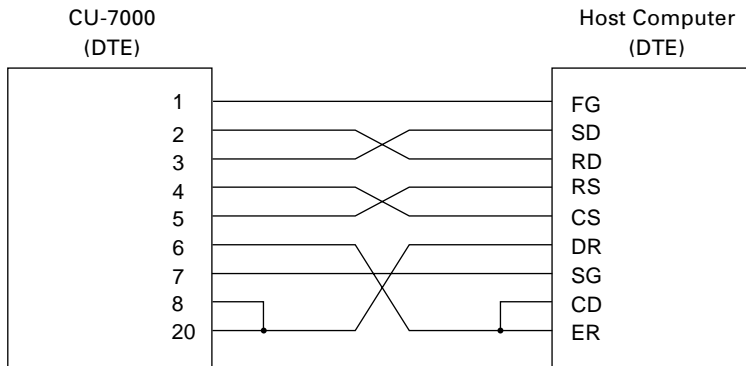

Cable Connection between CU-7000 and Host Computer

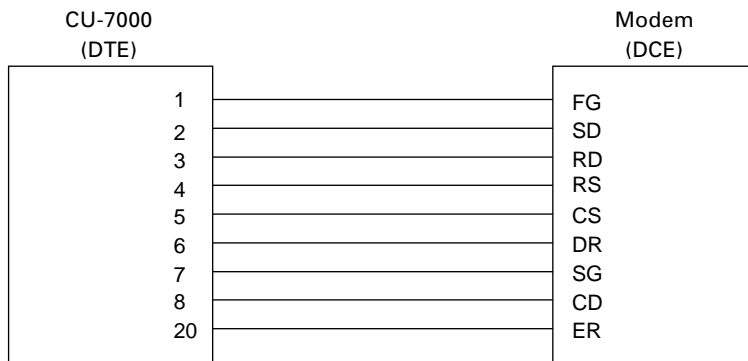

Cable Connection between CU-7000 and Modem

DTE and DCE

In the RS-232C interface specifications, the DTEs (Data Terminal Equipment) shall be generally connected with each other by a cross-mode cable; the DTE and DCE (Data Circuit-terminating Equipment) shall be connected with each other by a straight-mode cable.

The DTE is one piece of equipment connected at both ends of a communications line as a sender or receiver of data (such as CU-7000 on which the BHT-7000 is put and a host computer).

The DCE is one piece of equipment connected to the intermediate point between the DTE and the communications line. It terminates communications lines and exchanges information between those lines without any change in contents (such as modem).

Appendix A. Specifications	126
A.1 BHT-7000	126
[1] Product Specifications	126
[2] Bar Code Specifications	128
[3] Interface Specifications	130
A.2 CU-7000	131
[1] Product Specifications	131
[2] Charging Requirements (CU-7001)	131
[3] Interface Specifications	132
Appendix B. Communications Protocol Details	133
B.1 BHT-protocol	133
[1] Transmission Control Sequences	133
[2] Aborting Data Transmission	141
[3] BCC for Horizontal Parity Checking	142
B.2 BHT-Ir protocol	143
[1] Transmission Control Sequences	143
[2] Aborting Data Transmission	152
[3] CRC	153
[4] ID	153
Appendix C. A Typical Basic Operation	154

Appendices

Appendix A. Specifications

A.1 BHT-7000

[1] Product Specifications

Power Source	Main power	<ul style="list-style-type: none"> • Rechargeable lithium-ion battery cartridge (3.6 VDC) or • Dry battery cartridge (two alkaline manganese batteries LR6s) 												
Dimensions (W) x (L) x (H)		70 x 195 x 51 mm (2.8 x 7.7 x 2.0 inches)												
Weight		Approx. 210 g (Approx. 7.4 oz.) including battery cartridge												
Operating Ambient Temperature		-5°C to 50°C (23°F to 122°F)												
Operating Humidity		20% to 80% (with no dew condensation)												
Ambient Illuminance		500 to 3000 lx. (Depth of field: 80 mm, PCS value: 0.9 min., Reflection intensity: 85% min. for white and 5% max. for black, Narrow bar width: 0.127 mm min.) 20 to 10000 lx. (Depth of field: 430 mm, ITF: 1.0 magnification, PCS value: 0.9 min., Reflection intensity: 85% min. for white and 5% max. for black)												
Controller		CPU: 32-bit RISC RAM: 512KB Flash memory: 4MB												
Keypad		<table border="1" style="width: 100%; border-collapse: collapse;"> <thead> <tr> <th style="width: 50%;"></th> <th style="width: 25%;">26-key pad</th> <th style="width: 25%;">32-key pad</th> </tr> </thead> <tbody> <tr> <td>Magic keys</td> <td style="text-align: center;">4</td> <td style="text-align: center;">4</td> </tr> <tr> <td>Function keys</td> <td style="text-align: center;">8</td> <td style="text-align: center;">10</td> </tr> <tr> <td>Numerical keys and others</td> <td style="text-align: center;">16</td> <td style="text-align: center;">20</td> </tr> </tbody> </table>		26-key pad	32-key pad	Magic keys	4	4	Function keys	8	10	Numerical keys and others	16	20
	26-key pad	32-key pad												
Magic keys	4	4												
Function keys	8	10												
Numerical keys and others	16	20												

Display

Type: Dot-matrix, FSTN liquid crystal display (LCD) with backlight

Formation: Character display
 128 dots wide by 64 dots high

Status display
 128 dots wide by 1 dot high

Screen mode	Font size		Chars x Lines	Dots (W x H)
Single-byte ANK* mode	Standard-size		21 x 8	6 x 8
	Small-size		21 x 10	6 x 6
Two-byte Kanji mode	16-dot font	Full-width	8 x 4	16 x 16
		Half-width	16 x 4	8 x 16
	16-dot font (Double-width)	Full-width	4 x 4	32 x 16
		Half-width	8 x 4	16 x 16
	12-dot font	Full-width	10 x 5	12 x 12
		Half-width	20 x 5	6 x 12
12-dot font (Double-width)	Full-width	5 x 5	24 x 12	
	Half-width	10 x 5	12 x 12	

*ANK: Alphanumerics and Katakana

Calendar Clock

Year, month, day, hour, minute, and second

- Year Two digits (with auto-correction on February 29 for year 1901 to 2099)

Indicator LED

Colors: Red and green

[2] Bar Code Specifications

(1) Available Bar Code Types

Bar code type	Bar dimensions	Readable magnification
Universal product codes		
EAN-13	0.26 mm (10.24 mils)	0.8 magnification min.
EAN-8		
UPC-A		
UPC-E		
EAN-13 with supplemental codes		
EAN-8 with supplemental codes		
UPC-A with supplemental codes		
UPC-E with supplemental codes		
2-digit add-on		
5-digit add-on		
Interleaved 2 of 5 (ITF)	0.125 mm min. (4.9 mils min.)	PCS value ≥ 0.75 Reflection intensity difference between white and black bars ≥ 0.4
Standard 2 of 5 (STF)		
CODABAR		
CODE39		
CODE93	0.15 mm min. (5.91 mils min.)	(PCS value ≥ 0.45)
CODE128		

(2) Optical Properties Required for Bar Code Labels

White bars:	Reflection intensity	45% min.
Black bars:	Reflection intensity	25% max.
	PCS value	0.45 min.

(3) Bar Code Label Size

Recommended width: 10 mm min. (0.39 inch min.)

Length:	Depth of field (Distance from bar codes to the bar-code reading window)	Length of labels (including margins)
	400 mm (15.75 inches)	460 mm max. (18.11 inches max.) (Minimum narrow bar width: 1.0 mm min.)*4

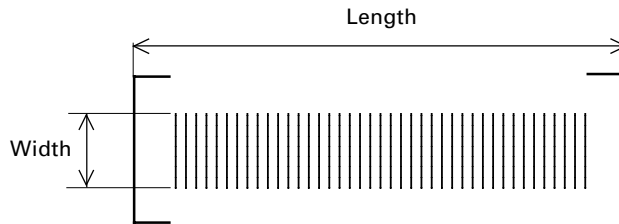

(4) Thickness of Bars and Depth of Field

Minimum narrow bar width	Depth of field
0.125 mm (4.92 mils)	0 to 45 mm (0 to 1.77 inches)*1
0.15 mm (5.91 mils)	0 to 85 mm (0 to 3.35 inches)*2
0.33 mm (12.99 mils)	0 to 200 mm (0 to 7.87 inches)*3
1.0 mm (39.37 mils)	100 to 400 mm (3.94 to 15.75 inches)*4
1.2 mm (47.24 mils)	120 to 450 mm (4.72 to 17.72 inches)*5

*1 Under the following conditions:

- Ambient illuminance: 500 lx. (Fluorescent lamp)
- CODE39, 19-digit
Narrow bar : Wide bar = 1 : 2.2
- Reflection intensity of white bars: 85% min.
Reflection intensity of black bars: 5% max.

*2 Under the following conditions:

- Ambient illuminance: 500 lx. (Fluorescent lamp)
- CODE39, 6-digit
Narrow bar : Wide bar = 1 : 2.2
- Reflection intensity of white bars: 85% min.
Reflection intensity of black bars: 5% max.

*3 Under the following conditions:

- Ambient illuminance: 500 lx. (Fluorescent lamp)
- EAN13, 1.0 magnification
- Reflection intensity of white bars: 85% min.
Reflection intensity of black bars: 5% max.

*4 Under the following conditions:

- Ambient illuminance: 500 lx. (Fluorescent lamp)
- ITF conforming to the UPC Shipping Container Code
- Reflection intensity of white bars: 85% min.
Reflection intensity of black bars: 5% max.
- 1.0 magnification

*5 Under the following conditions:

- Ambient illuminance: 500 lx. (Fluorescent lamp)
- ITF conforming to the UPC Shipping Container Code
Narrow bar : Wide bar = 1 : 2.2
- Reflection intensity of white bars: 85% min.
Reflection intensity of black bars: 5% max.
- 1.2 magnifications

[3] Interface Specifications

Optical Interface

Synchronization: Start-stop
 Input signals: RD
 Output signals: SD
 Transmission speed: 115,200 bps max.

Direct-connect Interface

Synchronization: Start-stop
 Transmission speed: 115,200 bps max.
 Signal level: Conforms to the RS-232C interface
 Pin assignment: As shown below.

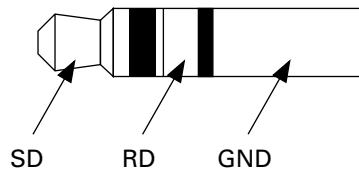

Pin No.	Signal	Functions	Signal Input/Output	
			BHT-7000	External device
1	SG (GND)	Ground for signals	—	
2	SD	Send data	→	
3	RD	Receive data	←	

A.2 CU-7000

[1] Product Specifications

Power Source

- Europe	230 VAC, 16 VA
- U.S.	120 VAC, 13 VA
- Australia	10 to 18 VDC, 450 mA (on 12 VDC)

Power Consumption

8 VA

Dimensions

(W) x (L) x (H)

112 x 148 x 84 mm
(4.41 x 5.83 x 3.31 inches)

Weight

CU-7001: Approx. 230 g (Approx. 8.11 oz.)
CU-7002: Approx. 200 g (Approx. 7.06 oz.)

Operating Ambient Temperature

0°C to 40°C (32°F to 104°F)

Operating Humidity

20% to 80% (with no dew condensation)

[2] Charging Requirements (CU-7001)

Charge current:

600 mA

Charge time:

Approx. 4 hours

[3] Interface Specifications

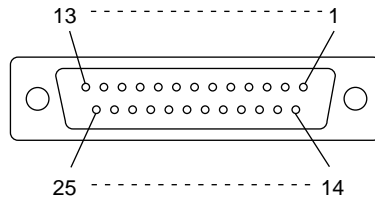

RS-232C Interface Port (Dsub-25S) on the CU-7000

Pin No.	Signal	Functions	Signal Input/Output	
			CU-7000	External device
1	FG	Frame ground	—	—
2	SD	Send data	→	—
3	RD	Receive data	←	—
4	RS	Request to send	—	—
5	CS	Ready to send	—	—
6	DR	Data set ready	—	—
7	SG	Signal ground	—	—
8	CD	Carrier detect	—	—
20	ER	Data terminal equipment ready	—	—

NOTE Shown below is a diagram of the internal connection in the CU-7000.

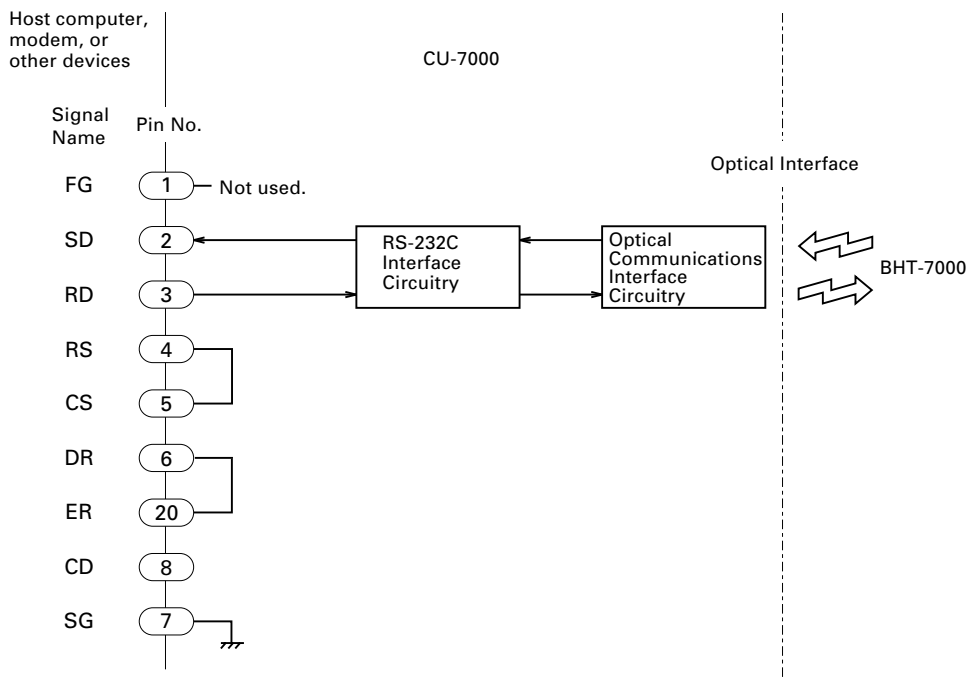

Appendix B. Communications Protocol Details

B.1 BHT-protocol

[1] Transmission Control Sequences

Shown below is a typical message transmission sequence supported by the BHT-protocol. This sequence example does not include transmission errors or negative responses.

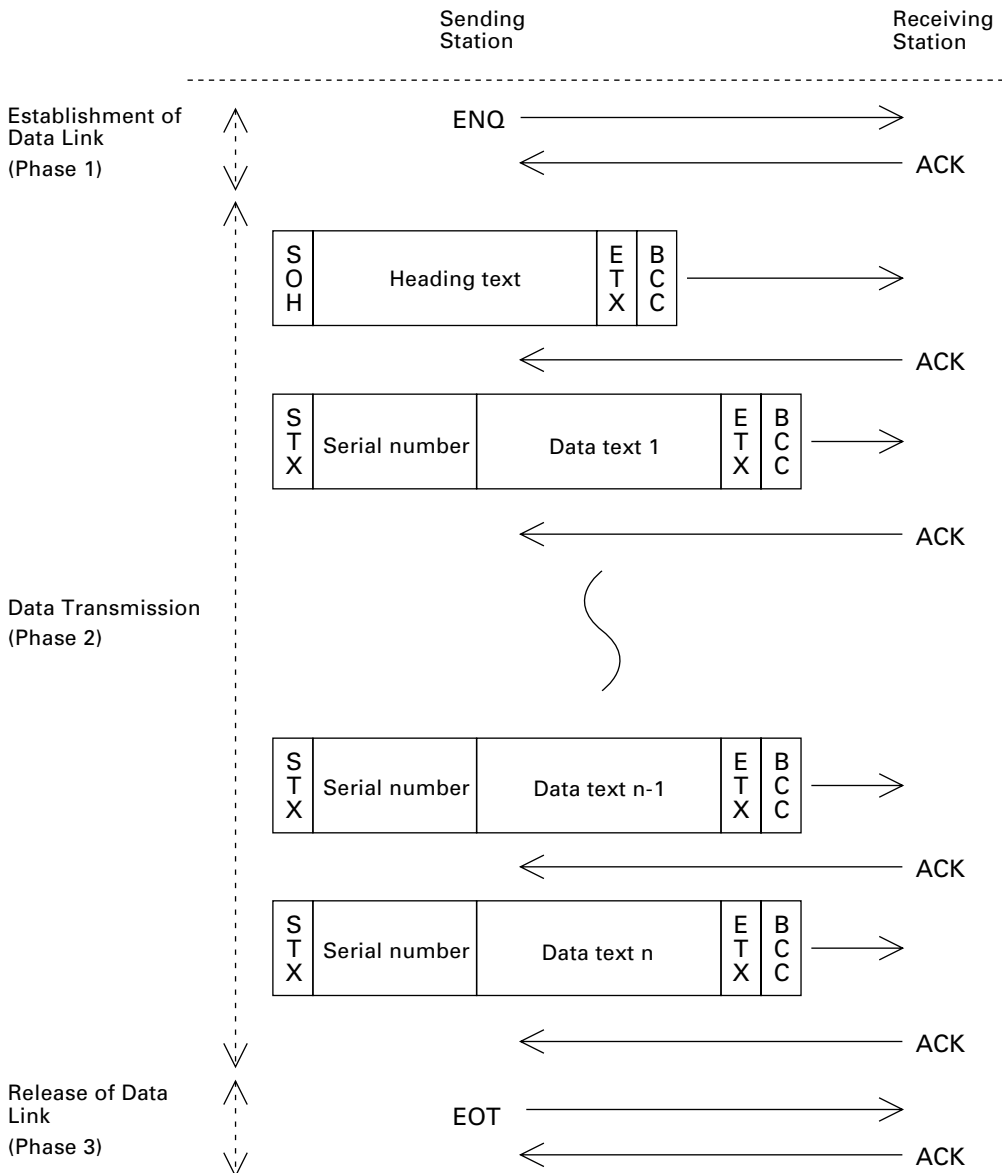

Data transmission may accidentally involve various types of errors. The BHT-protocol is designed to recover from those errors as frequently as possible. What follows is the BHT-protocol for phases 1 through 3.

Phase 1: Establishment of Data Link

■ Normal phase 1

The sending station transmits an ENQ to the receiving station. Upon receipt of an ACK from the receiving station, the sending station shifts to phase 2.

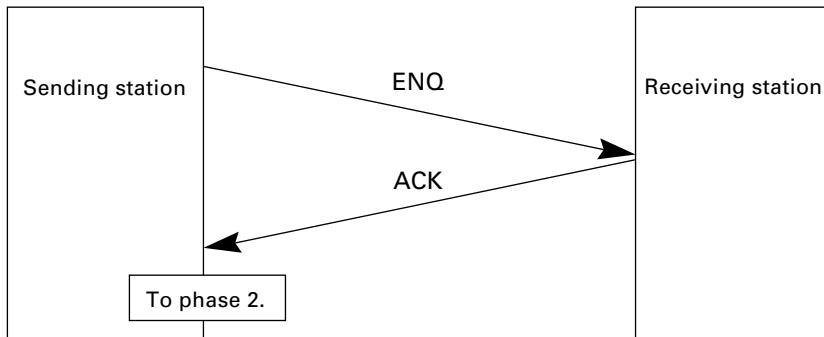

■ Phase 1 with iterated ENQ transmission due to no response or invalid response

If the sending station receives no response or any invalid response from the receiving station in response to an ENQ sent, it iterates sending of an ENQ at three-second intervals up to 10 times.

If the sending station receives an ACK before sending an ENQ ten times, it shifts to phase 2.

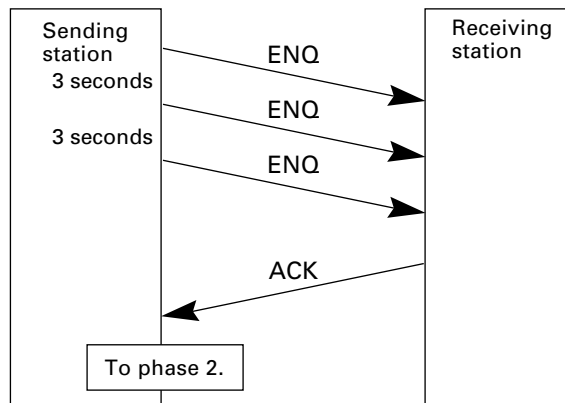

TIP

You may modify the number of ENQ iterations for the sending station. The default is 10 times at three-second intervals. For details, refer to the SET PROTOCOL screen in System Mode (pp. 54 and 56) and the XFILE statement given in "BHT-BASIC Programmer's Manual."

■ Abnormal termination of phase 1 (Abort of phase 1)

If the sending station receives no ACK from the receiving station after sending an ENQ 10 times in succession, it sends an EOT to the receiving station after three seconds from the 10th ENQ to terminate the message transmission abnormally.

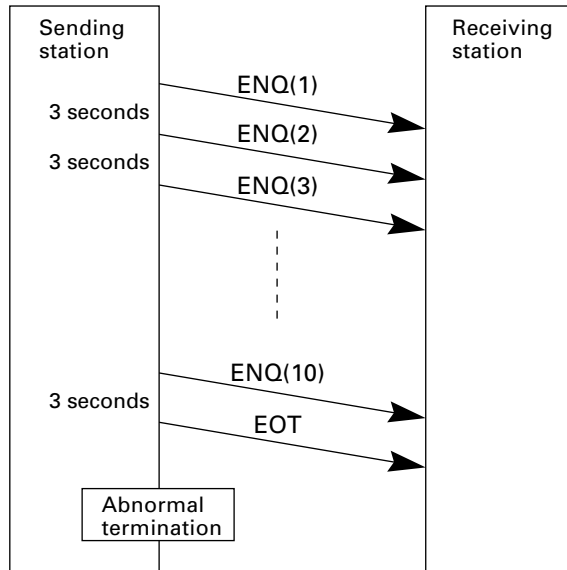

TIP

The receiving station's default timeout is 30 seconds. You may modify the timeout length on the SET PROTOCOL screen in System Mode (pp. 54 and 56) or by using the XFILE statement (refer to the "BHT-BASIC Programmer's Manual").

Phase 2: Data Transmission

■ Normal phase 2

The sending station first sends a transmission block containing the heading text. Each time the sending station receives an ACK from the receiving station, it sends a transmission block containing the data texts as shown below. Upon receipt of an ACK in response to the last transmission block (data text n), the sending station shifts to phase 3.

If a transmission message contains no data text, the sending station transmits the heading text only.

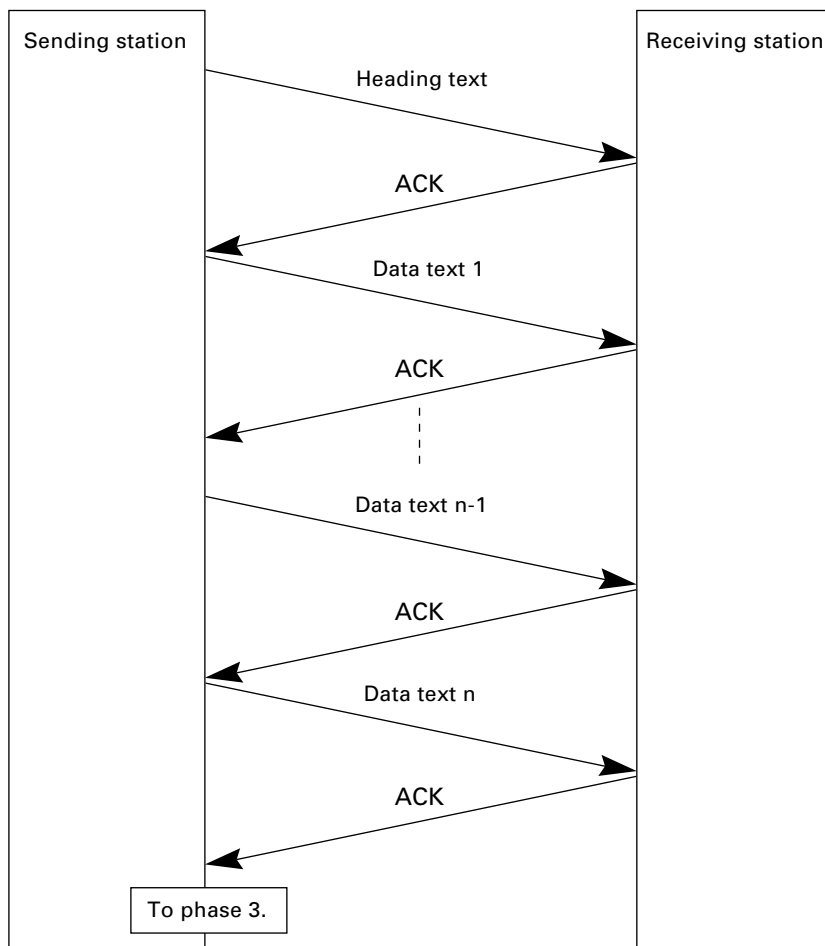

■ **Phase 2 with NAK**

If the sending station receives a NAK from the receiving station in response to a transmission block containing text data m , it sends that transmission block again immediately as shown below.

If the sending station receives an ACK before receiving a NAK 10 times in succession, it continues the subsequent message transmission.

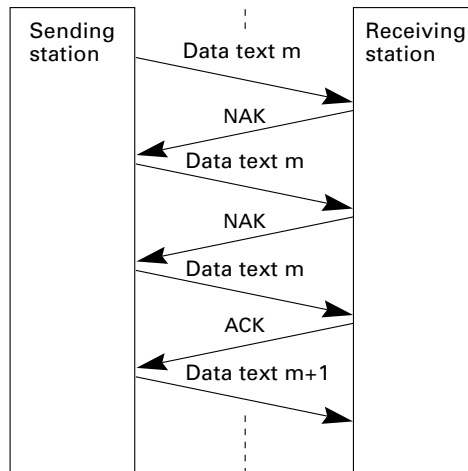

If the sending station receives a NAK 10 times in succession or it fails to send a same transmission block, it shifts to phase 3 to terminate the message transmission abnormally. Even if the phase 3 terminates normally, the transmission results in an abnormal end.

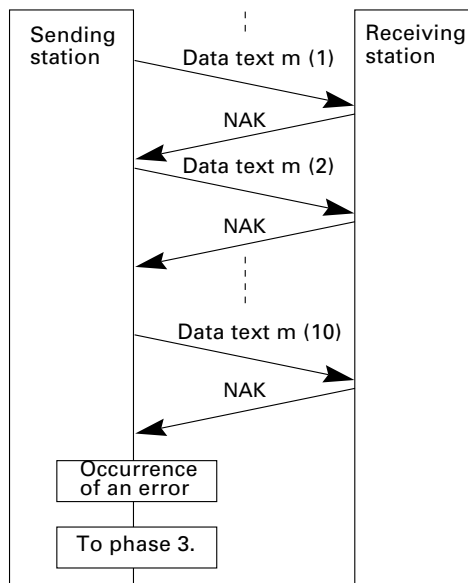

■ Phase 2 with EOT

If the sending station receives an EOT anytime during phase 2, it shifts to phase 3 to terminate the message transmission abnormally. Even if the phase 3 terminates normally, the transmission results in an abnormal end.

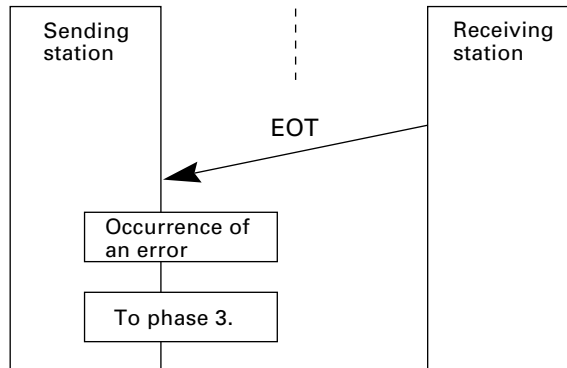

■ Phase 2 with iterated ENQ transmission due to no response or invalid response

If the sending station receives no response or any invalid response from the receiving station in response to a transmission block sent, it iterates sending of an ENQ at three-second intervals up to nine times.

If the sending station receives an ACK before sending an ENQ nine times, it continues the subsequent message transmission.

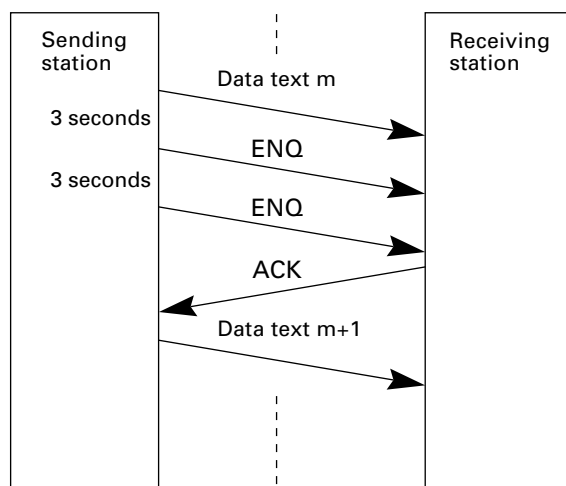

■ **Abnormal termination of phase 2 (Abort of phase 2)**

If the sending station receives no ACK from the receiving station after sending an ENQ nine times in succession, it sends an EOT to the receiving station after 3 seconds from the 9th ENQ to terminate this transmission sequence abnormally.

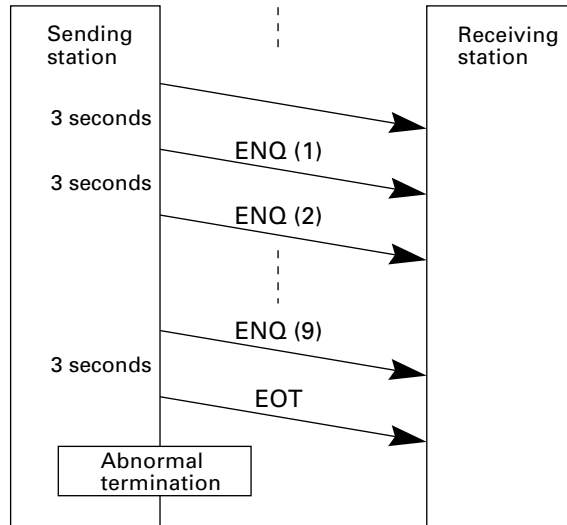

Phase 3: Release of Data Link

■ **Normal phase 3**

The sending station transmits an EOT to the receiving station. Upon receipt of an ACK from the receiving station, the sending station terminates the message transmission normally and releases the data link.

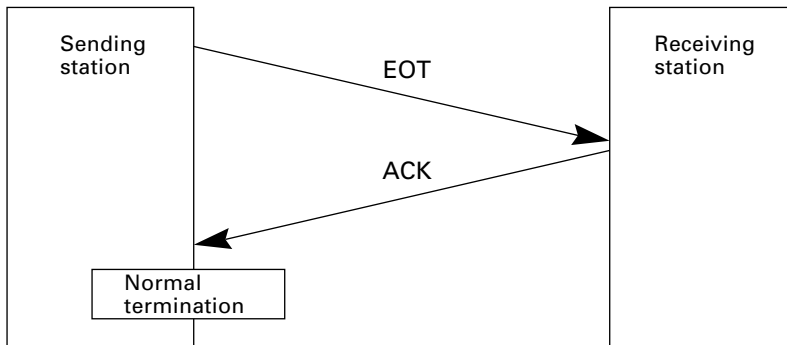

■ Phase 3 with iterated EOT transmission due to no response or invalid response

If the sending station receives no response or any invalid response from the receiving station in response to an EOT sent, it iterates sending of an EOT at three-second intervals up to ten times.

If the sending station receives an ACK before sending an EOT ten times, it terminates the message transmission normally and releases the data link.

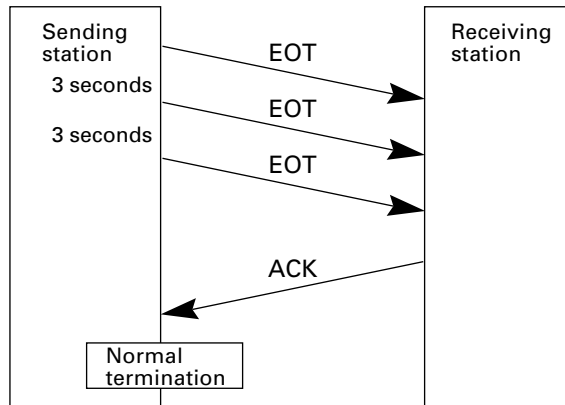

■ Abnormal termination of phase 3

If the sending station receives no ACK from the receiving station within three seconds from the 10th EOT, it terminates the message transmission abnormally and releases the data link.

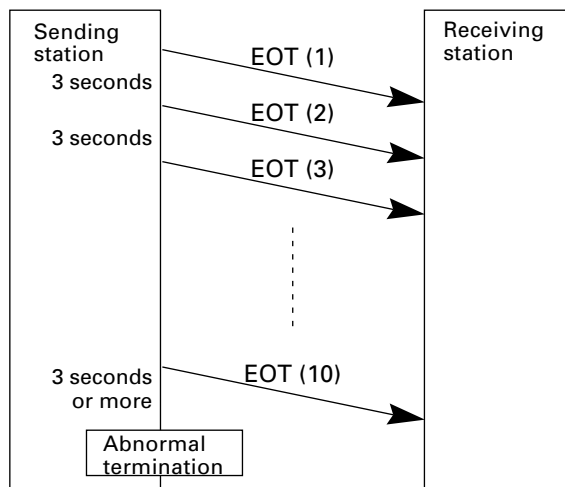

[2] Aborting Data Transmission

Pressing the C key aborts data transmission.

If the C key is pressed during downloading, the BHT-7000 transmits an EOT and aborts the file transmission.

If it is pressed during uploading, the BHT-7000 transmits the current transmission block followed by EOT and then aborts the file transmission.

[3] BCC for Horizontal Parity Checking

To check whether data has been transmitted accurately, the BHT-7000 supports horizontal parity checking for every transmission block.

In horizontal parity checking, a horizontal parity byte so called BCC (Block Check Character) is suffixed to an ETX of every transmission block.

In the BHT-protocol, every parity bit of BCC is set so that all set bits at the same bit level (including a parity bit) in the characters contained in the transmission block have an even number by binary addition, excluding SOH, STX, and functions SOH\$ and STX\$.

(For details about SOH\$ and STX\$ which are protocol functions unique to BHT-BASIC, refer to the "BHT-BASIC Programmer's Manual.")

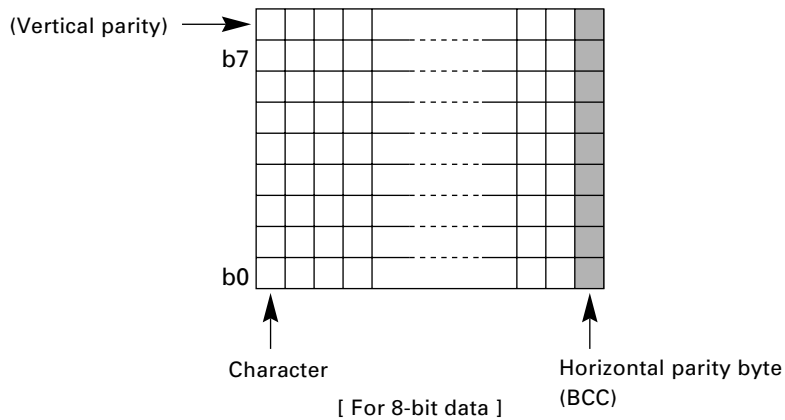

Shown below is a data text block indicating the bits to be added for horizontal parity checking.

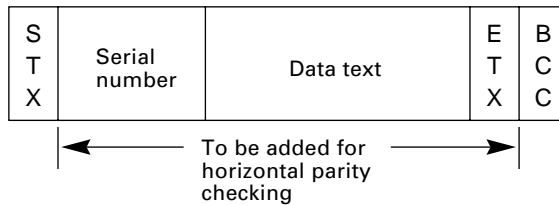

B.2 BHT-Ir protocol

[1] Transmission Control Sequences

Shown below is a typical message transmission sequence supported by the BHT-Ir protocol. This sequence example does not include transmission errors or negative responses.

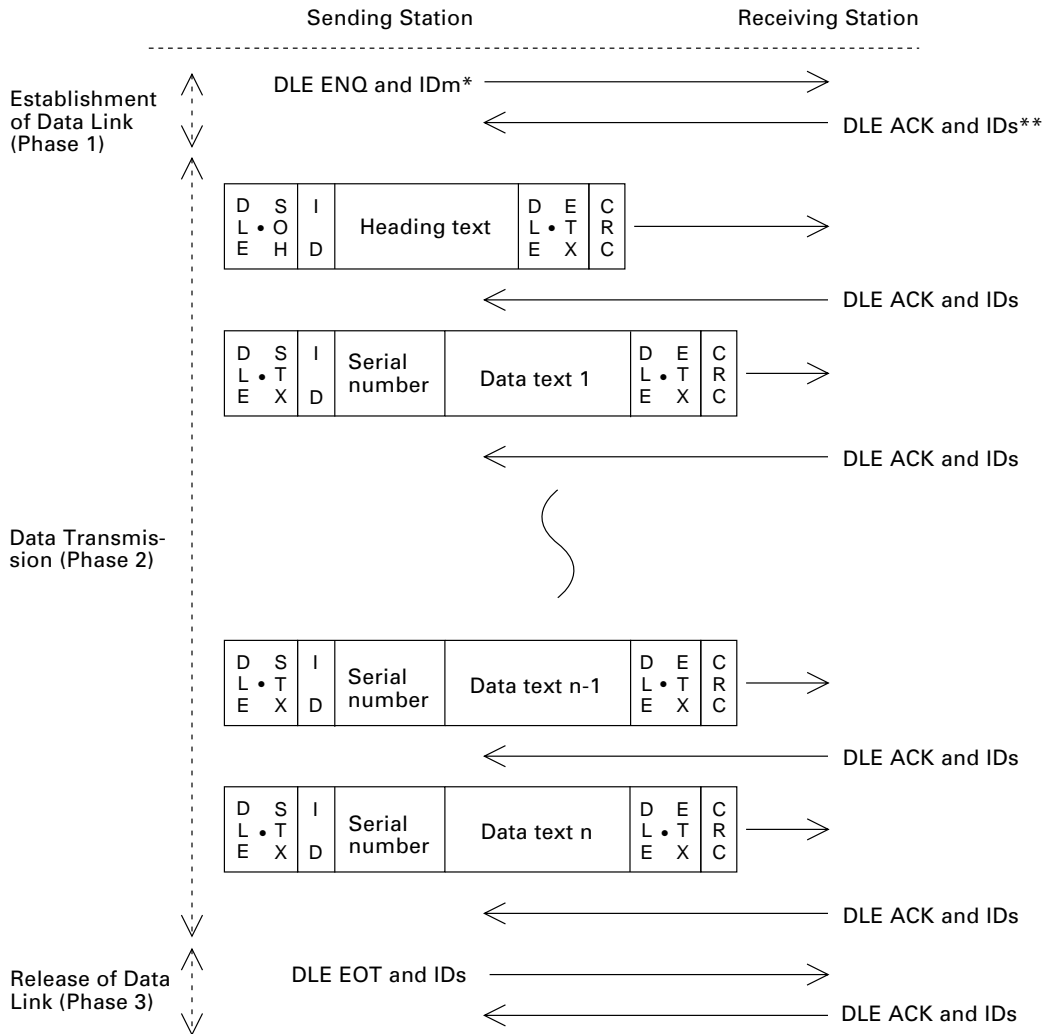

*IDm: ID of sending station
 **IDs: ID of receiving station

Data transmission may accidentally involve various types of errors. The BHT-Ir protocol is designed to recover from those errors as frequently as possible. What follows is the BHT-Ir protocol for phases 1 through 3.

Phase 1: Establishment of Data Link

■ Normal phase 1

The sending station transmits a sequence of DLE ENQ and IDm (sending station's ID) to the receiving station. Upon receipt of a sequence of DLE ACK and IDr (receiving station's ID) from the receiving station, the sending station shifts to phase 2.

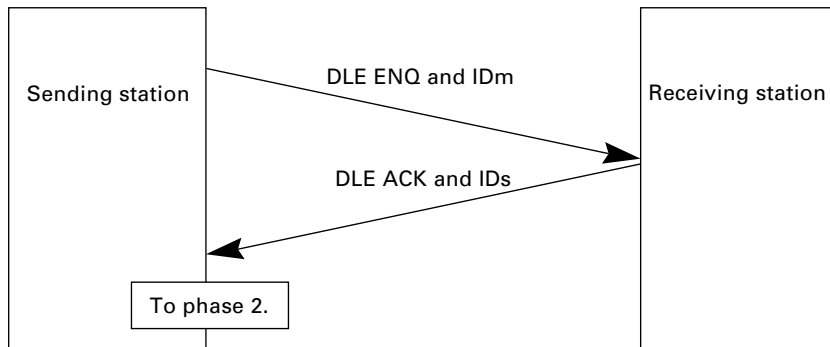

■ Phase 1 with iterated transmission of DLE ENQ and IDm due to no response or invalid response

If the sending station receives no response or any invalid response from the receiving station in response to the sent sequence of DLE ENQ and IDm, it iterates sending of the sequence at 0.5-second intervals up to 60 times.

If the sending station receives a sequence of DLE ACK and IDr before sending the sequence of DLE ENQ and IDm 60 times, it shifts to phase 2.

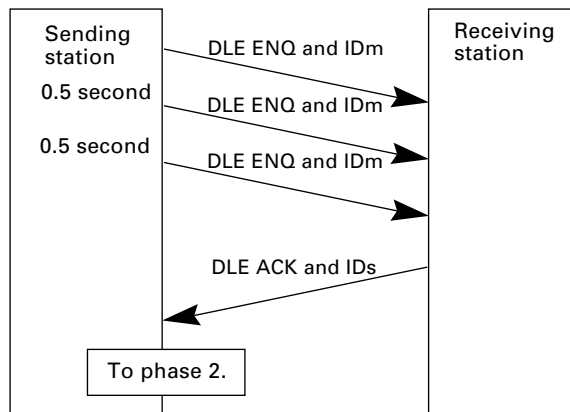

TIP

You may modify the number of iterations of a sequence of DLE ENQ and IDm for the sending station. The default is 60 times at 0.5-second intervals. For details, refer to the SET PROTOCOL screen in System Mode (pp. 54 and 56) and the XFILE statement given in "BHT-BASIC Programmer's Manual."

■ **Abnormal termination of phase 1 (Abort of phase 1)**

If the sending station receives no sequence of DLE ACK and ID's from the receiving station after sending a sequence of DLE ENQ and IDm 60 times in succession, it sends a sequence of DLE EOT and IDm to the receiving station after 0.5 second from the 60th sequence of DLE ENQ and IDm, then aborts the message transmission abnormally.

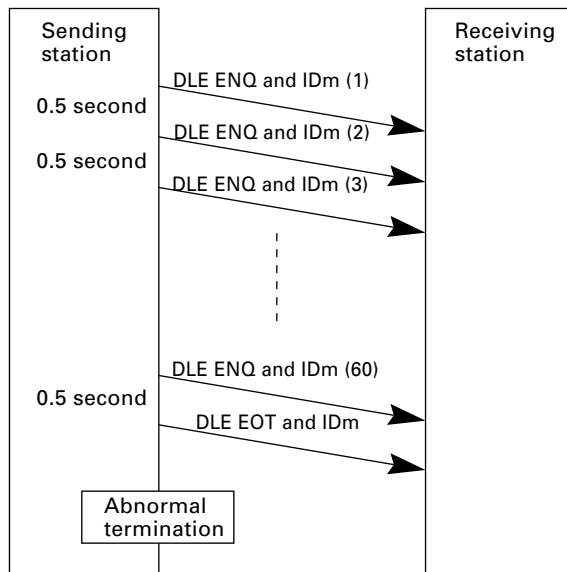

TIP

The receiving station's default timeout is 30 seconds. You may modify the timeout length on the SET PROTOCOL screen in System Mode (pp. 54 and 56) or by using the XFILE statement (refer to the "BHT-BASIC Programmer's Manual").

Phase 2: Data Transmission

■ Normal phase 2

The sending station first sends a transmission block containing the heading text. Each time the sending station receives a sequence of DLE ACK and IDs from the receiving station, it sends a transmission block containing the data texts as shown below. Upon receipt of a sequence of DLE ACK and IDs in response to the last transmission block (data text n), the sending station shifts to phase 3.

If a transmission message contains no data text, the sending station transmits the heading text only.

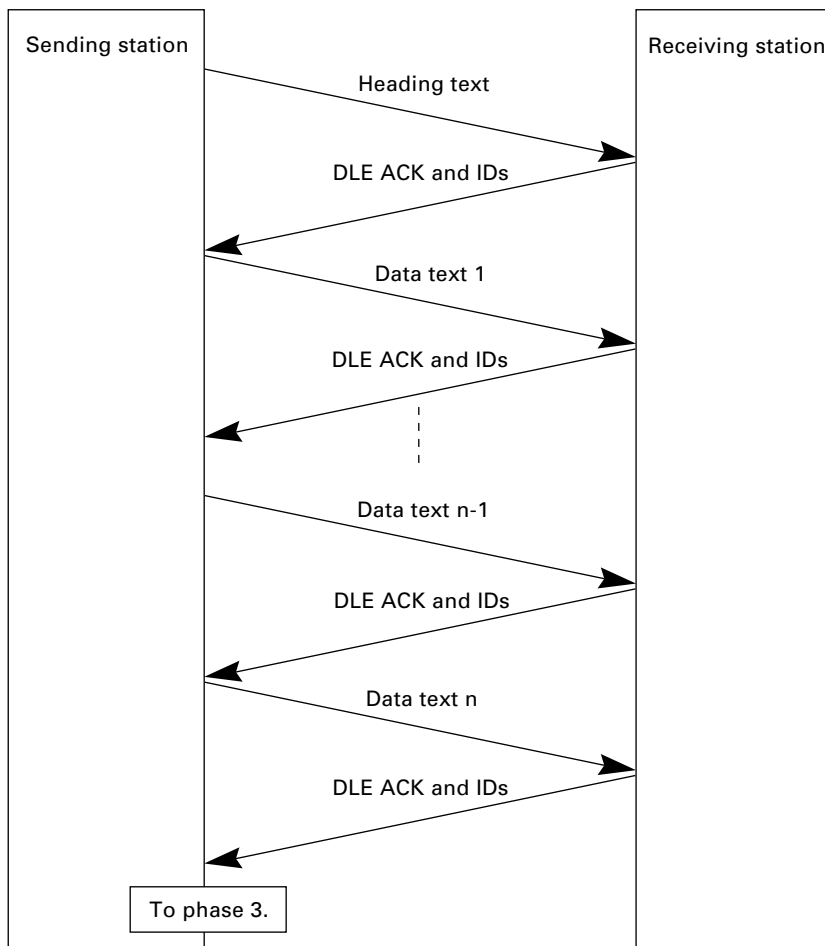

■ **Phase 2 with suspension of data reception for erasure of the flash memory**

If the receiving BHT-7000 requires the flash memory to be erased for receiving downloaded files, it sends a sequence of WACK and IDs to the sending station to suspend the data transmission.

Upon receipt of the sequence of WACK and IDs, the sending station stops the data transmission until any response comes from the receiving station for one minute. If no response comes within one minute, the sending station sends a sequence of DLE EOT and IDs and then aborts the current transmission.

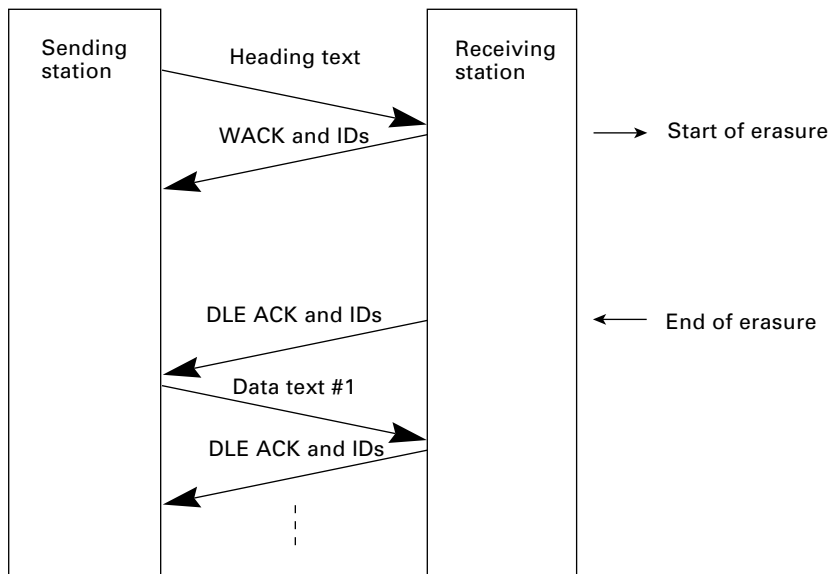

■ Phase 2 with a sequence of DLE NAK and IDs

If the sending station receives a sequence of DLE NAK and IDs from the receiving station in response to a transmission block containing text data m , it sends that transmission block again immediately as shown below.

If the sending station receives a sequence of DLE ACK and IDs before receiving the sequence of DLE NAK and IDs 10 times in succession, it continues the subsequent message transmission.

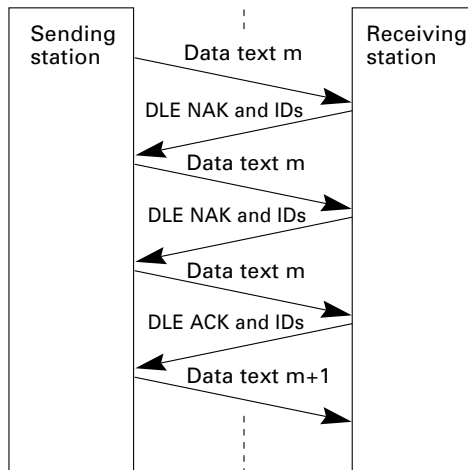

If the sending station receives a sequence of DLE NAK and IDs 10 times in succession or it fails to send a same transmission block, it shifts to phase 3 to terminate the message transmission abnormally. Even if the phase 3 terminates normally, the transmission results in an abnormal end.

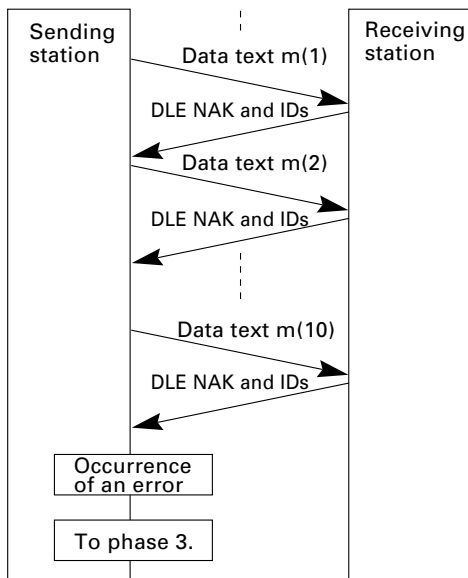

■ **Phase 2 with a sequence of DLE EOT and IDs**

If the sending station receives a sequence of DLE EOT and IDs anytime during phase 2, it shifts to phase 3 to terminate the message transmission abnormally. Even if the phase 3 terminates normally, the transmission results in an abnormal end.

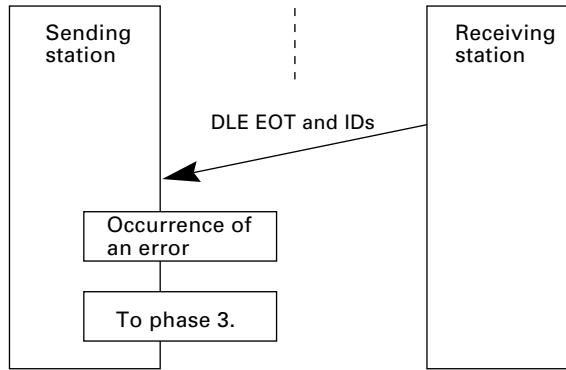

■ **Phase 2 with iterated transmission of DLE ENQ and IDs due to no response or invalid response**

If the sending station receives no response or any invalid response from the receiving station in response to a transmission block sent, it iterates sending of a sequence of DLE ENQ and IDs at 0.5-second intervals up to 59 times.

If the sending station receives a sequence of DLE ACK and IDs before sending the sequence of DLE ENQ and IDs 59 times, it continues the subsequent message transmission.

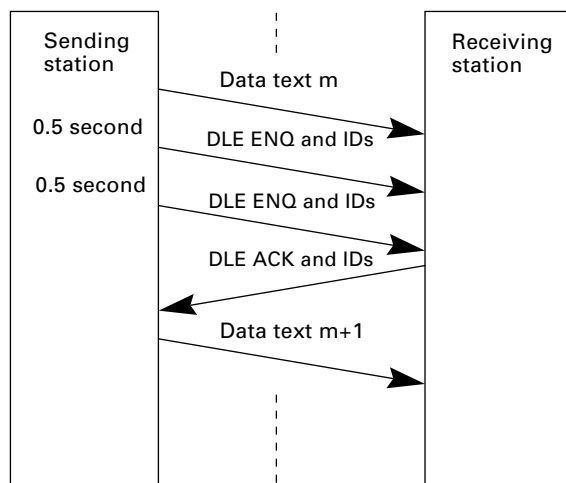

■ Abnormal termination of phase 2 (Abort of phase 2)

If the sending station receives no sequence of DLE ACK and IDs from the receiving station after sending a sequence of DLE ENQ and IDs 59 times in succession, it sends a sequence of DLE EOT and IDs to the receiving station after 0.5 second from the 59th sequence of DLE ENQ and IDs and then aborts this transmission abnormally.

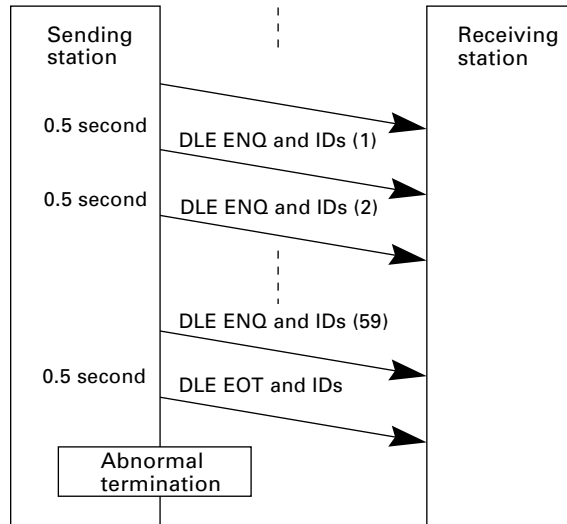

Phase 3: Release of Data Link

■ Normal phase 3

The sending station transmits a sequence of DLE EOT and IDs to the receiving station. Upon receipt of a sequence of DLE ACK and IDs from the receiving station, the sending station terminates the message transmission normally and releases the data link.

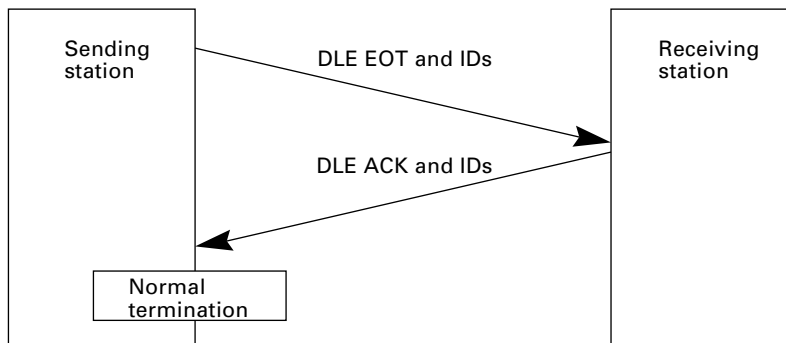

■ **Phase 3 with iterated transmission of DLE EOT and IDs due to no response or invalid response**

If the sending station receives no response or any invalid response from the receiving station in response to the sent sequence of DLE EOT and IDs, it iterates sending of the sequence at 0.5-second intervals up to 60 times.

If the sending station receives a sequence of DLE ACK and IDs before sending the sequence of DLE EOT and IDs 60 times, it terminates the message transmission normally and releases the data link.

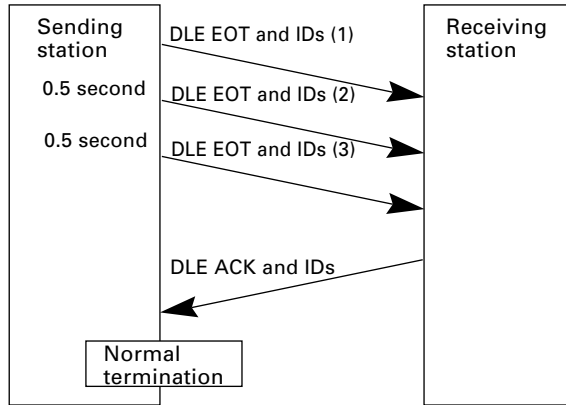

■ **Abnormal termination of phase 3**

If the sending station receives no sequence of DLE ACK and IDs from the receiving station within 0.5 second from the 60th sequence of DLE EOT and IDs, it aborts the message transmission abnormally and releases the data link.

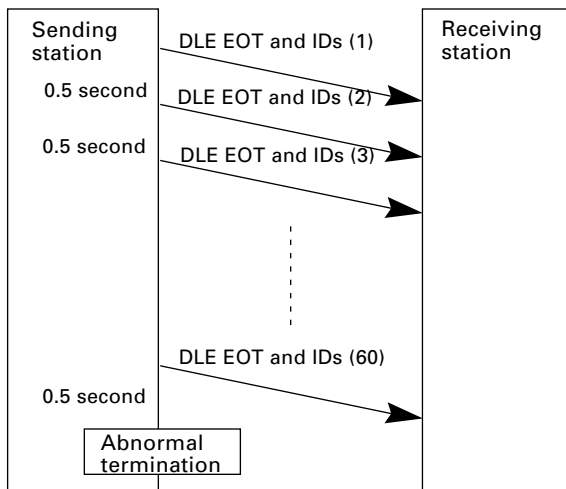

■ Phase 3 with timeout at the receiving station

If the receiving station receives no subsequent text or normal sequence of DLE EOT and IDs within 30 seconds after sending a sequence of DLE ACK and IDs, it sends a sequence of DLE EOT and IDs and aborts the transmission abnormally.

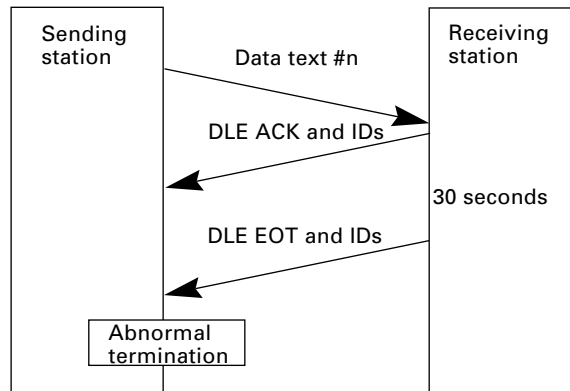

[2] Aborting Data Transmission

Pressing the **C** key aborts data transmission.

If the **C** key is pressed during downloading, the BHT-7000 transmits a sequence of DLE EOT and IDs and aborts the file transmission.

If it is pressed during uploading, the BHT-7000 transmits the current transmission block followed by a sequence of DLE EOT and IDs and then aborts the file transmission.

[3] CRC

To check whether data has been transmitted accurately, the BHT-Ir protocol supports CRC (Cyclic Redundancy Check) which employs the CRC-16 generating system. In CRC, a CRC character is suffixed to a sequence of DLE ETX of every transmission block.

Operands for CRC-16

The CRC generates CRC-16 from all bytes of a transmission block excluding DLE SOH or DLE STX characters (which are at the head of a transmission block), DLE character of DLE ETX and DLE character of DLE DLE in the text.

CRC operation

The CRC system generates CRC-16 as follows: It multiplies the polynomial formed by aligning all of the bits starting from the LSB of the first byte to the MSB of the last byte in a transmission block in descending order, by X^{16} . Next, divide the polynomial by the generative polynomial $X^{16} + X^{15} + X^2 + 1$. The remainder is the value of CRC-16.

Shown below is a data text transmission block and operands for CRC-16 generation.

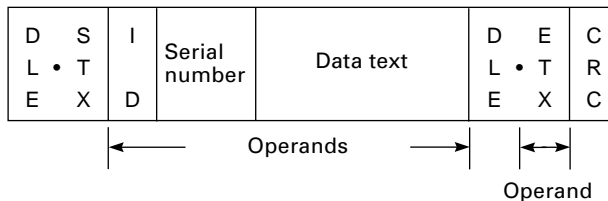

[4] ID

ID is a 2-digit hexadecimal and designated in 0000h through FFFFh in (2 bytes). 0000h is assigned to the host computer. Any of 0001h through FFFFh is assigned to the BHT-7000 as follows.

- The system sets an ID when the BHT-7000 is initialized.
- You may set an arbitrary ID in System Mode or by using the OUT statement in BHT-BASIC.

Appendix C.

A Typical Basic Operation

What follows is a typical basic operation which helps you instruct the hands-on user in practical bar-code reading operation.

Application type: Inventory

Operation: Power ON → Read the bar code on stock (A). → Key in the quantity.
Read the bar code on stock (B). → Key in the quantity.
⋮
Repeat the above operation.

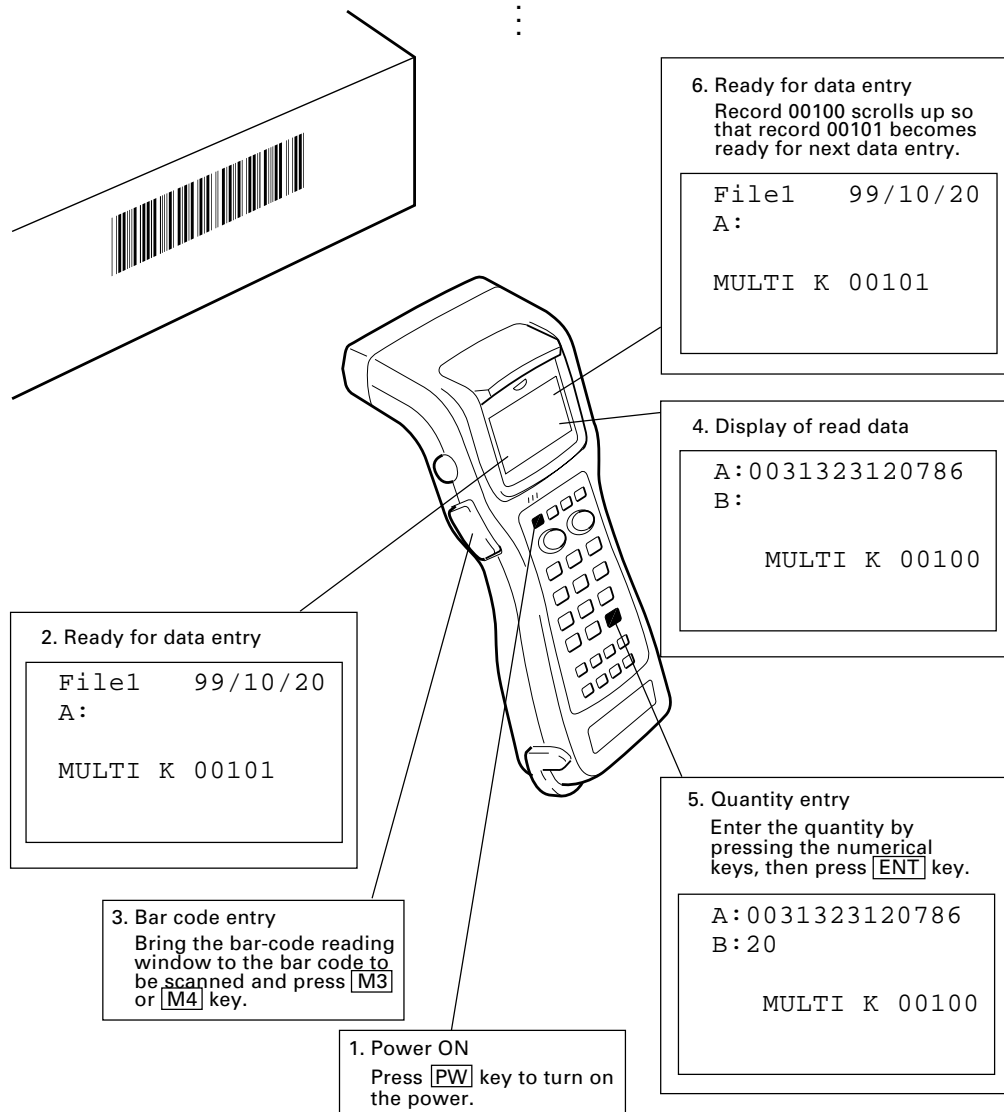

Index

Symbols

26-key pad 4, 15, 17, 25, 33, 37, 38, 39,
40, 44, 47, 48, 50, 53, 54, 55, 56,
57, 58, 59, 60, 61, 62, 68, 69, 72,
73, 75, 76, 80, 81, 126

3-pole mini stereo plug 9, 40, 69, 86

32-key pad 15, 16, 33, 72, 73, 126

A

aging test 35, 62, 65

B

backlight function on/off key 16, 17

bar-code reading test 35, 62, 63

battery cartridge ii, v, vi, vii, viii, x, xii,
xiii, 7, 15, 16, 17, 18, 19, 20, 21,
27, 28, 104, 105, 106, 108, 115,
116, 120, 126

battery level, battery output level,
battery output voltage, battery
voltage level xii, 7, 16, 17, 19,
20, 24, 26, 48, 104, 105

beeper scale test 62, 65

beeper volume xii, 7, 19, 24, 25, 48

BHT system parameter file 7, 36, 76,
77, 78, 79, 113

BHT-BASIC Compiler 8, 9, 12

BHT-BASIC Extension Library 8

BHT-BASIC Interpreter 11

BHT-Ir protocol xii, xiii, 9, 10, 14, 54,
55, 56, 58, 85, 91, 97, 99, 100, 101,
119, 125, 143, 144, 153

BHT-protocol xii, xiii, 10, 52, 58, 85,
91, 93, 94, 95, 119, 125, 133, 134,
142

black-and-white inverted label reading
47, 50

C

C-700, C-750 v, 21

calendar clock xii, 7, 12, 19, 22, 27, 28,
32, 34, 40, 44, 47, 49, 106, 109,
127

character length 52, 55, 88, 90

CODABAR 63, 128

CODE128 63, 128

CODE39 63, 128, 129

communications parameter xii, 34, 42,
46, 47, 52, 53, 54, 55, 77, 79, 82,
84, 85, 90, 112, 113, 119

communications protocol ii, xii, xiii,
13, 52, 53, 54, 55, 56, 58, 85, 91,
119, 125, 133

connector cover 15, 40

control character 85, 91, 92, 93, 94, 97,
98, 99, 100

CRC 97, 100, 125, 153

CU-7001 xiii, 115, 116, 120, 121, 125,
131

CU-7002 116, 131

D

DCE 123

decode level 50

deleting files 7, 36, 75

DIP switch 118

direct-connect viii, 9, 10, 15, 40, 52,
53, 55, 57, 69, 71, 130

download 7, 8, 9, 11, 12, 32, 34, 36, 39,
40, 41, 42, 43, 44, 57, 58, 76, 77,
81, 82, 109, 110, 111, 112, 119,
141, 147, 152

driver iv, 11

dry battery cartridge viii, 15, 18, 19,
20, 104, 105, 106, 126

Dsub-25P 118

DTE 123

E

EAN-13 63, 128

EAN-8 63, 128

Error in System Mode settings 108

execution program 34, 47, 48, 107,
108, 109, 110

extension program 8, 11

F

field space, space codes in the tail of a
data field 52, 54, 56

file test 35, 68

flash memory 98, 126, 147

flash memory error 109

H

hand strap xii, 1, 3, 15

horizontal parity 52, 54, 56, 91, 125,
142

HT<-->HT COPY 40, 41, 44, 45, 46

I

indicator LED 2, 15, 35, 62, 63, 66, 120,
121, 127

infrared communications xii, 7, 13

initializing xii, 7, 29, 48

interface cable viii, xiii, 8, 9, 40, 85, 86,
87, 88, 115, 118, 123

interface port 6, 8, 9, 15, 34, 40, 42, 46,
47, 52, 53, 57, 69, 70, 71, 77, 79,
82, 84, 86, 90, 112, 113, 116, 118,
119, 122, 132

Interleaved 2 of 5 (ITF) 63, 128

Ir-Transfer Utility C iii, 8, 9, 41, 45, 58,
119

Ir-Transfer Utility E iii, 8, 9, 10, 12, 41,
45, 58, 119

IrDA interface 8, 9

IrDA-compliant 6, 9, 13

ITF 47, 50, 51, 63, 126, 128, 129

J

JIS Level 1, JIS Level 2 11, 12, 74

K

Key entry & beeper test 72

L

LCD and indicator LED tests 62, 66

LCD contrast xii, 7, 19, 24, 25, 32, 48

LED indicators 116

lithium-ion battery v, vii, xiii, 20, 21,
115, 116, 120, 126

low battery indication 20, 104, 105

M

M1 4, 16, 17, 24, 30, 59, 60, 72

M2 16, 17, 24, 59, 60, 72

M3 2, 15, 59, 60, 72, 154

M4 2, 15, 59, 60, 72, 154
 magic key v, 34, 47, 59, 60, 126
 marker 2, 50, 51, 92
 memory size 35
 memory test 35, 64
 message version 30, 34, 35, 47, 48, 74

N

Nonlock 59

O

Onetime 59
 optical communications 6, 8, 116, 132
 optical communications unit 8
 optical interface xii, 1, 6, 15, 40, 52,
 53, 69, 70, 88, 90, 116, 119, 130,
 132

P

power LED 116, 120
 program execution 7, 34, 39, 104
 program version 35, 74
 protection sheet of the DIP switch 118
 protocol ii, xii, xiii, 9, 10, 13, 14, 52,
 53, 54, 55, 56, 58, 85, 91, 93, 94,
 95, 97, 99, 100, 101, 119, 125, 133,
 134, 135, 142, 143, 144, 145, 153

R

RAM 62, 64, 74, 126
 remote wakeup 7, 80
 resume data saving error 107
 resume function 34, 47, 61, 107
 RS-232C ii, xii, xiii, 8, 9, 85, 86, 115,

116, 118, 122, 123, 130, 132

S

serial number 52, 54, 56, 94, 100, 133,
 142, 143, 153
 space codes in the tail of a data field
 54, 56
 specular effect 2
 Standard 2 of 5 (STF) 63, 128
 STF 47, 50, 51, 63, 128
 stop bit length 55, 90
 supplemental code 128
 system area 11
 system down error 108
 SYSTEM MENU 12, 22, 33, 34, 36, 39,
 40, 42, 44, 46, 47, 48, 49, 50, 53,
 59, 61, 62, 74, 75, 76, 77, 79, 80,
 81, 82, 84, 107, 110, 111, 112, 113,
 119
 system message file 7, 36, 81, 82, 83,
 84, 111, 113
 System Mode ii, xii, xiii, xv, 7, 11, 12,
 16, 17, 22, 33, 34, 36, 37, 39, 40,
 44, 57, 58, 69, 90, 103, 104, 105,
 107, 108, 110, 119, 134, 135, 144,
 145, 153
 System Program malfunction 106

T

timeout 54, 56, 70, 71, 135, 145, 152
 Transfer Utility iii, 8, 9, 10, 12, 41, 45,
 58, 96, 119
 transmission speed xiii, 9, 13, 54, 55,
 80, 88, 90, 115, 118, 130
 transparency 92
 trigger switch 2, 15, 16, 17, 59, 60, 72

U

UPC-A 63, 128

UPC-E 63, 128

upload 7, 12, 22, 34, 36, 40, 44, 45, 46,
57, 58, 68, 76, 78, 79, 81, 82, 83,
84, 110, 113, 119, 141, 152

user area 11, 29, 30, 31, 39, 40, 76, 81,
83, 109

V

vertical parity 52, 55, 88, 89, 90, 142

Bar Code Handy Terminal BHT-7000

User's Manual

First Edition, May 2000

DENSO WAVE INCORPORATED

The purpose of this manual is to provide accurate information in the handling and operating of the BHT-7000. Please feel free to send your comments regarding any errors or omissions you may have found, or any suggestions you may have for generally improving the manual.

In no event will DENSO WAVE be liable for any direct or indirect damages resulting from the application of the information in this manual.

Free Manuals Download Website

<http://myh66.com>

<http://usermanuals.us>

<http://www.somanuals.com>

<http://www.4manuals.cc>

<http://www.manual-lib.com>

<http://www.404manual.com>

<http://www.luxmanual.com>

<http://aubethermostatmanual.com>

Golf course search by state

<http://golfingnear.com>

Email search by domain

<http://emailbydomain.com>

Auto manuals search

<http://auto.somanuals.com>

TV manuals search

<http://tv.somanuals.com>