

DENON

AV SURROUND RECEIVER

AVR-3600

OPERATING INSTRUCTIONS

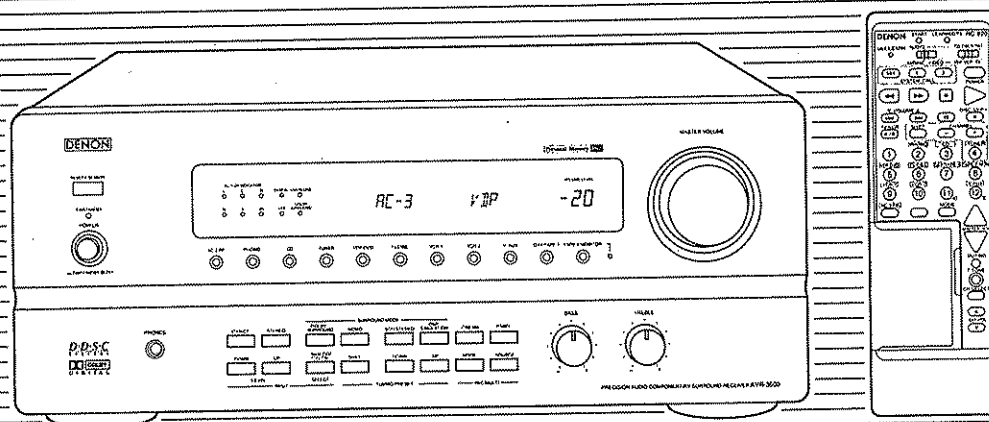

- We greatly appreciate your purchase of the AVR-3600.
- To be sure you take maximum advantage of all the features the AVR-3600 has to offer, read these instructions carefully and use the set properly. Be sure to keep this manual for future reference should any questions or problems arise.

"SERIAL NO. _____

PLEASE RECORD UNIT SERIAL NUMBER ATTACHED TO THE REAR OF THE CABINET FOR FUTURE REFERENCE

• SAFETY PRECAUTIONS

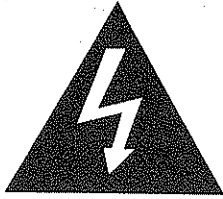

CAUTION
RISK OF ELECTRIC SHOCK
DO NOT OPEN

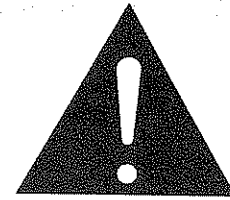

CAUTION: TO REDUCE THE RISK OF ELECTRIC SHOCK, DO NOT REMOVE COVER (OR BACK). NO USER SERVICEABLE PARTS INSIDE. REFER SERVICING TO QUALIFIED SERVICE PERSONNEL.



The lightning flash with arrowhead symbol, within an equilateral triangle, is intended to alert the user to the presence of uninsulated "dangerous voltage" within the product's enclosure that may be of sufficient magnitude to constitute a risk of electric shock to persons.



The exclamation point within an equilateral triangle is intended to alert the user to the presence of important operating and maintenance (servicing) instructions in the literature accompanying the appliance.

WARNING: TO REDUCE THE RISK OF FIRE OR ELECTRIC SHOCK, DO NOT EXPOSE THIS APPLIANCE TO RAIN OR MOISTURE.

CAUTION

TO PREVENT ELECTRIC SHOCK DO NOT USE THIS (POLARIZED) PLUG WITH AN EXTENSION CORD, RECEPTACLE OR OTHER OUTLET UNLESS THE BLADES CAN BE FULLY INSERTED TO PREVENT BLADE EXPOSURE.

ATTENTION

POUR PREVENIR LES CHOCS ELECTRIQUES NE PAS UTILISER CETTE FICHE POLARISEE AVEC UN PROLONGATEUR UNE PRISE DE COURANT OU UNE AUTRE SORTIE DE COURANT, SAUF SI LES LAMES PEUVENT ETRE INSEREES A FOND SANS EN LAISSER AUCUNE PARTIE A DECOUVERT.

SAFETY INSTRUCTIONS

1. Read Instructions – All the safety and operating instructions should be read before the appliance is operated.
2. Retain Instructions – The safety and operating instructions should be retained for future reference.
3. Heed Warnings – All warnings on the appliance and in the operating instructions should be adhered to.
4. Follow Instructions – All operating and use instructions should be followed.
5. Water and Moisture – The appliance should not be used near water – for example, near a bathtub, washbowl, kitchen sink, laundry tub, in a wet basement, or near a swimming pool, and the like.
6. Carts and Stands – The appliance should be used only with a cart or stand that is recommended by the manufacturer.
- 6A. An appliance and cart combination should be moved with care. Quick stops, excessive force, and uneven surfaces may cause the appliance and cart combination to overturn.
7. Wall or Ceiling Mounting – The appliance should be mounted to a wall or ceiling only as recommended by the manufacturer.
8. Ventilation – The appliance should be situated so that its location or position does not interfere with its proper ventilation. For example, the appliance should not be situated on a bed, sofa, rug, or similar surface that may block the ventilation openings; or, placed in a built-in installation, such as a bookcase or cabinet that may impede the flow of air through the ventilation openings.
9. Heat – The appliance should be situated away from heat sources such as radiators, heat registers, stoves, or other appliances (including amplifiers) that produce heat.
10. Power Sources – The appliance should be connected to a power supply only of the type described in the operating instructions or as marked on the appliance.
11. Grounding or Polarization – Precautions should be taken so that the grounding or polarization means of an appliance is not defeated.



12. Power-Cord Protection – Power-supply cords should be routed so that they are not likely to be walked on or pinched by items placed upon or against them, paying particular attention to cords at plugs, convenience receptacles, and the point where they exit from the appliance.
14. Cleaning – The appliance should be cleaned only as recommended by the manufacturer.
15. Power Lines – An outdoor antenna should be located away from power lines.
16. Outdoor Antenna Grounding – If an outside antenna is connected to the receiver, be sure the antenna system is grounded so as to provide some protection against voltage surges and built-up static charges. Article 810 of the National Electrical Code, ANSI/NFPA 70, provides information with regard to proper grounding of the mast and supporting structure, grounding of the lead-in wire to an antenna-discharge unit, size of grounding conductors, location of antenna-discharge unit, connection to grounding electrodes, and requirements for the grounding electrode. See Figure A.
17. Nonuse Periods – The power cord of the appliance should be unplugged from the outlet when left unused for a long period of time.
18. Object and Liquid Entry – Care should be taken so that objects do not fall and liquids are not spilled into the enclosure through openings.
19. Damage Requiring Service – The appliance should be serviced by qualified service personnel when:
 - A. The power-supply cord or the plug has been damaged; or
 - B. Objects have fallen, or liquid has been spilled into the appliance; or
 - C. The appliance has been exposed to rain; or
 - D. The appliance does not appear to operate normally or exhibits a marked change in performance; or
 - E. The appliance has been dropped, or the enclosure damaged.
20. Servicing – The user should not attempt to service the appliance beyond that described in the operating instructions. All other servicing should be referred to qualified service personnel.

FIGURE A
EXAMPLE OF ANTENNA GROUNDING
AS PER NATIONAL
ELECTRICAL CODE

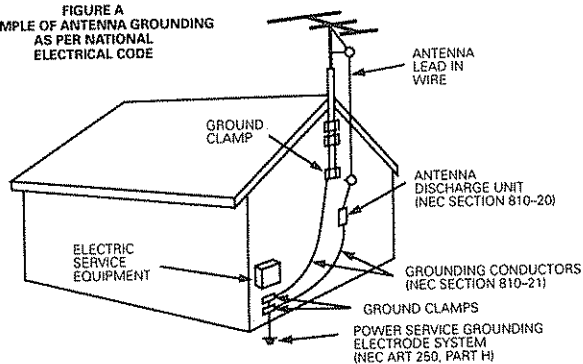





NEC - NATIONAL ELECTRICAL CODE

TABLE OF CONTENTS

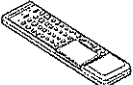
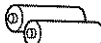

<table border="0" style="width: 100%;"> <tr><td style="border: 1px solid black; padding: 2px;">1</td><td>Note on Use</td><td style="text-align: right;">4</td></tr> <tr><td style="border: 1px solid black; padding: 2px;">2</td><td>Before Using</td><td style="text-align: right;">5</td></tr> <tr><td style="border: 1px solid black; padding: 2px;">3</td><td>Cautions on Installation</td><td style="text-align: right;">5</td></tr> <tr><td style="border: 1px solid black; padding: 2px;">4</td><td>Cautions on Handling</td><td style="text-align: right;">5</td></tr> <tr><td style="border: 1px solid black; padding: 2px;">5</td><td>Connections</td><td style="text-align: right;">6~10</td></tr> <tr><td style="border: 1px solid black; padding: 2px;">6</td><td>System Setup</td><td style="text-align: right;">11~17</td></tr> <tr><td style="border: 1px solid black; padding: 2px;">7</td><td>Remote Control Unit</td><td style="text-align: right;">18~22</td></tr> </table>	1	Note on Use	4	2	Before Using	5	3	Cautions on Installation	5	4	Cautions on Handling	5	5	Connections	6~10	6	System Setup	11~17	7	Remote Control Unit	18~22	<table border="0" style="width: 100%;"> <tr><td style="border: 1px solid black; padding: 2px;">8</td><td>Operations</td><td style="text-align: right;">22~26</td></tr> <tr><td style="border: 1px solid black; padding: 2px;">9</td><td>Using the Surround Function</td><td style="text-align: right;">26~32</td></tr> <tr><td style="border: 1px solid black; padding: 2px;">10</td><td>Listening to the Radio</td><td style="text-align: right;">32~34</td></tr> <tr><td style="border: 1px solid black; padding: 2px;">11</td><td>Last Function Memory</td><td style="text-align: right;">34</td></tr> <tr><td style="border: 1px solid black; padding: 2px;">12</td><td>Initialization of the Microprocessor</td><td style="text-align: right;">34</td></tr> <tr><td style="border: 1px solid black; padding: 2px;">13</td><td>Troubleshooting</td><td style="text-align: right;">35</td></tr> <tr><td style="border: 1px solid black; padding: 2px;">14</td><td>Specifications</td><td style="text-align: right;">bottom</td></tr> </table>	8	Operations	22~26	9	Using the Surround Function	26~32	10	Listening to the Radio	32~34	11	Last Function Memory	34	12	Initialization of the Microprocessor	34	13	Troubleshooting	35	14	Specifications	bottom
1	Note on Use	4																																									
2	Before Using	5																																									
3	Cautions on Installation	5																																									
4	Cautions on Handling	5																																									
5	Connections	6~10																																									
6	System Setup	11~17																																									
7	Remote Control Unit	18~22																																									
8	Operations	22~26																																									
9	Using the Surround Function	26~32																																									
10	Listening to the Radio	32~34																																									
11	Last Function Memory	34																																									
12	Initialization of the Microprocessor	34																																									
13	Troubleshooting	35																																									
14	Specifications	bottom																																									

• ACCESSORIES

Check that the following parts are included in addition to the main unit:

① Operating instructions 1 ④ Remote control unit (RC-820) 1	② Warranty (for North American model only) 1 ⑤ R6P/AA batteries 2	③ Service station list 1 ⑦ FM indoor antenna 1	⑥ AM loop antenna 1 ⑧ FM antenna adaptor 1
			
			

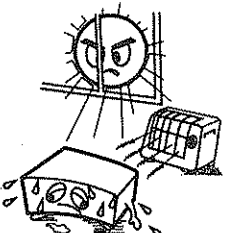
1 NOTE ON USE

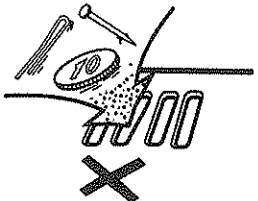
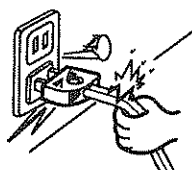
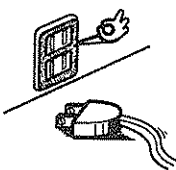
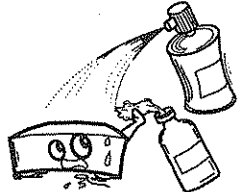
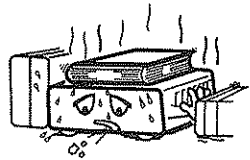
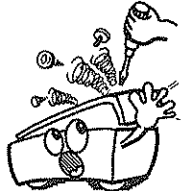
		
<ul style="list-style-type: none"> • Avoid high temperatures Allow for sufficient heat dispersion when installed on a rack. 	<ul style="list-style-type: none"> • Keep the set free from moisture, water, and dust. 	<ul style="list-style-type: none"> • Do not let foreign objects in the set.
		
<ul style="list-style-type: none"> • Handle the power cord carefully. Hold the plug when unplugging the cord. 	<ul style="list-style-type: none"> • Unplug the power cord when not using the set for long periods of time. 	<ul style="list-style-type: none"> • Do not let insecticides, benzene, and thinner come in contact with the set.
		
	<p style="text-align: center;">*(For sets with ventilation holes)</p> <ul style="list-style-type: none"> • Do not obstruct the ventilation holes. 	<ul style="list-style-type: none"> • Never disassemble or modify the set in any way.

2 BEFORE USING

Pay attention to the following before using this unit:

- **Moving the set**
To prevent short circuits or damaged wires in the connection cords, always unplug the power cord and disconnect the connection cords between all other audio components when moving the set.
- **Before turning the power switch on**
Check once again that all connections are proper and that there are not problems with the connection cords. Always set the power switch to the standby position before connecting and disconnecting connection cords.

3 CAUTIONS ON INSTALLATION

Noise or disturbance of the picture may be generated if this unit or any other electronic equipment using microprocessors is used near a tuner or TV.

If this happens, take the following steps:

- Install this unit as far as possible from the tuner or TV.
- Set the antenna wires from the tuner or TV away from this unit's power cord and input/output connection cords.
- Noise or disturbance tends to occur particularly when using indoor antennas or 300 Ω /ohms feeder wires. **We recommend using outdoor antennas and 75 Ω / ohms coaxial cables.**

For heat dispersal, leave at least 10 cm of space between the top, back and sides of this unit and the wall or other components.

- **Store this instructions in a safe place.**
After reading, store this instructions along with the warranty in a safe place. Also fill in the items on the back page for your convenience.
- **Note that the illustrations in this instructions may differ from the actual set for explanation purposes.**

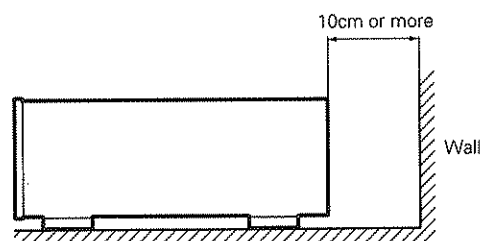
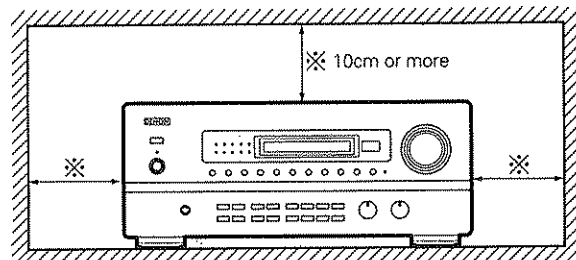

4 CAUTIONS ON HANDLING

- **Switching the input function when input jacks are not connected**
A clicking noise may be produced if the input function is switched when nothing is connected to the input jacks. If this happens, either turn down the MASTER VOLUME control or connect components to the input jacks.
- **Muting of PRE OUT jacks**
The PRE OUT jacks include a muting circuit. Because of this, the output signals are greatly reduced for several seconds after the power switch is turned on or input function, surround mode or any other set-up is changed. If the volume is turned up during this time, the output will be very high after the muting circuit stops functioning. Always wait until the muting circuit turns off before adjusting the volume.

- **Whenever the power switch is in the OFF state, the apparatus is still connected on AC line voltage. Please be sure to unplug the cord when you leave home for, say, a vacation.**

5 CONNECTIONS

- Do not plug in the power cord until all connections have been completed.
- Be sure to connect the left and right channels properly (left with left, right with right).
- Insert the plugs securely. Incomplete connections will result in the generation of noise.
- Use the AC OUTLETS for audio equipment only. Do not use them for hair driers, etc.
- Note that binding pin plug cords together with power cords or placing them near a power transformer will result in generating hum or other noise.
- Noise or humming may be generated if a connected audio equipment is used independently without turning the power of this unit on. If this happens, turn on the power of the this unit.

5-1 Connecting the audio components

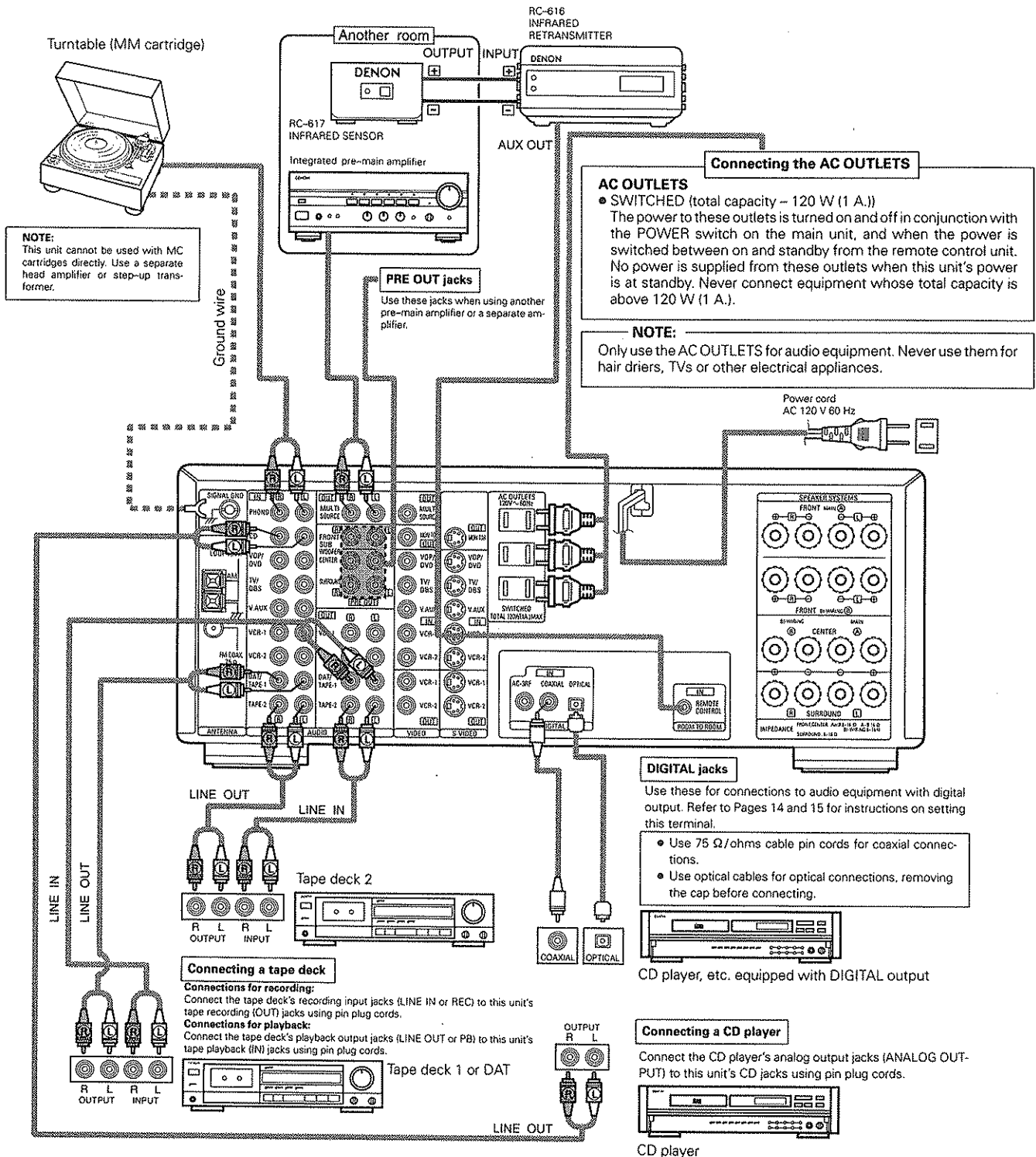

5-2 Connecting the video equipments

To connect the video signal, connect using a 75 Ω/ohms video signal cable cord. Using an improper cable can result in a drop in sound quality.

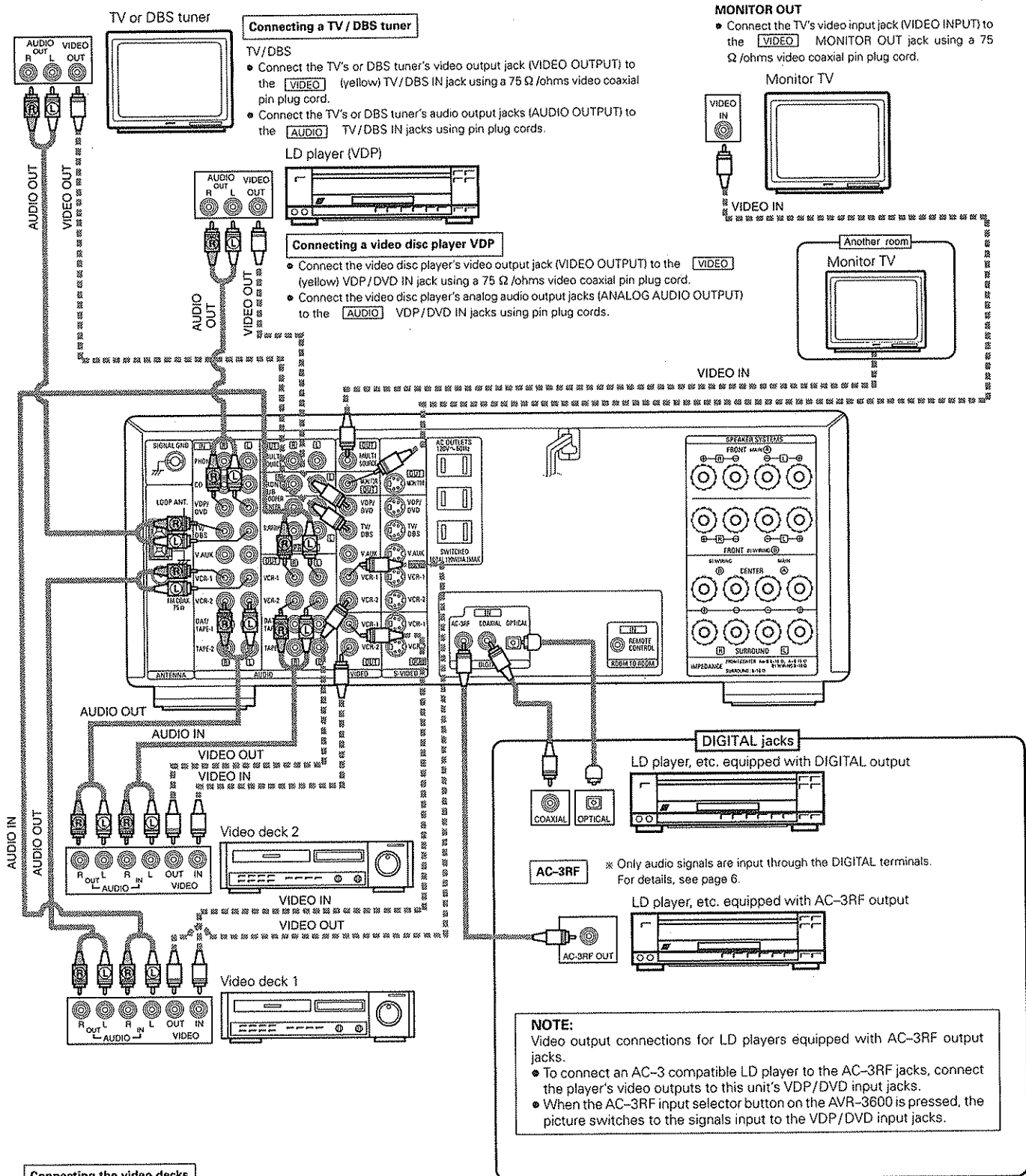

5-3 Connecting the S-video terminals

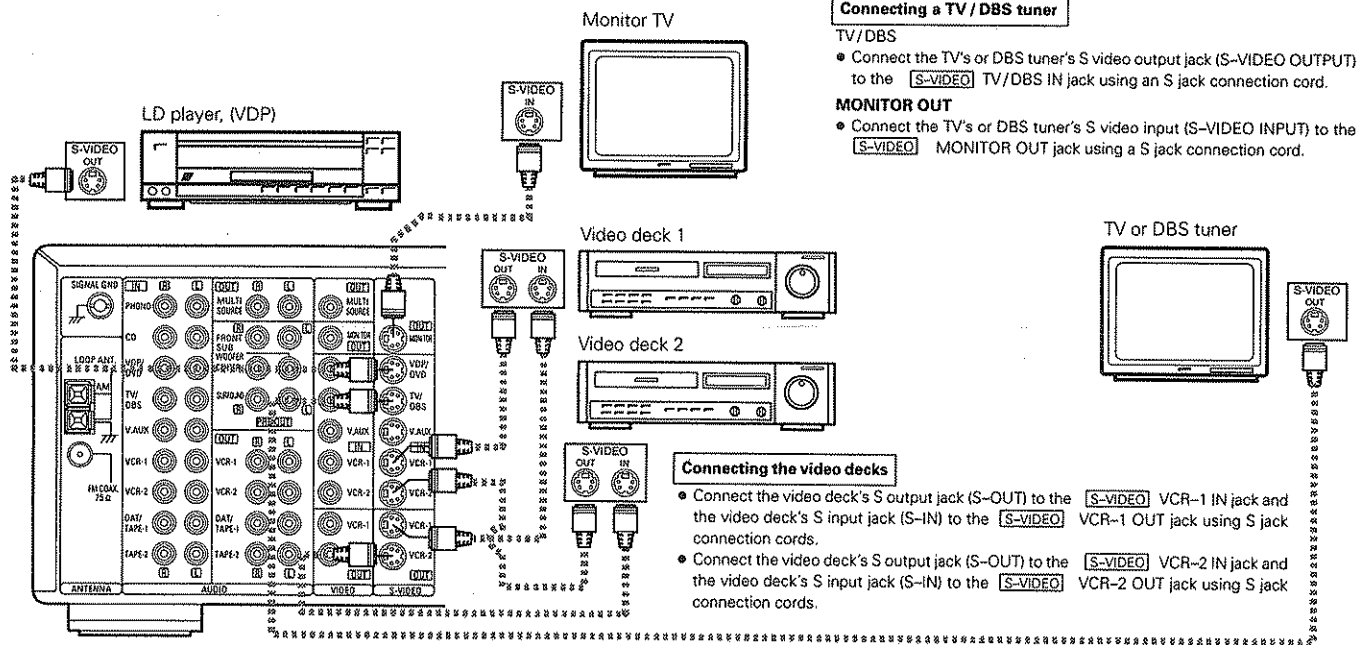

● **A note on the S input jacks**

The input selectors for the S inputs and pin jack inputs work in conjunction with each other.

● **Precaution when using S-jacks**

This unit's S-jacks (input and output) and video pin jacks (input and output) have independent circuit structures, so that video signals input from the S-jacks are only output from the S-jack outputs and video signals input from the pin jacks are only output from the pin jack outputs. When connecting this unit with equipment that is equipped with S-jacks, keep the above point in mind and make connections according to the equipment's instruction manuals.

5-4 Connecting the antenna terminals

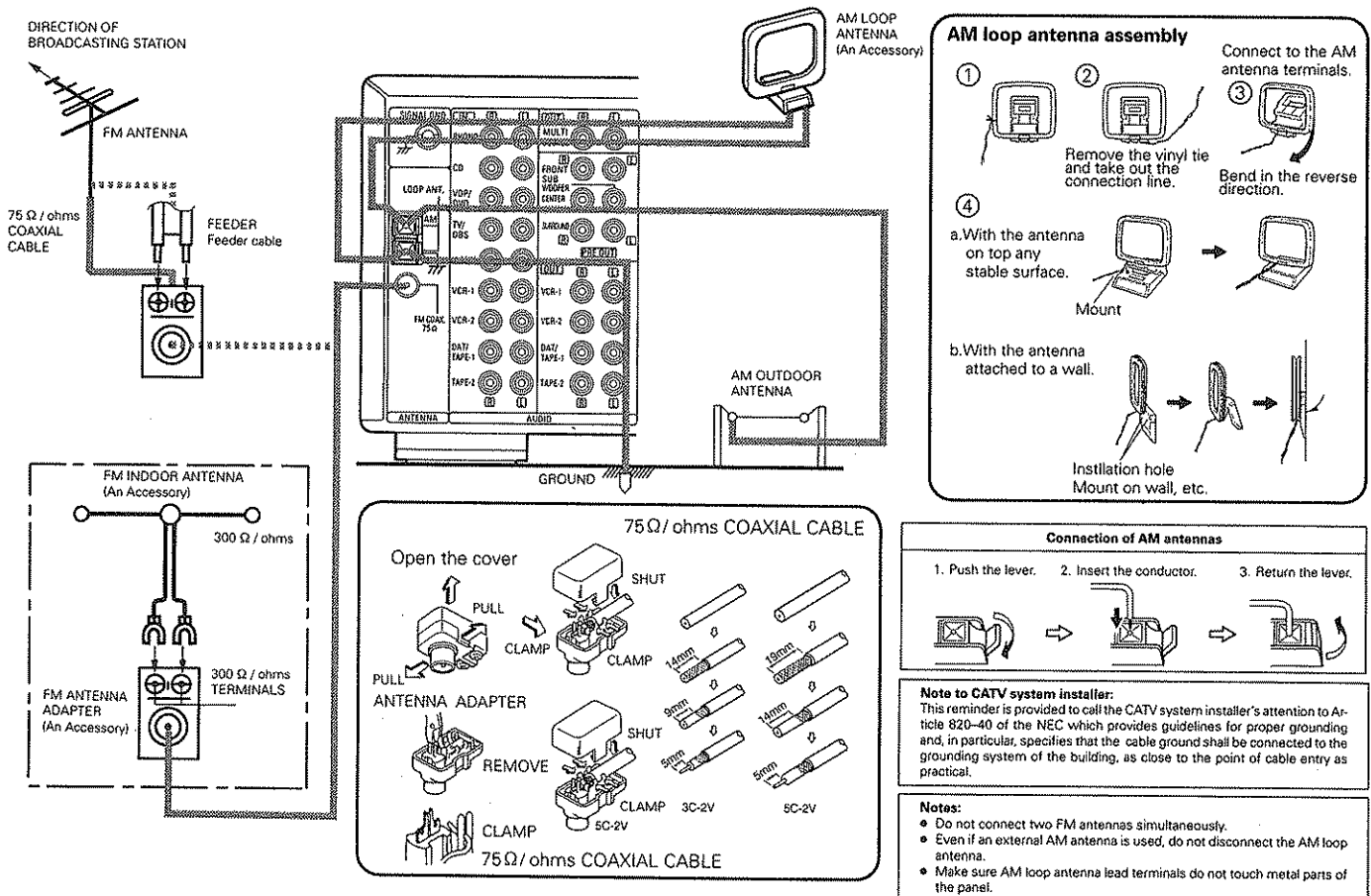

5-5 Speaker system connections

- Connect the speaker terminals with the speakers making sure that like polarities are matched (⊕ with ⊕, ⊖ with ⊖). Mismatching of polarities will result in weak central sound, unclear orientation of the various instruments, and the sense of direction of the stereo being impaired.
- When making connections, take care that none of the individual conductors of the speaker cord come in contact with adjacent terminals, with other speaker cord conductors, or with the rear panel.

Speaker Impedance

- When speaker systems A and B are used separately, speakers with an impedance of from 8 to 16 Ω/ohms can be connected for use as front and center speakers.
- Be careful when using two pairs of front or center speakers (A + B) at the same time, since use of speakers with an impedance of less than 16 Ω/ohms will lead to damage.
- Speakers with an impedance of 8 to 16 Ω/ohms can be connected for use as surround speakers.
- The protection circuit may operate or damage may occur when speakers with an impedance outside of the above range are used.

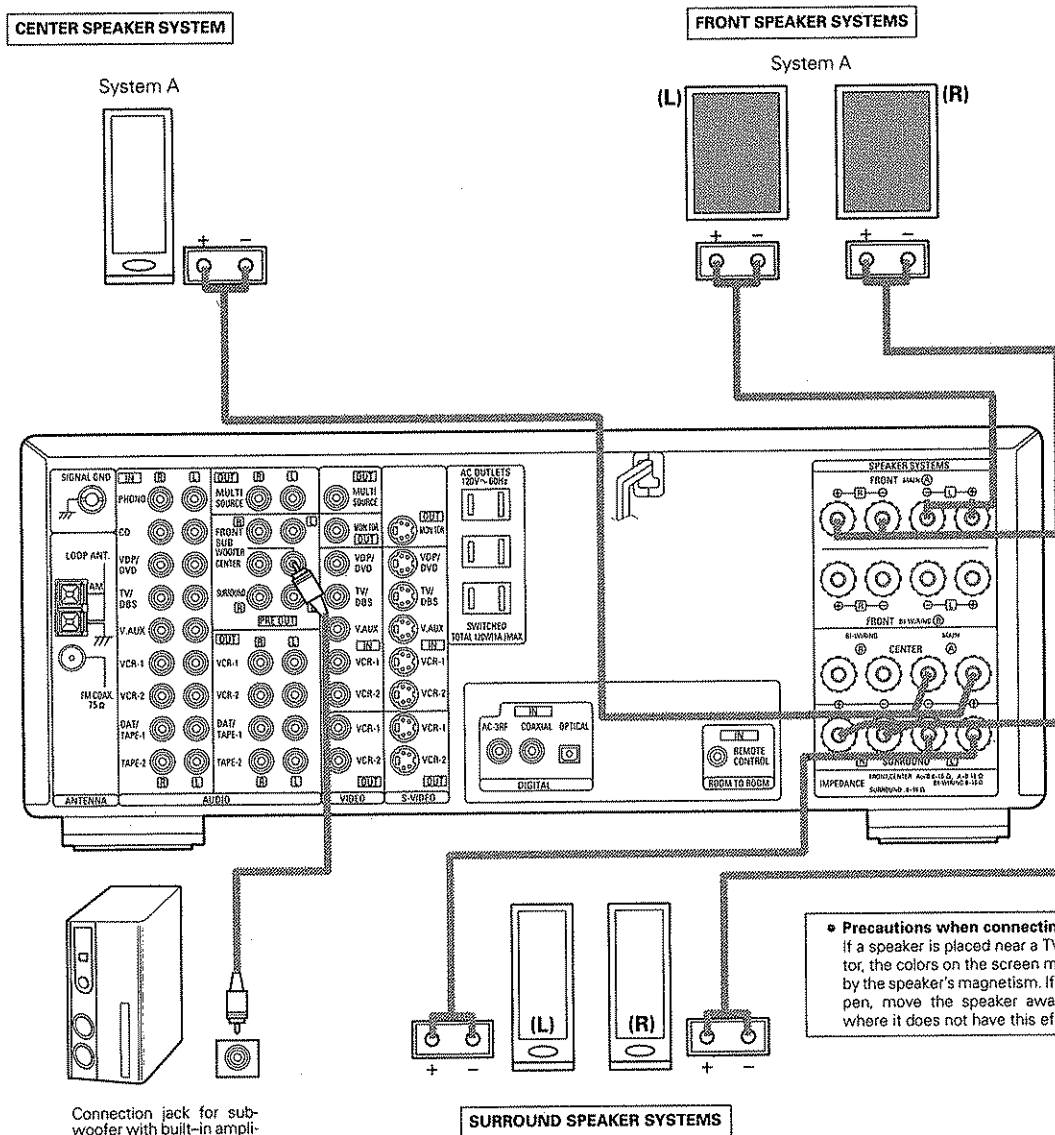
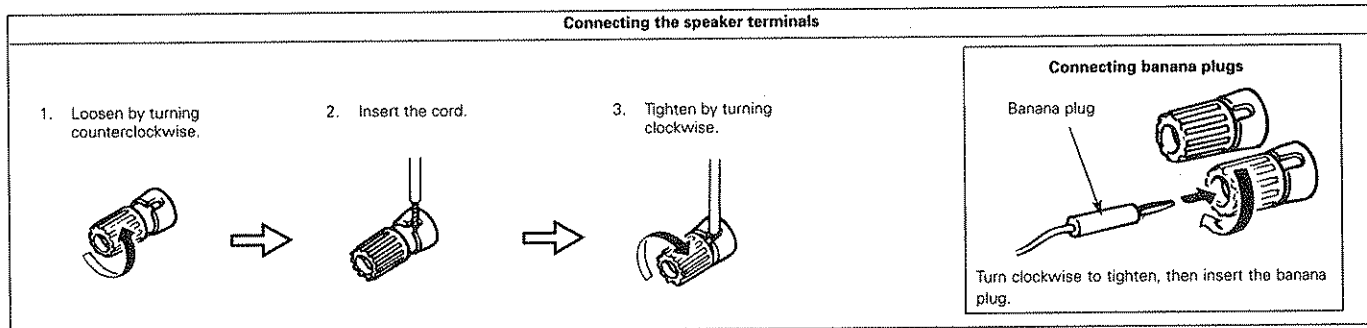

Connection jack for subwoofer with built-in amplifier (super woofer), etc.

- About bi-wiring
If your speakers have bi-wiring terminals, you can achieve higher quality sound by adding cords and using bi-wiring, as shown on the diagram below.
- By connecting speaker systems to both the speaker A and B terminals, you can play the same music source simultaneously in different rooms. (Use speakers with impedances of 16 Ω/ohms.)
- By adding an integrated amplifier, you can use the multi-source terminals to play the other music source simultaneously in different rooms. (See page 26.)

Bi-wiring procedure

CENTER SPEAKER SYSTEM

FRONT SPEAKER SYSTEMS

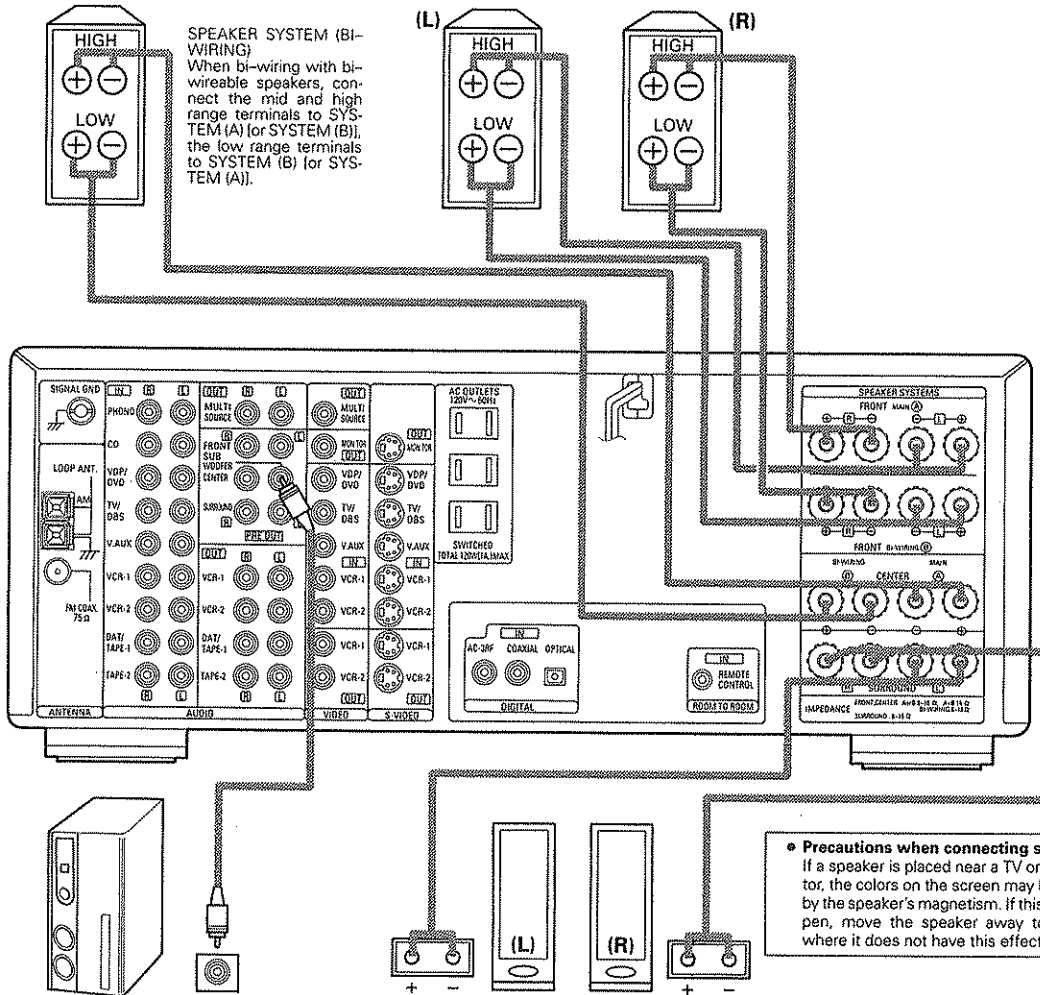

SURROUND SPEAKER SYSTEMS

6 SYSTEM SETUP

After connections with other components have been made, make the various settings on the monitor using this unit's on-screen display. These settings must be made in order to complete the AV system in your listening room.

Make the seven settings described below.

- ① **Speaker Configuration**
- ② **Delay Time**
- ③ **Channel Level**
- ④ **Digital Input** (only when an AV component is connected to the digital input jacks)
- ⑤ **AC-3**
- ⑥ **Auto Tuner Preset**
- ⑦ **On Screen Display**

NOTES:

- The output from the S MONITOR OUT terminal has priority for the on screen display. If you want to always output the on screen display signals to the video output, do not connect a cable to the S MONITOR OUT terminal.
- The on screen display is not displayed for the MULTI SOURCE MONITOR OUT terminal.
- This model's on screen function is designed for high resolution monitor displays. Small characters may be difficult to read on small displays or low resolution TVs.

Use the following buttons on the remote control unit to make the settings:

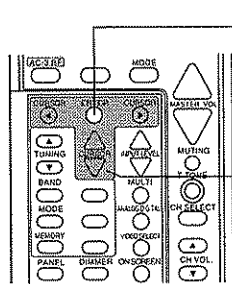

"ENTER" button

Press this to switch the display on the screen. Also use this button to complete the setting on the screen.

"CURSOR" buttons

◀ and ▶ : Use these to move the cursors (◀ and ▶) to the left and right on the screen.
 ▲ and ▼ : Use these to move the cursors (▲ and ▼) up and down on the screen.

6-1 Before setting up the system

1. Turn on the power and press the ENTER button. The "Menu" screen (screen 1) appears on the monitor.



2. Use the CURSOR buttons to specify "System Setup".

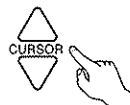

3. Press the ENTER button to switch the screen.



The "System Setup Menu" screen (screen 2) appears on the monitor.

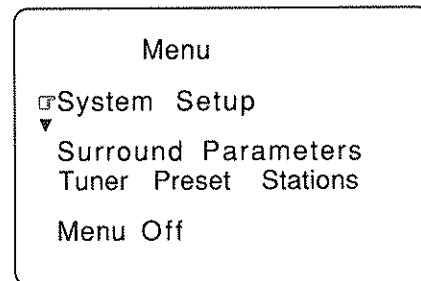

(screen 1)

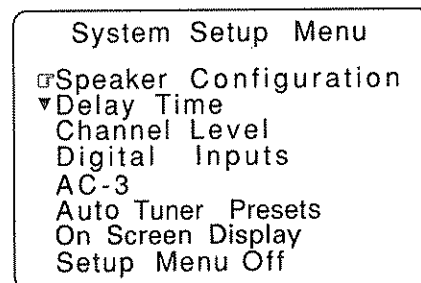

(screen 2)

6-2 Setting the speaker configuration

1. Use the CURSOR buttons to specify "Speaker Configuration" from the "System Setup Menu" screen (screen 2).



2. Press the ENTER button.



The "Speaker Configuration Menu" screen (screen 3) appears on the monitor.

3. Use the CURSOR buttons and select the different types of speakers connected and their size parameters.

To select the speakers:

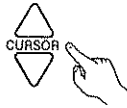

To select the parameters:

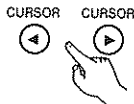

The selected parameters are highlighted.

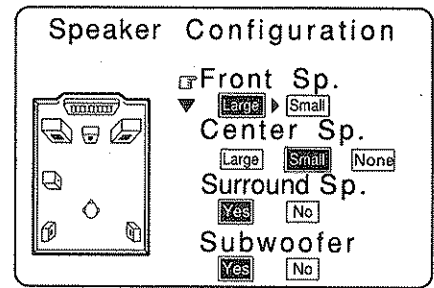

(screen 3)

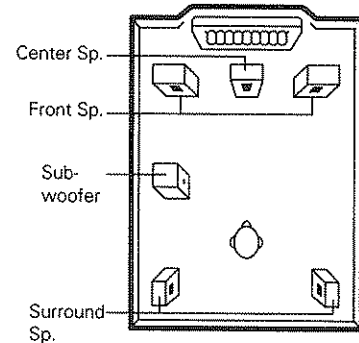

Parameters

- Large Select this when using speakers that can fully reproduce low sounds of below 80 Hz.
- Small Select this when using speakers that cannot reproduce low sounds of below 80 Hz with sufficient volume. When this setting is selected, low frequencies of below 80 Hz are assigned to the subwoofer.
- None Select this when no speakers are installed.
- Yes/No Select "Yes" when surround speakers and a subwoofer are installed, "No" when they are not installed.

4. After the above selections are completed, press the ENTER button again. The "System Setup Menu" screen reappears.

6-3 Setting the delay time

Input the listening position and the distance of the different speakers.

1. Use the CURSOR buttons to specify "Delay Time" from the "System Setup Menu" screen (screen 4).

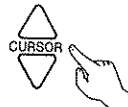

2. Press the ENTER button.



The "Delay Time" screen (screen 5) appears on the monitor.

3. Use the CURSOR buttons to specify the unit of distance.

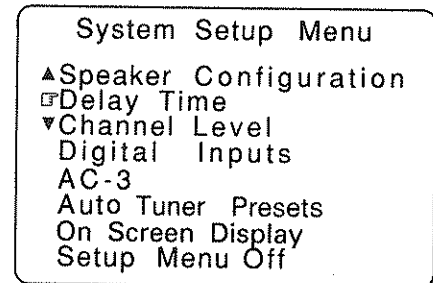
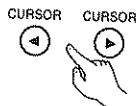

(screen 4)

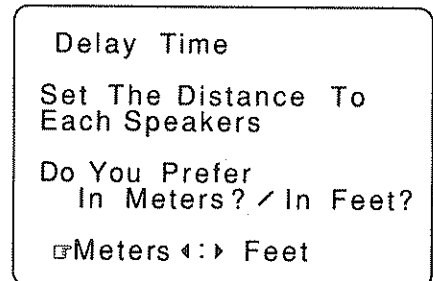

(screen 5)

NOTE: The settings are reset to their initial values when switching between meters and feet.

4. Use the CURSOR buttons to input the listening position and the distance of the different speakers. (screen 6-A)

To select the speakers:



To select the distance:

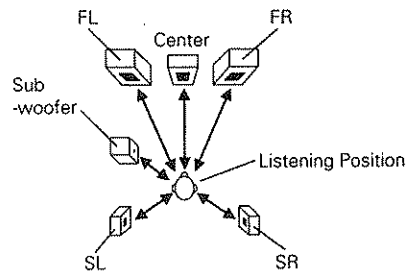
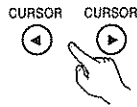

※ Select "Default" to return to the initial settings.

5. After the above selections are completed, press the ENTER button again. The "System Setup Menu" screen reappears. This procedure automatically sets the optimum surround delay time for the listening room.

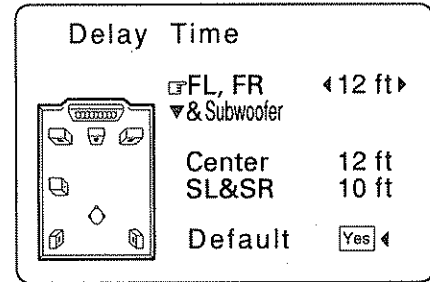

(screen 6-A)

※ If you set an invalid distance, a CAUTION notice, such as screen 6-B will appear. In this case, please relocate the blinking speaker(s) so that its distance is no larger than the value shown in highlighted line. Then press the ENTER button again.

※ Set in such a way that the distance to the center speaker is the same as or up to 5 feet (1.5 meters) shorter than the distance to the front left and front right speakers and the subwoofer.

※ Set in such a way that the distance to the surround left and right speakers is the same as or up to 15 feet (4.5 meters) shorter than the distance to the front left and front right speakers and the subwoofer.

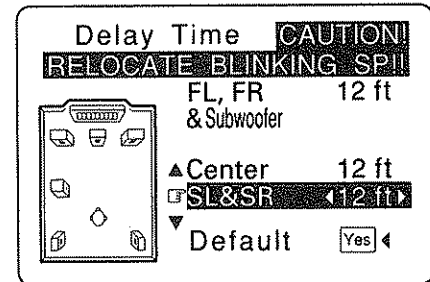

(screen 6-B)

6-4 Setting the channel level

Use test tones to adjust the volume of the different speakers.

1. Use the CURSOR buttons to specify "Channel Level" from the "System Setup Menu" screen. (screen 7)

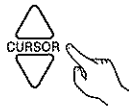

2. Press the ENTER button.



The "Channel Level" screen (screen 8) appears on the monitor.

3. Use the CURSOR buttons to select "Test Tone Mode", then select "Auto" or "Manual".

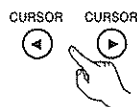

4. Use the CURSOR buttons to select "Test Tone Start", then select "Yes".

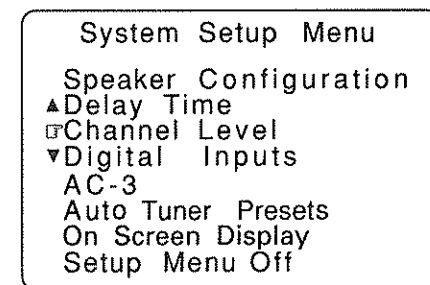
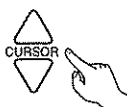

(screen 7)

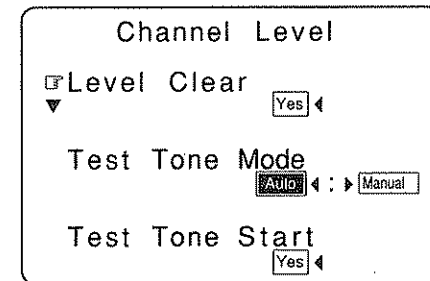

(screen 8)

5. a. If the "Auto" mode is selected:
 Test tones are automatically emitted from the different speakers.
 The test tones are emitted from the different speakers in the following order, at 4-second intervals the first time and second time around, 2-second intervals the third time around and on:



Use the CURSOR buttons to adjust all the speakers to the same volume. (screen 9)

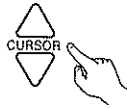

- b. If the "Manual" mode is selected:
 Use the cursor buttons to select the speakers from which to emit the test tones and adjust the volume. (screen 10)

To adjust the volume:



To select the speaker:

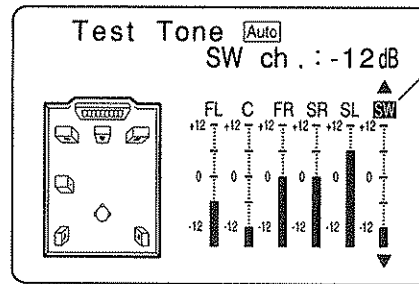
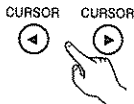

(screen 9)

The test tone is emitted from the speaker whose indicator is highlighted.

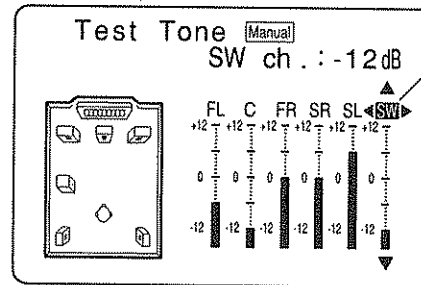

(screen 10)

The test tone is emitted from the speaker whose indicator is highlighted.

The level of each channel should be adjusted to 75 dB (C-weighted, slow meter mode) on a sound level meter at the listening position. If a sound level meter is not available adjust the channels by ear so the sound levels are the same. Because adjusting the subwoofer level test tone by ear is difficult, use a well known music selection and adjust for natural balance.

NOTE: When adjusting the level of an active subwoofer system, you may also need to adjust the subwoofer's own volume control.

6. After the above settings are completed, press the ENTER button again.
 The "System Setup Menu" screen (screen 2) reappears.

To cancel the settings, select "Level Clear" and "Yes" on the "Channel Level" screen, then make the settings again.

- NOTES:**
- The output channel levels for all the surround modes are set to the same conditions when the channel level setting on the system setup menu is conducted.
 - When the level clear operation is performed, all channel levels for all modes are set to 0 dB.

6-5 Digital input setup

Input the types of components connected to the digital input terminals.

1. Use the CURSOR buttons to specify "Digital Inputs" from the "System Setup Menu" screen. (screen 11)

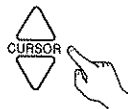

2. Press the ENTER button.

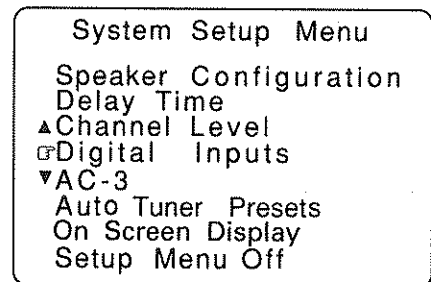

(screen 11)

The "Digital Input Setup" screen appears. (screen 12)

3. Use the cursor buttons to input the types of components connected to the digital input terminals.

To select the input terminal:

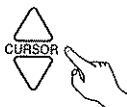

To select the type of component:

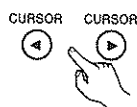

※ Select "OFF" if nothing is connected.

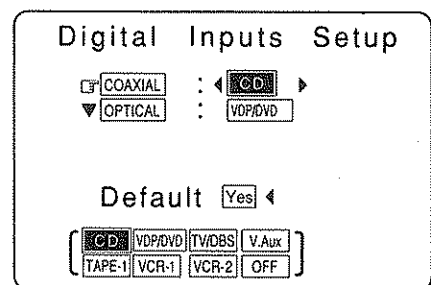

(screen 12)

Select "Default" to return to the initial settings.
The initial settings are set as shown on Table 6-5.

COAXIAL	CD
OPTICAL	VDP/DVD

Table 6-5 Initial Settings

- After the above settings are completed, press the ENTER button.
The "System Setup Menu" screen reappears.

6-6 Dolby Digital AC-3

When playing Dolby Digital AC-3 sources, the input level is corrected automatically.
Set the dialog normalization function.

- Use the CURSOR buttons to specify "AC-3" from the "System Setup Menu" screen.
(Screen 13)

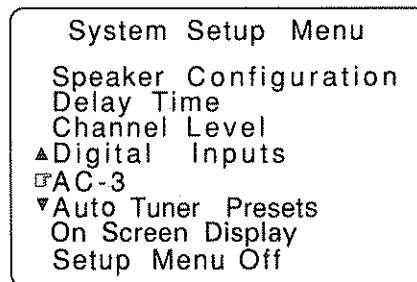
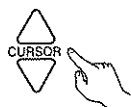

(screen 13)

- Press the ENTER button.



The "AC-3" screen appears. (Screen 14)

- Use the CURSOR buttons to select "ON" or "OFF".

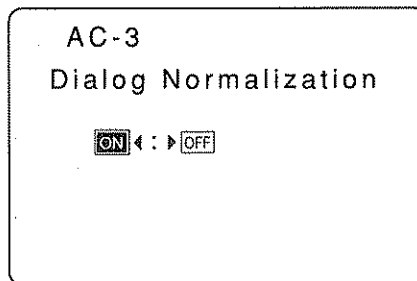
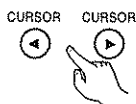

(screen 14)

When playing Dolby Digital AC-3 sources

NOTE: If dialog normalization is set to "OFF", it may not be possible to set the master volume to greater than -5 dB, depending on the number of speakers and the output channel level setting.

6-7 Auto tuner presets

Use this to automatically search for FM broadcasts and store up to 40 stations at preset channels A1 to 8, B1 to 8, C1 to 8, D1 to 8 and E1 to 8.

NOTE:

If an FM station cannot be preset automatically due to poor reception, use the "Manual tuning" operation to tune in the station, then preset it using the manual "Preset memory" operation.

1. Use the CURSOR buttons to specify "Auto Tuner Preset" from the "System Setup Menu" screen. (screen 15)

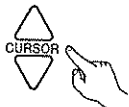

2. Press the ENTER button.



The "Auto Preset Memory" screen appears. (screen 16)

3. Use the CURSOR buttons to select "Yes".

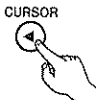

"Search" flashes on the screen and searching begins.
"Complete" appears once searching is completed.
The display automatically switches to screen 17.

4. Check the broadcast stations stored in the memory.
Press the ENTER button. (screen 17)



The monitor switches to the "Menu" screen. (screen 18)

5. Use the CURSOR buttons to specify "Tuner Preset Stations".

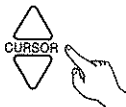

6. Press the ENTER button.

The display switches to screen 19 and the frequency of the preset station is displayed.
When the CURSOR button is pressed, the displayed page changes and the frequencies of other preset stations can be checked.

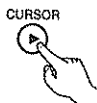

After checking, press the ENTER button again.

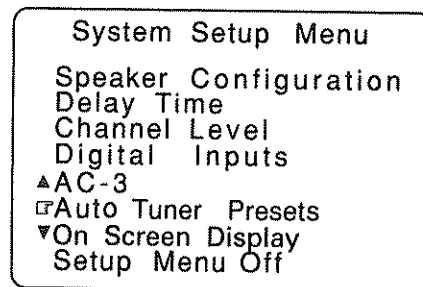

(screen 15)

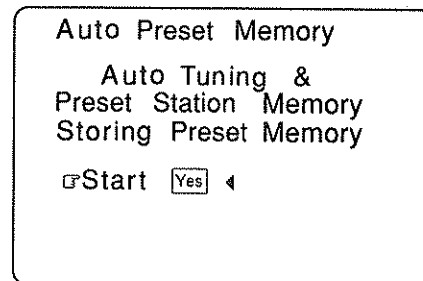

(screen 16)

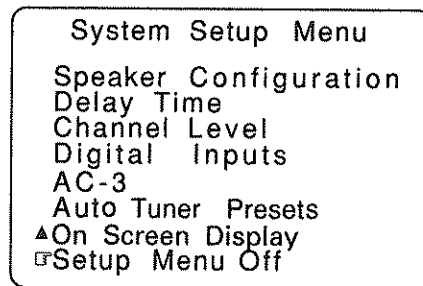

(screen 17)

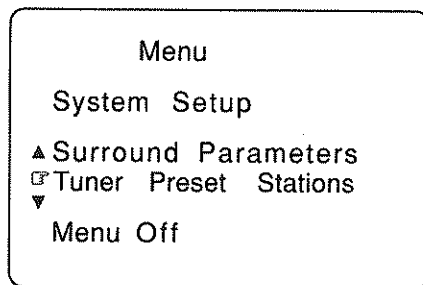

(screen 18)

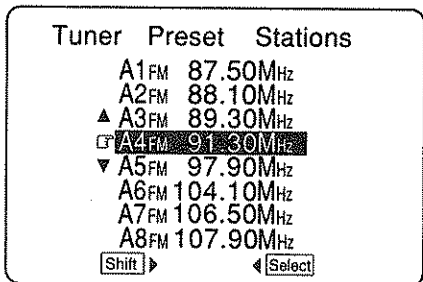

(screen 19)

6-8 On Screen Display

"ON" or "OFF" can be selected for functions other than the ones on the menu screen.

1. Use the CURSOR buttons to specify "On Screen Display" from the "System Setup Menu" screen. (screen 20)



2. Press the ENTER button.



The "On Screen Display" screen (screen 21) appears on the monitor.

3. Use the CURSOR buttons to select "ON" or "OFF".

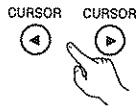

※ This completes the system setup operations. Once the system is set up, there is no need to make the settings again unless other components or speakers are connected or the speaker layout is changed.

6-9 Operation after completing system setup

1. Use the CURSOR buttons to specify "Setup Menu Off" from the "System Setup Menu" screen. (screen 22)

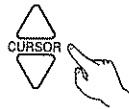

2. Press the enter button twice to turn off the on screen display.

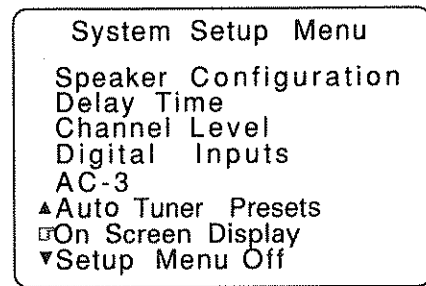

(screen 20)

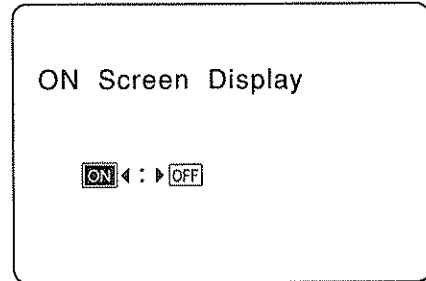

(screen 21)

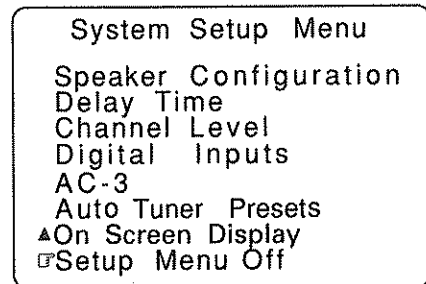

(screen 22)

● SYSTEM SETUP DEFAULT VALUE

① SPEAKER CONFIGURATION	FRONT L & Rch.		CENTER ch.	SURROUND L & Rch.		SUB WOOFER
	SMALL		SMALL	YES		YES
② DELAY TIME	FRONT L & Rch.		CENTER ch.	SURROUND L & Rch.		SUB WOOFER
	12 ft. (3.6 m)		12 ft. (3.6 m)	10 ft. (3.0 m)		12 ft. (3.6 m)
③ CHANNEL LEVEL	FRONT Lch.	FRONT Rch.	CENTER ch.	SURROUND Lch.	SURROUND Rch.	SUB WOOFER
	0 dB	0 dB	0 dB	0 dB	0 dB	0 dB
④ DIGITAL INPUTS	COAXIAL: CD			OPTICAL: VDP/DVD		
⑤ AC-3	DIALOG NORMALIZATION: ON					
⑥ AUTO TUNER PRESET						
A1 ~ A8	87.5/89.1/98.1/107.9/90.1/90.1/90.1/90.1 MHz					
B1 ~ B8	520/600/1000/1400/1500/1710 kHz/90.1/90.1 MHz					
C1 ~ C8	90.1 MHz					
D1 ~ D8	90.1 MHz					
E1 ~ E8	90.1 MHz					
⑦ ON SCREEN DISPLY	ON					

Playback with the above setting is possible upon shipment from the factory and after initializing (refer to page 34).

7 REMOTE CONTROL UNIT

Following the procedure outlined below, insert the batteries before using the remote control unit.

Range of operation of the remote control unit

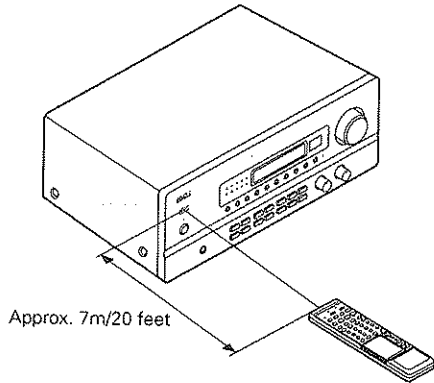

Point the remote control unit at the remote control sensor as shown on the diagram at the left.

NOTES:

- The remote control unit can be used from a straight distance of approximately 7 meters/20 feet, but this distance will shorten or operation will become difficult if there are obstacles between the remote control unit and the remote control sensor, if the remote control sensor is exposed to direct sunlight or other strong light, or if operated from an angle.
- Neon signs or other devices emitting pulse-type noise nearby may result in malfunction, so keep the set as far away from such devices as possible.

Inserting the batteries

1. Open the bottom cover of the remote control unit and remove the battery cover.

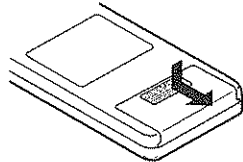

2. Insert the two R6P/AA batteries, matching the ⊕ and ⊖ marks on the batteries with those in the case. Close the bottom cover until it clicks shut.

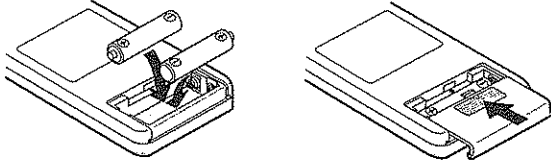

NOTES:

- Use only AA, R6P, UM-3 batteries for replacement.
- Be sure the polarities are correct. (See the illustration inside the battery compartment.)
- Remove the batteries if the remote control transmitter will not be used for an extended period of time.
- If batteries leak, dispose of them immediately. Avoid touching the leaked material or letting it come in contact with clothing, etc. Clean the battery compartment thoroughly before installing new batteries.
- Have replacement batteries on hand so that the old batteries can be replaced as quickly as possible when the time comes.
- The codes that have been learned may be lost if removed batteries are not replaced within about 5 minutes.

7-1 System code buttons

DENON remote-controllable audio components can be controlled using this unit's remote control unit. Note that some components, however, cannot be operated with this remote control unit.

1. Set to slide switch to "AUDIO" ("AVR/AVC").



2. Set the slide switch to the position for the component to be operated (CD, DECK or DAT).

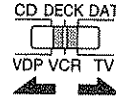

3. Use the buttons shown below to operate the audio component. For details, refer to the respective component's manual.

a. For CD players and DATs

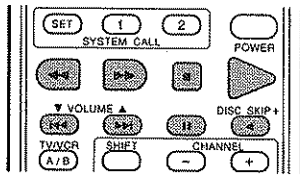

- ◀▶ : Manual search (reverse and forward)
- : Stop
- ▶ : Play
- ◀▶▶ : Auto search
- ⏸ : Pause
- DISC : Disc selection
- SKIP+ : (CD changer only)

b. For tape decks (DECK)

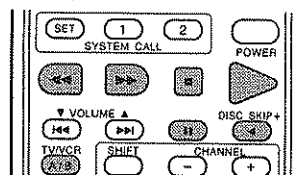

- ◀ : Reverse
- ▶ : Forward
- : Stop
- ▶▶ : Forward play
- ⏸ : Pause
- A/B : A/B deck selection
- ◀ : Reverse play

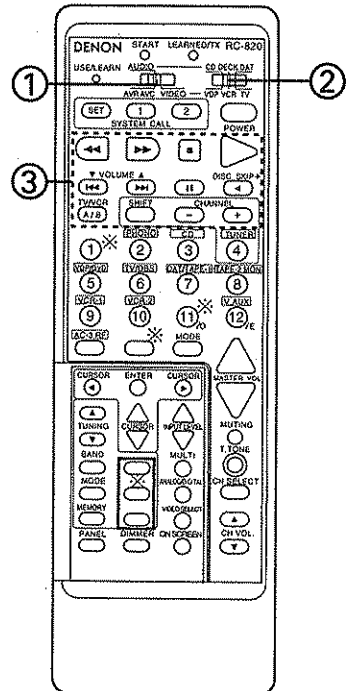

※ These buttons does not function. (Some buttons can be used by using the pre-set memory or the learning function.)

7-2 Preset memory

DENON and other makes of components can be operated by setting the preset memory for your make of video component. **Operation is not possible for some models, however. In this case use the learning function (see page 21) to store the remote control signals.**

For instructions on clearing the presettings stored in the preset memory, see page 22.

1. Set the slide switch to "VIDEO".

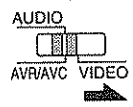

2. Set the slide switch to the component to be registered (VDP, VCR or TV).

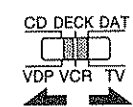

(Keep the POWER button pressed in when performing steps 3 and 4.)

3. Holding in the POWER button, press the button for the corresponding manufacturer in block A.
(Refer to Table 7-2.)

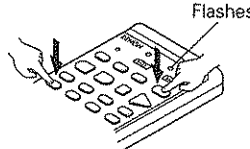

The LEARNED/TX LED flashes.

4. Next, while holding in the POWER button, press the button for the code in block B. (Refer to Table 7-2.) The operation is completed when the LEARNED/TX LED lights.

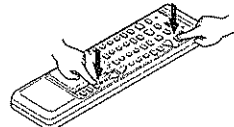

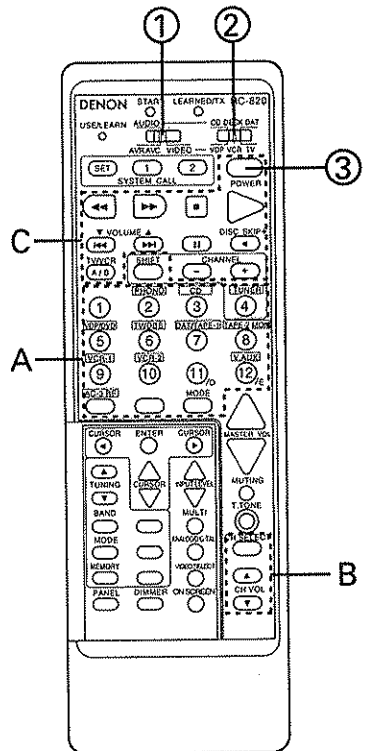

5. To continue registering other components, repeat steps 2 to 4.





This remote control unit can be used to operate components of other manufacturers without using the learning function by registering the manufacturer of the component as shown on Table 7-2.

Table 7-2: Combinations of Personal System Codes for Different Manufacturers

"VDP"

A \ B	CH SELECT (CH SELECT)	CH VOL. (CH VOL.)	CH VOL. (CH VOL.)
①	DENON A	DENON B	DENON C
② (PHONO)	—	—	—
③ (CD)	MITSUBISHI	—	—
④ (TUNER)	PANASONIC	—	—
⑤ (VDP/DVD)	—	—	—
⑥ (TV/DBS)	SONY A	SONY B	SONY C
⑦ (DAT/TAPE-1)	PIONEER	—	—
⑧ (TAPE-2/MON)	—	—	—
⑨ (VCR-1)	SANYO	—	—
⑩ (VCR-2)	SHARP	—	—
⑪	—	—	—
⑫ (V.AUX)	PHILIPS	—	—
 (AC-3RF)	RCA	—	—
	—	—	—
 (MODE)	MAGNAVOX	—	—

"VCR"

A \ B	CH SELECT (CH SELECT)	CH VOL. (CH VOL.)	CH VOL. (CH VOL.)
①	—	—	—
② (PHONO)	HITACHI A	HITACHI B	HITACHI C
③ (CD)	MITSUBISHI A	MITSUBISHI B	MITSUBISHI C
④ (TUNER)	PANASONIC A	PANASONIC B	—
⑤ (VDP/DVD)	JVC (VICTOR)A	JVC (VICTOR)B	—
⑥ (TV/DBS)	SONY A	SONY B	SONY C
⑦ (DAT/TAPE-1)	PIONEER	—	—
⑧ (TAPE-2/MON)	TOSHIBA A	TOSHIBA B	—
⑨ (VCR-1)	SANYO A	SANYO B	—
⑩ (VCR-2)	SHARP A	SHARP B	—
⑪	NEC A	NEC B	NEC C
⑫ (V.AUX)	PHILIPS A	PHILIPS B	PHILIPS C
 (AC-3RF)	RCA A	RCA B	—
	GENERAL ELECTRIC A	GENERAL ELECTRIC B	—
 (MODE)	MAGNAVOX A	MAGNAVOX B	MAGNAVOX C

"TV"

A \ B	CH SELECT (CH SELECT)	CH VOL. (CH VOL.)	CH VOL. (CH VOL.)
①	DENON	—	—
② (PHONO)	HITACHI A	HITACHI B	—
③ (CD)	MITSUBISHI A	MITSUBISHI B	MITSUBISHI C
④ (TUNER)	PANASONIC	—	—
⑤ (VDP/DVD)	JVC (VICTOR)	—	—
⑥ (TV/DBS)	SONY A	—	—
⑦ (DAT/TAPE-1)	PIONEER	—	—
⑧ (TAPE-2/MON)	TOSHIBA	—	—
⑨ (VCR-1)	SANYO A	SANYO B	—
⑩ (VCR-2)	SHARP	—	—
⑪	NEC A	NEC B	NEC C
⑫ (V.AUX)	PHILIPS A	PHILIPS B	PHILIPS C
AC-3RF (AC-3RF)	RCA A	RCA B	—
	GENERAL ELECTRIC A	GENERAL ELECTRIC B	—
MODE (MODE)	MAGNAVOX A	MAGNAVOX B	MAGNAVOX C

NOTES:

- The signals for the pressed buttons are emitted while setting the preset memory. To avoid accidental operation, cover the remote control unit's transmitting window while setting the preset memory.
- Some models and years of manufacture of components of the manufacturers listed on Table 7-2 cannot be used.

7-3 Operation after components are registered

1. Set the slide switch to "VIDEO".

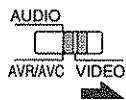

2. Set the slide switch to the component to be registered (VDP, VCR or TV).

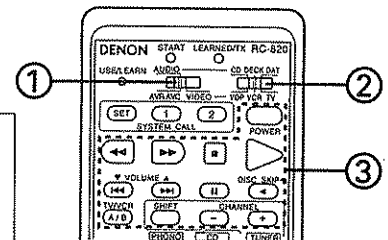

3. Use the buttons shown below to operate the video component. (Some models cannot be used.)
For details, refer to the respective component's manual.

a. VDP

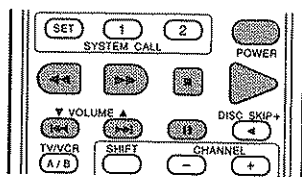

- POWER : Power on/off
 ◀▶ : Manual search (reverse and forward)
 ■ : Stop
 ▶ : Play
 ◀▶▶▶ : Auto search
 || : Pause

b. VCR

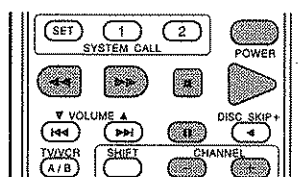

- POWER : Power on/off
 ◀▶ : Manual search (reverse and forward)
 ■ : Stop
 ▶ : Play
 || : Pause
 CHANNEL : Channel selection
 +, -

c. TV

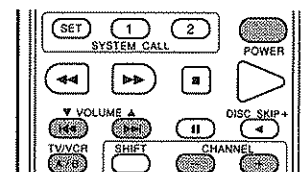

- POWER : Power on/off
 VOLUME : Volume up/down
 ▲, ▼ : Volume up/down
 TV/VCR : TV/video selection
 CHANNEL : Channel selection
 +, -

7-4 Remote control unit learning function

If your AV components are not Denon products or if operation is not possible with the preset memory settings, the components' remote control signals can be "learned" to enable remote control operation. The buttons that can be "learned" are the CD, DAT and DECK system buttons (see page 18) and the VDP, VCR and TV system buttons (see page 20). (For the TV only, the A block buttons can also be "learned".)

1. Press the USE/LEARN selector button with the tip of a pen etc., to set the learn mode. Both the START and LEARNED/TX indicators flash.

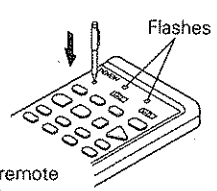

This unit's remote control unit

2. Set the program switch to the side to be "learned". Set to the AUDIO side for the CD, tape deck or DAT position, to the VIDEO side for the VDP, VCR or TV position.

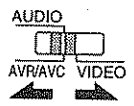

3. Set the program switch to the position to be "learned".

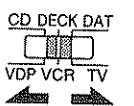

4. Set the remote control units so they are facing each other, then press the button to be "learned" on this unit's remote control unit.

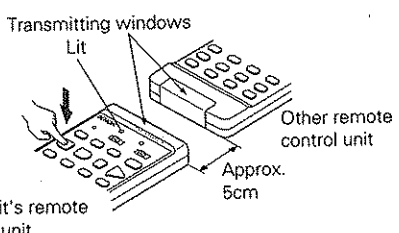

This unit's remote control unit

Other remote control unit

Approx. 5cm

The indicator stops flashing and the START LED lights. The learnable buttons are the buttons which can be operated with the DENON system codes for the CD player, DAT and tape deck, the buttons which can be operated with the preset memory for the VCR, VDP and TV. For the TV only, however, the buttons in the section indicated "A" on the diagram above can also be "learned". Use these to "learn" TV channels.

NOTE:

- Use button ⑪ / 0 as the 0 number button, button ⑫ / E as the enter button.

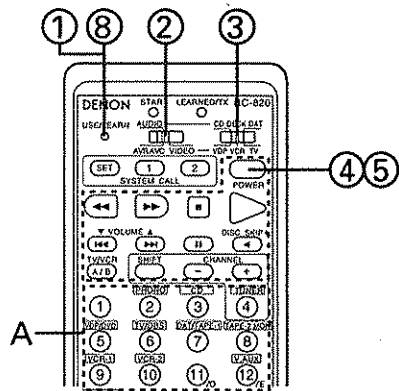

5. Check that the START LED is lit, then press the button to be "learned" on the other remote control unit.

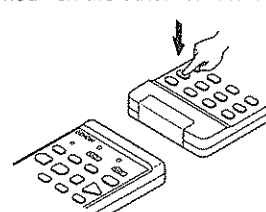

6. Once the START LED turns off and the LEARNED/TX LED lights, release the button on the other remote control unit.

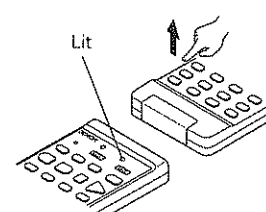

The two LEDs start flashing again.

7. To "learn" other buttons, repeat steps 2 to 6.

8. Once the learning operation is completed, press the USE/LEARN selector button again. The two LEDs stop flashing and the learning mode is cancelled.

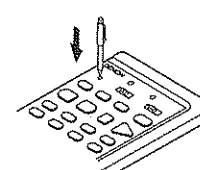





Check that the stored codes work properly.

NOTES:

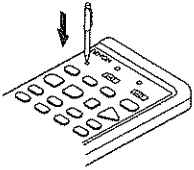
- Up to 26 codes can be "learned", but this number may be lower if the codes are long.
- If a non-learnable button is pressed or two or more buttons are pressed at once, the two LEDs will once again light when the button(s) is released.
- If the codes could not be stored, the LEARNED/TX LED does not light after the START LED turns off. For limited number of models, codes cannot be stored in RC-820.
- If the two LEDs start flashing rapidly after the START LED lights, this means that the memory is already full, and the code you have just attempted to store was not stored. To "learn" that code, first perform the resetting operation.

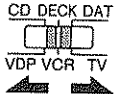
7-5 Clearing "learned" remote control signals and the preset memory settings

1. Press the USE/LEARN selector button with the tip of a pen, etc., to set the learn mode.
 
2. To clear "learned" remote control signals, set the slide switch to the position at which the signals were "learned". To clear the preset memory settings, set the slide switch to "VIDEO".
 
3. Set the slide switch to the position at which the signals were "learned" or at which the preset memory settings were set.
 

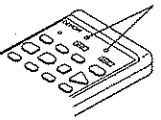
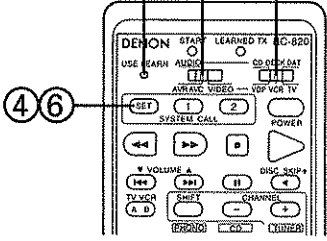
4. Press the SYSTEM CALL SET button, and hold it in for at least four seconds.
 
5. When both the START and LEARNED / TX LEDs light simultaneously, all the stored codes are cleared.
 
6. Press the USE/LEARN selector button.
 

8 OPERATIONS

8-1 Preparations for playback

1. Check that all connections are proper.
2. Set to the center position.

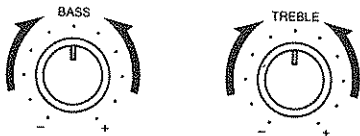

3. Set the remote control unit's slide switch to the AUDIO position. (only when operating with the remote control unit)



4. Turn on the power.
Press the POWER switch (button).

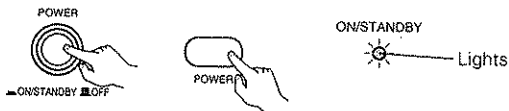

- **ON/STANDBY**

The power turns on and "ON/STANDBY" indicator is lit. Several seconds are required from the time the power switch is set to the "ON" position until sound is output. This is due to the built-in muting circuit that prevents noise when the power switch is turned on and off. Set the POWER switch to this position to turn the power on and off from the included remote control unit (RC-820).

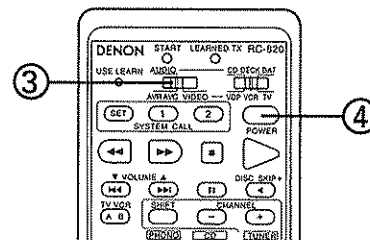
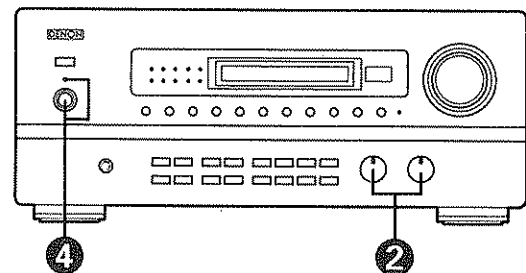

- **OFF**

The power turns off and "ON/STANDBY" indicator is off. In this position, the power cannot be turned on and off from the remote control unit.

8-2 Playing the analog program source (Stereo playback)

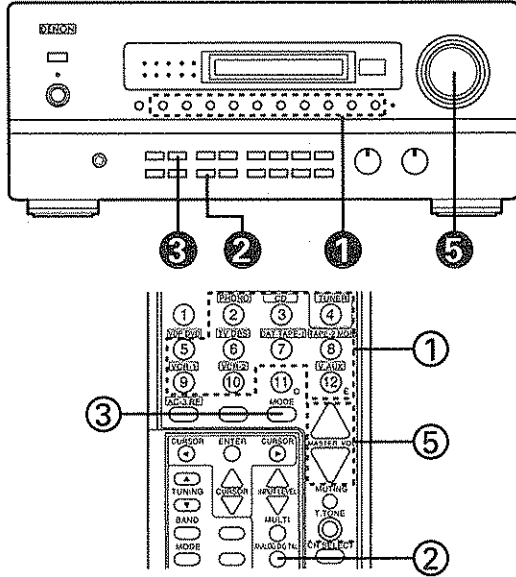

1. Press the button for the program source to be played.



2. Select the ANALOG INPUT.

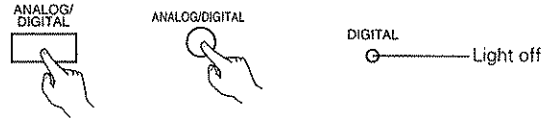

Check that the "DIGITAL" indicator is off. If it is lit, press the button to switch the mode.

3. Select the STEREO mode.

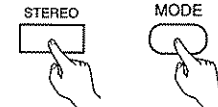

4. Start playback on the selected component.
For operating instructions, refer to the various components' manuals.

5. Adjust the MASTER VOLUME control.

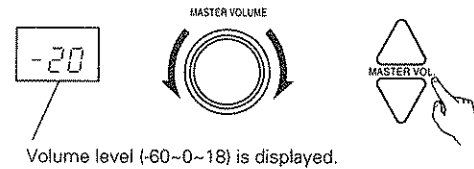

8-3 Playing the digital program source

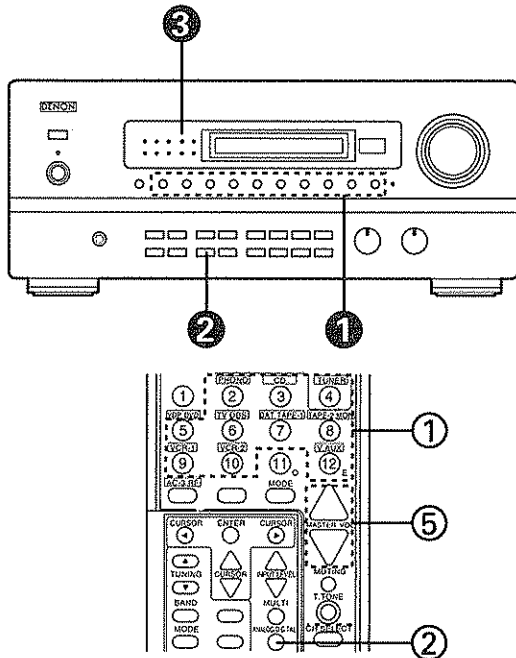

1. Press the button for the program source to be played that is connected to the digital input jacks.

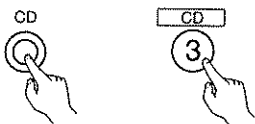

2. Select the digital input.

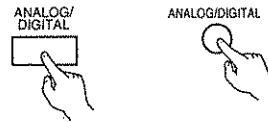

3. Check that the "DIGITAL" indicator is lit red.

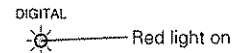

When digital signals are input properly, the DIGITAL indicator switches from red to green.

- ※ If the indicator is not lit green, check that the system setup's input setting (refer to page 14, 15) and the connections are proper, that the component's power is turned on, etc.

4. Start playback on the selected component.
For operating instructions, refer to the various components' manuals.

5. Adjust the MASTER VOLUME control.

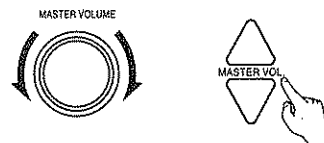

NOTE: If a CD-ROM is played, the "DIGITAL" indicator is lit green but no sound is heard.

8-4 Adjusting the TONE control

1. Adjust the BASS and TREBLE.

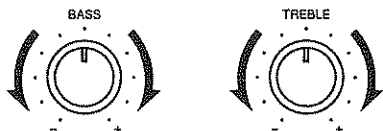

Turn the control clockwise to increase the bass or treble, counter-clockwise to decrease it.

2. Press the direct button if there is no need to adjust the sound.

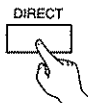

8-5 Simulcast playback

Use this switch to monitor a video source other than the audio source.

1. Press the VIDEO SELECT button repeatedly until the desired source appears on the display.

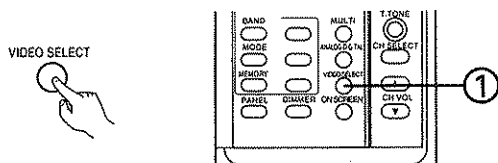

- ※ Cancelling simulcast playback.
- Select "SOURCE" using the video select button.
- Switch the program source to the component connected to the video or AC-3RF input.

8-7 Listen with headphones

Connect the headphones to the PHONES jack. The pre-out output is automatically turned off when headphones are connected.

8-8 On screen display

Each time an operation is performed, a description of that operation appears on the display connected to the unit's VIDEO MONITOR OUT terminal. Also, the unit's operating status can be checked during playback by pressing the remote control unit's ON SCREEN button.



Such information as the position of the input selector and the surround parameter settings is output in sequence.

8-9 Front panel display

Descriptions of the unit's operations are also displayed on the front panel display. In addition, the display can be switched to check the unit's operating status while playing a source by pressing the PANEL button.



8-10 Using the dimmer function.

Use this to change the brightness of the display. The display brightness changes in four steps (bright, medium, dim and off) by pressing the remote control unit's DIMMER button repeatedly.

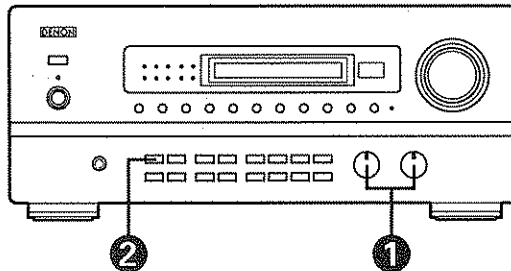

8-6 Using the muting function

Use this to turn off the audio output temporarily.

1. Press the MUTING button.
- ※ Cancelling MUTING mode. Press the MUTING button again.

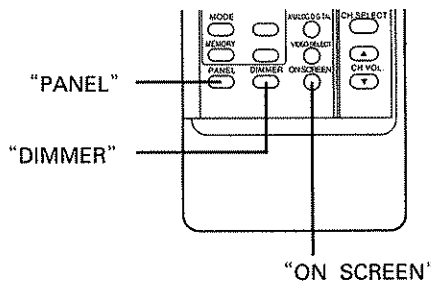
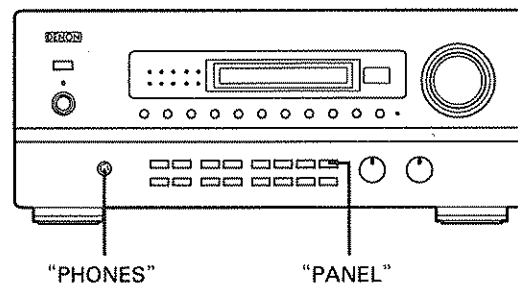
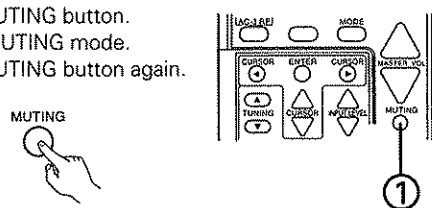

8-11 Multi-source REC OUT recording / playback

While listening to or watching the currently playing program source, you can record another program source (REC OUT mode), or by connecting the input jacks of an amplifier, etc., located away from the AVR-3600 (for example in another room) to the MULTI SOURCE output jacks, you can output the program source to the other location (room) (MULTI mode).

■ Recording a source other than the one currently playing (REC OUT mode)

1. Press the REC/MULTI MODE button until "REC OUT SOURCE" appears on the display.

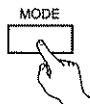

2. Select the source to be output to the recording output terminal. Press the REC/MULTI SOURCE button repeatedly until the desired source appears on the display.

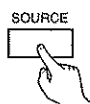

The indicator of the selected program source lights on the display at this time.

3. Set to the audio or video recording mode. For operating instructions, refer to the manuals of the components to be used for audio or video recording.

- ※ REC OUT select is not possible for TAPE-2 monitor REC OUT.
- ※ The signals of the source expect the digital input selected with the REC OUT mode are also output from the MULTI SOURCE AUDIO/VIDEO OUT terminals.
- ※ Digital input signals cannot be recorded. To record, connect to the analog input terminals.
- ※ To cancel the REC OUT mode. Press the REC/MULTI MODE button or the REC/MULTI SOURCE button repeatedly until "SOURCE" appears on the display.

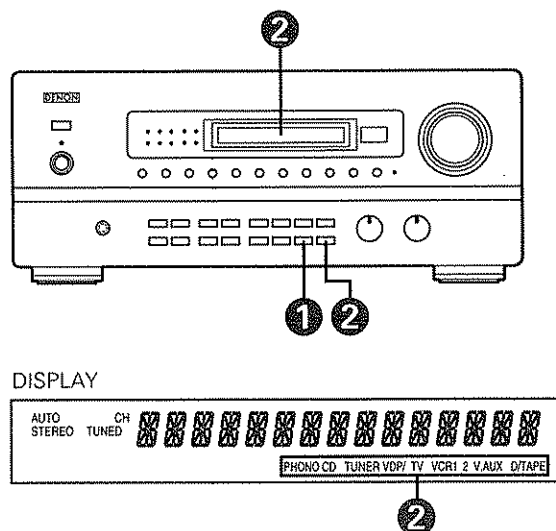

■ Playing a source other than the one currently playing in a different room (MULTI mode)

1. Press the REC/MULTI MODE button repeatedly until "M-SOURCE SOURCE" appears on the display. The "MULTI" indicator lights on the display at this time.

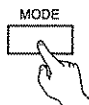

2. Select the source to be output to the MULTI SOURCE output terminal. Press the REC/MULTI SOURCE button repeatedly until the desired source appears on the display. The indicator of the selected program source lights on the display at this time.

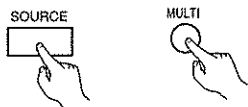

- ※ When the MULTI button on the remote control unit is pressed, the source to be output from the MULTI SOURCE terminals can be selected. (This cannot be selected when the main unit is in the REC OUT mode.)
- ※ The digital signals are not output from the MULTI SOURCE AUDIO/VIDEO OUT terminals.
- ※ To cancel the MULTI mode. Press the REC/MULTI MODE button or the MULTI button on the remote control unit repeatedly until "SOURCE" appears on the display.

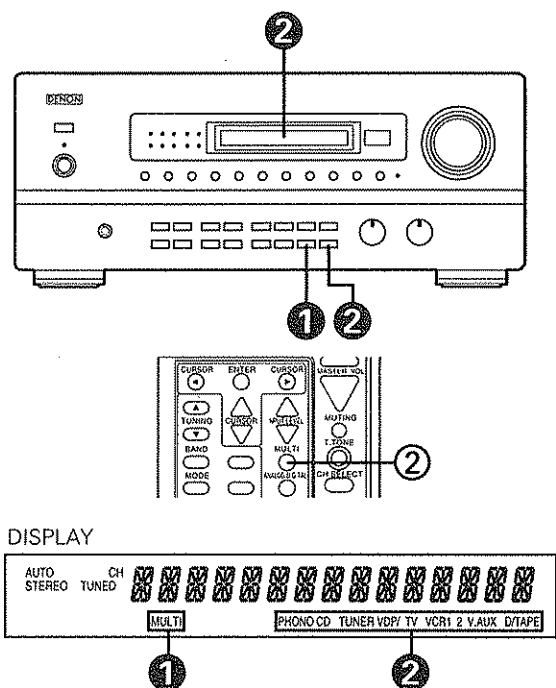

NOTE:

The signals of the source selected in the MULTI mode are also output from the TAPE and VCR recording output terminals.

Multi-source and multi-zone playback
MULTI ROOM MUSIC ENTERTAINMENT SYSTEM

- When the outputs of the MULTI SOURCE AUDIO/VIDEO OUT terminals are wired and connected to integrated amplifiers or TV displays installed in other rooms, different sources can be played in rooms other than the main room in which this unit and the playback devices are installed. (Refer to ANOTHER ROOM on the diagram below.)
- When a sold separately room-to-room remote control unit (DENON RC-616, 617 or 618) is wired and connected between the main room and another room, the remote-controllable devices in the main room can be controlled from another room using the remote control unit.
- ※ To control playback devices other than the ones above, either use that device's remote control unit or preset a separately sold programmable remote control unit.

NOTES:

- Use a 75 Ω/ohms coaxial pin-plug cord for video signals to connect and wire the MULTI SOURCE VIDEO output. For the AUDIO output, use high quality pin-plug cords and wire in such a way that there is no humming or noise.
- For instructions on installation and operation of separately sold devices, refer to the devices' operating instructions.

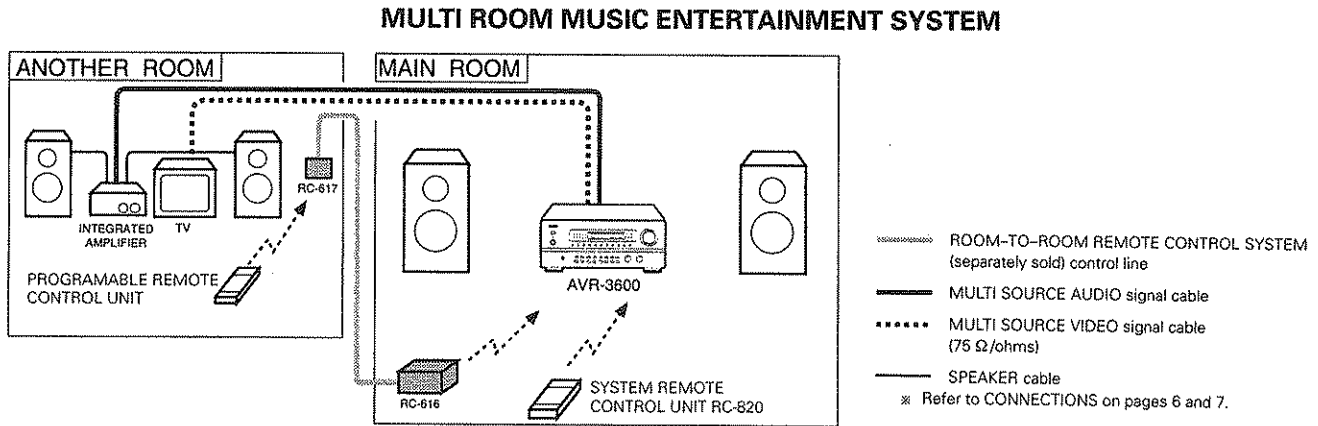

8-12 System call (remote control unit)

This function allows you to preset frequently used operation patterns in the remote control unit then automatically send a series of up to ten remote control codes with a single button.

Presetting

1. Press the SET button.

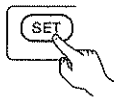

2. Press the buttons for the codes to be sent, changing the position of the slide switch as necessary. (Up to ten buttons can be set.) Buttons which have been "learned" and buttons which have been preset can also be selected.

3. Press the SYSTEM CALL button ("1" or "2") at which you want to store the codes. The setting is now stored.

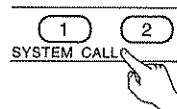

Recalling

4. Press the SYSTEM CALL button ("1" or "2") at which the desired codes have been stored. The series of codes is now sent.

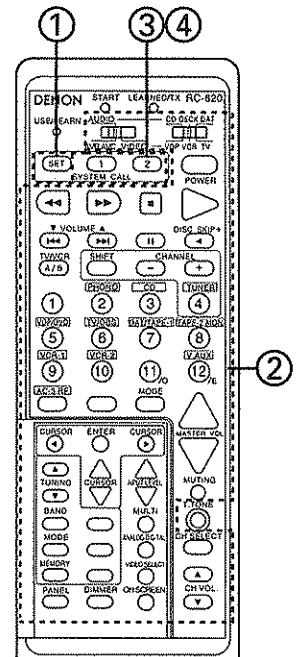
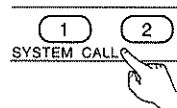

9 USING THE SURROUND FUNCTION

9-1 Dolby Surround

This unit is equipped with digital signal processing sections for decoding and reproducing movie soundtracks the same way as in movie theaters.

1. DOLBY SURROUND PRO LOGIC

When using conventional video tapes, laser discs, TV programs or CDs with the mark, Dolby Pro Logic provides extremely natural sound movement and positioning, immersing you in the on screen action. Pro Logic uses a directional emphasis circuit to decode four output channels (front left and right, center and surround) from the two audio channels provided on the software.

2. DOLBY DIGITAL AC-3

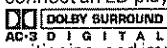
When you connect an LD player with an AC-3 RF output and play laser discs with the  mark, you can experience improved sound spatiality, positioning, and impact compared with Pro Logic. This is because Dolby Digital AC-3 delivers up to 5 totally discrete, full frequency audio channels (front left and right, center, and surround left and right), plus a bass-only effects channel. Since the signal is digital from the input of the program source until to the output of this unit, a higher quality and clarity of surround sound results.

Dolby Digital AC-3 (Auto Coding 3) is a system developed by Dolby Laboratories that transmits 5.1 channels of digital signals. The surround system developed for movie theaters using this system is called "Dolby SR-D (Surround Digital)". Whereas the conventional Dolby Pro Logic Surround is an analog matrix system, Dolby SR-D is a digital discrete system in which the different channels are completely independent. This makes it possible to achieve a realistic sound field with a "three-dimensional" feel, giving the sound a sense of distance, movement and relative position, and creating a surprisingly real and powerful sense of presence when playing movie software in AV rooms.

There are "5.1 ch" playback channels: three front channels (front left, center and front right), two surround channels (surround left and surround right), plus "0.1 channel" called LFE (Low Frequency Effect) for low bass effect sounds of 120 Hz or less. The signals are recorded on the software in fully discrete fashion, eliminating crosstalk between channels and making it possible to control the sound field in the listening/viewing space with greater precision.

In addition, the frequency range of the five channels extends up to 20 kHz, (the same as CDs,) resulting in clear sound with greater richness of expression. Also, Dolby Digital AC-3 will be used on DVDs, the next generation AV medium.

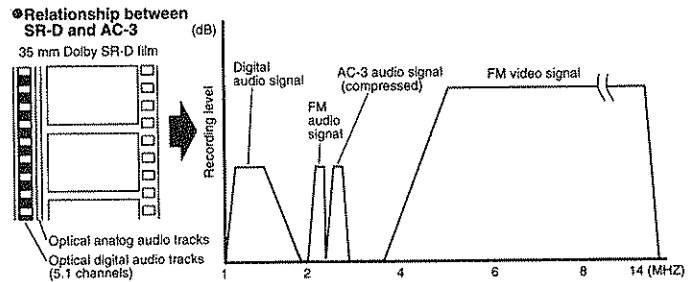

● Dolby Digital AC-3 and Pro Logic

Home surround methods	Dolby Digital AC-3	Dolby Pro Logic
No. recording channels (material)	5.1 ch	2 ch
No. playback channels	5.1 ch	4 ch
Playback channels	L, R, C, SL, SR and SW	L, R, C, S (SW recommended)
Audio processing	Digital discrete processing, AC-3 encoding/decoding	Analog matrix processing, Dolby Surround
Upper reproduction limit of surround channel	20 kHz	7 kHz

Manufactured under license from Dolby Laboratories Licensing Corporation. "Dolby," "AC-3," "Pro Logic" and the double-D symbol are trademarks of Dolby Laboratories Licensing Corporation. Copyright 1992 Dolby Laboratories, Inc. All rights reserved.

9-2 Before playing with the surround function

Before playing with the surround function, be sure to use the test tones to adjust the playback level from the different speakers. This adjustment can be performed with the system setup (see page 13, 14) or from the remote control unit, as described below.

Adjusting with the remote control unit using the test tones is only possible in the "Auto" mode and only effective in the Dolby Surround mode. The adjusted levels are automatically stored in the memory.

1. Press the test tone button.



2. Test tones are output from the different speakers. Use the channel volume adjust buttons to adjust so that the volume of the test tones is the same for all the speakers.

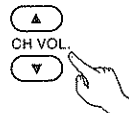

3. After completing the adjustment, press the test tone button again.



After adjusting using the test tones, adjust the channel levels either according to the playback sources or to suit your tastes, as described below.

1. Press the channel select button to select the speaker to be adjusted.

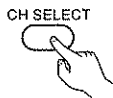

2. Adjust the level of the selected speaker.

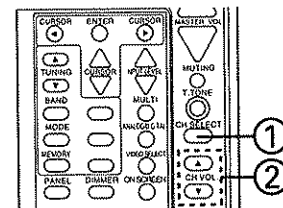
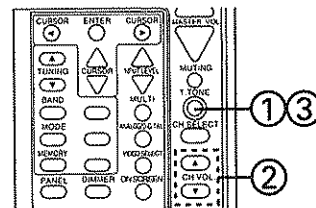
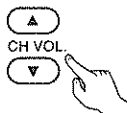

9-3 Using the Dolby Surround Pro Logic mode

1. Set the Dolby Surround mode.

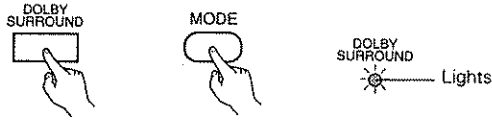

- ※ Conventional program sources will automatically be decoded with Dolby Pro Logic, while Dolby Digital AC-3 program sources will be decoded with Dolby Digital AC-3.

2. If necessary, adjust the input level when analog sources are used to obtain maximum dynamic range without overload.

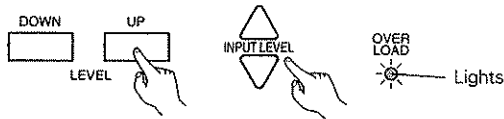

Set so that the indicator does not light at places where the volume is high.

- ※ For digital input sources, there is no need to adjust the input level. (These buttons will not operate and the indicator will not light.)
 - ※ The current input source, input level, etc., can be checked on the on screen display. (screen 23)
3. Play a program source with the or mark. For operating instructions, refer to the various components' manuals.

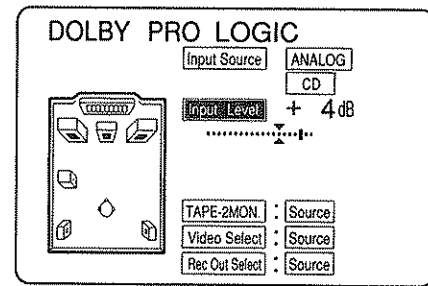
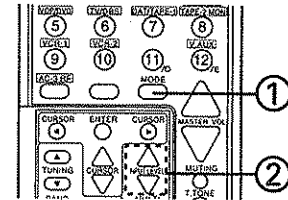
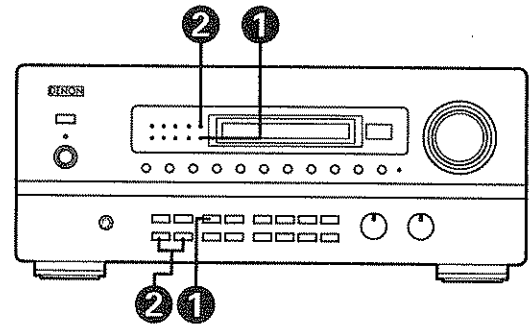

(screen 23)

9-4 Using the Dolby Digital AC-3 mode

1. Switch the audio input to AC-3RF input (a) or digital input (b). The VDP picture is linked to the AC-3RF signals.
 - a. **AC-3RF (VDP AUTO or VDP AC-3RF) input**
Select the AC-3 RF input.

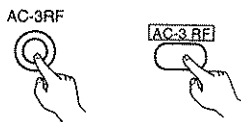

When the button is pressed, the video input automatically switches to VDP/DVD. The input mode switches as follows each time the button is pressed:

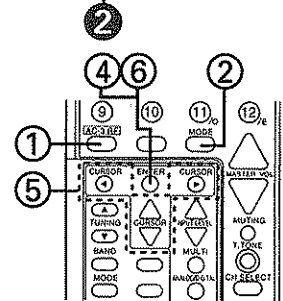
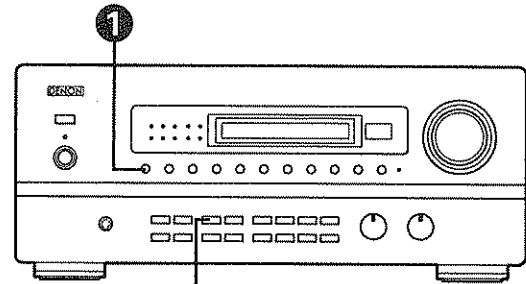

This input mode makes it possible to play the Dolby Digital AC-3 audio, digital audio or analog audio signals recorded on the source by switching between the priority and fixed modes for the AC-3RF, digital (optical/coaxial) or analog input jacks with the VDP/DVD function.

- VDP AUTO When AC-3RF signals and digital and analog signals are input from the LD, the signals are automatically selected with the following priority: AC-3RF → digital or analog.
- VDP AC-3 RF AC-3RF fixed input

NOTES:

- In the "VDP AUTO" mode, when an LD with the Dolby Digital AC-3 audio is detected, the decoder switches automatically and the Dolby Digital AC-3 audio is played. Also, in any mode other than normal LD player playback, no Dolby Digital AC-3 signals are detected, so the mode automatically switches to PCM or analog audio.
- In the "VDP AUTO" mode, when the mode changes from pause, chapter search, etc., to playback during playback of the Dolby Digital AC-3 audio on an LD, the PCM or analog sound may be output momentarily before the mode is switched to the Dolby Digital AC-3 audio mode. If this happens, the sound will not be interrupted if you switch to the "VDP AC-3RF" (AC-3RF fixed input) mode.
- The AC-3RF input mode setting is reset to "VDP AUTO" when the power is turned off using the power switch on the remote control unit or on the main unit.

b. Digital input

Select the digital input. Refer to page 23, 8-3, 1, 2 and 3.

2. Set the Dolby Surround mode.



3. Play a program source with the  mark or a program source with Dolby Digital AC-3 formats. The indicators below showing the signals included in the software light. (The number of channels differs according to the software.)

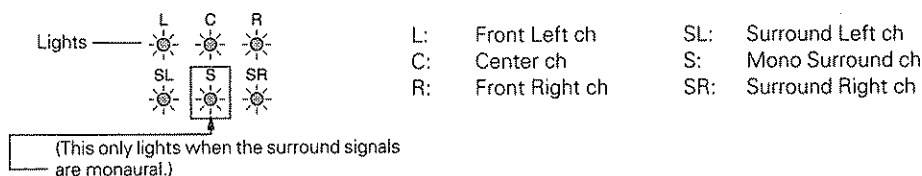

Also, the following indicator lights if the software contains Low Frequency Effect sounds:



4-1. Adjust the sound for the program source using the on screen display.

4-2. Press the ENTER button.



4-3. Use the CURSOR buttons to specify "Surround Parameters". (screen 24)

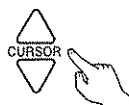

4-4. Press the ENTER button to switch the screen.



5. Use the CURSOR buttons to move the cursor on the screen and set the parameters. (screen 25)

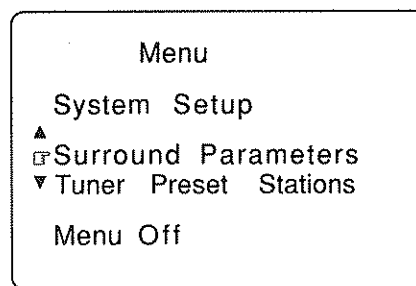

(screen 24)

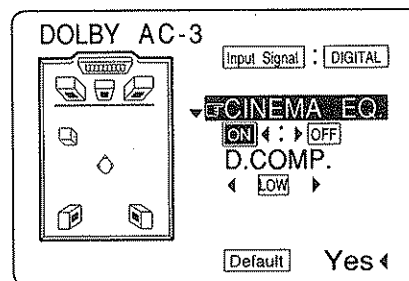

(screen 25)

6. After the above settings are completed, press the ENTER button.

NOTES:

- With this model, **Dolby Digital AC-3 encoded signals can only be played in the Dolby Pro Logic, Dolby Digital AC-3, direct and stereo modes.** Other surround mode buttons will not function during the Dolby Digital AC-3 signal playback.
- When the mode is switched to Dolby Digital AC-3 encoded signals while playing PCM digital signals or analog signals in the **MONO, 5CH STEREO, SUPER STADIUM, ROCK ARENA, JAZZ CLUB, CLASSIC CONCERT** or **MATRIX** Surround mode, the mode is **forcibly switched to the Dolby Surround mode.**

● **Surround parameters**

- CINEMA Use "CINEMA equalizer" if dialogue audio track sound scratchy when playing movie software. (The higher frequency component is lowered.) (Only effective in the Dolby Pro Logic, Dolby Digital AC-3 modes.)
This parameter can also be turned on and off with the CINEMA button on the main unit.
- D. COMP "Dynamic Range Compression" compresses the dynamic range. This is only effective for Dolby Digital AC-3 program sources. — There are four parameters: "OFF" ↔ "LOW" ↔ "MID" ↔ "HIGH"

NOTE: When "Default" is selected and the  cursor button is pressed, "CINEMA EQ" and "D.COMP" are automatically set to "OFF".

9-5 DSP surround simulation

This unit is equipped with a high precision D.S.P. (Digital Signal Processor) for processing signals digitally to simulate sound fields. Select the surround mode according to the playback source and adjust the parameters according to the conditions in the listening room to achieve realistic venue ambience.

These surround modes can be used with program sources not recorded in Dolby surround.

Types of surround modes and their characteristics

1	MONO	Use this when playing monaural signals, for example AM broadcasts or news programs.
2	5CH STEREO	The signals of the left and right channels are distributed to the different speakers to achieve a stereo sound from all directions at the listening position.
3	SUPER STADIUM	Use this to enjoy program sources such as football or baseball games with the atmosphere of a stadium.
4	ROCK ARENA	The powerful reverberations of this mode produce a sound field which recreates the excitement of live concerts. This mode is effective for rock, popular music, etc.
5	JAZZ CLUB	This mode creates the sound field of a live house with a low ceiling and hard wall reverberations. The result is that the artist seems to be performing right before your eyes.
6	CLASSIC CONCERT	This mode creates a sound field simulating a large concert hall, rich in reverberation. This mode is characterized by composed acoustics, and is perfect for playing classical music, etc.
7	MATRIX	Use this to enjoy stereo music sources with rich reverberations.

※ Depending on the program source being played, the effect may not be very noticeable.
In this case, try other surround modes, without worrying about their names, to create a sound field suited to your tastes.

Personal Memory Plus function for EASY USE

This unit automatically stores the surround mode adding selected effects for all input sources. The corresponding surround mode is recalled automatically each time an input source is selected.

9-6 Using the DSP surround simulation

1. Select the surround mode according to the input source.

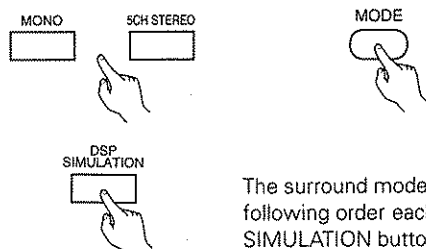

The surround mode switches in the following order each time the DSP SIMULATION button is pressed:

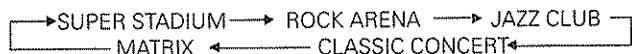

2. Press the ENTER button and call out the "Menu" screen from the on screen display.



3. Use the CURSOR buttons to specify "Surround Parameters". (screen 26)

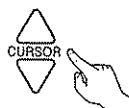

4. Press the ENTER button. The screen switches.

5. Move the cursor on the screen and make the various settings. (screen 27)

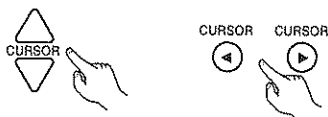

6. After the above settings are completed, press the ENTER button.

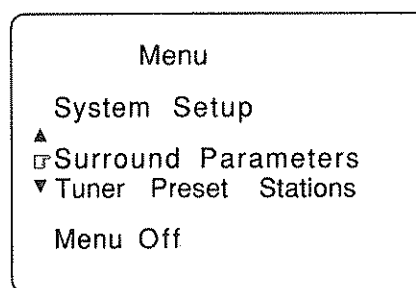
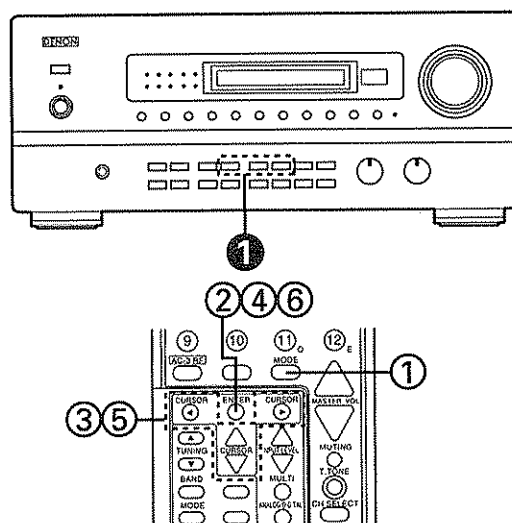

(screen 26)

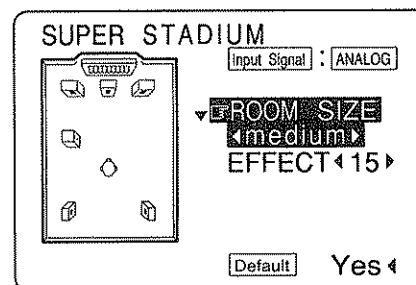

(screen 27)

● Surround modes and parameters

- ROOM SIZE "Room size" refers to the size of the sound field. — There are five parameters: "Small" ↔ "med.S." ↔ "medium" ↔ "med.L." ↔ "large"
- EFFECT LEVEL "Effect level" refers to the strength of the effect sounds. If the sound becomes distorted, lower the level. Parameter "1" ~ "15"
- DELAY This can be set to between 0 and 360 msec for the MATRIX mode.

NOTE: When "Default" is selected and the cursor button is pressed, "CINEMA EQ" and "D.COMP" are automatically set to "OFF", "ROOMSIZE" is set to "medium", "EFFECT LEVEL" is set to "10" and "DELAY TIME" is set to "30 ms".

NOTES:

- With this model, **Dolby Digital AC-3 encoded signals can only be played in the Dolby Pro Logic, Dolby Digital AC-3, direct and stereo modes.** Other surround mode buttons will not function during the Dolby Digital AC-3 signal playback.
- When the mode is switched to Dolby Digital AC-3 encoded signals while playing PCM digital signals or analog signals in the **MONO, 5CH STEREO, SUPER STADIUM, ROCK ARENA, JAZZ CLUB, CLASSIC CONCERT** or **MATRIX** Surround mode, the mode is **forcibly switched to the Dolby Surround mode.**

● Surround modes and parameters

MODE	OUTPUT CHANNEL				PARAMETER SOURCE (Default)					When playing AC-3 data
	FRONT L/R	CENTER	SURROUND	SUBWOOFER	CINEMA	ROOM SIZE	EFFECT LEVEL	DELAY TIME	D. COMP	
DIRECT	○	×	×	⊗ ※	×	×	×	×	○AC-3 SOURCE ONLY (OFF)	○
STEREO	○	×	×	⊗	×	×	×	×	○AC-3 SOURCE ONLY (OFF)	○
DOLBY PRO LOGIC	○	⊗	⊗	⊗	○(OFF)	×	×	×	○AC-3 SOURCE ONLY (OFF)	○
DOLBY AC-3	○	⊗	⊗	⊗	○(OFF)	×	×	×	○(OFF)	○
MONO	△	△	×	⊗	×	×	×	×	×	×
5CH STEREO	○	⊗	⊗	⊗	×	×	×	×	×	×
SUPER STADIUM	○	⊗	⊗	⊗	×	○(Medium)	○(10)	×	×	×
ROCK ARENA	○	⊗	⊗	⊗	×	○(Medium)	○(10)	×	×	×
JAZZ CLUB	○	⊗	⊗	⊗	×	○(Medium)	○(10)	×	×	×
CLASSIC CONCERT	○	⊗	⊗	⊗	×	○(Medium)	○(10)	×	×	×
MATRIX	○	⊗	⊗	⊗	×	×	×	○(30 msec)	×	×

○: Signal present or controllable.

△: Select one according to the speaker configuration setting.

⊗: Can be turned on and off according to the speaker configuration setting.

×

※: When the front speakers are large, no signals are output to the subwoofer, regardless of the speaker settings.

10 LISTENING TO THE RADIO

10-1 Auto tuning

1. Set the input function to "TUNER".

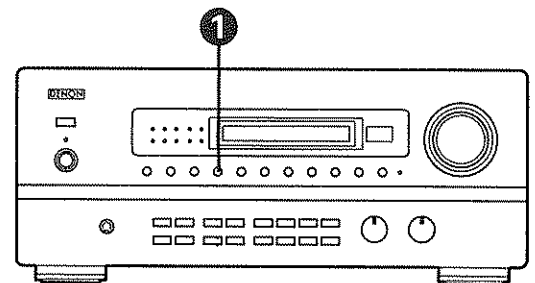
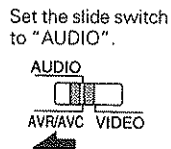
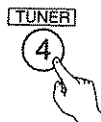

2. Watching the display, press the BAND button to select the desired band (AM or FM).



3. Press the MODE button to set the auto tuning mode.
4. Press the TUNING UP or DOWN button.

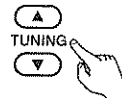

"Auto" appears on the display.

Automatic searching begins, then stops when a station is tuned in.

If tuning does not stop at the desired station, use to the "Manual tuning" operation.

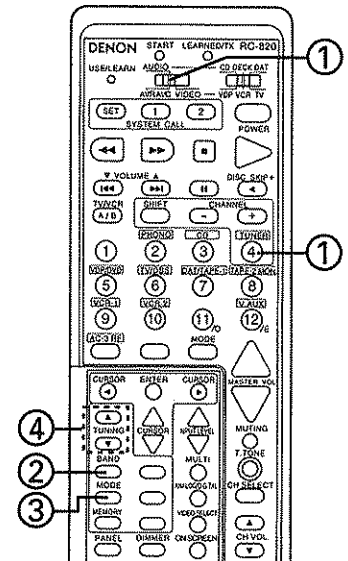

10-2 Manual tuning

1. Set the input function to "TUNER".
2. Watching the display, press the BAND button to select the desired band (AM or FM).
3. Press the MODE button to set the manual tuning mode. Check that the display's "AUTO" indicator turns.
4. Press the TUNING UP or DOWN button to tune in the desired station. The frequency changes continuously when the button is held in.

NOTES:

- When in the auto tuning mode on the FM band, the "STEREO" indicator lights on the display when a stereo broadcast is tuned in. At open frequencies, the noise is muted and the "TUNED" and "STEREO" indicators turn off.
- When the manual tuning mode is set, FM stereo broadcasts are received in monaural and the "STEREO" indicator turns off.

10-3 Preset memory

1. Use the "Auto tuning" or "Manual tuning" operation to tune in the station to be preset in the memory.

2. Press the MEMORY button.

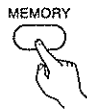

3. Press the SHIFT button and select the desired memory block (A to D).

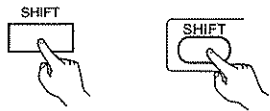

4. Press the PRESET UP or DOWN button to select the desired preset channel (1 to 8).



5. Press the MEMORY button again to store the station in the preset memory.



To preset other channels, repeat steps 2 to 5.

A total of 40 broadcast stations can be preset—8 stations (channels 1 to 8) in each of blocks A to E.

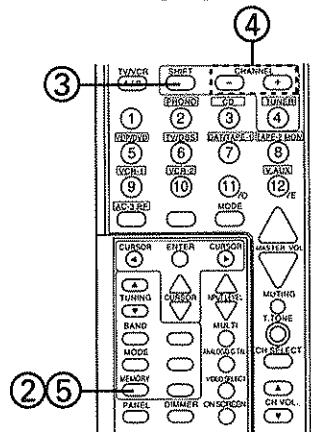
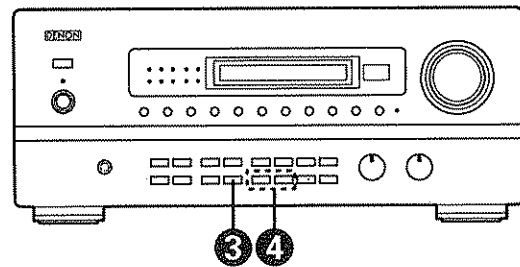

10-4 Checking the preset stations

The preset broadcast stations can be checked on the on screen display.

1. Press the ON SCREEN button repeatedly until the "Tuner Preset Stations" screen appears on the on screen display. (screen 28)

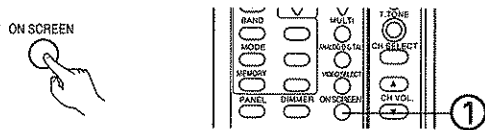

Tuner Preset Stations	
A1FM	87.50MHz
A2FM	88.10MHz
A3FM	89.30MHz
A4FM	91.30MHz
A5FM	97.90MHz
A6FM	104.10MHz
A7FM	106.50MHz
A8FM	107.90MHz

(screen 28)

10-5 Recalling preset stations

1. Watching the display, press the SHIFT button to select the preset memory block.

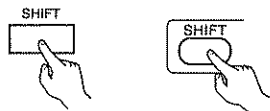

2. Watching the display, press the PRESET UP or DOWN button to select the desired preset channel.

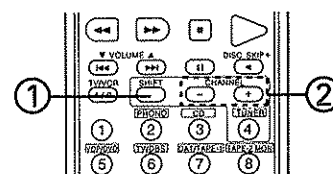
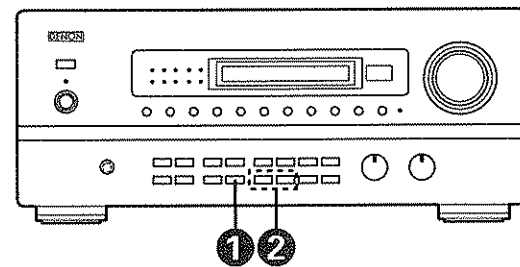

10-6 Recalling preset stations with the on screen display

1. Press the ENTER button and call out the "Menu" screen from the on screen display.



2. Use the CURSOR buttons to specify "Tuner Preset Stations". (screen 29)



3. Press the ENTER button. The screen switches to the "Tuner Preset Stations" screen. (screen 30)



4. Use the CURSOR buttons to select the station you want to tune in.



If the selected station is not displayed on the on screen display, use the CURSOR buttons to switch the displayed page.



5. Once the desired station is selected, press the CURSOR button to actually tune it in.



6. Once the desired station is tuned in, press the ENTER button. The "Menu" screen is displayed.



7. Use the CURSOR buttons to specify "Menu Off".

8. Press the ENTER button.

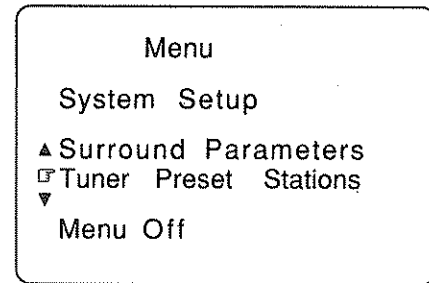

(screen 29)

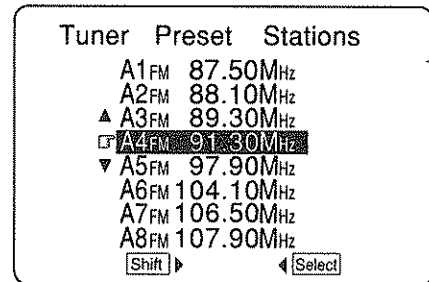

(screen 30)

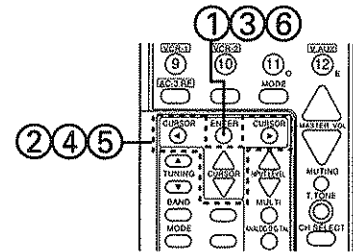

11 LAST FUNCTION MEMORY

- This unit is equipped with a last function memory which stores the input and output setting conditions as they were immediately before the power is switched off. This function eliminates the need to perform complicated resettings when the power is switched on.
- The unit is also equipped with a back-up memory. This function provides approximately one week of memory storage when the main unit's power switch is off and with the power cord disconnected.

12 INITIALIZATION OF THE MICROPROCESSOR

When the indication of the display is not normal or when the operation of the unit does not shows the reasonable result, the initialization of the microprocessor is required by the following procedure.

1. Switch off the unit using the main unit's power switch.
2. Hold the following AC-3 RF button and PHONO button, and turn the main unit's power switch on.
3. Check that the entire display is flashing with an interval of about 1 second, and release your fingers from the 2 buttons and the microprocessor will be initialized.

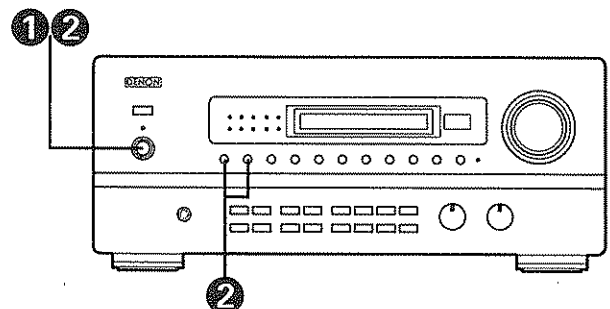

13 TROUBLESHOOTING

If a problem should arise, first check the following:

1. Are the connections correct?
2. Have you operated the receiver according to the Operating Instructions?
3. Are the speakers, turntable, and other components operating properly?

If this unit is not operating properly, check the items listed in the table below. Should the problem persist, there may be a malfunction. Disconnect the power immediately and contact your store of purchase.

	Symptom	Cause	Measures	Page
Common problems arising when listening to the CD, records, tapes, and FM broadcasts, etc.	DISPLAY not lit and sound not produced when power switch set to on.	<ul style="list-style-type: none"> • Power cord not plugged in securely. 	<ul style="list-style-type: none"> • Check the insertion of the power cord plug. • Turn the power on with the remote control unit after turning the POWER switch on. 	6 22
	DISPLAY lit but sound not produced.	<ul style="list-style-type: none"> • Speaker cords not securely connected. • Improper position of the audio function button. • Volume control set to minimum. • MUTING is on. • Digital signals not input Digital input selected. 	<ul style="list-style-type: none"> • Connect securely. • Set to a suitable position. • Turn volume up to suitable level. • Switch off MUTING. • Input digital signals or select input jacks to which digital signals are being input. 	9, 10 23 23 24 23
	-PROTECT- display appears.	<ul style="list-style-type: none"> • Speaker terminals are short-circuited. • Block the ventilation holes of the set. • The unit is operating at continuous high power conditions and/or inadequate ventilation. 	<ul style="list-style-type: none"> • Switch power off, connect speakers properly, then switch power back on. • Turn off the set's power, then ventilate it well to cool it down. Once the set is cooled down, turn the power back on. • Turn off the set's power, then ventilate it well to cool it down. Once the set is cooled down, turn the power back on. 	9, 10 5 5
	Sound produced only from one channel.	<ul style="list-style-type: none"> • Incomplete connection of speaker cords. • Incomplete connection of input/output cords. • Left/right balance is off. 	<ul style="list-style-type: none"> • Connect securely. • Connect securely. • Adjust balance knob properly. 	9, 10 6~8 24
	Positions of instruments reversed during stereo playback.	<ul style="list-style-type: none"> • Reverse connections of left and right speakers or left and right input/output cords. 	<ul style="list-style-type: none"> • Check left and right connections. 	6~10
	The on screen display is not displayed.	<ul style="list-style-type: none"> • "On screen display" is set to off on the system setup menu screen. 	<ul style="list-style-type: none"> • Set "on screen display" on the system setup menu screen to on. 	17
When playing records	Humming noise produced when record is playing.	<ul style="list-style-type: none"> • Ground wire of turntable not connected properly. • Incomplete PHONO jack connection. • TV or radio transmission antenna nearby. 	<ul style="list-style-type: none"> • Connect securely. • Connect securely. • Contact your store of purchase. 	6 6 ---
	Howling noise produced when volume is high.	<ul style="list-style-type: none"> • Turntable and speaker systems too close together. • Floor is unstable and vibrates easily. 	<ul style="list-style-type: none"> • Separate as much as possible. • Use cushions to absorb speaker vibrations transmitted by floor. If turntable is not equipped with insulators, use audio insulators (commonly available). 	--- ---
	Sound is distorted.	<ul style="list-style-type: none"> • Stylus pressure too weak. • Dust or dirt on stylus. • Cartridge defective. 	<ul style="list-style-type: none"> • Apply proper stylus pressure. • Check stylus. • Replace cartridge. 	--- --- ---
	Volume is weak.	<ul style="list-style-type: none"> • MC cartridge being used. 	<ul style="list-style-type: none"> • Replace with MM cartridge or use a head amplifier or step-up transformer. 	6
Remote control unit	This unit does not operate properly when remote control unit is used.	<ul style="list-style-type: none"> • Batteries dead. • Remote control unit too far from this unit. • Obstacle between this unit and remote control unit. • Different button is being pressed. • ⊕ and ⊖ ends of battery inserted in reverse. 	<ul style="list-style-type: none"> • Replace with new batteries. • Move closer. • Remove obstacle. • Press the proper button. • Insert batteries properly. 	18 18 18 18 18

14 SPECIFICATIONS

• Audio section

(Power amplifier)

Rated output:

(All properties shown are only for the power amplifier stage.)

Stereo (2ch driven)
 110 W × 2 ch (8 Ω / ohms, 20 Hz ~ 20 kHz with 0.05% T.H.D.)
 125 W × 2 ch (8 Ω / ohms, 1 kHz with 0.7% T.H.D.)

Surround

90 W × 5 ch (8 Ω / ohms, 1 kHz with 0.7% T.H.D.)

Dynamic power:

140 W × 2 ch (8 Ω / ohms)

235 W × 2 ch (4 Ω / ohms)

280 W × 2 ch (2 Ω / ohms)

Output terminals:

Front/Center: A or B or Bi-wiring 8 to 16 Ω / ohms
 A + B 16 Ω / ohms

Surround: 8 to 16 Ω / ohms

(Analog)

Input sensitivity / input impedance:

200 mV / 47 kΩ / kohms

Frequency response:

10 Hz ~ 100 kHz: +0, -3 dB (DIRECT mode)

S / N:

105 dB (DIRECT mode)

Distortion:

0.005% (20 Hz ~ 20 kHz) (DIRECT mode)

Rated output / maximum output:

1.2 V / 8 V

Maximum headphones output:

284 mW (8 Ω / ohms)

(Digital)

D / A output:

Rated output - 2 V (at 0 dB playback)

Total harmonic distortion - 0.005% (1 kHz, at 0 dB)

S/N ratio - 102 dB

Dynamic range - 96 dB

Format - Digital audio interface

Digital input:

• Video section

(Standard video jacks)

Input / output level and impedance:

1 Vp-p, 75 Ω / ohms

Frequency response:

5 Hz ~ 10 MHz +0, -3 dB

(S-video jacks)

Input / output level and impedance:

Y (brightness) signal - 1 Vp-p, 75 Ω / ohms

C (color) signal - 0.286 Vp-p, 75 Ω / ohms

Frequency response:

5 Hz ~ 10 MHz +0, -3 dB

• Tuner section

Receiving Range:

[FM] (note: μV at 75 Ω / ohms, 0 dBf = 1×10^{-15} W)

Usable Sensitivity:

87.5 MHz ~ 107.9 MHz

50 dB Quieting Sensitivity:

1.0 μV (11.2 dBf)

MONO 1.6 μV (15.3 dBf)

STEREO 23 μV (38.5 dBf)

Signal to Noise Ratio (IHF-A):

MONO 80 dB

50 dB

STEREO 75 dB

Total Harmonic Distortion

MONO 0.15%

(at 1 kHz):

STEREO 0.3%

[AM]

520 kHz ~ 1710 kHz

18 μV

• General

Power supply:

AC 120 V, 60 Hz

Power consumption:

8 A

Maximum external dimensions:

434 (W) × 181 (H) × 486 (D) mm (17-3/32" × 7-1/8" × 19-1/8")

Weight:

21.5 kg (47 lbs 6 oz)

• Remote control unit (RC-820)

Batteries:

R6P/AA Type (two batteries)

External dimensions:

70 (W) × 215 (H) × 19 (D) mm (2-3/4" × 8-15/32" × 3/4")

Weight:

180 g (Approx. 6 oz) (including batteries)

* For purposes of improvement, specifications and design are subject to change without notice.

NIPPON COLUMBIA CO. LTD.

14-14, AKASAKA 4-CHOME, MINATO-KU, TOKYO 107-11, JAPAN

Telephone: (03) 3584-8111

Cable: NIPPON COLUMBIA TOKYO Telex: JAPANOLA J22591

Free Manuals Download Website

<http://myh66.com>

<http://usermanuals.us>

<http://www.somanuals.com>

<http://www.4manuals.cc>

<http://www.manual-lib.com>

<http://www.404manual.com>

<http://www.luxmanual.com>

<http://aubethermostatmanual.com>

Golf course search by state

<http://golfingnear.com>

Email search by domain

<http://emailbydomain.com>

Auto manuals search

<http://auto.somanuals.com>

TV manuals search

<http://tv.somanuals.com>