

# DENON

**SUPER AUDIO CD RECEIVER**

# **RCD-CX1**

---

**Owner's Manual**

**Manuel de l'Utilisateur**

**Manual del usuario**

**SAFETY PRECAUTIONS**



**CAUTION**  
**RISK OF ELECTRIC SHOCK**  
**DO NOT OPEN**



**CAUTION:**  
**TO REDUCE THE RISK OF ELECTRIC SHOCK, DO NOT REMOVE COVER (OR BACK). NO USER-SERVICEABLE PARTS INSIDE. REFER SERVICING TO QUALIFIED SERVICE PERSONNEL.**

The lightning flash with arrowhead symbol, within an equilateral triangle, is intended to alert the user to the presence of uninsulated "dangerous voltage" within the product's enclosure that may be of sufficient magnitude to constitute a risk of electric shock to persons.

The exclamation point within an equilateral triangle is intended to alert the user to the presence of important operating and maintenance (servicing) instructions in the literature accompanying the appliance.

**WARNING:**  
**TO REDUCE THE RISK OF FIRE OR ELECTRIC SHOCK, DO NOT EXPOSE THIS APPLIANCE TO RAIN OR MOISTURE.**

**CAUTION:**  
**USE OF CONTROLS OR ADJUSTMENTS OR PERFORMANCE OF PROCEDURES OTHER THAN THOSE SPECIFIED HEREIN MAY RESULT IN HAZARDOUS RADIATION EXPOSURE. THIS PRODUCT SHOULD NOT BE ADJUSTED OR REPAIRED BY ANYONE EXCEPT PROPERLY QUALIFIED SERVICE PERSONNEL.**

**Laser Class (IEC 60825-1:2001)**

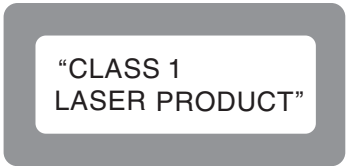

**Copyrights / Droits d'auteur / Derechos de Autor**

- It is prohibited by law to reproduce, broadcast, rent or play discs in public without the consent of the copyright holder.
- La reproduction, la diffusion, la location, le prêt ou la lecture publique de ces disques sont interdits sans le consentement du détenteur des droits d'auteur.
- De acuerdo con las leyes está prohibido reproducir, emitir, alquilar o interpretar discos en público sin la autorización del propietario de los derechos de autor.

# IMPOTANT SAFETY INSTRUCTIONS

1. Read these instructions.
2. Keep these instructions.
3. Heed all warnings.
4. Follow all instructions.
5. Do not use this apparatus near water.
6. Clean only with dry cloth.
7. Do not block any ventilation openings. Install in accordance with the manufacturer's instructions.
8. Do not install near any heat sources such as radiators, heat registers, stoves, or other apparatus (including amplifiers) that produce heat.
9. Do not defeat the safety purpose of the polarized or grounding-type plug. A polarized plug has two blades with one wider than the other. A grounding type plug has two blades and a third grounding prong. The wide blade or the third prong are provided for your safety. If the provided plug does not fit into your outlet, consult an electrician for replacement of the obsolete outlet.
10. Protect the power cord from being walked on or pinched particularly at plugs, convenience receptacles, and the point where they exit from the apparatus.
11. Only use attachments/accessories specified by the manufacturer.
12. Use only with the cart, stand, tripod, bracket, or table specified by the manufacturer, or sold with the apparatus. When a cart is used, use caution when moving the cart/apparatus combination to avoid injury from tip-over.
13. Unplug this apparatus during lightning storms or when unused for long periods of time.
14. Refer all servicing to qualified service personnel. Servicing is required when the apparatus has been damaged in any way, such as power-supply cord or plug is damaged, liquid has been spilled or objects have fallen into the apparatus, the apparatus has been exposed to rain or moisture, does not operate normally, or has been dropped.
15. Batteries shall not be exposed to excessive heat such as sunshine, fire or the like.



**CAUTION:**

- The ventilation should not be impeded by covering the ventilation openings with items, such as newspapers, tablecloths, curtains, etc.
- No naked flame sources, such as lighted candles, should be placed on the unit.
- Observe and follow local regulations regarding battery disposal.
- Do not expose the unit to dripping or splashing fluids.
- Do not place objects filled with liquids, such as vases, on the unit.

**ATTENTION:**

- La ventilation ne doit pas être gênée en recouvrant les ouvertures de la ventilation avec des objets tels que journaux, rideaux, tissus, etc.
- Aucune flamme nue, par exemple une bougie, ne doit être placée sur l'appareil.
- Veillez à respecter les lois en vigueur lorsque vous jetez les piles usagées.
- L'appareil ne doit pas être exposé à l'eau ou à l'humidité.
- Ne pas poser d'objet contenant du liquide, par exemple un vase, sur l'appareil.

**PRECAUCIÓN:**

- La ventilación no debe quedar obstruida por haberse cubierto las aperturas con objetos como periódicos, manteles, cortinas, etc.
- No debe colocarse sobre el aparato ninguna fuente inflamable sin protección, como velas encendidas.
- A la hora de deshacerse de las pilas, respete la normativa para el cuidado del medio ambiente.
- No exponer el aparato al goteo o salpicaduras cuando se utilice.
- No colocar sobre el aparato objetos llenos de líquido, como jarros.

**CAUTION:**

To completely disconnect this product from the mains, disconnect the plug from the wall socket outlet. The mains plug is used to completely interrupt the power supply to the unit and must be within easy access by the user.

**PRECAUTION:**

Pour déconnecter complètement ce produit du courant secteur, débranchez la prise de la prise murale. La prise secteur est utilisée pour couper complètement l'alimentation de l'appareil et l'utilisateur doit pouvoir y accéder facilement.

**PRECAUCIÓN:**

Para desconectar completamente este producto de la alimentación eléctrica, desconecte el enchufe del enchufe de la pared. El enchufe de la alimentación eléctrica se utiliza para interrumpir por completo el suministro de alimentación eléctrica a la unidad y debe de encontrarse en un lugar al que el usuario tenga fácil acceso.

**FCC Information (For US customers)**

**1. PRODUCT**

This product complies with Part 15 of the FCC Rules. Operation is subject to the following two conditions: (1) this product may not cause harmful interference, and (2) this product must accept any interference received, including interference that may cause undesired operation.

**2. IMPORTANT NOTICE: DO NOT MODIFY THIS PRODUCT**

This product, when installed as indicated in the instructions contained in this manual, meets FCC requirements. Modification not expressly approved by DENON may void your authority, granted by the FCC, to use the product.

**3. NOTE**

This product has been tested and found to comply with the limits for a Class B digital device, pursuant to Part 15 of the FCC Rules. These limits are designed to provide reasonable protection against harmful interference in a residential installation.







This product generates, uses and can radiate radio frequency energy and, if not installed and used in accordance with the instructions, may cause harmful interference to radio communications. However, there is no guarantee that interference will not occur in a particular installation. If this product does cause harmful interference to radio or television reception, which can be determined by turning the product OFF and ON, the user is encouraged to try to correct the interference by one or more of the following measures:

- Reorient or relocate the receiving antenna.
- Increase the separation between the equipment and receiver.
- Connect the product into an outlet on a circuit different from that to which the receiver is connected.
- Consult the local retailer authorized to distribute this type of product or an experienced radio/TV technician for help.

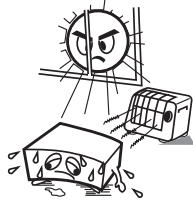
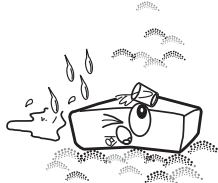
This Class B digital apparatus complies with Canadian ICES-003.

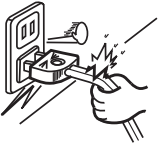
Cet appareil numérique de la classe B est conforme à la norme NMB-003 du Canada.

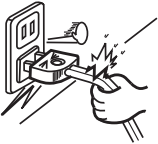
**NOTE ON USE / OBSERVATIONS RELATIVES A L'UTILISATION / NOTAS SOBRE EL USO**

 <ul style="list-style-type: none"> <li>• Avoid high temperatures. Allow for sufficient heat dispersion when installed in a rack.</li> <li>• Éviter des températures élevées. Tenir compte d'une dispersion de chaleur suffisante lors de l'installation sur une étagère.</li> <li>• Evite altas temperaturas. Permite la suficiente dispersión del calor cuando está instalado en la consola.</li> </ul>	 <ul style="list-style-type: none"> <li>• Keep the unit free from moisture, water, and dust.</li> <li>• Protéger l'appareil contre l'humidité, l'eau et la poussière.</li> <li>• Mantenga el equipo libre de humedad, agua y polvo.</li> </ul>	 <ul style="list-style-type: none"> <li>• Do not let foreign objects into the unit.</li> <li>• Ne pas laisser des objets étrangers dans l'appareil.</li> <li>• No deje objetos extraños dentro del equipo.</li> </ul>
 <ul style="list-style-type: none"> <li>• Unplug the power cord when not using the unit for long periods of time.</li> <li>• Débrancher le cordon d'alimentation lorsque l'appareil n'est pas utilisé pendant de longues périodes.</li> <li>• Desconecte el cordón de energía cuando no utilice el equipo por mucho tiempo.</li> </ul>	 <ul style="list-style-type: none"> <li>• Do not let insecticides, benzene, and thinner come in contact with the unit.</li> <li>• Ne pas mettre en contact des insecticides, du benzène et un diluant avec l'appareil.</li> <li>• No permita el contacto de insecticidas, gasolina y diluyentes con el equipo.</li> </ul>	 <ul style="list-style-type: none"> <li>• Do not let insecticides, benzene, and thinner come in contact with the unit.</li> <li>• Ne pas mettre en contact des insecticides, du benzène et un diluant avec l'appareil.</li> <li>• No permita el contacto de insecticidas, gasolina y diluyentes con el equipo.</li> </ul>
 <ul style="list-style-type: none"> <li>• Handle the power cord carefully. Hold the plug when unplugging the cord.</li> <li>• Manipuler le cordon d'alimentation avec précaution. Tenir la prise lors du débranchement du cordon.</li> <li>• Maneje el cordón de energía con cuidado. Sostenga el enchufe cuando desconecte el cordón de energía.</li> </ul>	 <p>* (For apparatuses with ventilation holes)</p> <ul style="list-style-type: none"> <li>• Do not obstruct the ventilation holes.</li> <li>• Ne pas obstruer les trous d'aération.</li> <li>• No obstruya los orificios de ventilación.</li> </ul>	 <ul style="list-style-type: none"> <li>• Never disassemble or modify the unit in any way.</li> <li>• Ne jamais démonter ou modifier l'appareil d'une manière ou d'une autre.</li> <li>• Nunca desarme o modifique el equipo de ninguna manera.</li> </ul>

## □ Contents

### Getting Started

<b>Accessories</b> .....	2
<b>Cautions on Handling</b> .....	2
<b>Cautions on Installation</b> .....	2
<b>About Discs</b> .....	2
Discs Usable on the RCD-CX1 .....	2
Holding Discs .....	3
Loading Discs .....	3
Cautions on Loading Discs .....	3
Cautions on Handling .....	3
Cautions on Storing Discs .....	3
Cleaning Discs .....	4
<b>About the Remote Control Unit</b> .....	4
Inserting the Batteries .....	4
Operating Range of the Remote Control Unit .....	4
<b>Part Names and Functions</b> .....	5
Front Panel .....	5
Display .....	5
Rear Panel .....	5
Remote Control Unit .....	6

### Connections

<b>Preparations</b> .....	7
Cables Used for Connections .....	7
Using the AM Loop Antenna .....	7
Assembling the AM Loop Antenna .....	7
<b>Speaker Connections</b> .....	8
Connecting the Speaker Cables .....	8
<b>Connecting the Playback Components</b> .....	8
Record Player .....	8
iPod® .....	9
<b>Connecting a Power Amp and Subwoofer</b> .....	9
<b>Connecting the Recording Components</b> .....	9
CD Recorder / MD Recorder / Tape Deck .....	9
<b>Connections to Other Devices</b> .....	10
Antenna terminals .....	10
<b>Connecting the Power Cord</b> .....	10
<b>Once Connections are Completed</b> .....	10

### Setup

<b>Setting the Current Time (12-Hour Display)</b> .....	11
---	----

### Playback

<b>Preparations</b> .....	12
Turning the Power On .....	12
Setting the layer to be played with priority .....	12
Loading Discs .....	12
<b>Operations During Playback</b> .....	12
Adjusting the Master Volume .....	12
Input Source Switching .....	12
Listening with Headphones .....	12
Adjusting the Tone .....	13
Turning the Sound Off Temporarily (Muting) .....	13
Switching the Brightness of the Display .....	13
<b>CD Playback</b> .....	14
Playing CDs .....	14
Switching the Display .....	14
Repeat Play or Random Play .....	14
Playing Tracks in the Desired Order <Program> .....	15
<b>Playback of MP3 and WMA Files</b> .....	15
About the MP3 and WMA Formats that can be Played .....	15
Playing MP3 and WMA Files .....	16
Repeat Play or Random Play .....	16
<b>TUNER Playback</b> .....	17
Tuning in Broadcast Stations .....	17
Automatically Presetting FM Stations (Auto Preset) .....	17
Presetting FM/AM Stations Manually .....	17
Listening to Preset Stations .....	18
Naming the Currently Tuned in Broadcast Station .....	18
<b>iPod® Playback</b> .....	18
Preparations .....	18
Listening to Audio .....	18
Disconnecting the iPod .....	19
<b>Recording</b> .....	19
Recording on an External Device .....	19

### Setting the Timer

<b>Timer Playback</b> .....	20
Setting the Timer .....	20
Set the Timer ON/OFF .....	21
Setting the Sleep Timer .....	22

### Other Functions

<b>Convenient Functions</b> .....	22
Auto Power On .....	22
Auto Function Selector Function .....	22
Last Function Memory .....	22
Resetting the Microprocessor .....	22

### Troubleshooting .....

23

### Specifications .....

24

# Getting Started

Thank you for purchasing this DENON product. To ensure proper operation, please read this owner's manual carefully before using the product.

After reading them, be sure to keep them for future reference.

## Accessories

Check that the following parts are supplied with the product.

① Remote control (RC-1109).....	1
② R03/AAA batteries .....	2
③ Power cord (Cord length: Approx. 6.6 ft /2 m) .....	1
④ AM loop antenna .....	1
⑤ FM indoor antenna .....	1
⑥ Owner's manual .....	1
⑦ Service station list .....	1

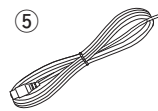
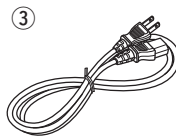
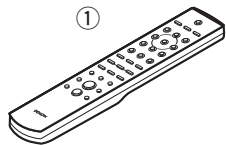

## Cautions on Handling

### • Before turning the power switch on

Check once again that all connections are correct and that there are no problems with the connection cables.

- Power is supplied to some of the circuitry even when the unit is set to the standby mode. When traveling or leaving home for long periods of time, be sure to unplug the power cord from the power outlet.

### • Sufficiently ventilate the place of installation

If the unit is left in a room full of the smoke from cigarettes, etc., for long periods of time, the surface of the optical pickup could get dirty, in which case it will not be able to read the signals properly.

### • About condensation

If there is a major difference in temperature between the inside of the unit and the surroundings, condensation (dew) may form on the operating parts inside the unit, causing the unit not to operate properly.

If this happens, let the unit sit for an hour or two with the power turned off and wait until there is little difference in temperature before using the unit.

### • Cautions on using mobile phones

Using a mobile phone near this unit may result in noise. If so, move the mobile phone away from this unit when it is in use.

### • Moving the unit

Turn off the power and unplug the power cord from the power outlet.

Next, disconnect the connection cables to other system units before moving the unit.

- Note that the illustrations in these instructions may differ from the actual unit for explanation purposes.

## Cautions on Installation

### Note:

For proper heat dispersal, do not install this unit in a confined space, such as a bookcase or similar enclosure.

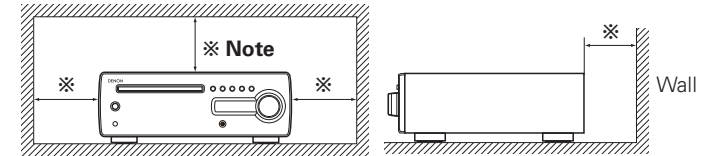

## About Discs

### Discs Usable on the RCD-CX1

#### ① Super Audio CDs

Super Audio CDs marked with the logotypes indicated below can be played on this unit.



There are three types of Super Audio CDs:

#### ① Single layer disc

Single layer Super Audio CD with only an HD layer.

#### ② Dual layer disc

Super Audio CD with a double HD layer, offering extended playing time and high sound quality.

#### ③ Hybrid disc

Two-layer Super Audio CD with an HD layer and a CD layer. The signals on the CD layer can be played on a regular CD player.

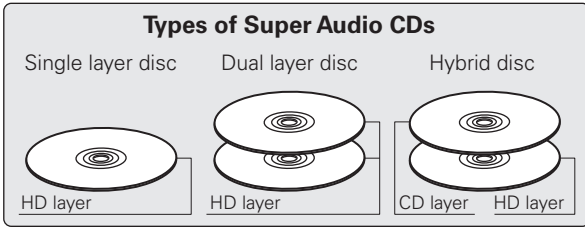

- ※ What is the HD layer?  
The HD layer is a layer of high density signals for Super Audio CDs.
- ※ What is the CD layer?  
The CD layer is the layer of signals that can be read on a regular CD player.



This unit is not compatible with multi-channel playback.

**2 Music CDs**

Discs marked with the logotype below can be played in this unit.



**3 CD-R/CD-RW**

- Some discs and some recording formats may not be playable.
- Non-finalized discs cannot be played.

- ※ What is finalization?  
Finalization is the process that makes recorded CD-R/CD-RW discs playable on compatible players.

**NOTE**

Discs with special shapes (heart-shaped discs, octagonal discs, etc.) cannot be played. Do not attempt to play them, as doing so can damage the product.



**Holding Discs**



Do not touch the signal surface.

**Loading Discs**

- Set the disc with the labeled side facing up.
- Make sure the disc tray is fully open when inserting the disc.
- Place the discs flatly, 12 cm discs in the outer tray guide (Figure 1), 8 cm discs in the inner tray guide (Figure 2).

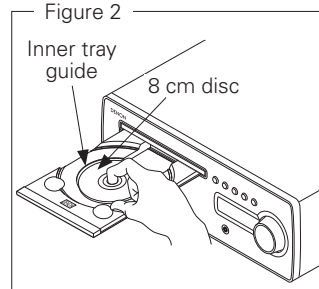
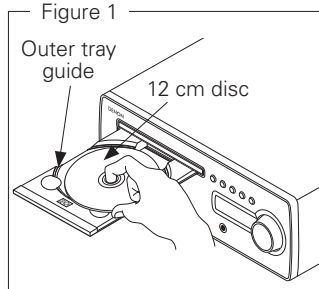

- Place 8 cm discs in the inner tray guide without using an adapter.



- "00:00" is displayed if a disc that cannot be played is loaded.
- "NO DISC" is displayed if the disc is loaded upside-down or if no disc is loaded.

**Cautions on Loading Discs**

- Only load one disc at a time. Loading two or more discs can damage the unit or scratch the discs.
- Do not use cracked or warped discs or discs that have been repaired with adhesive, etc.
- Do not use discs on which the sticky part of cellophane tape or labels is exposed or on which there are traces of where labels have been removed. Such discs can get caught inside the player and damage it.

**Cautions on Handling**

- Do not get fingerprints, oil or dirt on discs.
- Take special care not to scratch discs when removing them from their cases.
- Do not bend or heat discs.
- Do not enlarge the hole at the center.
- Do not write on the labeled (printed) surface with ball-point pens, pencils, etc., or stick new labels on discs.
- Water droplets may form on discs if they are moved suddenly from a cold place (outdoors for example) to a warm place, but do not try to dry them off using a hairdryer, etc.

**Cautions on Storing Discs**

- Be sure to remove discs after using them.
- Be sure to store discs in their cases to protect them from dust, scratches, warping, etc.
- Do not store discs in the following places:
  1. Places exposed to direct sunlight for long periods of time
  2. Dusty or humid places
  3. Places exposed to heat from heating appliances, etc.

## Cleaning Discs

- If there are fingerprints or dirt on discs, wipe them off before using the disc. Fingerprints and dirt can impair sound quality and cause interruptions in playback.
- Use a commercially available disc cleaning set or a soft cloth to clean discs.

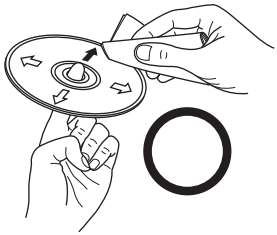

Gently wipe the disc from the inside towards the outside.

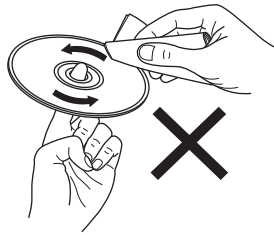

Do not wipe with a circular motion.

### NOTE

Do not use record spray, antistatic agents, or benzene, thinner or other solvents.

## About the Remote Control Unit

### Inserting the Batteries

- ① Remove the remote control unit's rear cover.
- ② Set two R03/AAA batteries in the battery compartment in the indicated direction.

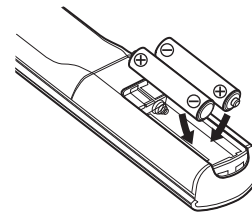
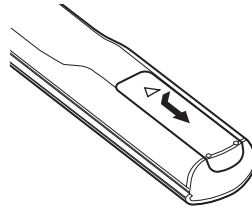

- ③ Put the rear cover back on.

### NOTE

- Replace the batteries with new ones if the set does not operate even when the remote control unit is operated close to the unit.
- The supplied batteries are only for verifying operation.
- When inserting the batteries, be sure to do so in the proper direction, following the “+” and “-” marks in the battery compartment.
- To prevent damage or leakage of battery fluid:
  - Do not use a new battery together with an old one.
  - Do not use two different types of batteries.
  - Do not attempt to charge dry batteries.
  - Do not short-circuit, disassemble, heat or dispose of batteries in flames.
- If the battery fluid should leak, carefully wipe the fluid off the inside of the battery compartment and insert new batteries.
- Remove the batteries from the remote control unit if it will not be in use for long periods.

## Operating Range of the Remote Control Unit

Point the remote control unit at the remote sensor when operating it.

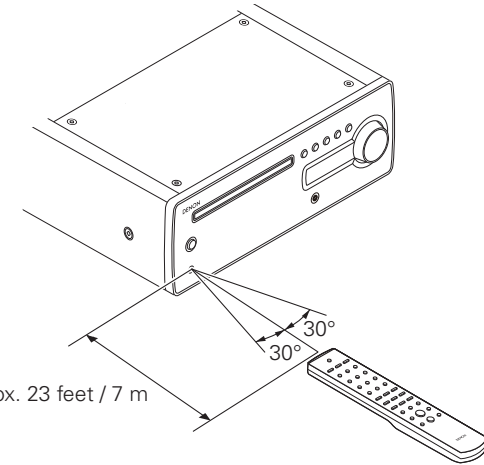

### NOTE

The set may function improperly or the remote control unit may not operate if the remote control sensor is exposed to direct sunlight, strong artificial light from an inverter type fluorescent lamp or infrared light.



# Part Names and Functions

For buttons not explained here, see the page indicated in parentheses ( ).

## Front Panel

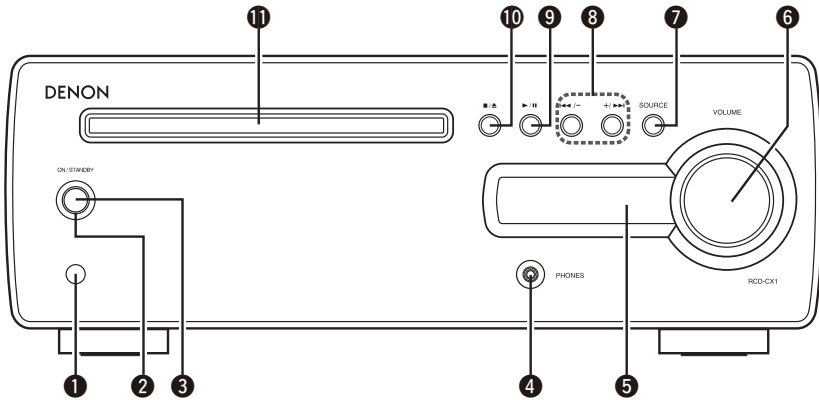

- 1 Remote control sensor ..... (4)
- 2 Power indicator ..... (12)
- 3 Power operation button (ON/STANDBY) ..... (11, 12)
- 4 Headphones jack (PHONES) ..... (12)
- 5 Display
- 6 Master volume control knob (VOLUME) ..... (12)
- 7 SOURCE button ..... (12)
- 8 Reverse-skip/Forward-skip buttons (|◀◀- / +▶▶|) ..... (14, 16, 17)
- 9 Play/Pause button (▶/||) ..... (14)
- 10 Stop / Disc tray open/close button (■/▲) ..... (12)
- 11 Disc tray ..... (3)

## Display

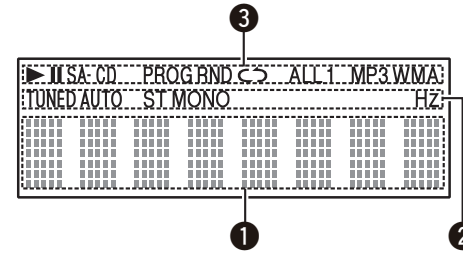

- 1 Information display  
Various information is displayed here, depending on the operation mode.
- 2 Tuner reception mode indicators ..... (17, 18)
- 3 Mode indicators ..... (14 ~ 19)

## Rear Panel

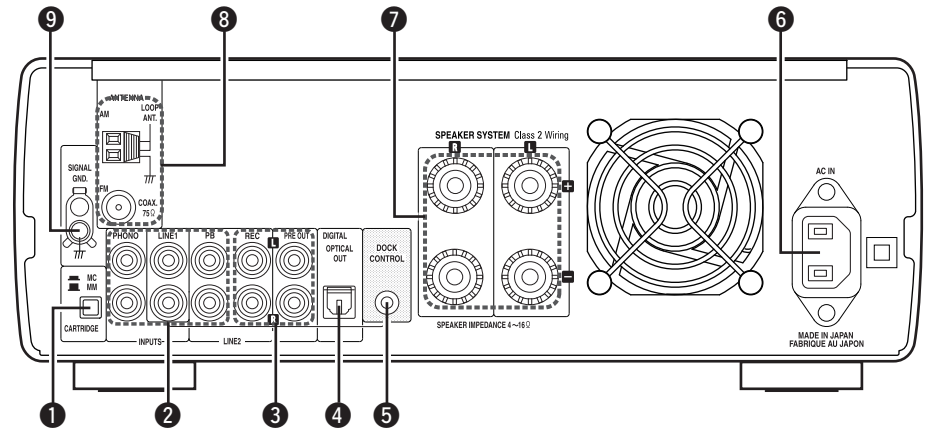

- 1 CARTRIDGE selection switch ..... (8)
- 2 Analog audio input connectors ..... (8, 9)
- 3 Analog audio output connectors ..... (9)
- 4 Digital audio output connector (OPTICAL OUT) ..... (9)
- 5 DOCK CONTROL jack ..... (9)
- 6 AC inlet (AC IN) ..... (10)
- 7 Speaker terminals (SPEAKER SYSTEM) ..... (8)
- 8 FM/AM antenna terminals ..... (10)
- 9 SIGNAL GND terminal ..... (8)



# Remote Control Unit

## Buttons Operable for All Functions (CD, PHONO, TUNER, LINE1, LINE2 and iPod)

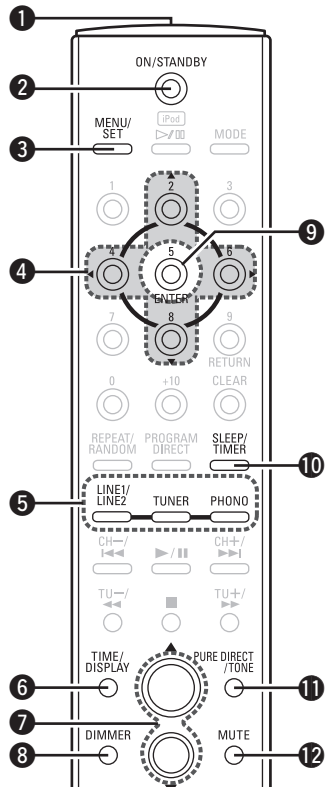

- 1 Remote control signal transmitter ..... (4)
- 2 ON/STANDBY button ..... (11)
- 3 MENU/SET button ..... (11)
- 4 Cursor buttons (2/Δ, 8/∇, 4/◀, 6/▷) ..... (11)
- 5 Function buttons (LINE1/LINE2, TUNER, PHONO) ..... (12)
- 6 TIME/DISPLAY button ..... (11)
- 7 Master volume control buttons (VOLUME) ..... (12)
- 8 DIMMER button ..... (13)
- 9 ENTER button (5/ENTER) ..... (11)
- 10 SLEEP/TIMER button ..... (22)
- 11 PURE DIRECT/TONE button ..... (13)
- 12 MUTE button ..... (13)

## Buttons Operable When the Function is Set to "CD"

The buttons listed at "Buttons Operable for All Functions" can also be used.

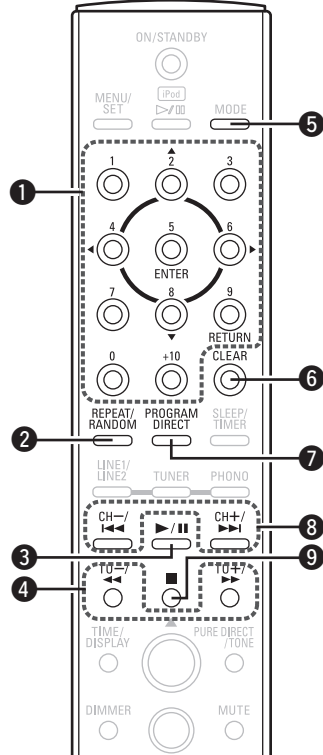

- 1 Number buttons ..... (14)
- 2 REPEAT/RANDOM button ..... (14)
- 3 Play/Pause button (▶/||) ..... (14)
- 4 Fast-reversing/Fast-forwarding buttons (TU-/◀◀, TU+/▶▶) ..... (14)
- 5 MODE button ..... (16)
- 6 CLEAR button ..... (15)
- 7 PROGRAM DIRECT button ..... (15)
- 8 Reverse-skip/Forward-skip buttons (CH-/◀◀, CH+/▶▶) ..... (14)
- 9 Stop button (■) ..... (14)

## Buttons Operable When the Function is Set to "TUNER"

The buttons listed at "Buttons Operable for All Functions" can also be used.

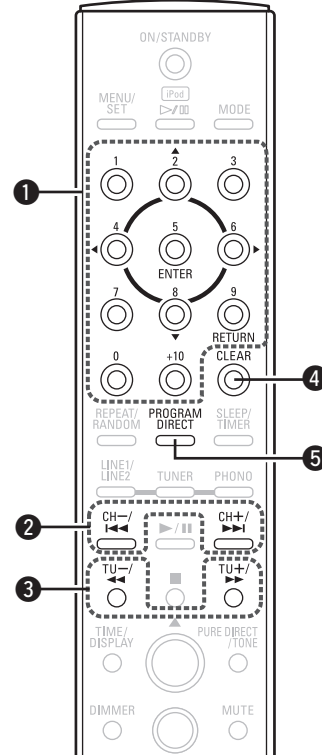

- 1 Number buttons ..... (17, 18)
- 2 Channel +, - buttons (CH-/◀◀, CH+/▶▶) ..... (17, 18)
- 3 Tuning +, - buttons (TU-/◀◀, TU+/▶▶) ..... (17)
- 4 CLEAR button ..... (18)
- 5 PROGRAM/DIRECT button ..... (17)

## Buttons Operable When the Function is Set to "iPod"

The buttons listed at "Buttons Operable for All Functions" can also be used.

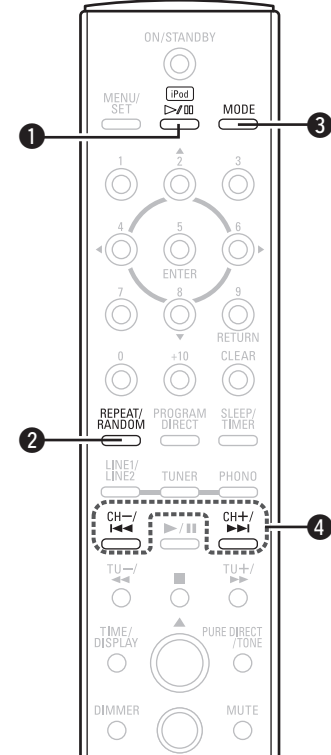

- 1 iPod ▶/|| button ..... (18)
- 2 REPEAT/RANDOM button ..... (18)
- 3 MODE button ..... (18)
- 4 Reverse-skip/Forward-skip / Fast-reversing/Fast-forwarding buttons (CH-/◀◀, CH+/▶▶) ..... (18)

# Connections

Connections for all compatible audio signal format is described in this operating instructions. Please select the types of connections suited for the equipment you are connecting.

With some types of connections, certain settings must be made on the RCD-CX1. For details, refer to the instructions for the respective connection items below.



**NOTE**

- Do not plug in the power cord until all connections have been completed.
- When making connections, also refer to the operating instructions of the other components.
- Be sure to connect the left and right channels properly (left with left, right with right).
- Do not bundle power cords together with connection cables. Doing so can result in humming or noise.

## Preparations

### Cables Used for Connections

Select the cables according to the equipment being connected.

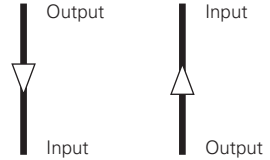
Audio cables	
<b>Optical digital connections</b>	 <p>Optical cable</p>
<b>Analog connections (stereo)</b>	 <p>(White) (Red)</p> <p>Stereo pin-plug cable</p>
<b>Speaker connections</b>	 <p>Speaker cables</p>
Signal direction	
Audio signal:	

### Using the AM Loop Antenna

- To use suspended on a wall**  
Suspend directly on the wall without assembling.

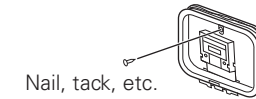

- To use standing alone**  
Use the procedure below to assemble.

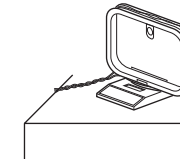

### Assembling the AM Loop Antenna

- 1** Bend in the direction of the arrow.



- 2** Insert into the hole.



# Speaker Connections

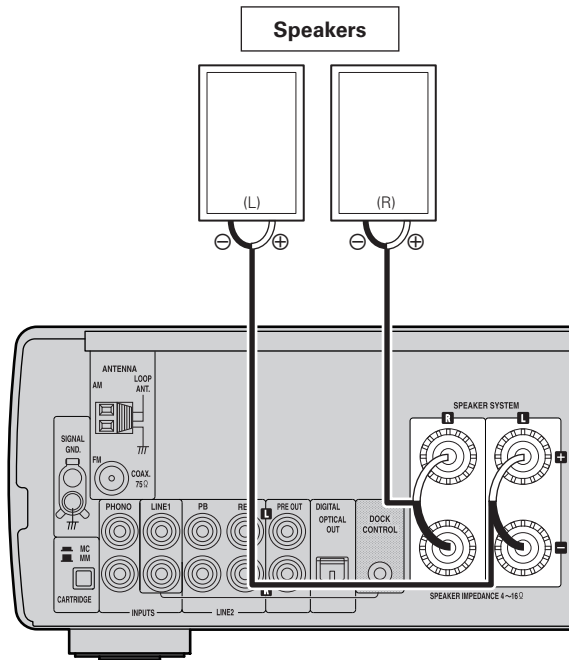

**NOTE**

- Use speakers with an impedance of 4 to 16 Ω/ohms. The protection circuit may be activated if speakers with an impedance other than specified are used.
- Connect the speaker cables in such a way that they do not stick out of the speaker terminals. The protection circuit may be activated if the core wires touch the rear panel or if the + and – sides touch each other (☞ “Protection circuit”).
- Never touch the speaker terminals while the power supply is connected. Doing so could result in electric shock.

**Protection circuit**

The protection circuit will be activated in the following cases:





- When the speaker cable’s core wires are touching the rear panel or screws or when the speaker cable’s + and – sides are touching
- When the surrounding temperature is extremely high
- When the internal temperature rises due to extended use with a high output

If this happens, unplug the power cord, then check the connections of the speaker cables and input cables. If the set’s temperature is extremely high, wait for it to cool off and improve surrounding ventilation. After doing this, plug the power cord back in.

If the protection circuit is activated though there are no problems in ventilation around the set or in connections, the set could be damaged. Turn off the power, then contact a DENON servicing and inquiry outlet.

## Connecting the Speaker Cables

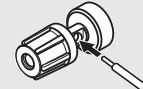
Carefully check the left (L) and right (R) channels and + (red) and – (black) polarities on the speakers being connected to the RCD-CX1, and be sure to interconnect the channels and polarities correctly.

- 1** Peel off about 10 mm of sheathing from the tip of the speaker cable, then either twist the core wire tightly or terminate it. 
- 2** Turn the speaker terminal counterclockwise to loosen it. 
- 3** Insert the speaker cable’s core wire to the hilt into the speaker terminal. 
- 4** Turn the speaker terminal clockwise to tighten it. 

# Connecting the Playback Components

## Record Player

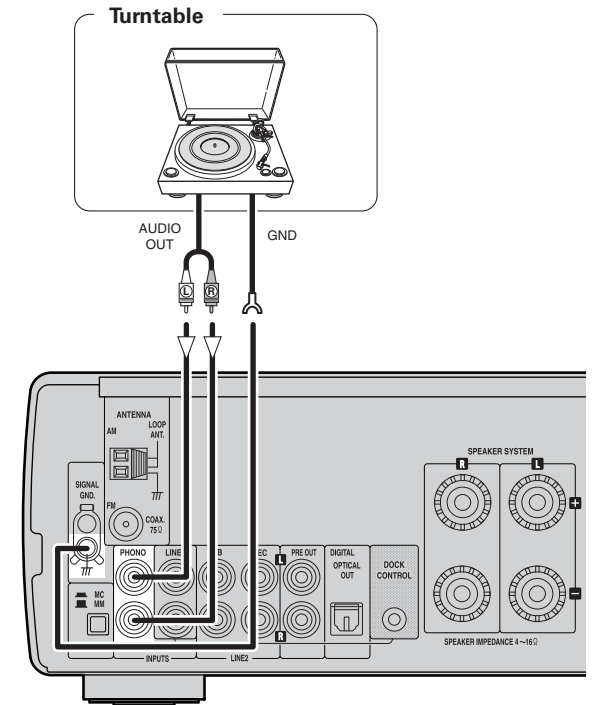

- With some record players, noise may be generated when the ground wire is connected. If so, disconnect the ground wire.
- Set the CARTRIDGE selection switch to “MM” or “MC” according to the cartridge being used.

**NOTE**

The RCD-CX1’s SIGNAL GND terminal is meant to reduce noise when a record player is connected. This is not a safety ground terminal.

**iPod®**

Use a DENON control dock for iPod (ASD-1R, ASD-11R or ASD-3N/3W, sold separately) to connect the iPod to the RCD-CX1.

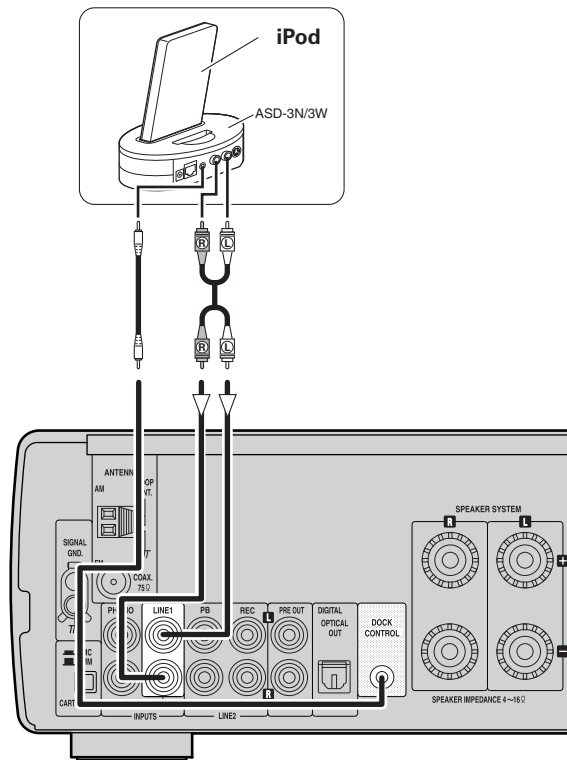

- When using a control dock for iPod, the Control Dock for iPod must be set. For details, refer to the operating instructions of the Control Dock for iPod.
- When the control dock for iPod is connected, the function indicator switches from "LINE1" to "iPod".
- To use an iPod, see "iPod® Playback" (page 18).

**Connecting a Power Amp and Subwoofer**

Use when adding a power amp, subwoofer, etc.

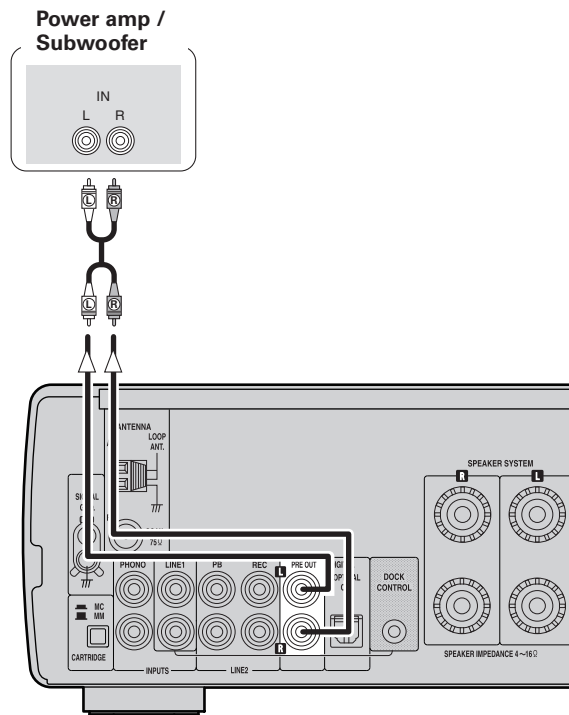

**NOTE**

DO NOT insert a short pin plug for recording output (REC) and pre-out terminals, as this may result in damage.

**Connecting the Recording Components**

**CD Recorder / MD Recorder / Tape Deck**

**Analog connections**

**Digital connections**

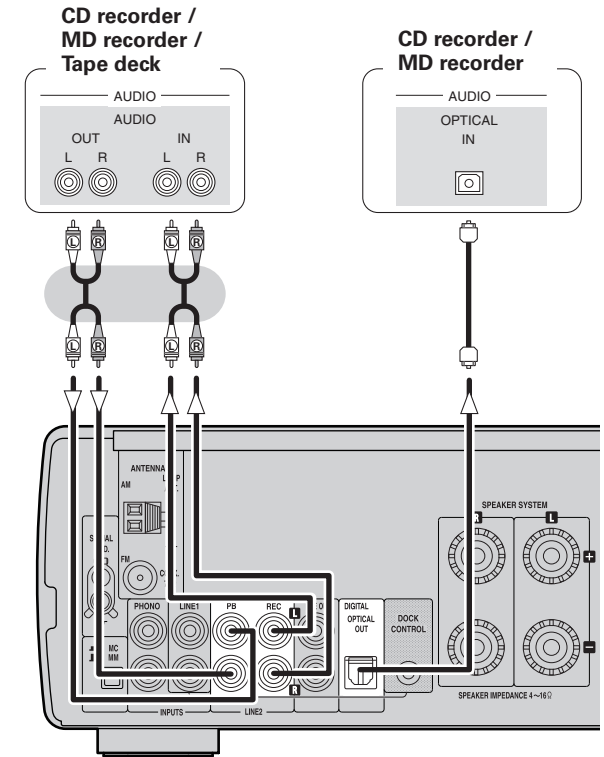

No digital signals are output for Super Audio CDs.

**When connecting the optical digital output connector with an optical transmission cable (sold separately)**

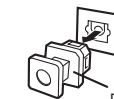

Protective cap

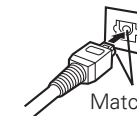

Match the shapes

Remove the protective cap, match the shapes, then insert firmly all the way in.



Store the protective cap in a safe place so as not to lose it, and use it when not using the terminal.

## Connections to Other Devices

### Antenna terminals

#### AM / FM

The AM and FM reception sensitivity depends on the place the antenna is set and the direction in which it is set. Set it so that reception is best.

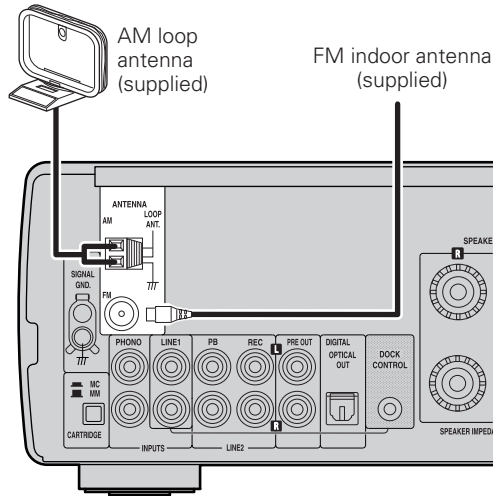

#### Connecting the AM loop antenna

- 1 Push the lever.
- 2 Insert the conductor.
- 3 Return the lever.

#### NOTE

- Make sure the AM loop antenna lead terminals do not touch metal parts of the panel.
- Do not connect two FM antennas simultaneously.

#### Note to CATV system installer:

This reminder is provided to call the CATV system installer's attention to Article 820-40 of the NEC which provides guidelines for proper grounding and, in particular, specifies that the cable ground shall be connected to the grounding system of the building, as close to the point of cable entry as practical.

## Connecting the Power Cord

Wait until all connections have been completed before connecting the power cord.

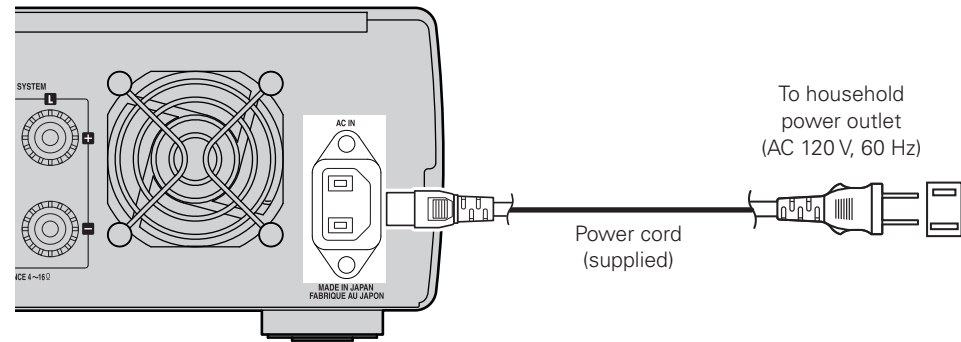

#### NOTE

- Insert the AC plugs securely. Incomplete connections could cause noise.
- When the power cord is plugged into the power outlet, the power indicator flashes orange for about 10 seconds. Do not unplug the power cord before the power indicator turns off and the RCD-CX1 enters Standby mode.
- Only use the supplied power cord.
- Be sure the power cord is unplugged from the power outlet before connecting or disconnecting it to the AC IN.

## Once Connections are Completed

### Turning the Power On (page 12)

# Setup

**Symbols used to indicate buttons in this manual**

- Button located on both the main unit and the remote control unit → **BUTTON**
- Button only on the main unit → **<BUTTON>**
- Button only on the remote control unit → **[BUTTON]**

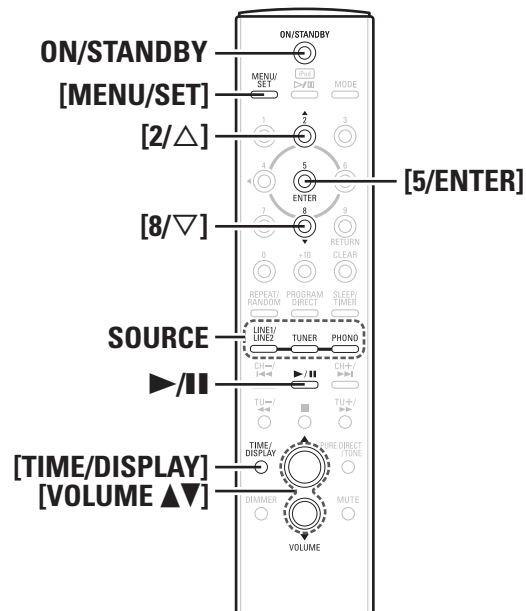
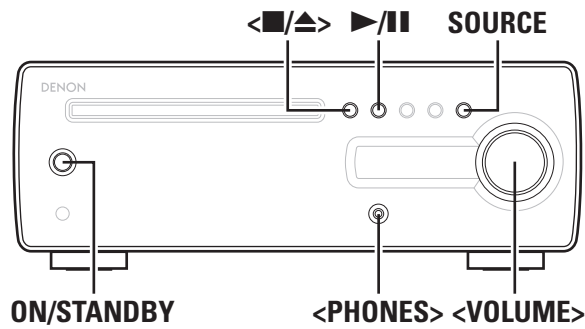

## Setting the Current Time (12-Hour Display)

**[Example]** Setting the current time to 10:15 am

- 1 Press ON/STANDBY to turn the power on.**
- 2 Press and hold in [TIME/DISPLAY].**  
The time is displayed.
- 3 Press and hold in [MENU/SET] to enter time setting mode.**  
"TIME Adj" is displayed for about 2 seconds.
- 4 Use [2/Δ] or [8/∇] to set the "hours".**
- 5 Press [MENU/SET] or [5/ENTER].**  
The "minutes" display flashes.
- 6 Use [2/Δ] or [8/∇] to set the "minutes".**
- 7 Press [MENU/SET] or [5/ENTER].**  
The current time is set, and the normal display reappears.

- Checking the current time when the power is on**  
Press and hold in [TIME/DISPLAY].  
Press once more and the display returns to its original condition.
- Checking the current time when the power is set to standby**  
Press [TIME/DISPLAY].  
Press once more, and the standby display is resumed.



Displaying the time when the power is set to standby consumes electricity. To reduce electric consumption, turn the time display off.

**NOTE**

The time cannot be set when in the standby mode. Turn on the power first.

# Playback

## Preparations

### Turning the Power On

#### Press ON/STANDBY.

- The power turns on. Press again to set the power to standby.
- When the power is turned on, the function that was being used when the power was last turned off is selected (☞ page 22 "Last function memory").

#### [When the last function was CD]

When no disc is loaded, "NO DISC" is displayed.

### Power indicator

Standby..... Off  
 Power on ..... Red  
 When the timer is set..... Orange

#### NOTE

- Power continues to be supplied to some of the circuitry even when the power is in the standby mode. When leaving home for long periods of time or when traveling, either press **ON/STANDBY** to turn off the power, or unplug the power cord from the power outlet.
- Be sure to stop playback before turning the power off.

#### ❑ Completely turning off the power

Unplug the power cord from the wall outlet.

- ※ Note that the time setting is cleared when the power cord is unplugged from the outlet.
- ※ The settings made for the various functions may be cleared if the power cord is left unplugged from a power outlet for an extended period of time.

### Setting the layer to be played with priority

- The layer that is played with priority when the disc is loaded can be set.
- Upon purchase, the priority layer is set to the "SA-CD".

#### 1 When "NO DISC" is displayed, press and hold [MENU/SET].

The current priority layer is displayed.

#### 2 Press [MENU/SET] again and select the layer to be played with priority.

SA-CD ← → CD

#### [Selectable items]

**SA-CD** : The SA-CD layer mode for Super Audio CDs.

**CD** : The CD layer mode for Super Audio CDs.



This setting is stored in the RCD-CX1's memory and is not canceled even when the disc tray is opened or closed or the power is turned on or off. To change the setting, perform the above procedure again.

### Loading Discs

#### In the stop mode, press <■/▲> to open the disc tray.

※ "Loading Discs" (☞ page 3).

#### ❑ To close the disc tray

Press <■/▲> again.

※ The disc tray also closes when ►/|| is pressed.

#### NOTE

- The power must be on when opening and closing the disc tray.
- Do not push the disc tray in by hand when the power is off. Doing so can damage it.
- Do not insert foreign objects into the disc tray. Doing so will damage it.

## Operations During Playback

### Adjusting the Master Volume

#### Either turn <VOLUME> or press [VOLUME ▲▼].

The volume level is displayed.

[Variable range] **-90.0dB** ~ **0.0dB**

※ When lowering the volume from -90.0 dB, the display shows "--. dB".

### Input Source Switching

#### Press SOURCE to select input source.

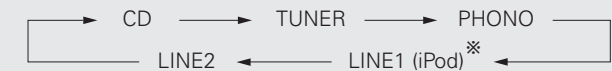

※ The "iPod" indicator is displayed when a Control Dock for iPod is connected. ("NO iPod" is displayed if no iPod is connected to the Control Dock for iPod.)

### Listening with Headphones

#### Plug the headphones (sold separately) into the <PHONES>.

※ The sound from the speakers is automatically cut off.

#### NOTE

Be careful not to set the volume too high when using headphones.



**Symbols used to indicate buttons in this manual**

Button located on both the main unit and the remote control unit → **BUTTON**  
 Button only on the main unit → **<BUTTON>**  
 Button only on the remote control unit → **[BUTTON]**

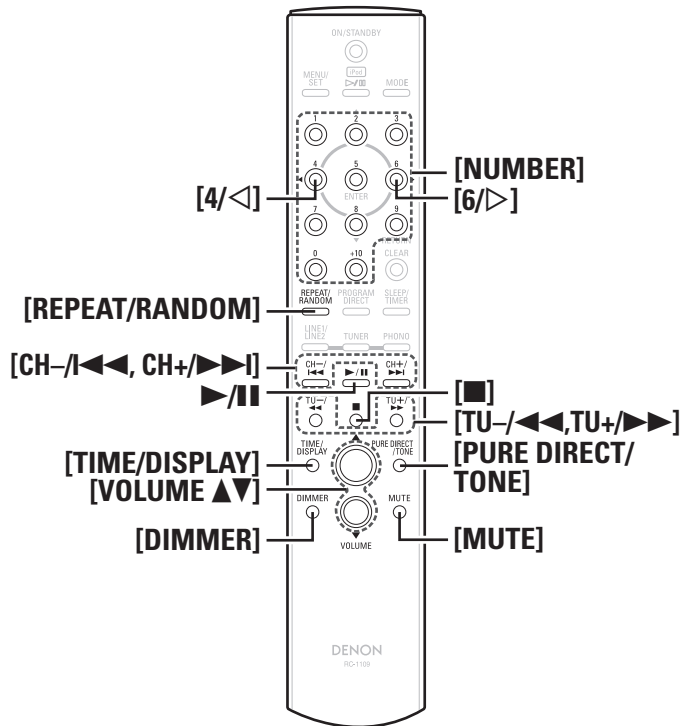
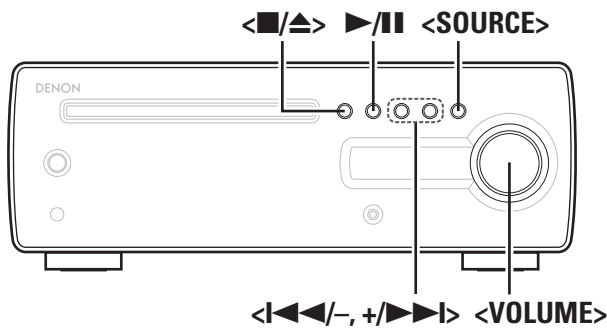

### Adjusting the Tone

**1** Press **[PURE DIRECT/TONE]** and select the mode you want to adjust.



**2** Adjust the volume with **[4/◀, 6/▶]**.

※ Thereafter, to adjust another mode, press **[PURE DIRECT/TONE]**.  
 ※ If no operation is performed for 3 seconds, the adjustment is retained and the normal display reappears.

#### [Selectable modes]

**Pure D (PURE DIRECT)** : This is the mode that recreates the original sound most faithfully, providing extremely high quality sound.

[Selectable items] **on** **off**

**BASS** : Adjusts the bass sound.  
 [Variable range] **-8dB** ~ **+8dB**

**TREBLE** : Adjusts the treble sound.  
 [Variable range] **-8dB** ~ **+8dB**

**BALANCE** : Adjusts the left/right volume balance.  
 [Variable range] **+L10** ~ **CENTER** ~ **+R10**

Press **[4/◀]** when you want to adjust the left channel, and **[6/▶]** when you want to adjust the right channel.

- Settings made upon purchase:
- Pure D (PURE DIRECT) .....off
  - BASS .....0dB
  - TREBLE .....0dB
  - BALANCE ..... CENTER

When "Pure D" is set to "on", digital output is switched off. What is shown on the display also goes off. (When not playing or when no disc is loaded, only part of the display is shown.)

**NOTE**

- When "Pure D" is set to "on", you cannot set "BASS", "TREBLE" or "BALANCE".
- When "Pure D" is set to "on", you cannot use **[DIMMER]**.

### Turning the Sound Off Temporarily (Muting)

Press **[MUTE]**.  
 The "Mute on" is displayed.

To cancel, press **[MUTE]** again.  
 (The mute mode is also canceled when the **<VOLUME>** is turned or a **[VOLUME ▲▼]** is pressed.)

### Switching the Brightness of the Display



※ The display's brightness switches each time the button is pressed.

## CD Playback

### Playing CDs

#### Press ►/II.

The "►" indicator lights and playback begins.



- If the function is set to something other than "CD," press ►/II to switch the function to "CD" and start playback (see page 22 "Auto Function Selector Function").
- The function can also be switched to "CD" using <SOURCE>.

#### NOTE

It is not possible to switch to a layer not recorded on the disc.

#### ❑ Stopping playback

Press <■/▲> or [■].

#### ❑ Stopping playback temporarily

Press ►/II.

The "III" indicator lights.

- ※ To resume playback, press ►/II.

#### ❑ Fast-forwarding and fast-reversing (searching)

During playback, press and hold in [TU -/◀◀, TU +/▶▶].

The "►" indicator flashes.

- ※ Normal playback resumes when the button is released.



The sound may be interrupted for a brief moment when resuming normal playback after searching.

#### ❑ Moving to the beginning of tracks (skipping)

During playback, press <|◀◀/-, +/▶▶|> or [CH -/◀◀, CH +/▶▶|].

- ※ The disc is skipped the number of tracks equal to the number of times the button is pressed.
- ※ When pressed once in the return direction, playback returns to the beginning of the currently playing track.

#### ❑ To play the desired track (remote control unit only)

Press [NUMBER] (0 ~ 9, +10) to select the track.

[Example] : Track 4 : [4]

[Example] : Track 12 : [+10] [2]

[Example] : Track 20 : [+10] [+10] [0]

### Switching the Display

Press [TIME/DISPLAY].

[During Play or Pause]

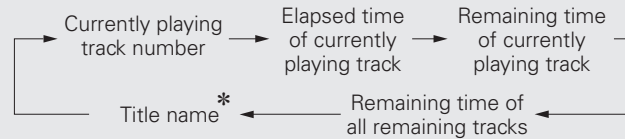

[During Stop]

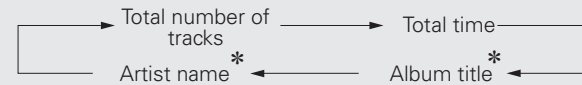

- \* Displayed only when Super Audio CD is in use.

※ The display switches each time the button is pressed.



When a Super Audio CD with no recorded text information is loaded, "NO TEXT" is displayed when you select "Title name," "Album title" or "Artist name".

### Repeat Play or Random Play

Press [REPEAT/RANDOM].

[During Stop]



When setting is completed, press ►/II to play.

[During Play]

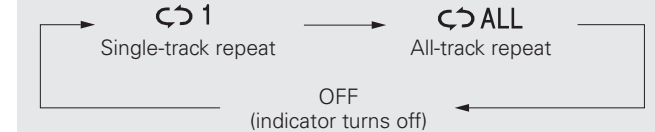

※ The display switches each time the button is pressed.

[Selectable items]

↻ 1  
(Single-track repeat) : Only 1 track is played repeatedly.

↻ ALL  
(All-track repeat) : All tracks are played repeatedly.

RND  
(Random) : Tracks are selected and played automatically in random order.

RND ↻ 1  
(Single-track random repeat) : Automatically selected single-track is played repeatedly.

RND ↻ ALL  
(Random Repeat) : All the tracks are played once in random order, then played again repeatedly, each time in a different random order.

OFF  
(indicator turns off) : Normal playback resumes.

#### NOTE

- Random play cannot be set or canceled during playback.
- Direct searching is not possible during random playback.

**Symbols used to indicate buttons in this manual**

Button located on both the main unit and the remote control unit → **BUTTON**  
 Button only on the main unit → **<BUTTON>**  
 Button only on the remote control unit → **[BUTTON]**

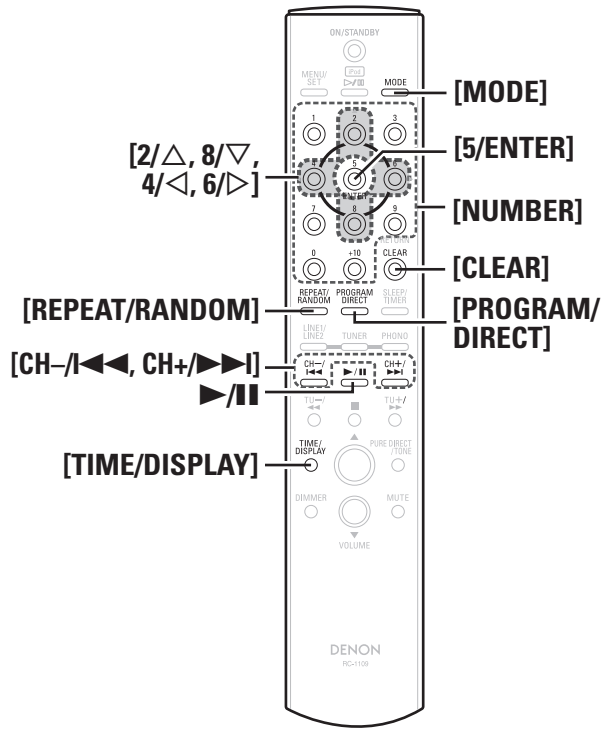
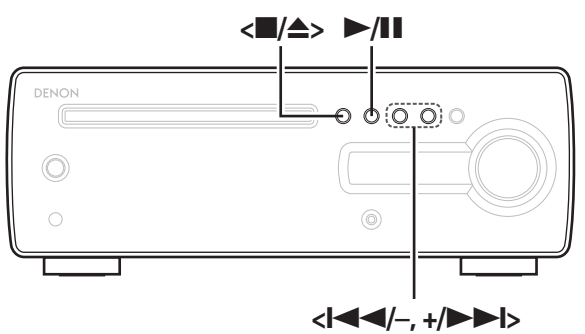

- To cancel random play and repeat play**  
 During stop, press **[REPEAT/RANDOM]** until displays of "↺ 1", "↺ ALL", "RND", "RND ↺ 1", "RND ↺ ALL" are unlit.  
 ※ You can cancel even if you press **<■/▲>** to open the disc tray.

**Playing Tracks in the Desired Order**  
**<Program>**  
 Up to 20 tracks can be programmed.

- 1 In the stop mode, press [PROGRAM/DIRECT].**  
 The "PROG" indicator lights.
- 2 Use [NUMBER] (0 ~ 9, +10) to select the tracks.**  
 ※ **Example :** To program tracks 3, 12, 7 to play in that order:  
 Press **[PROGRAM/DIRECT], [3], [+10], [2], [7]**.
- 3 Press <▶/⏸>.**  
 Playback starts in the programmed order.

- Checking the order of the programmed tracks**  
 In the stop mode, press **<+ />** or **[CH + />]**.  
 The track numbers are displayed in the programmed order each time the button is pressed.

- To delete programmed tracks one track at a time**  
 In the stop mode, press **[CLEAR]**.  
 The last track programmed is cleared each time the button is pressed.

- Clearing the all programmed track**  
 In the stop mode, press **[PROGRAM/DIRECT]**.  
 The "PROG" indicator turns off.  
 ※ You can cancel even if you press **<■/▲>** to open the disc tray.

**NOTE**  
 " - : - : - " is displayed if the total programmed time exceeds 99 minutes, 59 seconds.

- NOTE**
- Direct searching is not possible during programmed playback.
- Programmed playback is not possible with MP3 and WMA files.

**Playback of MP3 and WMA Files**

There are many music distribution sites on the Internet allowing you to download music files in MP3 or WMA (Windows Media® Audio) format. The music (files) downloaded from such sites can be stored on CD-R or CD-RW discs and played on the RCD-CX1.

"Windows Media" and "Windows" are registered trademarks or trademarks in the United States and other countries of Microsoft Corporation of the United States.

**About the MP3 and WMA Formats that can be Played**

CD-R and CD-RW discs created in the format described below can be played.

**Writing software format**

ISO9660 level 1  
 ※ When written in other formats, it may not be possible to play the disc properly.

**Maximum number of playable files and folders**

Total number of folders + files : 1000  
 Maximum number of folders : 255

**File format**

MPEG-1 Audio Layer-3  
 WMA (Windows Media Audio)

Playable MP3/WMA file			
File format	Sampling frequency	Bit rate	Extension
MP3	32, 44.1, 48 kHz	32 ~ 320 kbps	.MP3
WMA	32, 44.1, 48 kHz	64 ~ 160 kbps	.WMA

- With the RCD-CX1, the folder and file names can be displayed like titles. Up to 8 characters consisting of numbers, letters and the underscore can be displayed. Characters that cannot be displayed are replaced with asterisks.
- Copyright-protected files cannot be played. Note that depending on the software used for burning and other conditions, some files may not play or display correctly.
- JPEG and DivX® files are handled as files but cannot be played.



- Be sure to give files the extension ".MP3" or ".WMA". Files with any other extensions or with no extensions cannot be played.
- Recordings you have made should only be used for your personal enjoyment, and as per copyright laws may not be used in other ways without permission of the copyright holder.

## Playing MP3 and WMA Files

**1** Load a CD-R or CD-RW disc containing music files in the MP3 or WMA format into the disc tray (page 3).

**2** Press **[MODE]** and select "Folder Mode" or "Disc Mode".

**Folder mode :**

The "WMA" or "MP3" indicator flashes.  
The files in the selected folder are played.

**Disc mode :**

The "WMA" or "MP3" indicator lights.  
All the files on the disc are played.

**3** Use **[2/Δ, 8/∇]** to select the folder to be played.

**4** Use **<|◀◀/-, +/▶▶|>**, **[4/◀, 6/▶]** or **[CH -/|◀◀, CH +/▶▶|]** to select the file to be played.

**5** Press **▶/||** or **[5/ENTER]**.  
Playback starts.

**To switch the folder or file during playback**

• **Folder**

Use **[2/Δ, 8/∇]** to select the folder.

※ When a folder is selected, playback switches to the first track of the selected folder.

• **File**

Use **<|◀◀/-, +/▶▶|>** or **[CH -/|◀◀, CH +/▶▶|]** to select the file, or use **[4/◀, 6/▶]** to select the file number.

※ The file numbers are set automatically when the disc is loaded.

**Switching the display**

Press **[TIME/DISPLAY]** during play or pause.

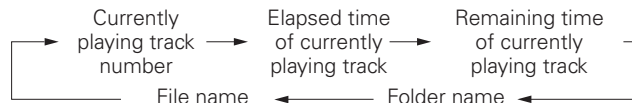

※ In the stop mode, only the total number of tracks is displayed.

## Repeat Play or Random Play

### Using the folder mode

Press **[REPEAT/RANDOM]**.

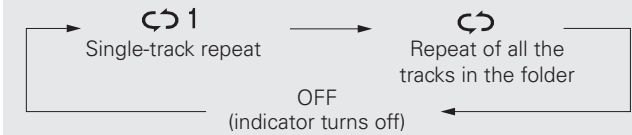

※ The display switches each time the button is pressed.

### [Selectable items]

**↻ 1 (Single-track repeat)** : Only the selected track is played repeatedly.

**↻ (Repeat of all the tracks in the folder)** : All the files in the selected folder are played repeatedly.

**OFF (indicator turns off)** : Folder mode playback resumes.

**NOTE**

- Random playback is not possible in the folder mode.
- Programmed playback is not possible with MP3/WMA discs.

### Using the disc mode

Same as setting method for CD.  
See "Repeat Play or Random Play" (page 14).

**NOTE**

Programmed playback is not possible with MP3/WMA discs.

**Symbols used to indicate buttons in this manual**

Button located on both the main unit and the remote control unit → **BUTTON**  
 Button only on the main unit → **<BUTTON>**  
 Button only on the remote control unit → **[BUTTON]**

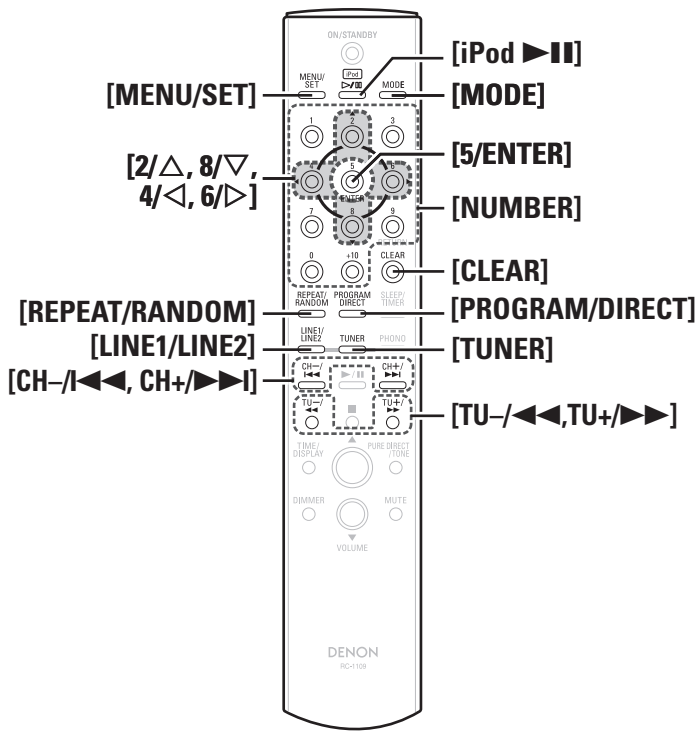
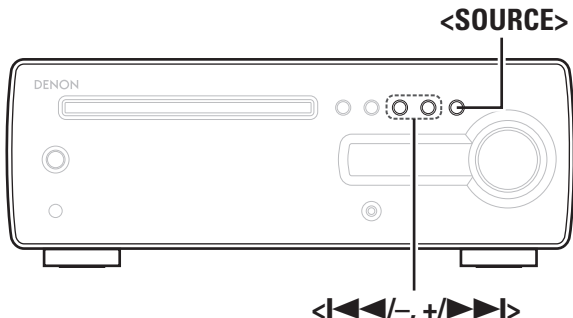

## TUNER Playback

### Tuning in Broadcast Stations

Connect the antenna beforehand (☞ page 10).

**1** Press **[TUNER]** to select the reception band.

→ FM AUTO → FM MONO → AM →

**[About the display]**  
 When "FM AUTO" is selected....."AUTO" is displayed.  
 When "FM MONO" is selected ..... "MONO" is displayed.  
 When "AM" is selected .....The reception mode is not displayed.

**2** Use **[TU -/|<<<, TU +/|>>>]** to select the reception band.  
 When a station is received, the "TUNED" indication will light.

- If the function is set to something other than "TUNER", press **[TUNER]** to switch the function to "TUNER" (☞ page 22 "Auto Function Selector Function").
- The function can also be switched to "TUNER" using **<SOURCE>**.

- To tune automatically**  
 Press and hold in **<|<<<|-, +/|>>>|>** or **[TU -/|<<<, TU +/|>>>]** to automatically search and tune in broadcast stations.  
 ※ Stations whose signal is weak cannot be tuned in.
- To stop auto tuning**  
 Press **<|<<<|-, +/|>>>|>** or **[TU -/|<<<, TU +/|>>>]**.
- To tune manually**  
 The reception frequency switches each time **[TU -/|<<<, TU +/|>>>]** is pressed.

A humming sound may be heard when using a TV nearby while receiving AM programs. If this happens, move the system as far from the TV as possible.

### About the FM Broadcast Reception Status Display

When the reception band mode is set to "FM AUTO", the "ST" indicator lights when a stereo broadcast is tuned in.

If the signal is weak and stable stereo reception is not possible, select "FM MONO" to receive in monaural.

### Automatically Presetting FM Stations (Auto Preset)

Up to 40 stations can be preset.  
 Auto preset is not possible with AM broadcast stations.

- 1** Press **[TUNER]** to select "FM AUTO" or "FM MONO".
- 2** Press and hold in **[MENU/SET]**.  
 "A.PRESET" flashes.
- 3** Press **[MENU/SET]** again.  
 Broadcast stations are preset automatically.

- Broadcast stations whose antenna signal are weak cannot be preset automatically. If you wish to preset such stations, tune them in manually.
- Once auto presetting starts, it cannot be stopped before it is completed. (It takes about 30 seconds for auto presetting to be completed.)

### Presetting FM/AM Stations Manually

Up to 40 stations (total for FM and AM) can be preset.

- 1** Tune in the station.
- 2** Press **[PROGRAM/DIRECT]**.  
 The minimum number display "P--" for the unregistered preset flashes.
- 3** Select the number to be preset using **[NUMBER]** (0 ~ 9, +10) or **[CH -/|<<<, CH +/|>>>]** and press **[PROGRAM/DIRECT]**.  
 The reception frequency and reception mode are preset.

## Listening to Preset Stations

Use **[NUMBER]** (0 ~ 9, +10) or **[CH -/|◀◀, CH +/▶▶|]** to select the preset number.

## Naming the Currently Tuned in Broadcast Station

Names of up to 8 characters can be input.

**1** Press **[MENU/SET]** three times.

**2** Press **[2/△]** or **[8/▽]**.  
The name input mode is set.

**3** Use **[2/△, 8/▽]** to select the character, then press **[6/▷]** to set.

※ Characters that can be input.

A to Z, 0 to 9, ^ ' ( ) \* + , - . / = (space)

※ Press **[4/◀, 6/▷]** to move the cursor.

※ Press **[CLEAR]** to delete characters.

**4** When the name has been entered, press **[5/ENTER]** to confirm the entry.



If a preset number has not been registered for the broadcast station you have entered, you are prompted to enter it now. Set the number to be preset using **[CH -/|◀◀, CH +/▶▶|]**.

### □ Changing the Broadcast Station Name

- ① Call out the preset name to be changed, then press **[MENU/SET]** three times.
- ② Use **[4/◀, 6/▷]** to select the character to be changed, then press **[CLEAR]**.
- ③ Perform step 3 and 4 at "Naming the Currently Tuned in Broadcast Station".

## iPod® Playback

With the RCD-CX1, you can listen to music on an iPod. It is also possible to operate the iPod from the main unit or remote control unit.



iPod is a trademark of Apple Inc., registered in the U.S. and other countries.

※ The iPod may only be used to copy or play contents that are not copyrighted or contents for which copying or playback is legally permitted for your private use as an individual. Be sure to comply with applicable copyright legislation.

## Preparations

**1** Set the iPod on the DENON Control Dock for iPod.  
(See the control dock for iPod's operating instructions.)

**2** Press **<SOURCE>** or **[LINE1/LINE2]** to select "iPod".

**3** Press **[MODE]** to select the display mode.  
The mode switches each time the button is pressed.

[Selectable mode]		Browse mode	Remote mode
Display location		Main unit display	iPod display
Playable files	Audio file	○	○
	Video file	×	○*
Active buttons	Remote control unit (RCD-CX1)	○	○
	iPod	×	○

\*: Video may not be output, depending on the combination of ASD-1R and iPod.

## Listening to Audio

**1** Use **[2/△, 8/▽]** to select the item, then press **[5/ENTER]** to select the music file to be played.

**2** Press **[iPod ▶/||]**.  
Playback starts.



- If the function is set to something other than "iPod", press **[iPod ▶/||]** to switch the function to "iPod" and start playback. (See page 22 "Auto Function Selector Function")
- The function can also be switched to "iPod" using **<SOURCE>** or **[LINE1/LINE2]**.

### □ Stopping playback temporarily

During playback, press **[iPod ▶/||]**.  
Press again to resume playback.

### □ Fast-forwarding or fast-reversing

During playback, either press and hold **[CH-/|◀◀]** or **[CH+/▶▶|]**.

### □ To cue to the beginning of a track

During playback, press **[CH-/|◀◀]** or **[CH+/▶▶|]**.

### □ To perform Repeat/Random playback (Browse mode only)

Press **[REPEAT/RANDOM]**.



### □ To switch between the Browse and Remote modes

Press **[MODE]**.



**Symbols used to indicate buttons in this manual**

Button located on both the main unit and the remote control unit → **BUTTON**  
 Button only on the main unit → **<BUTTON>**  
 Button only on the remote control unit → **[BUTTON]**

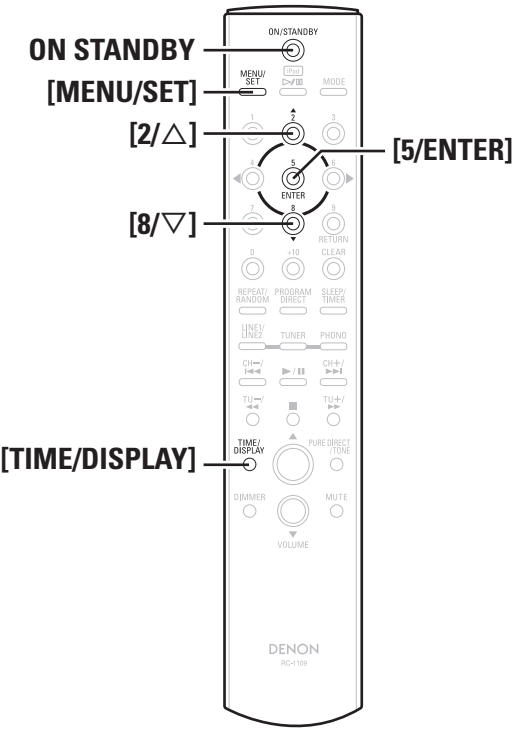
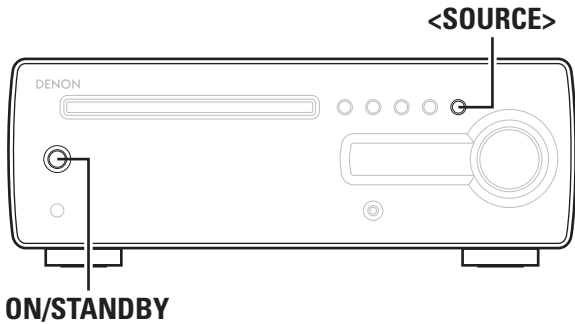

**Browse mode**

Operating mode that shows iPod information on the RCD-CX1 display. In this mode, it is not possible to operate the iPod directly or to perform the operations associated with the slide show function. Set the Remote mode to play slide shows.

**Remote mode**

This mode is for operating the iPod directly while watching the information displayed on the iPod's screen.



Also see the control dock for iPod operating manual regarding connection and operation.

**NOTE**

- DENON will accept no responsibility whatsoever for any loss of iPod data.
- Depending on the type of iPod and the software version, some functions may not operate.

**To Switch the Display**

During playback, press **[TIME/DISPLAY]**. The display switches each time the button is pressed.

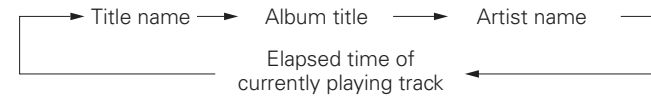

**Disconnecting the iPod**

- 1 Press **ON/STANDBY** to set the standby mode.
- 2 Remove the iPod from the control dock for iPod.

**Recording**

**Recording on an External Device**

First connect the device from which you want to record to the RCD-CX1 (page 9).

- 1 Press **<SOURCE>** to choose the input source to be recorded.
- 2 Set the recorder to the recording mode.
  - ※ For instructions on operating, see the operating instructions of the connected component.
- 3 Start playback on the player.
  - ※ For instructions on operating, see the operating instructions of the connected component.



- The LINE2 input signal is not output to the recording output terminal (REC).
- Adjusting the volume or tone does not affect the sound being recorded.



# Setting the Timer

## Timer Playback

The everyday timer, once timer and sleep timer can be set.

### Timer order of priority

The order of priority when the times set for the different timers overlap is as follows:

1. Sleep timer
2. Once timer
3. Everyday timer



If the current time is not set, enter timer setting mode to get time setting mode.

### Setting the Timer

#### • Everyday timer playback

Playback starts (the power turns on) and stops (the power turns off) at the set times each day.

#### • Once timer playback

Playback starts (the power turns on) and stops (the power turns off) once only at the set times.

**1** Press [MENU/SET].  
The "TIMER" is displayed.

**2** Use [2/△, 8/▽] to select the timer play mode.  
ONCE ↔ EVERYDAY

EVERYDAY

**3** Press [MENU/SET] or [5/ENTER].  
Timer playback mode is set, and "FUNC" is displayed.

**4** Use [2/△, 8/▽] to select the function to be played.



※ "iPod" is displayed only when control dock for iPod is connected.



**5** Press [MENU/SET] or [5/ENTER].  
The function to be played is set.

※ In the case of functions other than tuner, "ON" is displayed and the display advances to step 7.

**6** [Only when the "TUNER" function is selected]  
-① Use [2/△, 8/▽] to select the preset number.

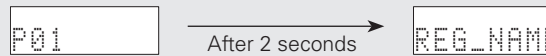

※ When no name has been registered for the selected preset number, the program service or frequency appears after the preset number is displayed.

-② Press [MENU/SET] or [5/ENTER].  
The station of the selected preset number is set, and "ON" is displayed.

**7** Use [2/△, 8/▽] to set the "hours" for the timer start time.



**8** Press [MENU/SET] or [5/ENTER].  
The "hours" for the timer start time are set.

**9** Use [2/△, 8/▽] to set the "minutes" for the timer start time.



**10** Press [MENU/SET] or [5/ENTER].  
The "minutes" for the timer start time are set and "OFF" is displayed.

**11** Use [2/△, 8/▽] to set the "hours" for the timer stop time.



**12** Press [MENU/SET] or [5/ENTER].  
The "hours" for the timer stop time are set.

**13** Use [2/△, 8/▽] to set the "minutes" for the timer stop time.



**14** Press [MENU/SET] or [5/ENTER].  
The "minutes" for the timer stop time are set.

**15** Use [2/△, 8/▽] to turn timer playback on.

Display	Once timer	Everyday timer
1__ / E__	OFF	OFF
1on / Eon	ON	ON
1__ / Eon	OFF	ON
1on / E__	ON	OFF

**16** Press [MENU/SET] or [5/ENTER].  
The timer setting is set.

**17** Set the power to standby.  
Timer playback standby mode is set, and the power indicator lights orange.

**Symbols used to indicate buttons in this manual**

Button located on both the main unit and the remote control unit → **BUTTON**  
 Button only on the main unit → **<BUTTON>**  
 Button only on the remote control unit → **[BUTTON]**

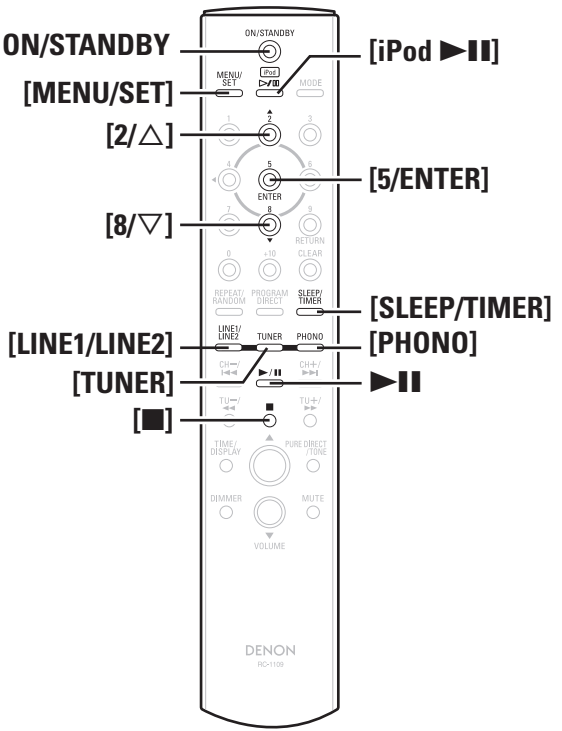
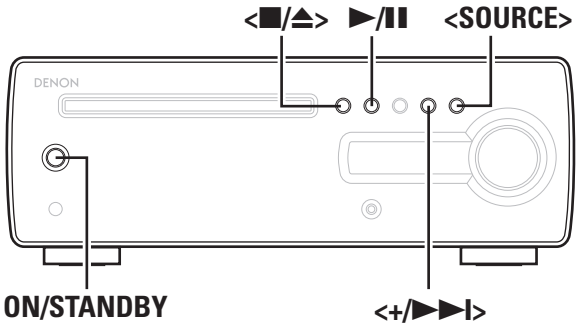

**To check the timer settings**

- Press **[MENU/SET]**.  
The "TIMER" is displayed.
- Press **[2/Δ, 8/∇]**.  
The "EVERYDAY" or "ONCE" is displayed.
- Press **[MENU/SET]**.  
The display switches as follows each time the button is pressed:  

Function selection	→	Timer On time
Timer ON/OFF	←	Timer Off time

**To change the timer settings**

Repeat the procedure under "Setting the Timer" (page 20).

**To change the setting while setting the timer**

- Press **<MUTE>** or **[MUTE]**.  
 Return to step 2 under "Setting the Timer" (page 20). Repeat the procedure.

**NOTE**

During setting, you can change with **<MUTE>** or **[MUTE]** up to step 14.

**To clear the timer settings**

- Press **[MENU/SET]**.  
The "TIMER" is displayed.
- Press **[2/Δ, 8/∇]**.  
The "EVERYDAY" or "ONCE" is displayed.
- While "EVERYDAY" or "ONCE" is displayed, press **<MUTE>** or **[MUTE]** for at least 2 seconds.

**If there is a power failure**

- The current time setting is canceled. Turn the power on and reset the current time (page 11).
- The timer settings are cleared. Set the timer again.
- The tuner's presets may be cleared. If so, perform the presetting procedure again.

**When performing a timer setting with DENON control dock for iPod (ASD-3N or ASD-3W)**

Pause the track you want to play, and keep the power on for DENON control dock for iPod.

**Set the Timer ON/OFF**

After setting with "Setting the Timer" (page 20), you can set timer on/off for timer operations you want to perform.

**1 Press [MENU/SET] twice or press and hold [SLEEP/TIMER].**

The current settings are displayed.

**2 Press [2/Δ, 8/∇] and select the timer for the timer operation you want.**



\* In "Setting the Timer" (page 20), in the case of reserving Everyday Timer only, the change is as follows when you press **[2/Δ, 8/∇]**.

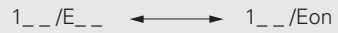

\* In "Setting the Timer" (page 20), in the case of reserving Once Timer only, the change is as follows when you press **[2/Δ, 8/∇]**.

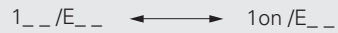

**3 Press [MENU/SET] or [5/ENTER].**

The timer setting is set.

**4 Press ON/STANDBY to set the RCD-CX1 to Standby mode.**

The power indicator lights orange.

## Setting the Sleep Timer

Use this function to automatically switch the power to the standby mode after a specific amount of time (minutes).  
The sleep timer can be set to up to 90 minutes, in steps of 10 minutes.

### 1 Select and play the desired function.

### 2 Press [SLEEP/TIMER] and select the setting time.

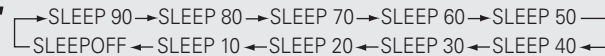

※ After about 5 seconds, the set returns to as it was before the sleep timer was set.

#### ❑ Canceling the sleep timer

Either press [SLEEP/TIMER] at step 2 under "Setting the Sleep Timer" until "SLEEPOFF" is displayed, or press ON/STANDBY.

#### ❑ Checking the time remaining until the sleep timer starts

Press [SLEEP/TIMER].

# Other Functions

## Convenient Functions

### Auto Power On

When the power is in standby, the power turns on when any of the buttons below other than ON/STANDBY is operated, and the respective operation is performed.

- <■/▲> ..... The disc tray opens.
- ▶/|| ..... Playback of that source starts.
- [TUNER] ..... Playback of the tuner starts.
- [■] ..... Change the function to "CD" and switch the power on.
- [PHONO] ..... Change the function to "PHONO" and switch the power on.
- [LINE1/LINE2] ..... Change the function to the finally set "LINE" and switch the power on.

#### NOTE

When the iPod can be played, press [iPod ▶/||] to start iPod playback.

### Auto Function Selector Function

When one of the buttons below is pressed, the function switches to the respective function and playback of that source starts.

- ▶/|| ..... The function switches to "CD" and the CD starts playing.
- [■] ..... The function switches to "CD" and the stop.
- [iPod ▶/||] ..... The function switches to "iPod" and the iPod starts playing.
- [TUNER] ..... The functions switches to "TUNER" and the band last set is tuned in.

### Last Function Memory

This stores the settings as they were directly before the standby mode was set.

When the power is turned back on, the settings are restored to as they were directly before the standby mode was set.

### Resetting the Microprocessor

Perform this procedure if the display is abnormal or if operations cannot be performed.

When the microprocessor is reset, all the settings are reset to their default values.

#### 1 Unplug the power cord.

#### 2 Plug the power cord into a power outlet while pressing <+ / ▶▶▶> and <SOURCE> simultaneously.

After about 15 seconds "RESET" is displayed to indicate that the microprocessor has been reset.



If "RESET" is not displayed in step 2, start over from step 1.

# Troubleshooting

If a problem should arise, first check the following:

1. Are the connections correct?
2. Is the set being operated as described in the owner's manual?
3. Are the other components operating properly?

If this unit does not operate properly, check the items listed in the table below. Should the problem persist, there may be a malfunction.

In this case, disconnect the power immediately and contact your store of purchase.

**[General]**

Symptom	Cause	Countermeasure	Page
Set does not operate properly.	<ul style="list-style-type: none"> <li>• External noise or interference is causing the set to malfunction.</li> </ul>	<ul style="list-style-type: none"> <li>• Reset the microprocessor.</li> </ul>	22
When the power is turned on, the power indicator does not light and no sound is produced.	<ul style="list-style-type: none"> <li>• Connection of the power cord is faulty.</li> </ul>	<ul style="list-style-type: none"> <li>• Check that the power plugs are securely inserted into the RCD-CX1's AC inlet and the wall power outlet.</li> </ul>	10
The power indicator lights but no sound is produced.	<ul style="list-style-type: none"> <li>• The speaker cables are not properly connected.</li> <li>• The function (input) is incorrect.</li> <li>• The volume is set too low.</li> </ul>	<ul style="list-style-type: none"> <li>• Connect securely.</li> </ul>	8
		<ul style="list-style-type: none"> <li>• Switch to the correct function (input).</li> </ul>	12
		<ul style="list-style-type: none"> <li>• Adjust the volume to an appropriate level.</li> </ul>	12
No sound is produced from one side.	<ul style="list-style-type: none"> <li>• The speaker cables are not properly connected.</li> <li>• The input cables are not properly connected.</li> <li>• The left/right balance is off.</li> </ul>	<ul style="list-style-type: none"> <li>• Connect securely.</li> </ul>	8
		<ul style="list-style-type: none"> <li>• Connect securely.</li> </ul>	8, 9
		<ul style="list-style-type: none"> <li>• Adjust the left/right balance.</li> </ul>	13
For stereo sources, the positions of the instruments are inverted.	<ul style="list-style-type: none"> <li>• The connections of the speaker cables or input cables are inverted.</li> </ul>	<ul style="list-style-type: none"> <li>• Check and remedy the connections.</li> </ul>	8 ~ 10

**[CD]**

Symptom	Cause	Countermeasure	Page
Disc tray does not open.	<ul style="list-style-type: none"> <li>• The power is not on.</li> </ul>	<ul style="list-style-type: none"> <li>• Turn on the power.</li> </ul>	12
"NO DISC" is displayed even though a disc is loaded.	<ul style="list-style-type: none"> <li>• The disc is not properly loaded.</li> </ul>	<ul style="list-style-type: none"> <li>• Reload the disc.</li> </ul>	3
"00 : 00" is displayed even though a disc is loaded.	<ul style="list-style-type: none"> <li>• A disc other than a CD or Super Audio CD is loaded.</li> </ul>	<ul style="list-style-type: none"> <li>• Load a CD or Super Audio CD.</li> </ul>	3
Playback does not start even when the ►/   button is pressed.	<ul style="list-style-type: none"> <li>• The disc is dirty or scratched.</li> </ul>	<ul style="list-style-type: none"> <li>• Wipe the dirt off the disc or replace the disc.</li> </ul>	3, 4
No digital signals are output.	<ul style="list-style-type: none"> <li>• For Super Audio CDs, no digital signals are output.</li> <li>• Turn the pure direct mode on.</li> </ul>	<ul style="list-style-type: none"> <li>• For Super Audio CDs, use the analog audio output signals.</li> </ul>	9
		<ul style="list-style-type: none"> <li>• Turn the pure direct mode off.</li> </ul>	13
A specific section of the disc cannot be played properly.	<ul style="list-style-type: none"> <li>• The disc is dirty or scratched.</li> </ul>	<ul style="list-style-type: none"> <li>• Wipe the dirt off the disc or replace the disc.</li> </ul>	3, 4
Programmed playback is not possible.	<ul style="list-style-type: none"> <li>• The tracks have not been programmed properly.</li> </ul>	<ul style="list-style-type: none"> <li>• Program properly.</li> </ul>	15
A CD-R or CD-RW disc cannot be played.	<ul style="list-style-type: none"> <li>• The disc has not been finalized.</li> <li>• The recording conditions are bad or the quality of the disc itself is poor.</li> </ul>	<ul style="list-style-type: none"> <li>• Finalize the disc then play it.</li> </ul>	3
		<ul style="list-style-type: none"> <li>• Use a properly recorded disc.</li> </ul>	-
Files recorded in MP3 or WMA format cannot be played.	<ul style="list-style-type: none"> <li>• You have selected a copyright-protected WMA file or a file that cannot be played normally.</li> </ul>	<ul style="list-style-type: none"> <li>• Press the ◀◀ or ▶▶ button to select a different file.</li> </ul>	16

**[Tuner]**

Symptom	Cause	Countermeasure	Page
Buzzing noise in FM broadcasts.	<ul style="list-style-type: none"> <li>The antenna cable is not properly connected.</li> <li>Noise interference from a nearby electronic device equipped with a microprocessor, or the radio broadcast signal is weak.</li> </ul>	<ul style="list-style-type: none"> <li>Connect the antenna properly.</li> <li>Reposition the equipment or the positions or directions of the connection cables, antenna, etc.</li> <li>Connect an outdoor antenna.</li> </ul>	10 - -
Hissing or buzzing noise is heard in AM broadcasts.	<ul style="list-style-type: none"> <li>Noise interference from a nearby monitor, etc., or there is interference in the broadcast signal.</li> </ul>	<ul style="list-style-type: none"> <li>Turn off the monitor.</li> <li>Change the position or direction of the AM loop antenna.</li> <li>Connect an outdoor antenna.</li> </ul>	- - -
Humming noise is heard in AM broadcasts.	<ul style="list-style-type: none"> <li>There is interference from current in power cords.</li> </ul>	<ul style="list-style-type: none"> <li>Connect an outdoor antenna.</li> </ul>	-

**[Record Player]**

Symptom	Cause	Countermeasure	Page
When playing records, a wailing noise (howling) is produced when the volume is raised.	<ul style="list-style-type: none"> <li>The player and speakers are too close together.</li> <li>The floor is soft and vibrates easily.</li> </ul>	<ul style="list-style-type: none"> <li>Move the player and speakers as far apart as possible.</li> <li>Use cushions or spikes to absorb the vibrations of the speakers being conveyed from the floor.</li> </ul>	- -

**[iPod]**

Symptom	Cause	Countermeasure	Page
iPod cannot be played.	<ul style="list-style-type: none"> <li>Device you want to play and set input source do not match.</li> <li>Cable is not properly connected.</li> <li>Control dock for iPod's AC adapter is not connected to power outlet.</li> </ul>	<ul style="list-style-type: none"> <li>Select an appropriate input source.</li> <li>Reconnect.</li> <li>Plug the control dock for iPod's AC adapter into a power outlet.</li> </ul>	18 9 -

**[Remote Control Unit]**

Symptom	Cause	Countermeasure	Page
Set does not work properly when remote control unit operated.	<ul style="list-style-type: none"> <li>Batteries are worn.</li> </ul>	<ul style="list-style-type: none"> <li>Replace with new batteries.</li> </ul>	4
	<ul style="list-style-type: none"> <li>You are operating outside of the specified range.</li> </ul>	<ul style="list-style-type: none"> <li>Operate within the specified range.</li> </ul>	4
	<ul style="list-style-type: none"> <li>Obstacle between main unit and remote control unit.</li> </ul>	<ul style="list-style-type: none"> <li>Remove the obstacle.</li> </ul>	4
	<ul style="list-style-type: none"> <li>The batteries are not inserted in the proper direction, as indicated by the polarity marks in the battery compartment.</li> </ul>	<ul style="list-style-type: none"> <li>Insert the batteries in the proper direction, following the polarity marks in the battery compartment.</li> </ul>	4
	<ul style="list-style-type: none"> <li>The set's remote control sensor is exposed to strong light (direct sunlight, inverter type fluorescent bulb light, etc.).</li> </ul>	<ul style="list-style-type: none"> <li>Move the set to a place in which the remote control sensor will not be exposed to strong light.</li> </ul>	4

# Specifications

**Receiver section**

**Rated output:**

2-channel driving  
 375 W + 375 W (8 Ω/ohms, DIN, 1 kHz, T.H.D. 0.7 %)  
 75 W + 75 W (4 Ω/ohms, DIN, 1 kHz, T.H.D. 0.7 %)

**High frequency distortion:**

0.05 % (Rated output: -3 dB), 8 Ω/ohms, 1 kHz

**Output terminals:**

Speaker 4 ~ 16 Ω/ohms  
 Suited for headphones/stereo headphones

**Equalizer amplifier output (REC OUT terminals):**

Rated output : 150 mV

**Input sensitivity / Input impedance:**

PHONO (MM) : 2.5 mV / 47 kΩ/kohms  
 PHONO (MC) : 0.2 mV / 100 Ω/ohms  
 CD, LINE1, LINE2 : 130 mV / 47 kΩ/kohms  
 PHONO (MM) : 20 Hz ~ 20 kHz ±0.5 dB  
 PHONO (MC) : 30 Hz ~ 20 kHz ±0.5 dB

**RIAA deviation:**

**Reception frequency range:**

FM : 87.5 MHz ~ 107.9 MHz AM : 520 kHz ~ 1710 kHz

**Reception sensitivity:**

FM : 1.5 μV / 75 Ω/ohms AM : 20 μV

**FM channel separation:**

35 dB (1 kHz)

**FM S/N ratio:**

Monaural : 74 dB Stereo : 70 dB

**FM harmonic distortion:**

Monaural : 0.3 % Stereo : 0.4 %

**S/N ratio:**

PHONO (MM) : 84 dB  
 (With input terminals short-circuited, 5 mV input signal)  
 PHONO (MC) : 70 dB  
 (With input terminals short-circuited, 0.5 mV input signal)

**(A-weighted network):**

LINE1, LINE2 : 95 dB (input terminals short-circuited)

**Tone control:**

BASS : 100 Hz ± 8 dB  
 TREBLE : 10 kHz ± 8 dB

**Frequency response:**

10 Hz ~ 40 kHz (+0.5 dB, -3 dB) (INPUT: LINE1, PURE DIRECT: ON)

**Clock/Timer section**

**Clock type:**

Power line frequency synchronized method (Within ±60 seconds per month)

**Timer:**

Everyday timer / Once timer : One system each  
 Sleep timer : Max. 90 minutes

**CD section**

**Analog output**

**Signal type:**

[Super Audio CD]

[CD]

1-bit DSD

16-bit linear PCM

**Sampling frequency:**

2.822 MHz

44.1 kHz

**Usable discs:**

Super Audio CD

Compact Disc

**Digital output**

**Optical:**

-

-15 ~ -21 dBm

**Emission wavelength:**

-

660 nm

**General**

**Power supply:**

AC 120 V, 60 Hz

**Power consumption:**

50 W  
 0.3 W (Standby)

**Maximum external dimensions:**

300 (W) x 110 (H) x 341 (D) mm

**Weight:**

8.0 kg

**Remote control unit (RC-1109)**

**Remote control method:**

Infrared pulse method

**Batteries:**

R03/AAA Type (two batteries)

**Maximum external dimensions:**

44 (W) x 233 (H) x 22 (D) mm

**Weight:**

165 g (including batteries)

**DENON**

[www.denon.com](http://www.denon.com)

Denon Brand Company, D&M Holdings Inc.  
Printed in Japan 5411 10058 001D

## Free Manuals Download Website

<http://myh66.com>

<http://usermanuals.us>

<http://www.somanuals.com>

<http://www.4manuals.cc>

<http://www.manual-lib.com>

<http://www.404manual.com>

<http://www.luxmanual.com>

<http://aubethermostatmanual.com>

Golf course search by state

<http://golfingnear.com>

Email search by domain

<http://emailbydomain.com>

Auto manuals search

<http://auto.somanuals.com>

TV manuals search

<http://tv.somanuals.com>