

Sliding Table Attachment

(Model 34-555)



PART NO. 1346924 - 09-18-03
Copyright © 2003 Delta Machinery

INSTRUCTION MANUAL



To learn more about DELTA MACHINERY
visit our website at: www.deltamachinery.com.

For Parts, Service, Warranty or other Assistance,

please call 1-800-223-7278 (In Canada call 1-800-463-3582).

Download from Www.Somanuals.com. All Manuals Search And Download.

SAFETY GUIDELINES - DEFINITIONS

This manual contains information that is important for you to know and understand. This information relates to protecting YOUR SAFETY and PREVENTING EQUIPMENT PROBLEMS. To help you recognize this information, we use the symbols to the right. Please read the manual and pay attention to these sections.

▲ DANGER Indicates an imminently hazardous situation which, if not avoided, will result in death or serious injury.

▲ WARNING Indicates a potentially hazardous situation which, if not avoided, could result in death or serious injury.

▲ CAUTION Indicates a potentially hazardous situation which, if not avoided, may result in minor or moderate injury.

CAUTION Used without the safety alert symbol indicates potentially hazardous situation which, if not avoided, may result in property damage.

▲ WARNING **SOME DUST CREATED BY POWER SANDING, SAWING, GRINDING, DRILLING, AND OTHER CONSTRUCTION ACTIVITIES** contains chemicals known to cause cancer, birth defects or other reproductive harm. Some examples of these chemicals are:

- lead from lead-based paints,
- crystalline silica from bricks and cement and other masonry products, and
- arsenic and chromium from chemically-treated lumber.

Your risk from these exposures varies, depending on how often you do this type of work. To reduce your exposure to these chemicals: work in a well ventilated area, and work with approved safety equipment, always wear **MSHA/NIOSH** approved, properly fitting face mask or respirator when using such tools.

GENERAL SAFETY RULES



▲ WARNING **READ AND UNDERSTAND ALL WARNINGS AND OPERATING INSTRUCTIONS BEFORE USING THIS EQUIPMENT.** Failure to follow all instructions listed below, may result in electric shock, fire, and/or serious personal injury or property damage.

IMPORTANT SAFETY INSTRUCTIONS

Woodworking can be dangerous if safe and proper operating procedures are not followed. As with all machinery, there are certain hazards involved with the operation of the product. Using the machine with respect and caution will considerably lessen the possibility of personal injury. However, if normal safety precautions are overlooked or ignored, personal injury to the operator may result. Safety equipment such as guards, push sticks, hold-downs, featherboards, goggles, dust masks and hearing protection can reduce your potential for injury. But even the best guard won't make up for poor judgment, carelessness or inattention. Always use common sense and exercise caution in the workshop. If a procedure feels dangerous, don't try it. Figure out an alternative procedure that feels safer. **REMEMBER:** Your personal safety is your responsibility. For additional information please visit our website www.deltamachinery.com.

▲ WARNING This machine was designed for certain applications only. Delta Machinery strongly recommends that this machine not be modified and/or used for any application other than that for which it was designed. If you have any questions relative to a particular application, **DO NOT** use the machine until you have first contacted Delta to determine if it can or should be performed on the product.

**Technical Service Manager
Delta Machinery
4825 Highway 45 North**

▲ WARNING FAILURE TO FOLLOW THESE RULES MAY RESULT IN SERIOUS PERSONAL INJURY.

1. **FOR YOUR OWN SAFETY, READ THE INSTRUCTION MANUAL BEFORE OPERATING THE MACHINE.** Learning the machine's application, limitations, and specific hazards will greatly minimize the possibility of accidents and injury.
2. **USE CERTIFIED SAFETY EQUIPMENT.** Eye protection equipment should comply with ANSI Z87.1 standards, hearing equipment should comply with ANSI S3.19 standards, and dust mask protection should comply with MSHA/NIOSH certified respirator standards. Splinters, air-borne debris, and dust can cause irritation, injury, and/or illness.
3. **DRESS PROPERLY.** Do not wear tie, gloves, or loose clothing. Remove watch, rings, and other jewelry. Roll up your sleeves. Clothing or jewelry caught in moving parts can cause injury.
4. **DO NOT USE THE MACHINE IN A DANGEROUS ENVIRONMENT.** The use of power tools in damp or wet locations or in rain can cause shock or electrocution. Keep your work area well-lit to prevent tripping or placing arms, hands, and fingers in danger.
5. **MAINTAIN ALL TOOLS AND MACHINES IN PEAK CONDITION.** Keep tools sharp and clean for best and safest performance. Follow instructions for lubricating and changing accessories. Poorly maintained tools and machines can further damage the tool or machine and/or cause injury.
6. **CHECK FOR DAMAGED PARTS.** Before using the machine, check for any damaged parts. Check for alignment of moving parts, binding of moving parts, breakage of parts, and any other conditions that may affect its operation. A guard or any other part that is damaged **should be properly repaired or replaced.** Damaged parts can cause further damage to the machine and/or injury.
7. **KEEP THE WORK AREA CLEAN.** Cluttered areas and benches invite accidents.
8. **KEEP CHILDREN AND VISITORS AWAY.** Your shop is a potentially dangerous environment. Children and visitors can be injured.
9. **REDUCE THE RISK OF UNINTENTIONAL STARTING.** Make sure that the switch is in the "OFF" position before plugging in the power cord. In the event of a power failure, move the switch to the "OFF" position. An accidental start-up can cause injury.
10. **USE THE GUARDS.** Check to see that all guards are in place, secured, and working correctly to prevent injury.
11. **REMOVE ADJUSTING KEYS AND WRENCHES BEFORE STARTING THE MACHINE.** Tools, scrap pieces, and other debris can be thrown at high speed, causing injury.
12. **USE THE RIGHT MACHINE.** Don't force a machine or an attachment to do a job for which it was not designed. Damage to the machine and/or injury may result.
13. **USE RECOMMENDED ACCESSORIES.** The use of accessories and attachments not recommended by Delta may cause damage to the machine or injury to the user.
14. **USE THE PROPER EXTENSION CORD.** Make sure your extension cord is in good condition. When using an extension cord, be sure to use one heavy enough to carry the current your product will draw. An undersized cord will cause a drop in line voltage, resulting in loss of power and overheating. See the Extension Cord Chart for the correct size depending on the cord length and nameplate ampere rating. If in doubt, use the next heavier gauge. The smaller the gauge number, the heavier the cord.
15. **SECURE THE WORKPIECE.** Use clamps or a vise to hold the workpiece when practical. Loss of control of a workpiece can cause injury.
16. **FEED THE WORKPIECE AGAINST THE DIRECTION OF THE ROTATION OF THE BLADE, CUTTER, OR ABRASIVE SURFACE.** Feeding it from the other direction will cause the workpiece to be thrown out at high speed.
17. **DON'T FORCE THE WORKPIECE ON THE MACHINE.** Damage to the machine and/or injury may result.
18. **DON'T OVERREACH.** Loss of balance can make you fall into a working machine, causing injury.
19. **NEVER STAND ON THE MACHINE.** Injury could occur if the tool tips, or if you accidentally contact the cutting tool.
20. **NEVER LEAVE THE MACHINE RUNNING UNATTENDED. TURN THE POWER OFF.** Don't leave the machine until it comes to a complete stop. A child or visitor could be injured.
21. **TURN THE MACHINE "OFF", AND DISCONNECT THE MACHINE FROM THE POWER SOURCE** before installing or removing accessories, before adjusting or changing set-ups, or when making repairs. An accidental start-up can cause injury.
22. **MAKE YOUR WORKSHOP CHILDPROOF WITH PADLOCKS, MASTER SWITCHES, OR BY REMOVING STARTER KEYS.** The accidental start-up of a machine by a child or visitor could cause injury.
23. **STAY ALERT, WATCH WHAT YOU ARE DOING, AND USE COMMON SENSE. DO NOT USE THE MACHINE WHEN YOU ARE TIRED OR UNDER THE INFLUENCE OF DRUGS, ALCOHOL, OR MEDICATION.** A moment of inattention while operating power tools may result in injury.
24. **THE DUST GENERATED** by certain woods and wood products can be injurious to your health. Always operate machinery in well-ventilated areas, and provide for proper dust removal. Use wood dust collection systems whenever possible.

FUNCTIONAL DESCRIPTION

FOREWORD

Delta Model 34-555 Sliding Table Attachment is an accessory for providing support for large capacity wood-working operations. The fence can be positioned in the front or rear of the movable table and can be positioned to make miter cuts. The adjustable stock stop is excellent for repetitive cutting.

UNPACKING AND CLEANING

Carefully unpack the accessory and all loose items from the shipping container(s). Remove the protective coating from all unpainted surfaces. This coating may be removed with a soft cloth moistened with kerosene (do not use acetone, gasoline or lacquer thinner for this purpose). After cleaning, cover the unpainted surfaces with a good quality household floor paste wax.

CARTON CONTENTS

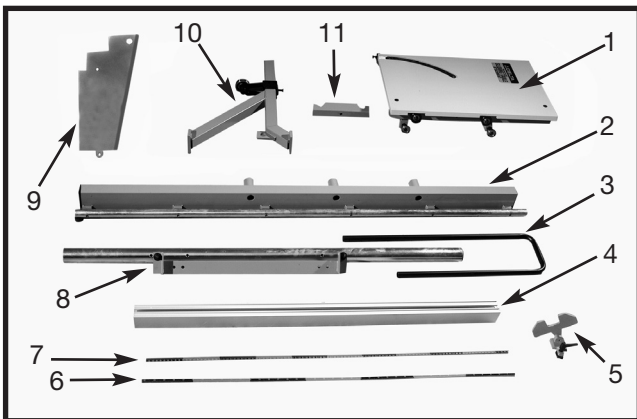

Fig. 1

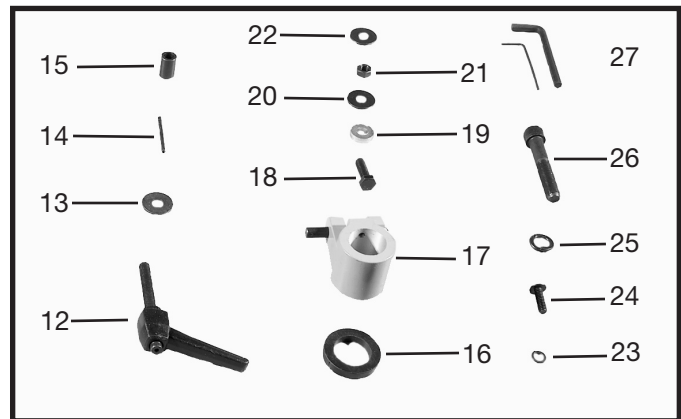

Fig. 2

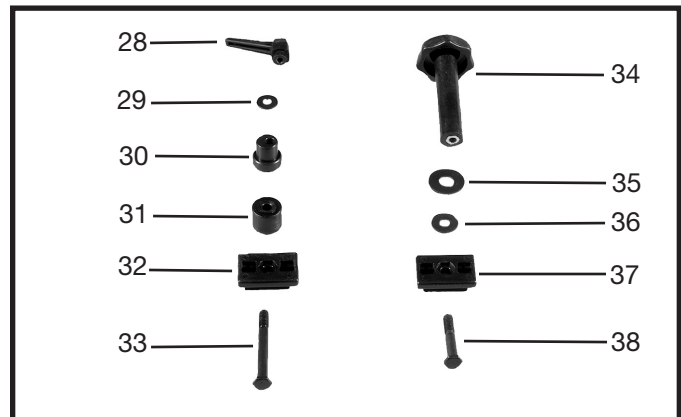

Fig. 3

1. Table Assembly
2. Upper Rail Assembly
3. Handle
4. Fence
5. Fence Stop Assembly
6. English (Inch) Scale
7. Metric Scale
8. Lower Rail Assembly
9. Sheet Metal Bracket
10. Table Assembly Support Frame
11. Handle Support Bracket
12. Lock Handle Assembly
13. 5/16" Flat Washer
14. Roll Pin
15. Rear Fence Cam
16. Rubber Bumper Stop
17. Table lock/stop Bracket
18. 1" Hex Head Screw
19. Special Washer (2)
20. 5/16" Flat Washer
21. 5/16" Hex Nut (2)
22. 5/16" Flat Washer (4)
23. 1/4" Lockwasher (4)
24. 3/4" Screw (4)
25. Lockwasher (3)
26. 2-1/2" Socket Head Cap Screw (3)

27. Hex Head Wrenches
28. Ratchet Handle
29. 5/16" Flat Washer
30. Rear Fence Cam
31. Spacer
32. Slide Bracket
33. Special Bolt
34. Lock Knob
35. Nylon Flat Washer
36. 5/16" Flat Washer
37. Slide Bracket
38. Special Bolt

ASSEMBLY

⚠ WARNING DISCONNECT MACHINE FROM POWER SOURCE.

If your saw is equipped with the Delta Jet-Lock Rip Fence with round guide rails, cut 5-1/2" off of the left end of both the front and rear guide rails. If your saw is equipped with a Beisemeyer fence, measure 1-1/2" to the left from the left side of the table and cut the rail. If your saw is equipped with the Delta Unifence Saw Guide, cut 8" off the left end of the front guide rail. Another option for the old Unifence is to redrill the mounting holes in the front guide rail 8" to the left and reposition the rip scale. On the new Unifence, the rail can slide by loosening the two bolts and repositioning the rip scale.

FOR 10" CONTRACTOR'S SAWS (OLD STYLE)

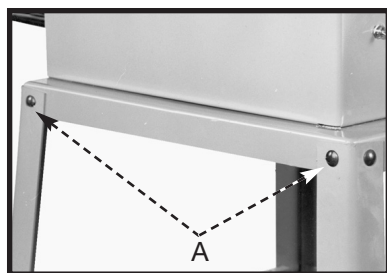

Fig. 4

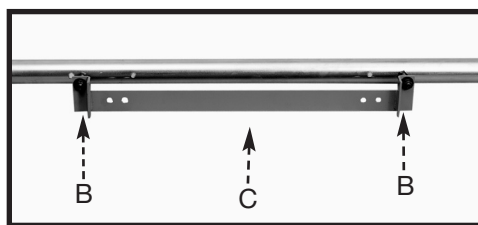

Fig. 5

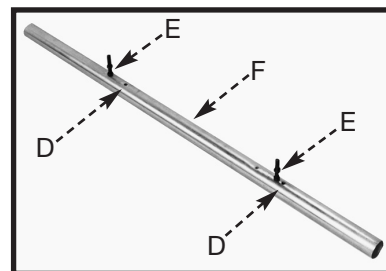

Fig. 6

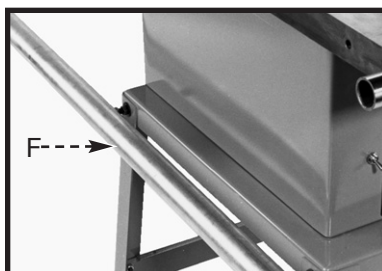

Fig. 7

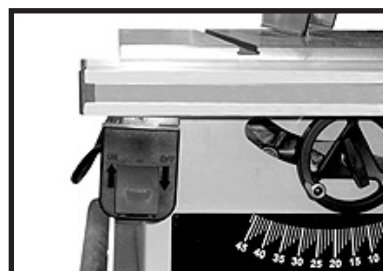

Fig. 8

(Contractor II Saws and Contractor Saw (Current Style) instructions follow in another section).

1. If your switch is attached to the left extension wing, remove it. (After installation of the sliding table, re-attach the switch to the location shown in Fig. 8).
2. Remove the left-hand table extension. (It will not be used with the Sliding Table.)
3. Remove the two top left carriage bolts (A) Fig. 4, washers, and nuts from saw stand and discard. Enlarge the holes using a 7/16" drill bit.
4. Locate the lower rail assembly (Fig. 5), and remove one nut and washer (B) from each side. Remove the mounting bracket (C). (It is not used in this assembly.)

NOTE: Save the two nuts and washers (B) for use later.

5. Move the studs (E) Fig. 6 on the lower guide rail (F) to the holes (D) in the guide rail. Holes should be 20-1/4" apart.
6. Attach the lower guide rail (F) Fig. 7 to the two holes in the stand using the two flat washers and nuts that were removed from the lower rail assembly in **STEP 3**.

NOTE: Position the end of the rail (F) Fig. 7 with the stud closest to the end toward the front.

7. Tighten the four nuts that attach the guide rail (F) Fig. 7 to the stand. Leave a space of 1-1/4" between the guide rail and the stand. Final adjustments will be made later.

FOR 10" CONTRACTOR'S SAWS

(CURRENT STYLE)

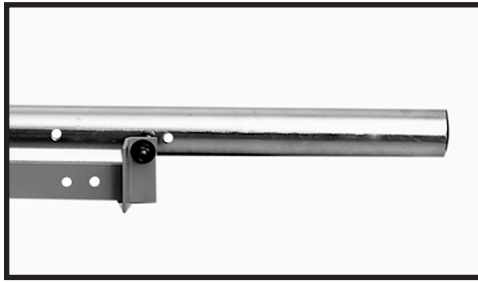

Fig. 9



Fig. 10

1. If your switch is attached to the left extension wing, remove it. (After installation of the sliding table, re-attach the switch to the location shown in Fig. 9.)
2. Remove the left-hand table extension. (It will not be used with the Sliding Table.)
3. Confirm that the rail/bracket has been assembled as shown in Fig. 9, and that the short end of the rail (stud closest to the end) is on the right. (If the rail has been previously attached with the long end of the rail to the right, remove the bracket, turn the rail 180 degrees, and re-attach the bracket.)
4. Locate the lower rail assembly (Fig. 9), two 1" hex head screws, two flat washers, two special washers, and two hex nuts.
5. Attach the rail as assembled (Fig. 10). Place the studs in the holes on the lower guide rail. These studs should be 21-3/4" apart.
6. Hold the lower rail assembly against the saw cabinet (Fig. 10) and mark and drill the two mounting holes in the side of the leg panels using a 7/16" drill. **NOTE:** Hold the rail assembly level with the bottom edge of the saw cabinet.
7. Fasten the lower rail assembly to the left side of the saw cabinet (Fig.10), using the hardware from Step 1.

FOR 10" CONTRACTOR II SAWS ONLY

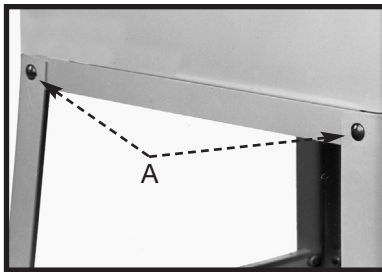

Fig. 11

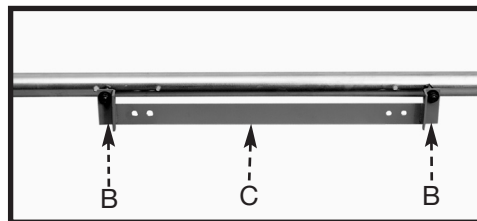

Fig. 12

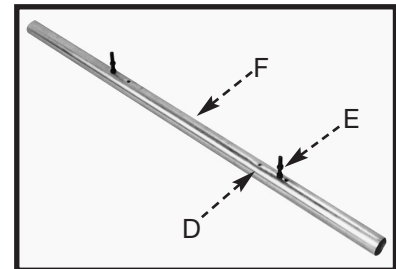

Fig. 13

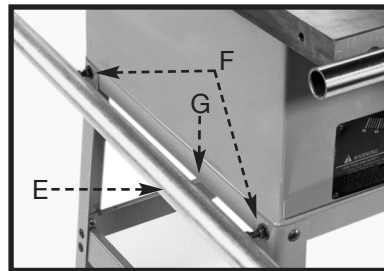

Fig. 14

1. If your switch is attached to the left extension wing, remove it. (After installation of the sliding table, re-attach the switch to the location shown in Fig. 6C.)
2. Remove the left-hand table extension. (It will not be used with the Sliding Table.)
3. Remove the two top left carriage bolts (A) Fig. 11, washers and nuts from saw stand and discard. Enlarge the holes using a 7/16" drill bit.
4. Locate the lower rail assembly (Fig. 12), and remove one nut and washer (B) from each side. Remove the mounting bracket (C) Fig. 12.

NOTE: Discard the bracket, but save the two nuts and washers (B) Fig. 12. They will be used to mount the rail to the stand.

5. Move the stud (E) Fig. 13 on the lower guide rail (F) to hole (D) in the guide rail. Hole spacing should be 18-1/4".
6. Attach the lower guide rail (E) Fig. 19 to the two holes in the stand, using the two flat washers and nuts that were removed from the lower rail assembly in **STEP 2**.

NOTE: Place the long end of rail (E) Fig. 19 (stud farthest from the end) toward the front.

7. Tighten the four nuts that attach the guide rail (F) Fig. 19 to the stand. Leave a space of 2-1/8" between the guide rail and the stand. Final adjustments will be made later.

FOR 10" TILTING ARBOR SAWS ONLY

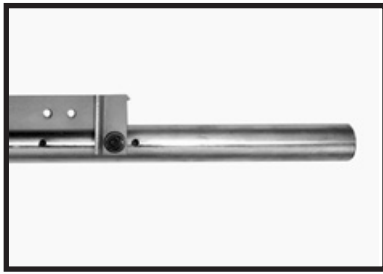

Fig. 15

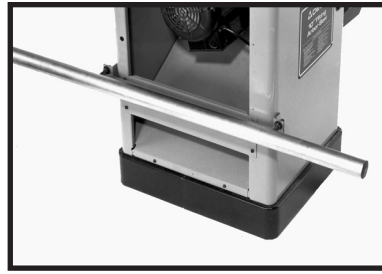

Fig. 16

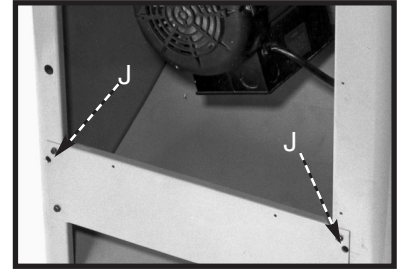

Fig. 17

1. Remove the motor cover. (To use the Sliding table, replace the motor cover with the part #734557 Hinged Motor Cover. Refer to the instructions that accompany the cover for installation.)
2. Locate the rail (Fig.15), two 1" hex head screws, 2 flat washers, 2 special washers, and 2 hex nuts. Make sure that the rail/bracket is assembled as shown in Fig. 15, and that the short end of the rail is on the right of the bracket. (If the rail has been previously attached with the long end to the right, remove the bracket, turn the rail 180 degrees, and re-attach the bracket.)
3. Measure down 21" from the surface of the saw table, draw a line, then hold up the rail (with the short end of the rail to the front of the saw) and mark the drill guides on the marked line. Drill 7/16" holes at these marked locations.
4. Fasten the lower rail assembly to the saw cabinet (Fig. 16), using the hardware From **STEP 1**.

NOTE: Position the special washers between the lower rail mounting bracket and the cabinet. Place the lockwashers and nuts inside the cabinet. Make sure that the head of the bolts and flat washers are on the outside of the mounting brackets.

FOR HEAVY DUTY SHAPERS ONLY

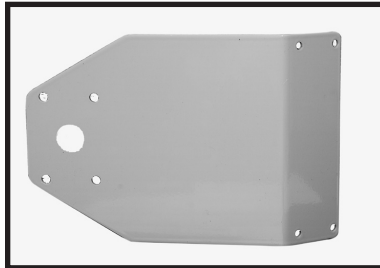

Fig. 18

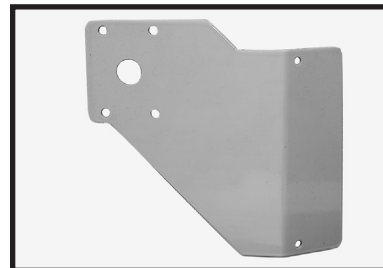

Fig. 19

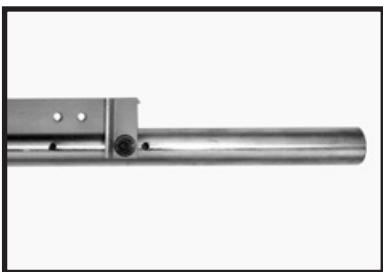

Fig. 20

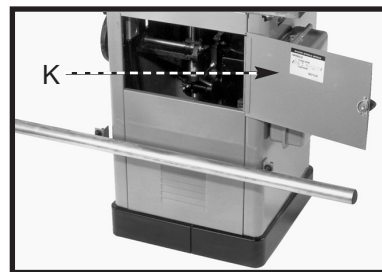

Fig. 21

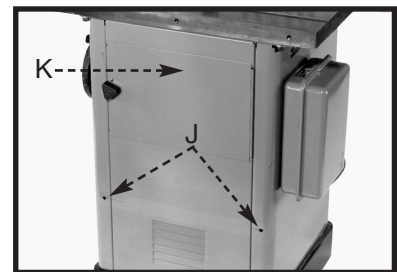

Fig. 22

1. If your switch bracket looks the same as the bracket in Fig 18, order a new switch bracket (#432-02-014-0017) that looks the same as the bracket in Fig. 19 .
2. Remove the front table extension.
3. Locate the rail (Fig.20), two 1" hex head screws, 2 flat washers, 2 special washers, and 2 hex nuts. Make sure that the rail/bracket is assembled as shown in Fig. 20, and that the short end of the rail (stud closest to the end) is on the right of the bracket. (If the rail has been previously attached with the long end to the right, remove the bracket, turn the rail 180 degrees, and re-attach the bracket.)
4. Measure down 21" from the surface of the shaper table and draw a line on the cabinet door side (Fig. 22). Hold the rail against the cabinet with the short end of the rail to the front of the saw, and mark the drill guides on the marked line. Drill 7/16" holes at these marked locations (J) Fig. 22.
5. Fasten the lower rail assembly to the front side of the shaper cabinet (Fig. 21), using the hardware From **STEP 1**.

NOTE: Position the special washers between the lower rail mounting bracket and the cabinet. Place the lockwashers and nuts inside the cabinet. Make sure that the head of the bolts and flat washers are on the outside of the mounting brackets.

FOR 10" RIGHT-TILT UNISAWS ONLY

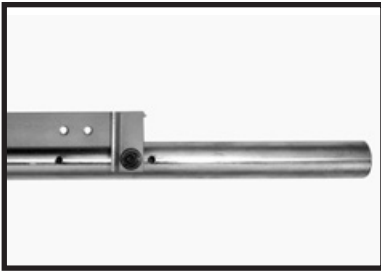

Fig. 23



Fig. 24

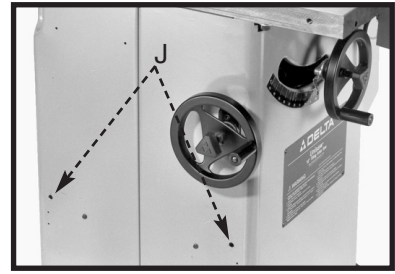

Fig. 25

1. If the switch is mounted to the left table extension, remove the switch and discard the hardware.
2. Remove the left-hand table extension. (It will not be used with the sliding table.)
3. Locate the rail (Fig.23), two 1" hex head screws, 2 flat washers, 2 special washers, and 2 hex nuts. Make sure that the rail/bracket is assembled as shown in Fig. 20, and that the short end of the rail is on the right of the bracket. (If the rail has been previously attached with the long end to the right, remove the bracket, turn the rail 180 degrees, and re-attach the bracket.)
4. Measure down 19-3/4" from the top surface of the saw table, draw a line, then hold up the rail (with the short end of the rail to the front of the saw). Mark the drill guides on the marked line. Drill 7/16" holes at these marked locations.
5. Fasten the lower rail assembly to the left side of the saw cabinet (Fig. 24), using the hardware From **STEP 1**.



Fig. 26

- NOTE:** Position the special washers between the lower rail mounting bracket and the cabinet. Place the lockwashers and nuts inside the cabinet. Make sure that the head of the bolts and flat washers are on the outside of the mounting brackets.
6. If your unit has the GPE switch (different from the one in Fig. 26), remove the bracket from the switch and attach the sheet metal bracket (#9 in **CARTON CONTENTS**). Attach it by moving from the original position to the position shown in Fig. 26.
 7. If your unit has the LVC switch, use the front rail mounting hardware and secure it with the nut on the backside. Attach this assembly in the same location and with the same hardware as in **STEP 6**.

FOR ALL PRODUCTS

1. Attach the upper rail assembly (L) Fig. 27 to the side of the table where the extension wing was previously mounted, using the three 2-1/2" socket head screws (M) and lockwashers (N) through the holes (C) Fig. 28.
2. Use a square (D) Fig. 28 with a straight edge (A) on the machine table with the other end extending over the top of the upper rail assembly (B). The top of the upper rail assembly (B) must be slightly below the table surface. Check the square (A) to confirm that the rail (E) is the same distance below the table surface at the front and the rear. To adjust, loosen the three screws located in holes (C) and adjust the upper guide rail assembly (B). After adjustment, tighten screws (C).
4. Attach the table support frame (P) Fig. 29 to the bottom of the table assembly using the four 3/4" screws (Q) and 1/4" lockwashers (R).
5. Insert the long end of the handle (S) Fig. 30 through the hole in the table support frame (P).
6. Place the 5/16" flat washer (T) Fig. 31 on the shaft end of the lock handle assembly (U) and place the handle support bracket (V) in position over the handle (S). Insert the threaded end of the handle assembly (U) through the hole (W) in the support bracket (V) and tighten the handle assembly (U).
7. Insert the roll pin (X) in the end of the handle rod (S) Fig. 32.

NOTE: The roll pin (X) prevents the handle (S) from pulling out of the support frame (P).

8. Slide the table assembly on the upper rail with the handle (S) Fig. 33 in the front position.

NOTE: The guide rail (C) must be between the two V roller bearings and the two flat roller bearings underneath the table assembly (Fig 35).

9. Make sure lower bearing (Y) Fig. 34, contacts lower rail (F) in the center of the rail. If necessary, loosen screw (Z) and move bracket (A) up or down until bearing (Y) contacts rail (F).

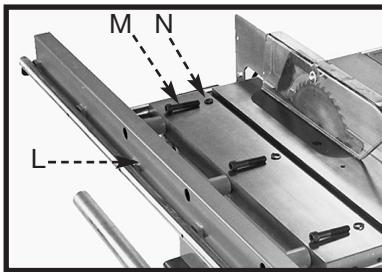

Fig. 27

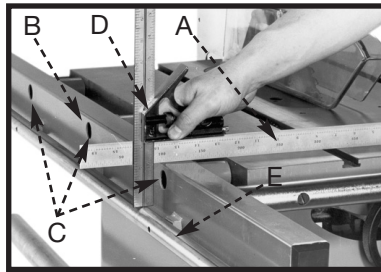

Fig. 28

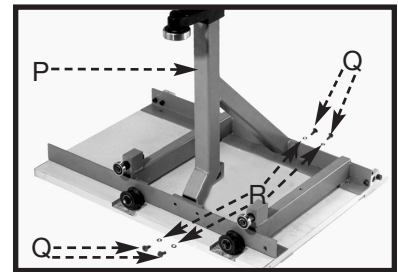

Fig. 29

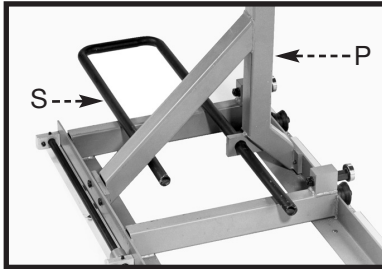

Fig. 30

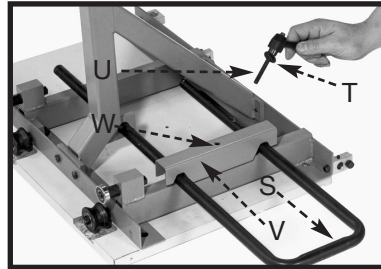

Fig. 31

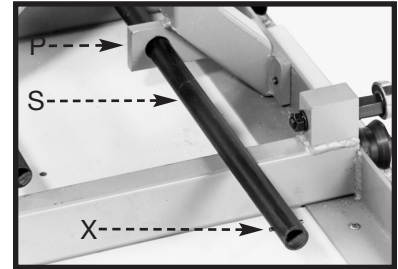

Fig. 32

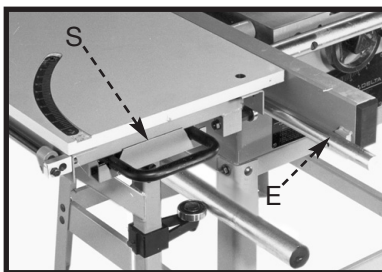

Fig. 33

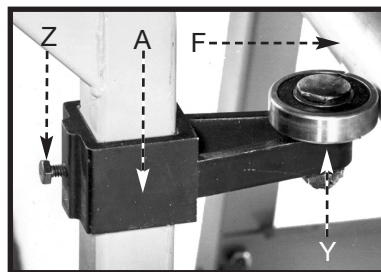

Fig. 34

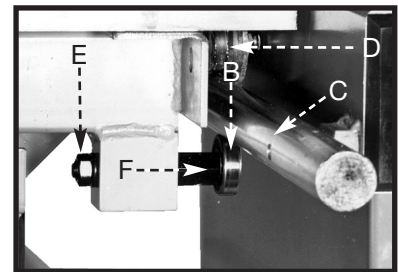

Fig. 35

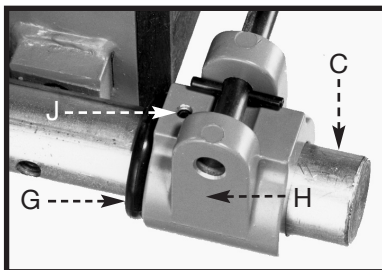

Fig. 36

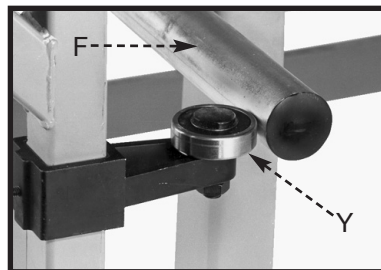

Fig. 37

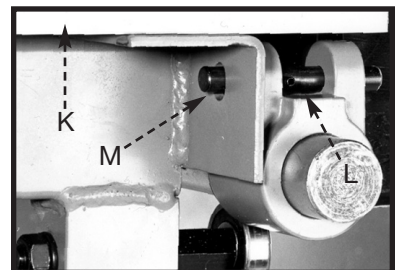

Fig. 38

NOTE: For Old Contractor's Saws, turn bracket (A) Fig. 34 upside down so that the bearing (Y) contacts the rail (F).

10. Adjust the two lower bearings, one of which is shown at (B) Fig. 35, so that the upper guide rail (C) will be between the two lower bearings (B) and two upper bearings (D). Adjust the bearing (B) by loosening the nut (E) and turning the eccentric (F) to move the bearing (B) up or down. Adjust the rear bearing in the same manner.

NOTE: This is a temporary adjustment. The final adjustment will be made later.

11. Attach the rubber bumper stop (G) Fig. 36, and table lock/stop bracket (H) to the front end of the upper rail (C).
12. Pull the sliding table toward the front of the saw until the lower bearing (Y) Fig. 37 is near the end of the lower rail (F).
13. Push the rubber bumper stop (G) Fig. 36 and the table lock/stop bracket (H) in until they contact the upper bearing on the sliding table. Tighten the set screw (J) Fig. 36 to hold the stop (H) in place.
14. Fig. 38 illustrates the sliding table (K) locked in the forward position. The lock pin (L) is moved to the left through the hole (M) in the table bracket to lock the table in place. To slide the table on the rail, move the lock pin (L) to the right.

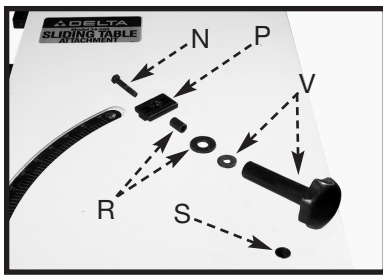

Fig. 39

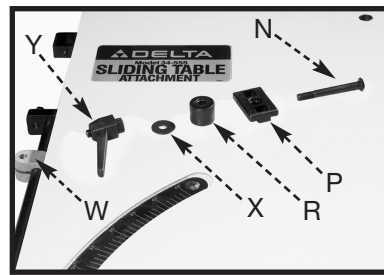

Fig. 40

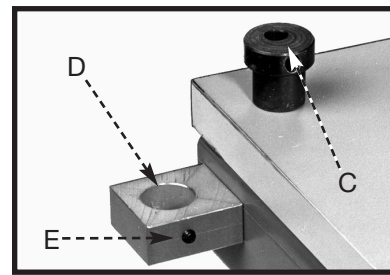

Fig. 41

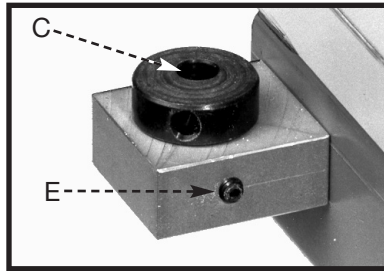

Fig. 42

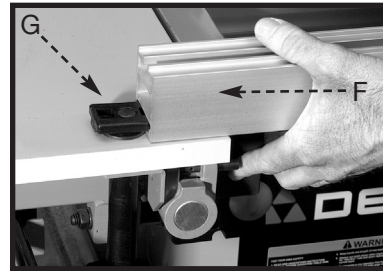

Fig. 43

NOTE: Never operate the sliding table with the table lock/stop bracket removed.

15. Place the special threaded bolt (N) Fig. 39 through the hole in the slide bracket (P) and the spacer and flat washer (R), then through the bushing (S) in the table and frame. Fasten in place with a flat washer and knob (V) from underneath the table. Make sure that the hex head on the bolt seats in the hex on the slide bracket.
16. Place the special threaded bolt (N) Fig. 40 through the hole in the remaining slide bracket (P) and the spacer (R) then down through the hole in the sliding bracket (W). Fasten in place with a flat washer (X) and locking lever (Y).
17. Insert the rear fence cam (C) Fig. 41 into hole (D) in the bracket. Tighten the set screw (E) Fig. 41 and Fig. 42 to hold the cam (C) in place. Adjustment to the cam (C) will be made later.
18. Attach fence (F) Fig. 43 to right fence clamp (G) and into left fence clamp (H) Fig. 44.
19. After the fence is attached to the sliding table, tighten the fence lock handle (G) Fig. 44 and lock knob (J) Fig. 47.
20. Attach the fence stop assembly (K) Fig. 45 to the top of the fence and tighten the lock handle (L).
21. Position fence (F) Fig. 46 on the table to provide a clearance of 1/4" or more between the right end of fence (F) and the blade guard. Place a 12" rule (M) against the saw blade and along the fence. Loosen the lock handle (L) and move the stop (N) against end of rule (M) to place it 12" from the blade.
22. Decide whether to use the metric or English scale. Peel the backing from the scale. (The English scale is used in these examples.) Apply the scale inside the fence channel, lining up the 12" mark on the scale with the pointer (O) Fig. 48. Make adjustments to the pointer (O) by loosening the screw (R), adjusting the pointer (O) and tightening the screw (R).

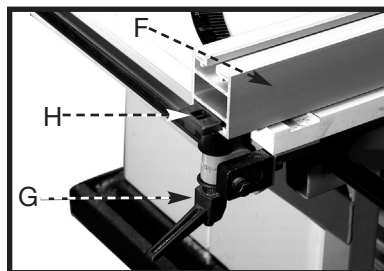

Fig. 44

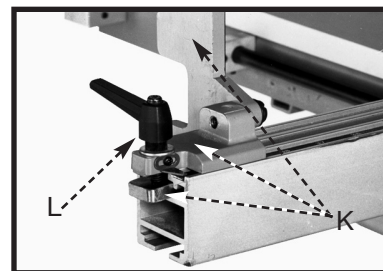

Fig. 45

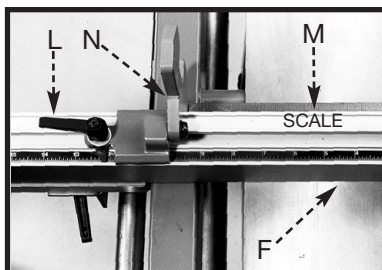

Fig. 46



Fig. 47

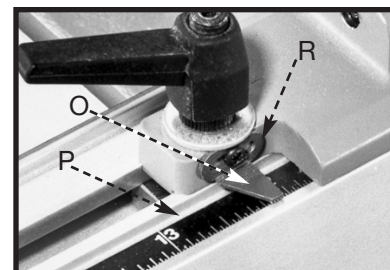

Fig. 48

ADJUSTING HEIGHT OF RIGHT EDGE OF SLIDING TABLE

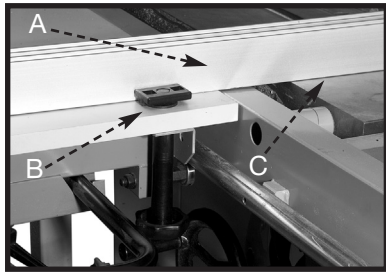

Fig. 49

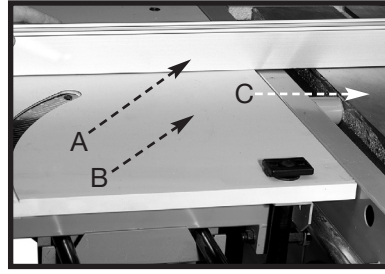

Fig. 50

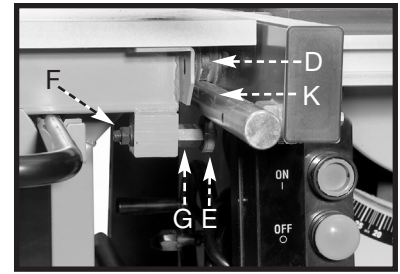

Fig. 51

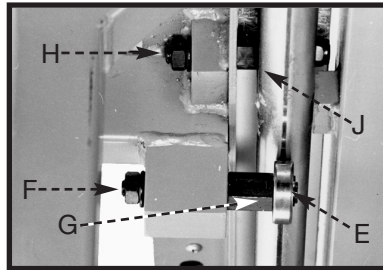

Fig. 52

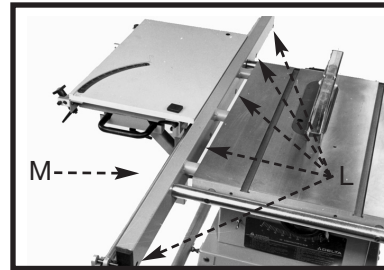

Fig. 53

The right edge of the sliding table should be slightly higher than the machine table, both front and rear. To check and adjust:

1. Use the fence (A) Figs. 49 and 50 or a suitable straight edge to see if the sliding table (B) is slightly higher than the machine table (C) at the front of the machine table (Fig. 49) and the rear of the machine table (Fig. 50).
2. The height of the sliding table is controlled by raising or lowering the two sets of upper and lower bearings that ride on the upper guide rail (K) Fig. 51. The front upper and lower bearings are shown at (D) and (E) Fig. 51.

NOTE: For clarity, the table/lock stop has been removed from the guide rail.

3. To adjust the lower bearing (E) Figs. 51 and 52 out of the way, loosen the nut (F) and turn the eccentric (G).
4. To adjust the upper bearing (D) Fig. 51, loosen the nut (H) Fig. 52, and turn the eccentric (J) until the table is slightly higher than the saw table. Tighten the nut (H). Readjust the lower bearing. Maintain a smooth sliding fit between the bearings and the upper guide rail.
5. **IMPORTANT:** If after adjusting, the height of the sliding table is still below the machine table surface, loosen the six screws that fasten the upper rail (M) to the mounting bracket, five of which are shown at (L) Fig. 53. Raise the rail parallel with the table surface. Then re-adjust the bearings.

ADJUSTING LOWER RAIL PARALLEL TO UPPER RAIL

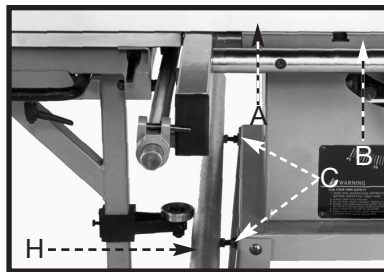

Fig. 54

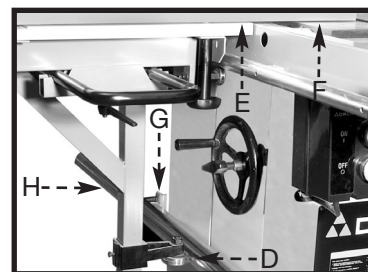

Fig. 55

To adjust the lower rail parallel to the upper rail:

1. Confirm that the fence is attached to the sliding table and that the right end of the fence extends across the surface of the table to the miter gauge slot.
2. Confirm that the gap between the bottom of the fence and the table at points (A) and (B) Fig. 54 is equal.
3. Move the sliding table to the front of the saw until the fence is at the front edge of the table.
4. Make any adjustments with the two nuts (C) Fig. 54. The other nut is located inside the stand or cabinet on the old style and contractor's saw II. (For the other machines, both nuts are located on the bracket.) Adjusting the nuts (C) will move the lower rail (H) closer to or farther away from other side of the bracket or the stand/cabinet. Do not adjust the nut next to the guide rail (H). Adjust the nuts until the gap between the bottom of the fence and the table is the same at points (A) and (B) Fig. 54.
5. Move the sliding table to the rear position until the bearing (D) Fig. 55 is positioned opposite the rear lower rail mounting bolt (G).
6. Check the gap between the bottom of the fence and the saw table at points (E) and (F) Fig. 55 to see if the gap is the same at both points.
7. Make any adjustments with the two nuts, one of which is shown at (G) Fig. 55. The other nut is located inside the stand or cabinet on the contractor's saw. (For the other machines, both nuts are located on the bracket.) Adjusting the nuts (G) will move the lower rail (H) closer to or farther away from the other side of the bracket or the stand/cabinet. Do not adjust the nut next to the guide rail (H). Adjust the nuts until the gap between the bottom of the fence and the table is the same at points (E) and (F) Fig. 55.

ADJUSTING SLIDING TABLE PARALLEL WITH MACHINE TABLE

Adjust the sliding table so that it is parallel with the machine table. (The sliding table must also be slightly higher than the machine table.) To check and adjust:

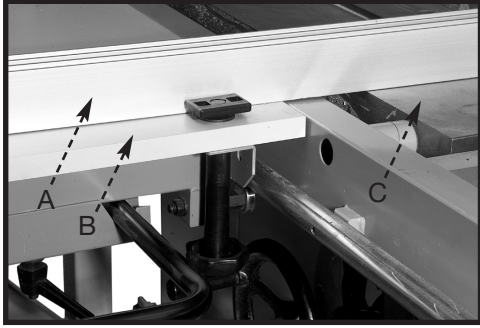

Fig. 56

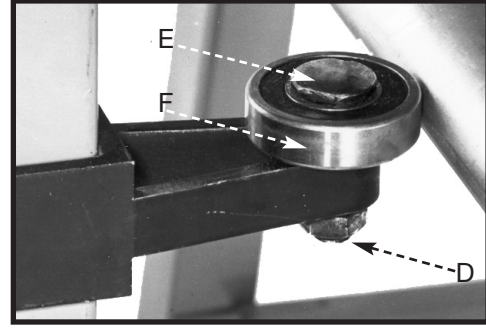

Fig. 57

1. Place a straight edge or the fence (A) Fig. 56 over the sliding table (B) and machine table (C).
2. The sliding table (B) Fig. 56 should be parallel with the machine table (C).
3. To adjust, loosen locknut (D) Fig. 57 and turn eccentric (E) to move bearing (F) in or out. Moving bearing (F) will raise or lower the right end of the sliding table. After adjustment is complete, tighten locknut (D).

ADJUSTING FENCE 90 AND 45 DEGREE POSITIVE STOPS

Positive stops are provided on the fence mounting bracket of your sliding table that will enable you to rapidly position the fence at 90 and 45 degrees to the blade. To check and adjust the fence positive stops:

1. With the fence (A) Fig. 58 in the forward operating position on the sliding table, loosen both fence locking handles, one of which is shown at (B). Pull the left end of fence as far toward the front as possible and tighten both locking handles (B).

⚠ WARNING DISCONNECT MACHINE FROM POWER SOURCE.

2. Place a square against the fence and the saw blade to check for a 90 degree angle. If the angle is incorrect, refer to **STEP 4**. Remove the square and connect the machine to the power source.
3. Make a test cut on a piece of stock (Fig. 59). Make sure that the edge of the stock against the fence is straight. Check to see that the cut portion of the stock is 90 degrees to the edge of the stock (against the fence). If the cut is not 90 degrees, refer to **STEP 4**.

⚠ WARNING DISCONNECT MACHINE FROM POWER SOURCE.

4. Loosen the locknut (C) Fig. 60 and adjust the screw (D) until it contacts the bracket (E) with the fence 90 degrees to the blade. Tighten the locknut (C). Connect the machine to the power source, and make additional cuts until the cut is 90 degrees.
5. After adjusting the fence positive stops, check the miter scale (M) Fig. 64. To adjust, loosen the two screws, one of which is shown at (N). Adjust the scale (M) and tighten the screws (N).
6. Loosen both fence locking handles and rotate left end of fence (A) to the rear until the pointer aligns with the 45 degree mark on the scale. (Fig. 61). Tighten both fence locking handles.

NOTE: When moving the left end of the fence for miter cutting, slide the fence by moving the lock handle (B) Fig. 60 with your hand.

7. Make a test cut on a piece of stock (Fig. 62). (Make sure that the edge of the stock against the fence is straight. If the cut is not 45 degrees to the edge against the fence, refer to **STEP 8**.)
8. Loosen the locknut (F) Fig. 63 and adjust the screw (G) until it contacts the bracket (H) with the fence at 45 degrees to the blade. Tighten the locknut (F).
9. Move the fence (A) Fig. 65 to the rear operating position by following the instructions "**MOVING FENCE TO REAR POSITION ON SLIDING TABLE**" later in this manual. Tighten both fence locking handles.

⚠ WARNING DISCONNECT MACHINE FROM POWER SOURCE.

10. Place a square against the fence and the saw blade to check for a 90 degree angle. If the angle is incorrect, refer to **STEP 12**. Remove the square and connect the machine to the power source.
11. Make a test cut on a piece of stock (Fig. 66). Make sure that the edge of the stock against the fence is straight. See if the cut is 90 degrees to the edge (against the fence). If the cut was not 90 degrees, refer to **STEP 12**.

⚠ WARNING DISCONNECT MACHINE FROM POWER SOURCE.

12. Slightly loosen both fence locking handles. Loosen the set screw (J) Fig. 67. Use a nail or some other suitable instrument in the hole (K) to rotate the eccentric bushing (L) until the fence is 90 degrees to the blade. Tighten the set screw (J). Connect the machine to the power source and make additional test cuts until the cut is 90 degrees.

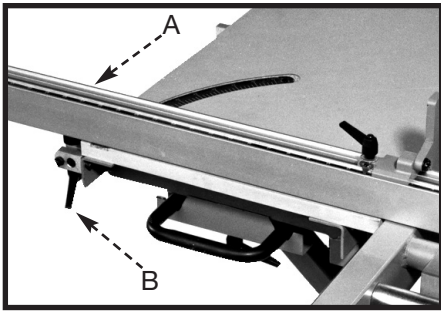

Fig. 58

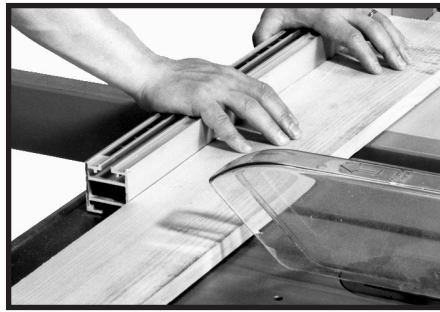

Fig. 59

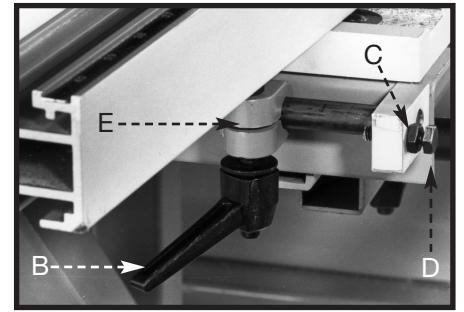

Fig. 60

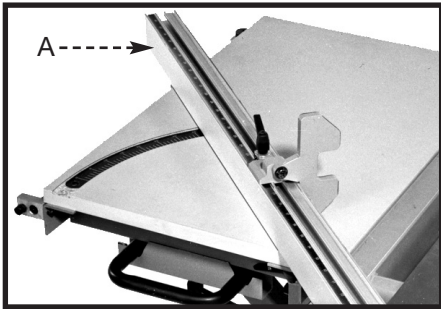

Fig. 61



Fig. 62

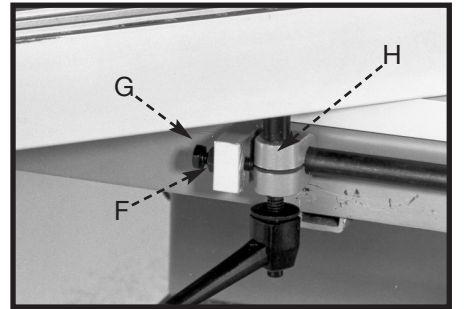

Fig. 63

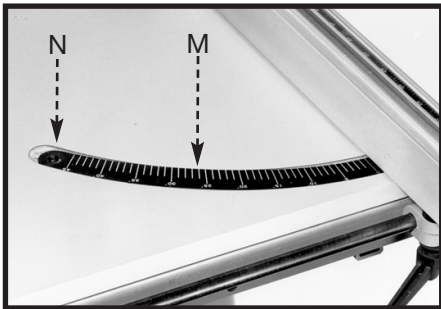

Fig. 64

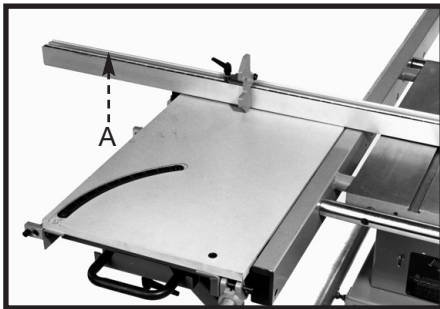

Fig. 65

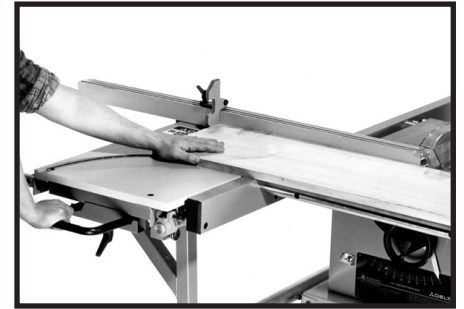

Fig. 66

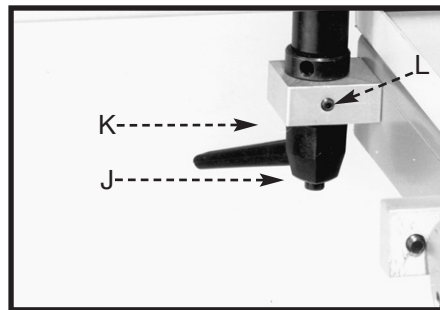

Fig. 67

MOVING FENCE TO REAR POSITION ON SLIDING TABLE

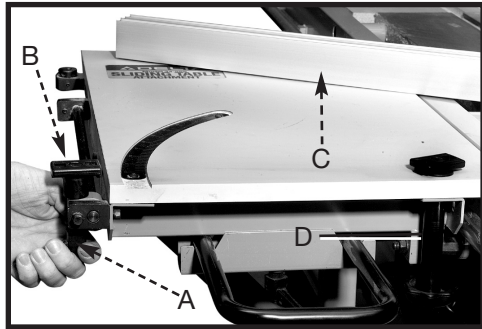

Fig. 68

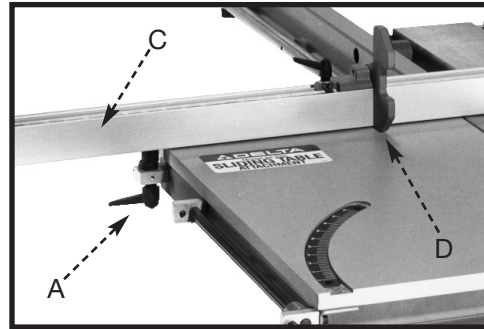

Fig. 69

When you use the fence in the rear position, you increase your cut-off capacity from 24" to 36". To move the fence:

1. Loosen the clamp handle (A) and the clamp knob (D) Fig. 68. Slide the fence (C) Fig. 68 from the two fence clamps (B).
2. Remove the fence locking handle, the clamp knob, and the fence clamps (B) and re-position the fence clamps (B), clamp handle, and clamp knob to the rear of the sliding table (Fig. 68).
3. Slide the fence (C) Fig. 69 back on the fence clamps and tighten the lock handles, one of which is shown at (A).

NOTE: When the fence (C) is used in the rear table position (Fig. 69), flip the fence stop (D) to the front.

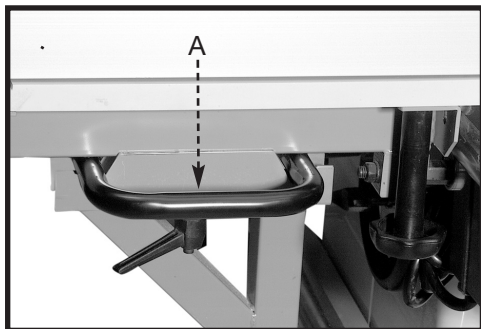

Fig. 70

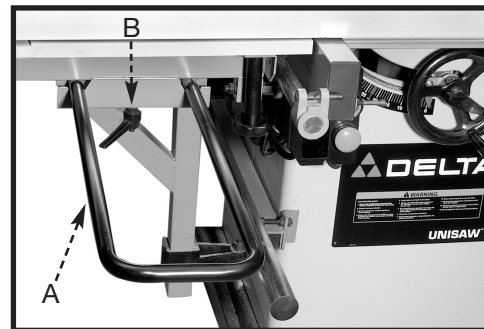

Fig. 71

A handle (A) Figs. 70 and 71 (used to slide the table) is supplied on the front of the sliding table mechanism. Depending on the size of the workpiece and/or operator convenience, you can move the handle (A) (Fig. 70) out by loosening the clamp handle (B) Fig. 71, sliding the handle (A) to the desired position, and tightening the clamp handle (B).



PARTS, SERVICE OR WARRANTY ASSISTANCE

All Delta Machines and accessories are manufactured to high quality standards and are serviced by a network of Porter-Cable • Delta Factory Service Centers and Delta Authorized Service Stations. To obtain additional information regarding your Delta quality product or to obtain parts, service, warranty assistance, or the location of the nearest service outlet, please call 1-800-223-7278 (In Canada call 1-800-463-3582).



Two Year Limited New Product Warranty

Delta will repair or replace, at its expense and at its option, any new Delta machine, machine part, or machine accessory which in normal use has proven to be defective in workmanship or material, provided that the customer returns the product prepaid to a Delta factory service center or authorized service station with proof of purchase of the product within two years and provides Delta with reasonable opportunity to verify the alleged defect by inspection. For all refurbished Delta product, the warranty period is 180 days. Delta may require that electric motors be returned prepaid to a motor manufacturer's authorized station for inspection and repair or replacement. Delta will not be responsible for any asserted defect which has resulted from normal wear, misuse, abuse or repair or alteration made or specifically authorized by anyone other than an authorized Delta service facility or representative. Under no circumstances will Delta be liable for incidental or consequential damages resulting from defective products. This warranty is Delta's sole warranty and sets forth the customer's exclusive remedy, with respect to defective products; all other warranties, express or implied, whether of merchantability, fitness for purpose, or otherwise, are expressly disclaimed by Delta.

PORTER-CABLE • DELTA SERVICE CENTERS (CENTROS DE SERVICIO DE PORTER-CABLE • DELTA)

Parts and Repair Service for Porter-Cable • Delta Machinery are Available at These Locations
(Obtenga Refaccion de Partes o Servicio para su Herramienta en los Sigüientes Centros de Porter-Cable • Delta)

ARIZONA

Tempe 85282 (Phoenix)
2400 West Southern Avenue
Suite 105
Phone: (602) 437-1200
Fax: (602) 437-2200

CALIFORNIA

Ontario 91761 (Los Angeles)
3949A East Guasti Road
Phone: (909) 390-5555
Fax: (909) 390-5554

San Leandro 94577 (Oakland)
3039 Teagarden Street
Phone: (510) 357-9762
Fax: (510) 357-7939

COLORADO

Arvada 80003 (Denver)
8175 Sheridan Blvd., Unit S
Phone: (303) 487-1809
Fax: (303) 487-1868

FLORIDA

Davie 33314 (Miami)
4343 South State Rd. 7 (441)
Unit #107
Phone: (954) 321-6635
Fax: (954) 321-6638

Tampa 33609
4538 W. Kennedy Boulevard
Phone: (813) 877-9585
Fax: (813) 289-7948

GEORGIA

Forest Park 30297 (Atlanta)
5442 Frontage Road,
Suite 112
Phone: (404) 608-0006
Fax: (404) 608-1123

ILLINOIS

Addison 60101 (Chicago)
400 South Rohlwing Rd.
Phone: (630) 424-8805
Fax: (630) 424-8895

Woodridge 60517 (Chicago)
2033 West 75th Street
Phone: (630) 910-9200
Fax: (630) 910-0360

MARYLAND

Elkridge 21075 (Baltimore)
7397-102 Washington Blvd.
Phone: (410) 799-9394
Fax: (410) 799-9398

MASSACHUSETTS

Braintree 02185 (Boston)
719 Granite Street
Phone: (781) 848-9810
Fax: (781) 848-6759

Franklin 02038 (Boston)
Franklin Industrial Park
101E Constitution Blvd.
Phone: (508) 520-8802
Fax: (508) 528-8089

MICHIGAN

Madison Heights 48071 (Detroit)
30475 Stephenson Highway
Phone: (248) 597-5000
Fax: (248) 597-5004

MINNESOTA

Minneapolis 55429
5522 Lakeland Avenue North
Phone: (763) 561-9080
Fax: (763) 561-0653

MISSOURI

North Kansas City 64116
1141 Swift Avenue
Phone: (816) 221-2070
Fax: (816) 221-2897

St. Louis 63119
7574 Watson Road
Phone: (314) 968-8950
Fax: (314) 968-2790

NEW YORK

Flushing 11365-1595 (N.Y.C.)
175-25 Horace Harding Expwy.
Phone: (718) 225-2040
Fax: (718) 423-9619

NORTH CAROLINA

Charlotte 28270
9129 Monroe Road, Suite 115
Phone: (704) 841-1176
Fax: (704) 708-4625

OHIO

Columbus 43214
4560 Indianola Avenue
Phone: (614) 263-0929
Fax: (614) 263-1238

Cleveland 44125
8001 Sweet Valley Drive
Unit #19
Phone: (216) 447-9030
Fax: (216) 447-3097

OREGON

Portland 97230
4916 NE 122 nd Ave.
Phone: (503) 252-0107
Fax: (503) 252-2123

PENNSYLVANIA

Willow Grove 19090
520 North York Road
Phone: (215) 658-1430
Fax: (215) 658-1433

TEXAS

Carrollton 75006 (Dallas)
1300 Interstate 35 N, Suite 112
Phone: (972) 446-2996
Fax: (972) 446-8157

Houston 77055
West 10 Business Center
1008 Wirt Road, Suite 120
Phone: (713) 682-0334
Fax: (713) 682-4867

WASHINGTON

Auburn 98001(Seattle)
3320 West Valley HWY, North
Building D, Suite 111
Phone: (253) 333-8353
Fax: (253) 333-9613

Authorized Service Stations are located in many large cities. Telephone **800-438-2486** or **731-541-6042** for assistance locating one. Parts and accessories for Porter-Cable-Delta products should be obtained by contacting any Porter-Cable-Delta Distributor, Authorized Service Center, or Porter-Cable-Delta Factory Service Center. If you do not have access to any of these, call **800-223-7278** and you will be directed to the nearest Porter-Cable-Delta Factory Service Center. Las Estaciones de Servicio Autorizadas están ubicadas en muchas grandes ciudades. Llame al **800-438-2486** ó al **731-541-6042** para obtener asistencia a fin de localizar una. Las piezas y los accesorios para los productos Porter-Cable-Delta deben obtenerse poniéndose en contacto con cualquier distribuidor Porter-Cable-Delta, Centro de Servicio Autorizado o Centro de Servicio de Fábrica Porter-Cable-Delta. Si no tiene acceso a ninguna de estas opciones, llame al **800-223-7278** y le dirigirán al Centro de Servicio de Fábrica Porter-Cable-Delta más cercano.

CANADIAN PORTER-CABLE • DELTA SERVICE CENTERS

ALBERTA

Bay 6, 2520-23rd St. N.E.
Calgary, Alberta
T2E 8L2
Phone: (403) 735-6166
Fax: (403) 735-6144

BRITISH COLUMBIA

8520 Baxter Place
Burnaby, B.C.
V5A 4T8
Phone: (604) 420-0102
Fax: (604) 420-3522

MANITOBA

1699 Dublin Avenue
Winnipeg, Manitoba
R3H 0H2
Phone: (204) 633-9259
Fax: (204) 632-1976

ONTARIO

505 Southgate Drive
Guelph, Ontario
N1H 6M7
Phone: (519) 836-2840
Fax: (519) 767-4131

QUÉBEC

1515 ave.
St-Jean Baptiste,
Québec, Québec
G2E 5E2
Phone: (418) 877-7112
Fax: (418) 877-7123

1447, Begin
St-Laurent, (Montréal),
Québec
H4R 1V8
Phone: (514) 336-8772
Fax: (514) 336-3505

The following are trademarks of PORTER-CABLE-DELTA (Las siguientes son marcas registradas de PORTER-CABLE S.A.): Auto-Set®, BAMMER®, B.O.S.S.®, Builder's Saw®, Contractor's Saw®, Contractor's Saw II™, Delta®, DELTACRAFT®, DELTAGRAM™, Delta Series 2000™, DURATRONIC™, Emc2™, FLEX®, Flying Chips™, FRAME SAW®, Homecraft®, INNOVATION THAT WORKS®, Jet-Lock®, JETSTREAM®, 'kickstand', LASERLOC®, MICRO-SET®, Micro-Set®, MIDI LATHE®, MORTEN™, NETWORK™, OMNIJIG®, POCKET CUTTER®, PORTA-BAND®, PORTA-PLANE®, PORTER-CABLE®&(design), PORTER-CABLE®PROFESSIONAL POWER TOOLS, Posi-Matic®, Q-3®&(design), QUICKSAND®&(design), QUICKSET™, QUICKSET II®, QUICKSET PLUS™, RIPTIDE™&(design), SAFE GUARD II®, SAFE-LOC®, Sanding Center®, SANDTRAP®&(design), SAW BOSS®, Sawbuck™, Sidekick®, SPEED-BLOC®, SPEEDMATIC®, SPEEDTRONIC®, STAIR EASE®, The American Woodshop®&(design), The Lumber Company®&(design), THE PROFESSIONAL EDGE®, THE PROFESSIONAL SELECT®, THIN-LINE™, TIGER®, TIGER CUB®, TIGER SAW®, TORQBUSTER®, TORQ-BUSTER®, TRU-MATCH™, TWIN-LITE®, UNIGUARD®, Unifence®, UNIFEEDE™, Unihead®, Uniplane™, Unirip®, Unisaw®, Univise®, Versa-Feeder®, VERSA-PLANE®, WHISPER SERIES®, WOODWORKER'S CHOICE™.

Trademarks noted with ™ and ® are registered in the United States Patent and Trademark Office and may also be registered in other countries. Las Marcas Registradas con el signo de ™ y ® son registradas por la Oficina de Registros y Patentes de los Estados Unidos y también pueden estar registradas en otros países.

Free Manuals Download Website

<http://myh66.com>

<http://usermanuals.us>

<http://www.somanuals.com>

<http://www.4manuals.cc>

<http://www.manual-lib.com>

<http://www.404manual.com>

<http://www.luxmanual.com>

<http://aubethermostatmanual.com>

Golf course search by state

<http://golfingnear.com>

Email search by domain

<http://emailbydomain.com>

Auto manuals search

<http://auto.somanuals.com>

TV manuals search

<http://tv.somanuals.com>