

# DJ-15 6" Jointer

INSTRUCTION MANUAL



DATED 11-28-95

PART NO. 1340235

© Delta International Machinery Corp. 1995

 **DELTA**

# TABLE OF CONTENTS

SAFETY RULES FOR ALL TOOLS .....	3
ADDITIONAL SAFETY RULES FOR JOINTER .....	4
UNPACKING AND ASSEMBLY INSTRUCTIONS .....	4
Unpacking And Cleaning The Jointer .....	4
Stand And Electricals .....	5
Assembling Jointer To Stand Or Bench .....	5
Assembling Fence .....	6
Assembling Rabbeting Ledge .....	7
Assembling Cutterhead Guard .....	7
Assembling Motor Pulley .....	7
Assembling Belt, Aligning Pulleys .....	8
Adjusting Belt Tension .....	8
Assembling Cutterhead Pulley And Belt Guard .....	8
ELECTRICAL CONNECTIONS .....	9
Single Phase Installation .....	9
Three Phase Installation .....	9
Changing Voltage .....	9
Cutterhead Rotation .....	9
OPERATING CONTROLS AND ADJUSTMENTS .....	10
Start/Stop Switch .....	10
Fence Operation .....	10
ADJUSTING FENCE POSITIVE STOPS .....	11
90 Degree Positive Stop .....	11
45 Degree Inward Positive Stop .....	12
45 Degree Outward Positive Stop .....	12
Infeed Table Adjustments .....	13
Outfeed Table Adjustments .....	13
MAINTENANCE .....	14
Removing, Replacing And Resetting Knives .....	14
Adjusting Knives .....	14
OPERATION .....	15
Placement Of Hands During Feeding .....	15
Jointing Short Or Thin Wood .....	15
Rabbeting .....	15
Jointing An Edge .....	16
Jointing Warped Wood .....	16
Planing/Surfacing .....	16
Direction Of Grain .....	16
Beveling .....	17
Taper Cuts .....	17
PARTS, SERVICE OR WARRANTY ASSISTANCE .....	18
WARRANTY .....	18

# SAFETY RULES

Woodworking can be dangerous if safe and proper operating procedures are not followed. As with all machinery, there are certain hazards involved with the operation of the product. Using the machine with respect and caution will considerably lessen the possibility of personal injury. However, if normal safety precautions are overlooked or ignored, personal injury to the operator may result. Safety equipment such as guards, push sticks, hold-downs, featherboards, goggles, dust masks and hearing protection can reduce your potential for injury. But even the best guard won't make up for poor judgment, carelessness or inattention. Always use common sense and exercise caution in the workshop. If a procedure feels dangerous, don't try it. Figure out an alternative procedure that feels safer. REMEMBER: Your personal safety is your responsibility.

This machine was designed for certain applications only. Delta Machinery strongly recommends that this machine not be modified and/or used for any application other than that for which it was designed. If you have any questions relative to a particular application, DO NOT use the machine until you have first contacted Delta to determine if it can or should be performed on the product.

DELTA INTERNATIONAL MACHINERY CORP.  
MANAGER OF TECHNICAL SERVICES  
246 ALPHA DRIVE  
PITTSBURGH, PENNSYLVANIA 15238  
(IN CANADA: 644 IMPERIAL ROAD, GUELPH, ONTARIO N1H 6M7)

## WARNING: FAILURE TO FOLLOW THESE RULES MAY RESULT IN SERIOUS PERSONAL INJURY

- 1. FOR YOUR OWN SAFETY, READ INSTRUCTION MANUAL BEFORE OPERATING THE TOOL.** Learn the tool's application and limitations as well as the specific hazards peculiar to it.
- 2. KEEP GUARDS IN PLACE** and in working order.
- 3. ALWAYS WEAR EYE PROTECTION.**
- 4. GROUND ALL TOOLS.** If tool is equipped with three-prong plug, it should be plugged into a three-hole electrical receptacle. If an adapter is used to accommodate a two-prong receptacle, the adapter lug must be attached to a known ground. Never remove the third prong.
- 5. REMOVE ADJUSTING KEYS AND WRENCHES.** Form habit of checking to see that keys and adjusting wrenches are removed from tool before turning it "on."
- 6. KEEP WORK AREA CLEAN.** Cluttered areas and benches invite accidents.
- 7. DON'T USE IN DANGEROUS ENVIRONMENT.** Don't use power tools in damp or wet locations, or expose them to rain. Keep work area well-lighted.
- 8. KEEP CHILDREN AND VISITORS AWAY.** All children and visitors should be kept a safe distance from work area.
- 9. MAKE WORKSHOP CHILDPROOF** - with padlocks, master switches, or by removing starter keys.
- 10. DON'T FORCE TOOL.** It will do the job better and be safer at the rate for which it was designed.
- 11. USE RIGHT TOOL.** Don't force tool or attachment to do a job for which it was not designed.
- 12. WEAR PROPER APPAREL.** No loose clothing, gloves, neckties, rings, bracelets, or other jewelry to get caught in moving parts. Nonslip footwear is recommended. Wear protective hair covering to contain long hair.
- 13. ALWAYS USE SAFETY GLASSES.** Wear safety glasses (must comply with ANSI Z87.1). Everyday eyeglasses only have impact resistant lenses; they are not safety glasses. Also use face or dust mask if cutting operation is dusty.
- 14. SECURE WORK.** Use clamps or a vise to hold work when practical. It's safer than using your hand and frees both hands to operate tool.
- 15. DON'T OVERREACH.** Keep proper footing and balance at all times.
- 16. MAINTAIN TOOLS IN TOP CONDITION.** Keep tools sharp and clean for best and safest performance. Follow instructions for lubricating and changing accessories.
- 17. DISCONNECT TOOLS** before servicing and when changing accessories such as blades, bits, cutters, etc.
- 18. USE RECOMMENDED ACCESSORIES.** The use of accessories and attachments not recommended by Delta may cause hazards or risk of injury to persons.
- 19. REDUCE THE RISK OF UNINTENTIONAL STARTING.** Make sure switch is in "OFF" position before plugging in power cord.
- 20. NEVER STAND ON TOOL.** Serious injury could occur if the tool is tipped or if the cutting tool is accidentally contacted.
- 21. CHECK DAMAGED PARTS.** Before further use of the tool, a guard or other part that is damaged should be carefully checked to ensure that it will operate properly and perform its intended function - check for alignment of moving parts, binding of moving parts, breakage of parts, mounting, and any other conditions that may affect its operation. A guard or other part that is damaged should be properly repaired or replaced.
- 22. DIRECTION OF FEED.** Feed work into a blade or cutter against the direction of rotation of the blade or cutter only.
- 23. NEVER LEAVE TOOL RUNNING UNATTENDED. TURN POWER OFF.** Don't leave tool until it comes to a complete stop.
- 24. DRUGS, ALCOHOL, MEDICATION.** Do not operate tool while under the influence of drugs, alcohol or any medication.
- 25. MAKE SURE TOOL IS DISCONNECTED FROM POWER SUPPLY** while motor is being mounted, connected or reconnected.
- 26. WARNING:** The dust generated by certain woods and wood products can be injurious to your health. Always operate machinery in well ventilated areas and provide for proper dust removal. Use wood dust collection systems whenever possible.



# ADDITIONAL SAFETY RULES FOR JOINTERS

1. **AVOID KICKBACKS.** A kickback occurs when the workpiece is thrown back by the cutterhead toward the infeed table. Never pass hands directly over the cutterhead. When a kickback occurs an injury can result. Some of the causes of kickback include:

- A. Dull and improperly adjusted knives.
- B. Knots, nails or imperfections in the workpiece.
- C. Taking too deep a cut in one pass.
- D. Failure to use adequate hold-downs/push blocks when jointing or surfacing short, thin or narrow work.

2. **IF YOU ARE NOT** thoroughly familiar with the operation of jointers, obtain advice from your supervisor, instructor or other qualified person.

3. **MAKE SURE** wiring codes and recommended electrical correction instructions are followed, and that the machine is properly grounded.

4. **MAKE** all adjustments with the power off.

5. **MAINTAIN** the proper relationship of infeed and outfeed table surfaces and cutterhead knife path.

6. **MAKE SURE** the cutterhead is not contacting the workpiece before turning on the power.

7. **KEEP** knives sharp and cutterhead and knives free of all rust and pitch.

8. **ALWAYS** keep hands and fingers away from the blade when the machine is running.

9. **ALWAYS** keep cutterhead guard in place when performing a jointing or planing operation. Check guard operation periodically to make certain that it operates freely.

## 10. DEFINITIONS OF JOINTING AND PLANING OPERATIONS:

A. **Jointing Operations** - Jointing cuts or edge jointing are made to square an edge of a workpiece. The workpiece is positioned on the jointer with the narrow edge of the workpiece on the infeed table and the major flat surface of the workpiece against the fence. The workpiece is moved from the infeed table across the cutterhead to the outfeed table.

B. **Planing Operations** - Planing or surfacing is similar to the jointing operation except for the position of the workpiece. For planing, the major flat surface of the workpiece is placed on the table of the jointer with the narrow edge of the workpiece against the fence.

11. **ALWAYS** use hold-downs/push blocks for jointing material less than 3 inches in height or planing material less than 3 inches thick.

12. **DO NOT** perform jointing or planing operations on material shorter than 10 inches.

13. **NEVER** perform a planing operation on material wider than 6 inches.

14. **NEVER** make a jointing or planing cut deeper than 1/8".

15. **SUPPORT** the workpiece adequately at all times during operation; maintain control of the workpiece at all times.

16. **DO NOT** back the work toward the infeed table. Always feed workpiece against cutterhead direction of rotation.

17. **DO NOT** attempt to perform an unfamiliar operation without study and the use of adequate hold-downs/push blocks, jigs, fixtures, stops, etc.

18. **STOP** the machine before removing chips.

19. **DISCONNECT** machine from the power source before making repairs.

20. **REPLACE** all guards after servicing.

21. **THE USE** of attachments and accessories not recommended by Delta may result in the risk of injuries.

22. **ADDITIONAL** Information regarding the safe and proper operation of this product is available from the National Safety Council, 1121 Spring Lake Drive, Itasca, IL 60143-3201 in the Accident Prevention Manual for Industrial Operations and also in the Safety Data Sheets provided by the NSC. Please also refer to the American National Standards Institute ANSI 01.1 Safety Requirements for Woodworking Machinery and the U.S. Department of Labor OSHA 1910.213 Regulations.

23. **SAVE THESE INSTRUCTIONS.** Refer to them often and use them to instruct others.

---

## UNPACKING AND ASSEMBLY INSTRUCTIONS

### UNPACKING AND CLEANING THE JOINTER

Carefully unpack the jointer and all loose items from the carton. Remove the protective coating from the machined surfaces of the jointer. This coating may be removed with a soft cloth moistened with kerosene (do not use acetone, gasoline, or lacquer thinner for this purpose). After cleaning, cover all unpainted surfaces with a good quality paste wax.

# STAND AND ELECTRICALS

If you purchased your jointer complete with stand and electricals, factory mounted and wired, the stand is shipped with the motor and switch completely wired and assembled to the stand, as shown in Fig. 2.

## ASSEMBLING JOINTER TO STAND OR BENCH

If the jointer is to be used with the stand shown in Fig. 2, the outfeed end of the jointer is to be at the same end of the stand as the chip chute (A) Fig. 2. Line up the four holes (B) Fig. 3, on the top of the stand with the four threaded holes on the bottom of the jointer base and fasten the jointer to the stand using the four 1" long socket head cap screws and lockwashers supplied.

If the jointer is to be used without the stand shown in Fig. 2, we recommend that the jointer be fastened to a supporting surface using the four threaded holes in the jointer base. Fig. 4, illustrates the size and center to center distance of the holes to be drilled in the supporting surface. **IMPORTANT:** Care must be taken that an opening is provided in the supporting surface to facilitate the removal of wood chips. The location and size of this opening is shown in Fig. 4. **NOTE:** If the motor is going to be located below the jointer an opening must also be provided for the belt.

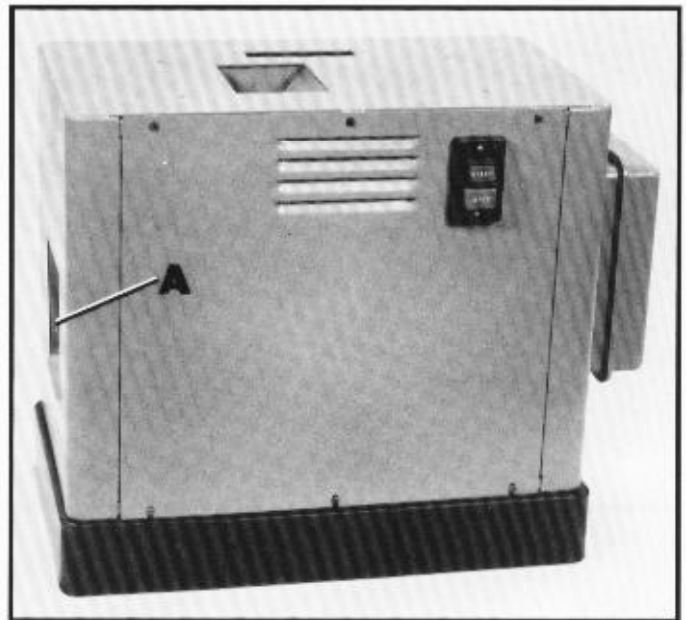

Fig. 2

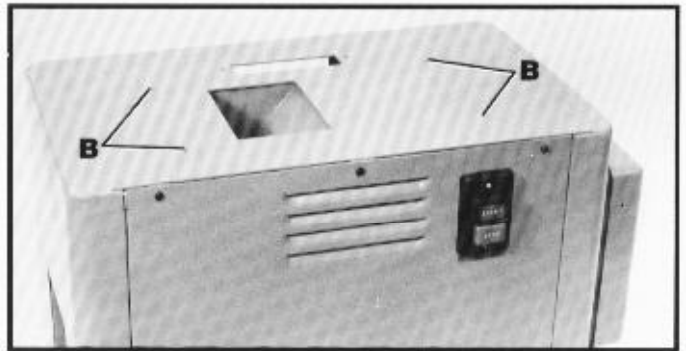

Fig. 3

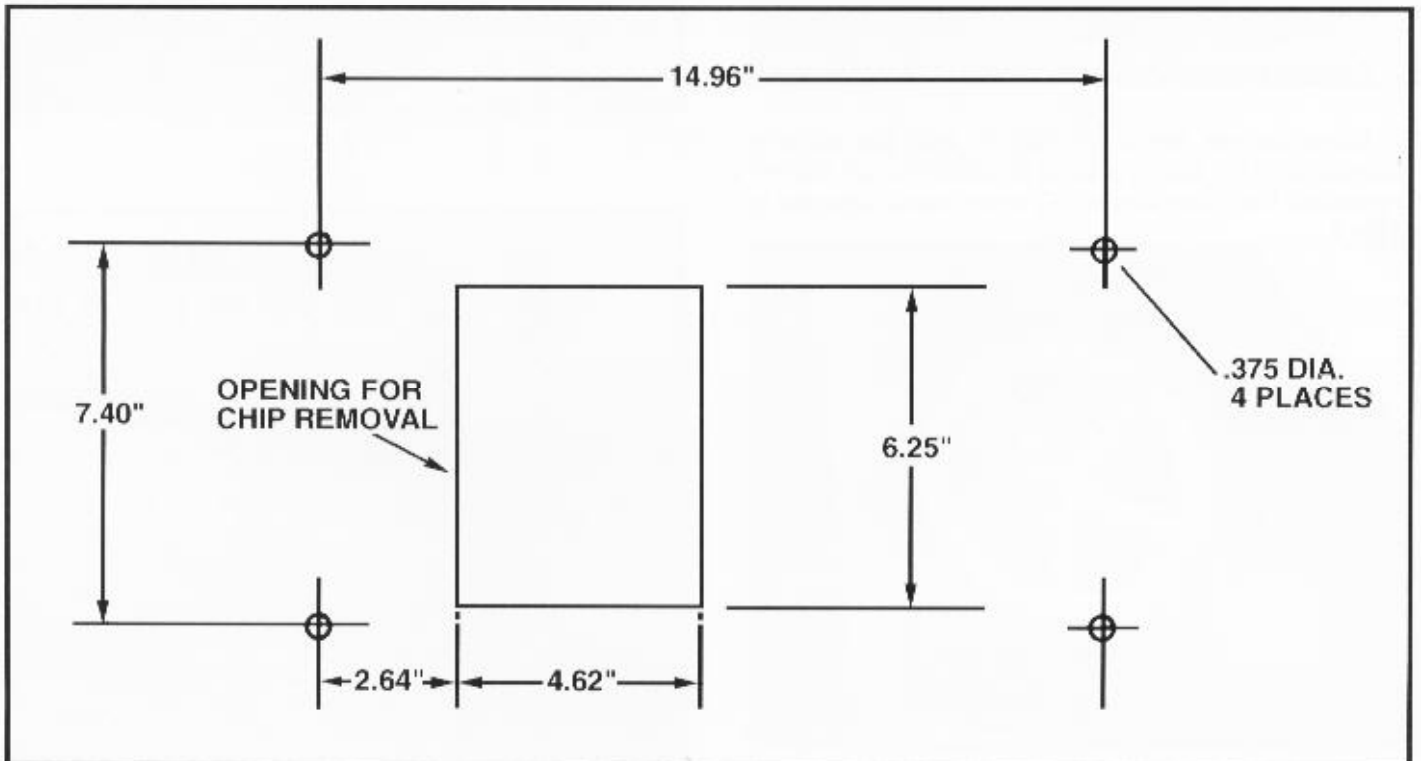

Fig. 4

# ASSEMBLING FENCE

1. Assemble the fence carriage (A) Fig. 5, and fence sliding bracket (B) to the side of the jointer base using the two 1-3/16" long socket head cap screws and washers (C).  
**NOTE:** The top surface (D) Fig. 6, of the fence carriage (A) must be level with the top surface of the outfeed table (E), to enable the fence to slide easily.

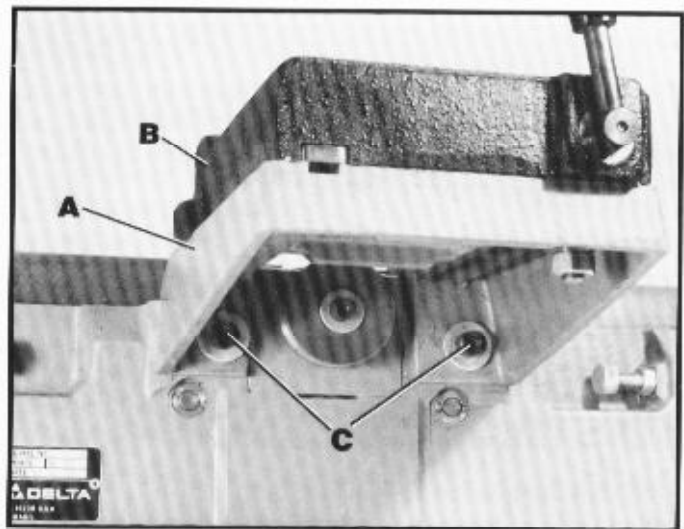

Fig. 5

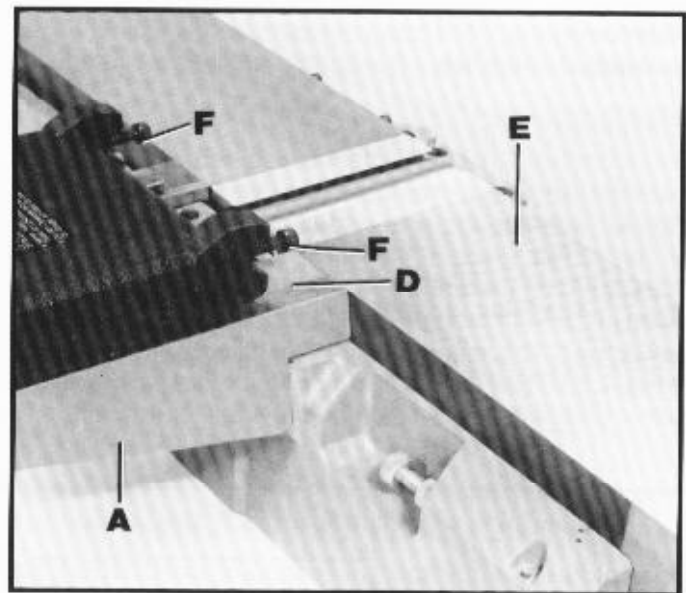

Fig. 6

2. Remove the two screws (F) Fig. 6.

3. Assemble the fence (G) Fig. 7, with the pivoting brackets (H) to the sliding bracket (B) using the two 1-3/16" long socket head cap screws (F) which were removed in STEP 2.

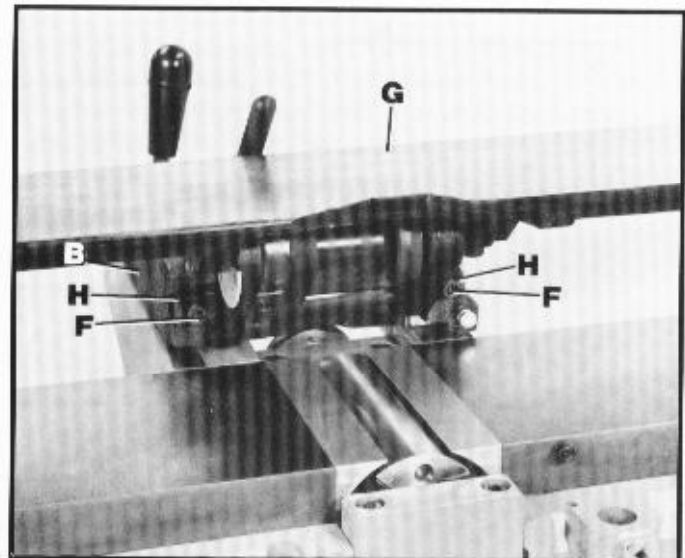

Fig. 7

## ASSEMBLING RABBETING LEDGE

Assemble the rabbeting ledge (A) Fig. 8, to the side of the infeed table using the two 3/4" long socket head cap screws (B). **NOTE:** The rabbeting ledge must be level with the top surface of the infeed table (C).

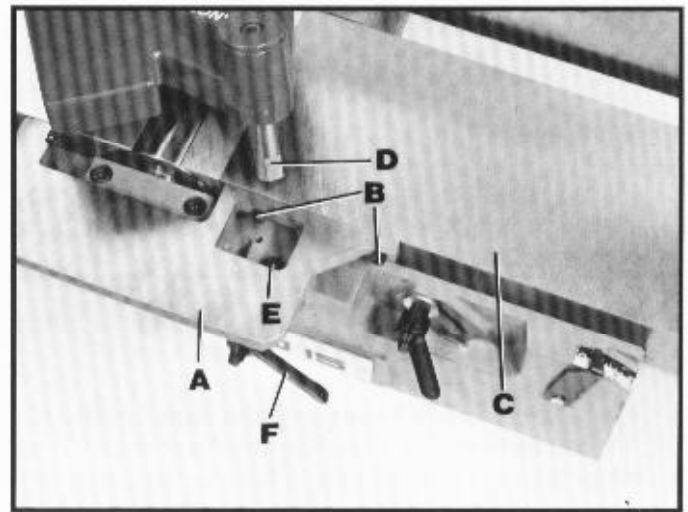

Fig. 8

## ASSEMBLING CUTTERHEAD GUARD

**CAUTION: WEAR HAND PROTECTION AND AVOID HAND CONTACT WITH THE CUTTERHEAD BLADE WHEN INSTALLING CUTTERHEAD GUARD.**

To assemble the cutterhead guard, insert post (D) Fig. 8, into hole (E) and tighten locking lever (F) against flat on post.

Fig. 9, illustrates the cutterhead guard assembled on the jointer. **IMPORTANT:** Make certain that the guard operates freely and does not bind or hang-up. Always check guard operation before applying power to the jointer.

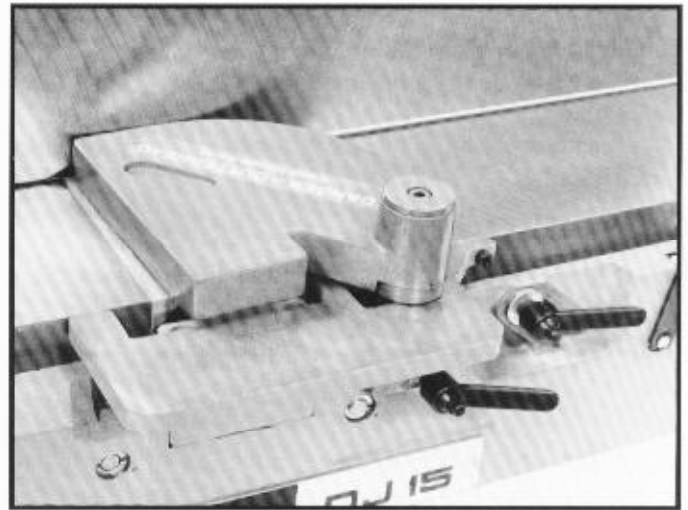

Fig. 9

## ASSEMBLING MOTOR PULLEY

To assemble the motor pulley, remove the back panel of the jointer stand. Assemble motor pulley (C) Fig. 10, to the motor shaft with the hub of the pulley in the out position as shown. Tighten set screw (D) against the key in the motor shaft.

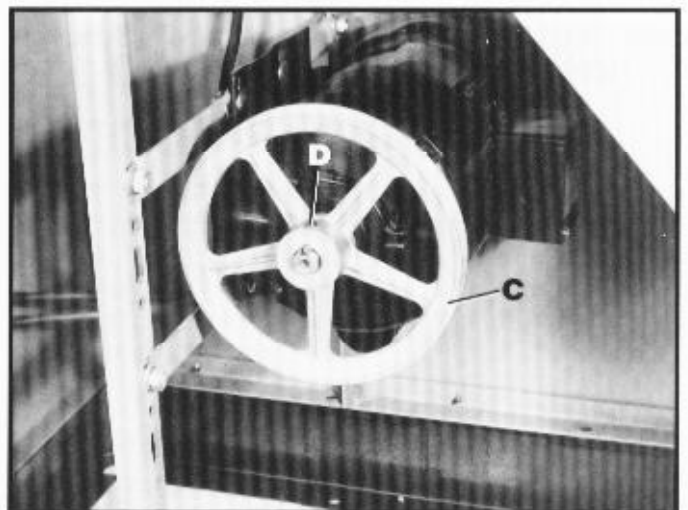

Fig. 10



## ASSEMBLING BELT, ALIGNING PULLEYS

To assemble the drive belt proceed as follows:

1. Place the belt (A) Fig. 11, around the cutterhead pulley (B), down thru the hole in the jointer stand and around the motor pulley (C) as shown.
2. Using a straight edge, make certain the motor pulley (C) Fig. 11, is aligned with the cutterhead pulley (B).
3. If an adjustment is necessary, the motor pulley (C) Fig. 11, can be moved in or out on the motor shaft (D), or the motor (E) can be moved along the mounting bars (F).

## ADJUSTING BELT TENSION

Correct belt tension is obtained when there is approximately 1" deflection in the center span of the belt (A) Fig. 11, using light finger pressure. If an adjustment is necessary, it can be made by the following methods:

1. Raising or lowering the motor on the motor mounting bars (F) Fig. 11.
2. If a major adjustment is needed, the motor mounting bars (F) Fig. 11, can be repositioned on the two posts (G).

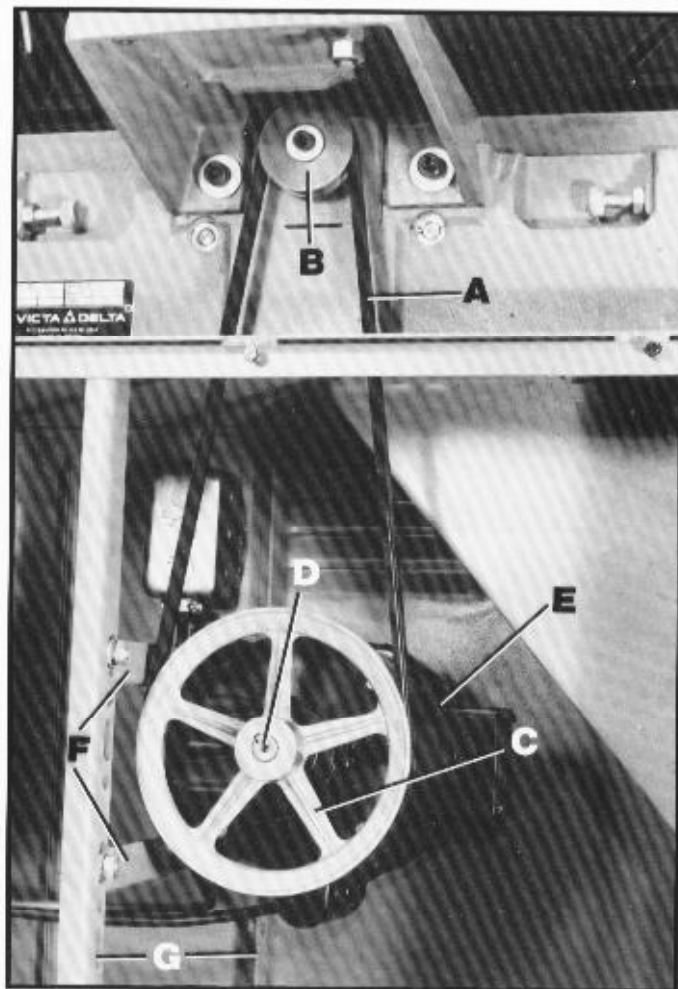

Fig. 11

## ASSEMBLING CUTTERHEAD PULLEY AND BELT GUARD

To assemble the cutterhead belt and pulley guard (A) Fig. 12, position the guard on the jointer stand and hold in place using the two 5/8" long screws (B), washers and hex nuts supplied.

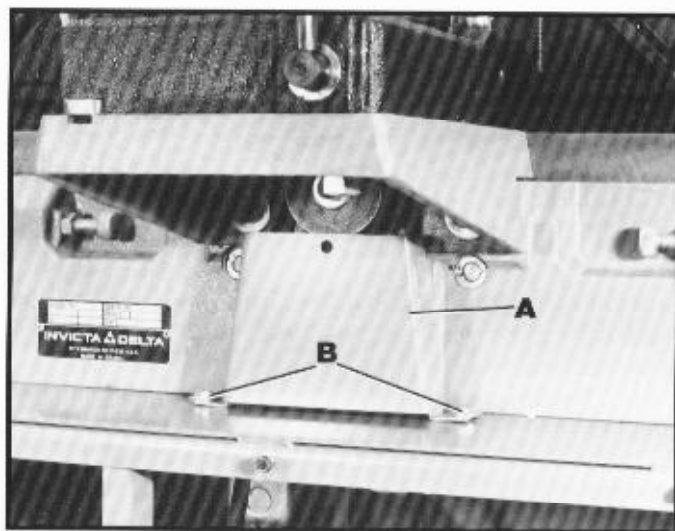

Fig. 12



# ELECTRICAL CONNECTIONS

The electrical rating of the DJ-15 6" Jointer is either 115/230 Volt, Single Phase or 200-230/460 Volt Three Phase.

Before connecting your machine to an electrical power system, be sure the motor rating agrees with the electrical system it is to be connected to. We also recommend that #14 wire, fused with a 20 amp, dual element time lag fuse, be used to supply power to all machines regardless of their electrical rating.

## SINGLE PHASE INSTALLATION

If the motor on your machine is wired for 115 Volt, Single Phase, the power cord is equipped with a plug that has two flat, parallel current-carrying prongs and one longer round or "U"-shaped, ground prong which requires a mating 3-conductor grounded type receptacle, as shown in Fig. 13.

If the motor on your machine is wired for 230 Volt, Single Phase, the power cord is equipped with a plug that has two flat, current-carrying prongs in tandem, and one round or "U"-shaped longer ground prong. This is used only with the proper mating 3-conductor grounding type receptacle, as shown in Fig. 14.

When either the 115 Volt or 230 Volt three prong plug on your machine is plugged into a grounded 3-conductor receptacle, the long ground prong on the plug contacts first so the machine is properly grounded before electricity reaches it.

**WARNING: IN ALL CASES, MAKE CERTAIN THE RECEPTACLE IN QUESTION IS PROPERLY GROUNDED. IF YOU ARE NOT SURE, HAVE A CERTIFIED ELECTRICIAN CHECK THE RECEPTACLE.**

## THREE PHASE INSTALLATION

If the motor on your machine is wired for 200, 230 or 460 Volts, Three Phase, refer to the electrical instruction manual supplied with your machine for instructions on how to connect electrical power.

## CHANGING VOLTAGE

The single phase 3/4 H.P. (push button switch only), 6" Jointer is supplied wired for 115 Volts. If you desire to change the voltage on this unit it is necessary to disconnect the machine from the power source, reconnect the leads in the motor junction box, as shown on the motor nameplate, and change the plug to a 230 Volt plug.

If you desire to change the voltage on either the single or three phase, 3/4 H.P., 6" Jointer that is equipped with 24 Volt push button station, magnetic starter, transformer and 3-leg overload protection, refer to the "**CHANGING VOLTAGE OF THE LVC MOTOR STARTER**" section in the electrical manual supplied with your jointer. The following steps must be completed:

1. **DISCONNECT THE MACHINE FROM THE POWER SOURCE.**

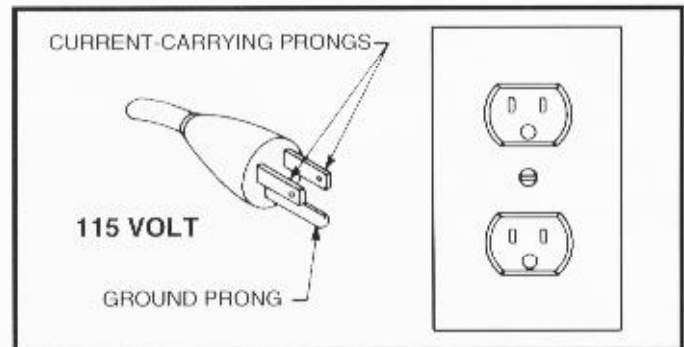

Fig. 13

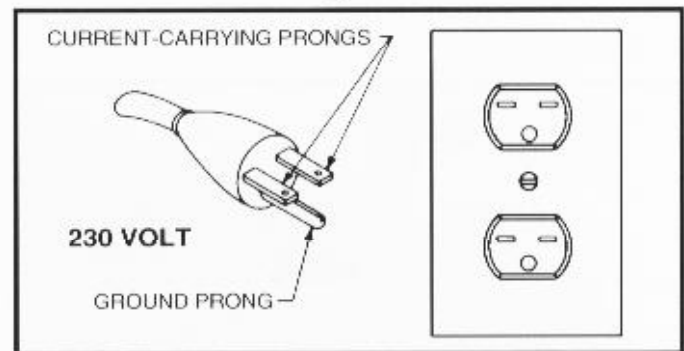

Fig. 14

2. Move the transformer primary pigtail to the proper terminal corresponding to the new input voltage.

3. Change the leads in the motor junction box for the proper line voltage, as shown on the motor nameplate.

4. Change the heater elements in the overload block for the proper voltage/ampereage, as shown on the motor nameplate. The correct heater elements can be identified by referring to the chart inside the motor starter box.

## CUTTERHEAD ROTATION

**IMPORTANT:** The rotation of the cutterhead must be in a clockwise direction when viewed from the left side of the machine; that is, the knives must be rotating toward the infeed table from the top. If the cutterhead rotation is incorrect, disconnect the machine from the power source and proceed as follows:

**Single Phase Machines** - Interchange leads T5 and T8 in the motor junction box.

**Three Phase Machines** - Interchange any two of the three incoming power lines.

# OPERATING CONTROLS AND ADJUSTMENTS

## START/STOP SWITCH

The start/stop switch is mounted on the jointer stand panel for easy accessibility. To start the machine, simply press the start button (A) Fig. 15; to stop the machine, press the stop button (B).

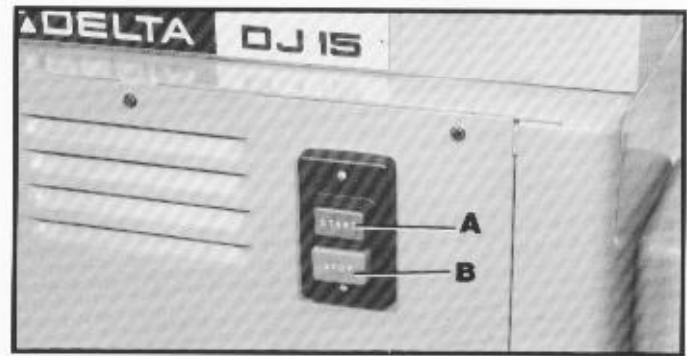

Fig. 15

## FENCE OPERATION

The fence can be moved across the table by loosening lock lever (A) Fig. 16, sliding the fence (B) to the desired position and retightening locking lever (A). As the fence is moved across the table, the sliding bracket (C) guards the cutterhead in back of the fence as shown.

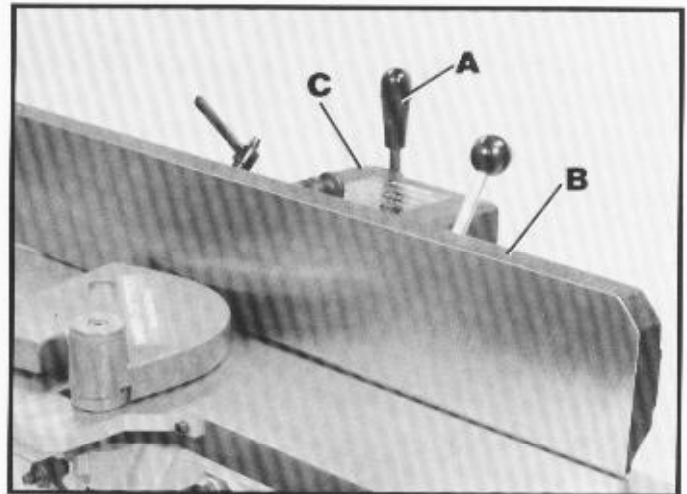

Fig. 16

To tilt the fence to the right or left, loosen handle (D) Fig. 17, pull out and turn plunger (E), and move the fence tilting lever (F) to obtain the desired angle of tilt; retighten locking handle (D). **NOTE:** The handle (D) Fig. 17, is spring-loaded, and can be repositioned by pulling out the handle and repositioning it on the serrated nut located underneath the handle.

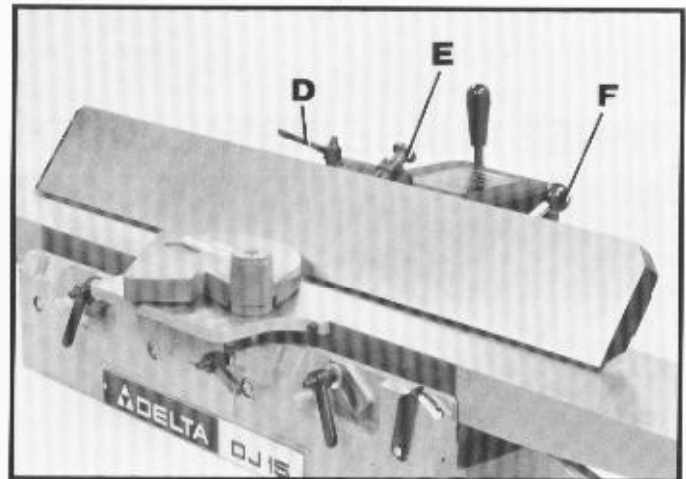

Fig. 17

**IMPORTANT:** When cutting a bevel, we suggest that whenever possible, the fence be tilted toward the table as shown in Fig. 18. The fence will then form a V-shape with the tables and the work is easily pressed into the pocket while passing across the knives.



Fig. 18

# ADJUSTING FENCE POSITIVE STOPS

The fence on the jointer is equipped with positive stops at 90 degrees and 45 degrees right and left.

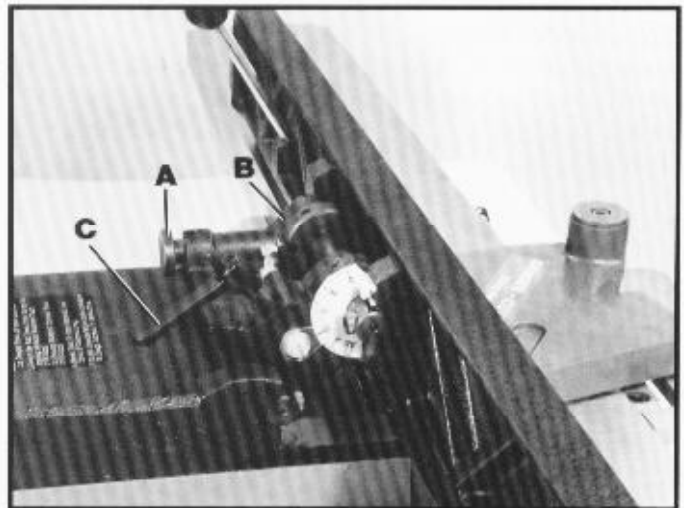

Fig. 19

## 90 DEGREE POSITIVE STOP

To check the accuracy of the positive stops, position the fence at 90 degrees to the table by making certain the end of plunger (A) Fig. 19, is engaged in notch in the index collar (B) as shown, and tighten lockhandle (C). Place a square (D) Fig. 20, on the jointer table and against the fence (E).

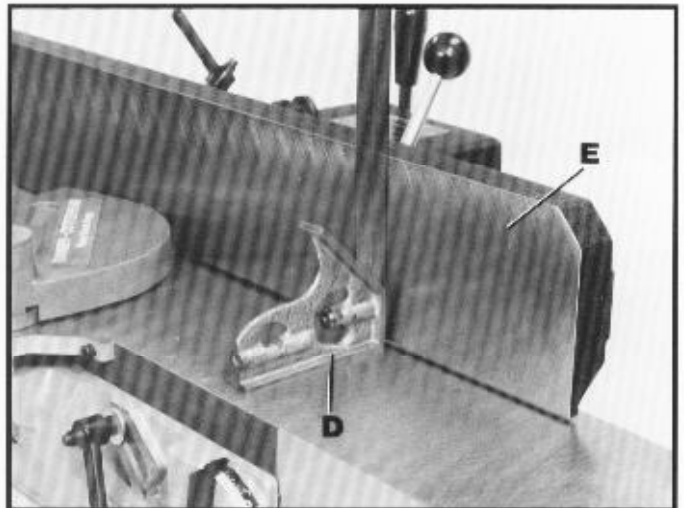

Fig. 20

If an adjustment is necessary, proceed as follows:

1. Loosen set screw (F) Fig. 21, in the index collar and loosen the fence locking handle (C).
2. Tilt the fence (C) Fig. 21, until you are certain the fence is 90 degrees to the table surface; tighten lockhandle (C) and set screw (F).
3. Set the angle of tilt scale (G) Fig. 21, to the proper degree mark by loosening screw (H) and adjusting the pointer.

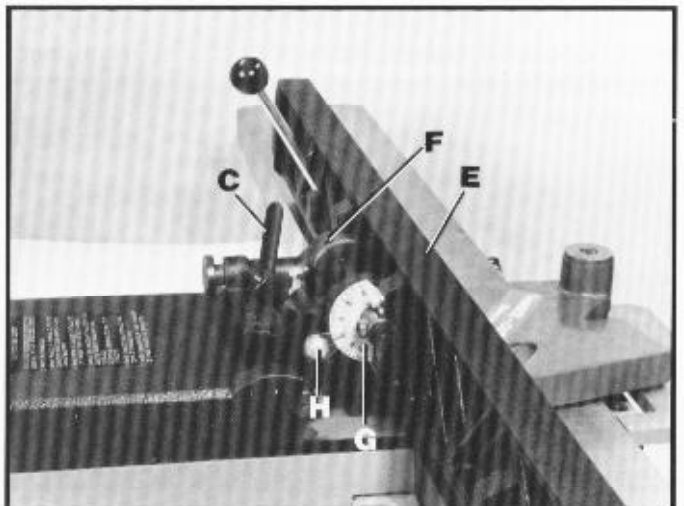

Fig. 21

## 45 DEGREE INWARD POSITIVE STOP

To check the accuracy of the positive stops at 45 degree inward angle of tilt, position the fence (E) Fig. 22, inward as far as possible. Use a combination square (D), and check to see if the fence is tilted inward accurately at 45 degrees. If an adjustment is necessary, proceed as follows:

1. Loosen lockhandle (C) Fig. 22.
2. Loosen locknut (A) Fig. 23, and turn adjustment screw (B) until the fence (E) is set accurately at 45 degrees to the table surface.
3. Retighten locknut (A) Fig. 23.

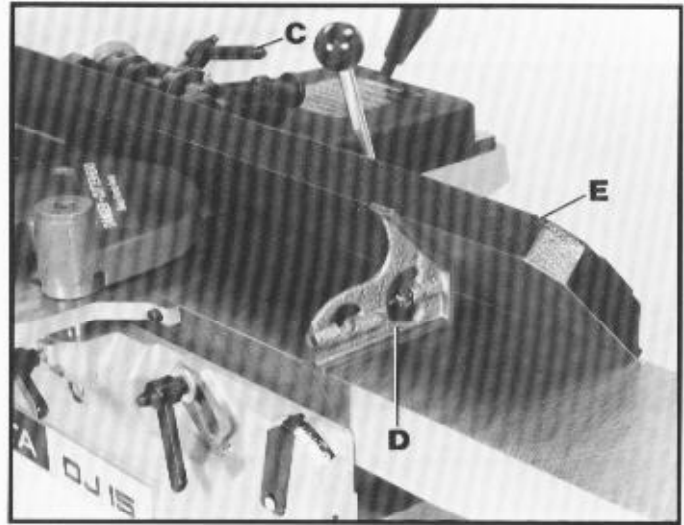

Fig. 22

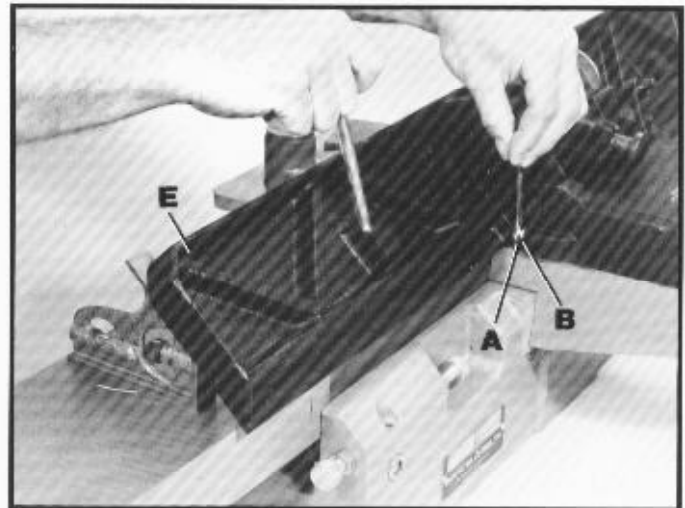

Fig. 23

## 45 DEGREE OUTWARD POSITIVE STOP

To check the accuracy of the positive stops at the 45 degree outward angle of tilt, position the fence (E) Fig. 24, outward as far as possible. Use a combination square (D) and check to see if the fence is tilted outward accurately at 45 degrees. If an adjustment is necessary, proceed as follows:

1. Loosen lockhandle (C) Fig. 24.
2. Loosen locknut (K) Fig. 24, and turn adjustment screw (L) until the fence (E) is set at 45 degrees with the table surface.
3. Retighten locknut (K) Fig. 24, and lockhandle (C).

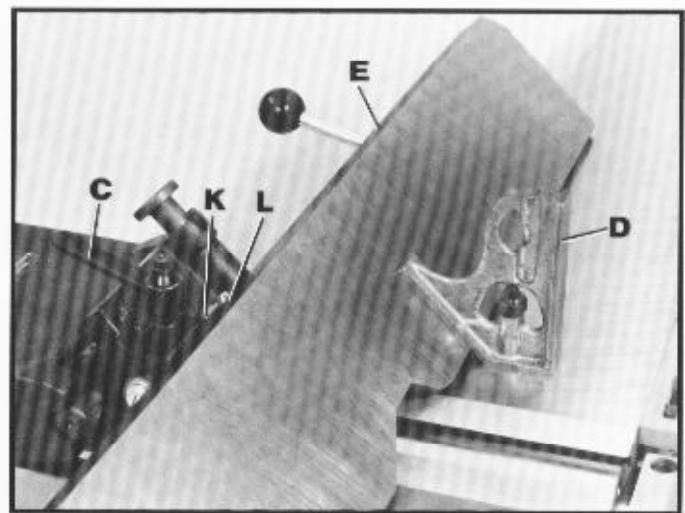

Fig. 24



## INFEEED TABLE ADJUSTMENTS

To raise or lower the infeed table, loosen table lockhandle (A) Fig. 25, and move the table raising and lowering hand lever (B), up or down until the table is at the desired position and tighten table lockhandle (A). **NOTE:** The table lockhandle (A) can be repositioned by pulling out the handle and repositioning it on the serrated nut located under the handle.

The depth of cut of the infeed table (position of table in relationship with the cutting circle) can be read with the pointer and scale (C) Fig. 25.

Positive stops are provided on the jointer to limit the height and depth of the infeed table. To adjust the stops, simply loosen two locknuts (D) and (E) Fig. 26, and turn the two adjustment screws (F) and (G) as necessary. Retighten locknuts (D) and (E). We recommend that the height of the infeed table be adjusted so the table at its highest point will be 1/2mm below the highest point of the knives. This is an important feature of your jointer which enables you to rapidly position the infeed table for a finish or a final cut.



Fig. 25

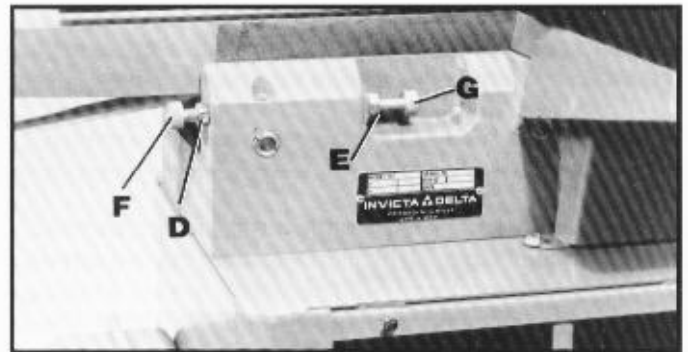

Fig. 26

## OUTFEED TABLE ADJUSTMENTS

For most jointing operations the outfeed table must be exactly level with the knives at their highest point of revolution. To move the outfeed table, loosen lockhandle (A) Fig. 27, and move the table raising and lowering hand lever (B) up or down until the table is level with the knives.

It may be necessary to adjust the positive stops. Loosen the two locknuts (C) and (D) Fig. 28, and the two adjusting screws (E) and (F) when moving the table up or down.

When the table is exactly level with the knives at the highest point of revolution, tighten lockhandle (A) Fig. 27, and turn adjusting screw (E) Fig. 28, until it bottoms; then tighten locknut (C). Screw (F) is also a positive stop for the lower limit of the outfeed table. We suggest that this stop also be tightened when the outfeed table is set level with the knives. This will prevent the outfeed table from accidentally being lowered.

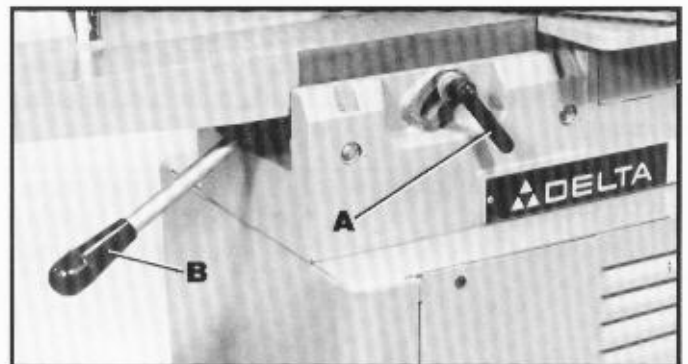

Fig. 27

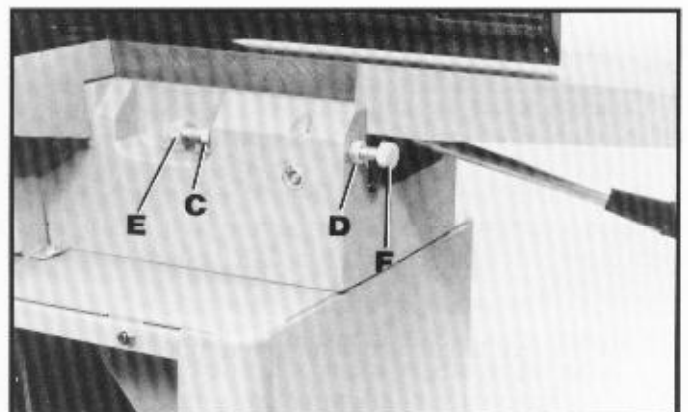

Fig. 28

# MAINTENANCE

## REMOVING, REPLACING AND RESETTING KNIVES

If the knives are removed from the cutterhead for replacement or regrinding, care must be used in removing and replacing them as follows:

1. **DISCONNECT THE MACHINE FROM THE POWER SOURCE.**

2. Be extremely careful that your hands do not come in contact with the cutterhead. Move the fence to the rear and remove the cutterhead guard.

3. Using wrench (A) Fig. 29, slightly loosen the three locking screws (B) in each knife slot to relieve stress in the cutterhead by turning the screws clockwise.

4. Loosen screws further and remove the knives (C) Fig. 29, from the cutterhead.

5. When the three knives are removed from the cutterhead, lower the two knife raising blocks by turning the two screws (D) Fig. 30, counterclockwise. Then lower the knife raising blocks in each of the two remaining cutterhead slots in the same manner.

6. When replacing, insert the knife (C) Fig. 30, into the slot in the cutterhead, making certain the bottom of the knife engages the cut out in the knife raising blocks and push the knife down as far as possible. **CAUTION:** Care must be taken when inserting the knives as the cutting edges are very sharp.

7. Tighten the knife locking screws (B) Fig. 30, by turning each one counterclockwise just enough to hold the knife in position. Replace the remaining two knives in the same manner.

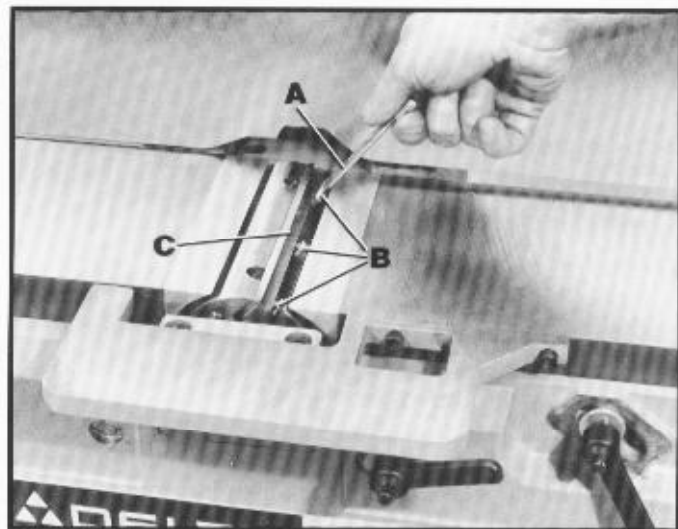

Fig. 29

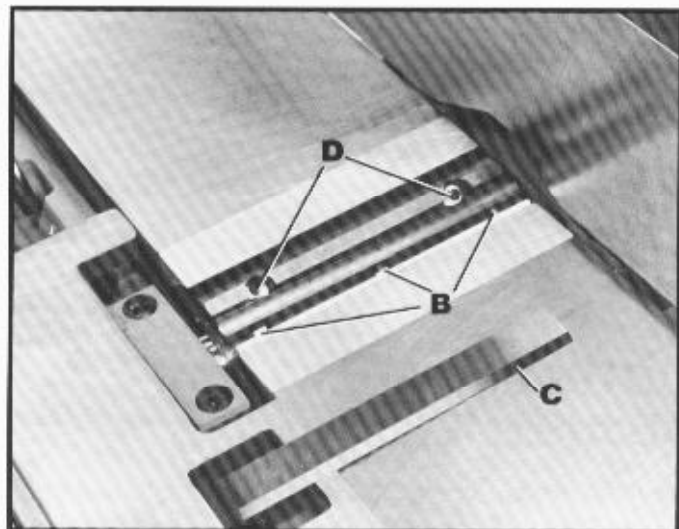

Fig. 30

## ADJUSTING KNIVES

The knives are adjusted correctly when the cutting edge of the knife extends out .015" from the diameter of the cutterhead. To adjust the knives, proceed as follows:

1. Carefully rotate the cutterhead (E) Fig. 31, manually until the round portion of the cutterhead is on top as shown.

2. Place a .015" feeler gage (F) Fig. 31, on the cutterhead and using a straight edge (G) on the rear table, adjust the height of the rear table (H), until it is .015" above the cutterhead diameter.

3. Lock the rear table in position and remove the feeler gage (F) Fig. 31.

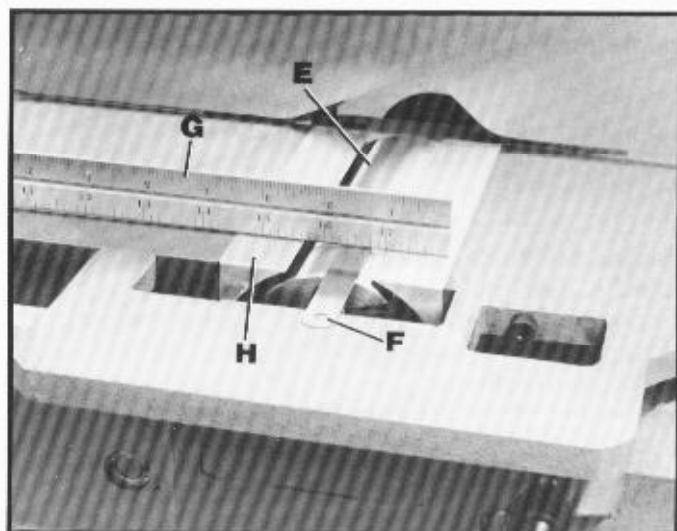

Fig. 31

## ADJUSTING KNIVES (CONT.)

- Lower the infeed table (J) Fig. 32, and place a straight edge (G) on the outfeed table extending over the cutterhead as shown.
- Rotate the cutterhead by hand. The knife should just touch the straight edge at its highest point at each end of the cutterhead.
- To raise the knife, use wrench as shown in Fig. 32, and turn screw (L) clockwise until the knife just touches the straight edge (G). Repeat this procedure on the other side of the cutterhead.
- Tighten the three knife locking screws (B) Fig. 32. Adjust the remaining two knives in the same manner.  
**CAUTION:** Make certain that all knives are securely fastened before turning on the machine.
- Replace cutterhead guard after adjustments are made.

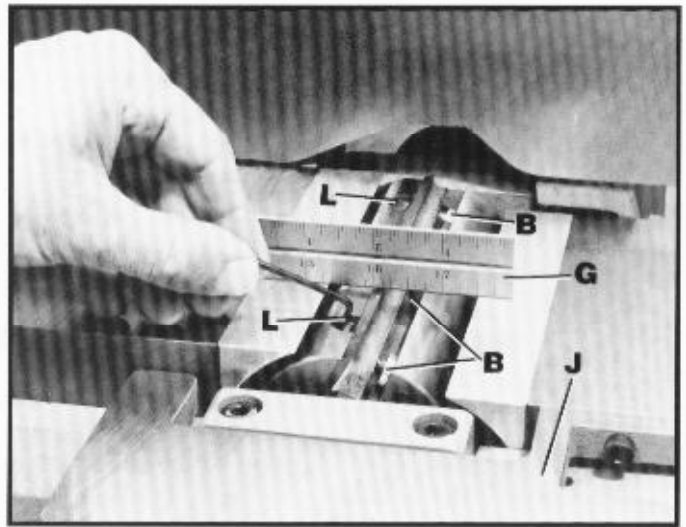

Fig. 32

## OPERATION

The following directions will give the beginner a start on jointer operation. Use scrap pieces of lumber to check settings and to get the feel of the operations before attempting regular work. **ALWAYS USE GUARDS AND KEEP HANDS AWAY FROM CUTTERHEAD. ALSO USE PUSH BLOCKS SUPPLIED WITH THE MACHINE WHENEVER POSSIBLE.**

### PLACEMENT OF HANDS DURING FEEDING

At the start of the cut, the left hand holds the work firmly against the front table and fence, while the right hand pushes the work toward the knives. After the cut is under way, the new surface rests firmly on the rear table as shown in Fig. 33. The left hand should press down on this part, at the same time maintaining flat contact with the fence. The right hand presses the work forward and before the right hand reaches the cutterhead, it should be moved to the work on the rear table. **NEVER PASS HANDS DIRECTLY OVER THE CUTTERHEAD.**

### JOINTING SHORT OR THIN WOOD

When jointing short or thin pieces, always use push blocks to eliminate danger to the hands. Fig. 34, illustrates using the 37-108 Delta Push Blocks while cutting a rabbet on the Jointer. Never joint (edge) material that is less than 10" long or 1/4" thick.

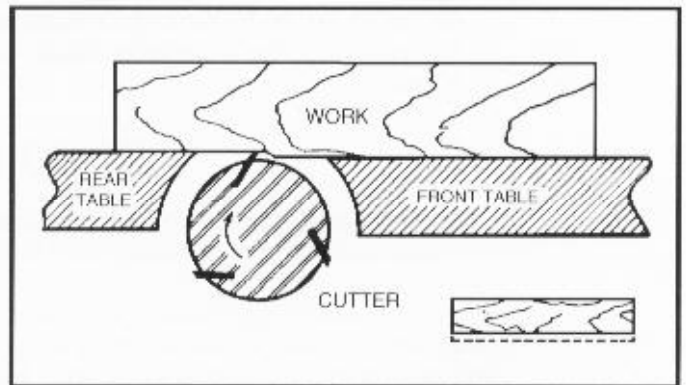

Fig. 33

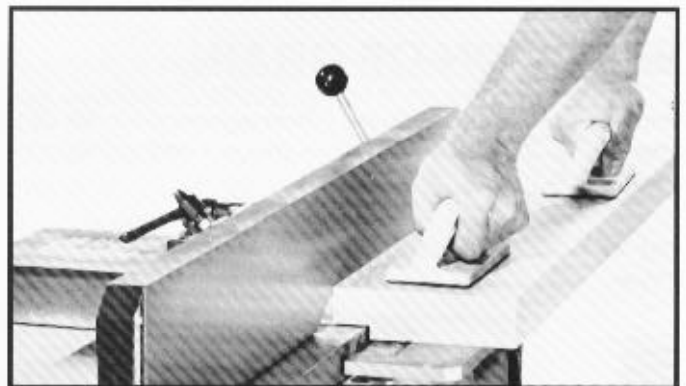

Fig. 34

### RABBETING

Figure 34, illustrates using the 37-108 Delta Push Blocks while cutting a rabbet. Since this operation requires removal of the cutterhead guard, it is critical that the operator be extremely careful in feeding the workpiece through the cutterhead and use push blocks whenever possible. The cutterhead guard should immediately be returned to the machine upon completion of the rabbeting operation.

## JOINTING AN EDGE

This is the most common operation for the jointer. Set the fence square with the table. Depth of cut should be the minimum (not to exceed 1/8") required to obtain a straight edge. Hold the best face of the piece firmly against the fence throughout the feed. Always use hold-downs/push blocks for jointing material less than 3" in height.

## JOINTING WARPED WOOD

If the wood to be jointed is dished or warped, take light cuts until the surface is flat. Avoid forcing such material down against the table; excessive pressure will spring it while passing the knives, and it will spring back and remain curved after the cut is completed.

## PLANING/SURFACING

When planing/surfacing short or thin pieces, always use push blocks to eliminate danger to hands. Never surface material that is less than 10" long or 5/8" thick. For surfacing, the workpiece should be at least 3/4" wide and no more than 6" wide.

## DIRECTION OF GRAIN

Avoid feeding the wood into the jointer against the grain as shown in Fig. 35. The result will be chipped and splintered edges.

Feed with the grain as in Fig. 36, to obtain a smooth surface.

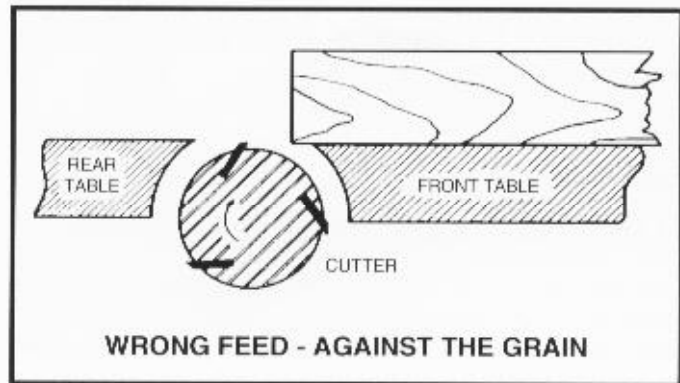

Fig. 35

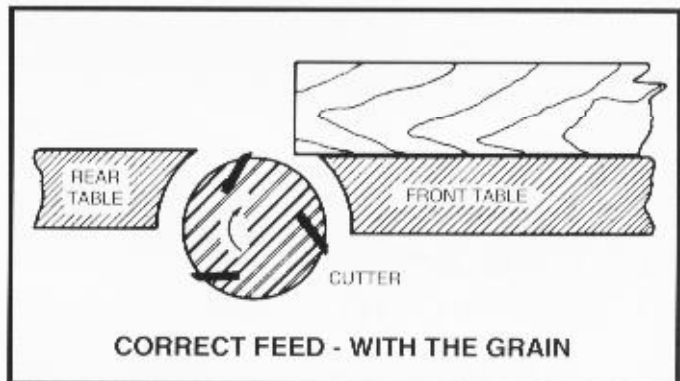

Fig. 36



## BEVELING

To cut a bevel, lock the fence at the required angle and run the work across the knives while keeping it firmly against the fence and tables. Several passes may be necessary to arrive at the desired result.

When the angle is small, there is little difference whether the fence is tilted to the right or left. However, at greater angles approaching 45 degrees, it is increasingly difficult to hold the work properly when the fence is tilted to the right. The advantage of the double-tilting fence is appreciated under such conditions.

When tilted to the left, the fence forms a V-shape with the tables, as shown in Fig. 37, and the work is easily pressed into the pocket while passing it across the knives. If the bevel is laid out on the piece in such direction that this involves cutting against the grain, it will be better to tilt the fence to the right.

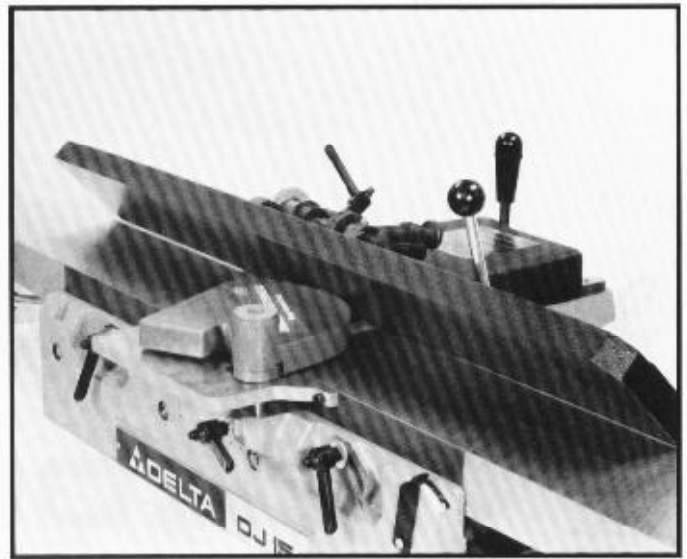

Fig. 37

## TAPER CUTS

One of the most useful jointer operations is cutting an edge to a taper. The method can be used on a wide variety of work. Tapered legs of furniture are a common example.

Instead of laying the piece on the front table, lower the forward end of the work onto the rear table. Do this very carefully, as the piece will span the knives, and they will take a "bite" from the work with a tendency to kickback unless the piece is firmly held. Now push the work forward as in ordinary jointing. The effect is to plane off all the stock in front of the knives, to increase depth, leaving a tapered surface.

The ridge left by the knives when starting the taper may be removed by taking a very light cut according to the regular method for jointing, with the front table raised to its usual position, or by sanding.

Practice is required in this operation, and the beginner is advised to make trial cuts on waste material. Taper cuts over part of the length and a number of other special operations can easily be done by the experienced craftsman.

Additional information on the safe and proper operation of wood jointers can be obtained by writing to:

**NATIONAL SAFETY COUNCIL  
1121 SPRING LAKE DRIVE  
ITASCA, IL 60143-3201**



## **Delta Building Trades and Home Shop Machinery Two Year Limited Warranty**

Delta will repair or replace, at its expense and at its option, any Delta machine, machine part, or machine accessory which in normal use has proven to be defective in workmanship or material, provided that the customer returns the product prepaid to a Delta factory service center or authorized service station with proof of purchase of the product within two years and provides Delta with reasonable opportunity to verify the alleged defect by inspection. Delta may require that electric motors be returned prepaid to a motor manufacturer's authorized station for inspection and repair or replacement. Delta will not be responsible for any asserted defect which has resulted from normal wear, misuse, abuse or repair or alteration made or specifically authorized by anyone other than an authorized Delta service facility or representative. Under no circumstances will Delta be liable for incidental or consequential damages resulting from defective products. This warranty is Delta's sole warranty and sets forth the customer's exclusive remedy, with respect to defective products; all other warranties, express or implied, whether of merchantability, fitness for purpose, or otherwise, are expressly disclaimed by Delta.

Printed in U.S.A.

## Free Manuals Download Website

<http://myh66.com>

<http://usermanuals.us>

<http://www.somanuals.com>

<http://www.4manuals.cc>

<http://www.manual-lib.com>

<http://www.404manual.com>

<http://www.luxmanual.com>

<http://aubethermostatmanual.com>

Golf course search by state

<http://golfingnear.com>

Email search by domain

<http://emailbydomain.com>

Auto manuals search

<http://auto.somanuals.com>

TV manuals search

<http://tv.somanuals.com>