

Dell and the Dell logo are trademarks of Dell Inc.

ConnectX[®]-3 Dual Port 40Gb/s and 56Gb/s Mezzanine Card for Dell User Manual

0J05YT, 0K6V3V

Rev 1.0

www.mellanox.com

NOTE:

THIS HARDWARE, SOFTWARE OR TEST SUITE PRODUCT (“PRODUCT(S)”) AND ITS RELATED DOCUMENTATION ARE PROVIDED BY MELLANOX TECHNOLOGIES “AS-IS” WITH ALL FAULTS OF ANY KIND AND SOLELY FOR THE PURPOSE OF AIDING THE CUSTOMER IN TESTING APPLICATIONS THAT USE THE PRODUCTS IN DESIGNATED SOLUTIONS. THE CUSTOMER'S MANUFACTURING TEST ENVIRONMENT HAS NOT MET THE STANDARDS SET BY MELLANOX TECHNOLOGIES TO FULLY QUALIFY THE PRODUCT(S) AND/OR THE SYSTEM USING IT. THEREFORE, MELLANOX TECHNOLOGIES CANNOT AND DOES NOT GUARANTEE OR WARRANT THAT THE PRODUCTS WILL OPERATE WITH THE HIGHEST QUALITY. ANY EXPRESS OR IMPLIED WARRANTIES, INCLUDING, BUT NOT LIMITED TO, THE IMPLIED WARRANTIES OF MERCHANTABILITY, FITNESS FOR A PARTICULAR PURPOSE AND NONINFRINGEMENT ARE DISCLAIMED. IN NO EVENT SHALL MELLANOX BE LIABLE TO CUSTOMER OR ANY THIRD PARTIES FOR ANY DIRECT, INDIRECT, SPECIAL, EXEMPLARY, OR CONSEQUENTIAL DAMAGES OF ANY KIND (INCLUDING, BUT NOT LIMITED TO, PAYMENT FOR PROCUREMENT OF SUBSTITUTE GOODS OR SERVICES; LOSS OF USE, DATA, OR PROFITS; OR BUSINESS INTERRUPTION) HOWEVER CAUSED AND ON ANY THEORY OF LIABILITY, WHETHER IN CONTRACT, STRICT LIABILITY, OR TORT (INCLUDING NEGLIGENCE OR OTHERWISE) ARISING IN ANY WAY FROM THE USE OF THE PRODUCT(S) AND RELATED DOCUMENTATION EVEN IF ADVISED OF THE POSSIBILITY OF SUCH DAMAGE.



Mellanox Technologies
350 Oakmead Parkway Suite 100
Sunnyvale, CA 94085
U.S.A.
www.mellanox.com
Tel: (408) 970-3400
Fax: (408) 970-3403

Mellanox Technologies, Ltd.
PO Box 586 Hermon Building
Yokneam 20692
Israel
Tel: +972-4-909-7200
Fax: +972-4-959-3245

© Copyright 2012. Mellanox Technologies. All rights reserved.

Mellanox®, BridgeX®, ConnectX®, InfiniBlast®, InfiniBridge®, InfiniHost®, InfiniRISC®, InfiniScale®, InfiniPCI®, PhyX®, CORE-Direct®, Virtual Protocol Interconnect®, Voltaire® and SwitchX® are registered trademarks of Mellanox Technologies, Ltd. FabricIT™, MLNX-OS™ and Unbreakable-Link™ are trademarks of Mellanox Technologies, Ltd. All other marks and names mentioned herein may be trademarks of their respective companies.

Table of Contents

Table of Contents	3
List of Tables	4
List of Figures	5
Revision History	6
About this Manual	7
Intended Audience	7
Related Documentation	7
Online Resources	7
Document Conventions	7
Chapter 1 Overview	9
1.1 Cards Covered in this Manual	9
1.2 Finding the GUID/MAC and Serial Number on the Mezzanine Cards	9
Chapter 2 Card Interfaces	11
2.1 I/O Interfaces	11
2.1.1 InfiniBand Interface	11
2.1.2 PCI Express Interface	12
2.1.3 I2C-compatible Interface	12
2.2 Power	12
2.3 Memory	12
2.3.1 System Memory	12
2.3.2 SPI	12
2.3.3 EEPROM	13
Chapter 3 Card Installation	18
3.1 Hardware Requirements	TBD 18
3.2 Installation Kit	18
3.3 Safety Warnings	23
Chapter 4 Driver Software and Firmware	24
4.1 Driver Software	24
4.1.1 Linux	24
4.1.2 Windows	25
4.2 FlexBoot	26
4.3 Updating Mezzanine Card Firmware	26
Appendix A Specifications	29
Appendix B Avertissements de sécurité d'installation (French)	31
Appendix C Installation - Sicherheitshinweise (German)	32
Appendix D Advertencias de seguridad para la instalación (Warnings in Spanish)	33

List of Tables

Table 1:	Revision History Table	6
Table 2:	Documents List	7
Table 3:	ConnectX-3 Mezzanine Card Details	9
Table 4:	Jumper Configuration	13
Table 5:	0J05YT VPD Layout	13
Table 6:	0K6V3V VPD Layout	15
Table 7:	Jumper Configuration	18
Table 8:	ConnectX-3 0J05YT/0K6V3V Specifications Table	30

List of Figures

Figure 1:	0J05YT Label	10
Figure 2:	Board Label	10
Figure 3:	0K6V3V Label	10
Figure 4:	Board Label	10
Figure 5:	0J05YT/0K6V3V Card	11
Figure 6:	I2C Connector	12
Figure 7:	Grounding Clip	19
Figure 8:	Blade Server	19
Figure 9:	Protective Cover in Place	20
Figure 10:	Remove the Cover	21
Figure 11:	Press on the Card	21
Figure 12:	Single Card in Slot C	22
Figure 13:	Two Cards Installed	22
Figure 14:	Device Manager (example)	26
Figure 15:	Support Download Assistant	28
Figure 16:	Mechanical Drawing of 0J05YT/0K6V3V Mezzanine Card	29

Revision History

This document was first printed on February 14, 2012.

Table 1 - Revision History Table

Date	Rev	Comments/Changes
February 2012	1.0	Initial Release

About this Manual

This *User Manual* describes ConnectX®-3 Dual QSFP Port mezzanine card for the Dell Blade Servers. It provides details as to the interfaces of the board, specifications, required software and firmware for operating the cards, installation instructions, and relevant documentation.

Intended Audience

This manual is intended for the installer and user of the mezzanine cards.

The manual assumes basic familiarity with the InfiniBand® (IB) network architecture specifications.

Related Documentation

Table 2 - Documents List

<i>IBTA Specification Release 1.2.1</i>	InfiniBand Architecture Specification
PCI Express 3.0 Specifications	Industry Standard PCI Express 3.0 Base and Card Electromechanical Specifications

Online Resources

- Mellanox Technologies Web pages: <http://www.mellanox.com>
- Dell Support Web pages: <http://support.dell.com>

Document Conventions

When discussing memory sizes, MB and MBytes are used in this document to mean size in mega bytes. The use of Mb or Mbits (small b) indicates size in mega bits.



These symbols indicate a situation, status, or condition that may cause harm to people or damage to the equipment.

1 Overview

This document is a *User Manual* for the Mellanox Technologies ConnectX®-3 40Gb/s and 56Gb/s InfiniBand dual-port mezzanine cards for the Dell Blade Servers. The cards described in this manual have the following main features:

- InfiniBand Architecture Specifications v1.2.1 compliant
- PCI Express 3.0 (1.1 and 2.0 compatible) through an x8 connector up to 8GT/s
- 1µs MPI ping latency
- Up to 56Gb/s InfiniBand per port
- CPU off-load of transport operations
- Application Offload
- End-to-end QoS and congestion control
- Hardware-based I/O virtualization
- TCP/UDP/IP stateless offload
- RoHS-R6 compliant

1.1 Cards Covered in this Manual

Table 3 - ConnectX-3 Mezzanine Card Details

Ordering Part Number (OPN)	PCI Express SERDES Speed	InfiniBand Data Transmission Rate	RoHS	Adapter IC Part Number
0J05YT	PCIe 3.0 x8 8GT/s /	InfiniBand 40Gb/s QDR	R-6	MT27508A1-FCCR-QV
0K6V3V	PCIe 3.0 x8 8GT/s /	InfiniBand 56Gb/s FDR	R-6	MT27508A1-FCCR-FV

1.2 Finding the GUID/MAC and Serial Number on the Mezzanine Cards

All cards include a label that has the card serial number and the card GUID for InfiniBand protocol on the print side of the card.

Figure 1: 0J05YT Label



Figure 2: Board Label



Figure 3: 0K6V3V Label



Figure 4: Board Label

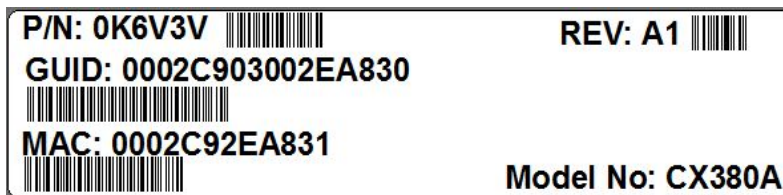

2 Card Interfaces

2.1 I/O Interfaces

Each mezzanine card includes the following interfaces:

- PCI Express (PCIe)
- I²C-compatible connector (for debug)

Figure 5: 0J05YT/0K6V3V Card

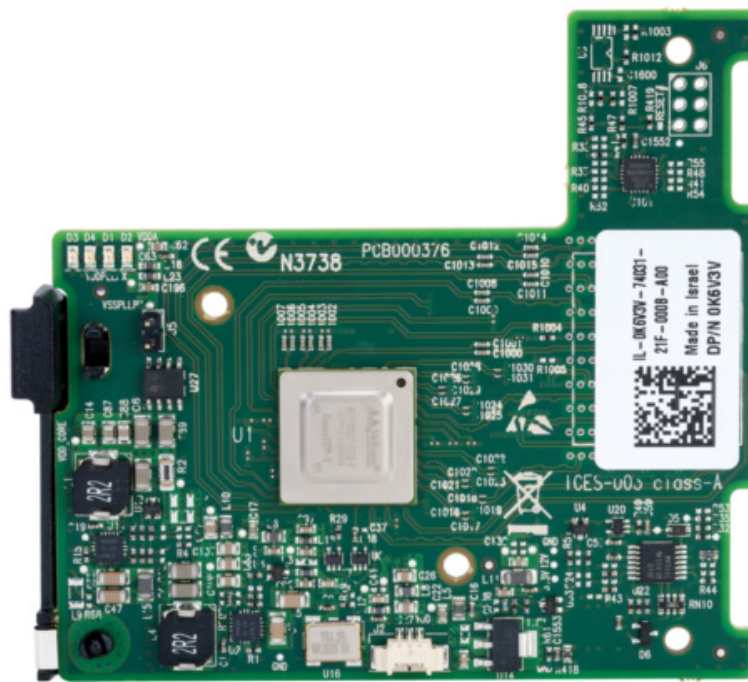

2.1.1 InfiniBand Interface

The ConnectX®-3 mezzanine cards are compliant with the *InfiniBand Architecture Specification, Release 1.2.1*. It has two compliant InfiniBand ports with four Tx/Rx pairs of SerDes.

2.1.2 PCI Express Interface

The ConnectX®-3 mezzanine cards support PCI Express 3.0 (1.1 and 2.0 compatible) . The device can be either a master initiating the PCI Express bus operations or a slave responding to PCI bus operations.

2.1.3 I²C-compatible Interface

A three-pin header on the mezzanine cards is provided as the I²C-compatible interface.

Figure 6: I²C Connector

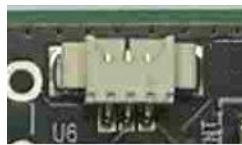

2.2 Power

All adapter cards receive 12V and 3.3V power from the PCI Express connector. All other required power voltages are generated by on-board switch mode regulators. See Appendix A.2, “Specifications,” on page 30.

2.3 Memory

The mezzanine cards support multiple memory devices through the PCI Express, SPI (Flash), and I²C-compatible interfaces.

2.3.1 System Memory

The mezzanine cards utilize the PCI Express interface to store and access fabric connection information on the system memory.

2.3.2 SPI

The mezzanine cards include one SPI Flash device accessible via the Flash interface of the ConnectX®-3 device.

A jumper inserted into the drill on each adapter card indicates to the device whether an on-board Flash device is to be used or not. Table 4 provides information on this jumper.

Table 4 - Jumper Configuration

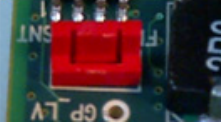
Description	Option	Card Default Configuration
Flash present/ not present	connection open – Flash present connection shorted – Flash not present 	connection open – Flash present

2.3.3 EEPROM

The mezzanine cards incorporate an EEPROM that is accessible through the I²C-compatible interface. The EEPROM capacity is 4Kb. The EEPROM is used for storing the Vital Product Data (VPD) and FRU. The PCI VPD (Vital Product Data) layout for each of the mezzanine cards complies with the format defined in the *PCI 3.0 Specification, Appendix I*.

Table 5 - 0J05YT VPD Layout

Offset (Decimal)	Item	Value	Format	Description
0	Large Resource Type ID String Tag (0x02)	0x82		
1	Length [7:0] LSB	0x14		
2	Length [15:8] MSB	0x0		
3	Data	DELL ConnectX-3 Mezz	STR	
23	Large Resource Type VPD-R Tag (0x10)	0x90		
24	Length [7:0] LSB	0x51		
25	Length [15:8] MSB	0x00		
26	VPD Keyword	PN	STR	Add in Card Part Number
28	Length	0x15		
29	Part Number	PN	%STR_SPC	
50	VPD Keyword	EC	STR	Engineering Change Level of the card (rev)
52	Length	0x3		
53	Revision	RV	%STR	PCB revision
56	VPD Keyword	SN	STR	Serial Number
58	Length	0x14		

Table 5 - 0J05YT VPD Layout

Offset (Decimal)	Item	Value	Format	Description
59	SerialNumber	OO0J05YTMMM MMYMDSSSS	%STR_SPC	“00..00XXXX..XX”
79	VPD Keyword	V0	STR	Misc Information
81	Length	0x15		
82	Data	VPI QDR SFF mezz	STR_SPC	
103	VPD Keyword	RV	STR	
105	Length	0x1		
106	Data	0,105	%CS0	
107	Large Resource Type VPD-W Tag (0x11)	0x91		
108	Length [7:0] LSB	0x91		
109	Length [15:8] MSB	0xF		
110	VPD Keyword	V1	STR	EFI Driver version
112	Length	0x6		
113	Data	N/A	STR_SPC	
119	VPD Keyword	YA	STR	Asset Tag
121	Length	0x18		
122	Data	N/A	STR_SPC	“N/A”
146	VPD Keyword	RW	STR	Remaining read/write area
148	Length	0x6b		
149	Data		STR_ZERO	Reserved (0x00)
256	VPD Keyword	RW	STR	Remaining read/write area
258	Length	0xfd		
259	Data		STR_ZERO	Reserved (0x00)
512	VPD Keyword	RW	STR	Remaining read/write area
514	Length	0xfd		
515	Data		STR_ZERO	Reserved (0x00)
768	VPD Keyword	RW	STR	Remaining read/write area
770	Length	0xfd		
771	Data		STR_ZERO	Reserved (0x00)
1024	VPD Keyword	RW	STR	Remaining read/write area
1026	Length	0xfd		
1027	Data		STR_ZERO	Reserved (0x00)
1280	VPD Keyword	RW	STR	Remaining read/write area
1282	Length	0xfd		
1283	Data		STR_ZERO	Reserved (0x00)
1536	VPD Keyword	RW	STR	Remaining read/write area
1538	Length	0xfd		
1539	Data		STR_ZERO	Reserved (0x00)
1792	VPD Keyword	RW	STR	Remaining read/write area
1794	Length	0xfd		
1795	Data		STR_ZERO	Reserved (0x00)
2048	VPD Keyword	RW	STR	Remaining read/write area

Table 5 - 0J05YT VPD Layout

Offset (Decimal)	Item	Value	Format	Description
2050	Length	0xfd		
2051	Data		STR_ZERO	Reserved (0x00)
2304	VPD Keyword	RW	STR	Remaining read/write area
2306	Length	0xfd		
2307	Data		STR_ZERO	Reserved (0x00)
2560	VPD Keyword	RW	STR	Remaining read/write area
2562	Length	0xfd		
2563	Data		STR_ZERO	Reserved (0x00)
2816	VPD Keyword	RW	STR	Remaining read/write area
2818	Length	0xfd		
2819	Data		STR_ZERO	Reserved (0x00)
3072	VPD Keyword	RW	STR	Remaining read/write area
3074	Length	0xfd		
3075	Data		STR_ZERO	Reserved (0x00)
3328	VPD Keyword	RW	STR	Remaining read/write area
3330	Length	0xfd		
3331	Data		STR_ZERO	Reserved (0x00)
3584	VPD Keyword	RW	STR	Remaining read/write area
3586	Length	0xfd		
3587	Data		STR_ZERO	Reserved (0x00)
3840	VPD Keyword	RW	STR	Remaining read/write area
3842	Length	0xfc		
3843	Data		STR_ZERO	Reserved (0x00)
4095	Small Resource Type END Tag (0x11)	0x78		

Table 6 - 0K6V3V VPD Layout

Offset (Decimal)	Item	Value	Format	Description
0	Large Resource Type ID String Tag (0x02)	0x82		
1	Length [7:0] LSB	0x14		
2	Length [15:8] MSB	0x0		
3	Data	DELL ConnectX-3 Mezz	STR	
23	Large Resource Type VPD-R Tag (0x10)	0x90		
24	Length [7:0] LSB	0x4D		
25	Length [15:8] MSB	0x00		
26	VPD Keyword	PN	STR	Add in Card Part Number
28	Length	0x15		
29	Part Number	PN	%STR_SPC	
50	VPD Keyword	EC	STR	Engineering Change Level of the card (rev)
52	Length	0x3		

Table 6 - 0K6V3V VPD Layout

Offset (Decimal)	Item	Value	Format	Description
53	Revision	RV	%STR	PCB revision
56	VPD Keyword	SN	STR	Serial Number
58	Length	0x14		
59	SerialNumber	OO0K6V3VMMM MMYMDSSSS	%STR_SPC	“00..00XXXX..XX”
79	VPD Keyword	V0	STR	Misc Information
81	Length	0x11		
82	Data	VPI FDR SFF mezz	STR_SPC	
99	VPD Keyword	RV	STR	
101	Length	0x1		
102	Data	0,101	%CS0	
103	Large Resource Type VPD-W Tag (0x11)	0x91		
104	Length [7:0] LSB	0x95		
105	Length [15:8] MSB	0xF		
106	VPD Keyword	V1	STR	EFI Driver version
108	Length	0x6		
109	Data	N/A	STR_SPC	
115	VPD Keyword	YA	STR	Asset Tag
117	Length	0x18		
118	Data	N/A	STR_SPC	“N/A”
142	VPD Keyword	RW	STR	Remaining read/write area
144	Length	0x6f		
145	Data		STR_ZERO	Reserved (0x00)
256	VPD Keyword	RW	STR	Remaining read/write area
258	Length	0xfd		
259	Data		STR_ZERO	Reserved (0x00)
512	VPD Keyword	RW	STR	Remaining read/write area
514	Length	0xfd		
515	Data		STR_ZERO	Reserved (0x00)
768	VPD Keyword	RW	STR	Remaining read/write area
770	Length	0xfd		
771	Data		STR_ZERO	Reserved (0x00)
1024	VPD Keyword	RW	STR	Remaining read/write area
1026	Length	0xfd		
1027	Data		STR_ZERO	Reserved (0x00)
1280	VPD Keyword	RW	STR	Remaining read/write area
1282	Length	0xfd		
1283	Data		STR_ZERO	Reserved (0x00)
1536	VPD Keyword	RW	STR	Remaining read/write area
1538	Length	0xfd		
1539	Data		STR_ZERO	Reserved (0x00)
1792	VPD Keyword	RW	STR	Remaining read/write area

Table 6 - 0K6V3V VPD Layout

Offset (Decimal)	Item	Value	Format	Description
1794	Length	0xfd		
1795	Data		STR_ZERO	Reserved (0x00)
2048	VPD Keyword	RW	STR	Remaining read/write area
2050	Length	0xfd		
2051	Data		STR_ZERO	Reserved (0x00)
2304	VPD Keyword	RW	STR	Remaining read/write area
2306	Length	0xfd		
2307	Data		STR_ZERO	Reserved (0x00)
2560	VPD Keyword	RW	STR	Remaining read/write area
2562	Length	0xfd		
2563	Data		STR_ZERO	Reserved (0x00)
2816	VPD Keyword	RW	STR	Remaining read/write area
2818	Length	0xfd		
2819	Data		STR_ZERO	Reserved (0x00)
3072	VPD Keyword	RW	STR	Remaining read/write area
3074	Length	0xfd		
3075	Data		STR_ZERO	Reserved (0x00)
3328	VPD Keyword	RW	STR	Remaining read/write area
3330	Length	0xfd		
3331	Data		STR_ZERO	Reserved (0x00)
3584	VPD Keyword	RW	STR	Remaining read/write area
3586	Length	0xfd		
3587	Data		STR_ZERO	Reserved (0x00)
3840	VPD Keyword	RW	STR	Remaining read/write area
3842	Length	0xfc		
3843	Data		STR_ZERO	Reserved (0x00)
4095	Small Resource Type END Tag (0x11)	0x78		

3 Card Installation

3.1 Hardware Requirements TBD

Before installing the mezzanine card, make sure that the system meets the hardware and software requirements listed in

Table 7 - Jumper Configuration

Requirement	Description
Hardware	Used with Dell Blade Servers
Software Operating Systems/Distributions	Refer to the Dell Blade Servers Manuals

3.2 Installation Kit

Make sure all of the parts are in the kit before you start the installation. If any parts are damaged or missing, call your supplier immediately.

Installation Instructions

Installation of this mezzanine card should only be done by a properly qualified technician or engineer. Installation or service not authorized by Dell or performed by unqualified personnel may void guarantees and warranties. Read and follow all safety precautions specified in this document and in the PowerEdge documentation.

Use the documentation supplied with the Dell Blade Servers to remove and replace the blade from the chassis.

The card shown below has grounding clips that must come in contact with the chassis after the card is installed.

Figure 7: Grounding Clip

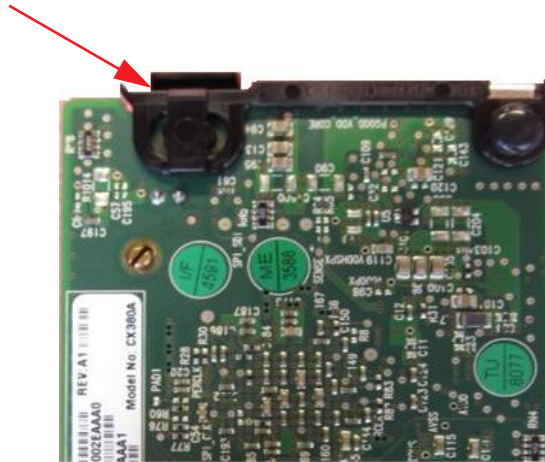

Make sure that you are properly grounded. Make sure that the equipment, both while in the chassis and while removed from the chassis, is properly grounded to prevent ESD.

Figure 8: Blade Server

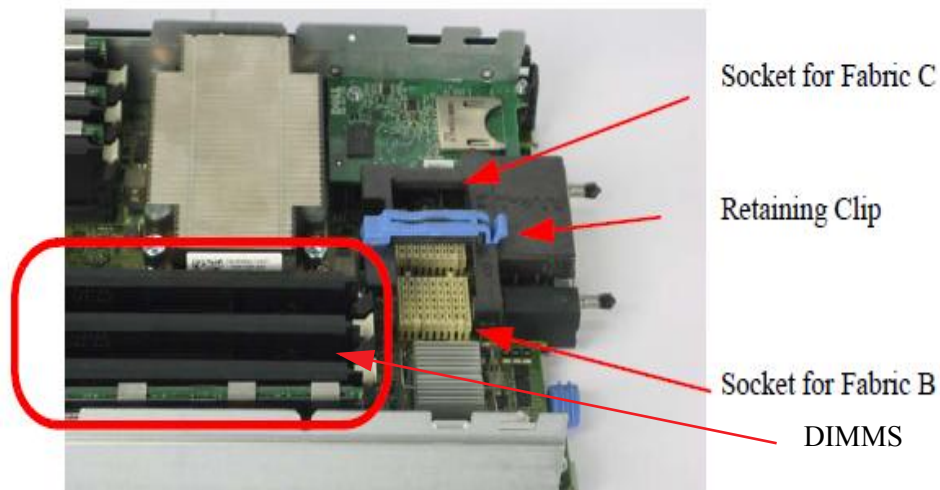



DIMMS can be hot. Allow sufficient time for the blade components to cool before starting this procedure.

1. Remove the blade from the chassis.
2. Remove the cover from the blade.
3. Open the retaining clip.

The card can be placed in either of the two available slots.

4. Expose the socket to be used for the new card.
 - a. When replacing an existing card, remove the card from the socket. Grab the card on the edge on the side with UPC number and pull up while gently rocking the card back and forth.
 - b. For a new installation remove the protective cover enclosing the socket for the card.

Figure 9: Protective Cover in Place



Figure 10: Remove the Cover

Hold the mezzanine card by the edges only.

Line up the mezzanine card so that the pins of the mezzanine card are over the sockets in the blade server.

5. Plug the card into the socket by placing your thumb over the UPC symbol and pressing down until the card reaches the bottom.

Figure 11: Press on the Card

6. Close the retaining clip.

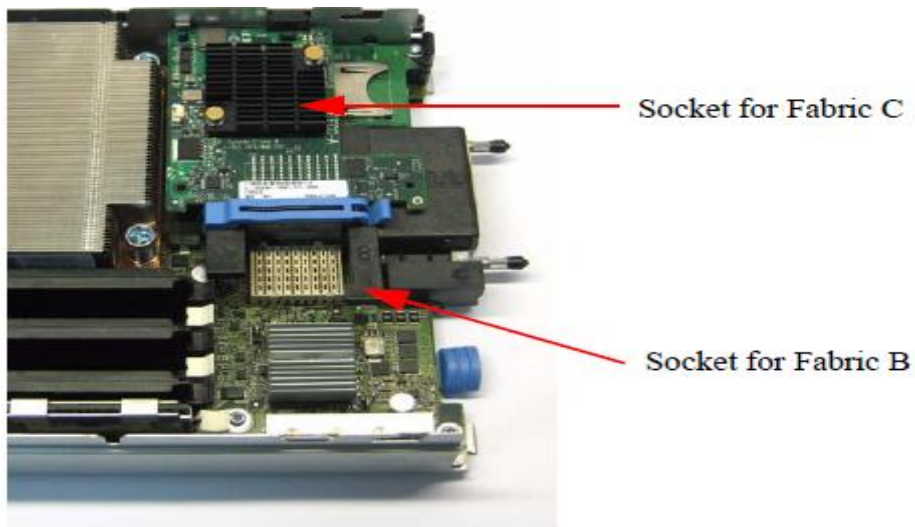
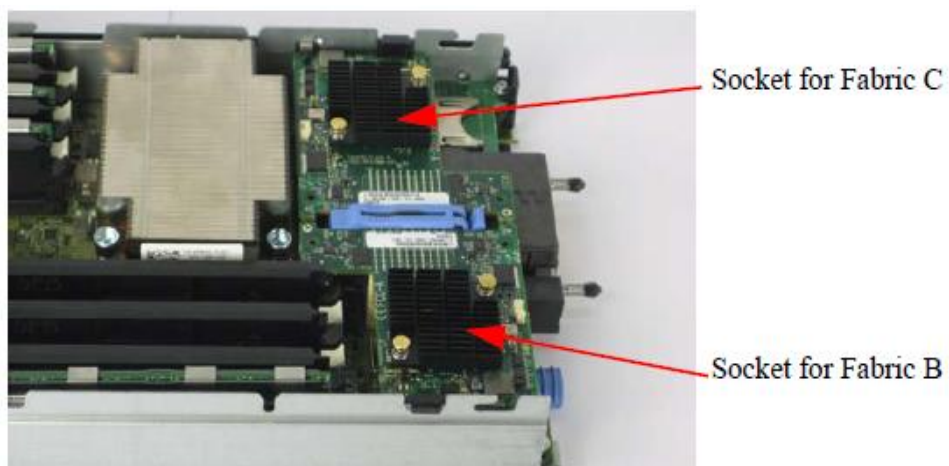
Figure 12: Single Card in Slot C**Figure 13: Two Cards Installed**

7. Replace the blade server cover.
8. Replace the blade server into the chassis

3.3 Safety Warnings

1. Installation Instructions



Read all installation instructions before connecting the equipment to the power source.

2. Over Temperature



This equipment should not be operated in an area with an ambient temperature exceeding the maximum recommended: °C (°F).
To guarantee proper air flow, allow at least 8cm (3 inches) of clearance around the ventilation openings.

3. Lightening – Electrical Hazard



During periods of lightning activity, do not work on the equipment.

4. Installation of Equipment



This equipment should be installed, replaced, or serviced only by trained and qualified personnel.

5. Disposal of Equipment =



Disposal of this equipment should be in accordance to all national laws and regulations.

6. Compliance with Local and National Codes



This equipment should be installed in compliance with local and national electrical codes.

4 Driver Software and Firmware

4.1 Driver Software

4.1.1 Linux

For Linux, download and install the latest OpenFabrics Enterprise Distribution (OFED) software package available via the Mellanox web site at: <http://www.mellanox.com> => Products => Software/Drivers => Infiniband & VPI Software/Drivers => Mellanox OFED => Download. Follow the installation instructions included in the download package (also available from the download page). To ensure that communication has been established follow the instructions below.

Check the link status

To check the IB link status, for IB cards, run “ibstat” and focus on the Physical state attributes.

Example:

```
> Host# ibstat

LCA 'mlx4_0'

CA type: MT4099

Number of ports: 2

Firmware version: 2.10.2000

Hardware version: 0

Node GUID: 0x0002c903002fefe0

System image GUID: 0x0002c903002fefe3

Port 1:

    State: Active

    Physical state: LinkUp

    Rate: 56

    Base lid: 4

    LMC: 0

    SM lid: 12

    Capability mask: 0x02514868

    Port GUID: 0x0002c903002fefe1

    Link layer: InfiniBand

Port 2:

    State: Active

    Physical state: LinkUp
```



```
Rate: 56
Base lid: 8
LMC: 0
SM lid: 12
Capability mask: 0x02514868
Port GUID: 0x0002c903002fefe2
Link layer: InfiniBand
```

Check the OFED version

To get the version of the running Mellanox OFED/BXOFED, run the following command:

```
# ofed_info |head -1
MLNX_OFED_LINUX-1.5.2-2.0.0 (OFED-1.5.2-20101219-1546) :

MLNX_OFED_LINUX-1.5.3-0.1.6 (OFED-1.5.3-0.1.6) :
```

Troubleshooting MLNX_OFED Installation

For troubleshooting driver installation, please check Mellanox OFED driver user manual at <http://www.mellanox.com> => Support => InfiniBand Products => Mellanox OFED.

4.1.2 Windows

For Windows, download and install the latest Mellanox WinOF VPI for Windows software package available via the Mellanox web site at: <http://www.mellanox.com> => Products => Software/Drivers => Infiniband & VPI Software/Drivers => Mellanox WinOF VPI => Download. Follow the installation instructions included in the download package (also available from the download page). To ensure that communication has been established follow the instructions below.

Displaying the Device Manager will show the Mellanox adapter devices and an IPoIB (network) device for each port.

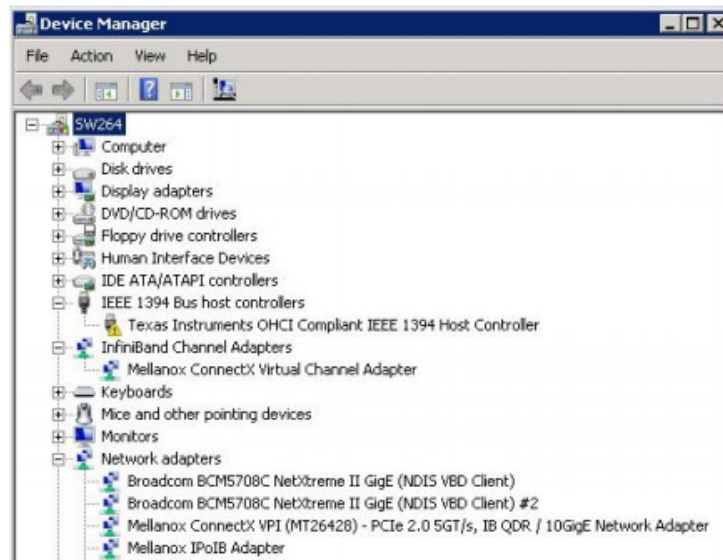
Figure 14: Device Manager (example)

Note: If the cards are connected to a managed switch, there is no need to run openSM. Only one OpenSM should run per subnet. In InfiniBand interfaces, OpenSM is installed as a disabled Windows service. To enable it, enter at the command line:

```
> sc start opensm
```

4.2 FlexBoot

FlexBoot enables remote boot over Boot over InfiniBand (BoIB), or Boot over iSCSI (Bo-iSCSI). This technology is based on the Preboot Execution Environment (PXE) standard specification, and FlexBoot software is based on the open source EtherBoot/gPXE project (see www.etherboot.org). For more information go to <http://www.mellanox.com> => Products => InfiniBand & VPI Software/Drivers => FlexBoot => User's Manual.

4.3 Updating Mezzanine Card Firmware

Each card is shipped with the latest version of qualified firmware at the time of manufacturing. Firmware is updated occasionally, and the most recent firmware can be obtained from: <http://www.mellanox.com> => Support => Download Firmware. Check that the firmware on your card is the latest found on the Mellanox site, if not update to the latest version found on the Mellanox web site.

Firmware can be updated on the stand alone single card using the **flint** tool of the *Mellanox Firmware Tools (MFT)* package. This package is available for download, along with its user manual, from the Mellanox Firmware Tools page. See <http://www.mellanox.com> => Support => Download Firmware Tools.

A firmware binaries table lists a binary file per mezzanine card. The file name of each such binary is composed by combining the firmware name, the firmware release version, and the card part

number. Please contact Mellanox System Support if you cannot find the firmware binary for your mezzanine card.

The following steps describe how to retrieve the PSID (firmware identification) and programmed firmware version of your mezzanine card. They also describe how to update the card with the latest firmware version available.

1. Retrieve the PSID and firmware version:
 - a. Install the MFT package. The package is available at www.mellanox.com => Products => Software/Drivers => InfiniBand & VPI Software/Drivers => Firmware Tools. Make sure to download the package corresponding to your computer's operating system.
 - b. Enter: `mst start`
 - c. Get the Mellanox *mst device name* using the command "`mst status`". The mst device name will be of the form: `/dev/mst/mt4099_pci_cr0`
 - d. Get the PSID (firmware identification) and programmed firmware version using the command

```
> flint -d /dev/mst/mt4099_pci_cr0 q
Image type:      ConnectX
FW Version:      2.9.4000
Device ID:       4099
Chip Revision:   0
Description:     Node                               Port1
Port2                               Sys image
GUIDs:           000002c900000200 000002c900000201
000002c900000202 000002c900000203
MACs:
000002c90200     000002c90201
Board ID:        (MT_1020110019)
VSD:
PSID:           MT_1020110019
```

2. Compare the programmed firmware version with the latest available.
 - a. Go to Mellanox's web site: <http://www.mellanox.com/supportdownloader>. See Figure 15
 - b. Enter your card PSID to display the latest firmware

Figure 15: Support Download Assistant

Mellanox - Support Download Assistant

Support Index | Documentation Login | Customer Support | Returns | Home

CLEAR PSID or OPN Identifying Adapter Cards (PSID)

Browse for Product Support START OVER

Select a Family	Select a Line	Select an OPN	Select a PSID (Rev)	Product Support Information
Adapter Cards Switches Gateways	Select an item from previous column			

3. If a newer firmware version exists for your mezzanine card, update the firmware as follows:
 - a. Download the firmware image zip file from the Download Center (see Step 2a above)
 - b. Unzip the firmware image
 - c. Burn the firmware image. Enter:

```
> flint -d /dev/mst/mt4099_pci_cr0 -i <binary image> burn
```

- d. Reboot the computer
- e. Enter: mst start
- f. Verify that the card firmware was updated successfully

```
> flint -d /dev/mst/mt4099_pci_cr0 q
Image type:      ConnectX
FW Version:     2.9.4100
Device ID:      4099
...
```

Appendix A: Specifications

A.1 Board Mechanical Drawing and Dimensions

The ConnectX®-3 mezzanine card mechanical drawing is depicted in Figure 16.



All dimensions are in millimeters.
All the mechanical tolerances are +/- 0.1mm

Figure 16: Mechanical Drawing of 0J05YT/0K6V3V Mezzanine Card

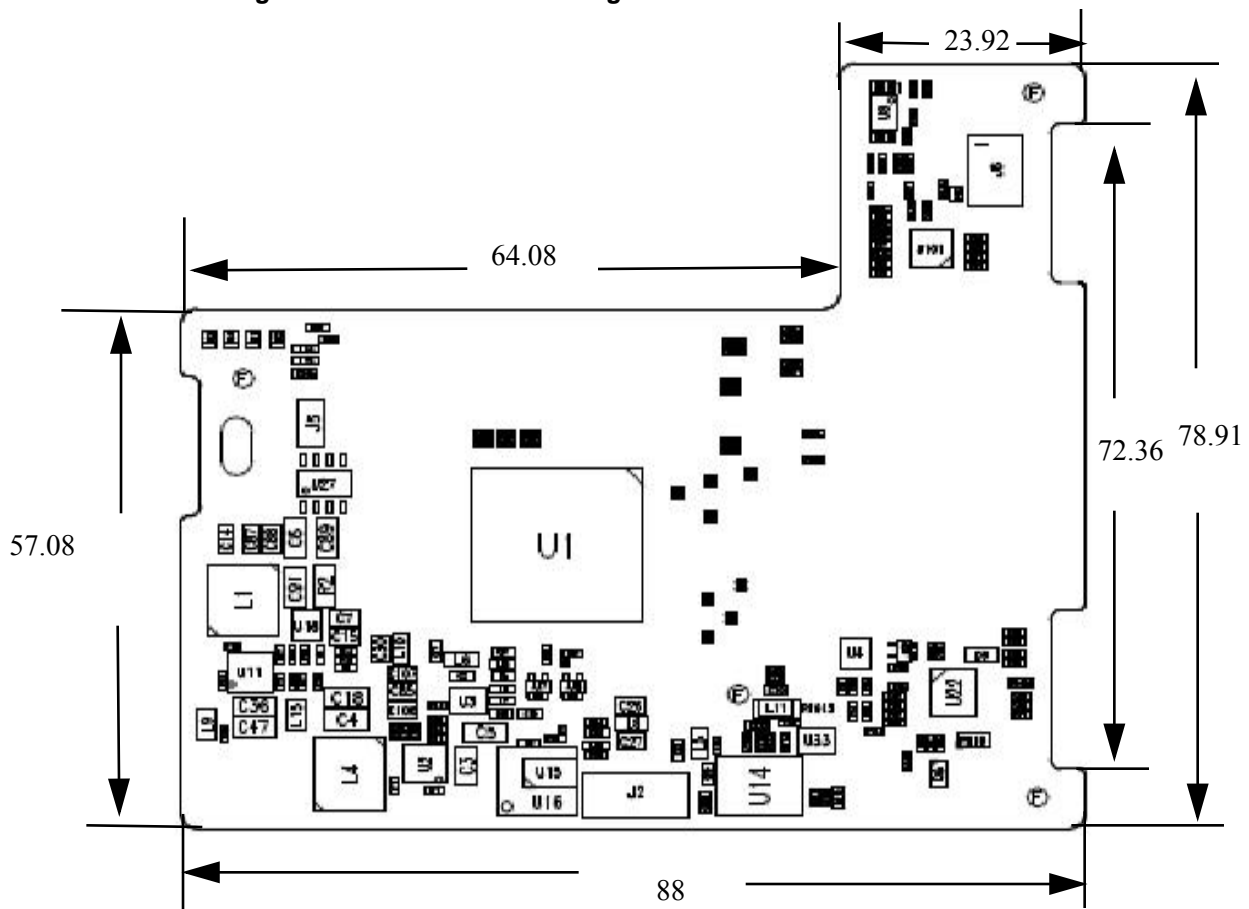

A.2 Specifications

Table 8 - ConnectX-3 0J05YT/0K6V3V Specifications Table

Physical	Size: 3.11in. x3.46 in. (78.91mm X 88mm)
Protocol Support	InfiniBand: IBTA v1.2.1 QDR (10Gb/s per lane) or FDR (14.0625Gb/s per lane) port
	Data Rate: Up to 56Gb/s FDR– InfiniBand
	PCI Express Gen3: 3.0 SERDES @ 8.0 GT/s (1.1 and 2.0 compatible)
Power and Environmental	Voltage: 12V, 3.3V, 3.3VAUX
	0J05YT Typ Power: 5.75W Max Power: 7.56W
	0K6V3V Typ Power: 8.84W Max Power: 9.02W
	Temperature: 0°C to 55°C
	Air Flow: 200LFM ^a
Regulatory	EMC: Refer to the following link: www.mellanox.com/related-docs/user_manuals/Regulatory_and_Compliance_Guide.pdf
	Safety: IEC/EN 60950-1:2006 ETSI EN 300 019-2-2 IEC 60068-2- 64, 29, 32
	RoHS: RoHS-R6
Cable Support	Please refer to "Mellanox Products Approved Cable Lists" at www.mellanox.com/related-docs/user_manuals/Mellanox_approved_cables.pdf

a. Air flow is measured ~1” from the heat sink between the heat sink and the cooling air inlet.

Appendix B: Avertissements de sécurité d'installation (French)

1. Instructions d'installation



Lisez toutes les instructions d'installation avant de brancher le matériel à la source d'alimentation électrique.

2. Température excessive



Ce matériel ne doit pas fonctionner dans une zone avec une température ambiante dépassant le maximum recommandé de 55°C (131°F). Un flux d'air de 200LFM à cette température ambiante maximale est nécessaire. En outre, pour garantir un bon écoulement de l'air, laissez au moins 8 cm (3 pouces) d'espace libre autour des ouvertures de ventilation.

3. Orages – dangers électriques



Pendant un orage, il ne faut pas utiliser le matériel.

4. Installation du matériel



Ce matériel ne doit être installé, remplacé ou entretenu que par du personnel formé et qualifié.

5. Elimination du matériel



L'élimination de ce matériel doit s'effectuer dans le respect de toutes les législations et réglementations nationales en vigueur.

6. Codes électriques locaux et nationaux



Ce matériel doit être installé dans le respect des codes électriques locaux et nationaux.

Appendix C: Installation - Sicherheitshinweise (German)

1. Installationsanleitungen



Lesen Sie alle Installationsanleitungen, bevor Sie das Gerät an die Stromversorgung anschließen.

2. Übertemperatur



Dieses Gerät sollte nicht in einem Bereich mit einer Umgebungstemperatur über der maximal empfohlenen Temperatur von 55°C (131°F) betrieben werden. Außerdem sollten mindestens 8 cm (3 in.) Freiraum um die Belüftungsöffnungen sein, um einen einwandfreien Luftstrom zu gewährleisten.

3. Bei Gewitter - Elektrische Gefahr



Arbeiten Sie während eines Gewitters und Blitzschlag nicht am Gerät.

4. Geräteinstallation



Diese Gerät sollte nur von geschultem und qualifiziertem Personal installiert, ausgetauscht oder gewartet werden.

5. Geräteentsorgung



Die Entsorgung dieses Geräts sollte unter Beachtung aller nationalen Gesetze Bestimmungen erfolgen.

6. Regionale und nationale elektrische Bestimmungen



Dieses Gerät sollte unter Beachtung der regionalen und nationalen elektrischen Bestimmungen installiert werden.

Appendix D: Advertencias de seguridad para la instalación (Warnings in Spanish)

1. Instrucciones de instalación



Antes de conectar el equipo a la fuente de alimentación, leer todas las instrucciones de instalación.

2. Sobre calentamiento



No se debe utilizar el equipo en un área con una temperatura ambiente superior a la máxima recomendada: 55°C(131°F). Además, para garantizar una circulación de aire adecuada, se debe dejar como mínimo un espacio de 8 cm (3 pulgadas) alrededor de las aberturas de ventilación.

3. Cuando hay rayos: peligro de descarga eléctrica



No utilizar el equipo ni conectar o desconectar cables durante períodos de actividad de rayos.

4. Instalación de equipos



La instalación, el reemplazo y el mantenimiento de este equipo estarán a cargo únicamente de personal capacitado y competente.

5. Eliminación de equipos



La eliminación definitiva de este equipo se debe efectuar conforme a todas las leyes y reglamentaciones nacionales.

6. Códigos eléctricos locales y nacionales



Este equipo se debe instalar conforme a los códigos eléctricos locales y nacionales.

Free Manuals Download Website

<http://myh66.com>

<http://usermanuals.us>

<http://www.somanuals.com>

<http://www.4manuals.cc>

<http://www.manual-lib.com>

<http://www.404manual.com>

<http://www.luxmanual.com>

<http://aubethermostatmanual.com>

Golf course search by state

<http://golfingnear.com>

Email search by domain

<http://emailbydomain.com>

Auto manuals search

<http://auto.somanuals.com>

TV manuals search

<http://tv.somanuals.com>