

Dell™ KM714 Wireless Keyboard and Mouse

# Owner's Manual



Information in this document is subject to change without notice.

© 2013 Dell Inc. All rights reserved.

Reproduction of these materials in any manner whatsoever without the written permission of Dell Inc. is strictly forbidden. Trademarks used in this text : Dell™ and the DELL logo are trademarks of Dell Inc.; Microsoft® and the Windows start button logo are either trademarks or registered trademarks of Microsoft Corporation in the United States and/or other countries.

Other trademarks and trade names may be used in this document to refer to either the entities claiming the marks and names or their products. Dell Inc. disclaims any proprietary interest in trademarks and trade names other than its own.

**2013 - 03 Rev. A00**

### Restrictions and Disclaimers

The information contained in this document, including all instructions, cautions, and regulatory approvals and certifications, is provided by the supplier and has not been independently verified or tested by Dell. Dell cannot be responsible for damage caused as a result of either following or failing to follow these instructions.

All statements or claims regarding the properties, capabilities, speeds or qualifications of the part referenced in this document are made by the supplier and not by Dell. Dell specifically disclaims knowledge of the accuracy, completeness or substantiation for any such statements. All questions or comments relating to such statements or claims should be directed to the supplier.

### Export Regulations

Customer acknowledges that these Products, which may include technology and software, are subject to the customs and export control laws and regulations of the United States ("U.S.") and may also be subject to the customs and export laws and regulations of the country in which the Products are manufactured and/or received. Customer agrees to abide by those laws and regulations. Further, under U.S. law, the Products may not be sold, leased or otherwise transferred to restricted end-users or to restricted countries. In addition, the Products may not be sold, leased or otherwise transferred to, or utilized by an end-user engaged in activities related to weapons of mass destruction, including without limitation, activities related to the design, development, production or use of nuclear weapons, materials, or facilities, missiles or the support of missile projects, and chemical or biological weapons.

# Contents

## Setup

## Keyboard

Features

Troubleshooting

Specifications

## Mouse

Features

Troubleshooting

Specifications

## Statutory Information

Warranty

Regulatory

Certifications

## Setup

### System Requirements

- One USB port (for the USB receiver)
- Microsoft Windows 8/7/RT

### Contents of the Box

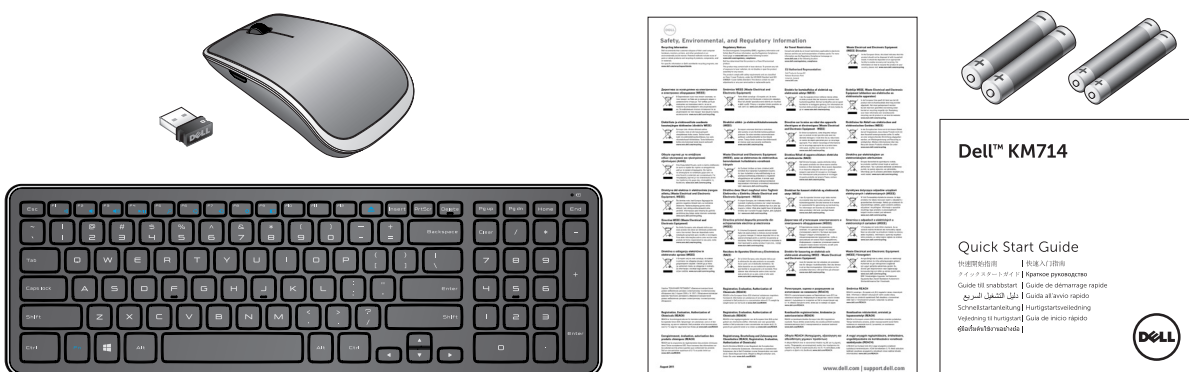

- One wireless keyboard
- One wireless mouse
- One USB receiver
- Two AA batteries for the mouse
- Two AAA batteries for the keyboard
- Product documentation

- 🔍 **NOTE:** The USB receiver may be pre-installed on your computer.
- 🔍 **NOTE:** The documents that shipped with the keyboard and mouse may vary based on your region.
- 🔍 **NOTE:** If the Caps Lock indicator does not appear on the screen or eject shortcut key does not function, download the software from [www.dell.com/support/KM714](http://www.dell.com/support/KM714)

## Setting Up Your Dell KM714 Wireless Keyboard and Mouse

1. Install the two AAA batteries in your keyboard.

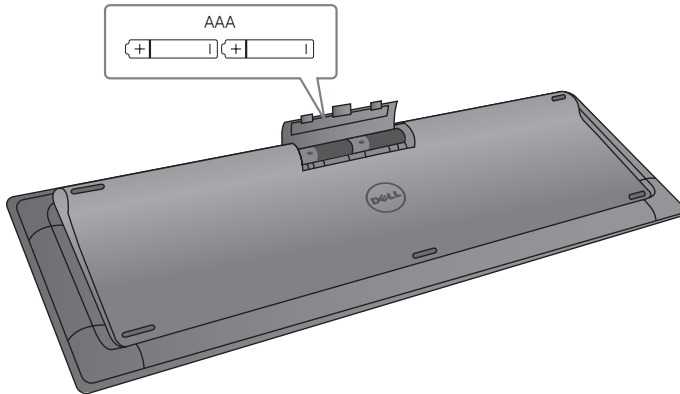

2. Install the two AA batteries in your mouse.

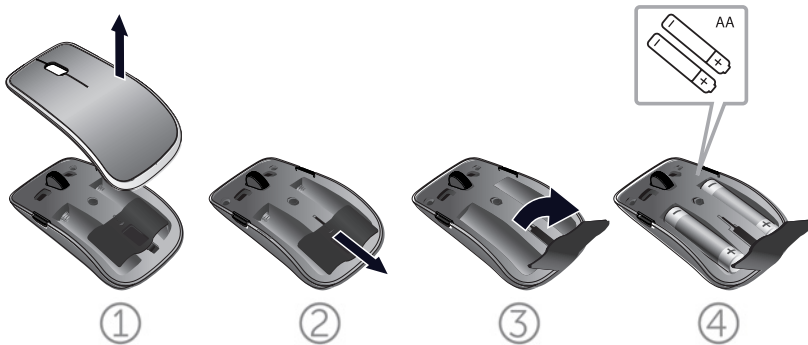

3. Connect the USB receiver to the computer.

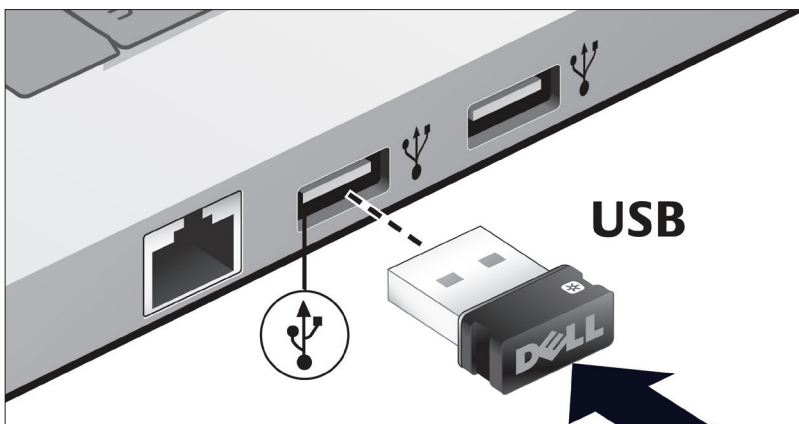

If your keyboard or mouse is not working, see the [Troubleshooting](#) section.

## Unifying Pairing Features

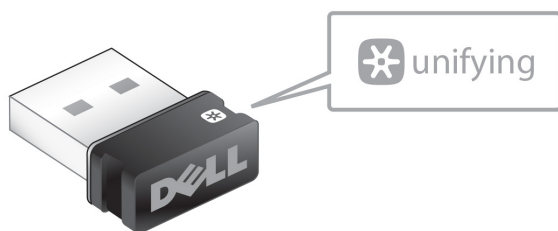

The USB Unifying receiver is a wireless receiver that can stay plugged into your computer's USB port, allowing you to easily connect your wireless mouse and keyboard to your computer, and up to four additional Unifying-compatible wireless devices at the same time.

To begin using your receiver, ensure your computer has the software installed. Unifying software may be pre-installed on your computer. The software can also be downloaded from [www.dell.com/support/Unifying](http://www.dell.com/support/Unifying)

## Features

### Top View

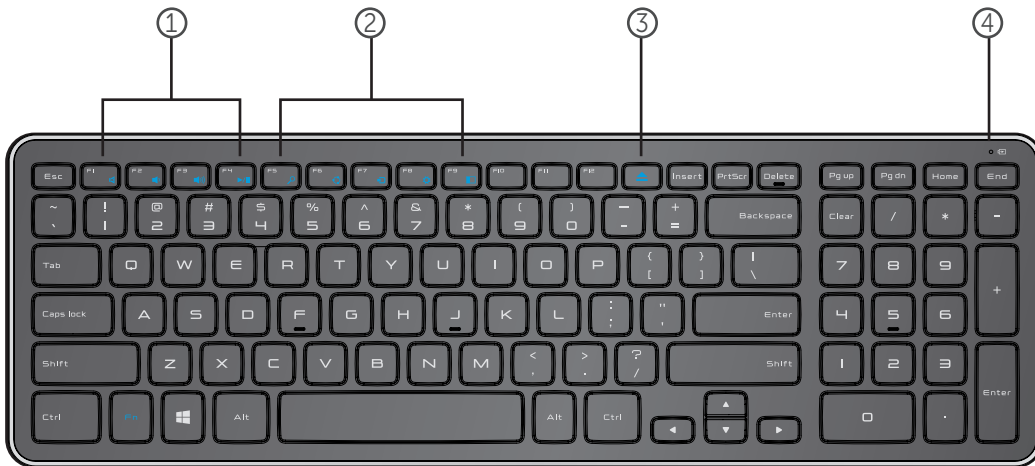

1. Multimedia Control Keys
2. Windows 8 shortcut keys
3. Optical-drive eject key
4. Battery status light – Indicates the status of the batteries installed on your keyboard
  - solid white** – Appears for about 15 seconds after the batteries are installed then turns off
  - blinking amber** – Battery charge is low. Replace the batteries.

## Features



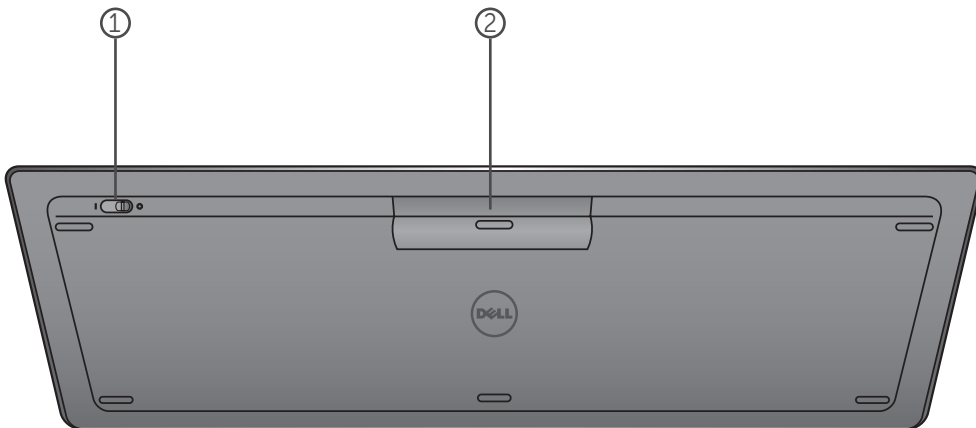





### Bottom View







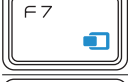





1. Power switch
2. Battery compartment



## Function Keys

 +		Mute the sound
		Decrease the volume level
		Increase the volume level
		Play or pause the media
		Search (Windows 8)
		Share (Windows 8)
		Devices (Windows 8)
		Settings (Windows 8)
		Recent Apps (Windows 8)

## Application Keys

Key Combinations	Function
 Windows key	Win7 : Open the Start Menu Win8 : Start screen
 + E	Open Windows Explorer
 + F	Find a document
 + M	Minimize all open windows
 + R	Display the Run dialog box
 + F1	Display the Help menu
 + TAB	Activate the next taskbar button
 + Ctrl + F	Open the find computers window
 + Shift + M	Undo minimize all windows
 + Pause/Break	Open the System Properties window

## Troubleshooting

If you have problems with your keyboard:

- Check if the batteries are inserted in the correct orientation.
- Check if the keyboard's power switch is set to "On".
- Remove and reinstall the batteries. The power status light turns on (solid white) for about 15 seconds and then turns off.
- Remove and reconnect the USB receiver on your computer.
- Connect the USB receiver into another USB port on your computer.
- Restart your computer.

## Specifications

### General

Model number	KM713
Connection type	2.4 GHz wireless technology
Supported operating systems	Microsoft Windows 8 Microsoft Windows 7 Microsoft Windows RT
Rollover	Pseudo N-key rollover capability
Key mechanism	Scissor

---

### Electrical

Operating voltage	2.05V to 3.2V
Battery life	Approximately 12 months
Battery required	Two AAA Alkaline

---

### Physical Characteristics

Height	21.2mm ( $\pm$ 0.4mm)
Length	380.03mm ( $\pm$ 0.7mm)
Width	122.21mm ( $\pm$ 0.4mm)
Weight	540g ( $\pm$ 10g), without batteries

---

### Environmental

Operating temperature	0°C to 40°C
Storage temperature	-40°C to 65°C
Operating humidity	90% maximum Relative Humidity, non condensing
Storage humidity	95% maximum Relative Humidity, non condensing

---

### 2.4 GHz Wireless

Radio transmission	Bi-directional communication (Transceiver)
Range	Up to 10 meters

## Features

### Top View



1. Left mouse button

2. Tilt wheel

3. Side button \*

4. Battery status light

Blinking amber - Battery charge is low. Replace the batteries.

5. Side button \*

6. Right mouse button

\*Both side buttons perform the same function.

## Features

### Bottom View



1. Laser sensor
2. Power button

## Shortcut Gestures

---



### Windows charms

Press and hold side button,  
and slide the mouse towards left.

(Windows 8 only)

---

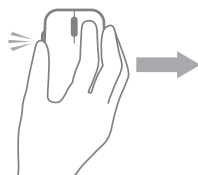

### App switch

Press and hold side button,  
and slide the mouse towards right.

(Windows 8 only)

---



### Scroll and pan

4-way scroll

(Windows 7 and 8)

---



### Zoom in/out

Press and hold side button,  
and scroll wheel up or down.

(Windows 7 and 8)

---



### Back

Press and hold side button,  
and tilt wheel towards left.

(Windows 7 and 8)

---

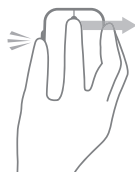

### Forward

Press and hold side button,  
and tilt wheel towards right.

(Windows 7 and 8)

---

## Increasing the Battery Life of your Mouse

The mouse has three operating modes built in to conserve battery power:

**1. Sleep mode:** When the mouse has been inactive for 5 seconds.

**To wake the mouse: Move, click or scroll the tilt wheel.**

**2. Deep sleep mode:** When the mouse has been inactive for 5 minutes.

**To wake the mouse: Move or click.**

**3. Cut-off mode:** When the mouse has been carried around or left facing upwards for 5 minutes or when the mouse has been inactive for 4 hours.

**To wake the mouse: Push the power button.**



## Troubleshooting

If you have problems with your mouse:

- Check if the batteries are inserted in the correct orientation.
- Check if the mouse's power button light is on.
- Remove and reinstall the batteries. Check to see if the power button light turns on (solid white).
- Remove and reconnect the USB receiver on your computer.
- Insert the USB receiver into another USB port on your computer.
- Restart your computer.

## Specifications

### General

Model Number	WM514
Connection Type	2.4 GHz wireless technology
Supported Operating Systems	Microsoft Windows 8 Microsoft Windows 7 Microsoft Windows RT

---

### Electrical

Operating Voltage	0.95 V to 1.8 V
Battery Life	Approximately 12 months
Battery Requirements	Two AA Alkaline

---

### Physical Characteristics

Height	33.6 ± 0.3 mm
Width	58.4 ± 0.3 mm
Length	109.9 ± 0.5 mm
Weight	67g, without batteries

---

### Environmental

Operating Temperature	0°C to 40°C
Storage Temperature	-40°C to 65°C
Operating Humidity	90% maximum Relative Humidity, non condensing
Storage Humidity	95% maximum Relative Humidity, non condensing

---

### 2.4 GHz Wireless

Radio Transmission	Bi-directional communication (Transceiver)
Range	Up to 10 meters

## Warranty

### Limited Warranty and Return Policies

Dell-branded products carry a 1-year limited hardware warranty.

If purchased together with Dell system, it will follow the system warranty.

#### **For U.S. customers:**

This purchase and your use of this product are subject to Dell's end user agreement, which you can find at [www.dell.com/terms](http://www.dell.com/terms). This document contains a binding arbitration clause.

#### **For European, Middle Eastern and African customers:**

Dell-branded products that are sold and used are subject to applicable national consumer legal rights, the terms of any retailer sale agreement that you have entered into (which will apply between you and the retailer) and Dell's end user contract terms. Dell may also provide an additional hardware warranty – full details of the Dell end user contract and warranty terms can be found by going to [www.dell.com](http://www.dell.com), selecting your country from the list at the bottom of the "home" page and then clicking the "terms and conditions" link for the end user terms or the "support" link for the warranty terms.

#### **For non-U.S. customers:**

Dell-branded products that are sold and used are subject to applicable national consumer legal rights, the terms of any retailer sale agreement that you have entered into (which will apply between you and the retailer) and Dell's warranty terms. Dell may also provide an additional hardware warranty – full details of Dell's warranty terms can be found by going to [www.dell.com](http://www.dell.com), selecting your country from the list at the bottom of the "home" page and then clicking the "terms and conditions" link or the "support" link for the warranty terms.

## Regulatory

Keyboard Regulatory Model: KM713

Mouse Regulatory Model: WM514

Dongle Regulatory Model: C-U0007

### Regulatory Information

These devices comply with Part 15 of the FCC Rules. Operation of the devices is subject to the following two conditions : (1) The devices may not cause harmful interference, and (2) The devices must accept any interference that may cause undesired operation.

This equipment has been tested and found to comply with the limits for a Class B digital device, pursuant to Part 15 of the FCC Rules. These limits are designed to provide reasonable protection against harmful interference in a residential installation. This equipment generates, uses, and can radiate radio frequency energy. If the equipment is not installed and used in accordance with the instructions, the equipment may cause harmful interference to radio communications. There is no guarantee, however, that such interference will not occur in a particular installation. If this equipment does cause harmful interference to radio or television reception (which can be determined by turning the equipment off and on), the user is encouraged to try to correct the interference by taking one or more of the following measures:

- Relocate this device.
- Increase the separation between the device and the receiver.
- Connect the device into an outlet on a circuit different from that of other electronics.
- Consult the dealer or an experienced radio technician for help.

### Agency Approval

C-Tick, FCC, CE, CB, UL, Canada IC, China SRRC, India WPC, Japan MIC, Thailand NTC, Singapore iDA, Malaysia SIRIM, Indonesia SDPPI, Russia GOST, Philippine NTC, Saudi Arabia (CITC & SASO), UAE TRA, Kuwait MOC, South Africa ICASA.

## Certifications

### Microsoft WHQL Logo

The Dell KM714 Wireless Keyboard and Mouse have passed WHQL logo testing by Microsoft Windows Hardware Quality Labs.

WHQL Logo is a certification scheme operated by Microsoft Windows Hardware Quality Labs. In this case it ensures that hardware is compatible with Microsoft Operating Systems. The keyboard and mouse are qualified through the use of WHQL test kits and have been included in the [Microsoft Hardware Compatibility List](#).

## Free Manuals Download Website

<http://myh66.com>

<http://usermanuals.us>

<http://www.somanuals.com>

<http://www.4manuals.cc>

<http://www.manual-lib.com>

<http://www.404manual.com>

<http://www.luxmanual.com>

<http://aubethermostatmanual.com>

Golf course search by state

<http://golfingnear.com>

Email search by domain

<http://emailbydomain.com>

Auto manuals search

<http://auto.somanuals.com>

TV manuals search

<http://tv.somanuals.com>