

**COBY®**

**TF-DVD5605**



**5.6" TFT LED Portable DVD/CD/MP3 Player**



## **Instruction Manual**

**Please read this manual carefully before operation.**

# PRECAUTIONS

	<b>CAUTION</b> WARNING: SHOCK HAZARD. DO NOT OPEN. AVIS: RISQUE DE CHOC ELECTRIQUE. NE PAS OUVRIE	
<b>CAUTION:</b> TO REDUCE THE RISK OF FIRE AND ELECTRIC SHOCK, DO NOT REMOVE THE COVER (OR BACK) OF THE UNIT. REFER SERVICING ONLY TO QUALIFIED SERVICE PERSONNEL.		

## For Customer Use:

Enter below the serial number that is located on the bottom of the unit. Retain this information for future reference.

Model No. TF-DVD5605

Serial No. \_\_\_\_\_



The lightning flash with arrowhead symbol within an equilateral triangle is intended to alert the user to the presence of uninsulated "dangerous voltage" within the product's enclosure that may be of sufficient magnitude to constitute a risk of electric shock.



The exclamation point within an equilateral triangle is intended to alert the user to the presence of important operation and servicing instructions in the literature accompanying the appliance.

### WARNING:

To prevent fire or shock hazard, do not expose this device to rain or moisture. Dangerous high voltage is present inside the enclosure. Do not open the cabinet.

### CAUTION:

This Digital Video Disc player employs a laser system. To prevent direct exposure to the laser beam, do not try to open the enclosure or defeat the safety interlocks. When open and the interlocks are defeated, visible laser radiation is present.

Use of controls, adjustments, or performance of procedures other than those specified herein may result in hazardous radiation exposure. **DO NOT STARE INTO THE BEAM.**

### FCC Notice:

This equipment has been tested and found to comply with the limits for a Class B digital device pursuant with the FCC Rules, Part 15. These limits are designed to provide reasonable protection against harmful interference in a residential installation. This equipment generates, uses, and can radiate radio frequency energy, and if not installed and used in accordance with the instructions may cause harmful interference to radio communication.

### WARNING:

Handling the cords on this product will expose you to lead, a chemical known to the State of California to cause cancer, and birth defects or other reproductive harm. **Wash hands after handling.**

### CAUTION:

To prevent electric shock, match wide blade of plug to wide slot of outlet and fully insert.

### NOTICE:

This product incorporates copyright protection technology that is protected by U.S. patents and other intellectual property rights. Use of this copyright protection technology must be authorized by Macrovision, and is intended for home and other limited viewing uses only unless otherwise authorized by Macrovision. Reverse engineering or disassembly is prohibited.



For recycling or disposal information about this product, please contact your local authorities or the Electronics Industries Alliance: [www.eiae.org](http://www.eiae.org).

# SAFETY INSTRUCTIONS

1. **Read Instructions:** All the safety and operating instructions should be read before the product is operated.
2. **Retain Instructions:** The safety and operating instructions should be retained for future reference.
3. **Heed Warnings:** All warnings on the product and in the operating instructions should be adhered to.
4. **Follow Instructions:** All operating and usage instructions should be followed.
5. **Cleaning:** Unplug this product from the wall outlet before cleaning. Do not use liquid cleaners or aerosol cleaners. Use a damp cloth for cleaning.
6. **Attachments:** Use only attachments recommended by the manufacturer. Use of other attachments may be hazardous.
7. **Water and Moisture:** Do not use this product near water (e.g., near a bath tub, washbowl, kitchen sink, laundry tub, in wet basements, or near a swimming pool and the like).
8. **Accessories:** Do not place this product on an unstable cart, stand, tripod, bracket, or table. Use only with carts, stands, tripods, brackets, or tables recommended by the manufacturer or sold with the product. Any mounting of the product should follow the manufacturer's instructions and should use a mounting accessory recommended by the manufacturer.
9. A product and cart combination should be moved with care. Quick stops, excessive force, and uneven surfaces may cause the product and cart combination to overturn.
10. **Ventilation:** Slots and openings in the cabinet are provided for ventilation to ensure reliable operation of the product and to protect it from overheating. These openings should never be blocked by placing the product on a bed, sofa, rug, or other similar surface. This product should not be placed in a built-in installation such as a bookcase or rack unless proper ventilation is provided or the manufacturer instructions have been adhered to.
11. **Power Sources:** This product should be operated only from the type of power source indicated on the rating label. If you are not sure of the type of power supply to your home, consult your product dealer or local power company. For products intended to operate from battery power or other sources, refer to the operating instructions.
12. **Grounding or Polarization:** This product may be equipped with a polarized alternating-current line plug that has one blade wider than the other. This plug will only fit into the power outlet in one direction. This is a safety feature. If you are unable to insert the plug fully into the outlet, try reversing the direction of the plug. If the plug should still fail to fit, contact an electrician to replace the obsolete outlet. Do not defeat the safety purpose of the polarized plug.
13. **Power-Cord Protection:** Power supply cords should be routed so that they are not likely to be walked on or pinched by items placed upon or against them, paying particular attention to cords at plugs, convenience receptacles, and at the point which they exit from the product.
14. **Protective Attachment Plug:** The product may be equipped with an attachment plug with overload protection. This is a safety feature. See the operating instructions for replacement or directions to reset the protective device. If replacement of the plug is required, be sure the service technician has used a replacement plug that has the same overload protection as the original plug as specified by the manufacturer.



# SAFETY INSTRUCTIONS

15. Outdoor Antenna Grounding: If an outside antenna is connected to the product, be sure the antenna system is grounded so as to provide some protection against voltage surges and built-up static charges. Article 810 of the National Electrical Code, ANS/NFPA 70 provides information with regard to proper grounding of the mast and supporting structure, grounding of the lead-in wire to an antenna-discharge unit, size of grounding conductors, location of antenna-discharge unit, connection to grounding electrodes, and requirements for the grounding electrode (see figure).

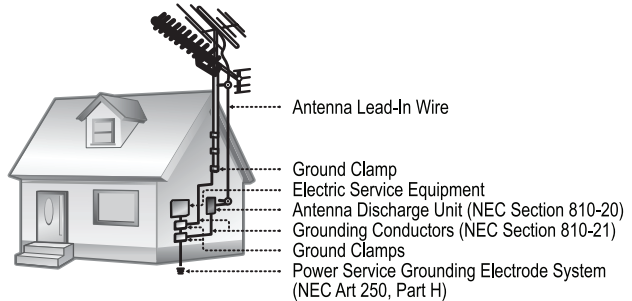

16. Lightning: For added protection for this product, unplug it from the wall outlet and disconnect the antenna or cable system during a lightning storm or when it is left unattended and unused for long periods of time. This will prevent damage to the product due to lightning or power-line surges.
17. Power Lines: An outside antenna system should not be located in the vicinity of overhead power lines or other electric light or power circuits, or where it can fall into such power lines or circuits. When installing an outside antenna system, extreme care should be taken to keep from touching such power lines or circuits, as contact with them might be fatal.
18. Overloading: Do not overload wall outlets, extension cords, or integral convenience receptacles as this can result in a risk of fire or electric shock.
19. Object and Liquid Entry: Never push objects of any kind into this product through openings as they may touch dangerous voltage points or shout-out parts that could result in a fire or electric shock. Never spill liquid of any kind on the product.
20. Servicing: Do not attempt to service this product yourself as opening or removing covers may expose you to dangerous voltage or other hazards. Refer all servicing to qualified service personnel.
21. Damage Requiring Service: Unplug this product from the wall outlet and refer servicing to qualified service personnel under the following conditions: a) when the power-supply or plug is damaged; b) if liquid has been spilled or if objects have fallen into the product; c) if the product has been exposed to rain or water; d) if the product does not operate normally by following the operating instructions. Adjust only those controls that are covered by the operating instructions as improper adjustment of other controls may result in damage and will often require extensive work by a qualified technician to restore the product to its normal operation; e) if the product has been dropped or damaged in any way; f) when the product exhibits a distinct change in performance—this indicates a need for service.
22. Replacement Parts: When replacement parts are required, be sure that your service technician has used replacement parts specified by the manufacturer or have the same characteristics as the original part. Unauthorized substitutions may result in fire, electric shock, or other hazards.
23. Safety Check: Upon completion of any service or repairs to this product, ask the service technician to perform safety checks to ensure that the product is in proper operating condition.

# SAFETY INSTRUCTIONS

24. Wall or Ceiling Mounting: The product should be mounted to a wall or ceiling only as recommended by the manufacturer.
25. Heat: The product should be situated away from heat sources such as radiators, heat registers, stoves, or other products (including amplifiers) that produce heat.

**Note:**

*The main plug is used to disconnect the device. It should remain within reach and should not be obstructed during intended use.*

# TABLE OF CONTENTS

PRECAUTIONS.....	2
SAFETY INSTRUCTIONS.....	3
TABLE OF CONTENTS.....	6
PACKAGE CONTENTS.....	8
ABOUT OPTICAL DISCS.....	9
Disc Requirements.....	9
Disc Care and Maintenance.....	9
Handling a Disc.....	9
Cleaning a Disc.....	9
LOCATION OF CONTROLS.....	10
Main Unit.....	10
Remote Control.....	11
CONNECTIONS.....	12
Audio/Video (AV) Output.....	12
GETTING STARTED.....	13
Remote Control.....	13
Power Supply.....	13
Using the AC Power Adapter.....	13
Using the DC (Car) Power Adapter.....	14
Using the Battery Pack (DC).....	14
BASIC OPERATIONS.....	15
Basic Disc Playback.....	15
Play/Pause/Stop.....	15
Previous/Next (Skip).....	15
Reverse/Forward (Search).....	15
Slow.....	15
Menu Navigation.....	16
Numeric Keypad.....	16
Adjusting the Volume.....	16
Disc Error Messages.....	16

# TABLE OF CONTENTS

DVD/DISC FUNCTIONS .....	17
Search .....	17
DVD Chapter/Title Search .....	17
DVD Time Search (within a specified title) .....	17
CD Time Search: .....	17
Repeat Mode.....	17
Repeat A-B Mode .....	17
Multi-Angle/Subtitle/Audio .....	18
Zoom .....	18
Program .....	18
DVD Program Mode.....	18
CD Program Mode.....	19
MP3 Program Mode.....	19
FUNCTION BUTTONS .....	20
LCD Mode .....	20
Display .....	20
DVD SETUP .....	21
Language Setup.....	21
Screen Setup .....	21
Custom Setup .....	22
SPECIFICATIONS.....	23
TROUBLESHOOTING.....	24

# PACKAGE CONTENTS

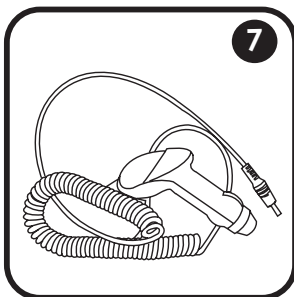
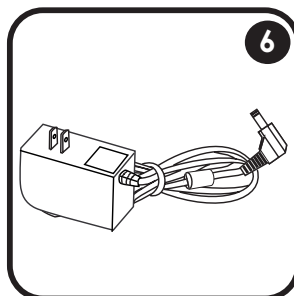
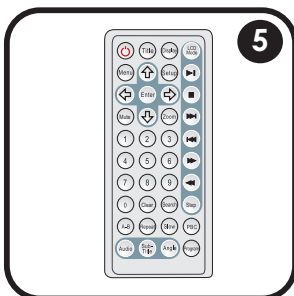
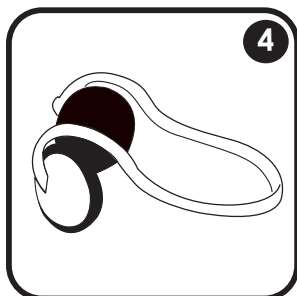
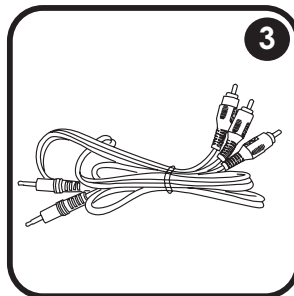
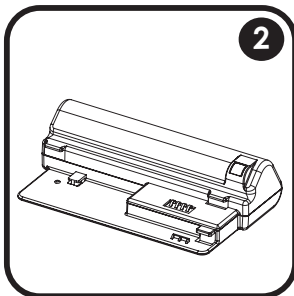

1. TF-DVD5605
2. Battery Pack
3. AV Cable

4. Stereo Headphones
5. Remote Control
6. AC Adapter



7. DC Car Adapter



# ABOUT OPTICAL DISCS

## Disc Requirements

This DVD player supports playback of the following discs.

Type	Disc Mark	Content Type	Disc Size	Max. Playback Time
DVD-Video Discs		Audio + Video (moving picture)	12 cm	133 min (SS-SL)
				242 min (SS-DL)
				266 min (DS-SL)
				484 min (DS-DL)
Audio Compact Discs (CDs)		Audio	12 cm	74 min
MP3 CDs	 (CD-R, CD-RW)	Audio	12 cm	~14 hours
JPEG CDs	--	Still Picture	12 cm	--

This unit can play back CD-R and CD-RW discs that contain audio titles, MP3 files, or JPEG picture files. Discs not listed above are not supported by this unit (e.g., PC CD-ROM, CD-Extra, CD-G, CD-I, etc.)

## Disc Care and Maintenance

Optical discs (DVDs, CDs) contain high-density compressed data and need proper handling.

### **Handling a Disc**

- Hold a DVD/CD by its edges. Avoid touching the recorded side of the disc. To remove a DVD/CD from its storage case, press down on the center retention mechanism of the case and lift the disc out.
- Do not subject discs to prolonged exposure to direct sunlight, high humidity, or high temperatures.
- Do not bend or press discs.
- To reduce the risk of scratches, always put discs back in their case after use. Store discs vertically in a cabinet.
- Do not place stickers or labels on either side of a disc.



### **Cleaning a Disc**

Use a dry, soft cloth to wipe off any fingerprints and dusts from the playing surface of the disc. Wipe in a straight line radially from the center to the outside edge of the disc. Small dust particles and light stains will not affect playback quality.

- Never use chemicals such as record sprays, anti-static sprays, benzene, or thinners to clean a disc. Doing so will damage the surface of the disc permanently.

# LOCATION OF CONTROLS

## Main Unit

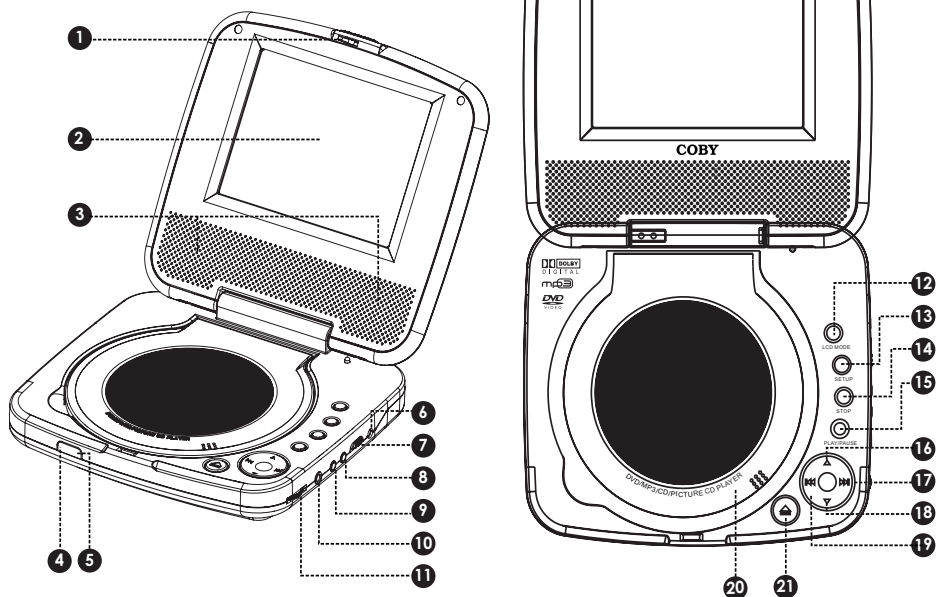

1. Latch
2. TFT LED Display
3. Stereo Speakers
4. Remote Sensor
5. Power Indicator
6. Power In Jack (DC 9V)
7. Power Switch
8. Video Out Jack
9. Audio Out Jack
10. Headphone Jack
11. Volume Control Dial
12. LCD Mode
13. Setup
14. Stop
15. Play/Pause/Enter
16. Up (Navigation)
17. Right (Navigation) Next/Forward
18. Down (Navigation)
19. Left (Navigation) Previous/Reverse
20. Disc Tray Lid
21. Disc Tray Open

# LOCATION OF CONTROLS

## Remote Control

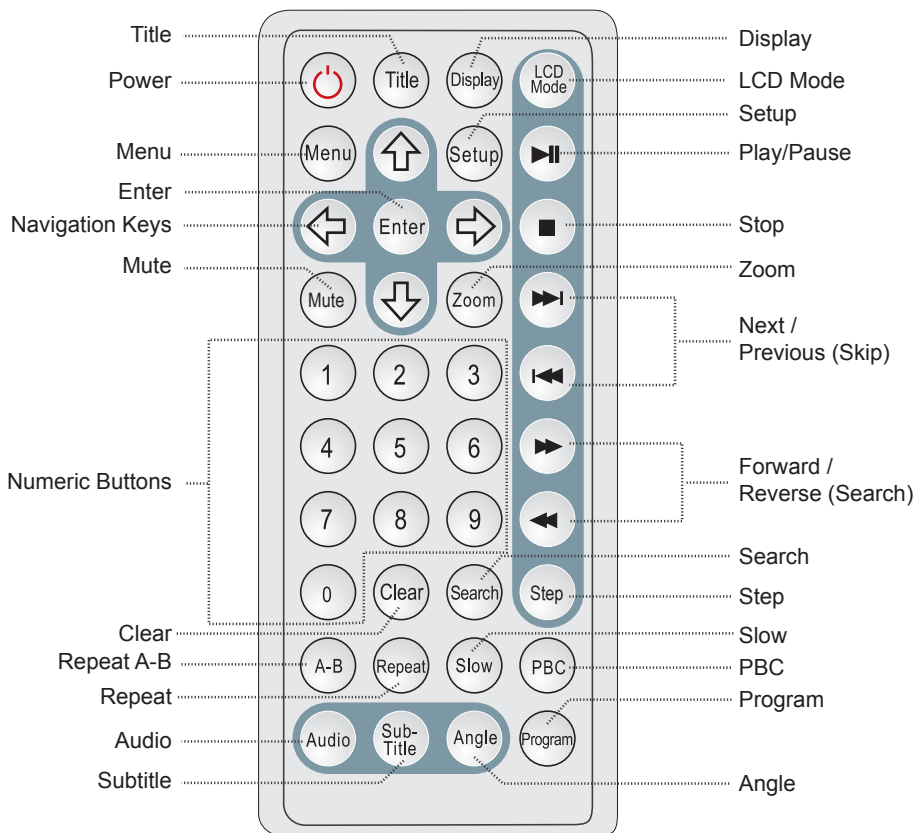

# CONNECTIONS

## **Audio/Video (AV) Output**

Your player comes equipped with AV Output Jacks.

Use the AV Output connection to output your player's DVD signal to an external display (e.g., a TV or monitor).

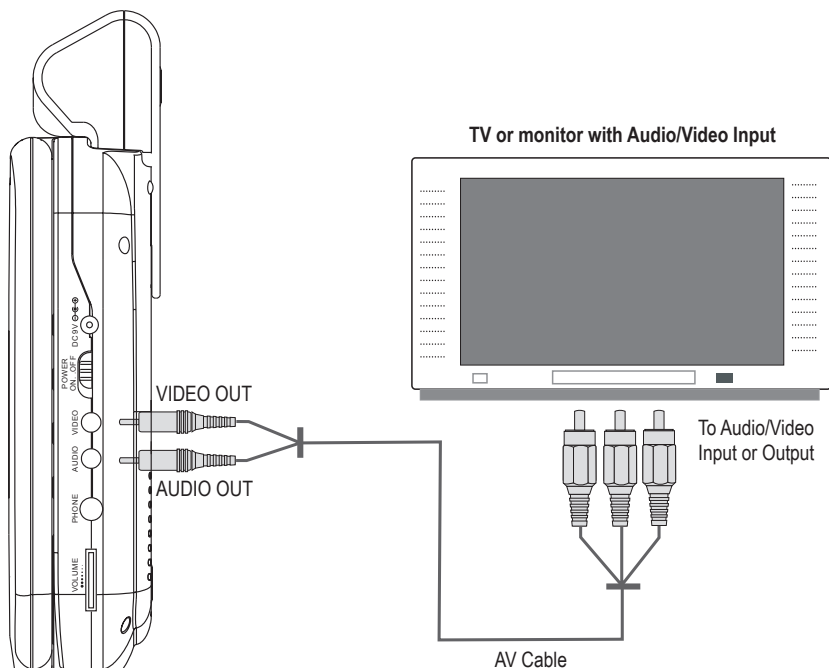

### **NOTE:**

- Refer to your TV's instruction manual for more information on setting it to the proper AV mode.
- Be sure to turn off and unplug your player and TV before making these connections.

# GETTING STARTED

## Remote Control

- Refer to the diagram. Remove the battery compartment cover located on the rear of the remote control. Insert batteries, making sure to match their polarities (+/-) to the markings on the inside of the compartment. Replace the cover.
- To use the remote, point it at the remote sensor of the player. Operate the remote within 15 feet of the sensor and at an angle of +/- 60 degrees.
- Batteries in the remote will last for approximately 1 year. Replace the batteries if the remote control does not work. Do not mix old with new batteries, or different types of batteries.
- Remove the batteries from the remote if it will not be used for a long period of time.

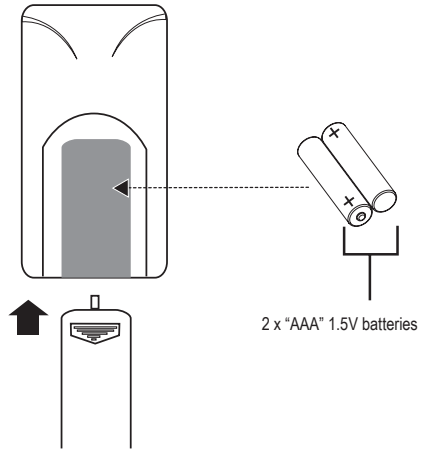

## WARNING

- The battery used in this device may present a fire or chemical burn if mistreated. Do not recharge, disassemble, incinerate, or heat the battery (~212°F).
- Keep batteries away from children.

## Power Supply

### Using the AC Power Adapter

This AC adapter should be used with 100-240V 50/60Hz AC wall outlets.

- DC Out: 9V
- DC Current: 2.0A min.

### Caution:

- *Do not connect the power plug to a power outlet other than that which is indicated here and on the label as this may result in the risk of fire or electric shock.*
- *Do not handle the power plug with wet hands. Doing so may cause electric shock.*
- *Only use AC adapters of the type specified here. Failure to do so may cause a fire or damage the player.*

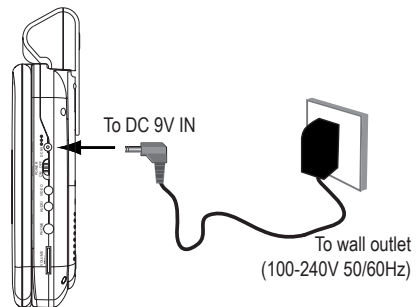

# GETTING STARTED

## Using the DC (Car) Power Adapter

This DC adapter should be used with DC car sockets.

- *The DC power adapter is for in-car use, only.*

## Using the Battery Pack (DC)

The rechargeable battery pack can be used for approximately 300 charge-cycles without any noticeable change in performance.

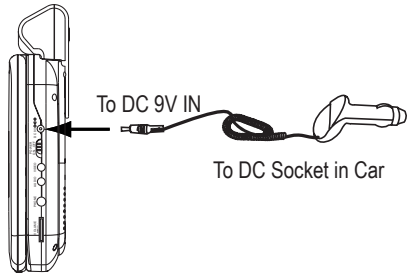

**Important:** *The battery should be charged fully (minimum 4 hours) before its initial use to ensure optimum lifetime performance.*

## To install the battery pack:

1. Place the battery into its cradle and align the battery hook with its slot. Match and insert the Retention Clips on the battery pack to the Retention Slots on the bottom of the player.
2. While pressing the battery down to prevent it from springing up, slide the battery in the direction of the arrow to lock it into place.
3. To release the battery, press the "Battery Release" button and slide the battery out in the opposite direction of the arrow.

## NI-MH Rechargeable Battery Pack

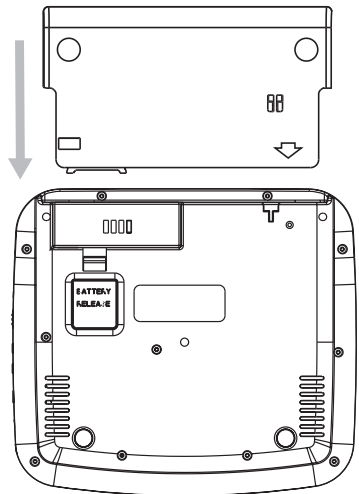

**TF-DVD5605  
(Bottom View)**

## To charge the battery pack:

1. While the battery pack is installed, connect the AC power adapter to the Power In jack located on the main unit.

## Note:



*When the battery charge level is low, the unit will enter STANDBY mode automatically.*

*Use the supplied power adapter only.*

*Do not incinerate or heat up the battery.*

*Do not use in high temperatures or near heat sources.*

*Use of other types of batteries may present the possibility of explosion. Replace the battery with the same or equivalent battery.*

## Power Management







If the player will not be in use for a long period of time, set the Power Switch to the OFF position, remove the battery, and unplug the player.

# BASIC OPERATIONS



## **Basic Disc Playback**

1. Open the player.  
Slide the latch in the direction of the arrow to unlock the DVD player and unfold to open.
2. Prepare the power supply.  
Set the Power Switch to the ON position to turn the player on.
3. Load a disc.  
Press the Open button to open the disc compartment lid. Insert a disc with the label-side up. Close the lid by hand (the lid will click into place).
  - If a single-sided disc is inserted upside-down, the player will display "NO DISC" or "BAD DISC".
3. Start playback.  
Make sure the AV Switch is set to AV OUT to use the player's built-in LCD screen. Press PLAY to start playback (some discs may start playing automatically).

## **Play/Pause/Stop**





- Press  to play the disc for the first time.
- Press  during playback to pause. Press  again to resume playback.
- Press  during playback to stop the disc ("Pre-Stop"). Press  to resume playback at the time-point at which the disc was stopped.
- Press  when the disc is "Pre-Stopped" to stop playback completely. (When  is pressed, the disc will start playing from the beginning.)

## **Previous/Next (Skip)**





- Press  to skip back one track (DVD, CD, MP3, etc).
- Press  to skip forward one track (DVD, CD, MP3, etc).



## **Reverse/Forward (Search)**

Normal     x2     x4     x8     x16     x32

- Press  to reverse through the disc. Each successive press of  will change the rate of reverse playback.
- Press  to fast-forward through the disc. Each successive press of  will change the rate of forward playback.

## **Slow**

Normal     x1/2     x1/4     x1/8     x1/16     x1/32

- Press SLOW for slow-motion playback. Each successive press of SLOW will change the rate of slow-motion playback. Press  to resume normal playback.
- Press STEP frame-by-frame playback. Each successive press of STEP will advance the video one frame. Press  to resume normal playback.

## **Note:**

*Audio will be muted during fast-forward, fast-reverse, and slow-motion playback.*

# BASIC OPERATIONS

## Menu Navigation

To navigate DVD disc menus or the player's setup menus:

- Use the Navigation keys (Up/Down/Left/Right) to select a desired feature or option in the menu.
- Press ENTER to confirm a selection in the menu.
  - For some menu options, you may be able to use the numeric keypad to input data.
- Press  to cancel an entry.

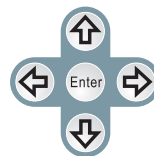

## Numeric Keypad

- Use the numeric keypad to skip directly to a DVD chapter or CD track.
- Use the numeric keypad to input numeric data in menu option fields when possible.

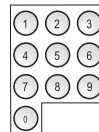

## Adjusting the Volume

- Turn the Volume Control dial to adjust the volume level up or down.
- Press MUTE to turn the volume off completely; press mute again to restore the volume to its previous level.

## Disc Error Messages

The following messages will be displayed on-screen if there is a problem with the format of the loaded disc.

- **WRONG REGIONAL DISC.** The region code of the disc does not match the player's region code (Region 1).
- **WRONG PASSWORD.** The parental rating level of the disc is higher than the parental rating level setting of the player. The player will not play the disc.
- **WRONG DISC.** The player is equipped with automatic disc quality detection software. If the player detects a disc that is damaged or has a format problem, it may play the disc at a lower quality or stop play completely, depending on how damaged the disc is.



*DVD disc production quality may vary; some discs may deviate from the industry standard. Some incorrectly-formatted discs may still play, however, the playback and operational quality of the disc may be substandard.*



# DVD/DISC FUNCTIONS

## Search

Press SEARCH to go directly to a desired point of a disc (e.g., Title, Chapter, Time).

### DVD Chapter/Title Search

- Press SEARCH once to display the Chapter/Title Search Bar.
- Press the LEFT/RIGHT navigation keys to select (highlight) an entry field.
- Use the Numeric keypad to input the desired chapter/title number, or press the UP/DOWN navigation keys to increase/decrease the chapter/title number.
- Press ENTER to confirm and execute the search or press SEARCH to exit search mode.



### DVD Time Search (within a specified title)

- Press SEARCH twice to display the Time Search Bar.
- Use the Numeric keypad to input the desired time (hours, minutes, seconds).
  - Press CLEAR to cancel any input errors.
- Press ENTER to confirm and execute the search or press SEARCH to exit search mode.



### CD Time Search:

- Press SEARCH once to display the CD Time Search Bar shown to the right.
- Use the Numeric keypad to input the desired time (hours, minutes, seconds).
  - Press CLEAR to cancel any input errors.
- Press ENTER to confirm and execute the search or press SEARCH to exit search mode.



## Repeat Mode

Press REPEAT to change the repeat mode of the player. Each successive press of REPEAT will change the mode as follows:

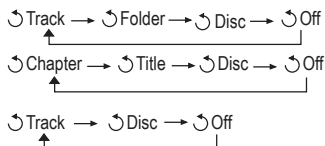

### **Note:**

*Some DVD discs do not allow Repeat mode.*

## Repeat A-B Mode

To repeat playback of a specific section of a disc (loop):

1. Press A-B to set the desired start point ("A") of the section to be repeated.
2. Press A-B again to set the desired end point ("B" of the section to be repeated).
3. The section "A-B" will now play repeatedly as a loop. Press A-B again to resume normal playback.

# DVD/DISC FUNCTIONS

## Multi-Angle/Subtitle/Audio

- During playback of a DVD that has been mastered with multiple angles, press ANGLE to view the available alternate camera angles. (A DVD may have up to 9 selectable angles.)
- During playback of a DVD that has been mastered with subtitles, press SUBTITLE to view the available subtitle tracks. (A DVD may have up to 32 selectable subtitles.)
- During playback of a DVD that has been mastered with alternate language/audio tracks, press AUDIO to hear the alternate tracks. (A DVD may have up to 8 selectable audio tracks.)
  - During CD or MP3-CD playback, press AUDIO to change between stereo, left-channel, and right-channel audio (the default setting is stereo).

## Zoom

Press ZOOM to change the magnification level of the picture.

- During DVD playback, each successive press of ZOOM will change the level of magnification to: Zoom 2x, Zoom 4x, Normal.
- During JPEG CD playback, each successive press of ZOOM will change the level of magnification to: 25%, 50%, 100%, 150%, 200%.

When the magnification level is greater than Normal/100%, use the navigation keys (UP/DOWN/LEFT/RIGHT) to pan around the magnified picture.

**Note:** The picture quality will decrease as the zoom level increases.

## Program

Enter Program mode to create a custom sequence of tracks to be played.

**(Program mode is available only when the player is in NAVIGATE OFF mode. Press the PBC button to set the player to NAVIGATE OFF mode.)**

### **Note:**

You can also use the numeric keypad to enter numbers directly in the fields. Use the navigation keys to move between entry fields.

## **DVD Program Mode**

1. Load a DVD and press PROGRAM.
2. Press the RIGHT navigation key to select the "Title" column; press the UP/DOWN navigation keys to select a title.
3. Press RIGHT to select the "Chapter" column; press UP/DOWN to select a chapter.
4. Press ENTER to confirm the selection.
5. Repeat steps 2-4 until you have finished programming your selections or when you have programmed the maximum 20 tracks.
6. Press PLAY to start playback. Press PROGRAM to cancel.

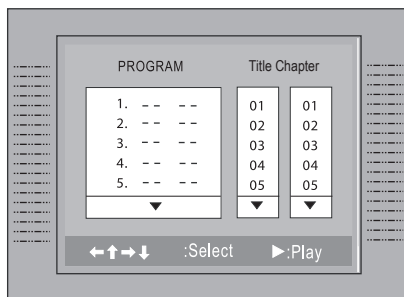

# DVD/DISC FUNCTIONS

## CD Program Mode

1. Load a CD and press PROGRAM.
2. Press the RIGHT navigation key to select the "Track" column; press the UP/DOWN navigation keys to select a track.
3. Press ENTER to confirm the selection.
4. Repeat steps 2-3 until you have finished programming your selections or when you have programmed the maximum 20 tracks.
5. Press PLAY to start playback. Press PROGRAM to cancel.

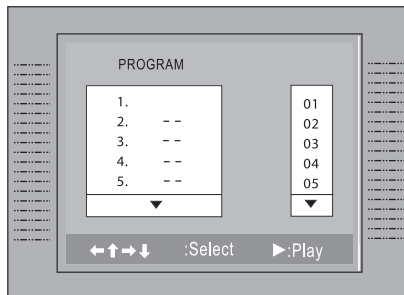

## MP3 Program Mode

1. Load an MP3-CD and press PROGRAM.
2. Use the navigation keys to select the desired file.
  - To navigate through subfolders: press the LEFT/RIGHT navigation keys to enter/exit a folder.
3. Press RIGHT to confirm. The confirmed file will be marked as a programmed file.
4. Repeat steps 2-3 until you have finished programming your selections or when you have programmed the maximum 20 tracks.
5. Press ENTER to confirm the selection.
6. Press PLAY to start playback. Press PROGRAM to cancel.

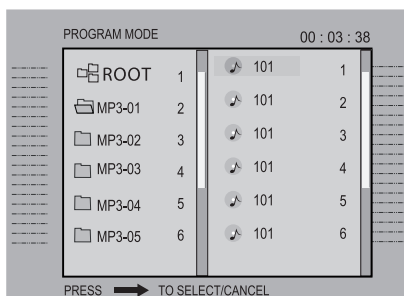

# FUNCTION BUTTONS

## LCD Mode

Press the LCD MODE button to adjust the brightness, contrast, and color of the LCD screen.

1. Press the UP/DOWN navigation keys to select the desired setting to adjust. From top to bottom, the settings are: Screen, Brightness, Contrast, Color, and Reset.
2. Press the LEFT/RIGHT navigation keys to adjust the selected setting.
  - Use the BRIGHTNESS adjustment to make the screen brighter or darker.
  - Use the CONTRAST adjustment to display a picture with higher or lower contrast.
  - Use the COLOR adjustment to display a picture with higher or lower color saturation.
  - Select RESET and press ENTER to return the LCD mode adjustments to their factory-default settings.

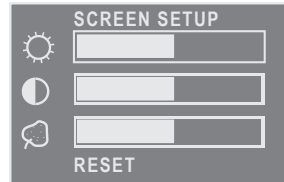

## Display

- Press the DISPLAY button once to show time information on-screen; press it twice to show status information on-screen; press it a third time to exit the on-screen display mode.

# DVD SETUP

Enter DVD Setup mode to adjust the various internal DVD settings of the player. Make sure the player has been completely stopped before entering Setup mode.

1. Press SETUP while the player is in DVD mode to access the DVD Setup menu.
2. Use the NAVIGATION keys to select a desired item.
3. Press ENTER to confirm a selection.
4. Press SETUP to exit Setup mode (or select EXIT and press ENTER).



## Language Setup

Use the NAVIGATION keys to highlight the desired language selection and press ENTER to confirm.

Item	Description	Options (Default is in Bold)
OSD	Sets the language of the player's on-screen display.	<b>English</b> , French, German, Spanish
Menu	Sets the default menu language of loaded DVDs.	<b>English</b> , Chinese, Japanese, French, German, Italian, Spanish, Portuguese, Hindi, Thai, Russian, Korean, Others
Audio	Sets the default language audio track of loaded DVDs.	<b>English</b> , Chinese, Japanese, French, German, Italian, Spanish, Portuguese, Hindi, Thai, Russian, Korean, Others
Subtitle	Sets the default subtitle track of loaded DVDs.	<b>English</b> , Chinese, Japanese, French, German, Italian, Spanish, Portuguese, Hindi, Thai, Russian, Korean, Others

## Screen Setup

Use the NAVIGATION keys to highlight the desired screen selection and press ENTER to confirm.

Item	Description	Options (Default is in Bold)
TV Type	Sets the aspect ratio of the display.	4:3 (PS) - Pan & Scan <b>4:3 (LB)</b> - Letterbox 16:9 - Widescreen
Screen Saver	The screensaver prevents burn-in damage to the player's screen.	<b>On</b> , Off
TV System	Sets the player's Video Out signal type. Set this to correspond with your TV.	<b>NTSC</b> , PAL, Auto

# DVD SETUP

## Custom Setup

Use the NAVIGATION keys to highlight the desired Custom Setup selection and press ENTER to confirm.

Item	Description	Options (Default is in Bold)
Parental Ctrl	Sets the maturity rating level of the player. The player will not play any discs rated higher than this setting. <u>This setting is password protected (the default password is: 8888).</u>	Levels 1 to 8. ( <b>8: ADULT is default</b> )
Password	Change the Parental Ctrl password. Enter the old password, the new password, and then the new password again to verify. <b>DO NOT FORGET THE PASSWORD; this password cannot be reset.</b>	
Angle Mark	Displays an on-screen prompt whenever an alternate angle becomes available for viewing (press ANGLE to view).	<b>On</b> , Off
Default	Resets all settings to their factory-default state. <b>This will not reset the Parental Ctrl password.</b>	Read

# SPECIFICATIONS

Power Supply	DC: 9V, 2A AC: 100-240V Adapter
Power Consumption	≤ 9W
Video Signal System	NTSC / PAL
Video Output	3.5mm mini-jack to Composite Video
Audio Output	3.5mm Stereo Headphone 3.5mm Stereo Line-Out Optical Out
S/N Ratio	90dB Typical
Dynamic Range (Audio)	90dB Typical
Display Type	5.6" TFT LED
Display Resolution	320 x 240
Operating Temperature	32°F - 95°F
Unit Dimensions	7.36" x 1.97" x 6.69" (WHD) (Main Unit + Battery)
Weight	2.1 lbs (Main Unit + Battery)

Specifications and manual are subject to change without prior notice.

# TROUBLESHOOTING

If you have a problem with this player, please read the troubleshooting guide below and check our website at [www.cobyusa.com](http://www.cobyusa.com) for Frequently Asked Questions (FAQs) and firmware updates. If these resources do not resolve the problem, please contact Technical Support.

## **COBY Electronics Technical Support**

56-65 Rust Street  
Maspeth, NY 11378

Hours: Monday to Friday, 8:30 AM–11:00 PM EST  
Saturday to Sunday, 9:00 AM–11:00 PM EST

Email: [techsupport@cobyusa.com](mailto:techsupport@cobyusa.com)

Phone: 800-681-2629 or 718-416-3197

Web: [www.cobyusa.com](http://www.cobyusa.com)

### ***There is no power to the device.***

- Ensure that the Power Switch is physically set to the ON position.
- Ensure that the AC adapter cord is securely connected to the player and the proper wall outlet.
- Ensure that the battery pack is fully charged.

### ***The device does not play.***

- Ensure that a supported disc is loaded in the player label-side up.
- Ensure that the disc's rating level does not exceed the player's.
- Ensure that the disc is not damaged or too dirty. Clean the disc or try another disc.
- Moisture may have condensed inside the player. Remove the disc and leave the player on for 1-2 hours and then try again.

### ***There is no picture.***

- Ensure that the AV switch is set to the correct mode (AV IN or AV OUT).
- Ensure that the TV set has been powered on and is set to the correct AV mode.
- Ensure that the connections between the player and the TV are secure and correct.
- Check if the connection cables are damaged.

### ***The picture is noisy or distorted.***

- The disc may be damaged or dirty. Clean the disc or try another one.
- Reset your TV's color system.
- Ensure that the player is connected directly to the TV (and not through a VCR, cable box, satellite receiver, etc.)

### ***There is no sound or distorted sound.***

- Ensure that the TV and amplifier have been turned on and properly set up.
- Ensure that the TV and amplifier connections are secure and correct.
- Try a different Audio track of the DVD by pressing AUDIO.
- Ensure that the MUTE function of the TV, Amplifier, or Player is not engaged.



# TROUBLESHOOTING

## ***The remote control doesn't work.***

- Ensure that the Power Switch has been physically set to the ON position.
- Ensure that there are no obstacles between the remote and the player.
- Point the remote at the remote sensor on the main unit.
- Ensure that the batteries in the remote retain a charge and have been installed correctly.
- Try replacing the remote's batteries.

## ***The player has malfunctioned.***

- Unplug the player and remove the battery pack for 30 minutes. After that, reinstall the battery and plug in the player. Power on the player -- the restore function should reset the player.

# NOTES

# NOTES

**COBY Electronics Corp.**

56-65 Rust Street  
Maspeth, NY 11378

[www.cobyusa.com](http://www.cobyusa.com)  
[www.ecoby.com](http://www.ecoby.com)

## Free Manuals Download Website

<http://myh66.com>

<http://usermanuals.us>

<http://www.somanuals.com>

<http://www.4manuals.cc>

<http://www.manual-lib.com>

<http://www.404manual.com>

<http://www.luxmanual.com>

<http://aubethermostatmanual.com>

Golf course search by state

<http://golfingnear.com>

Email search by domain

<http://emailbydomain.com>

Auto manuals search

<http://auto.somanuals.com>

TV manuals search

<http://tv.somanuals.com>