

COBY

90 DAY LIMITED WARRANTY

COBY ELECTRONICS CORP. ("COBY") warrants this product to the original purchaser to be free from defects in material or workmanship under normal use for 90 DAYS from the date of original purchase. COBY agrees at our option under this warranty, to repair or replace it with a new or reconditioned product at no additional charge. Our warranty, of course, does not cover any product which has been subject to neglect, unreasonable use, accident, violation of operating instructions, or any product that has been repaired or modified by an unauthorized service agent.

To obtain factory service, return this unit freight-prepaid to the address shown below within the duration of this warranty.

Enclose \$6.00 for each item in the form of money order made payable to COBY ELECTRONICS CORP. to cover the cost of postage and handling. Also, include a copy of the sales receipt to show the proof of purchase and a detailed description of the problem. The unit(s) must be packaged in such a way as to reasonably protect it from possible shipping damage.

For further information write to:

COBY ELECTRONICS CORP.
Customer Service Dept.
56 -65 Rust Street
Maspeth, N.Y. 11378

COBY's liability under any legal theory for any loss or damage in any way related to this product shall in no event exceed the sale price of this product. In no event shall COBY be liable for any incidental or consequential damages resulting from the use of, or inability to use this product. Repair or replacement as provided under this warranty is the exclusive remedy of the consumer.

Except to the extent prohibited by law, no express or implied warranty of merchantability or fitness for a particular purpose on this product shall not extend beyond the period of this warranty. Some states prohibit the exclusion or limitation of incidental or consequential damages, so that the above limitations or exclusion may not apply to you. This warranty gives you specific rights, and you may also have other rights which may vary from state to state.

COBY
MP-R650

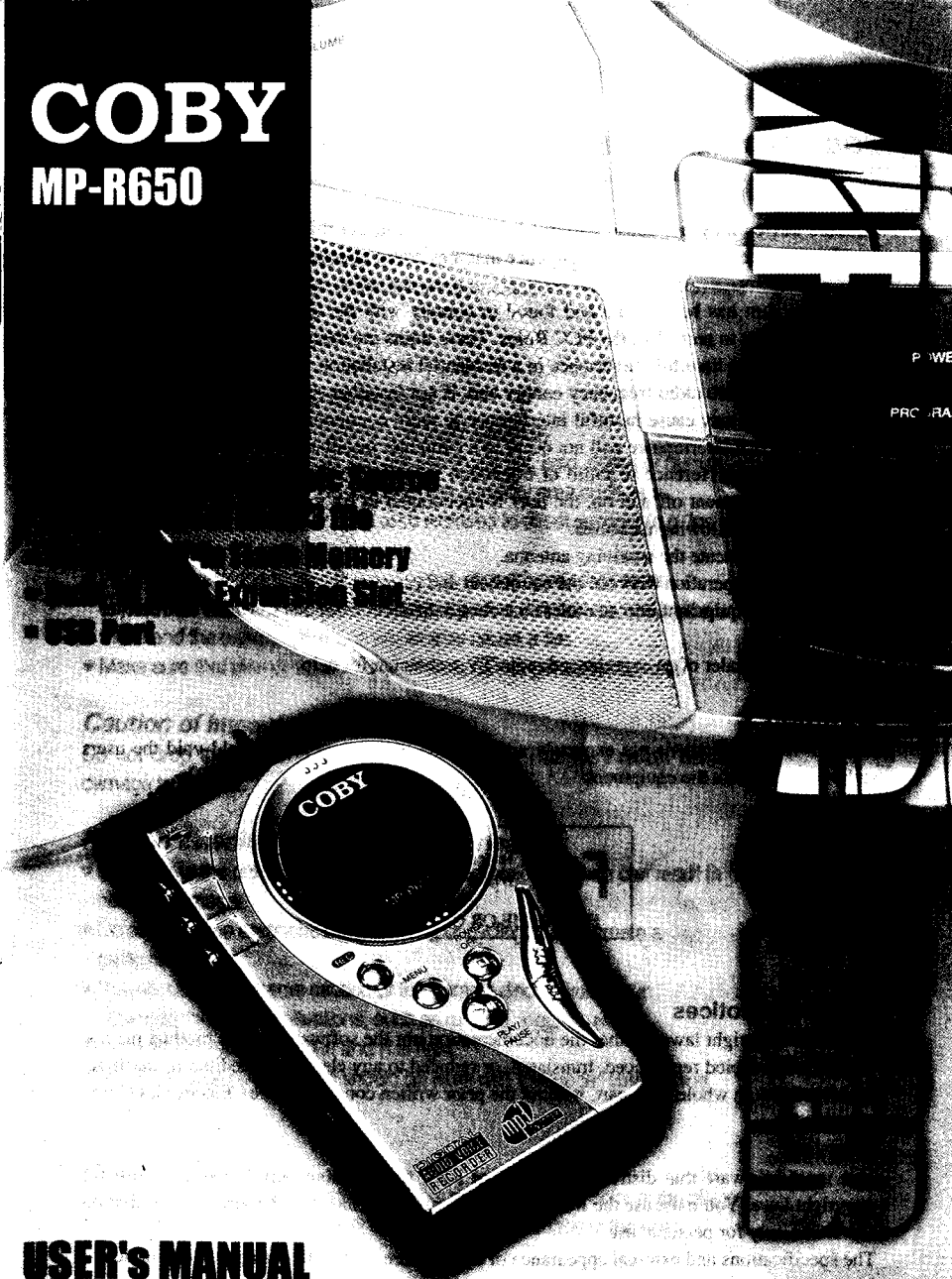

USER'S MANUAL

FCC INFORMATION TO THE USER

This device complies with Part 15 of the FCC Rules. Operation is subject to the following two conditions :

(1) This device may not cause harmful interference, and (2) this device must accept any interference received, including interference that may cause undesired operations.

This equipment has been tested and found to comply with the limits for a Class B digital device, pursuant to part 15 of the FCC Rules. These limits are designed to provide reasonable protection against harmful interference in a residential installation. This equipment generates, uses and can radiate radio frequency energy and, if not installed and used in accordance with the instructions, may cause harmful interference to radio communications. However, there is no guarantee that interference will not occur in a particular installation. If this equipment does cause harmful interference to radio or television reception, which can be determined by turning the equipment off and on, the user is encouraged to try to correct the interference by one more of the following measures:

- Reorient or relocate the receiving antenna.
- Increase the separation between the equipment and receiver.
- Connect the equipment into an outlet on a circuit different from that to which the receiver is connected.
- Consult the dealer of an experienced radio/TV technician for help.

WARNING

Changes or modifications not expressly approved by the manufacturer could void the user's authority to operate the equipment.

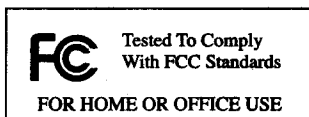

Copyright Notices

Under the copyright laws, neither the documentation nor the software for this product may be copied, photocopied reproduced, translated, or reduced to any electronic medium or machine-readable form, in whole or in part, without the prior written consent of Coby Electronics Corp.

Warning

You must be aware that distributing copies of MP3 files without permission is against the copyright laws. You must use the MP3 Manager program included in the supplied installation CD-ROM only for personal use.

The specifications and external appearance of this unit are subject to change without notice.



The following are precautions that you should always keep in mind. Any violation of one or more of the following precautions may cause damage and will void the warranty.

To maintain good performance

- Avoid exposure to heat, moisture and static electricity.
- Do not use the unit in places that are extremely hot, cold, dusty, or humid.
- In particular, do not keep the unit in a high humidity area such as a bathroom, near a heater or in an area exposed to direct sunlight (e.g. Inside a parked car).
- When you carry the battery in your pocket, do not have other metal objects such as coins or keys in the same pocket. Friction caused by the metal and the battery rubbing together may cause a fire.
- Make sure that pins or other foreign objects do not get inside the unit.

Caution of Impact

Do not drop the unit or allow any sharp impact. This may cause serious damage to the unit.

Note on listening with the headphones

- Listening to the unit at full power for extended periods of time can result in hearing damage.
- Do not wear the earphones while driving or cycling. It may create a traffic hazard.
- You should use extreme caution or temporarily discontinue use in potentially hazardous situations, such as running, jogging, etc.
- Wear them properly; L is left and R is right.
- The in-ear type headphones should be worn with the longer cord behind the neck.

To clean the unit

Do not use chemicals to clean the unit. This may change the color of the player or damage the surface. Use a soft towel to clean the surface of the unit.

MP3 MANAGER

PRECAUTIONS	3
TABLE OF CONTENTS	4
INTRODUCTION	6
PREPARATIONS	8
Inserting batteries	8
Battery Indicator	8
Turning on and off the power	9
Volume control	9
Multimedia Card installation	10
Formatting a Multimedia Card	10
Connecting Encoder to your PC	11
Connecting an external audio set	11
TO INSTALL USB DRIVER	12
Confirm installation of USB Driver	15
COBY MANAGER PROGRAM INSTALLATION	16
COBY Manager program structure	16
Installing COBY Manager program	17
COBY MANAGER PROGRAM OPERATION	20
Program Structure	20
Using the Menu	21
File Menu	21
Edit Menu	21
View Menu	21
Tool Menu	22
Help Menu	23

About the MP3 Player	24
Play files	25
Play Mode	26
View File Info	26
About the Memory Control	27
Downloading / Uploading file	27
Sending files from PC to Encoder	27
Sending files from Encoder to PC	27
IDENTIFICATION OF CONTROLS	28
COBY MP3 Encoder / Remote Controller	28
Display window	29
Playback	30
Section repeat playback	30
Play mode	31
Equalizer preset mode	31
RECORDING / ENCODING	32
Recording your voice	32
Encoding your music	32
Deleting files	34
Reformatting Internal Memory or MMC	34
SPECIFICATION	35
TROUBLESHOOTING	36

1. Main Features

COBY MP-R650

- Record music MP3 format / Playback music MP3 and WMA format
- Record 4 hours of voice or 30 minutes of Music with built-in 32MB flash Internal Memory
- Encode music input from an external audio set into MP3 files, then save the files on the Multimedia Card or Internal Memory
- Memory expansion slot - MMC(16M/32M/64M)
- Remote Controller with earphones

COBY MP-R650 Manager Program

- Transfer music (MP3/WMA) files and data (*.*) files from your PC to the Encoder
- Transfer recorded music files (MP3) and voice files (MP3) from the Encoder to your PC
- Format the Multimedia Card or Internal Memory
- Playback music/voice files

2. Accessories

The following accessories are supplied with COBY MP3 Encoder.
Check whether you have all the accessories illustrated.

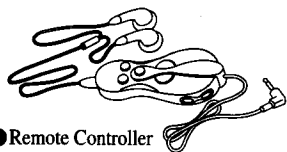

❶ Remote Controller with Earphones

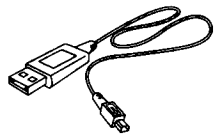

❷ USB Cable

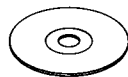

❸ Installation CD-ROM

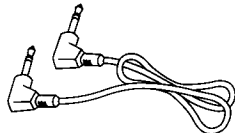

❹ Line in Cable

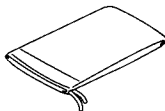

❺ Carrying Pouch



❻ User's Manual

3. System requirements

COBY Manager Program requires the following system:

- IBM-Compatible Pentium Processor PC with minimum of 32MB RAM
- At least 20MB hard disk space
- Microsoft Windows 98/ME/2000
- Color monitor supporting at least 256 different colors
- Video card supporting at least 640x480 resolution on 256 colors

1. Inserting batteries

1. Open the cover of the battery compartment.

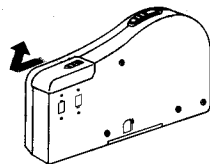

2. Insert 2 AAA size batteries with the positive and the negative terminals correctly aligned, then close the cover.

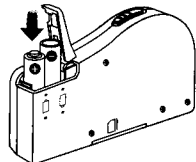

2. Battery Indicator

The battery indicator shows the power remaining.



When  flashes on the indicator, replace them with new ones.

Notes

- Make sure the batteries are inserted in the correct direction.
- Do not attempt to recharge, to disassemble or to apply heat to the battery. It may cause electrolyte leakage or an explosion.
- When the unit is not in use for a prolonged period, remove the battery from the unit to save battery power.
- If liquid leaks from the battery, wipe it thoroughly.

3. Turning on and off the power

1. Press the ►|| (PLAY) button to turn on the power
2. Press the ■ (STOP) button to turn off the power.

4. Volume control

Volume is controlled by the VOL+/VOL- buttons on the main unit or on the Remote Controller.

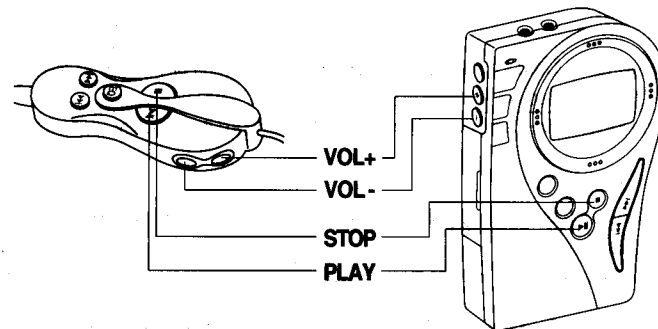

Notes

Volume are increased or decreased by one level each time volume key is pressed. Volume icon will increase or decrease when system's volume is increased or decreased by 4 level.

5. Multimedia Card Installation

Before inserting or removing a Multimedia Card, be sure to turn off unit and disconnect it from the USB cable.

Insert the Multimedia Card into the slot in the correct direction.

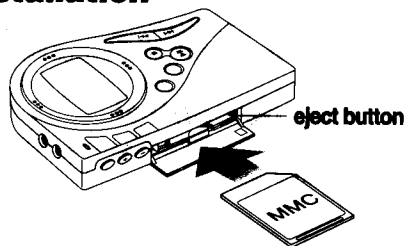

If using the Multimedia Card for the first time, format it with the unit or with the COBY Manager program installed on your PC.

To remove the Multimedia Card, press the eject button and pull it out gently.

Notes

- Insert the Multimedia Card completely into the slot. If not, COBY Manager will be unable to recognize the files on the card.
- Do not insert any foreign objects into the memory card slot.

6. Formatting Internal Memory or Multimedia Card

Before using a Multimedia Card for the first time it must be formatted.

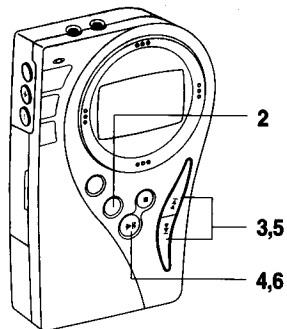

1. Insert the Multimedia Card into an empty slot.
2. Press the 'MENU' button repeatedly until 'FORMAT MEM' is displayed.
3. Select INT.MEM or MMC using the ►► or ◀◀ button
4. Press the ►► button to start format.
5. The confirmation message will be displayed.
FORMAT MEM. Confirm No :
Press the ►► or ◀◀ button to alter the setting.
6. **FORMAT MEM. Confirm Yes :** Press the ►► button to confirm formatting. Formatting will begin.

7. Connecting Encoder to your PC

Connect your PC and Encoder with the supplied USB cable.

- Do not disconnect the USB Cable while transferring data between the PC and Encoder.
- While connected to PC by USB Cable, if COBY Manager program is not in use, Encoder uses power from USB to save battery power.

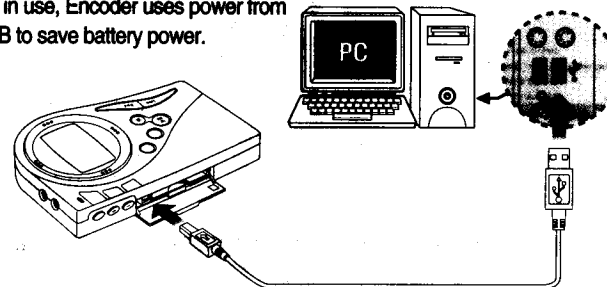

8. Connecting an external audio set

Connect the LINE OUT of the external audio set to LINE IN of the Encoder using provided line in cable.

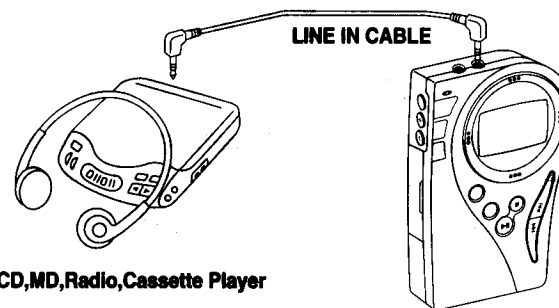

CD,MD, Radio, Cassette Player

You can record music from an external audio set and listen to it simultaneously through the headphones.

1. From Start, choose 'Control Panel' and run 'Add New Hardware'.
Click 'Next' button from below screen.

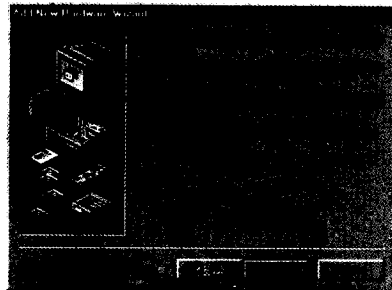

2. Click 'Next' button from below screen.

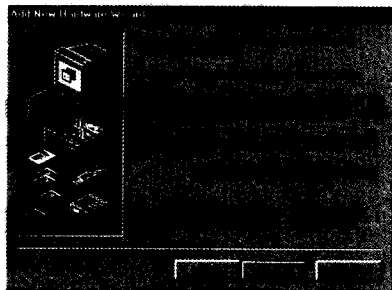

3. Choose second option to select new hardware manually.

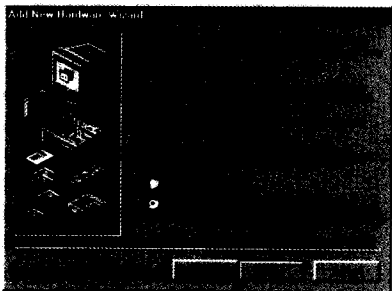

4. Choose 'Universal Serial Bus controller' from list of 'Hardware types'.
Click 'Next' button from below screen.

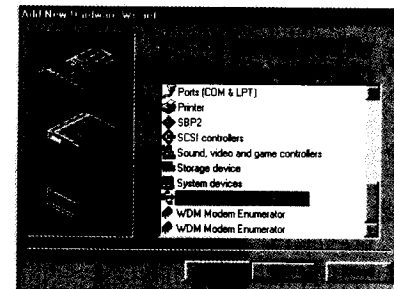

5. Select 'Have Disk' from below screen then find drive and directory by 'Browse' button below the screen.

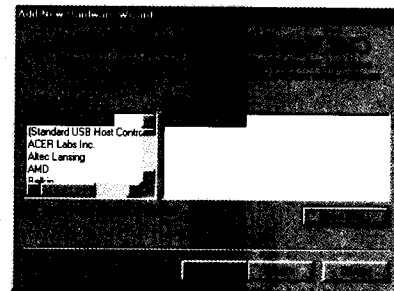

6. Select the drive and the directory which contains installation files.
eg. below screen indicates CD ROM is in D:\usb.

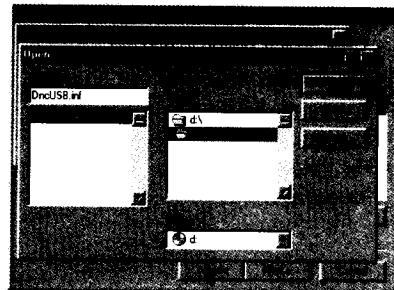

7. Installing USB Driver's model name will be appeared.

Click 'Next' button from below screen.

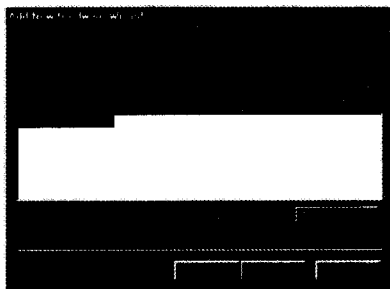

8. Installation of USB Driver file will initiate.

Click 'Next' button from below screen.

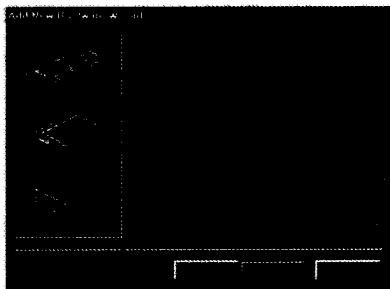

9. Installation of USB Driver is complete.

Click 'Finish' button to end the installation.

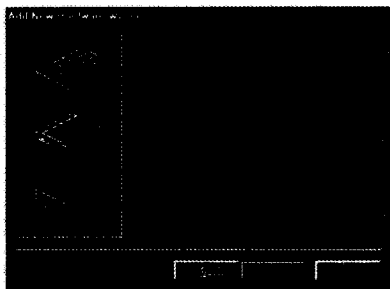

Confirm installation of USB Driver

1. Connect Encoder to PC using USB cable.

2. Choose 'System' from 'Control Panel'.

USB Driver installation has been successful if DnCTech USB Driver is registered under Universal Serial Bus controller as shown on below.

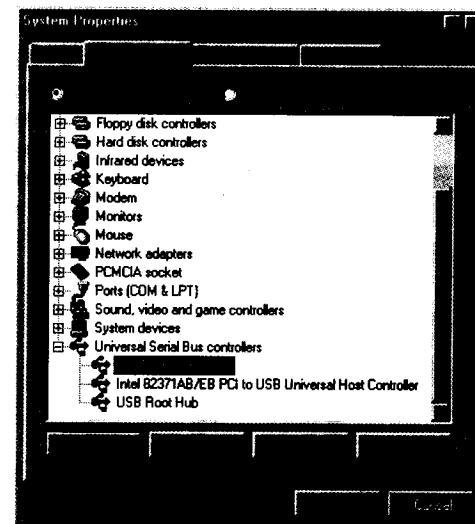

COBY Manager software controls the transfer of music, voice and data files between your PC and Multimedia Card or Internal Memory of Encoder.

1. COBY Manager Program Structure

1. Manager is a program that lets you download MP3 and WMA files to your Encoder. It can also upload MP3 and WMA files to your PC.
2. With Manager program, you can download and upload data files (*.*). This feature makes your Encoder work like a portable storage device.
3. Encoder can playback MP3 and WMA files downloaded from PC. It can also record files from CD or voice sound into MP3 files, and store it in Encoder in real time.
4. Manager UI

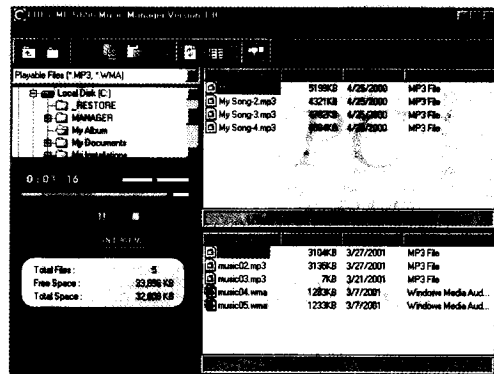

1) Major features of Manager

- Downloading/Uploading MP3 and WMA file
- Playback MP3 and WMA file
- File, Folder Editing (Copy, Paste, Cut, Delete)
- Internal Memory and Multimedia Card Formatting

2) Windows System Requirements

To run Manager on Windows, following hardware and software are required :

- IBM-Compatible Pentium Processor PC with minimum of 32MB RAM
- 20MB hard disk space
- Microsoft Windows 98/ME/2000 system
- Color monitor supporting at least 256 different colors
- Video card supporting at least 640x480 resolution on 256 color

2. Installing COBY Manager program

The following is COBY Manager Program installation procedure:

1. Run Windows, if it is not already running.
2. Insert Manager installation CD in your CD-ROM drive.
3. From Windows explorer, select your CD-ROM drive, and run setup.exe.
4. Preparing for program installation

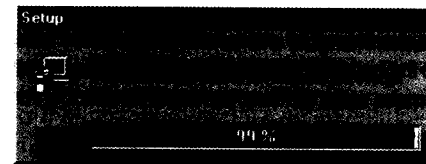

5. Click 'Next'

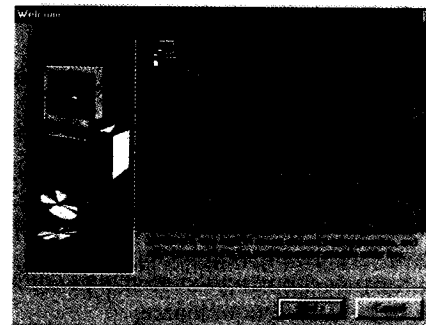

6. Input user/company information into User Information windows.

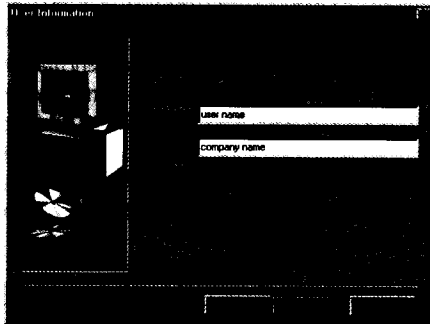

7. The default installation directory will be displayed as (C:\Program Files\COBY\MP-R650 Manager). To change the installation directory, click the 'Browse' button. Then from the popup menu, select the drive, and select the directory from the directory list.

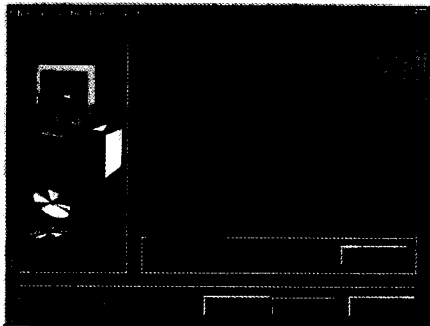

8. Click the 'Next' button, and the program will be installed to your system. The program icon will be created automatically.

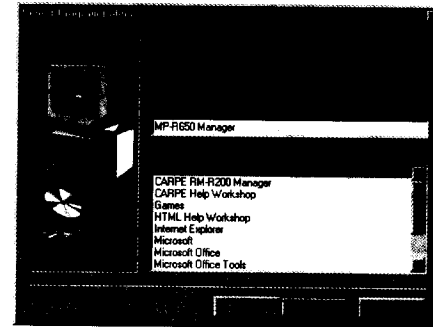

9. The below screen will be displayed when the program installation is completed. Clicking the 'finish' button, will end the installation.

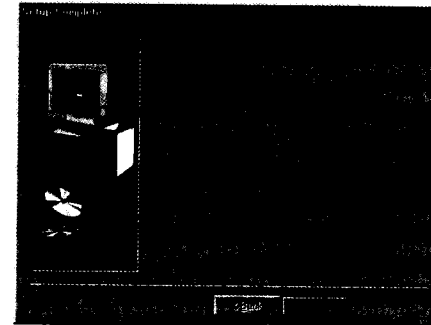

1. Program Structure

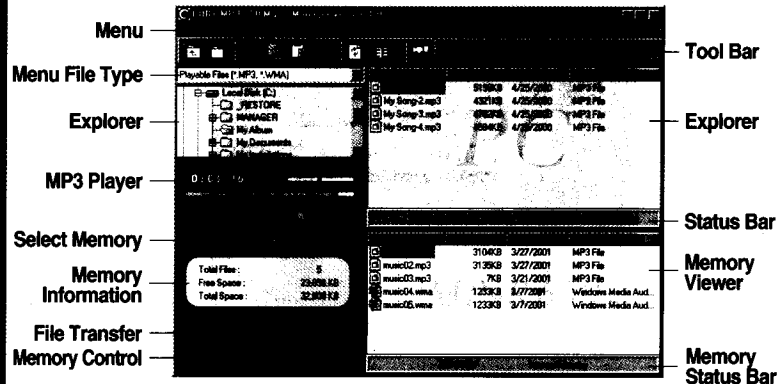

- **Menu** : To select the various menus available.
- **Tool Bar** : To select function like creating new folder, moving of folder & etc.
- **File Type** : To select the file types shown in the explorer. Select *.MP3 for viewing the MP3 files, *.WMA to view the WMA files and *.* to view all types of files.
- **Explorer** : To display data information stored in PC. Similar to Windows Explorer moving, copying of file / folder & etc can be performed.
- **MP3 player** : To playback the MP3 files, the uploaded Voice files and Music files (.MP3 file) recorded by Encoder.
- **Status Bar** : To display needs memory of selected file and the number of selected files.
- **Select Memory** : To select the Memory in Encoder.
- **Memory Information** : To display the total memory space, the usable memory space and number of files in the selected Memory.
- **File Transfer** : To send files from PC to Encoder and vice versa.
- **Memory Control** : To select function like refreshing of Memory, Memory format, delete selected files in Memory.
- **Memory Viewer** : To display the data information stored in the selected Memory.
- **Memory Status Bar** : To display the selected Memory.

2. Using the menu

1) File Menu  To create new folder, move or rename file & etc.

- **New Folder** : To create new folder.
- **Up One Level** : To move the folder one level up.
- **Refresh** : To display the updated PC data information.
- **Rename** : To edit the name of the selected file or folder.
- **Exit** : To close the COBY Manager Program.

2) Edit Menu  To copy, cut, paste file & etc.

- **Cut** : To delete the selected file or folder and to copy it to clipboard.
- **Copy** : To copy the selected file or folder to the clipboard.
- **Paste** : To paste the file or folder from clipboard to the selected location.
- **Delete** : To delete the selected file or folder.
- **Select All** : To select all the files and folders in the window.

3) View Menu  To set the display mode of file icons to be viewed.

- **Large Icon** : To display the files or folders in the selected folder as large icons.
- **Small Icon** : To display the files or folders in the selected folder as small icons.
- **List** : To list all the files in the selected folder.
- **Detail** : To display the detailed information of the files in the selected folder.

4) Tool Menu

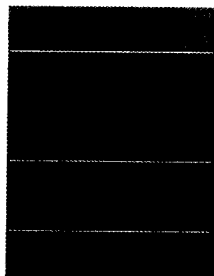

To format Memory, send files & etc.

- **Send to PC** : To send the selected files from Encoder to PC.
- **Send to MP-R650** : To send the selected files from PC to Encoder.
- **Internal Memory** : To select Internal Memory.
- **MMC** : To select MMC in slot.
- **MEM Refresh** : To display the latest data information in the selected Memory.
- **MEM Format** : To format the selected Memory (Internal Memory / MMC)
- **MEM Delete** : To delete the selected file in Memory (Internal Memory / MMC)
- **Player Tools**
 - **Play files** : To select the desired files to be playback. Multiple files can be selected simultaneously by using the Shift or Ctrl Keys.
 - **View file info** : displays, edit and delete the file information(ID3 tag) of the current file.
- **Playback**
 - **Previous** : To playback the previous file.
 - **Play** : To playback the current file that was stopped previously.
 - **Pause** : To momentarily stop the playback of the current file.
 - **Stop** : To stop the playback of the current file.
 - **Next** : To playback the next file.
- **Play Mode**
 - **Repeat** : To playback the current file repeatedly.
 - **Random** : To playback the files is random order.
- **Environment** : To select the default folder as the initial directory to be opened when Manager program is executed.
- **Codec Upgrade** : To upgrade the COBY Codec program.

5) Help Menu



To view the contents and version of the help program.

- **Content** : To view help file of the MP-R650 Music Manager.
- **About MP-R650 Music Manager** : To display the version information of the MP-R650 Music Manager.

3. About the Toolbar

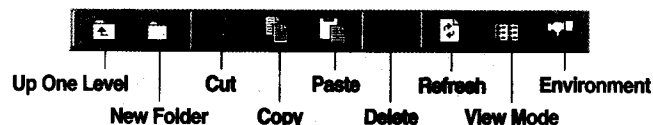

- **Up One Level** : To move the folder one level up.
- **New Folder** : To create new folder.
- **Cut** : To delete and copy the select files or folders to clipboard.
- **Copy** : To copy the selected files or folders to clipboard.
- **Paste** : To paste the files or folders from the clipboard to the selected location.
- **Delete** : To delete the selected files or folder.
- **Refresh** : To display the latest data information PC.
- **View** : To change the display mode to the files or folders in the selected folder.
- **Environment** : To select the default folder as the initial directory to be opened when Manager program is executed.

4. About the MP3 Player

1. From the Manager Explorer, select the folder that contains the Music or Voice files to be played.
2. Select the files to be played.
3. Start playback by double-click the selected files or by drag & drop the selected files into MP3 player.

Notes

When you click the play button, the playing song is not you selected from explorer, but that of previously you played.

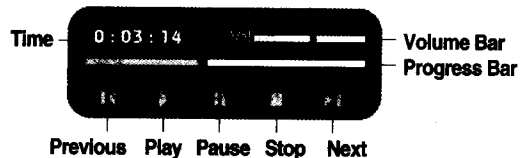

- **Volume Bar** : To adjust the volume level by dragging the bar.
- **Progress Bar** : To display the progress status of the file being played.
The playback position can be selected by dragging the bar.
- **Previous** : To playback the previous file.
- **Play** : To start playback the current file that was stopped previously.
- **Pause** : To momentarily stop the playback of the file.
- **Stop** : To stop the playback of the current file.
- **Next** : To playback the next file.

1) Play Files

To start playback of the selected files. Use Shift or Ctrl Key to enable multiple files to be selected simultaneously.

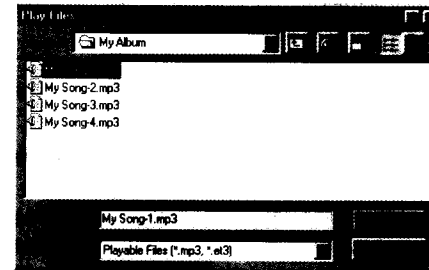

1. Move to the folder that contains the files to be played.
2. Select the files and start playback by clicking the Open button. Use Shift or Ctrl key to enable multiple files to be selected simultaneously.
3. Start playback of the selected files by clicking the Open button.

2) Play Mode

To select repeat or random playback.

- **Repeat** : To playback the files repeatedly.
- **Random** : To playback the files random order.

3) View File Info

To display, edit or delete the file information(ID3 tag) of the file being played.

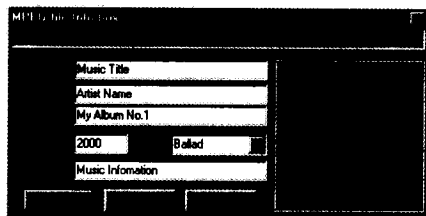

- **Title** : To display the title of the file being played.
- **Artist** : To display the name of the artist.
- **Album** : To display the name of the album.
- **Year** : To display the year when the file is created.
- **Genre** : To display the genre.
- **Comment** : To display the comment.
- **Save** : To save the input or edited file information.
- **Cancel** : To close the dialog without saving the edited file information.
- **Remove ID3** : To delete the file information.

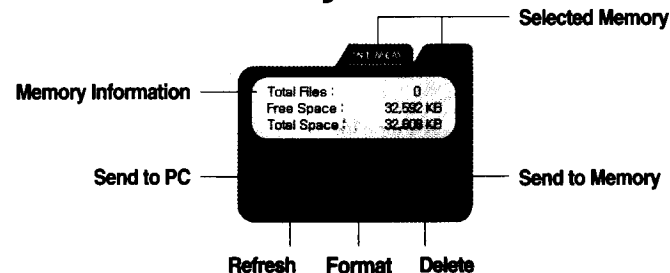

5. About the Memory Control



- **Selected Memory** : To select between MMC or Internal Memory.
- **Memory Information** : To display the total memory space, the usable memory space and number of files in the selected Memory.
- **Send to PC** : To send files from Encoder to PC.
- **Send to Memory** : To send files from PC to Encoder.
- **Refresh** : To update data information of the selected Memory.
- **Format** : To format the selected memory, Please take note that all stored data will be erased after formatting.
- **Delete** : To delete the selected file or files.

6. Downloading / Uploading file

1) Sending files from PC to Encoder

1. Move to the folder that contains the files to be sent.
2. Select the files to be sent. Multiple files can be selected at one time by using the Shift or Ctrl key.
3. Click  or  to start sending the selected files to Encoder.

2) Sending files from Encoder to PC

1. Select the folder that contains the files to be sent to.
2. Select the Memory that contains the files to be sent to.
3. Select the files to be sent to.
4. Click  to start sending the selected files to PC.

1. COBY MP3 ENCODER / REMOTE CONTROLLER

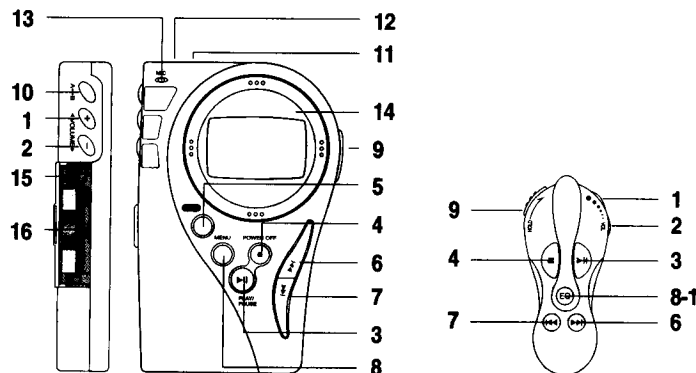

1. **VOL +** : Increase the volume.
2. **VOL -** : Decrease the volume.
3. **PLAY/PAUSE** : Play file, pause playback and turn on the power.
4. **STOP** : Stop playing and turn off the power.
5. **REC** : Start recording music from an external audio set or record voice using built-in microphone. (In recording mode, REC pause / REC continue)
6. **FORWARD** : Skip to next file or search forward.
7. **REWIND** : Skip to previous file or search backward.
8. **MENU** : Press repeatedly to select one of the functions provided in MENU mode. (In recording mode, display recording time or recordable remain time)
- 8-1. **EQ** : Select equalizer mode (Remote Control only).
9. **HOLD** : Prevent unintentional operation by setting to the HOLD position.
10. **A↔B MODE** : Repeat a selected section of the music or voice file being played.
11. **LINE-IN** : Plug in the input cable connected to an external audio set.
12. **EARPHONE** : Connect to the supplied remote controller with earphone.
13. **MICROPHONE** : Record voice messages.
14. **LCD** : Shows the information, status and settings.
15. **USB PORT** : Connector for USB cable.
16. **MMC SOCKET** : Multimedia Card slot.

2. DISPLAY WINDOW

The icons and text information on the display show the current mode and settings.

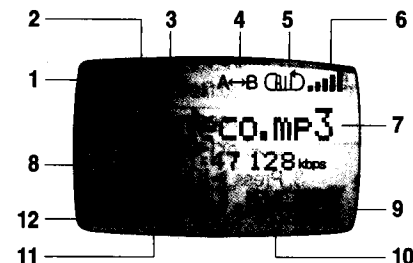

Icon Indicator

1. **Battery indicator** : Shows remaining battery power.
2. **Hold indicator** : Hold switch is set to the lock position.
3. **PLAY/PAUSE** : Playback mode/Pause mode selected.
4. **Section Repeat** : Section repeat mode is selected.
5. **Repeat one/all** : Current repeat mode.
6. **Volume** : VOL+/VOL- buttons sets current volume level.
7. **Main text display/Play information** : Music/Voice file names and the settings that can be changed in the menu mode are displayed on 12-digit main text display.
8. **Sub text display** : Following information is displayed on 12-digit sub text display.
 - Playing/recording time and MP3 transfer rate
 - Track number, options in the Menu.
 - Uploading or downloading.
9. **Record option** : Select Music/Voice for recording.
10. **Equalizer mode** : CLASSIC/JAZZ/ROCK mode.
11. **Random play mode** : Random play mode selected.
12. **Memory information** : Indicates memory in use, either Internal Memory or Multimedia Card.

3. PLAYBACK

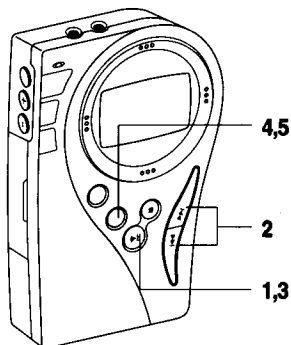

1. Press ►|| button to turn on the power.
The display will turn on.
2. Press ►►► or ◀◀◀ button to select desired file to play. The display will show the file name and number each time you press the ►►► or ◀◀◀ button.
3. Press ►|| button to play the selected file.
4. Press 'MENU' button to select 'Repeat' play mode.
5. Press 'MENU' button to select desired Equalizer setting.

4. Section repeat playback

1. Select a file and start playback.
2. When you reach the start of the passage to be repeated, press the A↔B button.
The A↔B indicator will flash on the display.
3. When you reach the end-point of the passage, press the A↔B button again.
Section repeat playback will start automatically. A↔B indicator stops flashing and lights up on the display.
4. To resume normal play, press the A↔B button.

Notes

Section repeat cannot be used on 2 different file, as it will be disabled when playback reaches the end of the file.

5. PLAY MODE

Normal play in sequential order of Internal Memory and MMC.
Repeat play of the current file.
Repeat all the files on Internal Memory and MMC in sequential order endlessly.
Random play until all the files on Internal Memory and MMC have been played.
Repeat the random play of all files endlessly.

6. EQUALIZER PRESET MODE

Normal Sound
Equalizer set as optimal for Classical music
Equalizer set as optimal for Jazz music
Equalizer set as optimal for Rock music

- Above EQ PRESET MODE and REPEAT MODE can be altered during playback using 'MENU' button

1. Recording your voice

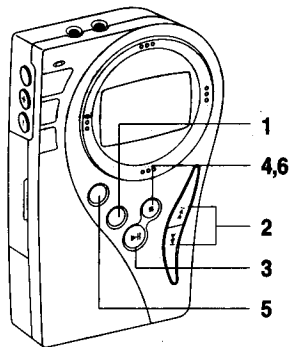

1. Press the 'MENU' button repeatedly until 'RECORD MODE' is displayed.
2. Press the ►► or ◄◄ button and select 'Voice-INT' or 'Voice-MMC' mode.
3. Press the ►|| button then * mark will appear beside the menu. Confirm 'VOICE' appear on the bottom right hand side corner of LCD.
4. Press the ■ button to escape from the MENU.
5. Press the REC button to start voice recording.
The file name and number will be generated automatically by Encoder.
e.g. RECV1001.mp3(Internal Memory),
RECV2001.mp3(MMC)
6. Press the ■ button to stop recording or press REC to pause.

2. Encoding your music

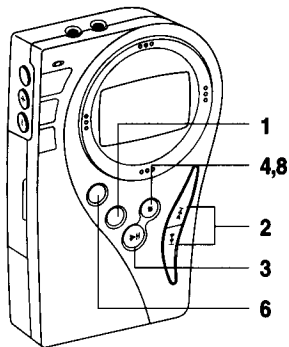

1. Press the 'MENU' button repeatedly until 'RECORD MODE' is displayed.
2. Press the ►► or ◄◄ button and select 'Music-INT' or 'Music-MMC' mode.
3. Press the ►|| button then * mark will appear beside the menu. Confirm 'MUSIC' appear on the bottom right hand side corner of LCD.
4. Press the ■ button to escape from the MENU.
5. Connect an external audio input to line in of Encoder.
6. Press the REC button to start music recording.
7. Start playing an external audio.
The file name and number will be generated automatically by Encoder.
e.g. RECM1001.mp3(Internal memory),
RECM2001.mp3(MMC)
8. Press the ■ button to stop recording or press REC to pause.

Notes

- Transferring files from Internal Memory and Multimedia Card are possible in both direction.
- Confirm target memory for recording before start recording.
RECORD SELECT MODE
Music-INT → Voice-INT → Music-MMC → Voice-MMC
- Encoder will use 3 different record gain control mode to achieve optimum recording.
INPUT GAIN SELECT MODE
Record NORM → Record LOW → Record HIGH

3. Deleting files

1. Press the MENU button repeatedly until 'DEL xxx/xxx' appears on the display.
2. Use the ►► or ◀◀ buttons to select the file to delete.
3. Press the ►|| button to delete the file.
4. The confirmation message will be displayed.

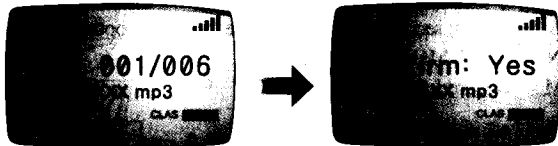

5. Press the ►|| button to confirm, the ■ button to cancel.

Notes

Once you have deleted a file, you cannot recover it. Make sure you choose correct file to delete.

4. Reformatting Internal Memory or MMC

The Memory needs to be reformatted when you need to delete all the files on the Memory or when the files on the Memory are corrupted.

1. Insert the Multimedia Card into an empty slot.
2. Press the MENU button repeatedly until 'FORMAT MEM' appears on the display.
3. Use ►► or ◀◀ button to select the memory to format.
4. Press the ►|| button to format the memory.
5. The confirmation message will be displayed.

FORMAT MEM. Confirm No : Press the ►► or ◀◀ button to alter the setting.

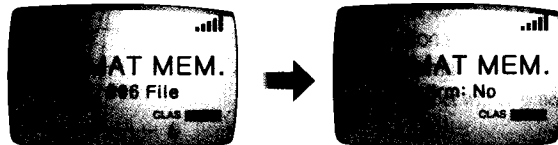

6. **FORMAT MEM. Confirm Yes :** Press the ►|| button to confirm formatting. Formatting will begin.

1. Mechanical

1. **Size :** 65x99.5x19mm (W x D x H)
2. **Weight :** 72g (With Battery : 95g)

2. Electrical

1. **LCD :** 22 X 34(1 Icon Line X 2 Text Line)
2. **Internal Mic. :** Condenser Mic.
3. **Battery :** AAA X 2(DC 3.0 V)
4. **External Port & Characteristic :**
 - **Line-in Jack**
Low Level : 200 ~ 400 mVrms
Medium Level : 400 ~ 600 mVrms
High Level : 600 ~ 800 mVrms
 - **Headphone & Remote control Jack**
Headphone Output Power : 5mW+5mW(320hm)
Remote control : 7 Function Key+Hold
 - **USB Port**
 - **Battery Bay**
5. **SNR :** over 85dB
6. **Frequency Characteristic :** 20 Hz ~ 16KHz
7. **Power :**
 - **Battery Bay :** AAA × 2EA
 - Use the USB power during connected to PC.

You can obtain technical assistance if some problems you encounter when using the Encoder cannot be identified and solved by the User's Manual. Contact us at customerservice@cobyusa.com website.

Before you ask for the technical assistance, please check and follow the Troubleshooting as below.

1. NO POWER ON

1. Check to see if the battery is placed properly.
2. Check to see if the battery is all used up.
3. Check to see if the battery is placed upside down.

2. UNABLE TO DOWNLOAD / UPLOAD DATA

1. Check the USB cable is properly connected to your PC and the Encoder.
2. Restart the COBY Manager program.
3. Power the Encoder off and then power it on again.
4. Check if the battery is low.
5. Press the Refresh button on the bottom left hand side corner of Manager.

3. NO SOUND OR INTERMITTENT PLAY

- Format the memory (Internal Memory or MMC) and download the music files all over again.

4. UNABLE TO MUSIC / VOICE RECORD

- Format the memory (Internal Memory or MMC) and record the Music or Voice again.

5. MMC IS NOT RECOGNIZED

- Using the COBY Manager program, format the MMC and copy files again.

6. BUTTONS DON'T WORK

- Check the "HOLD" button is on or the battery is low.

7. MMC DOESN'T WORK

1. Check if you insert the MMC correctly (refer to the picture on the back of the unit)
2. Format the MMC if you have downloading problems.
3. Refresh the COBY Manager program to see the files if they are not shown properly.
4. For the safe use, we recommend that you should format the MMC if it is from other player or PC.

8. THE PLAYER DOESN'T WORK

1. Check the battery state.
2. Power the player off and turn it on again.
3. Check the HOLD key is on.
4. Don't insert or eject the MMC during the music playing. We recommend insert or eject the MMC when the Encoder is turned off.

Free Manuals Download Website

<http://myh66.com>

<http://usermanuals.us>

<http://www.somanuals.com>

<http://www.4manuals.cc>

<http://www.manual-lib.com>

<http://www.404manual.com>

<http://www.luxmanual.com>

<http://aubethermostatmanual.com>

Golf course search by state

<http://golfingnear.com>

Email search by domain

<http://emailbydomain.com>

Auto manuals search

<http://auto.somanuals.com>

TV manuals search

<http://tv.somanuals.com>