



# XDMA460

## INSTALLATION/OWNER'S MANUAL

AM/FM/CD Receiver with Detachable Face



## Preparation

Please read entire manual before installation.

### Before You Start

- Disconnect negative battery terminal. Consult a qualified technician for instructions.
- Avoid installing the unit where it would be subject to high temperatures, such as from direct sunlight, or where it would be subject to dust, dirt or excessive vibration.

### Getting Started

- Remove trim ring from unit.
- Remove 2 transit screws located on top of the unit.
- Insert the supplied keys into the slots as shown, and slide the unit out of the mounting sleeve.
- Install mounting sleeve into opening, bending tabs to secure.
- Connect wiring harness and antenna. Consult a qualified technician if you are unsure.
- Certain vehicles may require an installation kit and/or wiring harness adapter (sold separately).
- Test for correct operation and slide into mounting sleeve to secure.
- Snap trim ring into place.

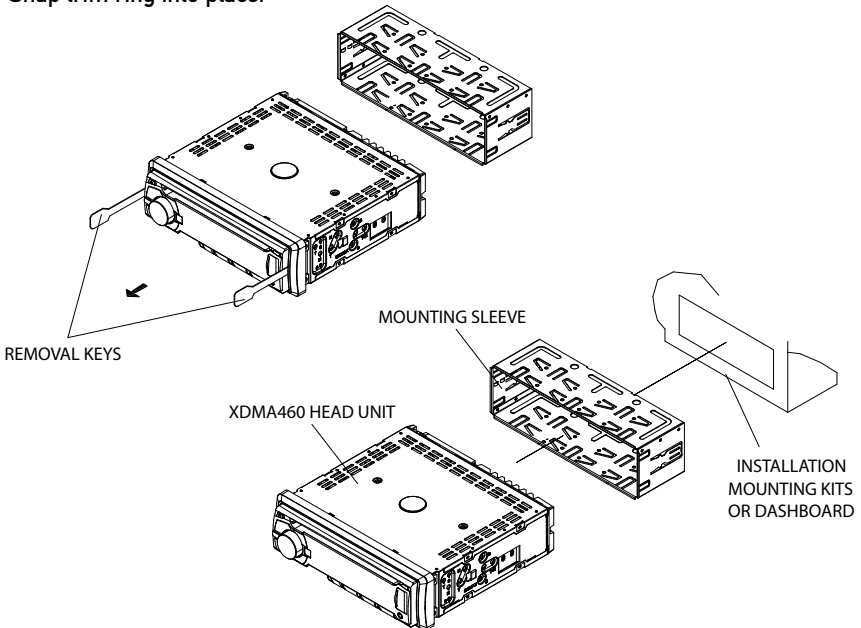

### TYPICAL FRONT-LOAD DIN MOUNTING METHOD

# Wiring Diagram

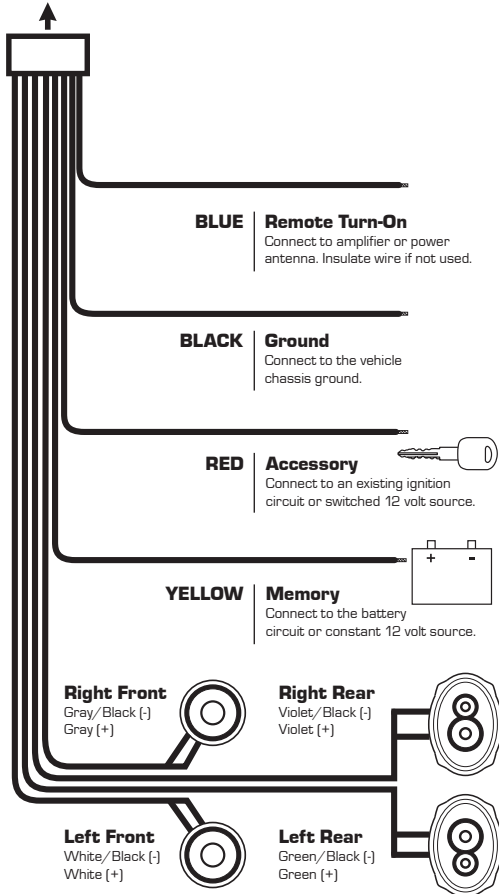
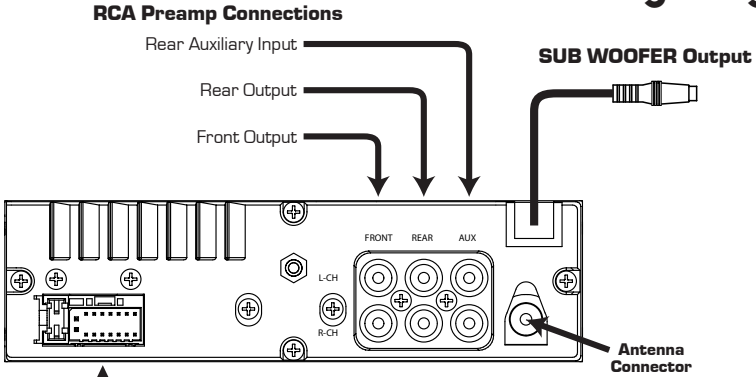

**FUSE**

When replacing the fuse, make sure new fuse is the correct type and amperage. Using an incorrect fuse could damage the radio.

The XDMA460 uses one 10 amp ATM fuse located beside the wiring connector.

## Control Locations - Receiver

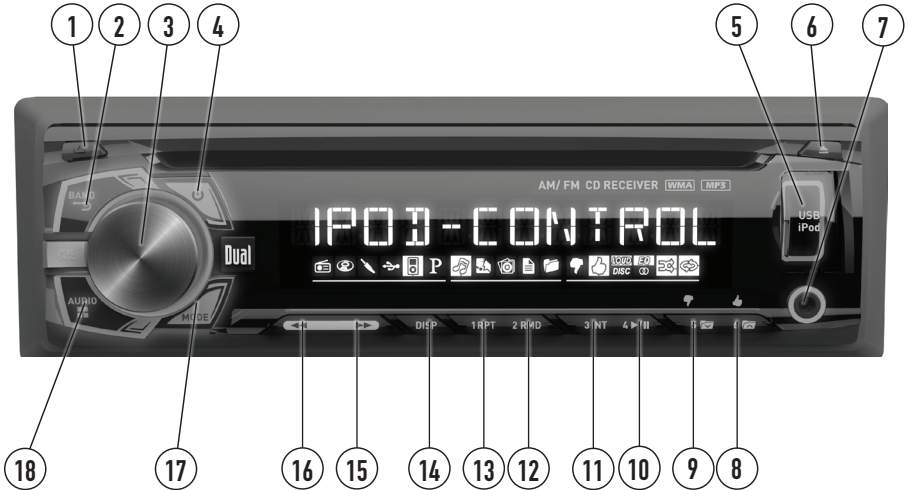

- |  |                           |
|--|---------------------------|
| ① Release                              | ⑩ Preset 4 / Play / Pause |
| ② Band / Go Back                       | ⑪ Preset 3 / Intro        |
| ③ Volume / Select                      | ⑫ Preset 2 / Random       |
| ④ Power                                | ⑬ Preset 1 / Repeat       |
| ⑤ USB Port                             | ⑭ Display                 |
| ⑥ Eject                                | ⑮ Tune / Track Up         |
| ⑦ Auxiliar Input                       | ⑯ Tune / Track Down       |
| ⑧ Preset 6 / Folder Up / Thumbs Up     | ⑰ Mode                    |
| ⑨ Preset 5 / Folder Down / Thumbs Down | ⑱ Audio / Menu            |

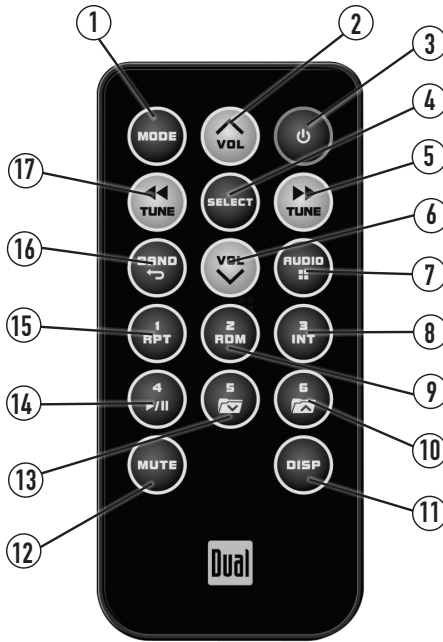

## Control Locations - Remote



- |                     |                           |
|---------------------|---------------------------|
| ① Mode              | ⑩ Preset 6 / Folder Up    |
| ② Volume Up         | ⑪ Display                 |
| ③ Power             | ⑫ Mute                    |
| ④ Select            | ⑬ Preset 5 / Folder Down  |
| ⑤ Tune / Track Up   | ⑭ Preset 4 / Play / Pause |
| ⑥ Volume Down       | ⑮ Preset 1 / Repeat       |
| ⑦ Audio / Menu      | ⑯ Band / Go Back          |
| ⑧ Preset 3 / Intro  | ⑰ Tune / Track Down       |
| ⑨ Preset 2 / Random |                           |



## General Operation

|                         |  |
|-------------------------|--|
| <b>Power On/Off</b>     | Press  or any other button (except <b>EJECT</b> ) to turn the unit on. Press  to turn the unit off.                                    |
| <b>Mode</b>             | Press <b>MODE</b> to select between AM/FM, CD player, auxiliary front/rear, USB, operation of iPod®/iPhone® and Pandora. Modes of operation are shown in the display.<br><br><b>NOTE:</b> CD, USB and operation of iPod modes will not appear unless a CD is inserted or USB/iPod devices are connected. |
| <b>Auxiliary Inputs</b> | The XDMA460 offers two auxiliary input ports, a 3.5 mm port on the front panel and an RCA connection on the back of the unit. Use either connection to connect audio device, MP3 player, etc. Press <b>MODE</b> to select AUX FRONT or AUX REAR  |
| <b>Volume</b>           | Adjust volume using volume knob (00-46).   |
| <b>Display</b>          | Press <b>DISP</b> to select between clock and different types of information, such as radio frequency, CD track/elapsed time or MP3/WMA song information.  |
| <b>Reset</b>            | Press <b>RESET</b> upon initial installation or if abnormal operation occurs. Reset button is located behind the front panel.  |
| <b>Set the Clock</b>    | With the unit on, press and hold <b>DISP</b> until the clock begins to flash, then release. Press <b>TUNE</b> ◀◀ to adjust the hours and <b>TUNE</b> ▶▶ to adjust the minutes. Press <b>DISP</b> momentarily to save the selected time.  |
| <b>12/24-hour Clock</b> | The clock will display 12-hour AM/PM time in USA frequency spacing mode (PM 10:00). In European frequency spacing mode, the clock will display 24-hour time (22:00).   |
| <b>Setup Menu</b>       | Press and hold <b>AUDIO/MENU</b> for more than 3 seconds to access the setup menu. Press <b>AUDIO/MENU</b> momentarily to select between the menu functions and rotate the <b>volume knob</b> left/right to adjust or activate the desired function.   |



# General Operation - Setup Menu

| Menu Function               | Options       | Action  |
|-----------------------------|---------------|---|
| Auto Station Store          | AUTO STORE    | Press <b>SELECT</b> to seek and save 6 strong stations in the current band. (Tuner mode only)                                     |
| Local/Distance Tuning       | LOCAL OFF     | Activates distance tuning (Tuner mode only).  |
|                             | LOCAL ON      | Activates local tuning for strong station reception only (Tuner mode only).   |
| Tuner Frequency Spacing     | FREQ USA      | Programs the unit to USA tuner spacing. (200kHz for FM and 10kHz for AM). (Tuner mode only)                                       |
|                             | FREQ EURO     | Programs the unit to European tuner spacing. (50kHz for FM and 9kHz for AM). (Tuner mode only)                                    |
| Selectable iPod Control     | IPOD FULL     | Programs the head unit to advanced control of the iPod/iPhone device.   |
|                             | IPOD BASIC    | Programs the head unit to manual control of the iPod/iPhone device and allows music to be controlled from the iPod/iPhone device. |
| Loudness                    | LOUD OFF      | Deactivates the Loudness feature, which increases bass and treble levels at low volume.   |
|                             | LOUD ON       | Activates the Loudness feature.   |
| Clock Display               | CLOCK OFF     | Programs unit to not display the clock when the power is off.   |
|                             | CLOCK ON      | Programs unit to display the clock when the power is off.   |
| Front Auxiliary Input       | AUX FRONT ON  | Enables the front panel 3.5mm auxiliary input.  |
|                             | AUX FRONT OFF | Disables the front panel 3.5mm auxiliary input.   |
| Rear Auxiliary Input        | AUX REAR ON   | Enables the rear RCA auxiliary input.   |
|                             | AUX REAR OFF  | Disables the rear RCA auxiliary input.  |
| Sub RCA output              | SUBWFR ON     | Enables the RCA subwoofer.  |
|                             | SUBWFR OFF    | Disables the RCA subwoofer.   |
| Beep Confirmation           | BEEP OFF      | Disables the confirmation beep.   |
|                             | BEEP ON       | Enables the confirmation beep.  |
| Programmable Turn On Volume | PRO-VOL #     | Programs unit to always turn on at a specific volume (default is OFF). Any volume level 1-46 can be selected.                     |
| Power on Message            | MESSAGE OFF   | Disables power on message. (example: GOOD MORNING)  |
|                             | MESSAGE ON    | Enables power on message to be displayed.   |
| Scrolling Option            | SCROLL 15 S   | Programs unit to scroll information once every 15 seconds (default).  |
|                             | SCROLL ONCE   | Programs unit to scroll once, then show the first 10 characters on display.   |
|                             | SCROLL ON     | Programs unit to scroll continuously.   |
|                             | SCROLL OFF    | Programs unit to show the first 10 characters on the display.   |
| Illumination Dimmer         | DIMMER HIGH   | Programs unit to the brightest illumination level.  |
|                             | DIMMER MED    | Programs unit to the middle illumination level.   |
|                             | DIMMER LOW    | Programs unit to the dimmest illumination level.  |
| Demonstration Mode          | DEMO OFF      | Disables the demonstration mode.  |
|                             | DEMO ON       | Enables the demonstration message.  |

## General Operation

**Audio** Press **AUDIO/MENU** momentarily to select between Bass, Treble, Balance, Fader, Subwoofer and Source Volume Level.

→ BASS → TREBLE → BALANCE → FADER → SUBWOOFER\* → SOURCE LEVEL →

**Bass** Press **AUDIO/MENU** until **BASS** appears then rotate volume knob left/right to adjust ( -6 minimum / +6 maximum).

**Treble** Press **AUDIO/MENU** until **TREBLE** appears then rotate volume knob left/right to adjust ( -6 minimum / +6 maximum).

**Balance** Press **AUDIO/MENU** until **BAL** appears then rotate volume knob left/right to adjust (BAL LEFT 12 - BAL RIGHT 12). BAL EVEN represents equal balance

**Fader** Press **AUDIO/MENU** until **FADER** appears then rotate volume knob left/right to adjust (FADER FRONT 12 - FADER REAR 12). FADER EVEN represents equal fader

**EQ** Press **EQ**, then turn the **volume knob** to cycle through the following equalization curves: FLAT (default), POP, JAZZ, CLASSIC, BEAT, ROCK and USER. Any manual adjustment to the Bass or Treble settings are automatically saved as USER.

**Source Volume Level** The source volume level control allows a gain adjustment for each audio source: AM, FM, CD, AUX FRONT/REAR, operation of iPod, Pandora and USB. Set the source volume level for each mode, depending on the relative volume of each audio source.

To set the source volume level, press **AUDIO/MENU** until SRC LEVEL appears. After one second, the current mode will appear on the display. Turn the volume knob to adjust the audio level of the current source (-6 minimum/+6 maximum).

**Note:** Only the current mode will be available for adjustment. To adjust another mode of operation, press **MODE** until the desired mode is selected, then set the source volume level for that mode.



## AM/FM Tuner Operation

|  |   |
|--|---|
| <b>Seek Tuning</b>                           | Press <b>TUNE</b> ◀◀ or <b>TUNE</b> ▶▶ for more than one second to seek to the next strong station.   |
| <b>Manual Tuning</b>                         | Press <b>TUNE</b> ◀◀ or <b>TUNE</b> ▶▶ momentarily to change radio frequency up or down one step at a time. Press and hold to advance quickly.  |
| <b>Band</b>                                  | Press <b>BAND</b> to select between FM1, FM2, FM3, AM1 and AM2 bands.   |
| <b>Storing and Recalling Station Presets</b> | Up to 18 FM stations and 12 AM stations can be stored. To store a station, select the desired band and station. Press and hold the desired preset button (1-6) for more than 2 seconds. When stored, the preset number will appear in the display. The station can be recalled anytime by pressing the corresponding preset button. |







## **CD Player Operation**

|                                 |   |
|---------------------------------|---|
| <b>Insert CD</b>                | With the label facing up, insert a standard size CD into the CD slot. The CD will automatically begin playback.   |
| <b>Eject CD</b>                 | Press <b>EJECT</b> to eject the CD. The unit will change to previous mode of operation. If the disc is not removed within 10 seconds, the unit will reload the disc. The unit does not have to be turned on to eject CD.  |
| <b>Track Select</b>             | Press <b>TRACK ►►</b> to skip to the beginning of the next track. Press <b>TRACK ◄◄</b> to return to the beginning of the current track. Pressing <b>TRACK ◄◄</b> again skips to the beginning of the previous track.   |
| <b>Fast Forward and Reverse</b> | Press and hold <b>TRACK ►►</b> or <b>TRACK ◄◄</b> to fast forward or reverse a track.   |
| <b>Pause</b>                    | Press <b>►/   </b> to temporarily stop CD playback.<br>Press <b>►/   </b> again to resume playback.   |
| <b>Intro</b>                    | Press <b>INT</b> to enter the Intro menu, then turn the volume knob to select one of the following options: <ul style="list-style-type: none"><li>• <b>OFF</b> - Cancels the <b>INT</b> function.</li><li>• <b>ALL</b> - Plays the first 10 seconds of each track.</li></ul>  |
| <b>Repeat</b>                   | Press <b>RPT</b> to enter the Repeat menu, then turn the volume knob to select one of the following options: <ul style="list-style-type: none"><li>• <b>ALL</b> - Plays all tracks on CD.</li><li>• <b>TRACK</b> - Continuously repeats selected track.</li></ul>   |
| <b>Random</b>                   | Press <b>RDM</b> to enter the Random menu, then turn the volume knob to select one of the following options: <ul style="list-style-type: none"><li>• <b>OFF</b> - Cancels the <b>RDM</b> function.</li><li>• <b>ALL</b>- Plays all tracks in random order.</li></ul>  |
| <b>CD-R/CD-RW Compatibility</b> | <p>Some CD-Rs and CD-RWs may be incompatible with this unit, depending on media type and recording method. In addition, the following CDs may be incompatible with this unit:</p> <p>CDs exposed to extreme temperatures or direct sunlight for extended periods of time, CDs recorded in which a recording session failed or a re-recording was attempted and, or encrypted or copy-protected CDs which do not conform to the audio CD-DA red book recording standard.</p> |



# CD Player Operation - MP3/WMA Files

|   |   |
|---|---|
| <p><b>Playing an MP3/WMA Disc</b></p>   | <p>When an MP3/WMA encoded disc is first inserted, "DISC READ" will appear in the display. Depending on the number of files and folders, this may take several seconds.</p>   |
| <p><b>Displaying Information</b></p>  | <p>Press <b>DISP</b> to select between song title, artist, file name, folder name, track number, and clock/elapsed time.</p> <p>"NO ARTIST" or "NO TITLE" will be displayed if the MP3/WMA file contains no ID3 tag information.</p> <p>"ROOT" will be displayed if the directory name of a root folder is not labeled.</p>   |
| <p><b>Title Icon</b> </p>  | <p>This icon will illuminate when the song title is displayed.</p>  |
| <p><b>Artist Icon</b> </p> | <p>This icon will illuminate when the artist name is displayed.</p>   |
| <p><b>Folder Icon</b> </p> | <p>This icon will illuminate when the folder name is displayed.</p>   |
| <p><b>File Icon</b> </p>   | <p>This icon will illuminate when the file name is displayed.</p>   |
| <p><b>Character Support</b></p>   | <p>Maximum character display information</p> <ul style="list-style-type: none"> <li>• Track name – 32 character maximum</li> <li>• Directory name – 32 character maximum</li> <li>• *Song title – 32 character maximum</li> <li>• *Artist name – 32 character maximum</li> </ul> <p>*Song title and Artist Name will only be displayed if included with the MP3/WMA file.</p> <p>When referring to MP3/WMA playback, the following terms are synonymous:</p> <ul style="list-style-type: none"> <li>• File name and track name</li> <li>• Folder name and directory name</li> </ul> |



## **CD Player Operation - MP3/WMA Files**

- Folder/File Search Mode** MP3/WMA CD mode features a file and folder search mode. This search allows navigating through folders to find a specific MP3 or WMA file for playback.
- Step 1** Press **SELECT** to enter the file/folder search mode. A list of all the folders on the CD will be displayed.
- Note:** Any files located in the root directory will be located in the folder named "ROOT". Press **SELECT** to view the files on the root folder.
- Step 2** Turn the **volume knob** to cycle through all the folders on the device and press **SELECT** to choose the desired folder. The list of files in the selected folder will be displayed. Turn the **volume knob** to cycle through the list of files.
- Note:** Pressing **GO BACK** when viewing the contents of a folder will return to the list of folders on the CD. Press **GO BACK** again to exit the search menu.
- Step 3** Once the desired song is displayed, press **SELECT** to begin playback of the desired song.



# CD Player Operation - MP3/WMA Files

|                      |  |
|----------------------|--|
| <b>Folder Access</b> | <p>Press  to select the previous folder.<br/>                 Press  to select the next folder.</p> <p>*Folder access is only available on MP3/WMA discs recorded with more than one folder.</p>   |
| <b>Repeat</b>        | <p>Press <b>RPT</b> to enter the Repeat menu, then turn the <b>volume knob</b> to select one of the following options:</p> <ul style="list-style-type: none"> <li>• ALL - Plays all tracks on CD.</li> <li>• TRACK - Continuously repeats selected track.</li> <li>• FOLDER - Continuously repeats all files in selected folder.</li> </ul>  |
| <b>Random</b>        | <p>Press <b>RDM</b> to enter the Random menu, then turn the <b>volume knob</b> to select one of the following options:</p> <ul style="list-style-type: none"> <li>• OFF - Cancels the <b>RDM</b> function.</li> <li>• ALL - Plays all tracks in random order.</li> <li>• FOLDER - Plays all tracks in folder in random order.</li> </ul> <p><b>Note:</b> Random mode is retained in memory when selecting between other modes and when the unit is turned on/off.</p>          |
| <b>Intro</b>         | <p>Press <b>INT</b> to enter the Intro menu, then turn the <b>volume knob</b> to select one of the following options:</p> <ul style="list-style-type: none"> <li>• OFF - Cancels the <b>INT</b> function.</li> <li>• ALL - Plays first 10 seconds of each track.</li> <li>• FOLDER - Plays first 10 seconds of each track in folder.</li> </ul> <p><b>Note:</b> Folder repeat, random and intro options only function on MP3/WMA discs recorded with more than one folder.</p> |



## **CD Player Operation - MP3/WMA Files**

### **Media Compatibility**

The following types of discs/files are compatible:

- CD-ROM (ISO), CD-R, CD-RW
- CD-DA
- MP3 data
- WMA data

The following types of discs/files are not compatible:

- WMA files that are protected by DRM (Digital Rights Management).
- WMA lossless format
- Discs recorded with Track At Once or packet writing
- MP3 PRO format
- MP3 playlists
- WAV format

### **Playback Order**

MP3/WMA playback sequence is based on recorded order of files and begins in the root folder of the disc. Any empty folders or folders that do not include MP3/WMA files are skipped. This unit may not play files in the order they were recorded in. Refer to your recording software's user's manual for more information.

### **Compatible Recording Formats**

- ISO9660 level 1
- ISO9660 level 2
- Yellow Book MODE 1
- Yellow Book MODE 2 FORM 1
- Multi session
- Maximum files - 999
- Maximum folders - 255
- Maximum folder levels - 8
- MPEG-1/2/2.5 Audio Layer-3

ISO9660 standards:

- Maximum nested folder depth is 8 (including the root folder).
- Valid characters for folder/file names are letters A-Z (all caps), numbers 0-9, and "\_" (underscore). Some characters may not be displayed correctly, depending on the character type.
- This device can play back discs in Joliet, Romeo, and other standards that conform to ISO9660. MP3/WMA written in the formats other than the above may not play and/or their file names or folder names may not be displayed properly.



# CD Player Operation - MP3/WMA Files

**Additional MP3/WMA Information**

An internal buffer provides ESP (Electronic Skip Protection) to virtually eliminate skipping.

When playing a disc recorded with regular audio files (CD-DA or .WAV) and MP3/WMA files, the unit will play the MP3/WMA files only.

Only MP3 files with filename extension (.mp3) can be played. Only WMA files with filename extension (.wma) can be played.

Do not attempt to play discs which contain non-MP3/WMA files with the MP3/WMA extension.

**Sampling Frequency Rates**

**MP3** 8kHz ~ 48kHz

**WMA** 32kHz ~ 48kHz

**Transfer Bit rates**

**MP3** 32kbps ~ 320kbps constant  
Variable bit rates

**WMA** 32kbps ~ 192kbps constant  
Variable bit rates

**Note:** Some files may not play or be displayed correctly, depending on sampling rates and bit rates.

**MP3 Tag Display**

ID3 tags Version 1.0 to 2.4.  
This model will not display ID3 Version 2.4 or greater tags.

**Recommended Settings**

For best results, use the following settings when burning an MP3 disc:  
128kbps or higher constant bit rate  
44.1kHz or higher sampling frequency

For best results, use the following settings when burning a WMA disc:  
64kbps or higher constant bit rate  
32kHz or higher sampling frequency



## USB Operation

|  |  |
|--|--|
| <b>Connecting a USB Device (sold separately)</b> | To play MP3/WMA files from most USB mass storage devices, line up the USB connector and insert the USB device into the XDMA460's USB port.   |
| <b>Playing Music</b>                             | When a USB device is first connected, "USB READ" will appear in the display and playback will begin momentarily. Depending on the number of files and folders, it may take several seconds for the device to begin playing. If no valid MP3/WMA files are detected, "NO FILE" will be displayed and the last mode will be resumed.   |
| <b>Track Select</b>                              | Press <b>TRACK</b> ►► to skip to the beginning of the next track. Press <b>TRACK</b> ◀◀ to return to the beginning of the current track. Pressing <b>TRACK</b> ◀◀ again skips to the beginning of the previous track.  |
| <b>Fast Forward and Reverse</b>                  | Press and hold <b>TRACK</b> ►► or <b>TRACK</b> ◀◀ to fast forward or reverse a track.  |
| <b>Pause</b>                                     | Press ►/   to temporarily stop USB playback.<br>Press ►/   again to resume playback.   |
| <b>File Search</b>                               | Press <b>SELECT</b> to enter the file/folder search mode. A list of all the folders from the USB device will be displayed.   |
| <b>Step 1</b>                                    | <b>Note:</b> Any files located in the root directory will be located in the folder named "ROOT". Press <b>SELECT</b> to view the files on the root folder.   |
| <b>Step 2</b>                                    | Turn the <b>volume knob</b> to cycle through all the folders on the device and press <b>SELECT</b> to choose the desired folder. The list of files in the selected folder will be displayed. Turn the <b>volume knob</b> to cycle through the list of files.<br><br><b>Note:</b> Pressing <b>GO BACK</b> when viewing the contents of a folder will return to the list of folders on the USB device. Press <b>GO BACK</b> again to exit the search menu. |
| <b>Step 3</b>                                    | Once the desired song is displayed, press <b>SELECT</b> to begin playback of the desired song.<br><br><b>Note:</b> Due to differences in USB device transfer speeds, it is recommended to limit each folder to less than 30 songs.   |



# USB Operation

**Displaying Information**

When a file is accessed, the clock and elapsed time will be displayed. Press **DISP** momentarily to select between song title, artist, file name, folder name, track number and clock/elapsed time.

"NO TITLE" will be displayed if no song title information is available.

"NO ARTIST" will be displayed if no artist information is available.

**Song Title Icon** 

This icon will illuminate when the song title is displayed.

**Artist Icon** 

This icon will illuminate when the artist name is displayed.



**Folder Icon** 

This icon will illuminate when the folder name is displayed.

**File Icon** 

This icon will illuminate when the file name is displayed.

**Folder Access**

Press  to select the previous folder.  
Press  to select the next folder.

**Note:** Folder access is only available on devices with more than one folder.

**Repeat**

Press **RPT** to enter the Repeat menu, then turn the **volume knob** to select one of the following options:

- ALL - Plays all tracks on the device.
- TRACK - Continuously repeats selected track.
- FOLDER - Continuously repeats all files in selected folder.

**Random**

Press **RDM** to enter the Random menu, then turn the **volume knob** to select one of the following options:

- OFF - Cancels the **RDM** function.
- ALL - Plays all tracks in random order.
- FOLDER - Plays all tracks in folder in random order.

**Note:** Random mode is retained in memory when selecting between other modes and when the unit is turned on/off.

**Intro**

Press **INT** to enter the Intro menu, then turn the **volume knob** to select one of the following options:

- OFF - Cancels the **INT** function.
- ALL - Plays first 10 seconds of each track.
- FOLDER - Plays first 10 seconds of each track in folder.



## USB Operation

### Character Support

- Maximum character display information
- Track name – 32 character maximum
  - Directory name – 32 character maximum
  - \*Song title – 32 character maximum
  - \*Artist name – 32 character maximum

\*Song title and artist name will only be displayed if included with the MP3/WMA file.

### Media Compatibility

The following types of files are compatible:

- MP3 data
- WMA data

The following types of files are not compatible:

- WMA files that are protected by DRM (Digital Rights Management).
- WMA lossless format
- MP3 PRO format
- MP3 playlists
- WAV format

### Playback Order

MP3/WMA playback sequence is based on order the files are copied to the USB device and begins in the root folder. Any empty folders or folders that do not include MP3/WMA files are skipped. Depending on your software, the playback order may vary.

### Playback Capacity

- Maximum number of files: 50,000
- Maximum number of folders: 255 plus the root directory
- Maximum number of files in each folder and root: 50,000

**Note:** If the number of files/folders exceeds the maximum outlined above, the additional files/folders will be ignored.

**Note:** Devices that exceed the maximum number of files or folders may not function properly.

### USB Device Compatibility

Due to the differences of USB devices, some devices may not be compatible. USB devices must be 'mass storage class' and formatted to the FAT or FAT32 file system in order to ensure compatibility.



## USB Operation

**Additional MP3/WMA Information**

Only MP3 files with filename extension (.mp3) can be played.  
 Only WMA files with filename extension (.wma) can be played.  
 Do not attempt to play non-MP3/WMA files with the MP3/WMA extension.

**Sampling Frequency Rates**

**MP3** 8kHz ~ 48kHz

**WMA** 32kHz ~ 48kHz

**Transfer Bit rates**

**MP3** 32kbps ~ 320kbps constant  
 Variable bit rates

**WMA** 32kbps ~ 192kbps constant  
 Variable bit rates

**Note:** Some files may not play or be displayed correctly, depending on sampling rates and bit rates.

**MP3 Tag Display**

ID3 tags Version 1.0 to 2.4

**Note:** If an invalid ID3 tag version is detected, "NO SUPPORT" will scroll on the display.

## Operation of iPod/iPhone

### Connecting an iPod/iPhone Device

#### USB Connection



Using the "dock connector to USB" sync cable (provided with the iPod/iPhone device), plug the USB cable into the XDMA460's USB port. Once connected, playback will begin automatically.

### Controlling a Device: Full Control

When the control of iPod/iPhone feature is set to "FULL" in the iPod Menu, use the following functions to control the device:

|                                 |  |
|---------------------------------|--|
| <b>Song Select</b>              | Press ►► to skip to the beginning of the next song. Press ◀◀ to return to the beginning of the current song. Pressing ◀◀ again skips to the beginning of the previous song.  |
| <b>Fast Forward and Reverse</b> | Press and hold ►► or ◀◀ to fast forward or reverse a song.   |
| <b>Pause</b>                    | Press ►/   to temporarily stop playback.<br>Press ►/   again to resume playback.   |
| <b>Repeat</b>                   | Press RPT to enter the Repeat menu, then turn the <b>volume knob</b> to select one of the following options: <ul style="list-style-type: none"><li>• ALL - Repeats all tracks.</li><li>• SONG - Repeats selected track.</li></ul>  |
| <b>Random</b>                   | Press RDM to enter the Random menu, then turn the <b>volume knob</b> to select one of the following options: <ul style="list-style-type: none"><li>• OFF - Cancels the RDM function.</li><li>• ALL - Plays all tracks in random order.</li><li>• ALBUM - Plays all tracks in the selected album in random order.</li></ul> |
| <b>Intro</b>                    | Press INT to enter the Intro menu, then turn the <b>volume knob</b> to select one of the following options: <ul style="list-style-type: none"><li>• OFF - Cancels the INT function.</li><li>• ON - Plays first 10 seconds of each track.</li></ul>   |



# Operation of iPod/iPhone

## Music Search Menu: Full Control

The XDMA460 features a powerful music search that simplifies the searching process. Follow the steps below to find the desired song:

- Begin Searching** | Press **SELECT** to begin the search. The main search menu will appear.
- Select a Category** | Turn the **volume knob** to select between **artists, albums, songs, playlists, podcasts and audiobooks**. Press **SELECT** to select the desired search category. Most search categories have subcategories to navigate through. See the table below for details.

| Search Category | Menu Navigation                 |
|-----------------|---------------------------------|
| Artists         | Menu ➔ Artists ➔ Albums ➔ Songs |
| Albums          | Menu ➔ Albums ➔ Songs           |
| Songs           | Menu ➔ Songs                    |
| Playlists       | Menu ➔ Playlists ➔ Songs        |
| Podcasts        | Menu ➔ Podcasts                 |
| Audiobooks      | Menu ➔ Audiobooks               |

- Finding a Song** | Once the search category (and subcategories) are selected, use the **volume knob** to navigate to the desired song/ podcast/audiobook.
- Playing a Song** | Press **SELECT** with the desired song name highlighted to begin playback.
- Step Backwards** | Press **GO BACK** to return to the previous menu, or exit the search menu when the main menu is shown.  
  
**Important Note:** Once a specific category is selected, the iPod/iPhone device playback will be limited to that category until another category is selected in the search menu.



## Operation of iPod/iPhone

### Displayed Information: Full Control

#### Displaying Information

Press **DISP** momentarily to select file/folder name (default), song title/artist, track number/clock & elapsed time.

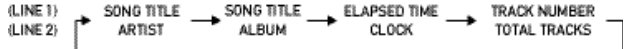

#### Character Support

Maximum character display information

- \*Song Title – 32 character maximum
- \*Artist Name – 32 character maximum
- \*Album Name - 32 character maximum

\*Song Title, Artist Name and Album Name will only be displayed if included with the file.

### Controlling a Device: Basic Control

When the control of iPod/iPhone feature is set to "BASIC" in the iPod Menu, use the following functions to control the device:

#### Manual Control for iPod

When "BASIC" control is selected from the iPod Menu, the iPod or iPhone device can be controlled directly from the device's interface. All functions except for volume can be used from the iPod or iPhone device.

#### Control Functions

In addition to manual control of the iPod/iPhone device, the following basic functions are still active:

#### Song Select

Press **▶▶** to skip to the beginning of the next song. Press **◀◀** to return to the beginning of the current song. Pressing **◀◀** again skips to the beginning of the previous song.

#### Pause

Press **▶/|||** to temporarily stop playback.  
Press **▶/|||** again to resume playback.

#### Volume

When playing an iPod device, the volume is adjustable using the **volume knob**.

---

# Operation of iPod/iPhone

## Device Compatibility

- |                 |   |
|-----------------|---|
| <b>Made for</b> | <ul style="list-style-type: none"><li>• iPod touch (4th generation)</li><li>• iPod nano (6th generation)</li><li>• iPod touch (3rd generation)</li><li>• iPod nano (5th generation)</li><li>• iPod touch (2nd generation)</li><li>• iPod nano (4th generation)</li><li>• iPod classic</li><li>• iPod touch (1st generation)</li><li>• iPod nano (3rd generation)</li><li>• iPod nano (2nd generation)</li><li>• *iPod nano (1st generation)</li><li>• *iPod with video</li><li>• iPhone 4</li><li>• iPhone 3GS</li><li>• iPhone 3G</li><li>• iPhone</li></ul> |
|-----------------|---|

\*These devices are not compatible with 'basic' control mode.

# Pandora Operation

|                          |   |
|--------------------------|---|
| <b>Requirements</b>      | <p>Control for Pandora requires:</p> <ul style="list-style-type: none"> <li>• An iPhone device with a reliable data connection, or an iPod touch that is connected to wireless internet.</li> <li>• The Pandora App installed on the iPhone/iPod device.</li> <li>• An active account with Pandora. Sign up at <a href="http://www.pandora.com">www.pandora.com</a>.</li> <li>• The USB sync cable that came with your iPod/iPhone device.</li> </ul>   |
| <b>USB Connection</b>    | <p>Connect an iPod touch or iPhone device (required, sold separately) to the USB port, using the USB sync cable included with your iPhone device.</p>   |
| <b>Changing Stations</b> | <ol style="list-style-type: none"> <li>1. Press <b>SELECT</b> to display the Stations Menu.</li> <li>2. Rotate the <b>volume knob</b> to choose to sort channels by date or alphabetically.</li> <li>3. Press <b>SELECT</b> to confirm, then turn the <b>volume knob</b> to cycle through the list of stations.</li> <li>4. Press <b>SELECT</b> when the desired station is highlighted, and playback will begin.</li> </ol> <p><b>Note:</b> Stations must be created on your account prior to connecting your iPod/iPhone device to the head unit.</p> |
| <b>Shuffle</b>           | <p>Press <b>SELECT</b> to display the Stations Menu. Choose "Shuffle" from the stations menu to shuffle songs from all of your stations.</p>  |
| <b>Skipping Tracks</b>   | <p>Press <b>▶▶</b> to skip the current song.</p>  |
| <b>Play/Pause</b>        | <p>Press <b>▶/  </b> to temporarily stop playback.<br/>Press <b>▶/  </b> again to resume playback.</p>  |
| <b>Thumbs Up</b>         | <p>Press <b>👍</b> to tell Pandora you like the current track. Pandora will play more tracks with similar qualities.</p>   |
| <b>Thumbs Down</b>       | <p>Press <b>👎</b> to tell Pandora you do not like the current track. Pandora will not play the current track again, and will avoid playing tracks with similar qualities.</p> <p>Refer to <a href="http://www.pandora.com/everywhere/mobile">www.pandora.com/everywhere/mobile</a> for devices compatible with the Pandora mobile application.</p>  |
|                          | <p><b>Note:</b> Pandora is an internet service, carrier and data charges may apply.</p>   |





# Troubleshooting

| Problem                                 | Cause   | Action   |
|---|---|--|
| <b>Unit will not turn on (no power)</b> | Yellow wire not connected or incorrect voltage<br>Red wire not connected or incorrect voltage | Check connections for proper voltage (11~16VDC)                          |
|   | Black wire not connected  | Check connection to ground   |
|   | Fuse blown  | Replace fuse   |
| <b>Unit has power (but no sound)</b>    | Speaker wires not connected   | Check connections at speakers  |
|   | One or more speaker wires touching each other or touching chassis ground                      | Insulate all bare speaker wires from each other and chassis ground       |
| <b>Unit blows fuses</b>                 | Yellow or red wire touching chassis ground  | Check for pinched wire   |
|   | Speaker wires touching chassis ground   | Check for pinched wire   |
|   | Incorrect fuse rating   | Use fuse with correct rating   |
| <b>Excessive skipping</b>               | Unit is not mounted correctly or backstrap is not secure                                      | Check mounting sleeve and backstrap support                              |
|   | Physical defect in media (CD, CD-R or CD-RW)  | Check media for scratches  |
| <b>ERROR 2 appears on display</b>       | Disc read error or disc is in upside down   | Press eject or <b>RESET</b>  |
| <b>PROTECT appears on display</b>       | The WMA file is copy-protected by DRM (Digital Rights Management)                             | Write disc using WMA files that are not copy-protected                   |
| <b>NO FILE appears on display</b>       | Selected file is not available in direct or alphanumeric search modes                         | Repeat search using valid parameters                                     |
| <b>Unit will not accept a disc</b>      | CD mechanism position out of alignment  | Press and hold <b>EJECT</b> for 3 seconds to reset CD mechanism position |
|   | CD transit screws still in place  | Remove 2 transit screws located on top of the unit                       |
| <b>NO SUPPORT appears on display</b>    | An invalid ID3 tag version is present   | Version 1.0 to 2.4 ID3 tags are supported.                               |
|   | An ID3 tag character is not supported   | Only ASCII characters are supported.                                     |



## Limited One Year Warranty

This warranty gives you specific legal rights. You may also have other rights which vary from state to state.

Dual Electronics Corp. warrants this product to the original purchaser to be free from defects in material and workmanship for a period of one year from the date of the original purchase.

Dual Electronics Corp. agrees, at our option, during the warranty period, to repair any defect in material or workmanship or to furnish an equal new, renewed or comparable product (whichever is deemed necessary) in exchange without charges, subject to verification of the defect or malfunction and proof of the date of purchase. Subsequent replacement products are warranted for the balance of the original warranty period.

**Who is covered?** This warranty is extended to the original retail purchaser for products purchased from an authorized Dual dealer and used in the U.S.A.

**What is covered?** This warranty covers all defects in material and workmanship in this product. The following are not covered: software, installation/removal costs, damage resulting from accident, misuse, abuse, neglect, product modification, improper installation, incorrect line voltage, unauthorized repair or failure to follow instructions supplied with the product, or damage occurring during return shipment of the product. Specific license conditions and copyright notices for the software can be found via [www.dualav.com](http://www.dualav.com).

### What to do?

1. Before you call for service, check the troubleshooting guide in your owner's manual. A slight adjustment of any custom controls may save you a service call.
2. If you require service during the warranty period, you must carefully pack the product (preferably in the original package) and ship it by prepaid transportation with a copy of the original receipt from the retailer to an authorized service center.
3. Please describe your problem in writing and include your name, a return UPS shipping address (P.O. Box not acceptable), and a daytime phone number with your shipment.
4. For more information and for the location of the nearest authorized service center please contact us by one of the following methods:
  - Call us toll-free at 1-866-382-5476
  - E-mail us at [cs@dualav.com](mailto:cs@dualav.com)

**Exclusion of Certain Damages:** This warranty is exclusive and in lieu of any and all other warranties, expressed or implied, including without limitation the implied warranties of merchantability and fitness for a particular purpose and any obligation, liability, right, claim or remedy in contract or tort, whether or not arising from the company's negligence, actual or imputed. No person or representative is authorized to assume for the company any other liability in connection with the sale of this product. In no event shall the company be liable for indirect, incidental or consequential damages.

## Specifications

|                  |  |
|------------------|--|
| <b>CD Player</b> | Frequency response: <b>10Hz-20kHz</b><br>Channel separation @ 1kHz: <b>&gt;65dB</b><br>D/A converter: <b>1 Bit</b>   |
| <b>FM Tuner</b>  | Tuning range: <b>87.5MHz-107.9MHz</b><br>Usable sensitivity: <b>8.5dBf</b><br>50dB quieting sensitivity: <b>10dBf</b><br>Stereo separation @ 1kHz: <b>40dB</b><br>Frequency response: <b>30Hz-13kHz</b>        |
| <b>AM Tuner</b>  | Tuning range: <b>530kHz-1710kHz</b><br>Usable sensitivity: <b>22uV</b><br>Frequency response: <b>30Hz-2.2kHz</b>   |
| <b>General</b>   | Speaker output impedance: <b>4~8 ohms</b><br>Line output voltage: <b>2 Volts RMS</b><br>Dimensions: <b>7" x 7" x 2" (178 x 178 x 51 mm)</b><br><br>Design and specifications subject to change without notice. |



### CEA-2006 Power Standard Specifications (reference: 14.4VDC +/- 0.2V, 20Hz~20kHz)

Power Output: 18 Watts RMS x 4 channels at 4 ohms and  $\leq 1\%$  THD+N  
 Signal to Noise Ratio: 80dBA (reference: 1 watt into 4 ohms)

# FCC Compliance

This device complies with Part 15 of the FCC Rules. Operation is subject to the following two conditions:

- (1) this device may not cause harmful interference, and
- (2) this device must accept any interference received, including interference that may cause undesired operation.

**Warning:** Changes or modifications to this unit not expressly approved by the party responsible for compliance could void the user's authority to operate the equipment.

**Note:** This equipment has been tested and found to comply with the limits for a Class B digital device, pursuant to Part 15 of the FCC Rules. These limits are designed to provide reasonable protection against harmful interference in a residential installation. This equipment generates, uses and can radiate radio frequency energy and, if not installed and used in accordance with the instructions, may cause harmful interference to radio communications. However, there is no guarantee that interference will not occur in a particular installation. If this equipment does cause harmful interference to radio or television reception, which can be determined by turning the equipment off and on, the user is encouraged to try to correct the interference by one or more of the following measures:

- Reorient or relocate the receiving antenna.
- Increase the separation between the equipment and receiver.
- Connect the equipment into an outlet on a circuit different from that to which the receiver is connected.
- Consult the dealer or an experienced radio/TV technician for help.



Dual Electronics Corp.  
Toll Free: 1-866-382-5476  
9AM-5PM EST, Monday-Friday

[www.dualav.com](http://www.dualav.com)  
©2013 Dual Electronics Corp. All rights reserved.

iPhone, iPod, iPod classic, iPod nano, and iPod touch are trademarks of Apple Inc., registered in the U.S. and other countries.

"Made for iPod" and "Made for iPhone" mean that an electronic accessory has been designed to connect specifically to iPod or iPhone, respectively, and has been certified by the developer to meet Apple performance standards. Apple is not responsible for the operation of this device or its compliance with safety and regulatory standards. Please note that the use of this accessory with iPod or iPhone may affect wireless performance.

Pandora, the Pandora logo, and the Pandora trade dress are trademarks of Pandora Media, Inc., used with permission.

Other trademarks and trade names are those of their respective owners.

NSA0813-V01

## Free Manuals Download Website

<http://myh66.com>

<http://usermanuals.us>

<http://www.somanuals.com>

<http://www.4manuals.cc>

<http://www.manual-lib.com>

<http://www.404manual.com>

<http://www.luxmanual.com>

<http://aubethermostatmanual.com>

Golf course search by state

<http://golfingnear.com>

Email search by domain

<http://emailbydomain.com>

Auto manuals search

<http://auto.somanuals.com>

TV manuals search

<http://tv.somanuals.com>