



**Digital Camera**  
**DXG-502 User's Manual**

# Table of Contents

## Precautions

|                                |   |
|--------------------------------|---|
| Safety Precautions .....       | 4 |
| Precautions Before Use .....   | 4 |
| Precautions for Operation..... | 4 |

## Package Contents

## Digital Camera Overview

|                        |   |
|------------------------|---|
| Product Overview ..... | 7 |
| Button Operation ..... | 9 |

## Battery Usage

|                                    |    |
|------------------------------------|----|
| Inserting/Changing Batteries ..... | 10 |
|------------------------------------|----|

## Memory Card and Built-in Memory

|                                 |    |
|---------------------------------|----|
| Loading the Memory Card .....   | 11 |
| Removing the Memory Card.....   | 11 |
| Using the Built-in Memory ..... | 13 |

## Adjusting the Wrist/Lens Straps

## Turning on the Camera and Lights

|                             |    |
|-----------------------------|----|
| Power.....                  | 15 |
| Battery Capacity Meter..... | 15 |
| Lights.....                 | 16 |

## Setting the Date, Time and Language

|                             |    |
|-----------------------------|----|
| Setting Date and Time ..... | 17 |
| Setting Language .....      | 17 |

## Basic Operations

|                                       |    |
|---------------------------------------|----|
| LCD Monitor.....                      | 18 |
| Info/Hint .....                       | 18 |
| Description of Button Functions ..... | 19 |
| Menu.....                             | 19 |

## Setup Mode

|                        |    |
|------------------------|----|
| Advanced Settings..... | 20 |
| Menu Index.....        | 21 |

## Photo Mode

|                                       |    |
|---------------------------------------|----|
| Auto Mode.....                        | 25 |
| Manual Mode .....                     | 27 |
| Scene Mode .....                      | 29 |
| Descriptions of the Three Modes ..... | 30 |
| Taking Pictures.....                  | 30 |

# Table of Contents

|  |    |
|--|----|
| LCD Screen .....                               | 31 |
| Optical Zoom / Digital Zoom .....              | 31 |
| Flash .....                                    | 32 |
| Burst / Self Portrait / Close-up .....         | 32 |
| Self-timer Mode.....                           | 33 |
| Close-Up Mode (Macro) .....                    | 33 |
| Focus Selection.....                           | 34 |
| Instructions for Scene Modes .....             | 34 |
| Descriptions on Menu.....                      | 36 |
| Image Resolution .....                         | 36 |
| Picture Quality .....                          | 36 |
| Photo Mode .....                               | 36 |
| Auto .....                                     | 36 |
| Manual.....                                    | 36 |
| White Balance .....                            | 36 |
| EV Compensation .....                          | 37 |
| Metering Mode .....                            | 37 |
| ISO.....                                       | 37 |
| Scene Mode .....                               | 37 |
| Effects .....                                  | 37 |
| Off .....                                      | 38 |
| Black and White .....                          | 38 |
| Vivid .....                                    | 38 |
| Sepia .....                                    | 38 |
| Advanced Settings .....                        | 38 |
| Self Timer .....                               | 38 |
| Burst (Number of Pictures in Succession) ..... | 38 |
| Self Portrait Flash Unit .....                 | 38 |
| Sound Effect of Shutter .....                  | 38 |
| Menu Index.....                                | 39 |

## Video Mode

|                           |    |
|---------------------------|----|
| Recording Videos .....    | 44 |
| Description on Menu ..... | 45 |
| Image Resolution .....    | 45 |
| White Balance .....       | 45 |
| Record .....              | 45 |
| Menu Index.....           | 46 |

## Review Mode

|  |    |
|--|----|
| Picture.....                           | 47 |
| Video .....                            | 49 |
| Thumbnail Display .....                | 49 |
| Playing Video .....                    | 50 |
| Picture Magnification Mode.....        | 50 |
| Audio Record .....                     | 51 |
| Playing/Deleting the Audio Record..... | 52 |
| Playing the Audio Record .....         | 52 |
| Deleting the Audio Record .....        | 52 |
| Adjusting Volume .....                 | 53 |

# Table of Contents

|  |    |
|--|----|
| Description on Menu .....                          | 54 |
| Deletion .....                                     | 54 |
| Delete One .....                                   | 54 |
| Delete All .....                                   | 54 |
| Single Protection / Single Protection Remove ..... | 54 |
| All Protection .....                               | 54 |
| Remove All Protection .....                        | 54 |
| Slide Show .....                                   | 54 |
| Starting the Slide Show .....                      | 54 |
| Display Interval .....                             | 55 |
| Repeating the Slide Show .....                     | 55 |
| DPOF .....   | 55 |
| Setting Single .....                               | 55 |
| Setting All .....                                  | 55 |
| Direct Printing .....                              | 55 |
| Printing a Single Picture .....                    | 55 |
| Printing All Pictures .....                        | 55 |
| Paper Size .....                                   | 55 |
| Menu Index.....                                    | 56 |
| Printing Notices.....                              | 62 |

## PC Mode

|                                  |    |
|----------------------------------|----|
| Removable HDD (Hard Drive) ..... | 63 |
| Data .....                       | 64 |

## Video Out

## Installing the Software

|                                       |    |
|---------------------------------------|----|
| Installing the Software on a PC ..... | 66 |
|---------------------------------------|----|

## Installing Application Programs

|   |    |
|---|----|
| Installing Application Programs on a PC ..... | 68 |
|---|----|

## Appendix

|                              |    |
|------------------------------|----|
| Product Specifications ..... | 72 |
| System Requirements .....    | 73 |

# Precautions

## Safety Precautions

The supplied Software CD is designed exclusively for a PC. Playing the CD on a stereo or audio CD player may damage the player.

This is a sophisticated electronic device. Do not disassemble the unit; the inside contain high-voltage components can cause an electrical shock or fire hazard.

To reduce the risk of fire, do not store this product in direct sunlight for long periods of time.

## Precautions Before Use

### Take some test shots before taking pictures.

Before using this camera for an important occasion, such as a wedding ceremony or overseas trip, first test the camera to ensure that it functions properly. DXG is not responsible for any incidental losses (such as the costs of photography or the loss of income from photography) incurred as the result of this product malfunctioning, and no compensation will be provided for it.

### Copyright information

All pictures taken with this digital camera must be in accordance with copyright law. When "No Photography" restrictions are in place, it is illegal to record any live performance, improvisation, or exhibit, even for personal use. Any transfer of pictures or memory card data must be conducted under the constraints of copyright law.

### LCD (Liquid Crystal Display) Monitor

Notes on the LCD (Liquid Crystal Display) monitor

Be extra careful with the LCD monitor. If it is damaged and begins to leak, do the following:

1. If the liquid touches the skin: wipe the skin dry with a cloth and rinse immediately with plenty of water.
2. If the liquid comes in contact with eyes: rinse immediately with plenty of water for at least 15 minutes and seek medical advice as soon as possible.
3. If the liquid is accidentally swallowed: rinse the mouth with water, drink plenty of water and induce vomiting. Seek medical advice as soon as possible.

## Precautions for Operation

This product consists of intricate electrical parts. To ensure the highest possible performance, do not drop or hit the camera.

Avoid using or storing the camera in the following locations:

1. Damp or dusty places.
2. In sealed vehicles, in direct sunlight or in any areas with extremely high temperatures.
3. Turbulent or high-vibration environments.
4. Areas with smoke, oil fumes or steam.
5. Locations subject to strong magnetic fields.
6. Rainy or snowy environments.

# Precautions

Do not open the battery cover when the power is on.

If water has entered the camera, turn the power OFF and remove the batteries immediately.

How to maintain the camera:

1. If the lens, LCD monitor, or viewfinder surface is dirty, use a lens brush or soft cloth to wipe it clean. Do not touch the lens with your fingers.
2. To avoid scratching the lens, LCD monitor, or viewfinder surface, do not use any hard or abrasive object to touch the camera.
3. Do not use any detergents or volatile solutions to clean the camera. This may harm the camera and/or paint. Use a soft cloth only.

# Package Contents

Please check the package contents. Please contact your dealer right away in case of any item missed.

**1. Digital Camera**



**2. User Manual**

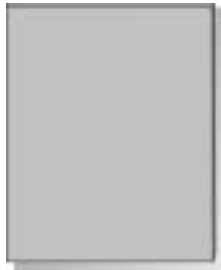

**3. Wrist Strap**



**4. Lens Cap**



**5. USB /TV-OUT  
CABLE**



**6. Camera Leather  
Case**



**7. Software CD**

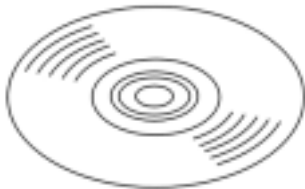

**8. AA NiMH Batteries x2  
with Charger**



# Digital Camera Overview

## Product Overview

### Front View

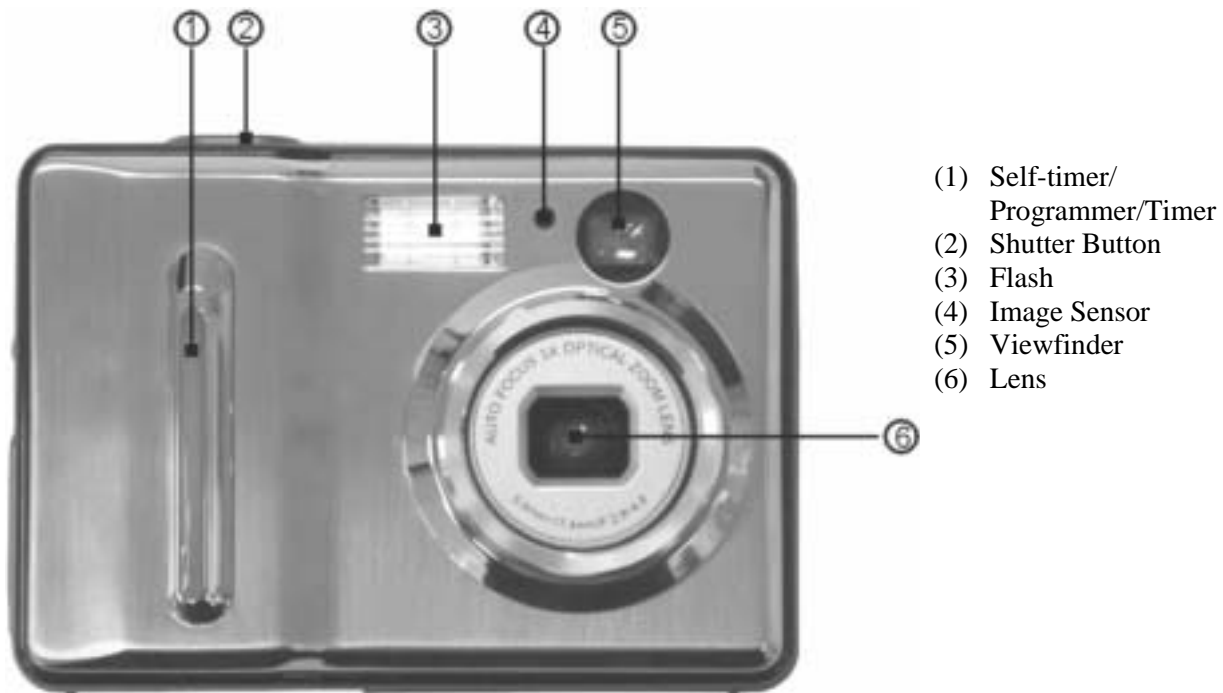

### Shutter

Press the shutter button to take photos and start video recording.

### Lens Cap

Remove the lens cap before turning on the camera. Refit the cap when the camera is powered off to protect the lens and keep dust out.

### USB Cover

Open the USB cover, which has a slot for both USB and TV-Out cables.



# Digital Camera Overview (Continued)

## Back View



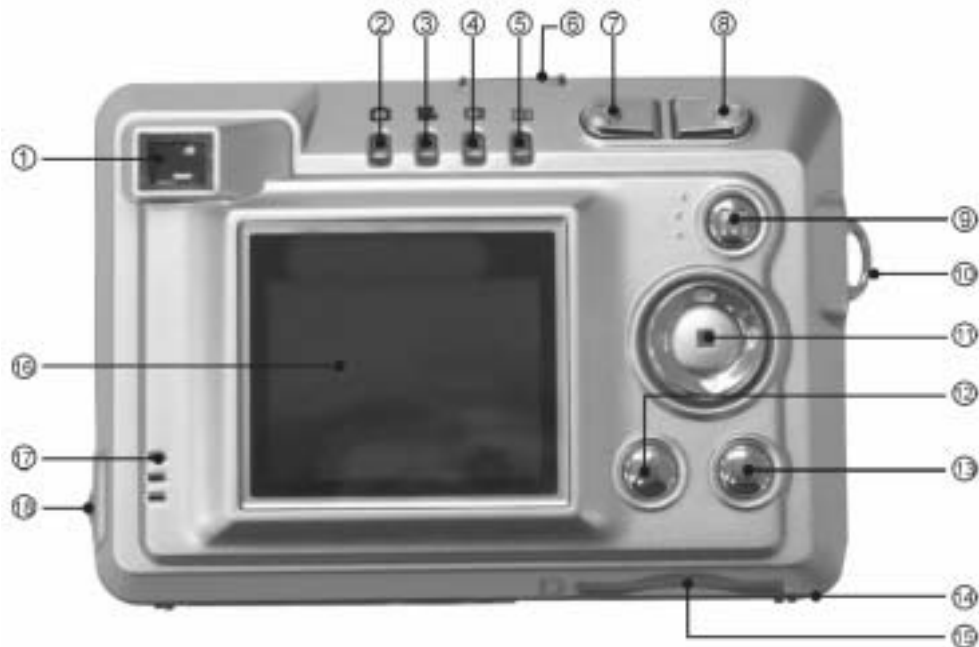

- (1) Viewfinder
- (2) Photo Mode
- (3) Video Mode
- (4) Review Mode
- (5) Setup Mode
- (6) Power Switch
- (7) Reduction Key
- (8) Magnifier Key
- (9) Mode dial
- (10) Wrist Strap Buckle
- (11) Confirm/Function Button
- (12) Flash Button
- (13) Menu button
- (14) Battery Cover
- (15) Memory Card Slot
- (16) LCD Screen
- (17) Speaker
- (18) USB/TV-OUT Slot



# Digital Camera Overview (Continued)

## Button Operation

### Mode Switch

There are four modes available, including Photo Mode , Video Mode , Review Mode  and Setup Mode . The LED indicates which mode is in use.

### Menu button



This displays the selection menu for each of the modes. For details, please refer to menu descriptions in each mode.

### Flash Button



There are six selections for the flash mode. Refer to the flash setting for greater detail.

### Multiple Controller

Besides the menu selection, the Multiple Controller has a quick function. Select “Hint of Info” in the “Info” to read the function of each button.

### Zoom Button

The Zoom button is used to adjust the size of the subject.

# Battery Usage

## Inserting/Changing Batteries

Turn the digital camera off and follow the instructions below.

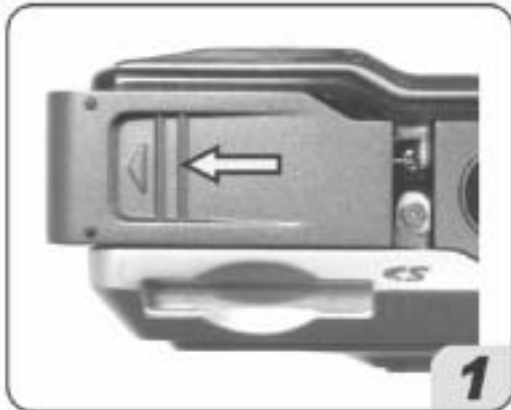

Slide the battery cover in the direction of the arrow and lift it open as shown.

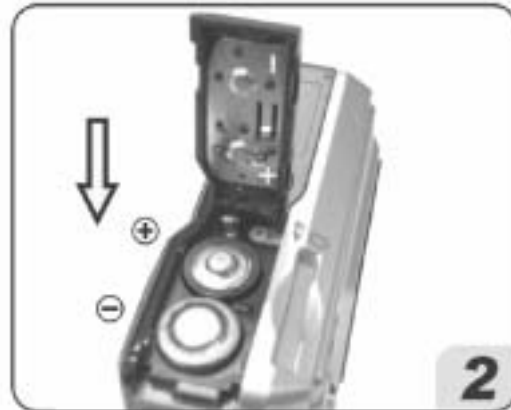

Follow the instruction labeled on the inside of the battery compartment door and insert the batteries as indicated.



Close the battery cover.



**To avoid any possible damage, be gentle when opening and closing the battery compartment.**

# Memory Card and Built-in Memory

## Loading the Memory Card

Turn the camera off and follow the instructions below.



Orient the memory card as shown, and insert it into the slot.



Press the memory card in all the way.

## Removing the Memory Card

Turn the digital camera off and follow the instructions below.

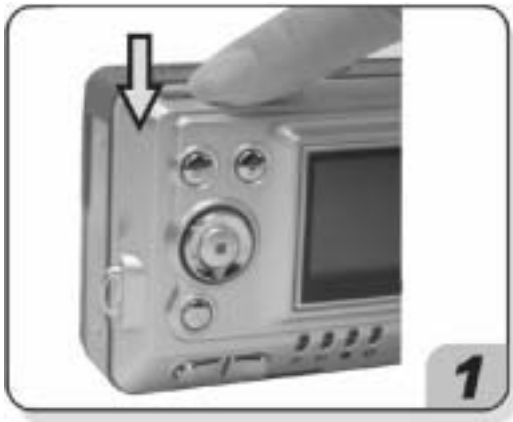

Gently push the card in and it will eject automatically.



Pull the memory card out as shown.

## Memory Card and Built-in Memory(Continued)



This product can use an SD or MMC memory card, with memory capacity ranging from 16MB to 512 MB.

The memory card can only fit in one direction. Do not use excessive force when installing into a memory card socket; too much force could cause damage.



If the memory card is unreadable, wipe its metal side with a soft, dry cloth and install it again.

Make sure to unlock the memory card before inserting. Otherwise, the camera will display an  icon and be unable to save images.



**Notice! Use FAT16 or FAT32 when formatting the memory card with PC.**

# Memory Card and Built-in Memory(Continued)

After installing the memory card, the screen will display an  icon under normal status. If it displays  (indicating that the built-in memory is in use), please refer to the following four possible reasons and resolutions.

**The memory card format is unrecognizable.**

Back up the data on the memory card to a PC and re-format the memory card.

**A poor connection is being made with the card contacts.**

Wipe the card contacts clean with a dry soft cloth and reinstall.

**The memory card is damaged and unable to function.**

Contact the memory card company for repair or replacement.

**The memory card slot is damaged and unable to read data.**

Contact the dealer for repair or replacement.

## Usage of Built-in Memory

When the memory card capacity is full, the camera's built-in 16MB flash memory offers a temporary space for storage (Due to internal firmware storage, the actual memory capacity is slightly less than 16MB).

While the memory card is installed, all functions (format, save, review, upload/download and so on) are directed to the memory card.

Simply pull out the memory card out to use the built-in memory, then all the data functions are based on the built-in memory.

# Adjusting the Wrist/Lens Straps

Follow the illustrations below to secure the camera strap.



Put the wrist strap through the wrist strap post.



Pull one end of the strap through the other and tighten it.



Put the lens strap through the lens strap post.



Pull the other end of the strap through the other side of the lens strap post and tighten it.



Put one end of the lens strap through the camera strap post.



Finally, pull the lens cap through and tighten it.

# Turning on the Camera and Lights

## Power

Press the Power button to turn on the camera and press it again to turn it off.



**This camera features a power-saving mode, it switches off automatically when there is no action within a preset time. Please refer to the Setup mode/Power Saving for details.**

## Battery Capacity Meter

The battery capacity meter on the camera screen indicates:



**Full** (This icon disappears 5 seconds after entering the mode.)

**Half** (This icon disappears 5 seconds after entering the mode.)

**Low** (The icon changes to yellow and remains.)

**Exhausted** (The icon changes to red and keeps blinking.)



**When replacing batteries, the date and time need to be reset. Other settings of the menu will be restored and need no re-setting.**



# Turning on the Camera and Lights (Continued)



**Low battery level adversely affects the recharge of the flash. Use fully-charged batteries for best results.**



**The camera cannot operate under a certain power level. Use fully charged batteries to make sure the camera doesn't shut off.**

## Lights

Descriptions of the front Flashing Unit and the back mode status indicator.

|                       | Indicators                    | Description |  |
|-----------------------|-------------------------------|-------------|--|
| Mode Status Indicator | Yellow/Red Indicator          | Light on    | This indicates the current mode you are in, for example, the Photo Mode or Video Mode. |
| Programmer/Timer      | Four lights change and blink. | Blink       | When turning on the camera, it blinks.<br>When using the self-timer, it blinks.        |

# Setting the Date, Time and Language

Use the Mode dial to enter the Setup (**SET**) Mode.

## Setting Date and Time

This camera can record the date and time on pictures. Be sure to set the correct date and time before taking pictures. Please refer to Setup Mode on page 21 for more details.

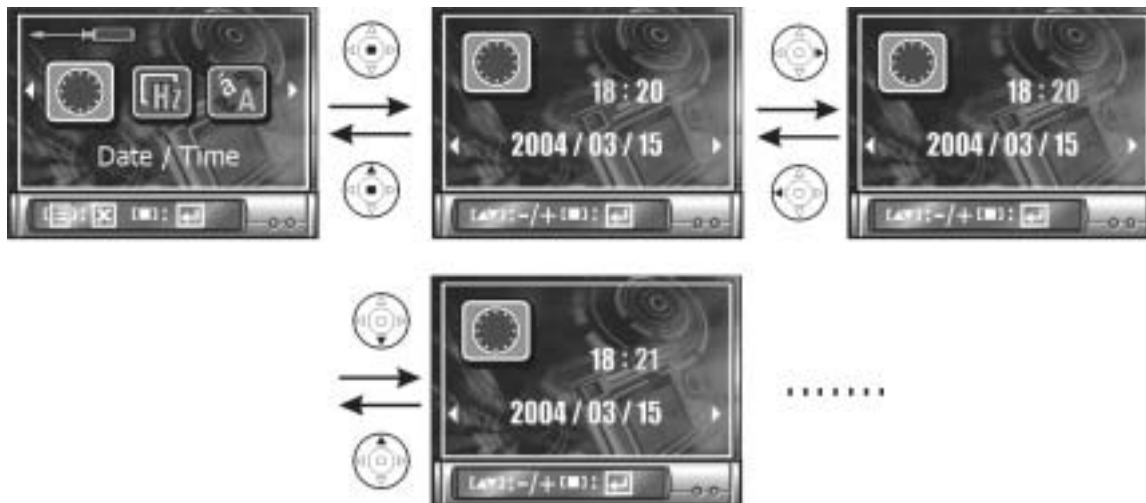

## Setting Language

Select the language of your choice; the options include English, Traditional Chinese, French, German, Italian, Japanese, and Spanish.





# Basic Operations

## LCD Monitor

The LCD screen is used to frame the picture, adjust settings, and review pictures and videos. It is normal that the LCD screen looks darker under direct sunlight or bright light.

## Info/Hint

Press the  button to enter the Info page. Press the  button again to provide a Hint that offers descriptions of functions of buttons. For example:

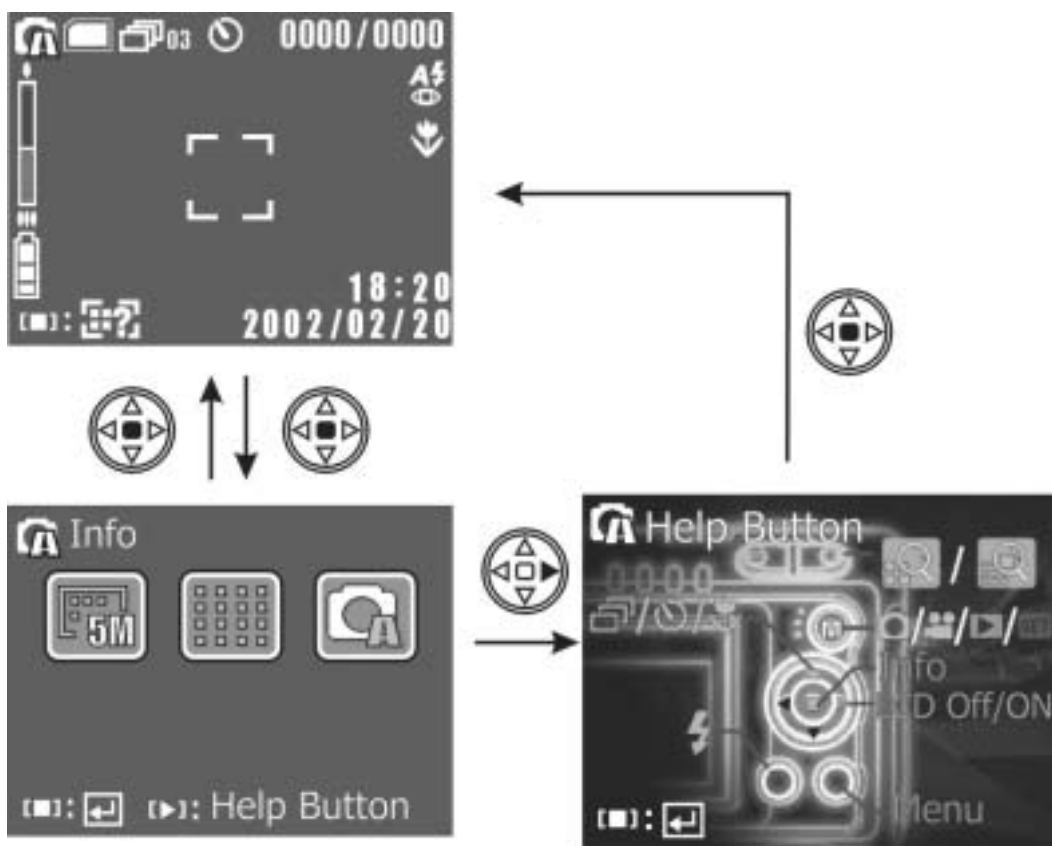













Current status of settings

Description of each active function.

# Basic Operations

## Description of Button Functions

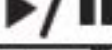
On the bottom of the LCD screen there are button function directions, which describe what the buttons do.

| Icons   | Description                                   |
|---|---|
|    | Center of the Multiple controller             |
|    | Up/down/left/right of the multiple controller |
|    | Flash Button                                  |
|    | Menu button                                   |
|    | Zoom button                                   |
|    | Zoom in/Zoom out                              |
|    | Sound Recording Mode/Sound Recording Menu     |
|  | Set/Enter                                     |
|  | Delete/Back                                   |
|  | Increase/ Decrease                            |
|  | Play/ Stop                                    |
|  | Volume/ Print                                 |

## Menu

In the Photo/Video/Review Modes, press the  button to enter the Mode Menu for relevant settings.

# Setup Mode

Use the Mode dial to enter the Setup (**SET**) Mode. The following are descriptions of the settings.

## ■ **Date/Time Set**

This allows the camera to record the date and time on pictures. Correct date and time should be set before taking pictures.

## ■ **Light Frequency**

Adjusts the power frequency to your regional setting, such as 50Hz (Europe) or 60HzAC (U.S.A).

## ■ **Language**

Displays different languages; English, Traditional Chinese, Japanese, German, French, Italian, and Spanish.

## ■ **Energy Saving**

Provides auto power off timing options: Off, 30 sec, 1 min, 5 min, and 10 min.

## ■ **Video Output**

Adjusts the video output format to the regional setting, so pictures can be seen on TV. The United States uses NTSC.

## ■ **Display**

Allows you to display pictures/videos on the camera screen or TV. Use this option to transfer images to a TV.

## Advanced Settings

## ■ **Button audio**

Activates the sound effects when buttons are pressed.

## ■ **Startup Light**

Activates the front LED light effect when the camera is turned on. Four options are available: OFF, Effect 1, Effect 2 and Effect 3.

## ■ **Startup Sound**

Offers an opening sound effect when turning the camera on (Option: ON/OFF).

## ■ **Startup Picture**

Four options are available for setting the startup picture: default startup picture, customized 1, customized 2, and customized 3. The customised picture can be any one you have taken.

## ■ **Format**

This will reformat and delete all the data on the memory (card). Please make sure the information is backed up before formatting. NOTE: Once deleted, the files cannot be recovered.

## ■ **Reset**

After resetting, all options are restored to the default settings.

# Setup Mode (Continued)

## Menu Index

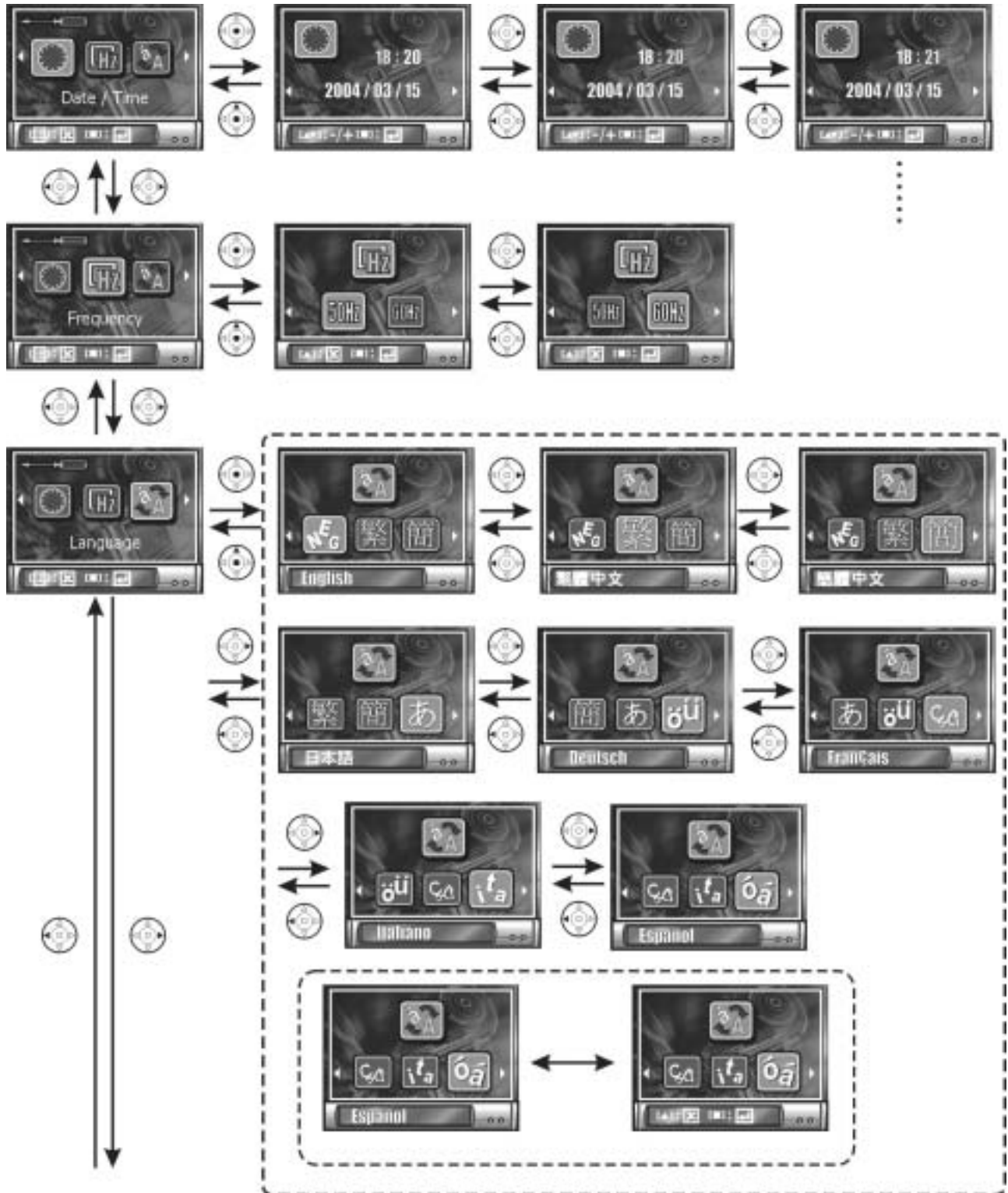

# Setup Mode (Continued)

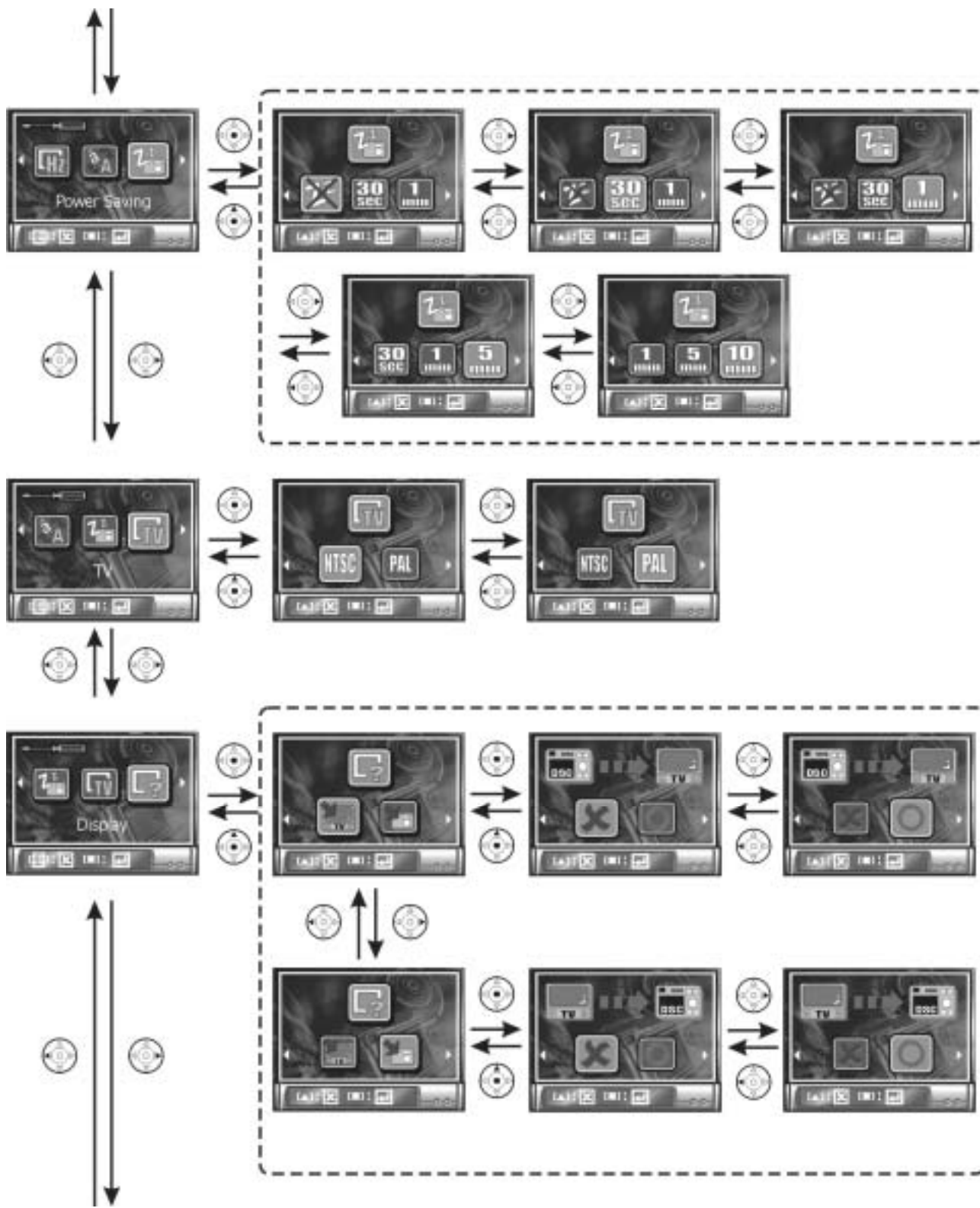

# Setup Mode (Continued)

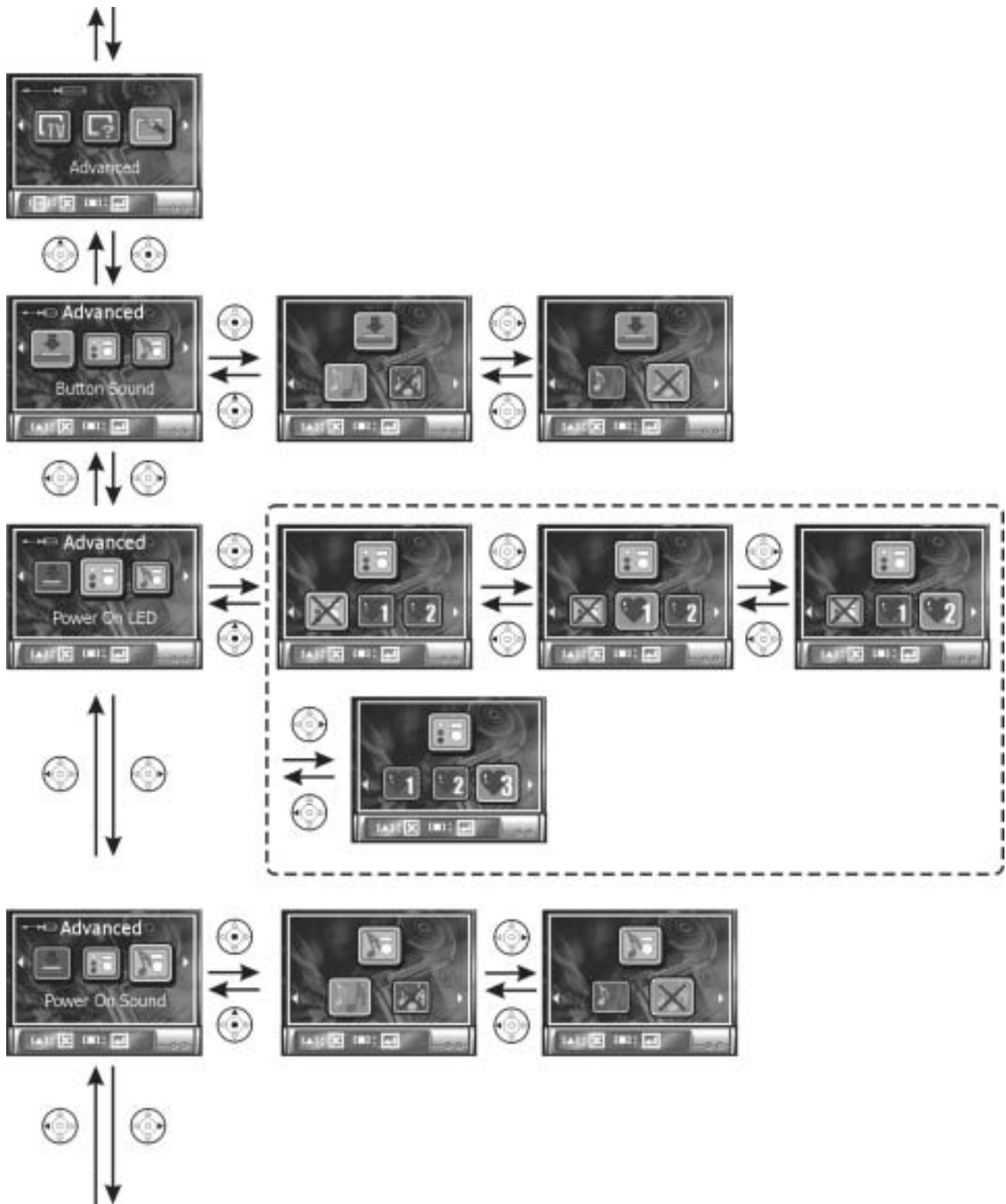



# Setup Mode (Continued)

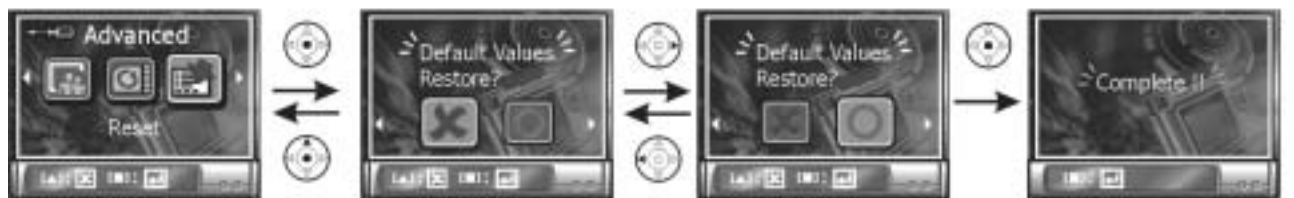
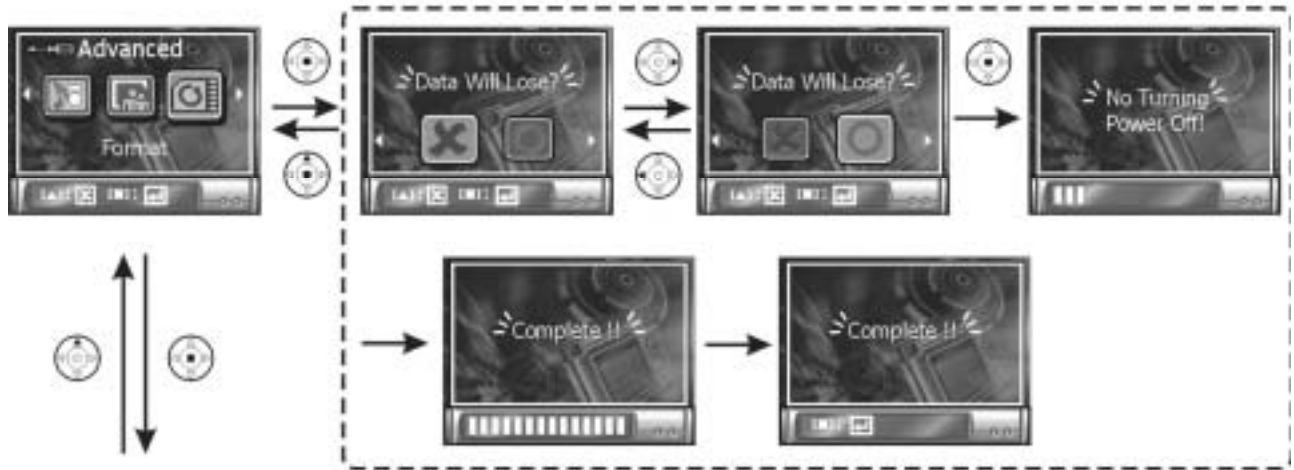
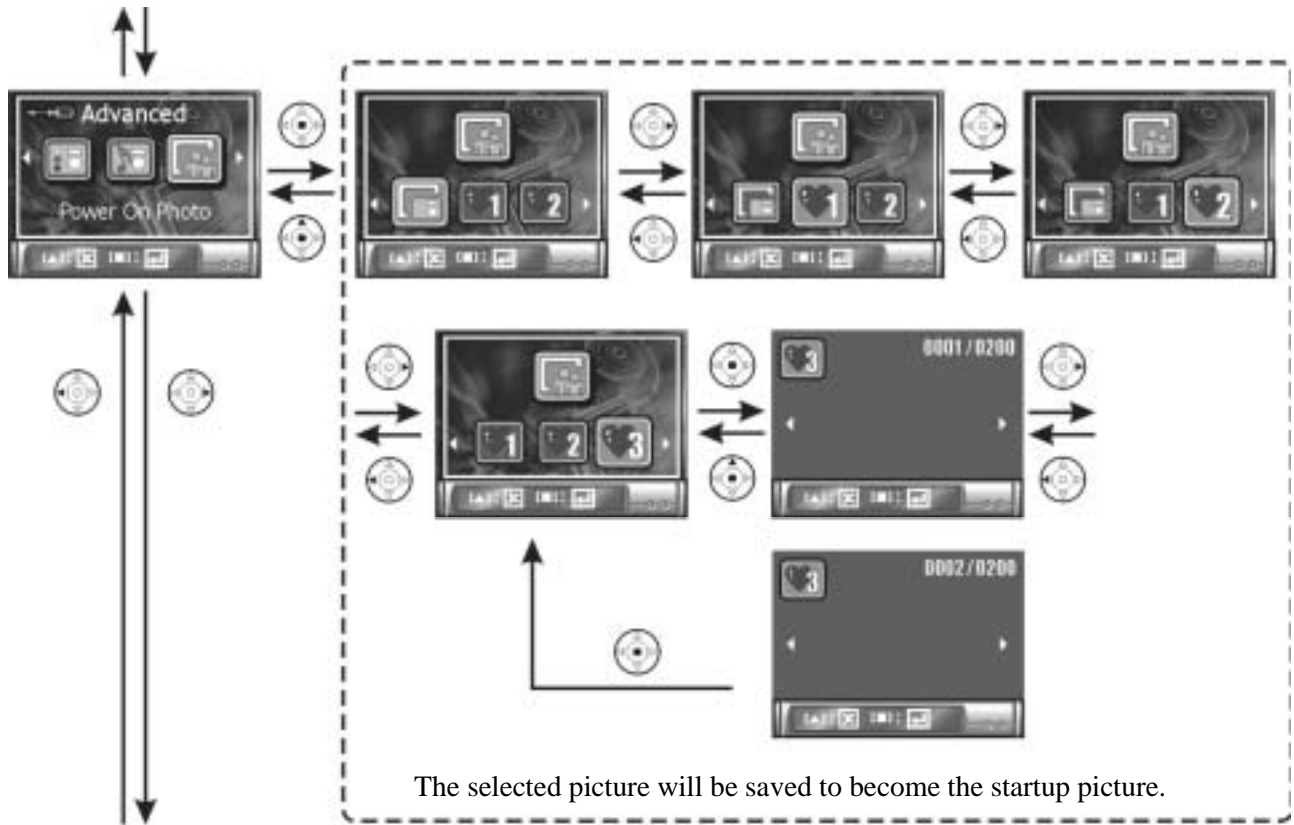

# Photo Mode







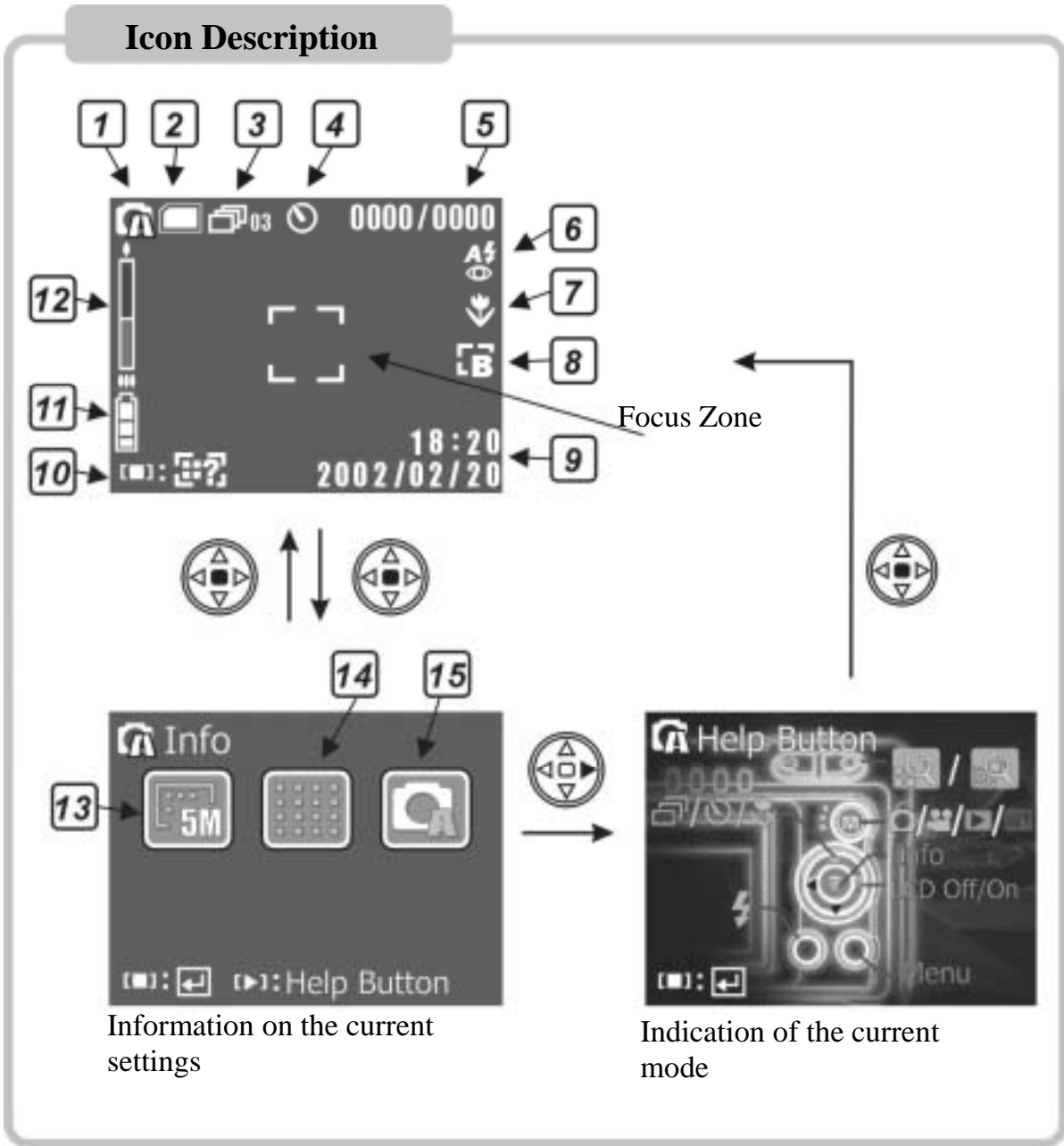

Use the Mode dial to switch to the Photo (📷) Mode.

The Photo Mode has following options: Auto, Manual, and Scene Mode.

## Auto Mode



# Photo Mode (Continued)

- 1 Photo Mode (Auto)
- 2 Status of Memory Card
  -  : Memory Card empty
  -  : Memory Card half full
  -  : Memory Card is almost full
  -  : Memory Card full (red light blinks)
  -  : Memory card write protect
  -  : Built-in memory
  -  : Built-in memory half full
  -  : Built-in memory full (red light blinks)
- 3 Burst Mode / Number of pictures
- 4 Self Portrait
- 5 Number of pictures taken / Maximum number of pictures
- 6 Flash Mode
- 7 Portrait Mode
- 8 Effect Mode
- 9 Time and date (This icon disappears 5 seconds after entering the mode.)
- 10 Info
- 11 Battery Info
- 12 Optical Zoom / Digital Zoom
- 13 Image Resolution
- 14 Picture Quality
- 15 Photo Mode (Auto)

# Photo Mode (Continued)

## Manual Mode

### Icon Description

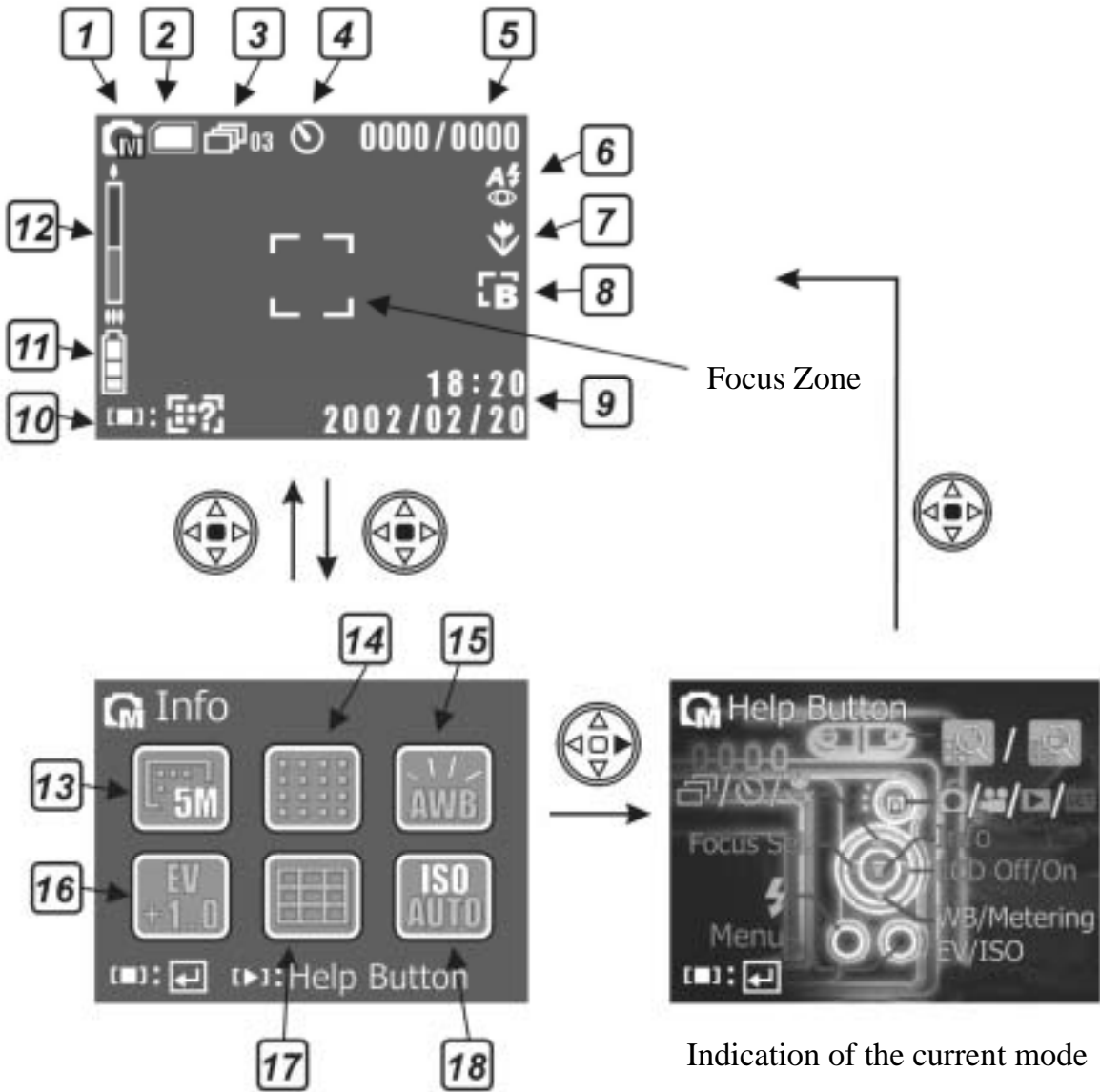

Information on the current settings

Indication of the current mode

## Photo Mode (Continued)

- 1 Photo Mode (Manual)
- 2 Status of Memory Card
- 3 Burst Mode / Number of pictures
- 4 Self Portrait
- 5 Number of pictures taken / Maximum number of pictures
- 6 Flash Mode
- 7 Portrait Mode
- 8 Effect Mode
- 9 Time and date (this icon disappears 5 seconds after entering the mode,.)
- 10 Info
- 11 Battery Info

Except for **1**, other settings are the same as in the Auto Mode.

- 12 Optical Focus / Digital Focus
- 13 Image Resolution
- 14 Picture Quality
- 15 White Balance
- 16 EV Compensation
- 17 Metering Mode
- 18 ISO Sensitivity

# Photo Mode (Continued)

## Scene Mode

### Icon Description

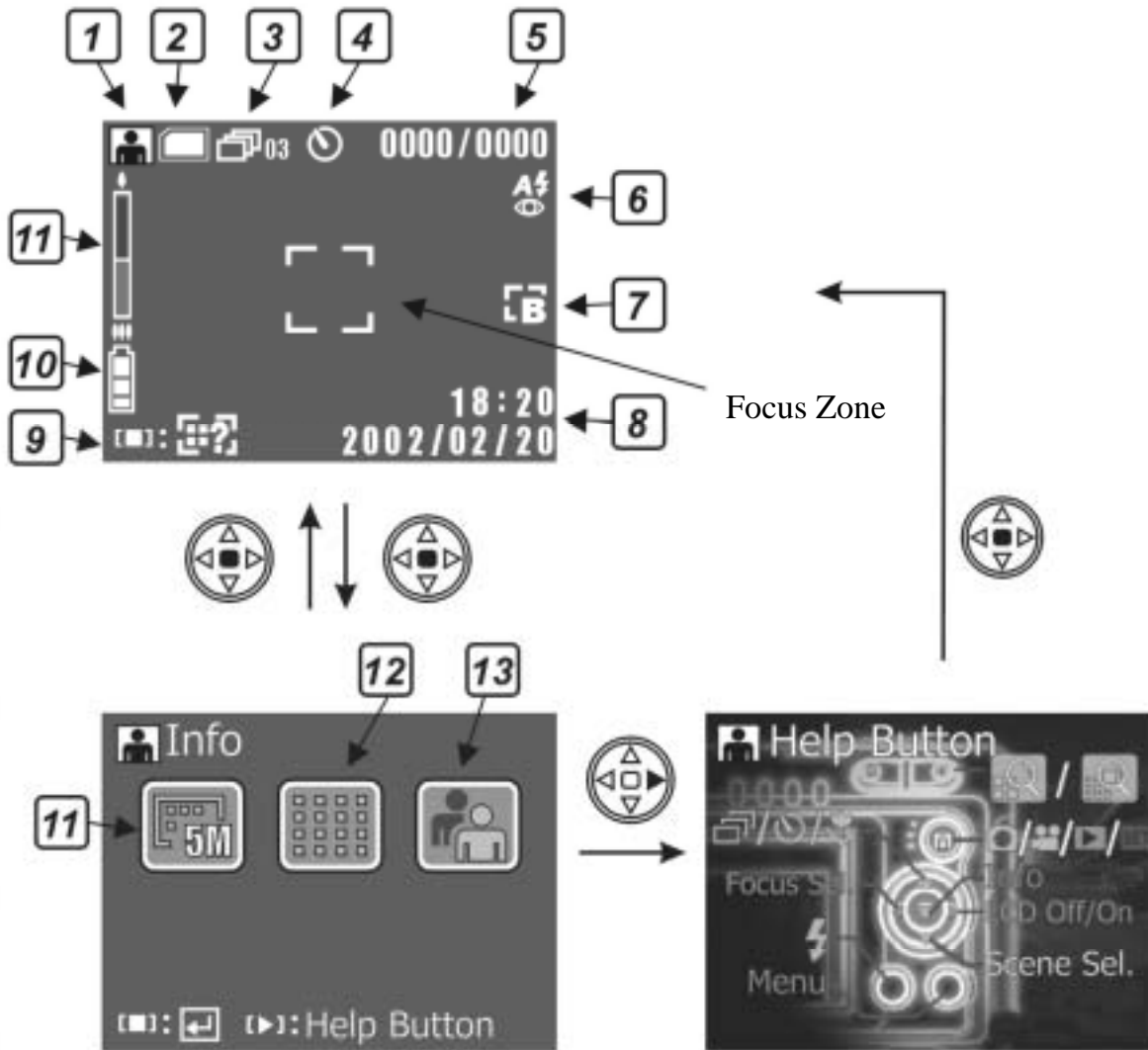

Information on the current settings

Indication of the current mode

Except for “1 13” other resttings are the same as in the Auto Mode.

Photo Mode (Scene Mode)

# Photo Mode (Continued)

## Descriptions of the Three Modes

### Auto

The Auto Mode offers users a simple, fast capture mode. Except for Image Resolution and Picture Quality, other settings are default values which cannot be adjusted (Eg: White Balance, Exposure Compensation, Metering, ISO and Focus Selection will be modified automatically by the camera). This setting is suitable for most users.

### Manual

The Manual Mode offers settings which are fully adjustable, such as Image Resolution, Picture Quality, White Balance, Exposure Compensation, Metering, ISO, and Focus Selection. This setting is suitable for more advanced users.

### Scene Mode

The Scene Mode offers twelve built-in scenes. Individual settings cannot be adjusted, except for Image Resolution and Picture Quality.



Portrait



Night Landscape



Fireworks



Landscape



Beach



Image Transfer



Party



Sunset



Backlight



Night Portrait



Multiple Exposure



Sport

## Taking Pictures

This camera takes digital still images in JPEG format. The number of pictures you can take is subject to the storage capacity of the memory (card), Image Resolution, and Picture Quality. Pictures with higher resolution and quality require more memory.

**Follow these steps to take pictures.**





**1**

Turn on the camera and set up the date and time (Please refer to Date and Time Set).

**2**

Use the Mode dial to switch to Photo Mode (Choose among Auto, Manual, and Scene Mode. Auto Mode is suggested for most users.) Find corresponding icons displayed on the upper left hand corner of the screen and set the Image Resolution and Picture Quality according to your preference (Please refer to Picture Quality).

# Photo Mode (Continued)

- 3 Use the  to choose the Burst / Self Portrait / Close-up Mode.
- 4 Frame the view on the LCD screen and press the Shutter button. The Shutter button has two parts. Press it halfway and hold for focus, with a red framing mark. Then press it the rest of the way down to save the picture. A  icon will appear on the screen.
- 5 Use the Zoom button to zoom out/in  /  on the subject. This camera has a maximum 12X zoom (3X Optical Zoom and 4X Digital Zoom).
- 6 Activate the Flash when there are insufficient light sources (refer to the Flash Mode for details.)
- 7 Refer to the Review Mode for viewing the pictures.

## LCD Screen

Use the  key to switch screen display types.

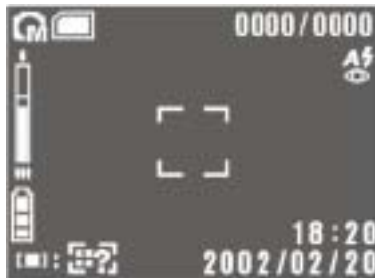

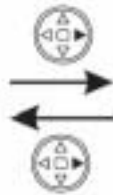

Standard Screen



LCD screen turned off.

## Optical Zoom / Digital Zoom

Use the Zoom button to zoom out/in  /  on the subject. This camera has a maximum 12X zoom (3X Optical Zoom plus 4X Digital Zoom).

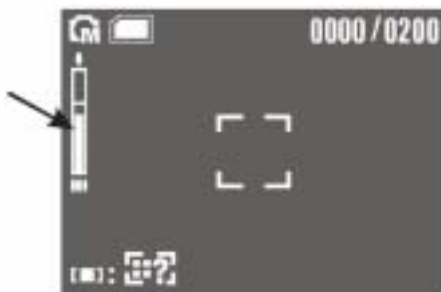

The blue region indicated by the arrow indicates the optical zoom range.

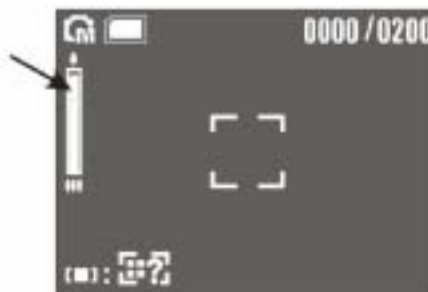

The red region indicated by the arrow indicates the digital zoom range.









# Photo Mode (Continued)

Using the Digital Zoom to enlarge images may cause slight aliasing. Note: Full Digital Zoom is not recommended for taking pictures that require the highest clarity.

## Flash

Use the  key to switch to Flash mode.

| Display  | Function                            | Description  |
|--|-------------------------------------|--|
|   | No Flash                            | Turns off the Flash (for bright places).   |
|   | Auto                                | Auto Flash automatically comes on when needed.   |
|   | Forced Flash                        | Always flashes (bright or dark areas).   |
|   | Auto Flash plus Red Eye Reduction   | Flash fires automatically in low light, and pre-flashes to reduce “red eye” effects. Auto Flash is suitable for portraits.   |
|   | Forced Flash plus Red Eye Reduction | Always flashes with red eye reduction flash.   |
|  | Slow Sync                           | Keeps the shutter open longer. Used at night and in low light to lighten the background and foreground. A tripod is advised. |

## Burst / Self Portrait / Close-up

Use the  button to switch among Burst / Self Portrait / Close-up Mode.

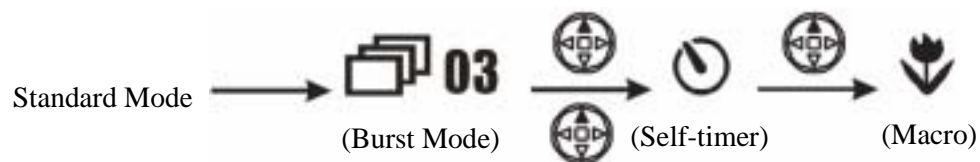

### Continuous Photography Mode

When entering the Burst Mode, the  03 icon appears on the upper part of the screen. The number represents the number of camera pictures that will be taken (up to 5 pictures). After framing, press the Shutter button and the camera will shoot continuously for that number of photos.

# Photo Mode (Continued)



**Image Resolution is set at 5MP and Flash is “OFF” in the Burst Mode, regardless of the current settings.**

## Self-timer Mode



The  icon appears on the upper part of the screen after entering the Self-timer mode. Press the Shutter after framing the view and you will see the countdown (the default value is 10 seconds and can be adjusted on the menu). The front Flash Unit blinks, and as soon as it reaches 3 seconds, it blinks faster. When it reaches zero, the camera takes the pictures automatically.

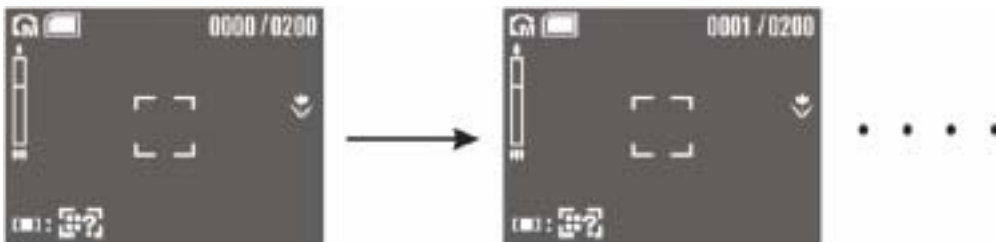

## Close-Up Mode (Macro)

The  icon appears on the right side of the screen when entering the Close-Up Mode or “Macro” Mode. Take pictures with short distance under the following ranges:









| Mode  | Icon on the screen  | Description   |
|---|---|---|
| Close-Up<br> |  | An ideal close-up picture will be shot within 6 ~ 20 inches.  |
| Basic   | None  | For general picture-taking, a suitable shooting distance ranges from 20 in. to infinity; the picture will become blurred if the distance is less. |

# Photo Mode (Continued)



**The Close-Up function is unavailable in the Scene Mode.**

## Focus Selection

Press the  button in the Manual and Scene Mode to enter the focus selection. Set the desired focus zone. The Focus Zone is divided into five areas and five framing marks will be displayed on the screen. The green one represents the area in use. Use the     buttons for selection, and press the  button. Follow the usual procedures for photographing.

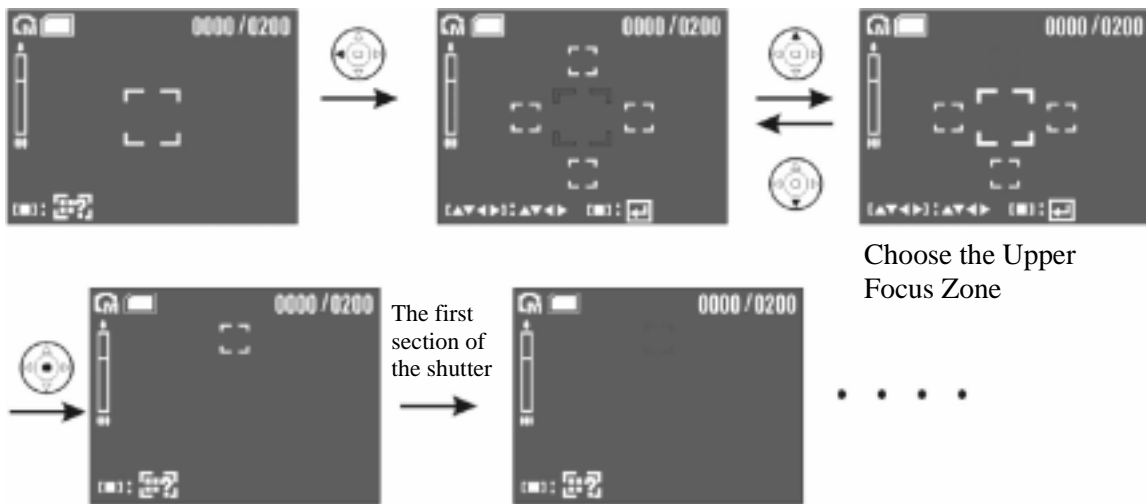

**The Focus Zone is disabled in the Auto Mode. Only the Manual and Scene Modes offer the Focus Zone selection.**

## Instructions on Scene Modes

Twelve built-in scenes are offered in the Scene Mode. Different settings for White Balance, Exposure Compensation, Metering and other functions are set at default values and cannot be adjusted in these scenes. Choose the scene according to your preference.

Press the  button to enter the Quick Menu and choose the scene. The twelve scenes are described below.









Portrait: For people and other subjects in the daytime.







Landscape: For landscapes in the daytime. The Focus is set at distant scenery.

# Photo Mode (Continued)

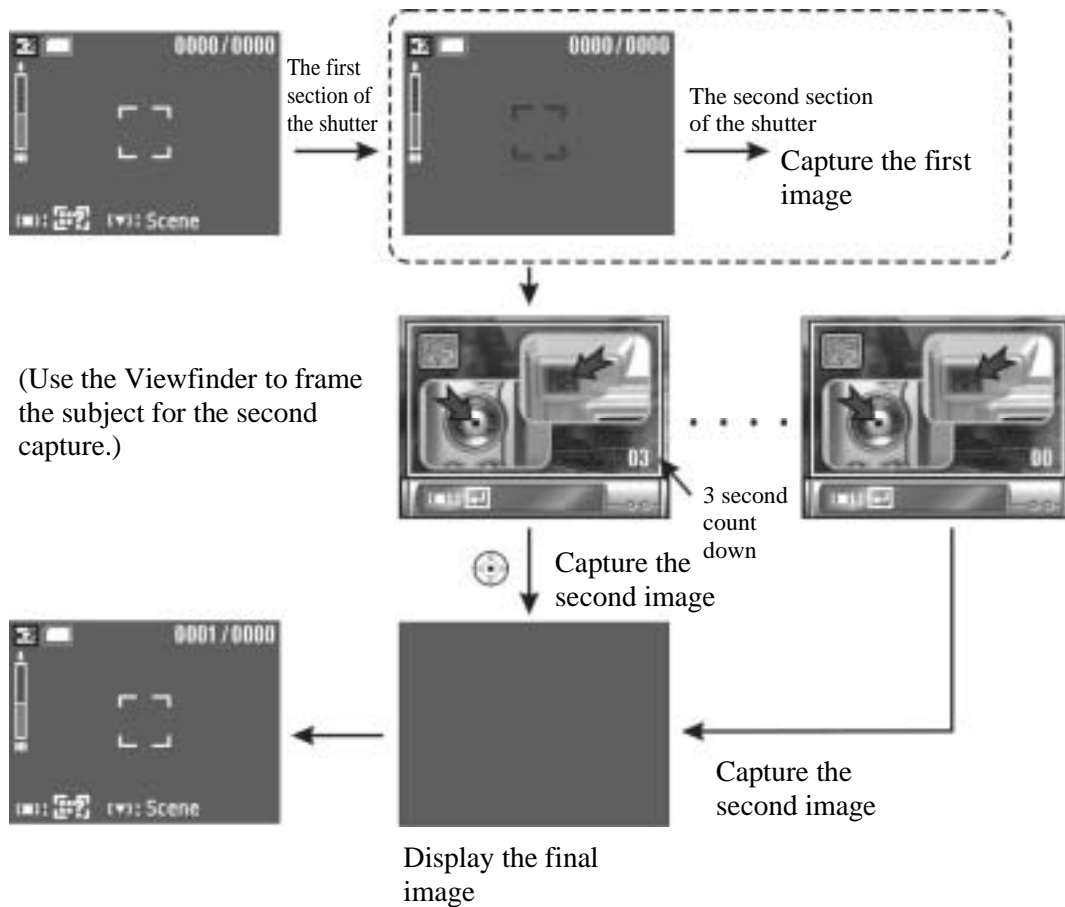
-  Party: For parties indoors.
-  Night Portrait: For taking pictures of people at night. A slower shutter speed is used. To avoid blurred pictures, use a tripod.
-  Night Landscape: For taking pictures of landscapes at night. A slower shutter speed is used. To avoid blurred pictures, use a tripod.
-  Beach: For shooting beach scenes. This enables to you to accurately capture the color of the water.
-  Sunset: For sunrises, sunsets, or rosy clouds at sunset.
-  Multiple Exposure: For scenes that requires two exposures to create a mix effect. Capturing the first

subject is the same as general photography. But in the second photo, the button should be pressed within 3 seconds (otherwise the camera shoots automatically as soon as the timer counts down to zero).



-  Fireworks: For taking pictures of fireworks at night. Focus is set at a distance with a slower shutter speed. To avoid blurred images, use a tripod.
-  Copy: For duplicating images.
-  Backlight: For taking pictures of subjects with bright light behind them.
-  Sports: For capturing subjects that are in motion. A fast shutter speed is used, so use this scene under ample lighting.

# Photo Mode (Continued)



**The Close-Up function will not operate in these scenes: Landscape, Night Landscape, Beach, Sunset, and Fireworks.**





## Description on Menu

Use Menu button  to display/hide the menu. Here are the descriptions:

### Image Resolution

Four resolution options are available for taking still images, including VGA, 3MP, 5MP, and 8MP. Pictures with higher resolution can be printed clearly, but consume more memory and take longer to write to memory. The resolution of 8MP applies to firmware interpolation, and is not recommended for pictures that require high detail.

### Picture Quality

Three picture quality options are available: Best , Standard , and Basic . The difference is the picture compression ratio. For example,  has the highest compression ratio. It takes up the least memory, but it has the lowest picture quality.

### Photo Mode

Photo Mode includes Auto , Manual , and Scene .

### Auto

### Manual

### White Balance

Have you ever wondered why pictures taken indoors sometimes come out looking yellow? The reason is that different lighting sources produce different colors of light (a flash bulb produces a very white light, while a 100 watt incandescent bulb produces a very yellow-looking light). Our brain automatically adjusts the color so that a white object always appears white regardless of the lighting condition, but a photograph records the true color. To compensate for this, the DXG-502 can shift the RGB color balance of the ambient light so that the color in the photograph appears as it should. This process is referred to as “matching the white balance”.

**The Manual Mode offers five settings of White Balance.**



Auto: Automatically matches White Balance; suitable for general picture taking.



Daylight: For taking pictures outdoors in natural lighting.

# Photo Mode (Continued)



Tungsten: For taking pictures indoors under incandescent lighting.





Fluorescent: For taking pictures indoors under fluorescent lighting.



Cloudy Day: For taking pictures outdoors on a cloudy day.

## ● EV Compensation

The Exposure Value (EV) compensation can be adjusted automatically  , or manually  in 20 levels from -2.0EV to +2.0EV. All things being equal, the higher the EV compensation, the brighter the photos.

## ● Metering Mode

Four Metering Modes are available, as below:

### ⊙ Matrix Metering

Matrix Metering divides the viewfinder into several zones to make an ideal exposure value.

### ⊙ Center-Weighted Metering

This uses the entire image area but calculates the exposure by giving more importance to the center of the image. This mode is best for portrait photography.

### ⊙ Spot Metering

This measures a spot in the center, which is about 1/25<sup>th</sup> of the viewfinder's area to determine the exposure of the entire image. Spot Metering is suitable for extremely bright and dark backgrounds.

### ⊙ Auto Focus Metering

This metering technique is applied to the current focus zone.

## ■ ISO

ISO is the speed of the camera's response to light. Use a higher ISO setting in low light scenes. Four options are available: Auto, 100, 200 and 400. NOTE: Higher ISO setting may cause "noise" in pictures.

## ■ Scene Mode

Twelve built-in scenes are offered in the Scene Mode. Different settings on White Balance, Exposure Compensation, Metering, and other functions are set at default values and cannot be adjusted. Choose the scene according to your preference.

## ■ Effects

This camera offers three default effect settings, allowing users to apply effects in the Manual, Auto and Scene Mode. These are three default settings:

# Photo Mode (Continued)

## Off

Choose "OFF" to close all effect functions.

## Black and White

This option is for black-and-white pictures.

## Vivid

Choose this to stress the contrast between colors and saturation, making pictures look more colorful.

## Sepia

This effect makes pictures have an antique look.

## Advanced Settings

## Self Timer

Choose this function to set the Self-Portrait and the countdown time, from 2 sec to 10 sec. (The default value is 10 sec.)

## Burst (Number of Pictures in succession)

Choose this to set the Burst Mode and number of pictures taken in succession, from 3 to 5 pictures. (The default value is 5.)

## Self Portrait Flash Unit

Use this to set the Self Portrait mode and the front light effect, which has three modes available.

## Sound Effect of Shutter

Use this to set the sound effect when the shutter is pressed. Fours options are available, including OFF, default sound effect 1, default sound effect 2, and default sound effect 3.

# Photo Mode (Continued)

## Menu Index

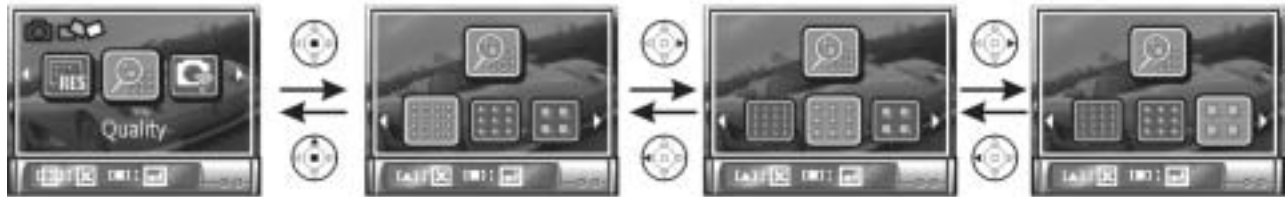

**Record Mode**





# Photo Mode (Continued)

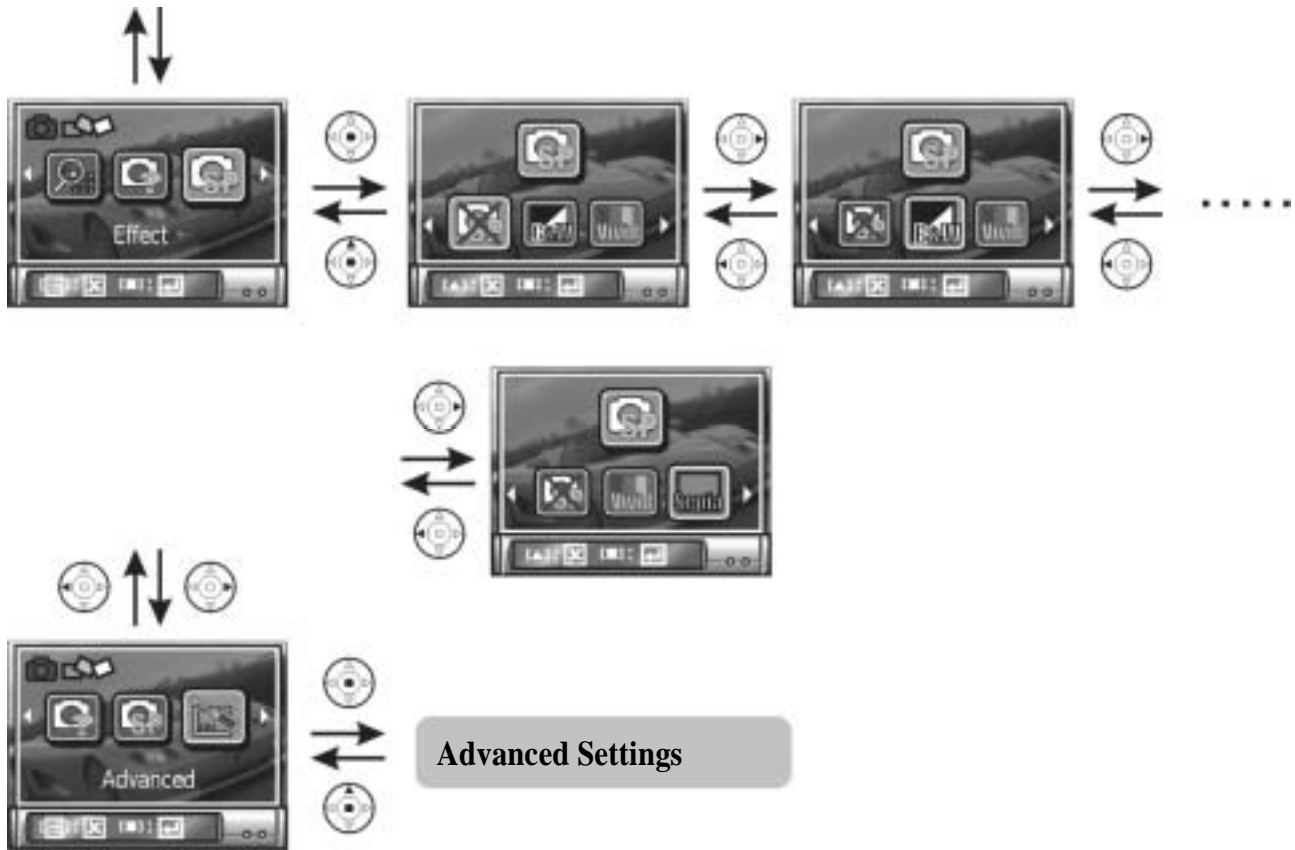

# Photo Mode (Continued)

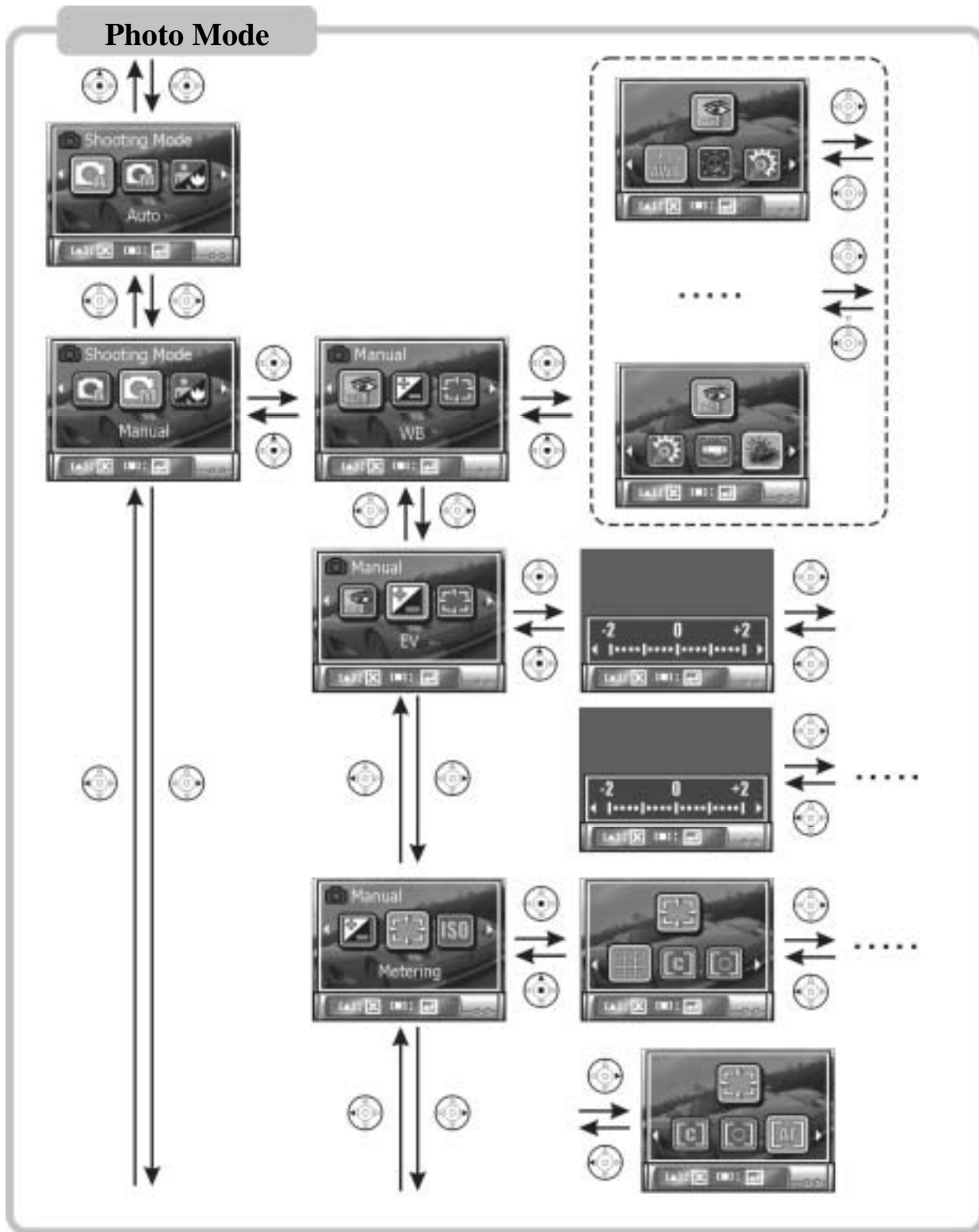

# Photo Mode (Continued)

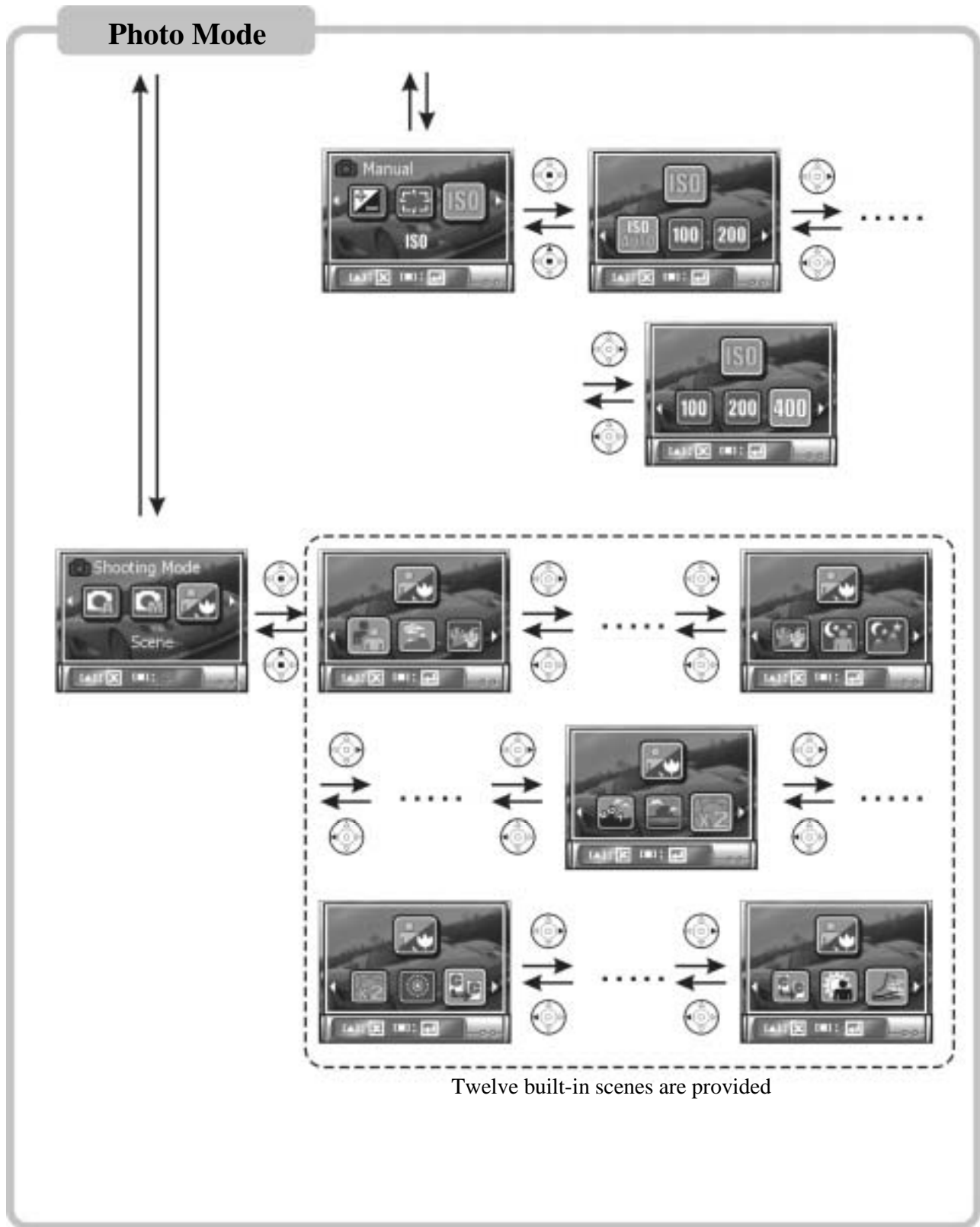

Twelve built-in scenes are provided

# Photo Mode (Continued)

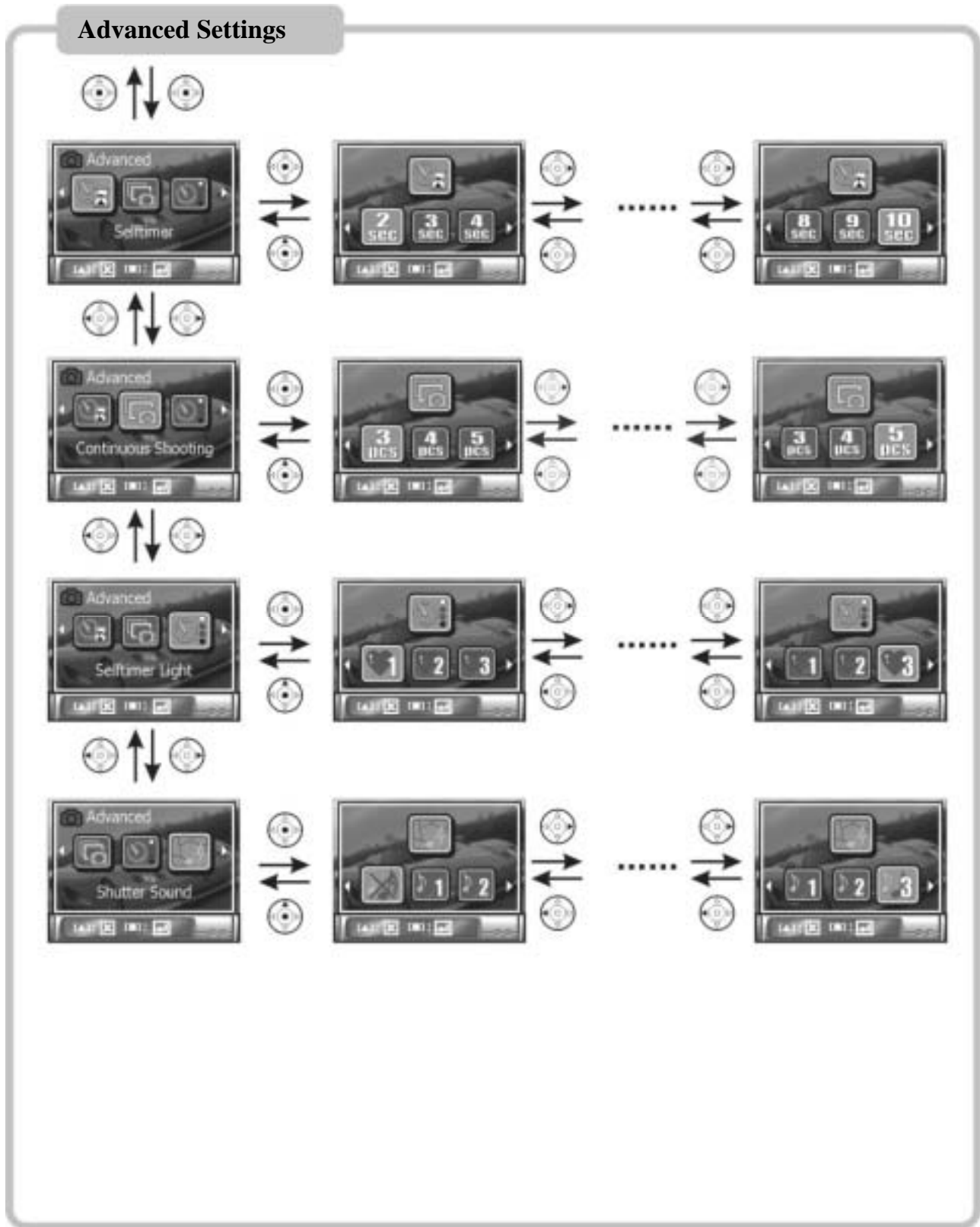

# Video Mode

Use the Mode dial to switch to the Video (📹) Mode.

## Icon Description

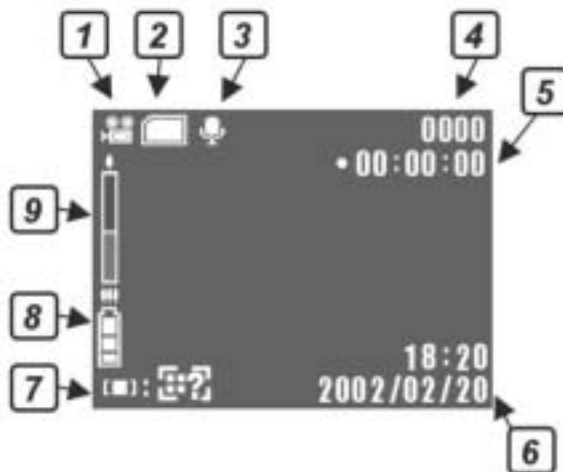

- 1** Video Mode
- 2** Status of Memory Card
- 3** Audio Recording Status
- 4** Number of Videos Recorded
- 5** Time of Video Recorded
- 6** Time and Date (This icon disappears 5 seconds after entering the mode.)
- 7** Info
- 8** Battery Info
- 9** Optical Zoom / Digital Zoom

## Recording Videos

You can use the DXG-502 to record a video with MPEG-4 format, and use the upper microphone to record the audio. (The audio recording function can be turned off.)

The length of video recording is subject to the memory capacity, as well as the image resolution and quality; Video clips with higher resolution and quality will take up more memory.

# Video Mode (Continued)

Follow these steps to record a video.

- 1 Turn on the camera and set up the date and time (Please refer to Date and Time Set).
- 2 Use the Mode dial to switch to Video () Mode, the icon is shown on the screen. Set the image resolution and picture quality according to your needs.
- 3 Frame the view you want to record on the screen. Press the Shutter button to start. The length of video recording time appears on the upper right of the screen, and a lower-right icon begins rotating.
- 4 The Zoom button is disabled during video recording. Use the zoom button to adjust the lens before pressing the Shutter button.
- 5 Press the Shutter button again to stop video recording.
- 6 If you want to review the video, check the Review Mode (Please refer to Review Mode).







**The zoom button is disabled during video recording. Use the zoom button to adjust the lens *before* pressing the Shutter button.**

## Descriptions on Menu

Use the Menu button  to display/hide the menu. The following are descriptions:

### Image Resolution

Three picture quality options are available: Best , Standard , and Basic . The difference is the video compression ratio. For example,  has the highest compression ratio. It takes up the least memory, but has the lowest picture quality.

### White Balance

Please refer to White Balance in the manual for details on White Balance.



Auto: Automatic correction of White Balance; ideal for general photography.



Indoor: Ideal for pictures indoors.



Outdoor: Ideal for pictures outdoors (in natural light).

### Record

This switches the microphone  (On) or  (Off).

# Video Mode (Continued)

## Menu Index

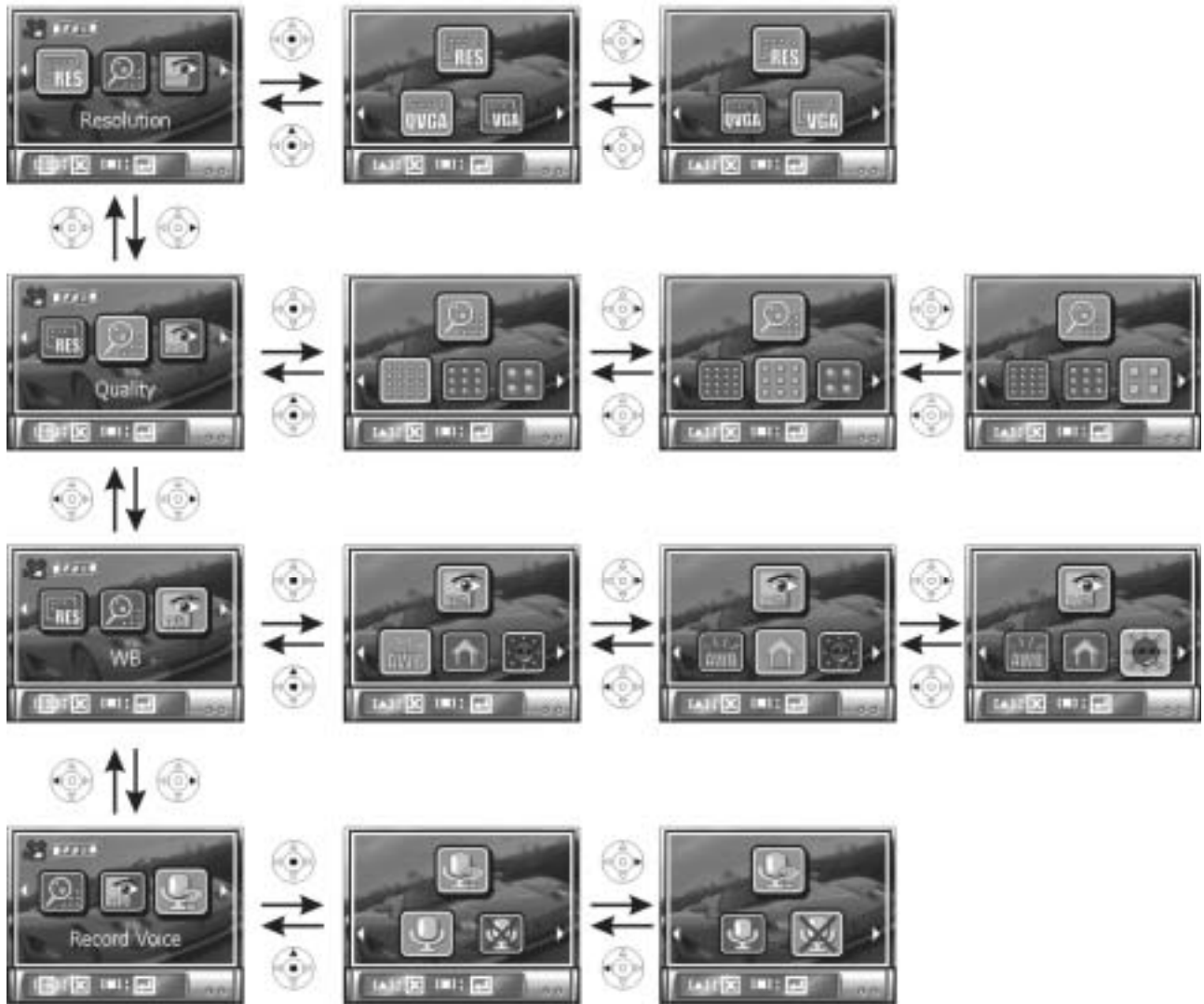

# Review Mode

Use the Mode dial to switch to Review Mode 

View pictures and videos in the Review Mode. Icons on the screen and functions vary depending on the file format.

## Picture

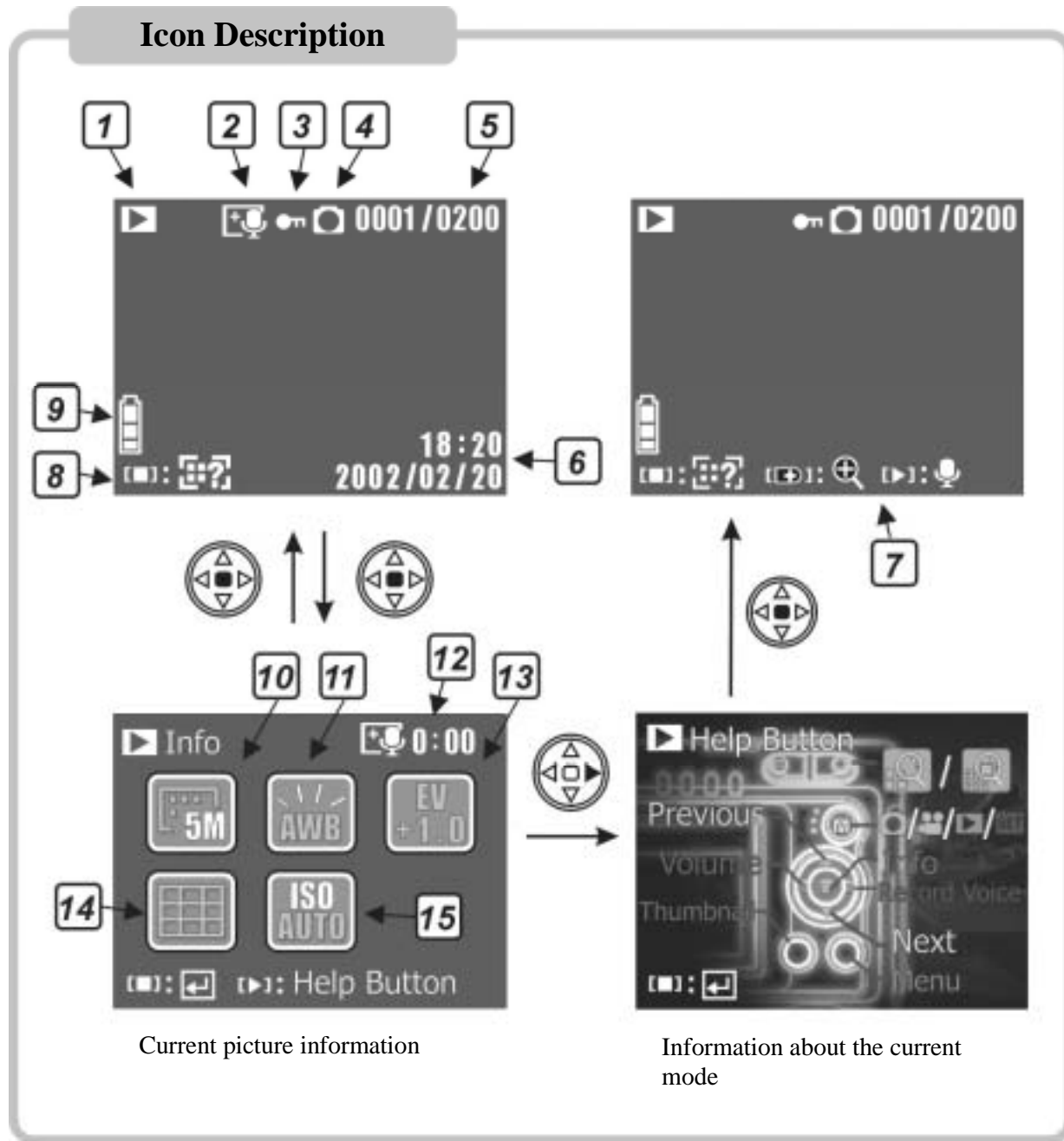



## Review Mode (Continued)

- 1 Review Mode
- 2 Picture with audio record (refer to the audio recording).
- 3 Protect Mode
- 4 Current file format (Picture)
- 5 Current file index/Total file number
- 6 Date and Time (in five seconds after entering this mode, changes to 7)
- 7 Magnification Mode/Recording
- 8 Info
- 9 Battery Info
- 10 Image resolution for photos
- 11 White Balance for photos
- 12 The picture contains audio recording time
- 13 Exposure compensation in photos
- 14 Metering mode in picture taking
- 15 ISO in photos



**Where there is no file stored in the memory, a “No File” message will appear on the screen, and you cannot access the selection menu.**

# Review Mode (Continued)

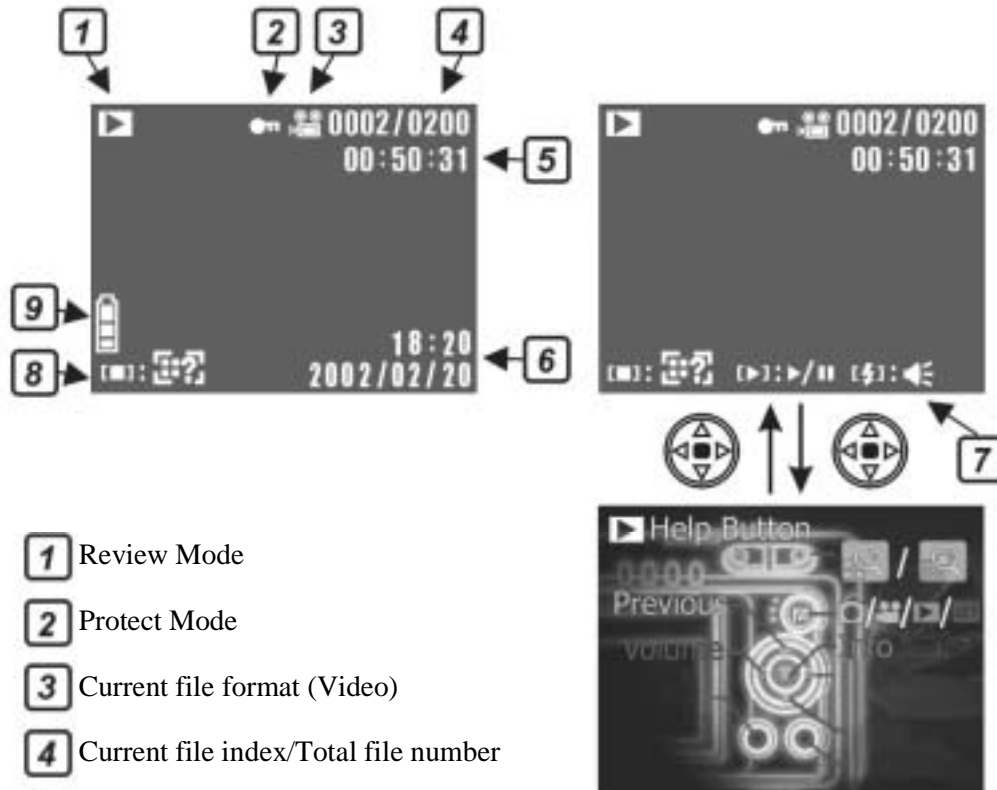

## Video

### Icon Description



- 1 Review Mode
- 2 Protect Mode
- 3 Current file format (Video)
- 4 Current file index/Total file number
- 5 Video Recording Time
- 6 Date and Time (5seconds after entering this mode, this changes to 7)
- 7 Video Review/Volume Adjustment
- 8 Info
- 9 Battery Info



### Thumbnail Display

Use the  button to display thumbnails. Select a thumbnail picture (video) and press the  button to display that picture (video) in full size.

## Review Mode (Continued)











## Playing Video

Select the video and press the  button to play the video. To pause, press the  button again. Press the  button to stop during playback.



## Picture Magnification Mode

When selecting a picture file, press the  button to enter the Picture Magnification Mode. In the Magnification Mode, press the  /  buttons to zoom in/out the picture. The magnification value is displayed on the upper left. You can also use the     buttons to navigate and zoom into different parts of the picture.

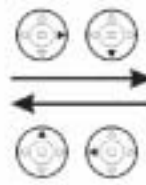
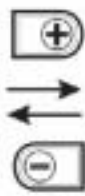

The maximum magnification value depends on the image resolution of the picture. Pictures with higher resolution can have a larger magnification value. To exit the Magnification Mode, press the  button.

# Review Mode (Continued)



The red framing mark becomes smaller when increasing the magnification value.

## Audio Record

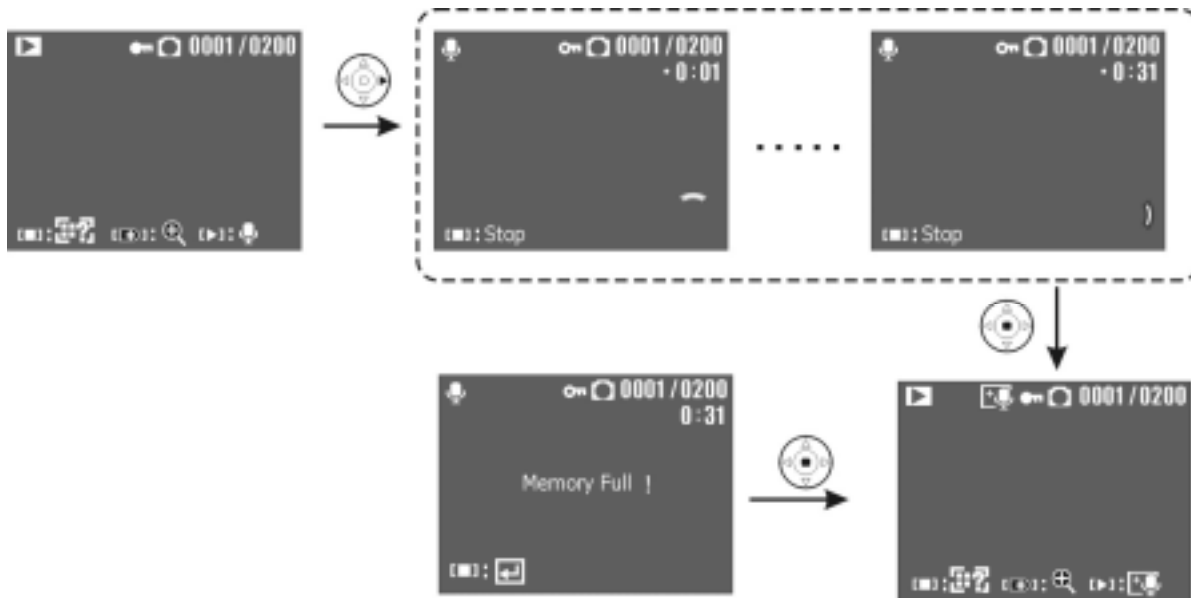

When selecting a picture file, press the  button to record the audio record of the picture. Press the  button to stop recording.



When the memory is full, the text blinks and the camera stops recording.

# Review Mode (Continued)

## Playing/Deleting the Audio Record

If the selected picture has an audio record, the  icon will be shown above the picture. Press the  button to enter the mode of playing/deleting the audio record and follow the directions below.

### Playing the Audio Record

Press the  button to play the audio file in the Play/Delete Mode, the audio recording time is shown on the upper right of the screen. To stop playing, press  button.

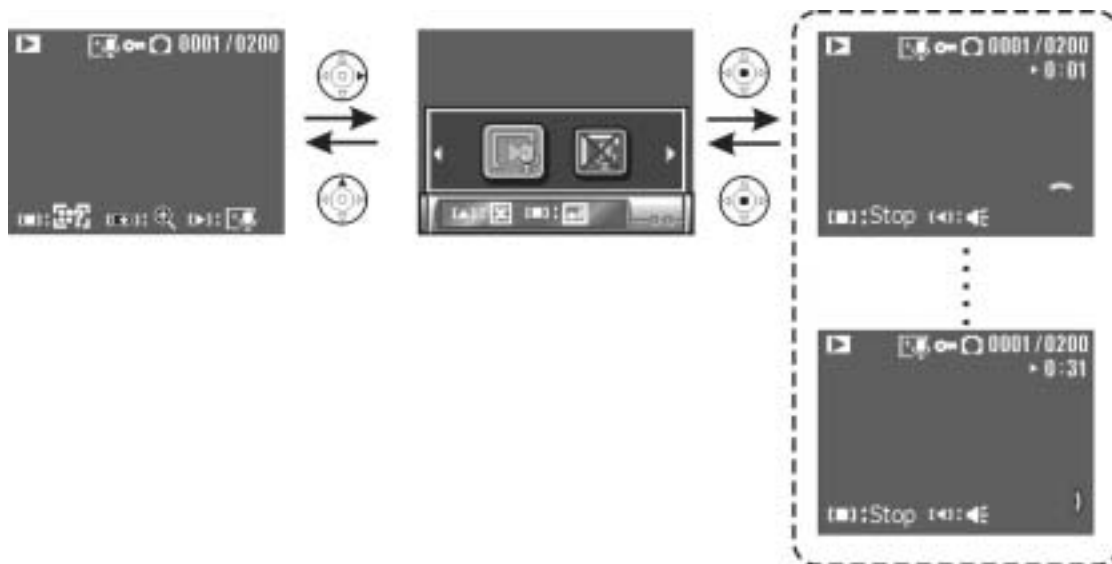

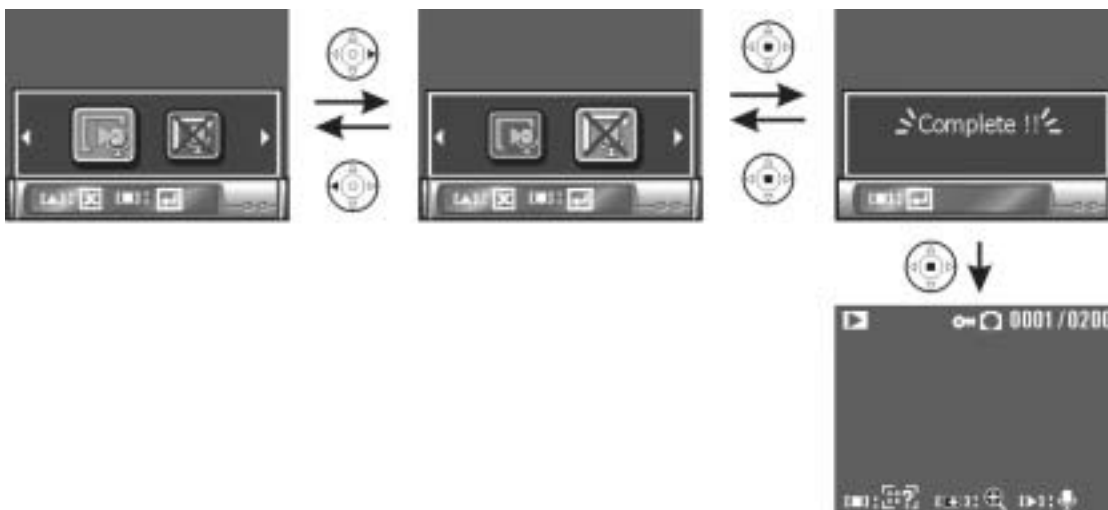

### Deleting the Audio Record

In the Play/Delete Mode, you can delete the audio records of pictures. Press the  button to delete the audio record and record another one with the picture. NOTE: the record can not be restored once deleted.



# Review Mode (Continued)

## Adjusting Volume

When selecting video clips or picture with an audio record, press the  button to adjust the volume, either before or during playback. Press the  or  buttons to adjust the volume; the lowest volume is mute.

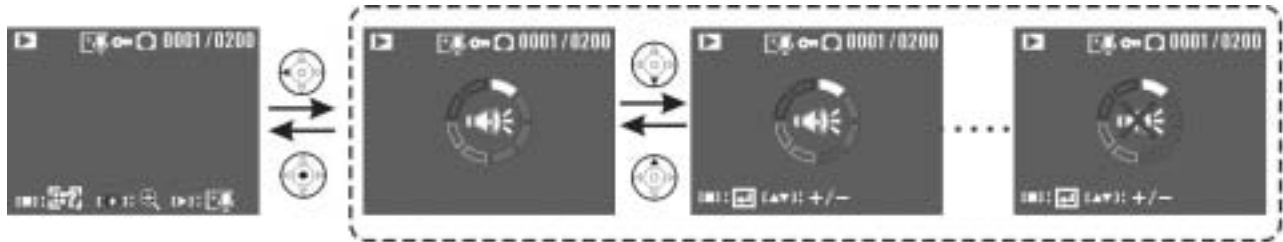

Before playing audio record

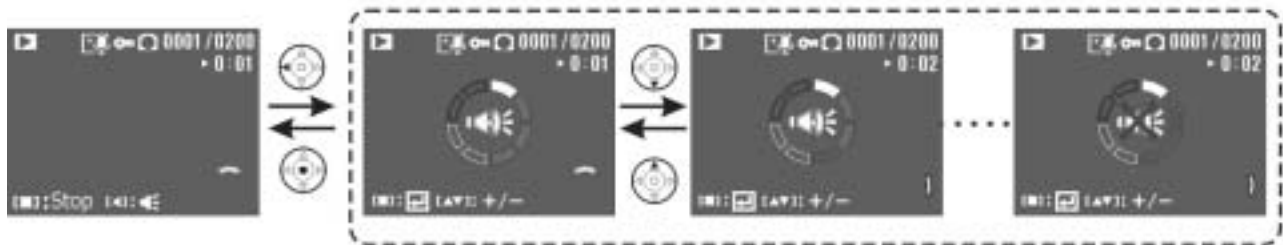

Playing audio record

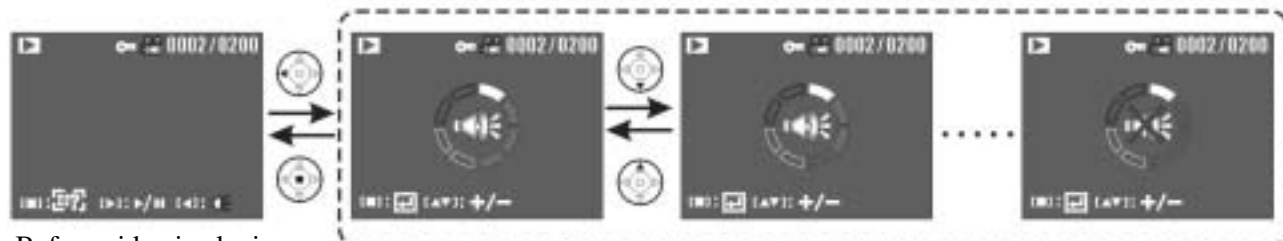

Before video is playing

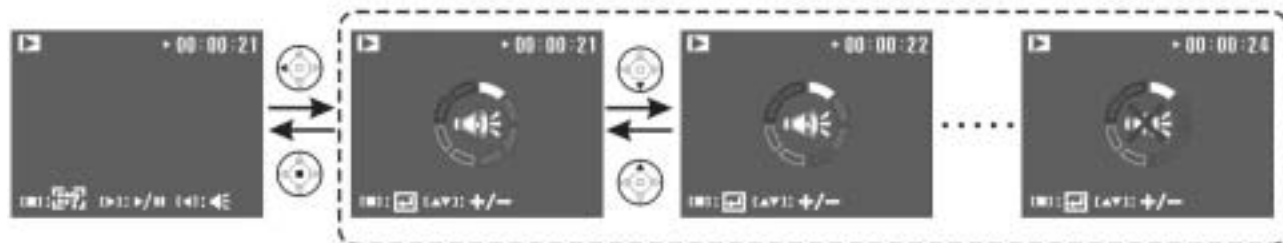

While video is playing

# Review Mode (Continued)

## Description on Menu

Use the Menu button  to display/hide the menu. The following are descriptions:

### ■ Deletion

#### ■ Delete One

This deletes the unwanted files from the memory card. NOTE: The file can not be restored once deleted.

#### ■ Delete All

This deletes all files from the memory card. NOTE: The file can not be restored once deleted.

### ■ Single Protection

### ■ Single Protection Remove

Important pictures/videos can be protected. Protected pictures and videos cannot be deleted without first removing the protection. Protected pictures or videos include the  icon on the screen, including two sub-options (this differs on whether the file has been selected for protection), as shown below:

Single Protection (when the selected file has not been set for protection)

Single Protection Remove (when the selected file is set for protection)

To return to the menu, select  and press  button.



Press the  button to exit the menu under any selection.

### ■ All Protection/Remove Protection

#### ■ All Protection

All the pictures/videos on the memory card can be set for protection.

#### ■ Remove All Protection

Removes the protection from all of the pictures/videos on the memory card.

### ■ Slide Show

The Slide Show can display all the pictures (not including the movie and audio files).

### ■ Starting the Slide Show



# Review Mode (Continued)

Starting the Slide Show. To cancel the Slide Show, press the  button.

## Display Interval

Select the slide show display interval from 1 to 10 seconds.





## Repeating the Slide Show

Choose to repeat the Slide Show, with two options:  (Repeat) and  (No Repeat).

## DPOF (Digital Print Order Format)

This setting stores the digital printing commands in the picture files. Users can directly print the pictures by inserting the memory card into any DPOF compatible printer.

## Setting Single

Sets the printing number of every single picture. Use / to increase/decrease the printing number, / to select the previous/next picture, and the  button to set/cancel the date stamp on pictures.





## Setting All

Sets an equal printing number for all of the pictures and whether the date stamp is printed or not. The operation is the same as that of setting a single picture.





## Direct Printing

This setting enables a direct print out of your pictures by connecting the camera with a printer through the USB cable (The printer must support the Direct Printing function).





## Printing a Single Picture

For printing one selected picture only. Use / to select the previous/next picture and the  button to set/cancel the printing of the date stamp. After making sure every thing is set, press the  button to start printing.

## Printing All Pictures

Print all the pictures. Use / to increase/decrease the printing number and / button to select the date stamp option. When everything is set, press the  button to start printing.

## Paper Size

Set the printing paper size; there are five built-in sizes:     



# Review Mode (Continued)

## Menu Index



**Deletion**



If the selected file has been set for protection, it shows...



**Single Protection  
(Single Protection  
Remove )**



**All Protection/  
Remove  
Protection**



**Slide Show**



**DPOF**



**Direct Printing**

# Review Mode (Continued)

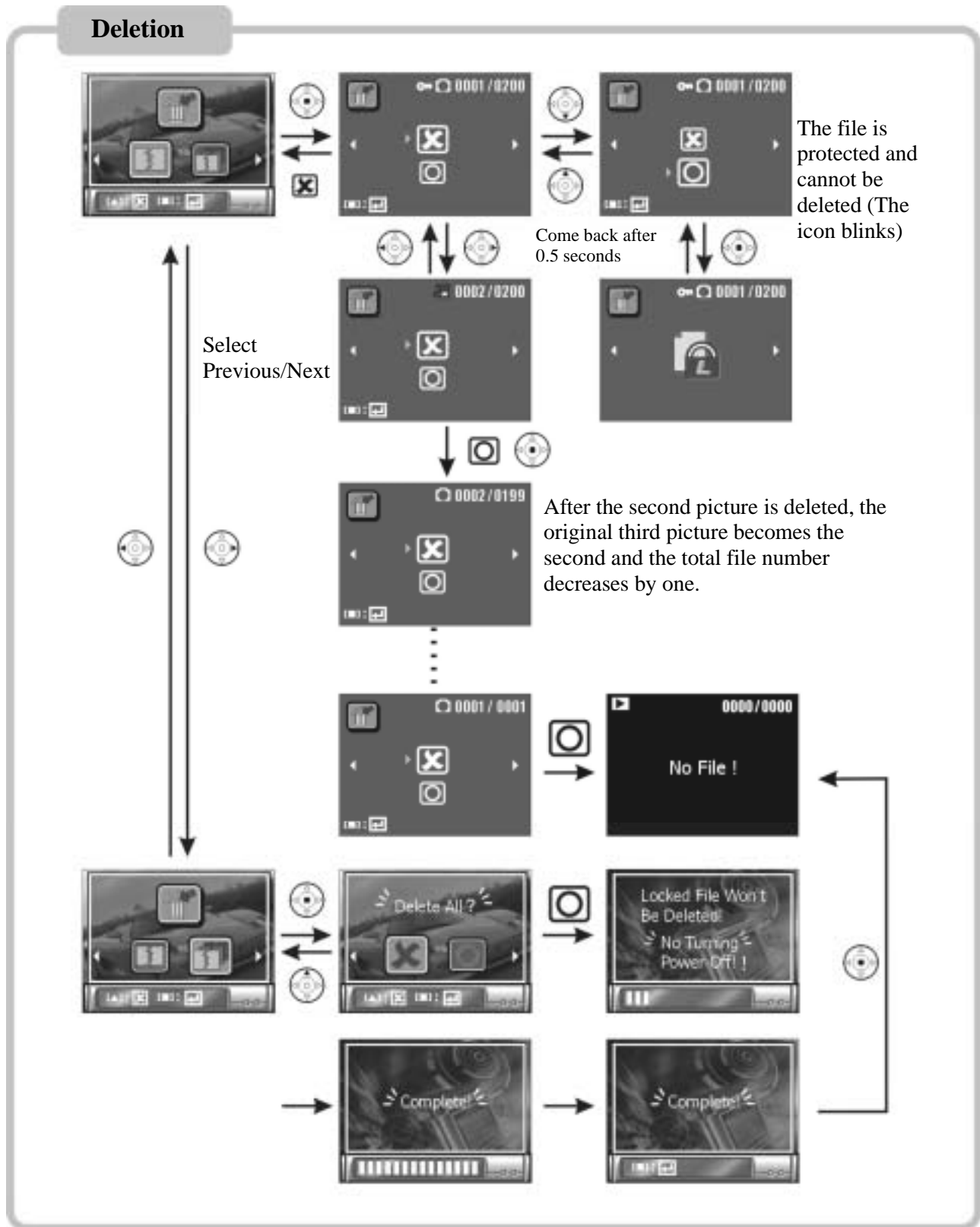

# Review Mode (Continued)

## Single Protection (Single Protection Remove)

Displays this message if the protection of a single file is removed.

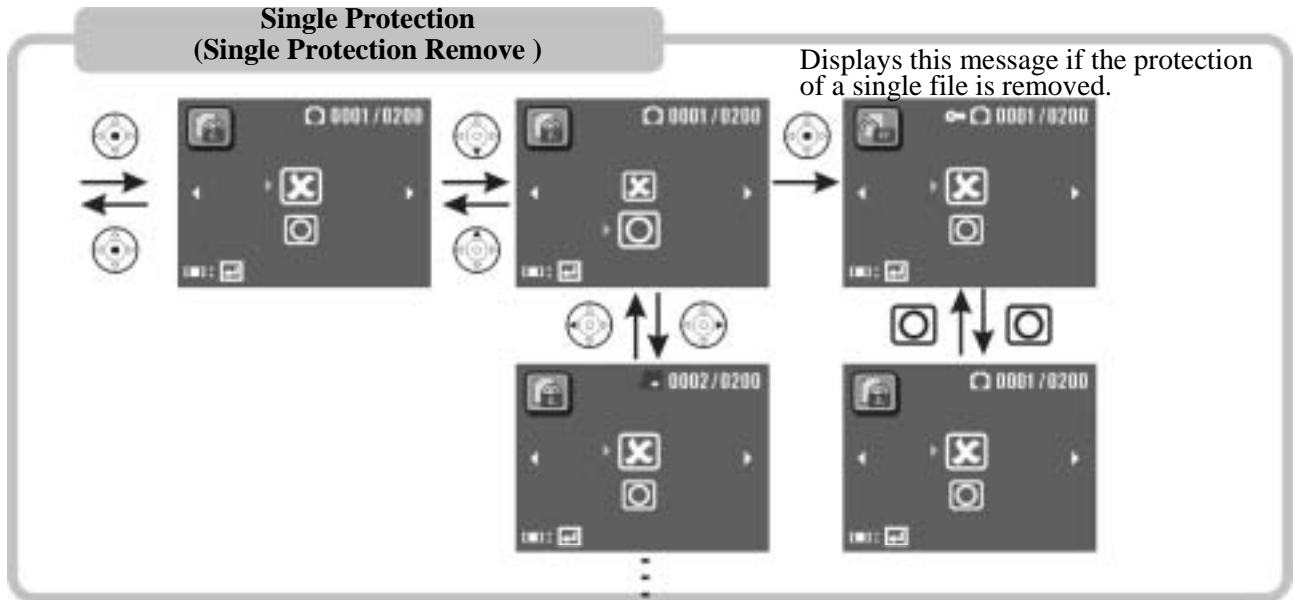

## All Protection/Remove Protection

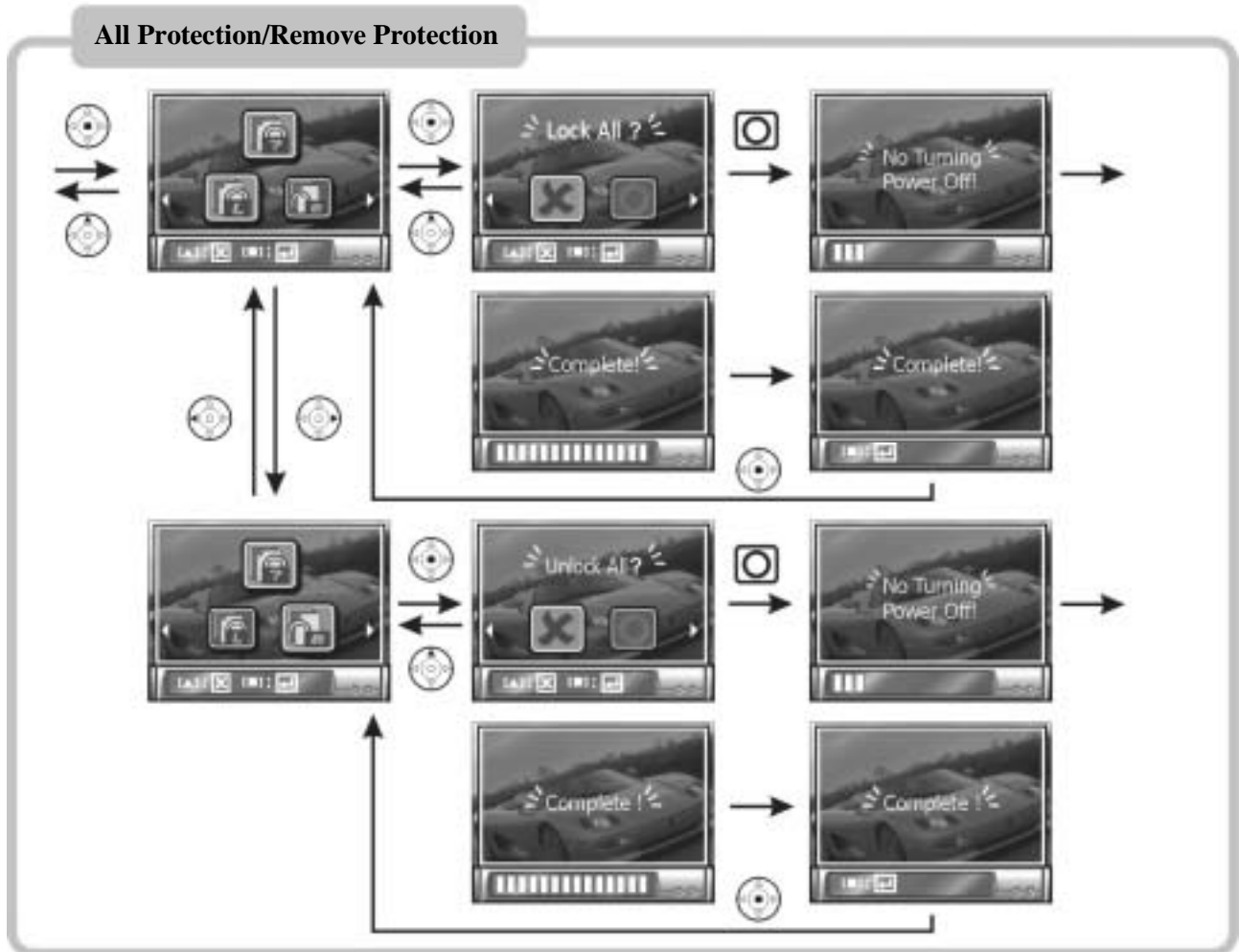

# Review Mode (Continued)

## Slide Show

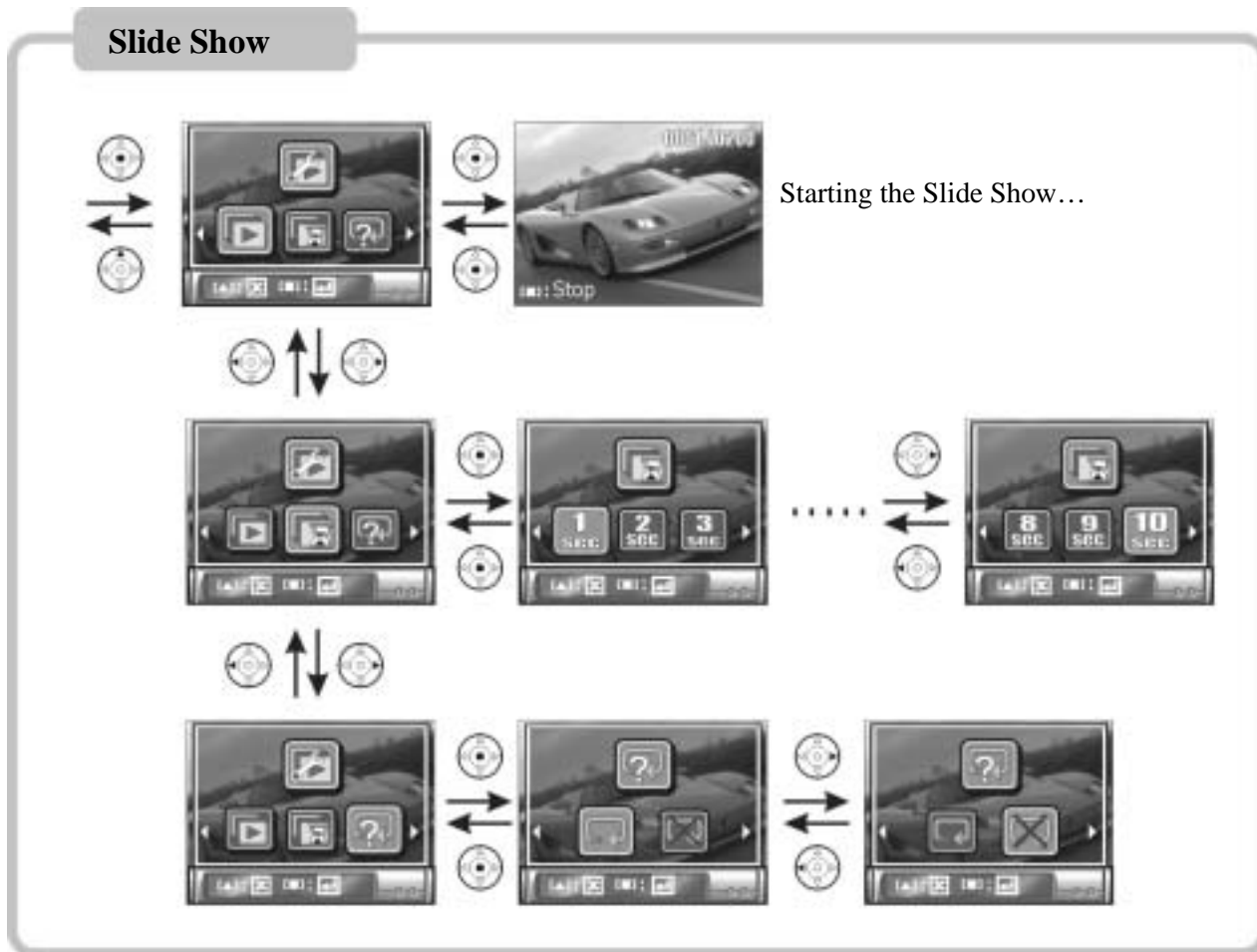

This message appears when entering the Slide Show, DPOF, Direct Printing Mode with only videos but no pictures on the memory card.

# Review Mode (Continued)

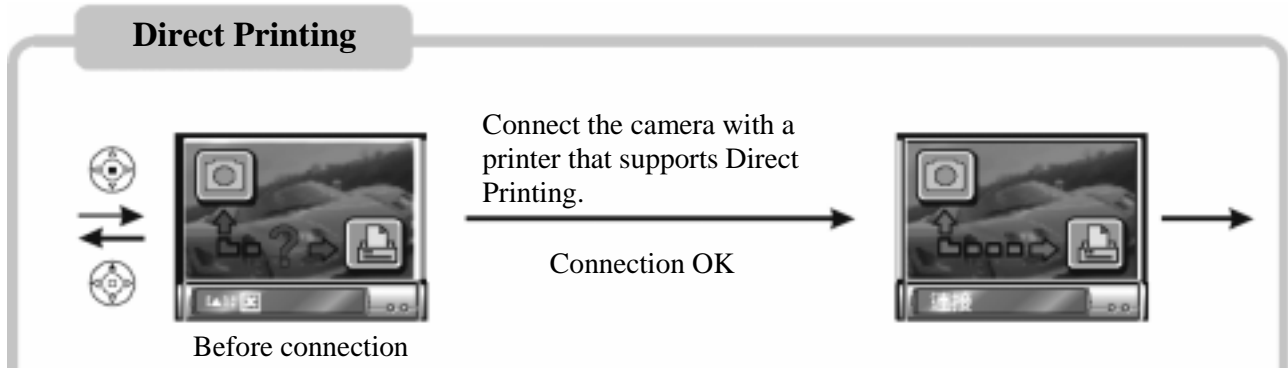
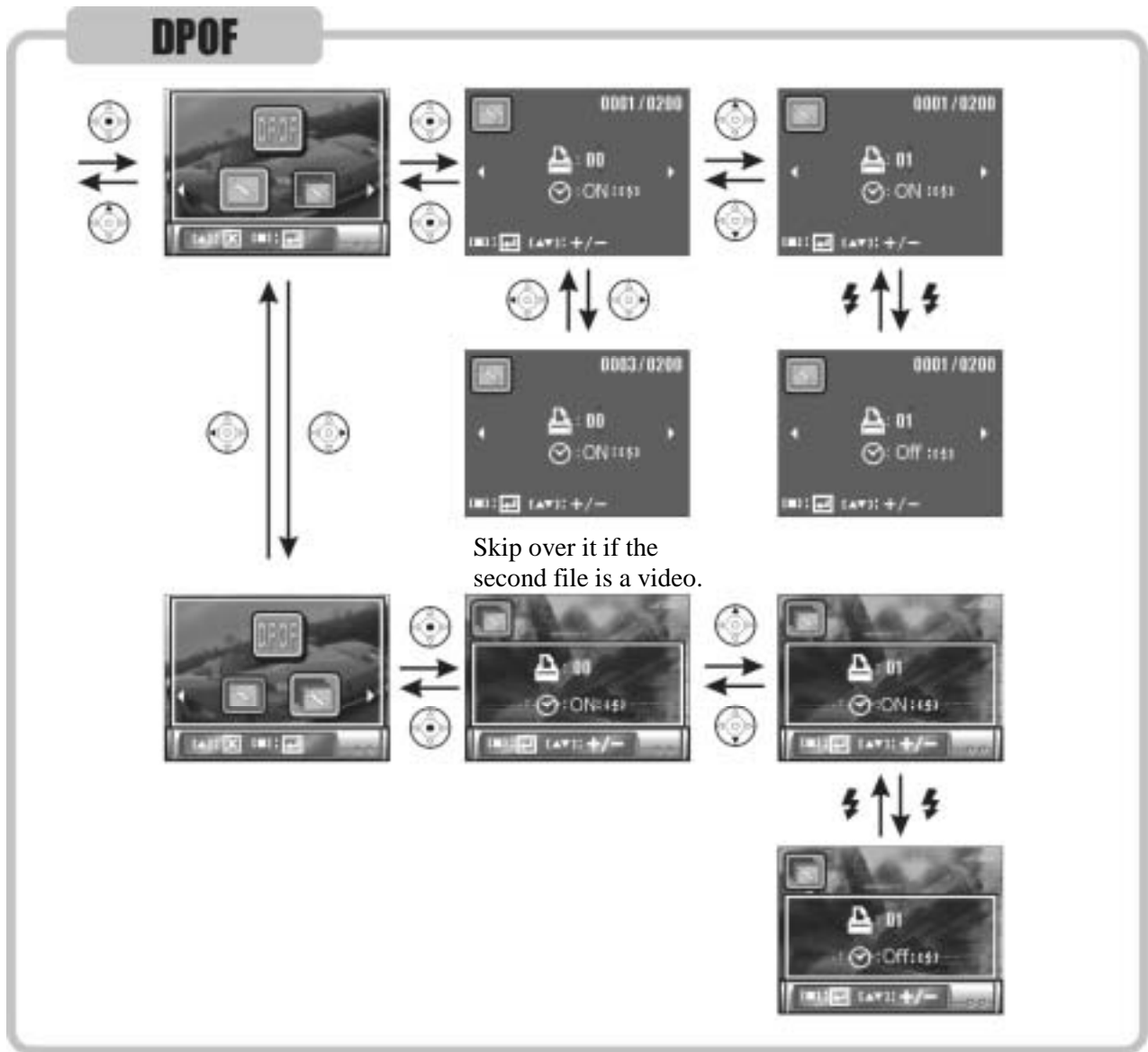

# Review Mode (Continued)

↓ The following options show up only when the printer supports these functions.

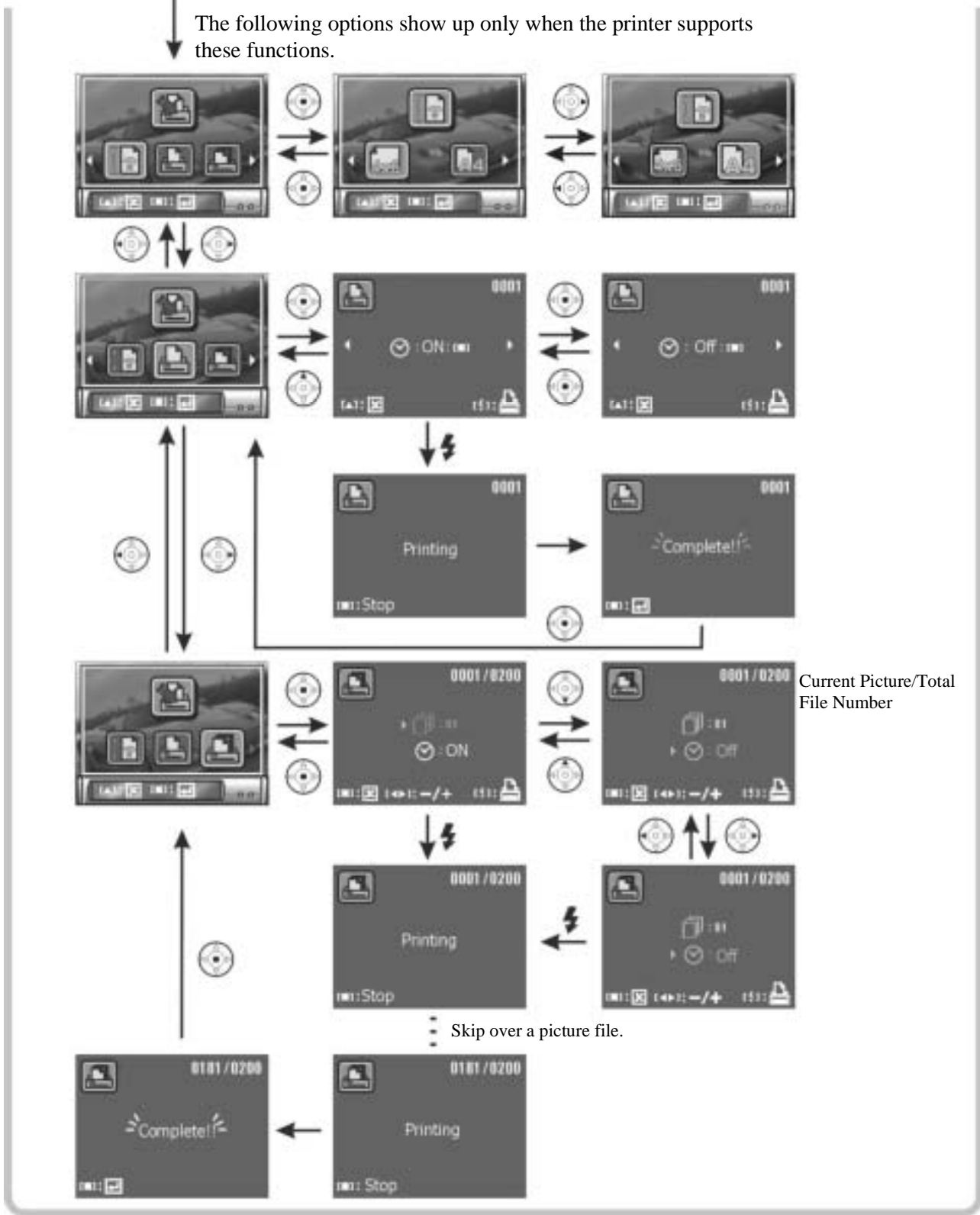

# Review Mode (Continued)

## Printing Notices



If you plug the USB cable into other device instead of a printer in the Direct Printing Mode, disconnect the USB cable and restart the camera.

If the screen displays one of the following messages, there might be a problem with the printer. Examine the printer status. Often the problems are the result of the printer being:

Out of Paper

Out of Ink

Using Mismatched Paper Size

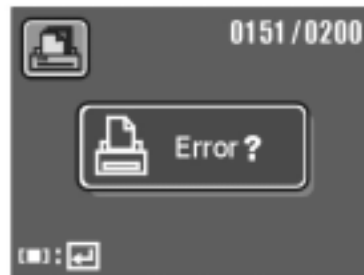

For other un-correctable printer errors, please contact the printer manufacturer.

# PC Mode

Switch from any mode to PC Mode by plugging the USB cable into the USB port on the camera.

Plug in the USB cable  
(connecting the camera  
with your computer)



## Removable HDD (Hard Drive)

The camera memory card can be used as a removable HDD. After making a connection, transfer the data from the memory card to your PC or from the PC to the memory card.

When the camera screen goes dark, you can operate directly from the PC. Once the USB connection is removed, restart the camera to resume operation.



When memory card is inserted, all of the operations will be based on the data on the memory card. If you want to use the internal memory, simply remove the memory card.



# PC Mode (Continued)

## Data

Find the DCIM folder in the memory card of the camera from a PC. The data structure is as follows:

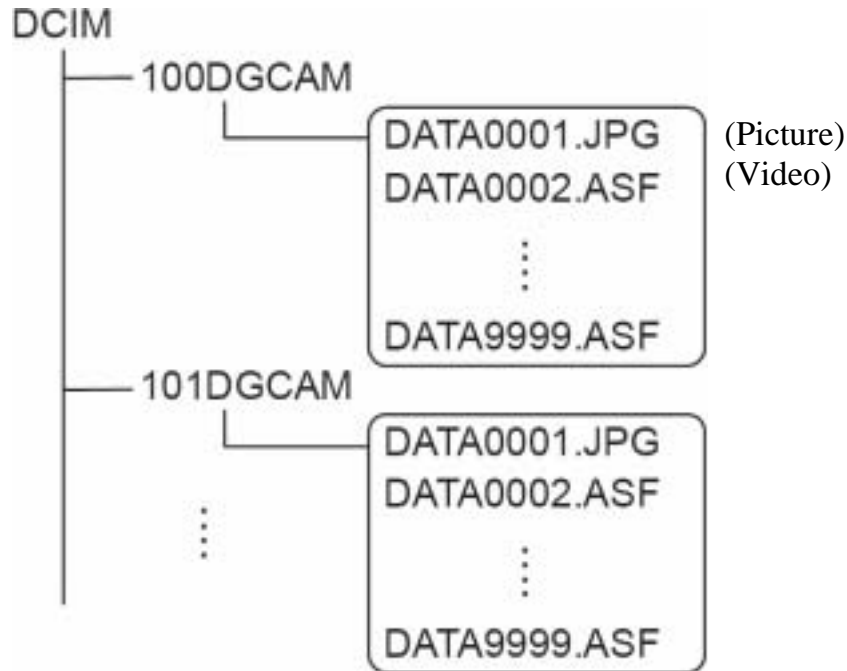

When files in the 100DGCAM folder reach DATA9999, the camera will automatically make a new folder named 101DGCAM, where new pictures, videos, and audio files will be saved. When the file index reaches 9999 again, it will repeat this process again.





If the upload file cannot be opened, the file format is probably not compatible with the camera.

# Video Out

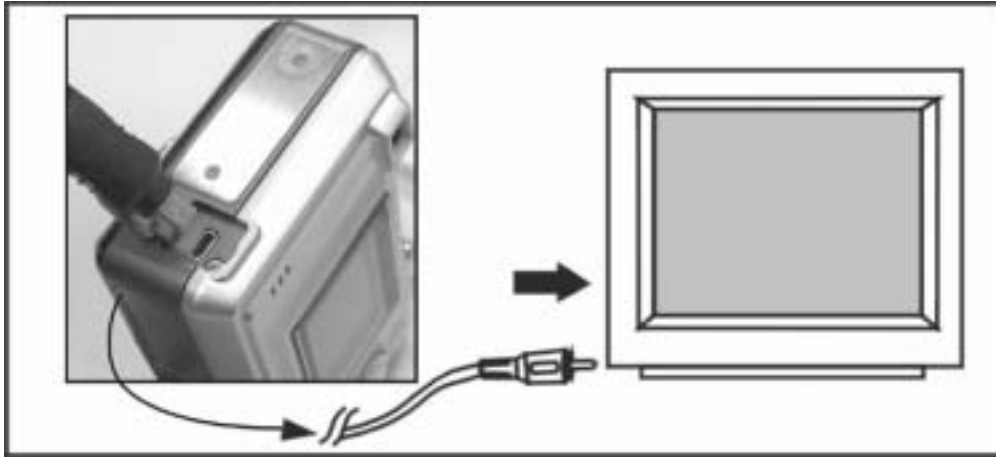
Use the TV-Out function provided by the camera to transfer the images to a television.



**Please follow these steps:**

- 1** Before getting started, set the Video Out setting to either NTSC or PAL, according to your regional setting (The United States uses NTSC). Please refer to the Setup Mode/Video Out.
- 2** Use the video cable provided to connect the camera with the television. Switch to the Setup Mode, enter  under  (Display) and press the  button. When the camera LCD turns off; the television will receive the data and display the images. You can then use the camera as usual.
- 3** Remember to switch the display back to the camera screen before disconnecting the video cable, or the camera screen will remain off.



Because of different TV formats, it is normal for pictures to be cropped when displayed on the television screen.

# Installing the Software

## Installing the Software on a PC

You can use and operate the “storage device” and “video device” provided by the camera through a PC. Before operation, follow the instructions below to install the software drivers.

1. Insert the Software CD supplied by the package into the CD-ROM drive.
2. The Auto-run program will be executed and the welcome screen will appear with the following message: (If your CD-ROM drive doesn't support the auto-run function, please double click on the "My Computer" icon on the desktop. Then double click the CD-ROM drive icon and click the "Driversetup\Setup.exe" file in the root directory.)
3. Select the desired language of setup program you wish to install.
4. Click on "Driver > Install", and the following screen will appear:



5. Select the desired language, and then press "OK".



# Installing the Software (Continued)

6. Click "Next" to continue the setup program.

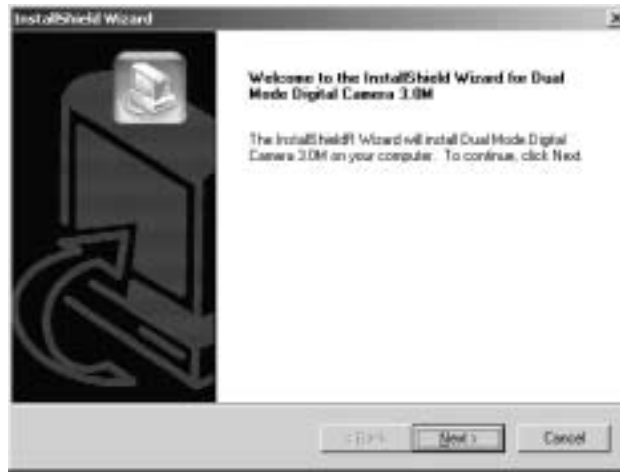

7. After the installation is completed, the following screen will appear. Click "Finish" to complete the application installation.



# Installing Application Programs

## Installing the Application Programs on a PC

Installing the **NewSoft** application programs (Take MP38 for example)

1. Insert the Software CD supplied by the package into the CD-ROM drive.
2. The Auto-run program will be executed and the welcome screen will appear the following message: (If your CD-ROM drive doesn't support the auto-run function, please double click on the "My Computer" icon on the desktop. Then double click the CD-ROM drive icon and click the "MP38\Setup.exe" file in the root directory.)
3. Select the desired language of setup program you want to install.
4. Click on the " **NewSoft Video works** > Install", the following screen will appear:



5. Select the desired language, and click "OK".



# Installing Application Programs (Continued)

- Click "Yes" to accept the conditions of the Legal Disclaimer and continue the installation.



- After entering the application setup screen, click "Next" to continue.



- Press "Yes" to accept the conditions of Software License Agreement and continue the installation.





# Installing Application Programs (Continued)

12. The following screen will appear. Click "Finish" to complete the application installation.

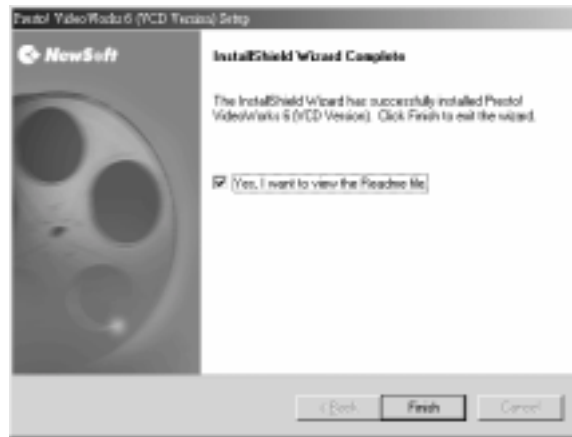

13. The Windows Media application has been installed successfully. Click "OK" to continue.



14. Go to DirectX9 for setting, and click "Set" after confirmation

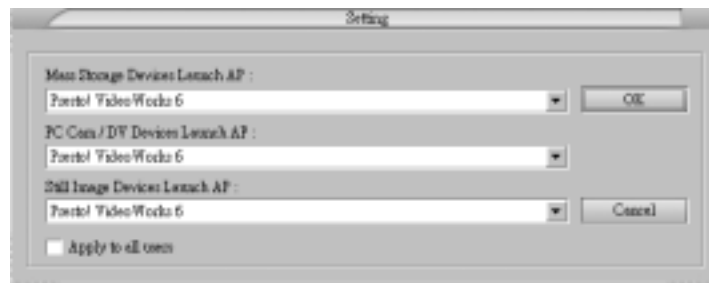



# Appendix

## Product Specifications

|                               |   |
|-------------------------------|---|
| <b>Image sensor</b>           | 1/2.5" CCD  |
| <b>Pixel</b>                  | 5.0 Megapixels  |
| <b>Lens</b>                   | W : F2.8            f=5.8mm<br>T : F4.8            f=17.4mm   |
| <b>Focus Distance</b>         | 4 to 20 inches (macro)<br>20 in. to infinity (people/landscape)                                     |
| <b>Shutter Speed</b>          | Mechanical shutter & Electrical shutter<br>(3 sec~1/2000 sec)                                       |
| <b>Display Screen</b>         | 1.5" LTPS full color LCD<br>(502 x 240 PIXELS)  |
| <b>Storage Media</b>          | Built-in 16MB FLASH MEMORY<br>SD card (MMC compatible), supports 16MB~512MB.                        |
| <b>Optical Zoom</b>           | 3X Optical Zoom   |
| <b>Digital Zoom</b>           | 4X Digital Zoom   |
| <b>Flash mode</b>             | Off/Forced Flash/Auto Flash plus Red Eye Reduction/Forced Flash<br>plus Red Eye Reduction/Slow Sync |
| <b>Flash Effective Range</b>  | 2 ~ 6 feet  |
| <b>Photo Mode</b>             | Auto/Manual/Scene   |
| <b>EV Compensation</b>        | -2.0EV~+2.0EV (20 options)  |
| <b>White Balance</b>          | Picture: Auto/Daylight/Tungsten/Cloudy/Fluorescent<br>Movie: Auto/Indoor/Outdoor                    |
| <b>Metering Mode</b>          | Matrix Metering/Center-Weighted Metering/Spot Metering/Auto<br>Focus Metering                       |
| <b>ISO</b>                    | Auto/100/200/400  |
| <b>Self Timer</b>             | 2~10 sec  |
| <b>Continuous Photography</b> | 3~5 pictures (5.0 Megapixels)   |
| <b>File Formats</b>           | Picture: JPEG(Exif2.2/DCF) Standard<br>Video: MPEG-4 with Sound                                     |

# Appendix (Continued)

**Picture Resolution**                      Picture: VGA, 3MP, 5MP, 8MP  
Video: VGA (640 x 480) (10fps)  
QVGA (320 x 240) (20fps)

**Picture Quality**                        Picture: Best/Standard/Basic  
Video: Best/Standard/Basic

**Interfaces**                                USB 2.0  
Video Output (NTSC/PAL Selectable)

**Languages**                                English/Traditional Chinese/Japanese/German/French/  
Italian/Spanish

**Auto Shut Down**                        30 sec / 1 min / 5 min / 10 min

**Power**                                        2X "AA" Ni-MH Rechargeable Batteries

**Dimensions**                                3.5" x 2.48" x 1.58"

**Weight**                                        <5.29 ounces (without batteries)

## System Requirements

Please refer to the minimum system requirements when operating the digital camera. Better computer equipment is strongly recommended for achieving better performance. The minimum system requirements are as follows:

**OS**    Windows® 98SE/Me/2000/XP  
**CPU**    Pentium® 166MHz or higher  
**Memory**                                        32 MB memory or more  
**CD-ROM**                                        4X and above  
**Hard Drive**                                    At least 20 MB free space (longer video requires more space).  
**Others**    One standard USB 1.1 port

## Free Manuals Download Website

<http://myh66.com>

<http://usermanuals.us>

<http://www.somanuals.com>

<http://www.4manuals.cc>

<http://www.manual-lib.com>

<http://www.404manual.com>

<http://www.luxmanual.com>

<http://aubethermostatmanual.com>

Golf course search by state

<http://golfingnear.com>

Email search by domain

<http://emailbydomain.com>

Auto manuals search

<http://auto.somanuals.com>

TV manuals search

<http://tv.somanuals.com>