

DXG-308
User's Manual



Table of Contents

Chapter 1 Attention

1-1 Safety Precautions	2
1-2 Before Using Your Camera	2
1-3 Operating Precautions.....	3
1-4 Package Contents	3

Chapter 2. Getting to Know Your Camera

2-1 Features Overview.....	4
2-2 Specifications.....	6
2-3 System Requirements.....	6

Chapter 3. Controls, Operation, and Display

3-1 LED Indicators.....	7
3-2 LCD Monitor Display.....	7
3-3 Power Supply.....	8
3-4 Shutter Button.....	8
3-5 Mode Dial.....	9
3-6 Multi-Select Button.....	9
3-7 Flash Button.....	9
3-8 Display Mode Button.....	9
3-9 Macro Switch.....	10

Chapter 4. Navigating Modes and Menus

4-1 Record Mode	11
4-2 Play Mode.....	12
4-3 Movie Mode	13
4-4 Setup Mode	13
4-5 Mode Selection	15

Chapter 5. Preparing Your Camera

5-1 Attaching the Strap.....	16
5-2 Loading Batteries.....	16
5-3 Loading and Removing the Memory Card.....	17
5-4 Setting Up the OSD Language.....	19
5-5 Setting Up the Date/Time.....	19

Chapter 6. Getting Started

6-1 Setup Mode.....	20
6-2 Record Mode.....	20
6-3 Play Mode.....	21
6-4 Movie Mode.....	21
6-5 PC Mode.....	22
6-6 TV-OUT Operation.....	22

Chapter 7. Driver Installation

7-1 Installing the Camera Driver for PC.....	23
7-2 Installing the Applications for PC.....	24

Chapter 8. File Transfers

8-1 How to Transfer Files.....	27
8-2 Mass Storage.....	27
8-3 Web Camera.....	27

Chapter 1 Attention

Please read through this manual carefully before using the camera and follow the instructions to avoid damage caused by improper operation.

1-1 Safety Precautions

- The software CD-ROM packaged with the camera is designed for PCs only. Using this CD-ROM on a stereo or CD player may cause damage to it.
- This camera is a precision electronic device. Do not attempt to service this camera yourself, as opening or removing covers may expose you to dangerous voltage points or other risks.
- Keep camera away from heat and direct sunlight to avoid fire risk.
- Be extra careful with the LCD liquid. If the LCD monitor is damaged please follow these procedures:
 - If the liquid contacts the skin: wipe the skin dry with a cloth and wash thoroughly with water.
 - If the liquid gets in the eye: rinse immediately with water for at least 15 minutes and then consult a physician to receive treatment as soon as possible.
 - If the liquid is accidentally swallowed: rinse mouth with water, drink a large amount of water and induce vomiting. Consult a physician to receive treatment as soon as possible.

1-2 Before Using Your Camera

Before taking pictures with this camera on important occasions (such as a wedding ceremony or an overseas trip),

test the camera beforehand to ensure that it functions well. Any additional loss caused by the malfunction of this product (such as costs of photography or any loss of benefit generated by the photography) is not the responsibility of our company and no compensation will be given for it. Always take test shots before formal recording.

- Always observe intellectual property rights

Pictures taken with this digital camera may not be used in violation of copyright laws. Moreover, when "No Photography" restrictions are in place, do not record any live performance, improvisation or exhibit, even for personal and non-commercial purposes. Any transfer of pictures or use of memory cards must be conducted under the constraints of copyright law.

1-3 Operating Precautions

This product consists of intricate electrical parts. To ensure normal photography, do not drop, strike or hit the camera.

- Avoid using or placing the camera in the following locations:
 - Damp and dusty places.
 - Sealed vehicles or places exposed to direct sunlight or places subject to extremely high temperatures or heat.
 - Violently shaky or turbulent environments.
 - Areas full of smoke, fumes or steam.
 - Areas subject to strong magnetic field.
 - Rain, or snow or precipitation.
- Do not open the battery cover when the power is on.
- If water enters the camera, turn the power OFF and remove the batteries immediately.
- Maintain your camera:
 - If the lens or LCD monitor surface becomes dirty, please use a lens brush or soft cloth to wipe clean instead of touching them with your fingers.
 - Do not allow the camera to come into contact with solid objects to avoid scratching the lens and LCD monitor surface.
 - Do not use detergents or volatile solutions, which will cause the camera case and paint to dissolve and distort. Use soft cloth only.

1-4 Package Contents

Check to see you have received the following items:



CD-ROM
(incl. Camera Driver & Application Software), Pouch, Wrist Strap, Batteries

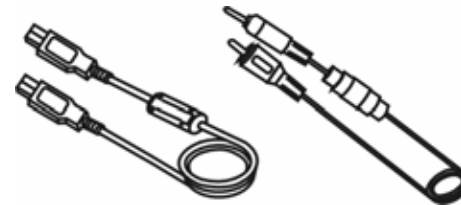

USB Cable TV-OUT Cable



This User's Manual

- CD-ROM (incl. Camera Driver & Application Software)
- Pouch
- Wrist Strap
- 2 x AA Alkaline Batteries
- USB Cable
- TV-OUT Cable
- This User's Manual

Chapter 2 Getting to Know Your Camera

2-1 Features Overview

Front View

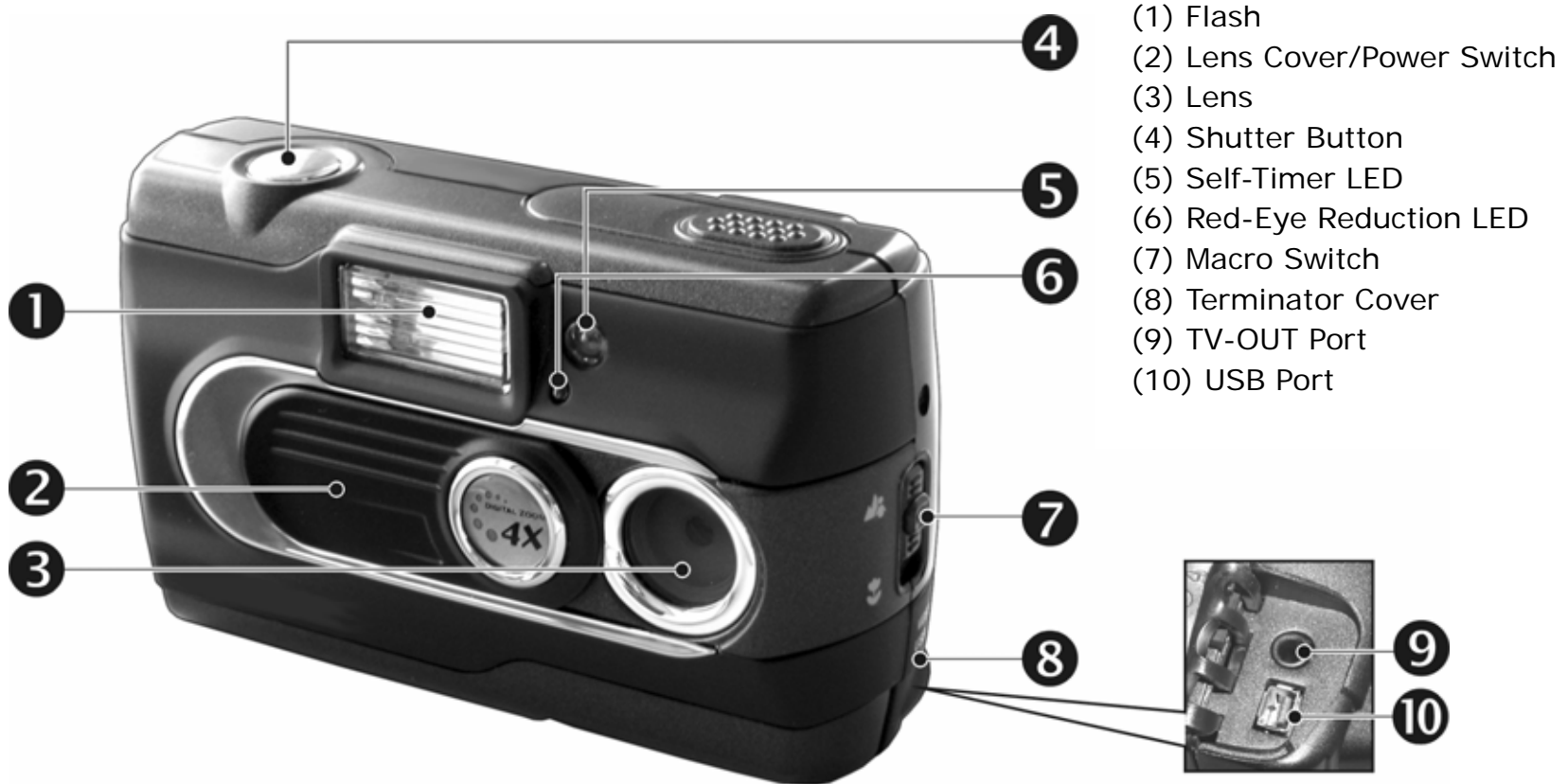

Rear View



2-2 Specifications

- Lens: f=9.61 mm
- Image Sensor: 3.3 megapixel CMOS
- Focus: F/3.0
- Sensitivity: ISO 100
- White Balance: Auto, Sun, Tungsten, Fluorescent.
- Shutter: Electrical
- Shutter Speed: 1/4 sec. ~ 1/2000 sec.
- Storage Media: 16MB Internal Flash Memory
SD Card (MMC compatible) Slot
(support 4/8/16/32/64/128/256/512MB)
- Image File Format: JPEG for Still images, AVI for Movie files.
- Image Resolutions:
 - >2976x2232 (Firmware Interpolation Technology)
 - >2048x1536
 - >1600 x 1200
 - >1280 x 960
- Digital Zoom: 10-Step 4X Digital Zoom
- Focal Range Standard: 1.2m ~ Infinity
- Focal Range Macro: 23 ~ 27cm
- Self-timer: 10 sec. delay
- PC-CAM Modes: 640 x 480 Pixels, 10 fps
320 x 240 Pixels, 15 fps
- Flash Modes: Auto, Red-eye reduction, Off
- TV-OUT: NTSC/PAL system selectable
- PC Interface: USB (Ver. 1.1)
- Movie File: Records 80 sec. continuous movie file with 512 x 384 format (16MB internal memory)

- Recordable Images (16MB):

		1280X960	1600X1200	2048X1536	2976x2232
16MB	Fine	32	21	13	6
	Normal	80	52	32	15

*For reference only, actual image numbers may vary.

- Power Supply: 2 x AA Alkaline Batteries or supports CRV-3; USB 5V (PC-CAM Mode)
- Dimensions: 93 x 56 x 38 mm
- Weight: About 120g (batteries excluded)

2-3 System Requirements

The following are minimum system requirements for the digital camera. We recommend that you use a computer system that exceeds the minimum requirements in order to utilize the camera at its optimum efficiency. The minimum system requirements for the digital camera are as follows:

System	Requirement
OS	Microsoft Windows 98SE/Me/2000/XP
CPU	Intel Pentium 166MHz or higher
Memory	Minimum 32 MB memory or above
CD-ROM	4X or above
HDD	Hard drive with 10 MB free disk space minimum
Others	One standard USB 1.1 port

Chapter 3 Controls, Operation, and Display

3-1 LED Indicators

The meanings of the LED indicators located above the LCD monitor are:

Standby/Busy (Red LED) Macro Mode (Green LED)



LED Status		Description
Red	On	The red LED turns on when the camera is recording or when the batteries are charging the flash. The LED blinks every 10 seconds in normal standby mode.
	Blinking	Standby
Green	On	Macro mode (close-up)
	Off	Normal mode

3-2 LCD Monitor Display

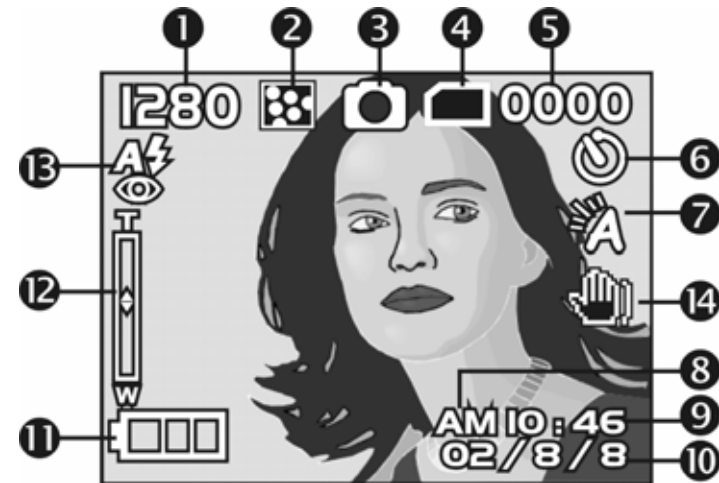

- (1) Image resolution
- (2) Image quality
- (3) Current working mode
- (4) Memory card loaded symbol
- (5) Shot number
- (6) Self-timer photography
- (7) White balance
- (8) Morning/Afternoon (AM/PM) display
- (9) Time
- (10) Date
- (11) Remaining battery power
- (12) Zoom level
- (13) Flash status
- (14) Palm Icon: indicates darker lighting conditions where extra-steady shooting is required. Use tripod.

3-3 Power Supply

- Slide the lens cover to the left to turn on the camera.



- Slide the lens cover towards the right to turn off the camera.



- Use the lens cover to turn the camera on and off. After turning on the camera, the red busy LED blinks, then the last recorded image appears on the LCD monitor.
- ※Auto Power Off: If the camera is idle for one minute, the power is turned OFF to prevent battery drain. Press the Display Mode Button to restart the camera.

※The following features are automatically saved before turning off the camera unless you select "Reset Default" to restore the factory settings.:

1. Resolution
2. Quality
3. OSD Language
4. White Balance
5. EV Compensation
6. TV-Out
7. Light Frequency
8. PC Mode

3-4 Shutter Button

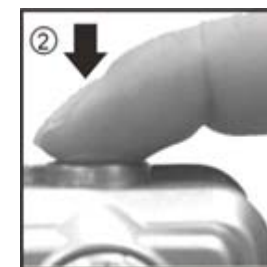
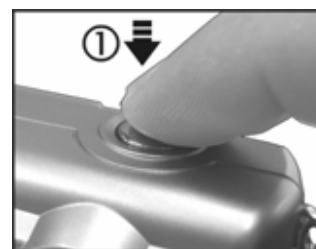

- This camera is designed for a two-step shutter function. A set of yellow brackets "[]" appears in the center of the LCD monitor when the **Shutter** button is pressed and held half way down. At this point the camera is metering to calculate the exposure. Fully depress the **Shutter** button and the camera will beep to indicate a shot is being taken.

3-5 Mode Dial



- Select a working mode by using the Mode Dial:

1. PC Mode
2.  Record Mode
3.  Play Mode
4.  Movie Mode
5.  Setup Mode

3-6 Multi-Select Button



You can perform various operations in different modes by using the Multi-Select button, for example, select, confirm, go forward and go back. The center button functions like an Enter key on a PC keyboard.

3-7 Flash Button



- This button works only in the Record Mode. Press this button to select the desired flash mode. There are 3 flash modes:

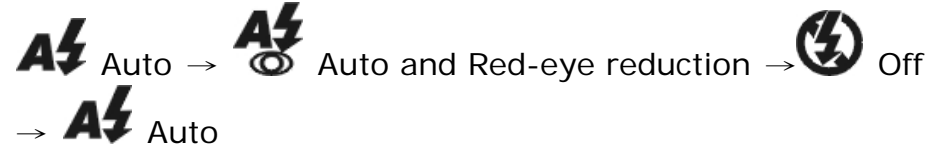

3-8 Display Mode Button



1. Press this button to change the LCD monitor to show one of several displays.
Standard → Image Only → LCD Monitor Off → Standard
2. Press the "**Display Mode Button**" to enter the "**Play Mode**" to review images when the camera has powered down.
3. In the **Record Mode**, if the camera has automatically powered down to conserve battery power, press the "**Display Mode Button**" to turn the camera on again.

3-9 Macro Switch

● Use the Macro switch on left side of the camera to select either Basic (normal lens) or Macro (close-up) mode. When you select **Macro**, the green macro LED turns on.

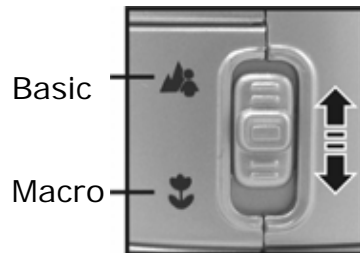

※ In **Macro Mode** the flash is disabled automatically to avoid overexposure.

Chapter 4 Navigating Modes and Menus

4-1 Record Mode



→For more information, please refer to section 3-2 "LCD Monitor Display," page 7.

Quick Index of Menu (for Reference):

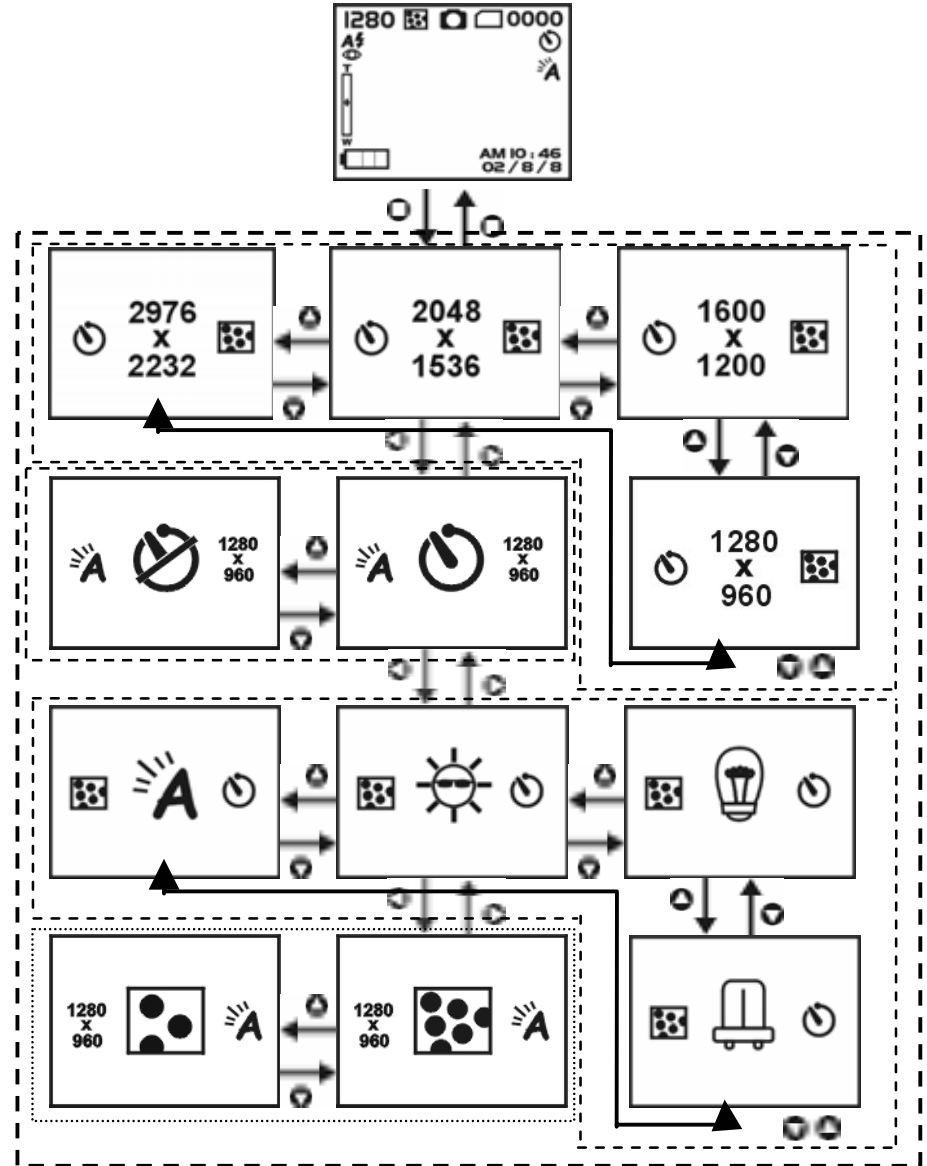

4-2 Play Mode ▶



- 1) Current Image Number/Total Number of Images
- 2) Battery Power

Index for Quick Menu:

1. Delete Pictures

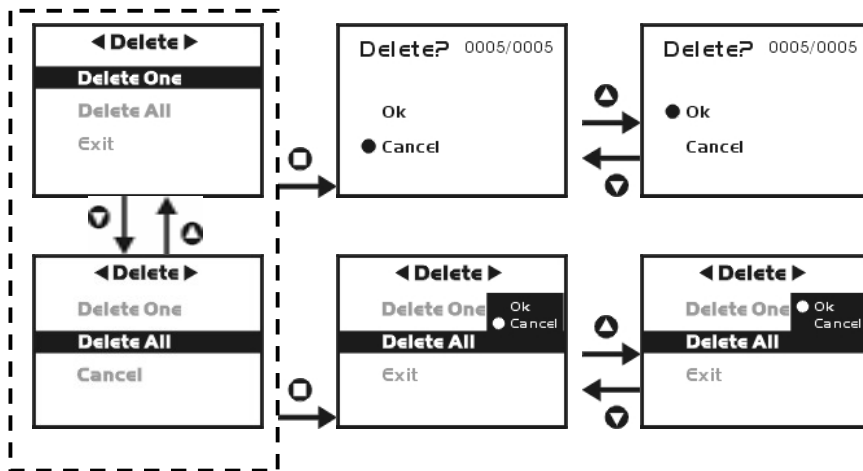

2. Slideshow

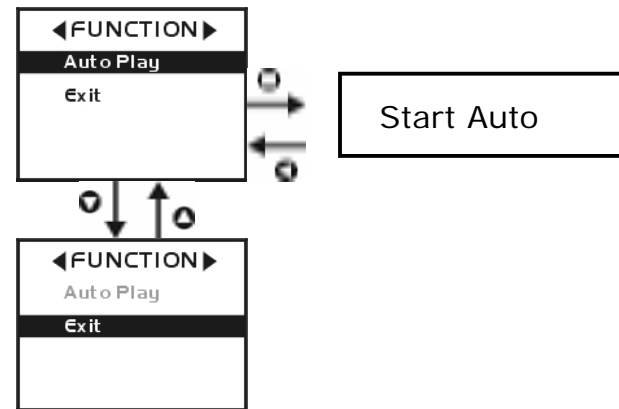

3. DPOF (Digital Print Order Format) Settings.

DPOF (Digital Print Order Format) allows for tagging of images on memory cards for printing. DPOF allows digital camera users to define what images are to be printed on compatible print devices. Basically, it is a set of text files in a special directory in the digital camera's storage files. These files define what images (if any) are to be printed, how many copies of each image are to be printed, and if any information (such as time and date) is to be overlaid on the image. DPOF is implemented through a menu option in the digital camera's playback mode.

- There are three basic options when printing images with DPOF: printing individual images, printing all images and printing with or without the image recorded date.

※ The DPOF function works only with a memory card.

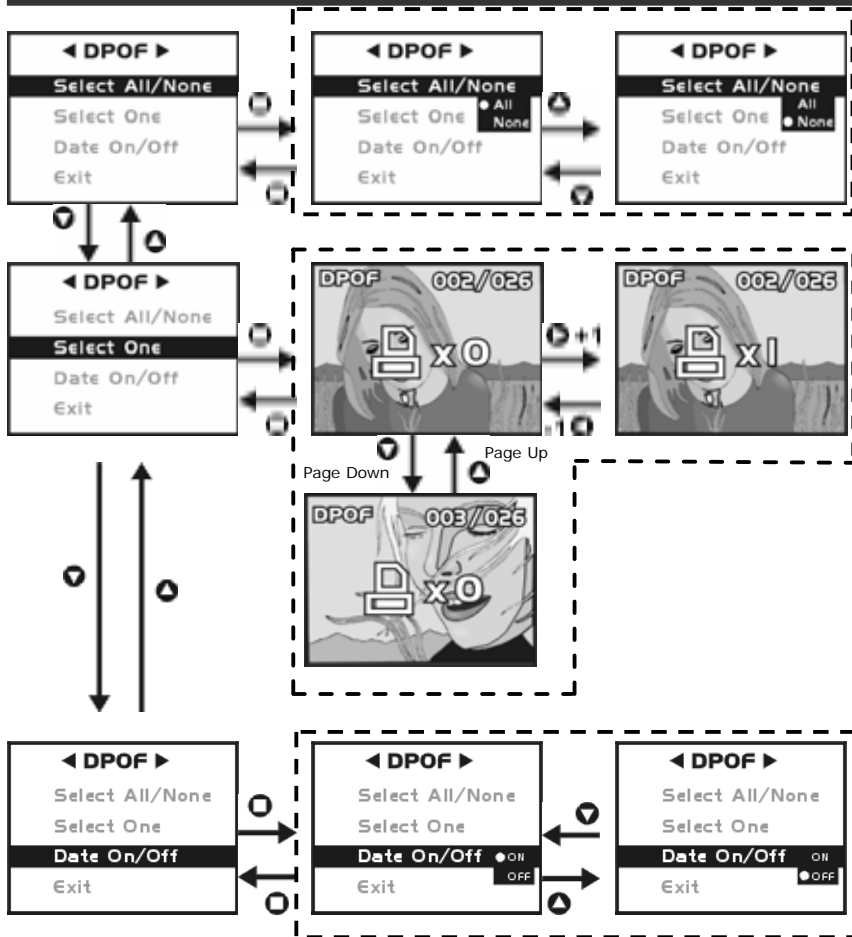

4-3 Movie Mode

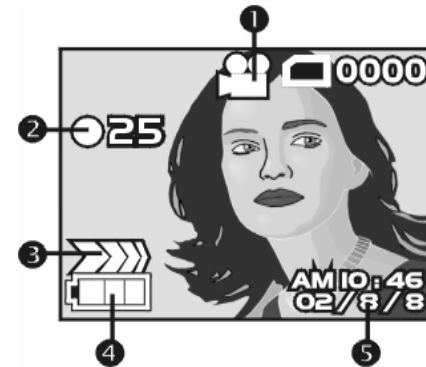

- (1) Movie Mode
- (2) Movie Length
- (3) Record Indicator
- (4) Battery Power Level
- (5) Time/Date

4-4 Setup Mode

1. Image Resolution

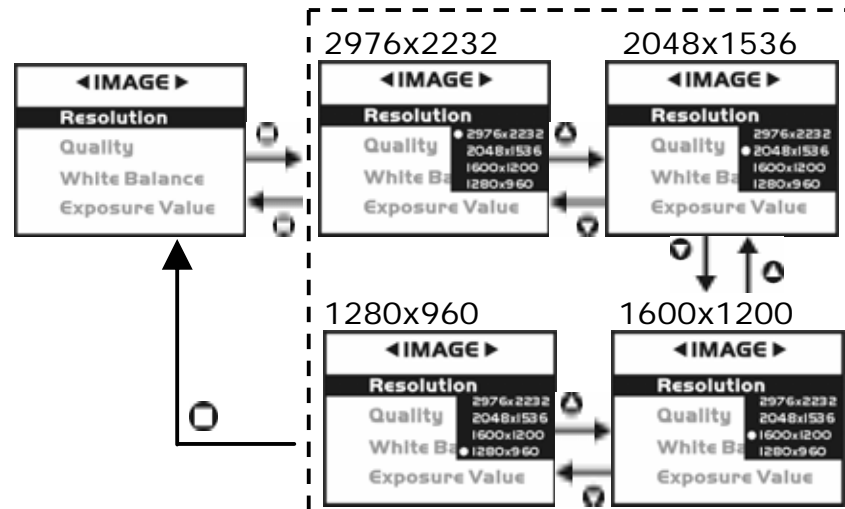

2. Image Quality:



3. White Balance:

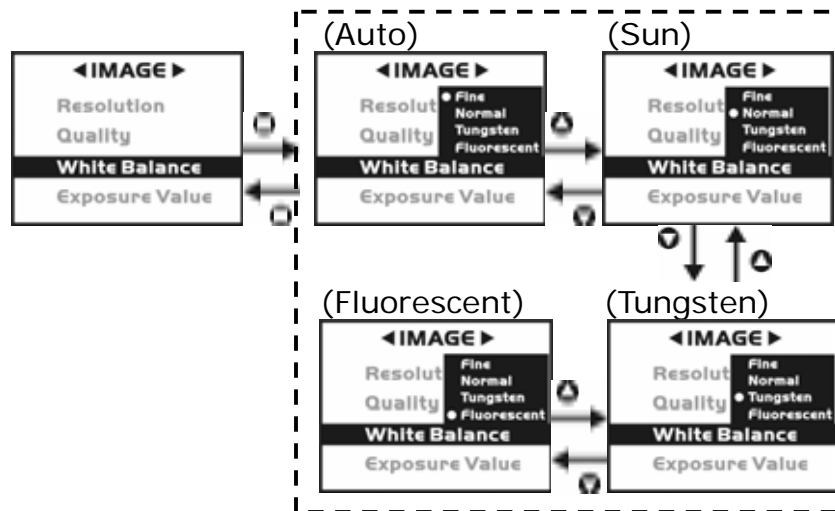

4. EV (Exposure Value) Compensation

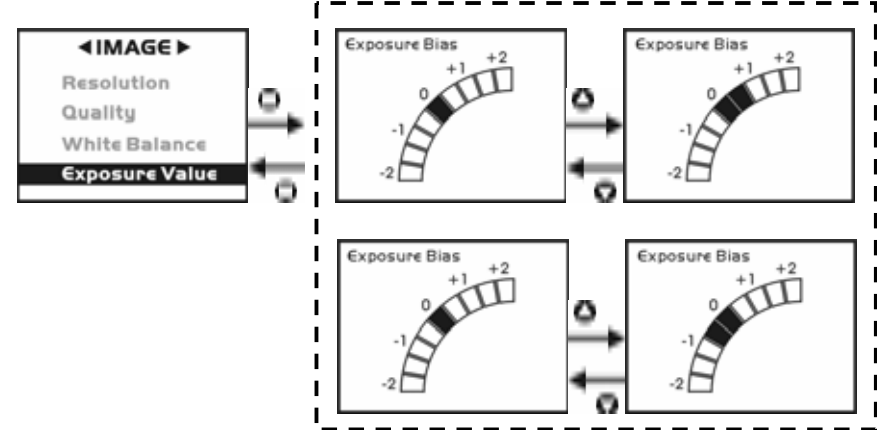

5. OSD Language

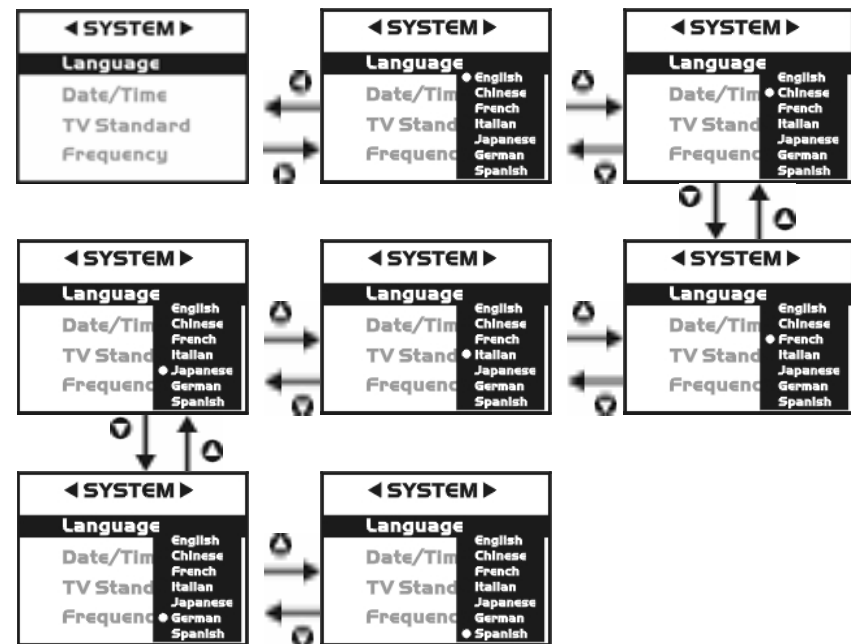

6. Date / Time

0+1

0+1



7. TV-Out Operation

0-1

0-1

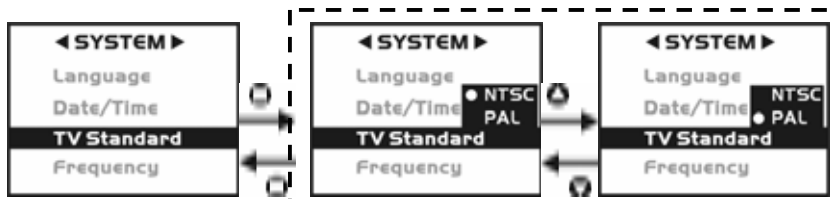

8. Light Frequency

Select the correct frequency (50Hz or 60Hz) for your region. (USA=60Hz)

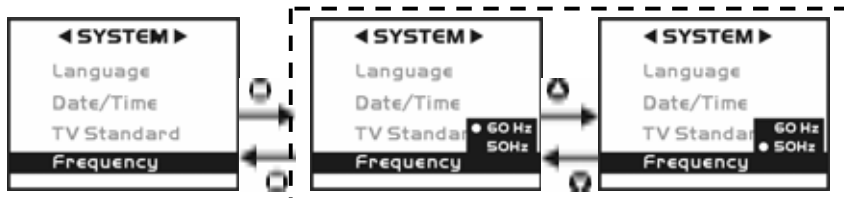

9. Format Media

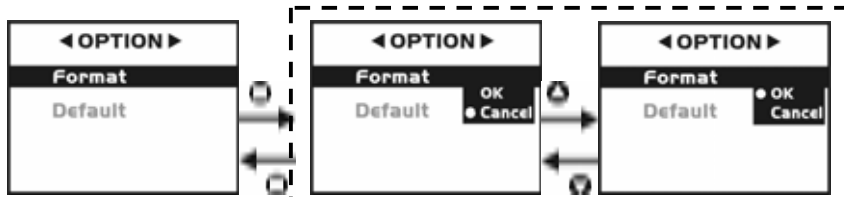

※ If a memory card has been inserted, only the memory card is formatted, and not the internal memory.

10. Default Reset to default factory settings

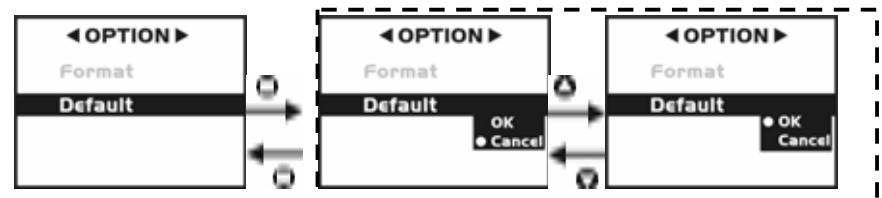

4-5 Mode Selection

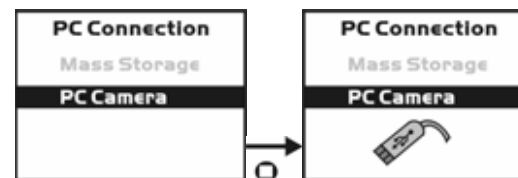
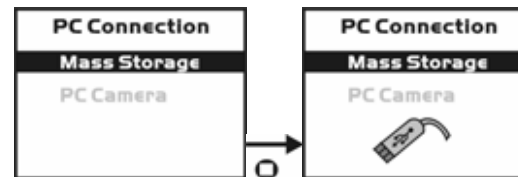

Chapter 5 Preparing Your Camera

5-1 Attaching the Strap



- Insert the thin end of strap into the strap holder.

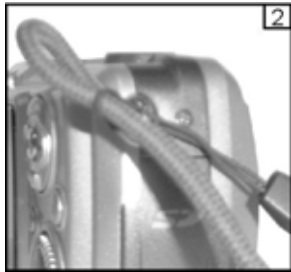

- Pass the other end of strap through the loop.

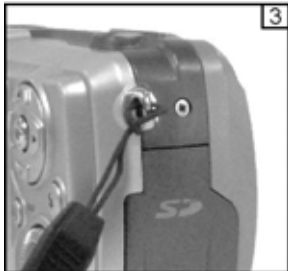

- Stretch the strap tightly.

5-2 Loading Batteries

- Turn the camera off.
- Insert two AA alkaline batteries or rechargeable batteries. Please make sure the batteries are fully charged. If the batteries are low, please change the batteries as soon as possible to maintain normal date/time operation.
- ※ If the battery power indicator only shows one black block, the flash is disabled. If power is less than **1.8V** (the level at which the battery power indicator turns red) the camera automatically turns off.



- Slide the switch on the battery cover in the direction indicated by the arrow.



- Insert batteries as indicated on the inside cover.



- Close and lock the battery cover.

NOTE: Open the cover gently to avoid damaging the battery compartment cover.

Battery Tips:

- ※ If the battery power indicator shows only one black block, the flash is disabled.
- ※ When the battery indicator turns red, you can no longer record.
- ※ The date and time is stored for approximately 3 minutes. Double-check date and time after inserting new batteries to ensure date and time accuracy.

5-3 Loading and Removing Memory Card

1. To load the memory card:

- Turn off the camera.



- Slide the battery cover switch in the direction indicated.



- Insert the memory card in the direction indicated.

2. To remove the memory card



- Press the memory card down gently.



- The memory card will bounce upward.



- Pull the memory card out with your fingers as shown.

NOTE:

Before using the camera, please remember to insert the memory card into the slot. If the memory card is



full of images or data, you can turn the **Mode Dial**  to **Setup Mode** **SET** and then select "**Format**" item to format the memory card. First backup any important data stored in the memory card.

※There is 16MB internal flash memory built into the camera to store images

If there is a memory card inserted, the card takes precedence. Images are stored on the card. If you want to store image in the internal memory, simply remove the memory card.

- This camera uses SD or MMC memory available in various module sizes (4/8/16/32/64/128/256/512MB).
- The memory card won't fit if inserted the wrong direction. Avoid damage to the card by inserting gently.
- If the camera does not recognize the memory card, gently wipe the metal interface of the card with a soft cloth and reload the card.
- Make sure the memory card is in unlocked status. If it is locked, the LCD monitor will display  and you will be unable to take a picture or play back images.

● LCD monitor will display  when no memory card is present.

● LCD monitor will display  when memory card is loaded and working properly. In case the LCD monitor still displays  with the card inserted, consider the following possible cause and solutions:



- Image format can't be recognized by camera:
Save image data to PC for backup, then format the memory card.
- Memory card dirty:
Use clean soft cloth to clean memory card and re-insert.
- Memory card malfunction:
Contact the memory card supplier for further assistance.
- Card slot in camera malfunctions:
Contact authorized dealer to request further assistance.

date and time.

5-4 Setting Up the OSD Language

Before using the camera, turn the **Mode Dial** to **Setup Mode**  and then select "**Language**" to set the OSD language. There are 7 options for your selection: English, Chinese, French, German, Italian, Japanese, and Spanish.









5-5. Date/Time

Before using the camera, turn the **Mode Dial**  to **Setup Mode**  and then select "**Date/Time**" to set the

Chapter 6: Getting Started



6-1 Setup Mode

In **Setup Mode**, you can adjust the camera's basic functions, including Image Size, Image Quality, Self-timer, White Balance, EV Compensation, OSD Language, Date/Time, Preset Settings, Format Media, and TV-Out. To set these options:

1. Turn the **Mode Dial**  to **Setup Mode** .
2. Turn on the camera. The red LED will blink, and then the setup screen will show on the LCD monitor.
3. Press the arrow button  /  on the **Multi-Select Button**  to move and select the menu items.
4. Press the arrow button  on the **Multi-Select Button**  to enter the selected menu items.
5. Press the arrow button  on the **Multi-Select Button**  to return the previous menu.











6-2 Record Mode

Record Mode offers you a quick and easy way to take ideal pictures.

1. Turn the **Mode Dial**  to **Record Mode** .
2. Turn on the camera. The last recorded image appears on the LCD display.
3. Press and hold the **Shutter** button halfway down. The camera will process the exposure settings and yellow brackets "[]" will appear in the center position of LCD monitor. Continues to press and hold the **Shutter** button halfway down to keep the same

value. Press the **Shutter** button down fully and you will hear two beep sounds, one low beep and one high beep. Hold the camera steady until after the two beeps.

4. When taking a picture, you can press the **Flash Button**  to set the desired flash modes: Auto, Red-eye reduction, and Off.

5. Press the **Display Mode Button**  to choose your desired LCD display mode. There are five display modes: Standard Display, Full Display, Image Only, LCD Monitor Off, and Only Operation Settings.
6. Use the **Multi-Select Button**  to set the detailed settings for recording images, e.g., Image Resolution, Image Quality, Self-timer, and Light Frequency settings. By pressing the  button on the center of the **Multi-Select Button**, the menu items will appear on the LCD monitor. Press the arrow buttons  /  /  /  on the **Multi-Select Button**  to move to, and **Enter** to select, the desired menu items.
7. Press the arrow buttons  /  on the **Multi-Select Button**  to adjust the digital zoom and a zoom indicator appears on the left side of the LCD Monitor.
8. Slide the **Macro Button** downwards to enable Macro (close-up) photography.











When you select the **Macro Mode**, the green Macro LED located on the top of the LCD monitor will light up.

※ If the low battery power icons appear on the LCD Monitor, replace the batteries immediately to keep the camera operating normally.

※ If the "Memory is not enough!" warning message appears on the LCD Monitor, the memory card is full.

6-3 Play Mode

In **Play Mode**, users can review recorded stills and movies. To review:

1. Turn the **Mode Dial**  to **Play Mode** .
2. Turn on the camera. The most recently recorded image appears on the LCD monitor.
3. Press the arrow buttons  /  on the **Multi-Select Button**  to review the previous and back image.
4. Press the  button on the center of the **Multi-Select Button**  to enable the "Delete", "Slideshow" and "DPOF" functions.
5. Press the arrow button  on the **Multi-Select Button**  to enter the selected menu items.
6. Press the arrow button  on the **Multi-Select Button**  to exit the menu.

※ The DPOF function can only be used with a memory card inserted.



※ If there is no image stored in the internal memory or memory card, a "No picture" message pops up on the LCD Monitor in the **Play Mode**.

※ Press the **Display Mode Button**  to review the

images when the camera is powered off. Press the **Display Mode Button** again to turn off the LCD Monitor.

6-4 Movie Mode

Use **Movie Mode** to record moving pictures (no audio). To record movies:

1. Turn the **Mode Dial**  to **Movie Mode** .
 2. Turn on the camera. When the camera is on, the last image recorded appears on the LCD monitor.
 3. Press the Shutter button to start recording. Press the **Shutter** button again to stop recording.
 4. The LCD Monitor will show the recorded time (seconds) while you are recording the movie pictures.
- The maximum recording time depends on the amount of memory card space available.

6-5 PC Mode

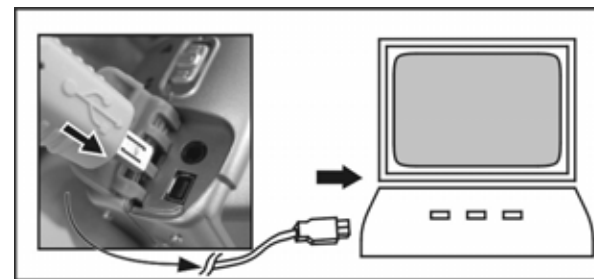





● Use **PC Camera** or **Mass Storage** items in the **PC Connection** menu:

1. Turn on the camera and turn the **Mode Dial**  to **PC**.

PC Camera and **Mass Storage** options will appear on the LCD Monitor.

2. Press the arrow buttons ▲ / ▼ on the **Multi-Select**

Button Button  to move and select the desired option. Press the  or  button to confirm and save the settings.

3. The  message will pop up on the LCD Monitor. Connect the USB cable to the camera and PC to complete the configuration.

※ Once you save the settings, the camera will keep these menu settings before you change them again.

2. Use the TV out cable provided with the camera to connect the camera and output device.
3. Turn on the camera. Images display via on the TV.

※ Operate the camera as normal.

※ Exercise caution when moving the camera since it is connected via cable.

※ To restore the LCD Monitor display, simply disconnect the TV out cable from the camera.

6-6 TV-Out Operation

Using the **TV-Out** function offered by the camera, you can transfer the images to the other display devices, e.g. TV or computer. To transfer images:

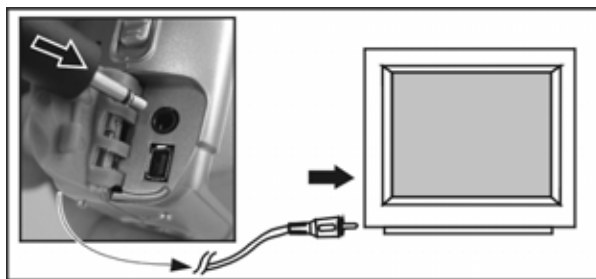

1. Select the correct video type for the device to be

connected. Turn the **Mode Dial**  to **Setup Mode** **SET**. Select the correct video output type, either NTSC (US) or PAL.

Chapter 7 Driver Installation

7-1 Installing the Camera Driver for PC

You can use the **PC Camera** and **Mass Storage** functions of the camera via PC. To install the driver:

1. Insert the companion CD-ROM supplied with the camera into the CD-ROM drive.
2. The welcome screen automatically appears after a moment:



4. Click **Next** to continue the setup program. A message appears:



5. Click **Finish** to restart the computer and finish the camera driver installation.

(Note: If your CD-ROM drive does not automatically run the CD install program, double click the "My Computer" icon on the desktop. Then double click the CD-ROM drive icon and click the **InstallMgr.exe** file in the root directory.

3. Click **Install driver** and a screen appears:

7-2 Installing Applications for PC

Install the **Arcsoft Software** (example given: Photo Impression).

1. Insert the companion CD-ROM supplied with the camera into the CD-ROM drive.
2. The Auto-run program execute and a welcome screen appears:



(Note: If your CD-ROM drive does not automatically run the CD install program, double click the "**My Computer**" icon on the desktop. Then double click the CD-ROM drive icon and click the **InstallMgr.exe** file in the root directory.

3. Click the **Arcsoft PhotoImpression** to install, and the screen will appear:



4. Select your language. Click **OK** to confirm.
5. Welcome screen shows. Click **Next** to continue.

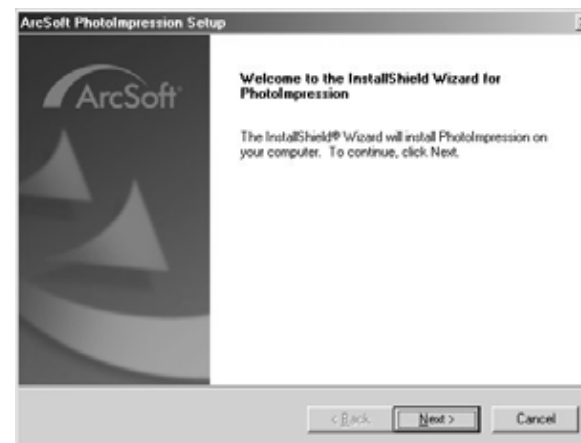

6. Enter **Software License Agreement** window. Click **Yes** to continue installation.



7. Follow the installation **Wizard** to select a destination folder and components.

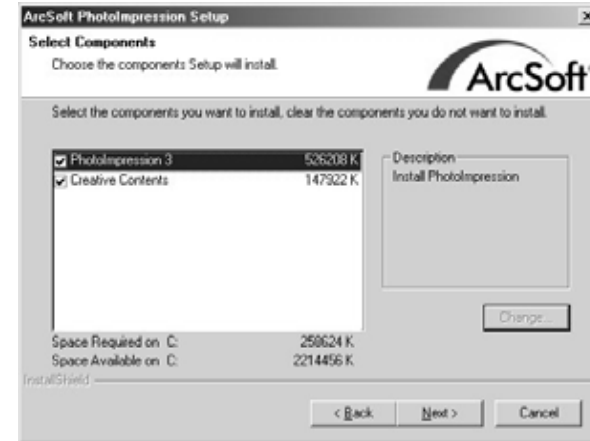

8. Select the program folder you want to install

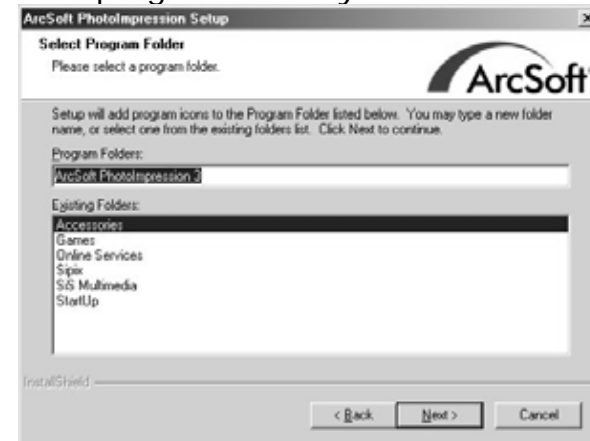
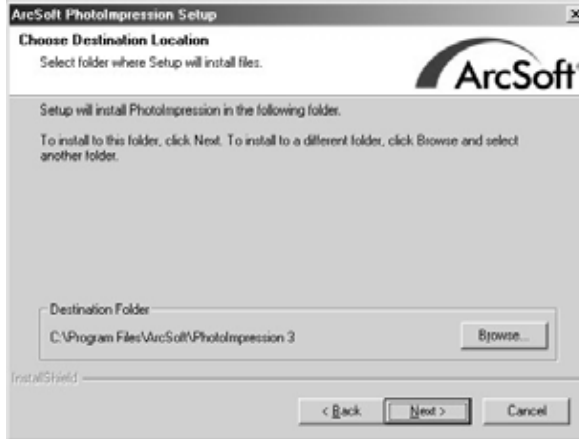

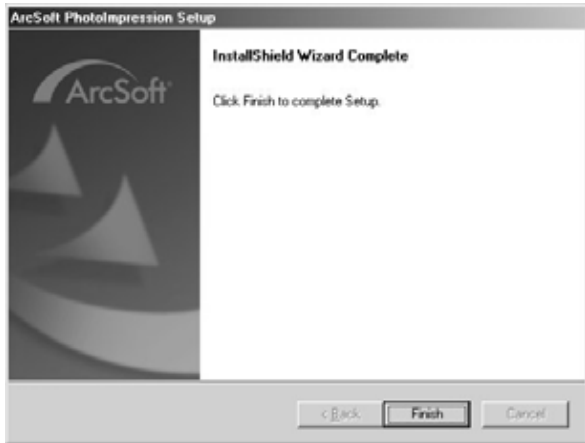

9. When the installation is complete, the window below will appear. Click **Finish** to end the installation.



Chapter 8 File Transfers

8-1 How to Transfer Files

Use the **Mass Storage** function in the **PC Connection** menu to connect and transfer files via USB. Note: Windows XP and Windows 2000 users do not need to install the camera driver to transfer files.

1. Turn the camera on by sliding the lens cover.
2. Set the Mode Dial  to **PC**
3. On the camera's LCD display, highlight "**Mass Storage**" (in blue)
4. Press the Enter Button on the **Multi-Select Button**  to select **Mass Storage**; a flashing USB cable icon appears on the display.
5. Connect the USB cable between the camera and the computer.

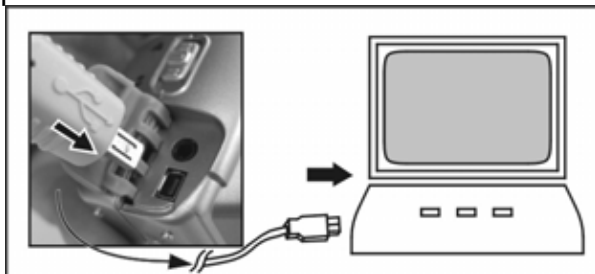

6. Your operating system responds with a window offering options to view and copy files.
7. Choose your desired option for using files. Windows will prompt you for input.

8-2 Mass Storage

The operating system recognizes the camera as a mass storage device. With the camera connected to the computer via USB you can easily transfer files from the camera using an alternative method from the one just described:

1. Double click on the My Computer icon.
2. Eject any CDs in the CD-ROM drive.
3. Find an icon representing the digital camera.
4. Double click on the icon.
5. Double click on file folder, labeled DCIM.
6. Double click on file folder, labeled 100FSCAM.
7. Drag and drop photo files, or the whole folder.

The file folders containing the images from the camera are automatically created upon camera connection.

8-3 Web Camera

Use the **PC Camera** function in the **PC Connection** menu to connect and transfer files via USB. Note: install the camera driver from the companion CD to use the camera's PC Camera functions:

1. Turn the camera on by sliding the lens cover.
2. Set the Mode Dial  to **PC**
3. On the camera's LCD display, highlight "**PC Camera**" (in blue)

-
4. Press the Enter Button on the **Multi-Select Button**  to select **PC Camera**; a flashing USB cable icon appears on the display.
 5. Connect the USB cable between the camera and the computer.

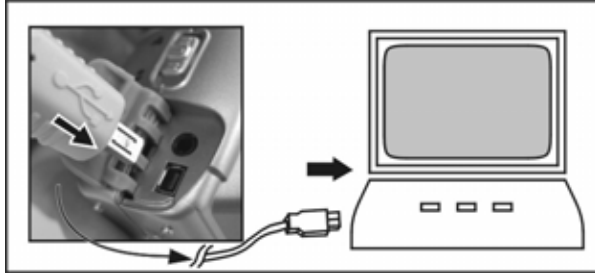

6. Open your web chat software. Click on the appropriate icon or menu selection to start the camera and use the web chat software to broadcast images via the Internet.

You can also use the **PC Camera** function to capture images with the camera connected to the computer via USB using various programs that allow this function, such as Arcsoft's PhotoImpression.

Disclaimer

The information in this document is believed to be reliable, but no responsibility is assumed for inaccuracies. DXG Technology reserves the right to make changes to the items described herein to improve reliability, function or design. Neither DXG nor any of its employees, assume any liability for damages or losses, either direct or incidental, which may arise out of the application or use of any of its products or circuits, particularly with regard to damage that may occur in the operation of its products.

©2004 DXG USA, City of Industry, CA Version 1.0 06/01/04

Free Manuals Download Website

<http://myh66.com>

<http://usermanuals.us>

<http://www.somanuals.com>

<http://www.4manuals.cc>

<http://www.manual-lib.com>

<http://www.404manual.com>

<http://www.luxmanual.com>

<http://aubethermostatmanual.com>

Golf course search by state

<http://golfingnear.com>

Email search by domain

<http://emailbydomain.com>

Auto manuals search

<http://auto.somanuals.com>

TV manuals search

<http://tv.somanuals.com>