

Clarion[®] SIRCR

SIRIUS[®] Vehicle Installation Kit

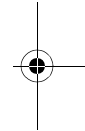

Vehicle Installation Guide

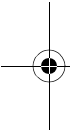
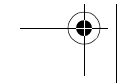
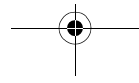

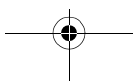
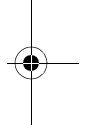
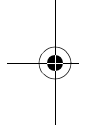

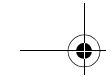

SIRCR

1



Dear Customer

Congratulations on your purchase of the world's finest brand in the electronic industry. At Clarion we are committed to high-quality sound reproduction, and are confident that you will be pleased with your purchase.

Clarion's Sirius Satellite Plug and Play Receiver provides entertainment with the flexibility of both home and car use.

100 streams (channels) of original programming received in high-quality digital sound provide:

- 60 channels of commercial-free music
- 40 channels of news, sports and entertainment

This SIRCR Vehicle Installation Kit contains the antenna and power adapter required to provide satellite radio in your automobile. The antenna connects to the Plug and Play receiver cradle.

When not traveling by car, you can disconnect the Plug and Play receiver from its vehicle cradle and connect it to the cradle at home (using the optional SIRHM Home Installation Kit)

Clarion and Sirius Satellite Radio welcome you to an experience like no other.

To learn more about Clarion's complete line of audio products, please visit us at our Website:

www.clarion.com

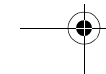
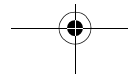
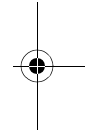
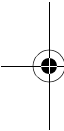



2

Vehicle Installation Guide

Vehicle Precautions

Follow these precautions to avoid serious auto accident or personal injury:

- Do not mount the Plug and Play receiver where it will block your view through the windshield or your view of dashboard indicators and displays.
- Do not mount the Plug and Play receiver where it might obstruct the operation of a safety device, such as air bags, etc.
- Do not let the receiver distract you as you drive. You are responsible for the vehicle. Always drive safely and follow traffic rules.

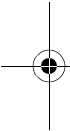

FCC Notice

This receiver complies with the interference limits relative to a Class B digital device, applicable under Part 15 of the FCC Rules regarding installation in a residential environment. If the receiver is not installed in accordance with these instructions, it could cause harmful interference to radio or television reception. If this condition persists after corrective action, consult your dealer or experienced installation facility.

Copyright and Trademarks

This document is copyrighted by Clarion. You may not copy any portion of it without permission.

SIRIUS is a registered trademark of SIRIUS Satellite Radio.

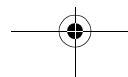

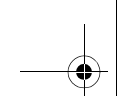

SIRCR

3



Contents

Installation cautions 5

Listening options 6

 Connecting using an audio cable 6

 Connecting using FM transmission 7

Install the cradle 7

 Install the cradle in the base 9

 Using other manufacturer's mounts 10

Install the receiver 10

Removing the receiver 11

Mount the antenna 11

 Determine the best position 11

 Route the cable 12

Limited warranty information 15

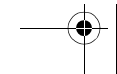
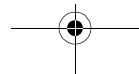
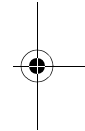
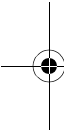



4

Vehicle Installation Guide



1. Package contents

In addition to this manual, this kit includes the following:



Cradle installed on base

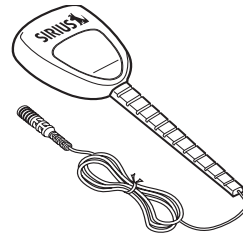

Car antenna

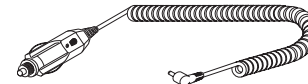

Power adapter



Audio cable



4 Phillips machine screws (M4 x 8 mm)



4 split lock washers (M4)



4 flat washers (M4)



1 alcohol swab

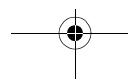

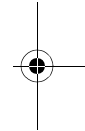
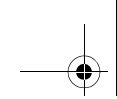
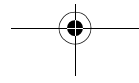
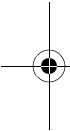

SIRCR

2. Installation cautions

- To prevent a short-circuit, turn off the ignition and remove the negative (-) battery cable before starting to install. Connect the power wires last.
- Do not install the receiver where it will receive direct sunlight or be subject to extreme temperatures.
- Mount the receiver firmly in place using the hardware supplied. Incorrect installation may cause damage to the system.

- Do not damage the vehicle wiring.
- Use the supplied screws and washers.
- Do not snag any wires when tightening the screws.

In addition to the components in the kit, you will need a dry, clean, lint-free cloth. If it's cold outside you may also need a hair dryer to warm the adhesive backing on the mounting base.

6

Vehicle Installation Guide

3. Listening options

Note

If you are uncomfortable installing components in your car, enlist the help of a professional installer.

The Plug and Play receiver and cradle provide an audio output signal that you may connect:

- Directly using the audio cable supplied.
The audio signal travels from the cradle to the auxiliary inputs of a radio or other system.
- Wirelessly using the Plug and Play receiver's FM Transmitter feature.

The satellite radio plays through your car radio when the radio is tuned to one of ten FM frequencies.

Connecting using an audio cable

Note

To use the wireless connection, do not connect the audio cable.

Use an audio cable when connecting to entertainment systems other than a radio.

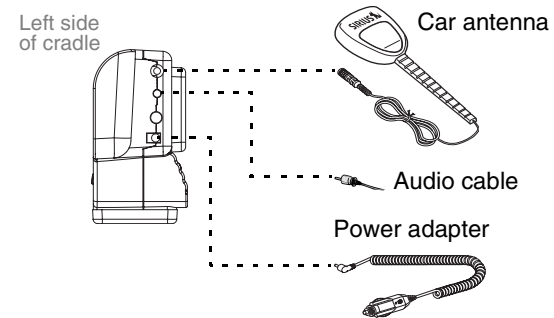

Audio cable connections

Connecting using FM transmission

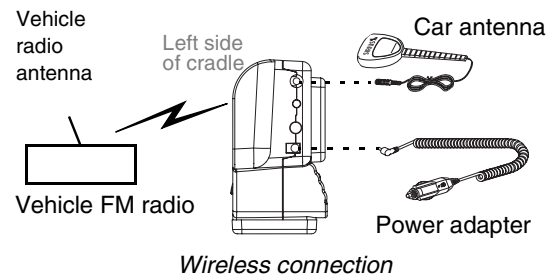

Wireless connection

The cradle supports ten FM transmission frequencies.

1. Turn the Plug and Play receiver on.
2. Confirm that the FM Transmitter option is set to FM ON. This is the default setting.
3. Select a frequency on the Plug and Play receiver using the FM Transmitter option.

For more information, see the *Plug and Play Receiver User's Guide*.

4. Set your car radio to the same frequency.

4. Install the cradle

You can mount the cradle directly to the dashboard or another flat surface or you may mount it using the mounting base in this kit.

1. Locate a firm, reasonably flat surface within your vehicle to permit optimum viewing and line-of-sight access by the supplied remote control.



Vehicle Installation Guide

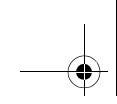

Caution

Do not install the cradle or mounting base on a leather or fabric surface, or in a position that could impair your vision, block air bags or obstruct vehicle dashboard controls, including radio CD/cassette operational displays.

Be very careful and plan ahead when selecting the mounting location. If you use the adhesive backing on the base you won't be able to reposition the receiver once you mate the backing to the mounting surface.

To screw the base to the surface, avoid unintentional damage by making sure the area behind the mounting surface is clear of wires or other items.

Note

The fins on the mounting base are pliable and can be bent to conform to most mounting surfaces.

2. Using the alcohol swab, clean the mounting surface and thoroughly wipe the area dry with a clean, lint-free cloth.
3. Decide how to mount the cradle. Your choices are:
 - Install the cradle in the mounting base and use the adhesive backing to fix the mounting base to the mounting surface.
 - Install the cradle in the mounting base and use screws to fix the base to the mounting surface.

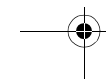
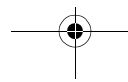
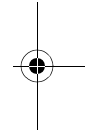
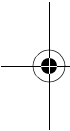

SIRCR

9

Install the cradle in the base

The cradle comes with two mounting plates, one on the rear and the other on the bottom of the receiver.

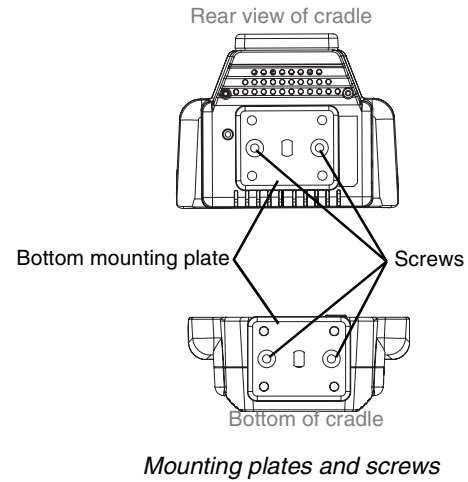

1. Choose one of the mounting plates, loosen and remove the two screws that secure the plate to the cradle.
2. Save the screws for reassembly and remove the plate.

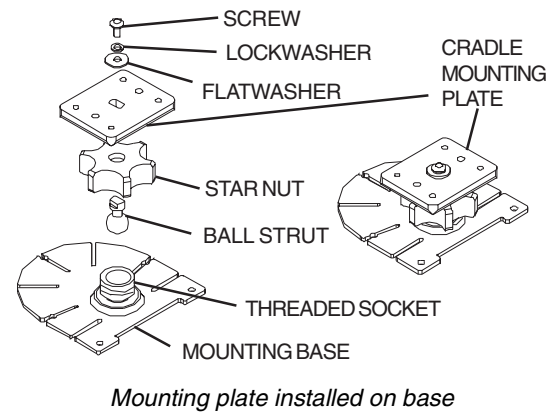

10

Vehicle Installation Guide

3. Unscrew the star nut and ball strut assembly from the mounting base threaded socket.
4. Remove the screw, lockwasher and flatwasher from the end of the ball strut.
5. Insert the end of the ball strut into the keyed opening on the cradle mounting plate.
6. Secure the plate to the ball strut using the flatwasher, lockwasher and screw.
7. Reattach the mounting plate assembly to the rear or bottom of the cradle assembly, using the two flat-head screws you previously removed.

Using other manufacturer's mounts

You may install the cradle using other mounts. The mounting plates on the rear and bottom of the cradle provide multiple mounting options using various vehicle-specific aftermarket brackets, such as those you may purchase separately from your local dealer.

5. Install the receiver

1. Place the Plug and Play receiver in the cradle so that the connectors are lined up.

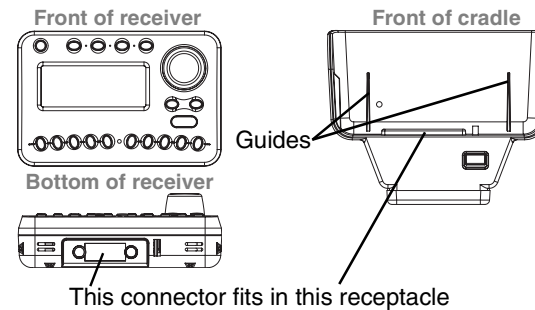

Plug and Play receiver and cradle connectors

Using the guides, gently slide the Plug and Play receiver to engage the connectors and lock into place.

You may adjust the orientation of the cradle by loosening the star nut and tightening it when the cradle is in the desired viewing position.

6. Removing the receiver

When it's time to take the Plug and Play receiver with you, press the release button to remove it from the cradle and slide the receiver upwards.

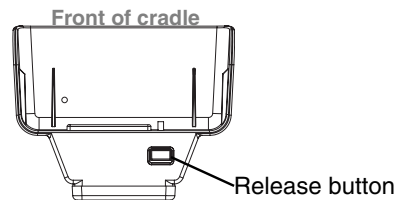

Plug and Play release button

7. Mount the antenna

Your goal is to place the antenna on a relatively flat surface on the exterior of the vehicle, preferably on the roof (the high point) or on the trunk, if the car is a convertible.

Determine the best position

1. Plug the antenna into the connector on the side of the cradle.

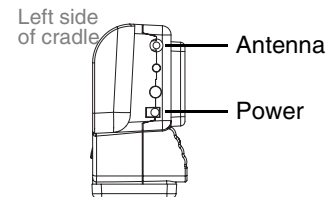

Antenna and power connectors



When connected to the Plug and Play receiver's cradle, the antenna can receive the SIRIUS signal virtually anywhere as long as no obvious obstructions, such as buildings, high terrain, parking garages and tunnels block the satellite signal.

2. Mount the antenna on the roof or trunk.

If the vehicle has a roof or trunk rack, you may have to mount the antenna off-center. The magnet secures the antenna in place.

3. Connect the power adapter to the cradle and the vehicle's +12 VDC power receptacle (cigarette lighter).
4. Press the power button to turn the Plug and Play receiver's power on.
5. If you don't hear anything, check the signal strength indicator in the bottom left corner of the display.

If necessary, move the antenna to different positions until the signal comes loud and clear.

6. Mark this position with masking tape or use some other method that won't scratch the body work.

Route the cable

1. Plan the routing of the antenna cable to the Plug and Play receiver's antenna input.

Avoid any obstructions that could crimp, kink or twist the cable. Use protective grommets wherever you encounter rough openings.

2. At the lowest point of the rear window, route the cable into the trunk, taking advantage of existing cable conduits.
3. Snake the cable around the passenger compartment to the back of the SIRIUS cradle.

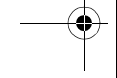
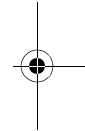
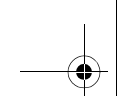
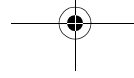
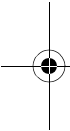



SIRCR

13

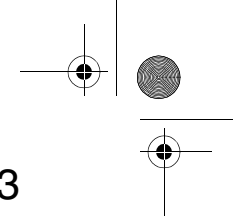

In SUVs and minivans, route the cable into the vehicle under the rubber molding of the hatch door or tailgate, and then under the interior trim.

Note

Avoid exposing the cable in the driver or passenger areas where it could become entangled in feet or other objects.

4. Plug the antenna cable into the connector on the side of the cradle.
5. Plug the cigarette lighter adapter into the +12VDC power receptacle.

The power LED on the power button glows red.

You're ready to enjoy SIRIUS programming.

Caution

If you leave the cigarette lighter adapter plugged in when the ignition is off you could drain the vehicle's battery. Unplug the adapter when you leave the vehicle.

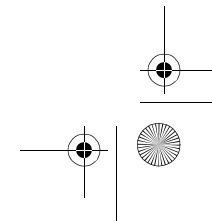
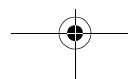
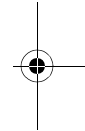
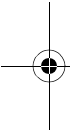



14

NOTES

Vehicle Installation Guide

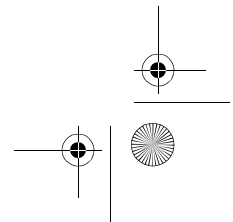
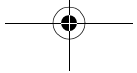
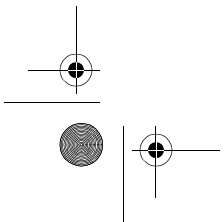
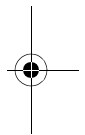
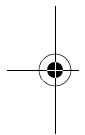
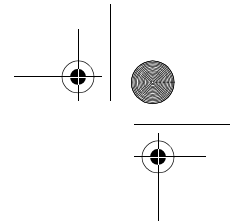

1. Limited warranty information

For USA and Canada only

This product is warranted against all defects in material workmanship for a period of one year from the date of original purchase. Clarion ProAudio products, except for speakers, are covered by a two year limited warranty when installed by an authorized Clarion dealer. The conditions of this limited warranty and the extent of responsibility of Clarion Corporation of America ("Clarion") under this limited warranty are as follows:

1. PROOF OF DATE OF PURCHASE WILL BE REQUIRED FOR WARRANTY SERVICE OF THIS PRODUCT. IN THE CASE OF THE TWO (2) YEAR LIMITED WARRANTY FOR CLARION PROAUDIO PRODUCT, PROOF OF INSTALLATION BY AN AUTHORIZED DEALER IS REQUIRED. INFORMATION ABOUT CLARION AUTHORIZED WARRANTY SERVICE CENTERS MAY BE OBTAINED BY CONTACTING CLARION AT THE ADDRESS BELOW.
2. This limited warranty will become void if service performed by anyone other than an approved Clarion Warranty Service Center results in damage to the product.
3. This limited warranty does not apply to any product which has been subject to misuse, neglect or accident, or which has had the serial number altered, defaced or removed, or which has been connected, installed, adjusted or repaired, other than in accordance with the instructions furnished by Clarion.
4. This limited warranty does not cover car static or other electrical interferences, tape head or laser pick-up cleaning or adjustments, or labor costs for the removal or reinstallation of the unit for repair.
5. The sole responsibility of Clarion under this limited warranty shall be limited to the repair of the product or replacement of the product, at the sole discretion of Clarion.

6. Product must be shipped in its original carton or equivalent carton, fully insured, with shipping charges prepaid. Clarion will not assume any responsibility for any loss or damage incurred in shipping.
7. ALL IMPLIED WARRANTIES EXCEPT TO THE EXTENT PROHIBITED BY APPLICABLE LAW SHALL HAVE NO GREATER DURATION THAN THE WARRANTY PERIOD SET FORTH ABOVE. UNDER NO CIRCUMSTANCES SHALL CLARION BE LIABLE FOR ANY LOSS OR DAMAGE, DIRECT OR CONSEQUENTIAL, ARISING OUT OF THE USE OR INABILITY TO USE THE PRODUCT. BECAUSE SOME STATES DO NOT ALLOW LIMITATIONS ON HOW LONG AN IMPLIED WARRANTY LASTS OR EXCLUSIONS OR LIMITATIONS OF INCIDENTAL OR CONSEQUENTIAL DAMAGES, THE ABOVE LIMITATIONS OR EXCLUSIONS MAY NOT APPLY TO YOU.
8. THIS LIMITED WARRANTY GIVES YOU SPECIFIC LEGAL RIGHTS, AND YOU MAY ALSO HAVE OTHER RIGHTS WHICH VARY FROM STATE TO STATE.
9. Should you have any difficulties with the performance of this product during the warranty period, please call or visit our web site (www.clarion.com) for a listing of Authorized Warranty Service Centers in your area. You may also contact Clarion at the address listed below.

In USA:
Clarion Corporation of America
Attn: Customer Service Manager
661 W. Redondo Beach Blvd.
Gardena, CA. 90247-4201
1-800-GO-CLARION
(310)327-9100

In Canada:
Clarion Canada, Inc.
Warranty Service Center
2239 Winston Park Drive
Oakville, Ontario L6H 5R1
(905)829-4600

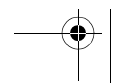
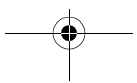
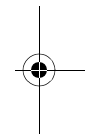
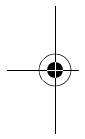
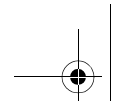



Sirius_Shuttle_Vehicle_Installation.book Page 1 Friday, March 12, 2004 4:56 PM

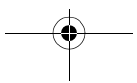
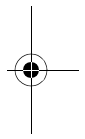
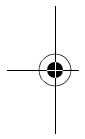

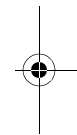
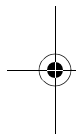

Clarion Corporation of America
661 West Redondo Beach Blvd.
www.clarion.com

200402-SIRCR-10 Rev2.0

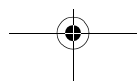

Free Manuals Download Website

<http://myh66.com>

<http://usermanuals.us>

<http://www.somanuals.com>

<http://www.4manuals.cc>

<http://www.manual-lib.com>

<http://www.404manual.com>

<http://www.luxmanual.com>

<http://aubethermostatmanual.com>

Golf course search by state

<http://golfingnear.com>

Email search by domain

<http://emailbydomain.com>

Auto manuals search

<http://auto.somanuals.com>

TV manuals search

<http://tv.somanuals.com>