

P-SERIES MANUAL



P1500X & P1800SX

Powered Loudspeakers

Instruction Manual (English) – Page 2
Manuel d'instruction (Français) – Page 34
Manual de instrucciones (Español) – Página 66
Gebrauchsanleitung (Deutsch) – Seite 98

To avoid injury, read all operating instructions and safety information in this manual before using the speaker.
Failure to follow these safety instructions could result in fire, electric shock, or other injury or damage to the speaker or other property.

Contents

IMPORTANT SAFETY INSTRUCTIONS.....	3
REGULATORY CERTIFICATION	5
Introduction	6
Before you begin.....	6
Quick Start.....	7
Loudspeaker placement.....	7
P1500X Mixer - Rear Panel.....	8
P1800SX Mixer - Rear Panel.....	11
P1500X and P1800SX Power Connections - Rear Panel.....	13
Using the P1500X as a floor/stage monitor	14
Using the pole mount	15
Using the suspension points	16
Application #1 – Single P1500X.....	17
Application #2 – Adding a second P1500X.....	18
Application #3 – Adding Subwoofers.....	19
Application #3 – Adding Subwoofers (Adjusting HPF & LPF Filters continued).....	20
Application #4 – Daisy-Chain	21
Application #5 – Adding a P1500X as a Stage Monitor	22
Application #6 – Large Venue/Front of House.....	23
Protective Grill	24
Remote Main Volume	24
System Block Diagram (P1500X full-range loudspeaker).....	25
System Block Diagram (P1800SX subwoofer)	25
Troubleshooting.....	26
Specifications	28
Package Contents.....	28
Care and Maintenance.....	29
Appendix A – Cable Connections	29
Warranty	31
How to Obtain Warranty Service	33

IMPORTANT SAFETY INSTRUCTIONS

 **CAUTION:** The lightning flash with an arrowhead symbol within an equilateral triangle is intended to alert the user to the presence of un-insulated dangerous voltage within the unit's enclosure that may be of sufficient magnitude to constitute a risk of electric shock to persons.

 **WARNING:** The exclamation point within an equilateral triangle is intended to alert the user to the presence of important operating and maintenance (servicing) instructions in the literature accompanying the product.

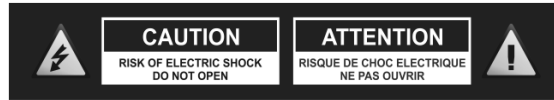



 **NOTE:** The hand within an equilateral triangle is intended to alert the user to specific guidance and information regarding the information regarding the operation of the unit, and should be read fully before using the unit for the first time.

 **CAUTION:** To reduce the risks of fire or electric shock do not remove any covers, or open the unit. There are no user-serviceable parts inside. All servicing should be referred to qualified service engineers.

-  a) Read and follow all the safety and operating instructions before connecting or using this unit.
 b) Retain this user manual for future reference.
 c) All warning on the unit and its packaging should be read and followed.

 **CAUTION:** To reduce the risks of fire or electric shock do not expose this product to rain, moisture, dripping, or splashing. Do not place objects containing liquid such as vases or glasses on apparatus. Do not use this product near water for example, near a bath tub, or near a swimming pool. Unplug the unit from the wall outlet before cleaning. Never use thinner, cleaning fluids, solvents or chemically impregnated cloths. For cleaning always use a soft dry cloth. Unplug this product during lightning storms or when unused for long periods of time.

 **CAUTION:** The unit should be installed so that its location or position does not interfere with its proper ventilation. For example, it should not be situated on a bed, sofa, rug or similar surface that may block the ventilation openings; or placed in a built-in installation, such as a bookcase or cabinet, that may impede the flow of air through its ventilation openings and/or fan assembly. The unit should be situated from heat sources such as radiators, heat registers, stoves or other devices (including amplifiers) that produce heat. No naked flame sources, such as lighted candles, should be placed on, or near the unit.

 **WARNING:** Do not place this unit on an unstable surface, cart, stand or tripod, bracket or table. The unit may fall, causing serious injury to a child or adult and serious damage to the unit. Use only with a cart, stand, tripod, bracket or table recommended by the manufacturer. Any mounting of the device on a wall or ceiling should follow the manufacturer's instructions and should use a mounting accessory recommended by the manufacturer. An appliance and cart combination should be moved with care. Quick stops, excessive force and uneven surfaces may cause the appliance and cart combination to overturn. When a cart is used, use caution when moving the cart/apparatus combination to avoid injury from tip-over.



 **NOTE:** Should the unit become damaged beyond repair, or reaches the end of its life, please consult the regulations regarding disposal of electronic products in your region.

 **NOTE:** Cerwin-Vega cannot be held responsible for damage caused by improper use of the unit and or the applications provided for use with the unit.

 **TO PREVENT ELECTRIC SHOCK, MATCH THE WIDE BLADE OF THE PLUG TO THE WIDE WALL SOCKET SLOT AND FULLY INSERT.**

 The apparatus shall be connected to a Mains socket outlet with a protective ground(earth) connection.

IMPORTANT SAFETY INSTRUCTIONS (continued)

-  1. The unit and power supply should only be connected to a power outlet that matches the voltage and frequency as marked on the rear of the unit and power supply.
- 2. Protect the power cable from being walked on or pinched particularly at plugs, convenience receptacles, and the point where they exit from the apparatus.
- 3. Do not defeat the safety purpose of the polarized or grounding-type plug. A polarized plug has two blades with one wider than the other. A grounding type plug has two blades and a third grounding prong provided for your safety. If the provided plug does not fit into your outlet, consult a qualified electrician for replacement of the obsolete outlet.
- 4. If the mains plug supplying this product incorporates a fuse then it should only be replaced with a fuse of identical or lower rupture value.
- 5. Never use a damaged or frayed power cable; this can cause serious risk of exposure to lethal voltages.
- 6. The power cable of the unit should be unplugged from the wall outlet when it is not going used for a long period of time.
- 7. Only use attachments/accessories specified by the manufacturer.
- 8. To completely disconnect the power input, the mains plug of the speaker should be disconnected from the mains connection.
- 9. The mains plug of the apparatus should not be obstructed so it can be easily accessed during intended use.

 **DO NOT ATTEMPT SERVICING OF THIS UNIT YOURSELF. REFER SERVICING TO QUALIFIED SERVICE PERSONNEL.**

In the event that servicing is needed, make sure that any replacement parts used have the same characteristics as the original parts and that routine safety checks have been performed to guarantee that the equipment is in safe operating condition.

 **REPLACEMENT WITH INCORRECT PARTS MAY RESULT IN FIRE, ELECTRIC SHOCK OR OTHER HAZARDS.**

 This unit should be serviced by qualified service personnel when:

- The power cord or the plug has been damaged
- Objects have fallen, or liquid has been spilled into the unit
- The unit has been exposed to rain or liquids of any kind
- The unit does not appear to operate normally or exhibits a marked change in performance
- The device has been dropped or the enclosure damaged.

 Keep speakers out of extended or intense direct sunlight. The driver suspension could prematurely dry out and finished surfaces may become degraded by long-term exposure to intense ultra-violet (UV) light.

 The speaker contains sensitive components. Do not drop, disassemble, open, crush, bend, deform, puncture, microwave, incinerate, paint, or insert foreign objects into speaker.

 The speakers are easily capable of generating sound pressure levels (SPL) sufficient to cause permanent hearing damage to performers, production crew and audience members. Caution should be taken to avoid prolonged exposure to SPL in excess of 90 dB(A).

 Operate and store the speaker in a place where the temperature is between -20° to 55°C. Low or high temperature conditions might cause the speaker to temporarily stop working. Avoid dramatic changes in temperature or humidity when using the speakers as condensation may form within the speaker.

 Turn the speaker off when in any area with a potentially explosive atmosphere. Obey all signs and instructions as sparks in such areas could cause an explosion or fire resulting in serious injury or even death. Areas with potentially explosive atmosphere are often but not always marked clearly. Potential areas may include fueling areas, areas where the air contains chemicals or partials (including grain dust or metal particles) below deck on boats, fuel or chemical transfer storage facilities, and any area you'd normally be advised to turn off your vehicle engine.

 The speaker contains small parts, which may present a choking hazard to small children. Keep the speaker and its accessories away from small children.

REGULATORY CERTIFICATION

Cerwin-Vega declares under our sole responsibility that this product, to which this declaration relates, is in conformity with the following standards:

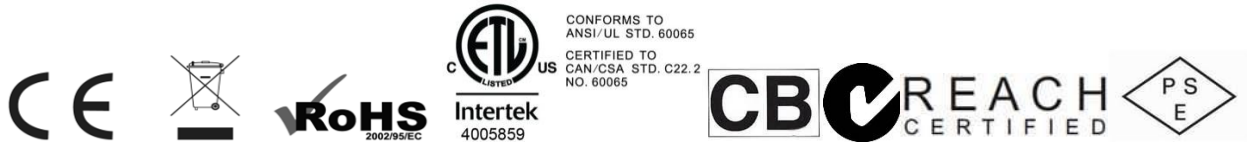

The Declarations of Conformity can be obtained from Gibson Europe BV - Kamerlingh Onnesweg, 2 - 4131 PK Vianen - The Netherlands Tel : +31 347 32 40 10 - Fax : +31 347 32 40 15

This device complies with Part 15 of the FCC Rules. Operation is subject to the following two conditions: (1) this device may not cause harmful interference, and (2) this device must accept any interference received, including interference that may cause undesired operation.



WARNING: Changes or modifications to this unit not expressly approved by the party responsible for compliance could void the user's authority to operate the equipment.



NOTE: This equipment has been tested and found to comply with the limits for a Class B digital device, pursuant to Part 15 of the FCC Rules.

These limits are designed to provide reasonable protection against harmful interference in a residential installation. This equipment generates, uses, and can radiate radio frequency energy and, if not installed and used in accordance with the instructions, may cause harmful interference to radio communications. However, there is no guarantee that interference will not occur in a particular installation. If this equipment does cause harmful interference to radio or television reception, which can be determined by turning the equipment off and on, the user is encouraged to try to correct the interference by one or more of the following measures:

- Reorient or relocate the receiving antenna.
- Increase the separation between the equipment and receiver.
- Connect the equipment into an outlet on a circuit different from that to which the receiver is connected.
- Consult the dealer or an experienced radio TV technician for help.

This Class B digital apparatus complies with Canadian ICES-003.

Introduction

Congratulations - Welcome to the Cerwin-Vega! Family! You've joined a growing group of audio professionals who have turned to Cerwin-Vega! for the most advanced audio reproduction systems available. All Cerwin-Vega! products are thoroughly tested to insure that they meet or exceed our performance specifications. Backed by the best service in the industry, Cerwin-Vega! is dedicated to quality and reliability. For a complete overview of Cerwin-Vega! products and services, log onto www.Cerwin-Vega.com

Before you begin

The Cerwin-Vega! P-Series active speakers covered by this manual are designed for portable applications in which the speakers will be stacked directly on a floor, stage, stable platform, or mounted on a tripod stand or pole-mount. Cerwin-Vega! does not support suspension of the subwoofer models covered by this manual nor are these models intended for fixed installation in outdoor or high moisture environments. Moisture can damage the speaker cone or surround and cause corrosion of electrical contacts so avoid exposing the speakers to direct moisture.

Cerwin-Vega! speakers can generate considerable energy. When placed on a slippery surface such as polished wood or linoleum, the speaker may move due to its own mechanical vibration. Precautions should be taken to assure that the speaker does not fall off a stage or table on which it is placed.

Some Cerwin-Vega! speakers include a receptacle cup to allow mounting of a satellite speaker on top of the subwoofer using a standard speaker pole shaft. When using a standard speaker pole shaft, be sure to observe the following precautions:

- **CAUTION:** There are a wide variety of pole stands and pole shaft available in the market. Please refer to qualified service personnel from the pole stands and pole shaft manufacturer for installation service. Improper use of accessory and inappropriate installation will present a tripping hazard.
- Check the speaker pole shaft specification to be certain it is designed to support the weight of the speakers.
- Observe all safety precautions specified by the speaker pole shaft manufacturer.
- Always verify that the subwoofer is placed on a flat, level, and stable surface.
- Route cables so that performers, production crew, and audience will not trip over them, toppling the speaker.
- Always be cautious in windy, outdoor conditions as the stability of the entire system may be compromised.

Quick Start

The steps below provide a quick reference on how to setup and use a single loudspeaker. A typical setup will follow the same basic steps.

STEP 1	<ul style="list-style-type: none"> ✓ Make sure the loudspeaker is unplugged. ✓ Be sure the master switch is to set to the 'OFF' position. ✓ Turn the Volume to the lowest level (fully counter-clockwise) ✓ Check that the loudspeaker voltage selector is set to the same voltage as the AC power outlet.
STEP 2	<ul style="list-style-type: none"> ✓ Place the loudspeaker in the ideal location. See the Loudspeaker Placement page for recommended usage. ✓ Connect the source audio equipment output to the loudspeaker input. Be sure the source equipment is powered on and set to a normal output level.
STEP 3	<ul style="list-style-type: none"> ✓ Connect the power cord to the loudspeaker and AC power outlet. ✓ Set the master power switch to the 'ON' position and verify the rear POWER LED indicator is illuminated. ✓ Slowly turn the volume clockwise until the sound output is at the desired level. If there is no sound, check to make sure the source equipment is providing audio output.
NOTE(s)	<p>When you are done using the loudspeaker, set the master power switch to 'OFF' before removing any cables and turning off the source audio equipment.</p> <p>Do not switch the loudspeaker voltage selector or MIC/LINE switch while the loudspeaker is powered 'ON' and plugged into an AC power outlet.</p>

Loudspeaker placement

- Never point a microphone directly at a loudspeaker as this will result in extreme feedback (unwanted sound). Be sure the loudspeaker is placed away from the front of the microphone or directly behind the microphone when in a floor monitor position.
- When used with turntables, carefully place the loudspeaker so that any vibrations do not interfere with the turntable performance and functionality.
- Avoid placing the loudspeaker in the corners or along the walls of a room. This will increase the low-frequency sounds and the sound will result in a muddy and incoherent sound reproduction.
- Avoid placing the speakers directly on a hollow stage. It is better to place the loudspeakers on tripod stands or a sturdy table.
- The loudspeaker should be placed two to four feet above the ear level of the audience since the human body can absorb sound especially at high frequencies. This will make sure the entire audience can hear the sound system with the best possible clarity.

P1500X Mixer - Rear Panel

The P1500X powered loudspeaker has an assortment of mixer controls and connections that cover several applications. It is suggested to review the P1500X mixer, as listed below, to take full advantage of the product features.

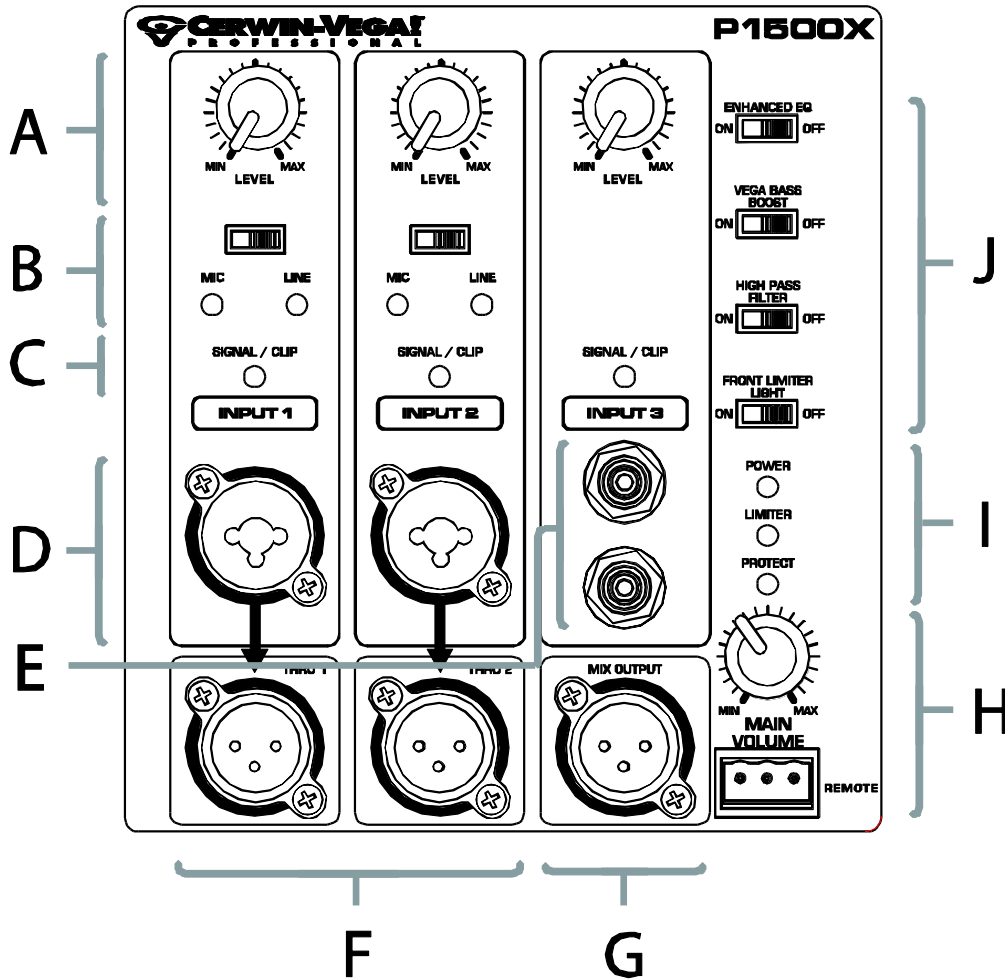

(A) INPUT 1, INPUT 2, INPUT 3 LEVEL KNOBS

Each level knob adjusts the gain level on the respective input signal. The full clock-wise position (MAX) sets the gain level to maximum whereas a full counter-clockwise (MIN) position sets the gain level to the minimum 'MUTE' level. It is recommended to set each level knob to the middle position and the main volume knob to the MIN or fully counter-clockwise position when first connecting the system.

(B) INPUT 1, INPUT 2 MIC/LINE SWITCH

Set each switch according to the equipment connected to INPUT 1 and INPUT 2. For example, if a microphone is connected to INPUT 1, set the switch to 'MIC'. If a mixing console or acoustic-electric guitar is connected then set the switch to 'LINE'.

SWITCH POSITION	INPUT IMPEDANCE
MIC	2 kOhm
LINE	40 kOhm



NOTE: The switch must be properly set to the device that is connected to the input. Any mistake may result in unexpected sound level.

(C) SIGNAL/CLIP INDICATORS

Each of the three inputs is monitored by an indicator that provides status on the incoming audio signal. The SIGNAL indicator is illuminated when there is an audio signal present with a level greater than -30dBu, approximately the lowest level before a MUTE condition. The CLIP indicator is illuminated when the audio signal is clipping and adjustments must be made to avoid amplifier shutdown and poor sound quality. Adjustments to prevent clipping are made by reducing the input signal gain/level on the appropriate channel or reducing the volume level on your audio source, if possible.

(D) INPUT 1 & INPUT 2 INPUT JACKS

A combination input on each channel allows for either XLR or ¼" TRS cable types.

(E) INPUT 3 INPUT JACKS

A pair of ¼" TS unbalanced input jacks is provided on this channel for stereo connections such as a keyboard or media device. Devices with RCA outputs can use these inputs with the appropriate cable or plug adapter. Both input jacks on this channel are summed into one mono signal.

(F) THRU 1 & THRU 2

The balanced XLR outputs THRU 1 & THRU 2 are parallel connections to the respective INPUT 1 and INPUT 2. The level controls for INPUT 1 & INPUT 2 will not affect the signal on the direct output connection.

(G) MIX OUTPUT

This is a balanced XLR output that is a sum of all three input channels. This output is not affected by changes to the Main Volume knob or the custom features but is affected by the levels set on each channel level knob. This connection is designed to provide an output which combines all three input channels together for connecting to another P1500X powered speaker or a recording device.

(H) MAIN VOLUME KNOB & REMOTE VOLUME CONTROL

It is highly recommended to have the volume set to the minimal (MIN) level upon initial system start-up and it can be adjusted two different ways. On the main volume knob, volume is increased in a clockwise rotation and decreased in a counter-clockwise rotation. Another method to control the volume is by using the Remote connection (sold separately). A removable three-terminal jack can be wired over long distances to a remote volume control device with a corresponding connection.

(I) INDICATORS

Three indicators provide operating condition status on the P1500X:

- 1) The POWER indicator (green) will illuminate when power is properly applied to the P1500X and the main power switch is 'ON'.
- 2) The LIMITER indicator (yellow) will illuminate when the P1500X automatically reduces the sound output to prevent damage to the speaker. While the P1500X is producing sound, it is suggested to reduce the volume level so the LIMITER indicator does not illuminate. Continuing use of the P1500X while this indicator is illuminated may result in a protect condition where no sound can be produced. Note, upon initial power up the indicator will blink. This is normal behavior as it will indicate the firmware version in the unit.
- 3) The PROTECT indicator (red) will illuminate when the P1500X automatically places itself into a condition where sound output is shutoff. This condition may be the result of excessive limiting, an excessive heat condition, or a low voltage condition. These conditions all can cause significant damage to the product.

*(J) CUSTOM FEATURES**ENHANCED EQ SWITCH*

The ENHANCED EQ switch adjusts the contour of the overall frequency response and attenuates the mid-range frequencies which helps increase focus on the low and high frequencies while potentially reducing feedback. This feature is ideal for situations where an external mixer or EQ device is not available or playback only situations such as mobile DJ's. It is recommended that users listen to their system with this switch both on or off to determine what is best for their needs.

VEGA BASS BOOST SWITCH

Engaging the VEGA BASS BOOST switch to 'ON' adds low frequency gain to the signal and dynamically adjusts the low-frequency response based on the speaker volume level. Leaving the switch 'OFF' and engaging the HIGH PASS FILTER is recommended when using the P1500X with a subwoofer. When using the P1500X with the P1800X subwoofer it is also recommended to engage the HPF THRU & LPF SUB switch on the P1800X for the best performance.

HIGH PASS FILTER SWITCH

When engaged to 'ON', the HIGH PASS FILTER (HPF) switch attenuates overall frequency output below 80Hz. This is recommended to reduce stage rumble when the speaker is used as a floor monitor or in situations where low frequencies need to be attenuated such as in combination with a subwoofer.

FRONT LIMITER LIGHT SWITCH

Setting the FRONT LIMITER LIGHT switch to 'ON' will enable the limiter indicator light on the front of the P1500X. This allows the user to see when the limiter is engaged in situations where it needs to be visible such as during a sound check.

P1800SX Mixer - Rear Panel

The P1800SX powered subwoofer features an assortment of controls and connections similar to the P1500X but unique to the needs of this subwoofer. It is suggested to review the P1800SX mixer, as listed below, to take full advantage of the product features.

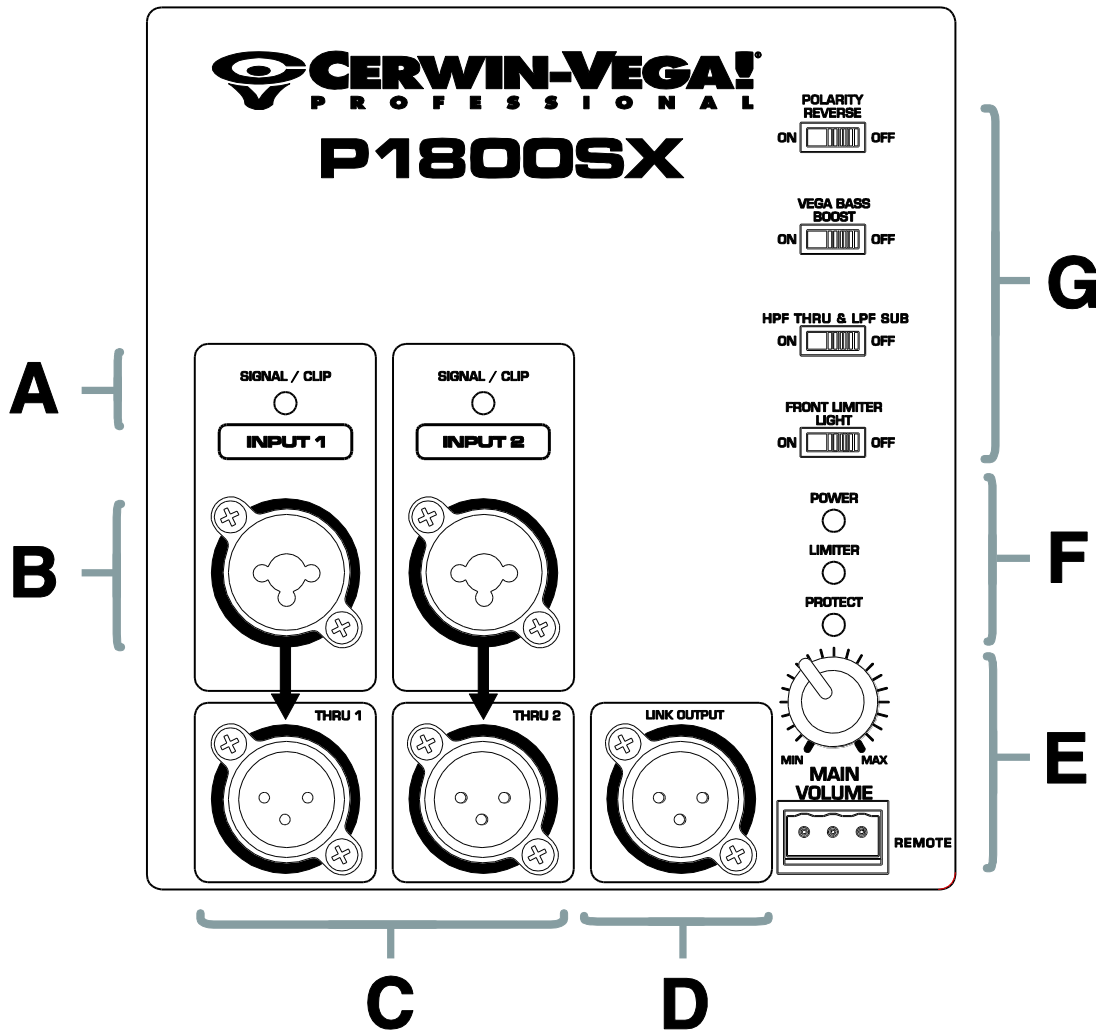

(A) SIGNAL/CLIP INDICATOR

Each of the two inputs is monitored by an indicator that provides status on the incoming audio signal. The SIGNAL indicator is illuminated when there is an audio signal present with a level greater than -30dB, approximately the lowest level before a MUTE condition. The CLIP indicator is illuminated when the audio signal is clipping and adjustments must be made to avoid amplifier shutdown and poor sound quality. Adjustments to prevent clipping are made by reducing the input signal gain/level on the appropriate channel.

(B) INPUT 1 & INPUT 2 INPUT JACKS

A combination input allows for both XLR and ¼" TRS cable types.

(C) THRU 1 & THRU 2

The balanced XLR output is a connection to the respective INPUT 1 and INPUT 2. Note, the HPF THRU & LPF SUB custom feature is placed between the INPUT and THRU.

(D) LINK OUTPUT

This is a balanced XLR output that is the sum of the two input channels. This output is not affected by changes to the Main Volume knob or the custom features. This connection is designed to provide an output which combines both channels together for connecting to an additional P1800SX.

(E) MAIN VOLUME KNOB & REMOTE VOLUME CONTROL

It is highly recommended to have the volume set to the minimal (MIN) level upon initial system start-up and it can be adjusted two different ways. On the main volume knob, volume is increased in a clockwise rotation and decreased in a counter-clockwise rotation. Another method to control the volume is by using the Remote connection (sold separately). A removable three-terminal jack can be wired over long distances to a remote volume control device with a corresponding connection.

(F) INDICATORS

Three indicators provide operating condition status on the P1800SX:

- 1) The POWER indicator (green) will illuminate when power is properly applied to the P1800SX and the main power switch is 'ON'.
- 2) The LIMITER indicator (yellow) will illuminate when the P1800SX automatically reduces the sound output to prevent damage to the speaker. While the P1800X is producing sound, it is suggested to reduce the volume level so the LIMITER indicator does not illuminate. Continuing use of the P1800SX while this indicator is illuminated may result in a protect condition where no sound can be produced. Note, upon initial power up the indicator will blink. This is normal behavior as it will indicate the firmware version in the unit.
- 3) The PROTECT indicator (red) will illuminate when the P1800SX automatically places itself into a condition where sound output is shutdown. This condition may be the result of excessive limiting, an excessive heat condition, or a low voltage condition. These conditions all can cause significant damage to the product.

(G) CUSTOM FEATURES***POLARITY REVERSE***

In situations where the P1800SX is not optimally located, a polarity reverse switch is provided which inverts the phase of the audio signal by 180 degrees and can improve low frequency performance. In certain situations, the location of the subwoofer may be out of phase with the full-range speakers. By reversing the polarity of the subwoofer, the phase will match the full-range with the benefit of not having to relocate the subwoofer.

VEGA BASS BOOST SWITCH

Engaging the VEGA BASS BOOST switch to 'ON' adds low frequency gain to the signal and dynamically adjusts the low-frequency response based on the subwoofer volume level.

HPF THRU & LPF SUB

When turned on, the HPF THRU & LPF SUB switch engages two filters simultaneously:

- 1) A low pass filter will attenuate frequencies above 80Hz for the P1800X subwoofer.
- 2) A high pass filter will attenuate frequencies below 80Hz on the THRU 1 & 2 outputs. This is recommended when using the subwoofer in combination with other speakers such as the P1500X.

FRONT LIMITER LIGHT

Setting the FRONT LIMITER LIGHT switch to 'ON' will enable the limiter indicator light on the front of the P1800SX. This allows the user to see when the limiter is engaged in situations where it needs to be visible such as during a sound check.

P1500X and P1800SX Power Connections - Rear Panel

The P1500X and P1800SX power connections are located on the rear panel. It is suggested to understand the power connections and descriptions below to insure proper use.

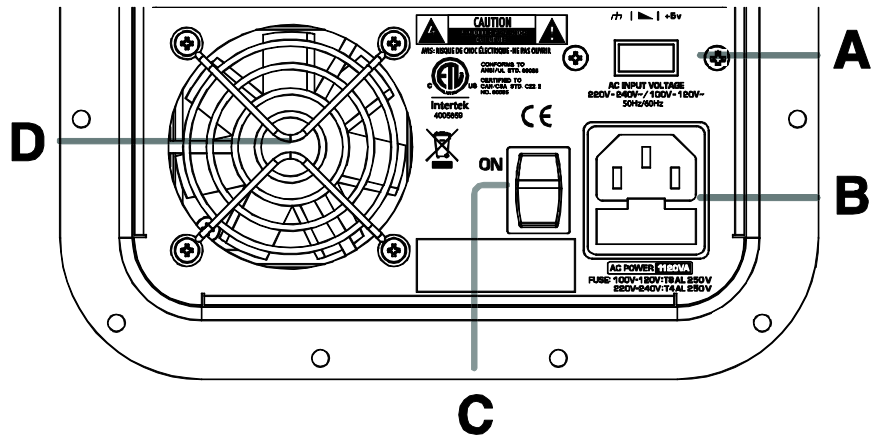

(A) MAIN POWER VOLTAGE SELECTOR

The loudspeaker can be used with 100-120V AC or 220-240V AC power supply lines. Be sure the voltage selector switch is set to the proper voltage before connecting the power cord. In addition, if the selector is adjusted from its shipped setting, be sure the proper fuse has been installed. Any failure to meet these instructions may result in damage to the loudspeaker.

(B) POWER INLET & FUSE

The power inlet is an IEC receptacle type and should only be used with the power cord, or rated-equivalent, that is included with the loudspeaker.

Below the power inlet is the fuse holder that can only be accessed when the power cord is removed. Be sure to replace the fuse with rated-equivalent (see Specification section).

(C) MAIN POWER SWITCH

The ON/OFF master switch controls the power to the loudspeaker. Be sure all connections and audio settings are set at a safe level before placing the loudspeaker into an 'ON' condition.

(D) FAN

The fan is automatically controlled by the loudspeaker and provides air-flow ventilation for the internal electronics. The fan should never be blocked in order to insure proper cooling air flow to the electronics.

Using the P1500X as a floor/stage monitor

The P1500X can be used as a floor monitor by laying the cabinet on its side at a fixed 45 degree angle toward the performers. It is recommended to engage the HIGH PASS FILTER which cuts low frequencies to minimize any low frequency bass-coupling or stage rumble between the loudspeaker and the stage platform. Be sure that the P1500X and cables are not located where they can become a tripping hazard. It is recommended to use right angle XLR or right angle ¼" jacks where possible to avoid cable binding between the loudspeaker and stage platform.

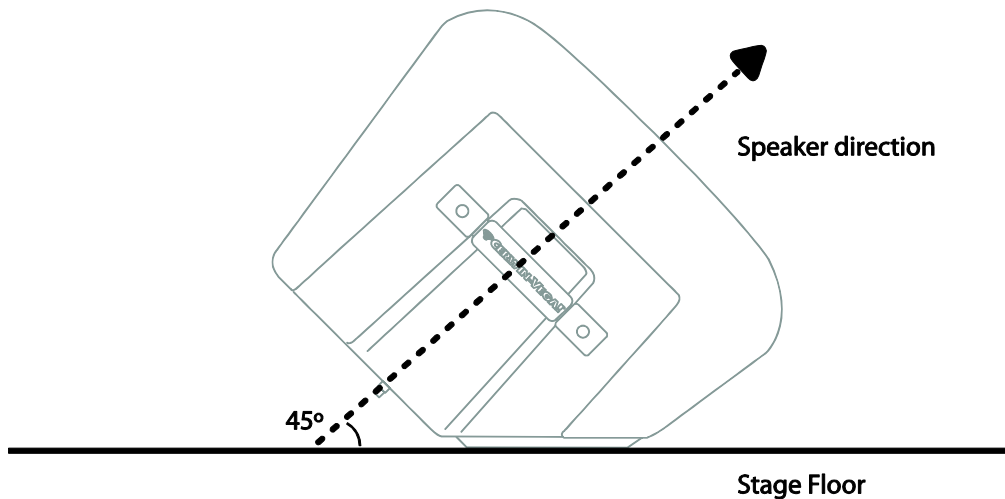

Using the pole mount

The P1500X has two different pole mounting angles: level and 7.5 degrees down. This allows the loudspeaker to be adjusted to an angle that provides optimal audience coverage. For example, a loudspeaker placed on a raised stage platform may have the pole mount adjusted to 7.5 degrees downward so the front audience will not be missed.

Adjust the pole mount angle on the loudspeaker before it is placed onto a pole. On the bottom of the loudspeaker is a rotatable disc with two tabs and a position indicator. Use the two tabs to rotate the disc so that the position indicator is aligned with either 0 (level) or 7.5 (angle downwards). Be sure the disc 'clicks' into place and cannot rotate freely.

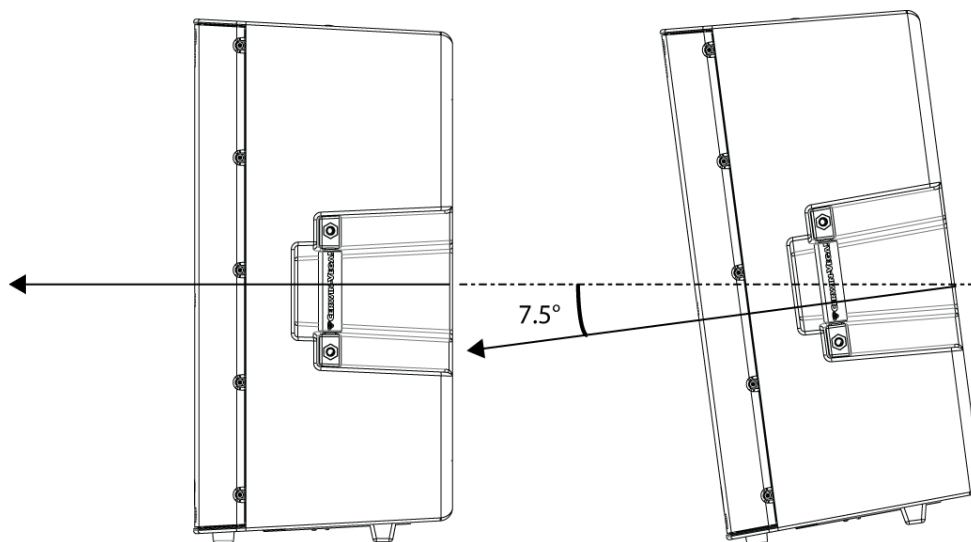
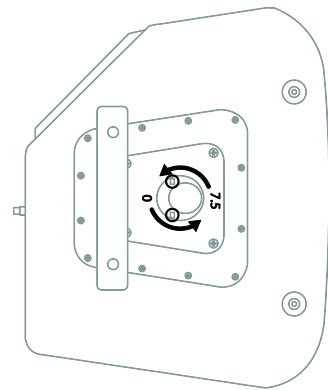

CAUTION: When using stands or poles, be sure to observe the following:

- Make sure the pole stand is capable of handling the weight of the loudspeaker. Be sure to observe all precautions as indicated by the pole stand manufacturer.
- The pole stand must be placed on a flat, level and stable surface with the legs fully extended. The pole stand legs should be placed where they will not present a tripping hazard.
- Power cables and audio signal cables must be placed in a location where they will not create a tripping hazard or topple the speakers over when moved or pulled.
- When placing the loudspeakers on top of the pole stand, be sure to ask for help.
- Before loudspeaker pole mounting, be sure to inspect all critical points for any cracks, deformations, corrosion and/or missing parts that may affect the strength and safety of the installation.
- Only use a pole stand intended for loudspeaker use.
- Avoid placing the pole stand and loudspeaker in an area of traffic to prevent accidental contact.
- In a windy environment, be sure to use additional weight to support (sandbags) on the base of the pole stand for additional stability. Do not attach banners, signage or balloons to the pole stand and/or the loudspeaker.
- Consult a licensed, professional engineer regarding equipment installation and ensure that all local, state and national regulations regarding the safety and operation of loudspeakers and related equipment are understood and adhered to.

Using the suspension points

The P1500X suspension points are M10 threads with a depth of 25mm. Two suspension points are located on each handle (top for vertical orientation and on the side for horizontal orientation) as well as two pull-back points located on the rear of the unit.

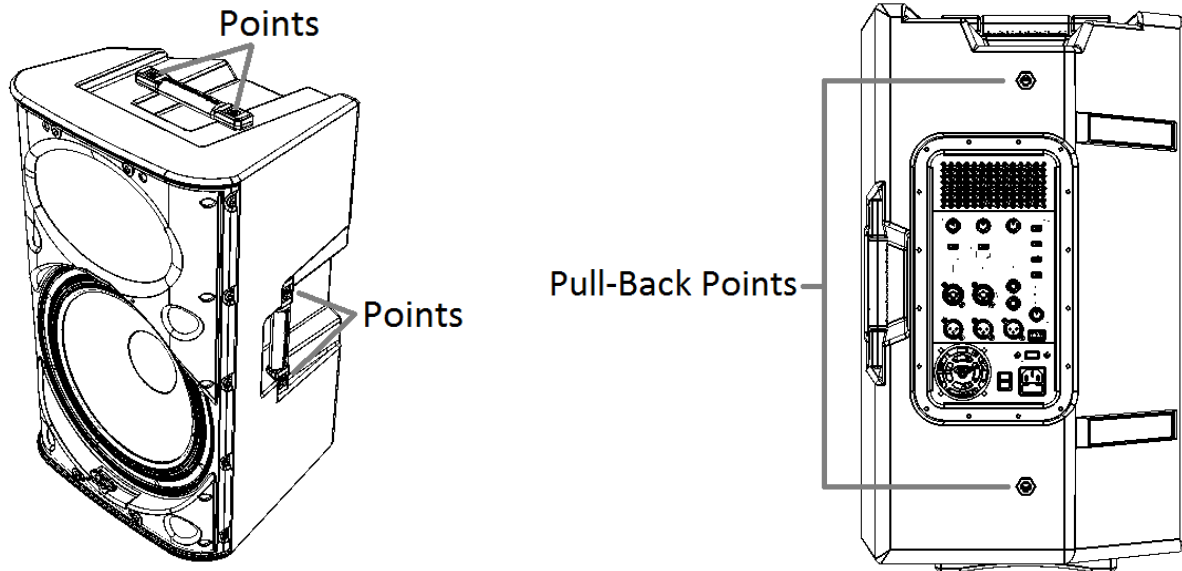

CAUTION: When using suspension installation, be sure to observe the following:

- Loudspeaker suspension requires qualified persons who are familiar with rigging standards and practices. Any unsafe mounting of any heavy load can result in serious injury and equipment damage.
- Consult a licensed, professional engineer regarding equipment installation and ensure that all local, state and national regulations regarding the safety and operation of loudspeakers and related equipment are understood and adhered to.
- Do not attempt to suspend the loudspeakers by the handles.
- Before loudspeaker suspension, be sure to inspect all critical points for any cracks, deformations, corrosion and/or missing parts that may affect the strength and safety of the installation.
- Only use commercially-available M10 load-rated shoulder eyebolts along with rigging hardware appropriate for the actual load.
- Fittings and rigging hardware may deteriorate over extended periods of time due to wear and/or corrosion, be sure the installed is checked thoroughly by qualified personal at regular intervals.
- Cerwin-Vega! cannot be held responsible for damage or injury caused by insufficient strength of the support structure or improper installation.
- Do not use the pull-back point as the suspension point for a majority of the load. The pull-back points are intended for angling the loudspeaker downwards only. Note that the loudspeaker suspension points are intended for one loudspeaker only.

Application #1 – Single P1500X

A single P1500X powered speaker can be used to reinforce sound for a wide variety of performances. The diagram below shows an application where a vocal microphone, an acoustic-electric guitar and either a keyboard or media player are used together. Each individual channel volume can be adjusted to create the right balance while the main volume knob controls the overall audience volume.

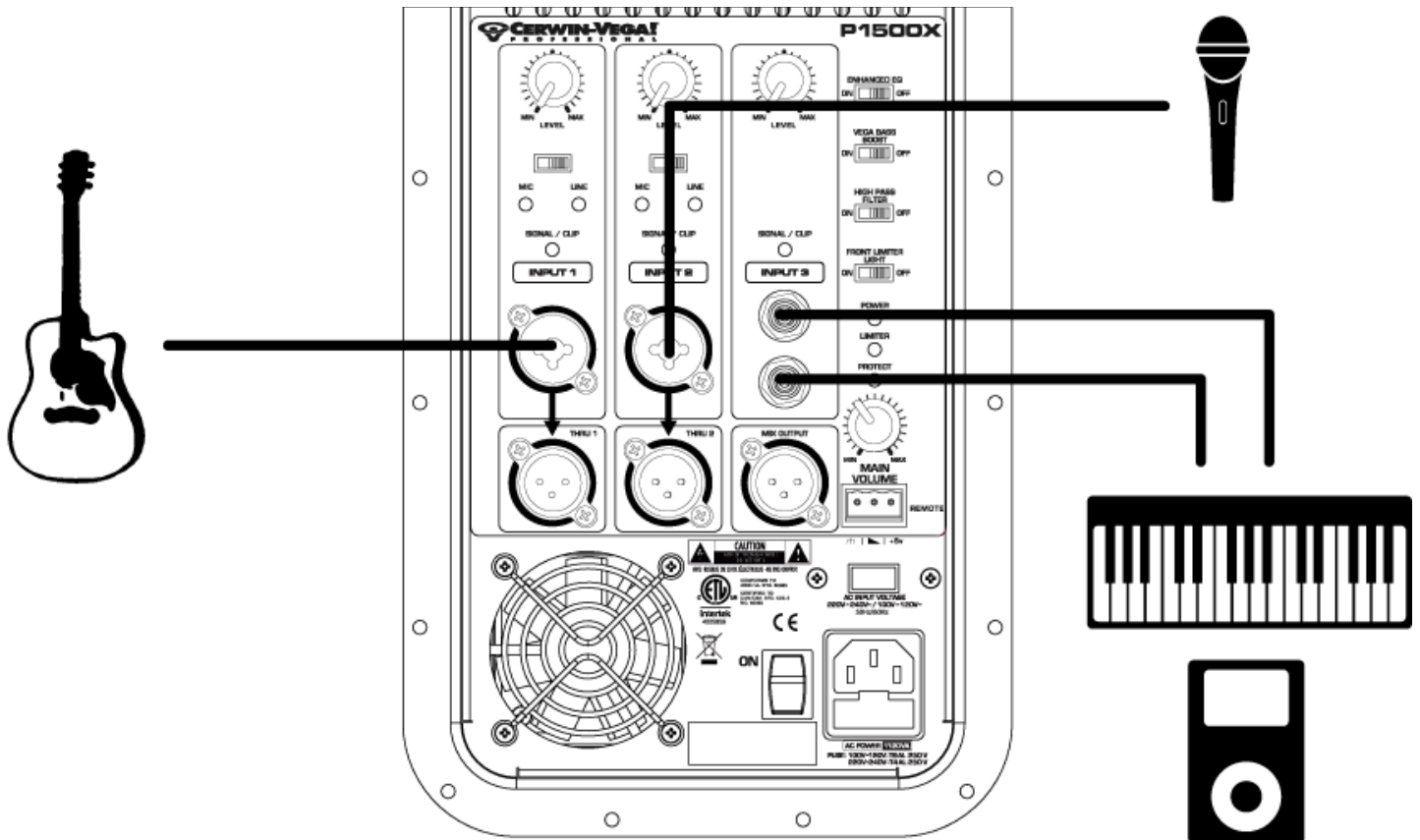

	Equipment	Cable Type
Input 1	Acoustic-Electric Guitar (Set switch to LINE)	¼" TS (standard guitar cable)
Input 2	Microphone (Set switch to MIC)	XLR
Input 3	Keyboard (or media player)	Dual ¼" TS (or RCA*)

* Devices with RCA outputs can use INPUT 3 with the appropriate cable or plug adapters.

Application #2 – Adding a second P1500X

A second P1500X loudspeaker can easily be added using a standard XLR/mic cable as in the example below. A two speaker system can cover a wider audience and situations where more volume is needed. To add a second P1500X loudspeaker, connect the MIX OUTPUT of the first speaker to INPUT 1 or INPUT 2 on the second speaker then set the level and main volume to an appropriate setting on the first speaker. Be aware that the main volume on the first speaker will not change the volume on the second speaker so make sure to set the input and main volume knobs to similar settings.

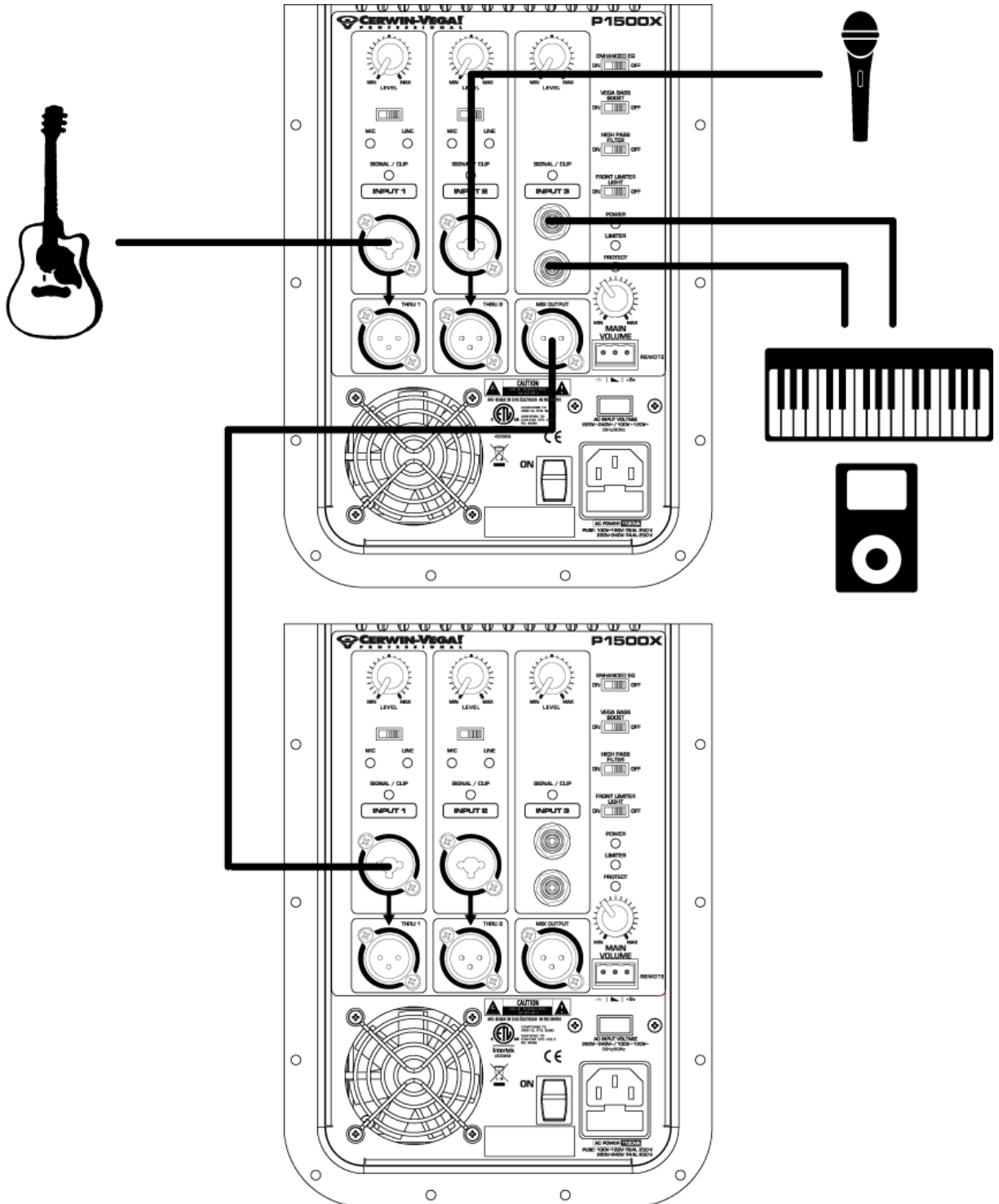

Application #3 – Adding Subwoofers

For demanding applications where even greater bass response is ideal, adding subwoofers to a pair of P1500X speakers is a great idea. In the diagram below, an audio source is connected to INPUT 1 on each P1800SX subwoofer and then the signal is linked to the P1500X speakers by using the P1800SX THRU 1 outputs. The P1500X and P1800SX also have CUSTOM FEATURES that allow them to work together efficiently which is covered on the next page.

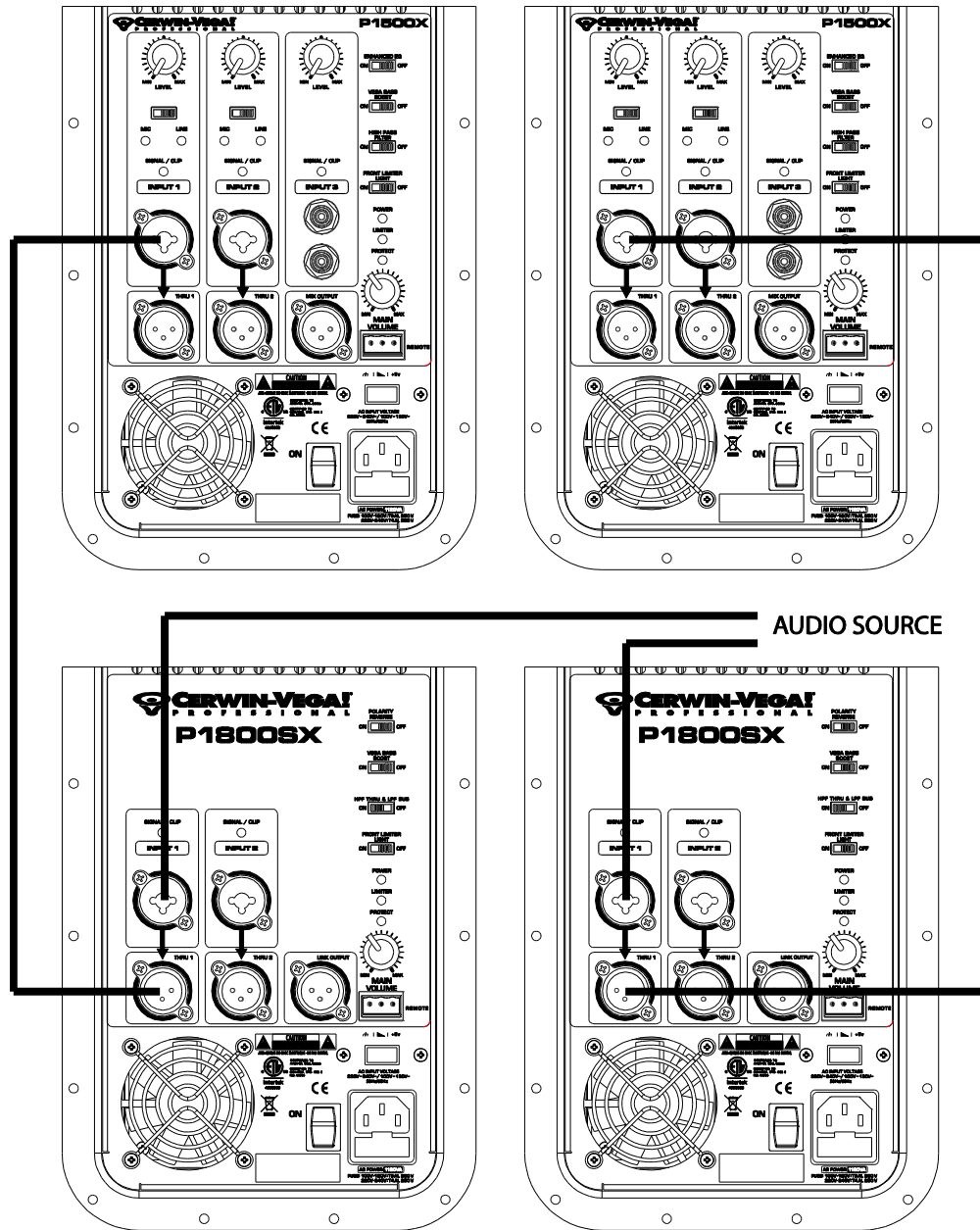

P1500X	Equipment	Cable Type
Input 1	From P1800SX THRU 1 output	XLR
P1800SX	Equipment	Cable Type
Input 1	From Audio Source	XLR or ¼" TRS

Application #3 – Adding Subwoofers (Adjusting HPF & LPF Filters continued)

When using the P1500X and P1800SX together it is important to know how to set the HIGH PASS FILTER switch on the P1500X and the HPF THRU & LPF SUB switch on the P1800SX so that both speakers work well together. Fortunately, this system is designed so that the user can route the audio source to either the P1500X or P1800SX depending on the situation. The settings below have been provided for either setup.

SIGNAL FLOW

TOP (P1500X) to BOTTOM (P1800SX)

SIGNAL FLOW

BOTTOM (P1800SX) to TOP (P1500X)

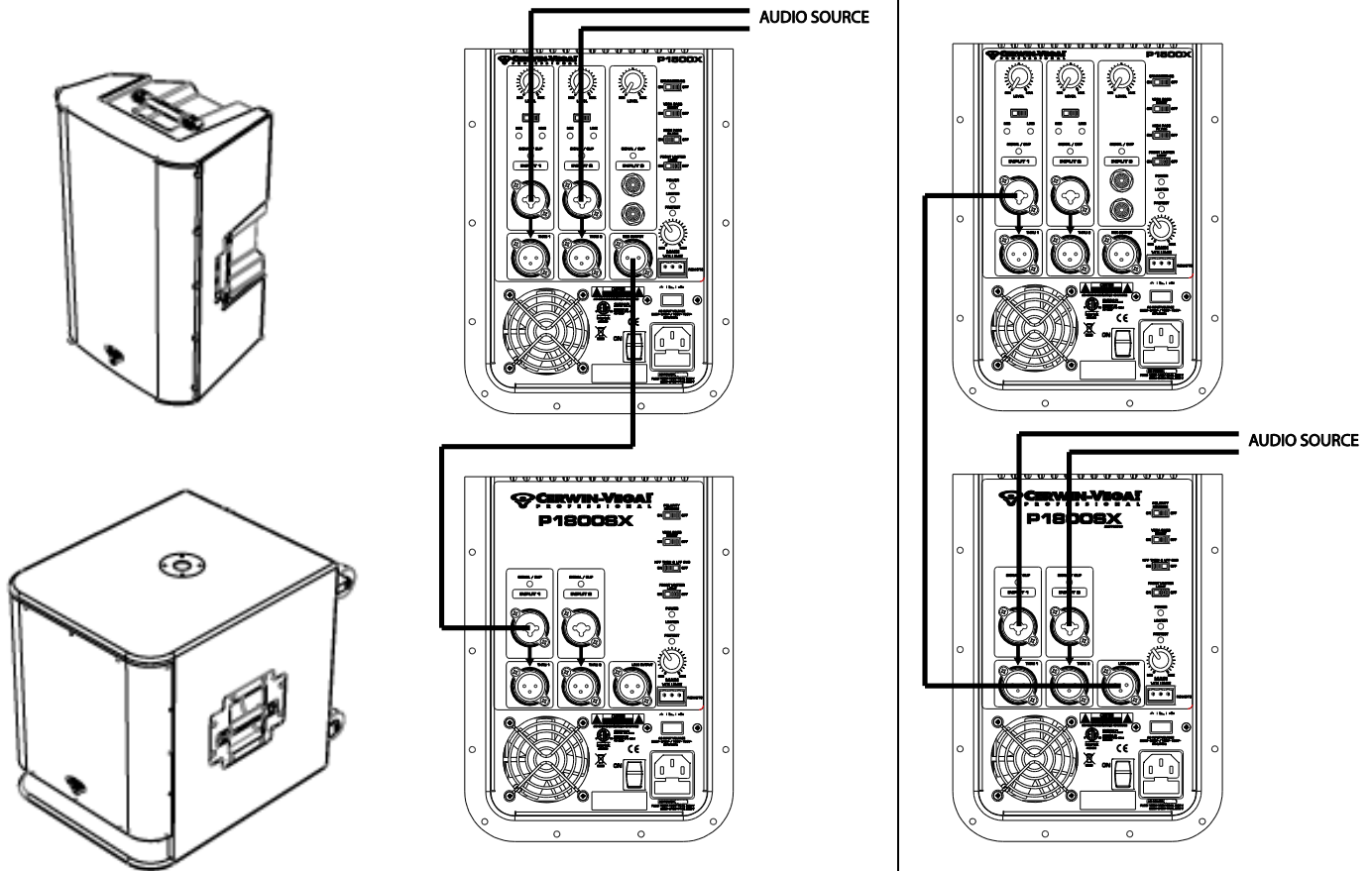

RECOMMENDED SETTINGS

P1500X: High Pass Filter is ON
 P1800SX: HPF THRU & LPF SUB is ON

P1500X: High Pass Filter is OFF
 P1800SX: HPF THRU & LPF SUB is ON



NOTE: Using a standard speaker pole, the P1500X and P1800SX active subwoofer create a complementary system that is easy to setup and transport.

Application #4 – Daisy-Chain

Some events may require several P1500X speakers spread across a long distance or a large stage front to provide adequate sound reinforcement for the entire audience. Since there are multiple sources, the loop out from the mix output should be used to daisy-chain to the next P1500X and then use the thru-out from the second speaker onward.

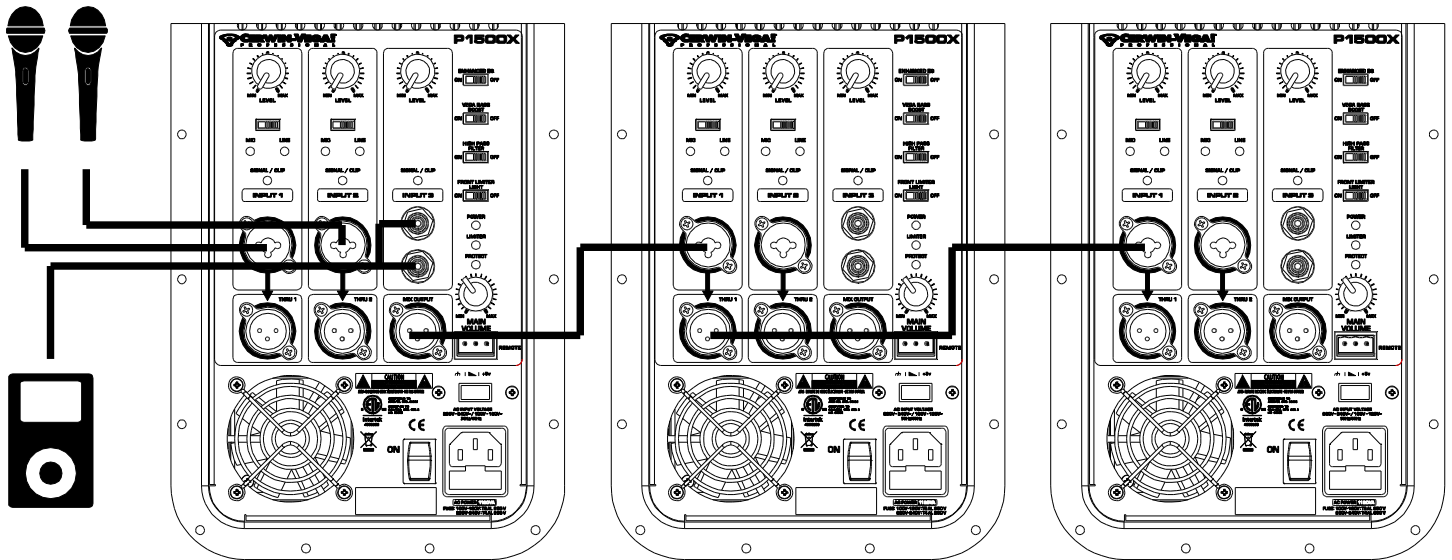

	Equipment	Cable Type
Input 1	Microphone (Set switch to MIC)	XLR
Input 2	Microphone (Set switch to MIC)	XLR
Input 3	Player (Left-to-Left, Right-to-Right)	1/8" to dual 1/4" TS(or RCA*)
MIX OUTPUT	P1500X next in daisy-chain (Input 1, Set switch to LINE)	XLR

* Devices with RCA outputs can use INPUT 3 with the appropriate cable or plug adapters.

Application #5 – Adding a P1500X as a Stage Monitor

In a live performance, the performer may wish to have a stage monitor to help hear the performance better. The diagram below shows a P1500X used as a stage monitor for the performer plus two P1500X speakers (daisy-chained) for the audience. The performer(s) may have a different mix requirement than the audience which means all the THRU outputs from the performer(s) must be taken to the first loudspeaker used to cover the audience. At the first loudspeaker, the input levels can be mixed to the preferred presentation for the audience. The performer's monitor can be mixed to the performer's specific requirements without affecting what the audience hears



NOTE: Careful positioning of the monitor loudspeaker is required as the proximity to the microphone is susceptible to feedback. As a general rule, never point the microphone towards the loudspeaker.

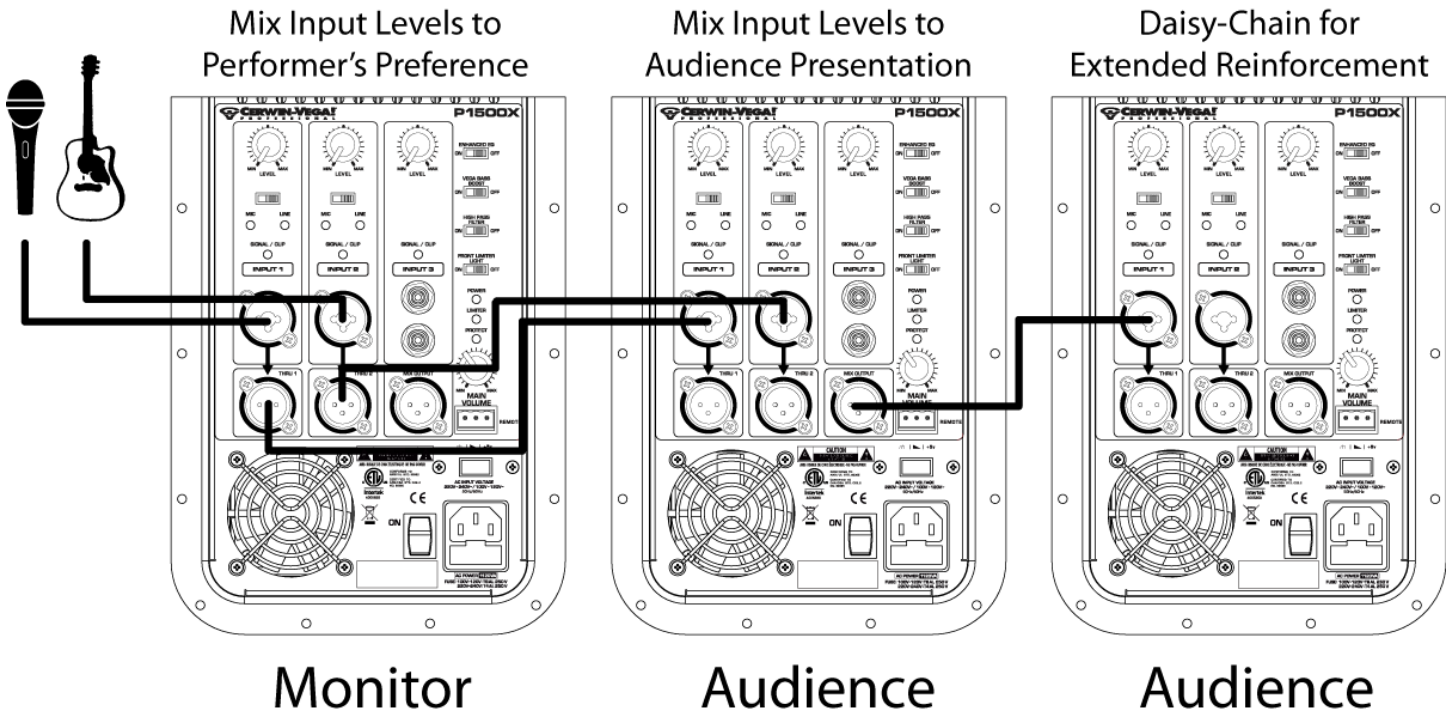

Application #6 – Large Venue/Front of House

In larger venues the Front of House engineer has control of the entire sound reinforcement system using the console mixer. The diagram below shows how a console mixer interfaces with the performers' on-stage audio equipment with several P1500X speakers directed towards the audience.

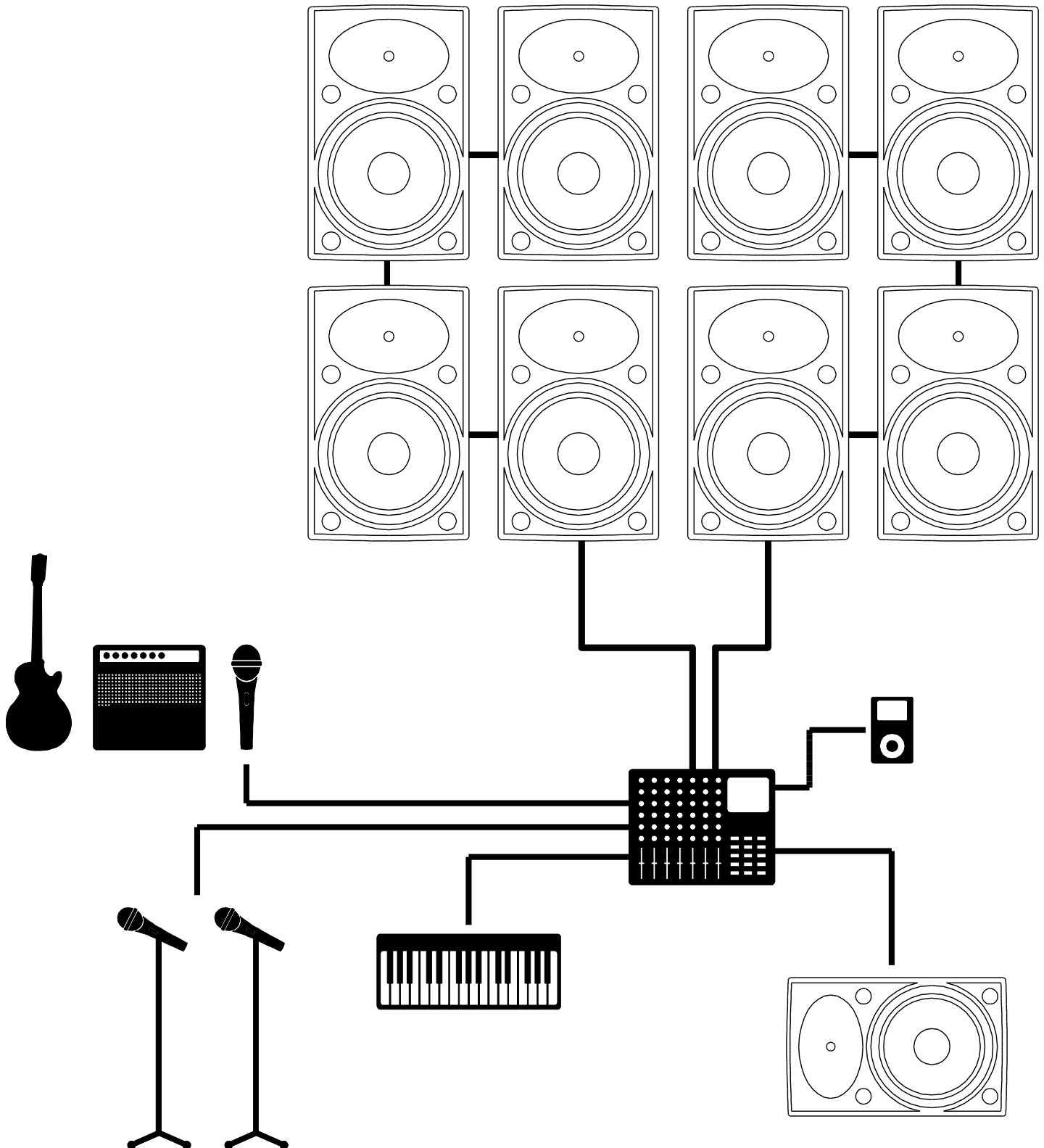

Protective Grill

The P1500X and P1800SX are shipped with the grill attached. It is recommended to leave the grill in place as it will prevent any accidental damage to the drivers that may result during transportation, setup and general use.

In the event that the grill needs to be removed, simply remove the hex-head screws around the edge of the grill. Remove the grill slowly to avoid damaging the gasket. When replacing the grill, be sure the gasket is in place and all fasteners are secured in tightly to prevent rattling during general use.

Remote Main Volume

The 3-pin terminal connector plug allows the P1500X or P1800SX main volume level to be controlled from a remote location through signal wires and an external device (not included). The signal wire passes only a voltage level and not the actual audio signal. A single device can control the main volume of multiple units when connected correctly. The potentiometer should be 10kOhm and specified to support numerous rotations as required for volume control use.



NOTE: Do not use the remote main volume connection for anything other than volume control through the external device. Failure to follow this warning may result in damage to the loudspeaker.

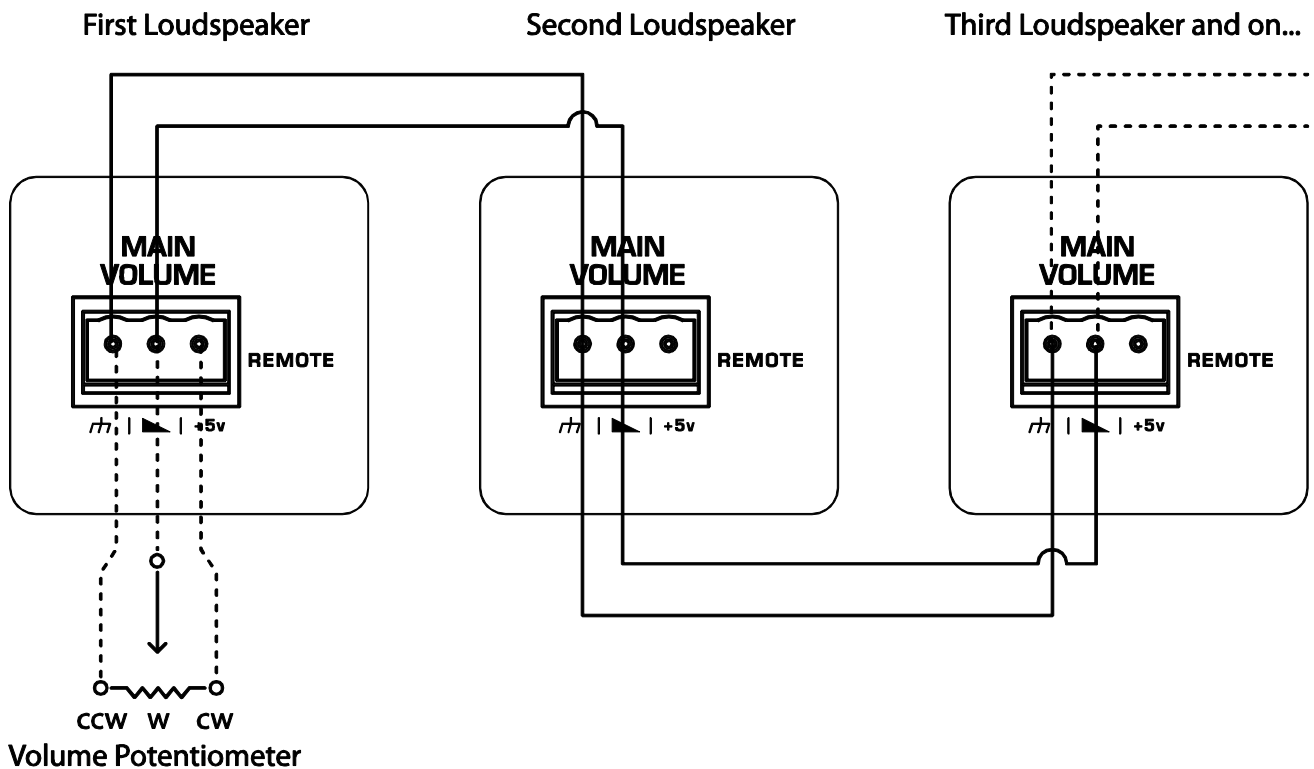

System Block Diagram (P1500X full-range loudspeaker)

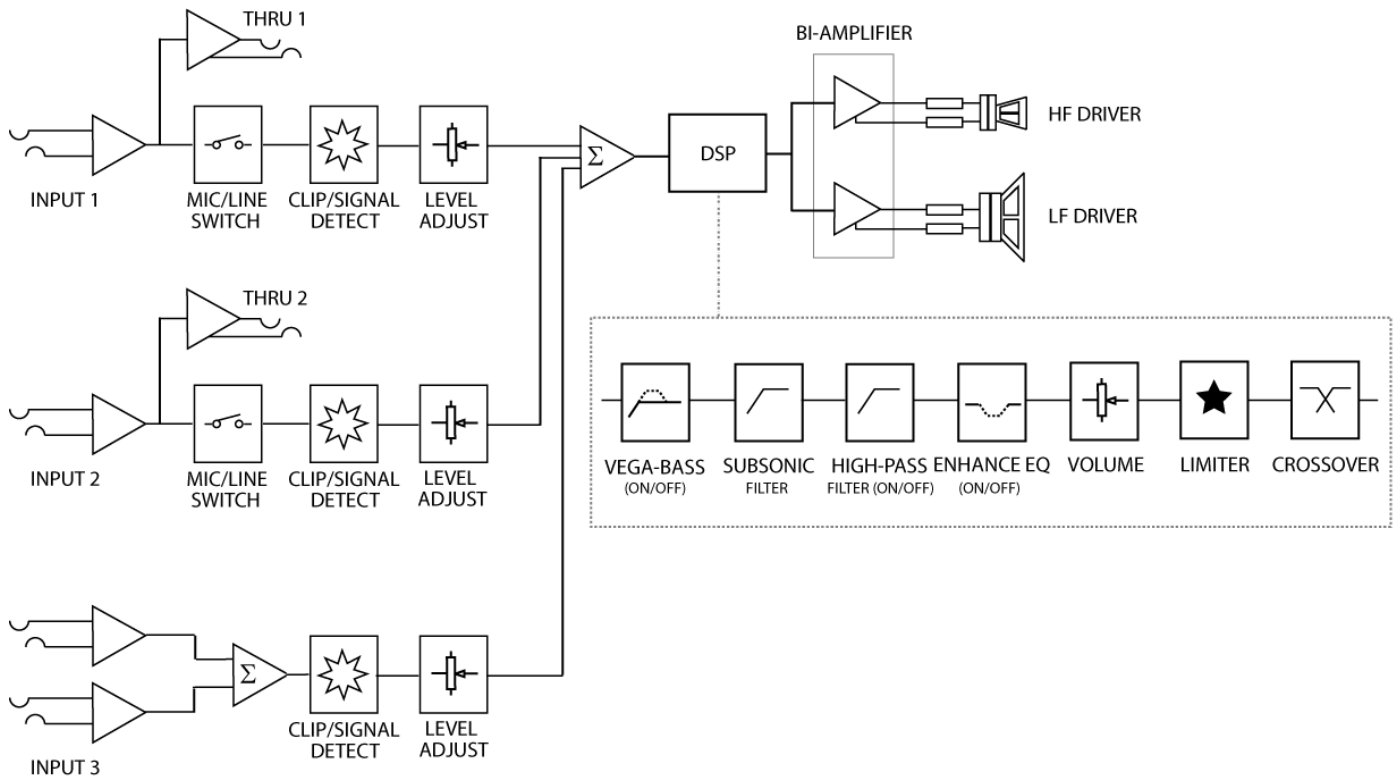

System Block Diagram (P1800SX subwoofer)

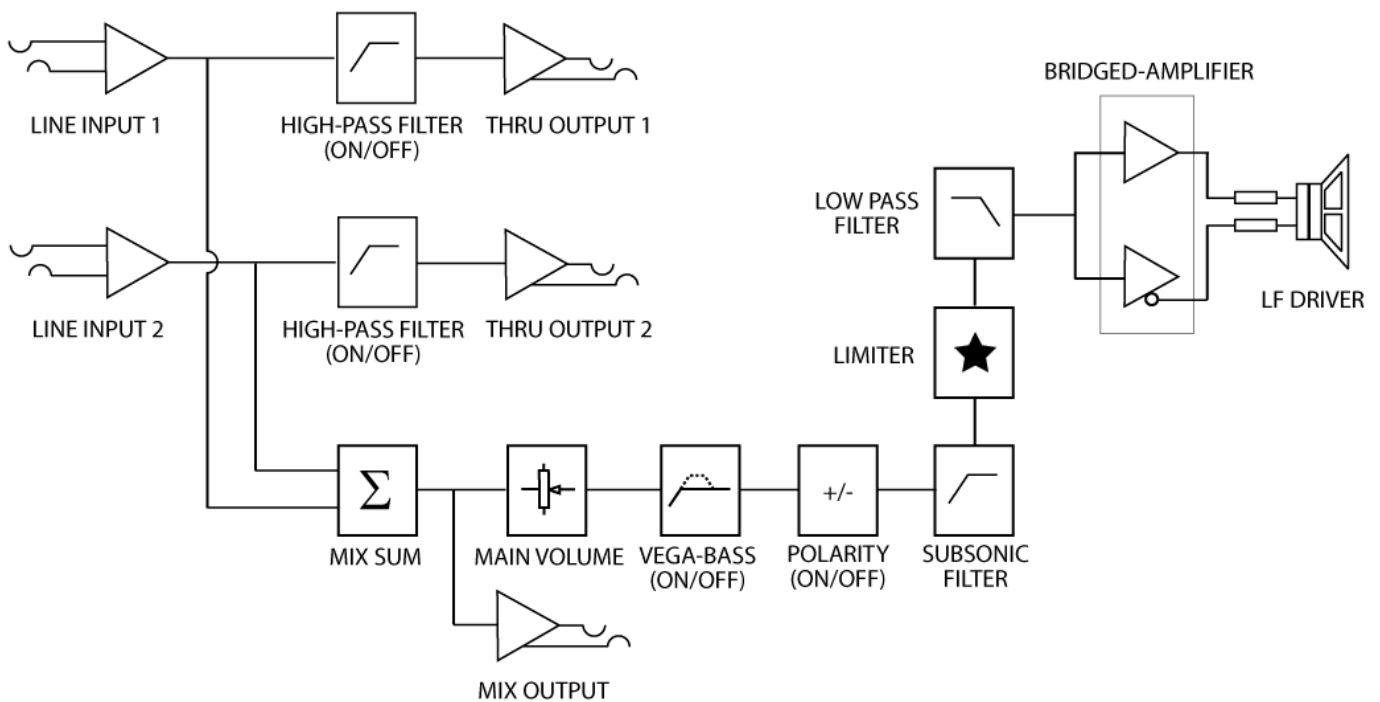

Troubleshooting

Problem	Cause	Solution
No Sound	Loudspeaker is not connected to active AC power	Verify the loudspeaker is indeed connected to an active AC power source. Various outlets may need to be switched 'on'. Use a lamp as another way to be sure the AC power source is active.
	Loudspeaker power switch is in the 'OFF' position	Verify that the power switch on the back of the loudspeaker is 'ON'.
	Input level is set to minimum setting	Set the input level to a setting where sound can be heard.
	Main volume is set to minimum setting	Set the volume level to a setting where sound can be heard.
	Audio source is not active, volume is set too low, or poor connection	<ul style="list-style-type: none"> • Use the Signal indicator on the back of the loudspeaker to verify an audio signal is indeed present. • Verify that the audio equipment is turned 'ON' and set to output an audio signal at a volume level above minimum. • Verify the cable connection from the audio source output to the loudspeaker input is correct. • Audio mixers may have a MUTE or LOOP switch that may need to be disengaged. • Microphones that require phantom power must be used with an external power source.
No Power	Loudspeaker is not connected to active AC power	Verify the loudspeaker is indeed connected to an active AC power source. Various outlets may need to be switched 'ON'. Use a lamp as another way to be sure the AC power source is active.
	Loudspeaker power switch is in the 'OFF' position	Verify that the power switch on the back of the loudspeaker is 'ON'.
	AC power source voltage is too low or high	Verify if the AC power source is too low or too high. The loudspeaker will protect itself if the AC power source is 10% lower or 10% higher than the loudspeaker's intended voltage setting.
	Loudspeaker fuse is blown	Disconnect all power connections and inspect and replace, if necessary, the fuse located on the rear of the loudspeaker. See Specifications for fuse information.
Shutdown	Loudspeaker self-protection	<ul style="list-style-type: none"> • Avoid placing the loudspeaker near a heat source or under direct sun light. • Avoid using an audio source with clipped and/or distorted input signal. • Verify the limiter indicators are not always on and if so, lower the input and volume levels until the limiter indicator is 'OFF'.

Troubleshooting (continued)

Bad Sound	Equipment settings are not set properly causing distortion	<ul style="list-style-type: none"> • Check the meters on the external mixing console to ensure that the signal is not being clipped by the mixer, if the levels from the mixer are too hot correct the gain structure of the console; first by lowering the pre-amplifier trim (input sensitivity), if this does not lower the signal level sufficiently then lower the channel fader, and if the level is still too hot then lower the master bus (but most likely a clipped input is the source of the distortion). It is important to check every active input channel on the console to ensure that each input trim is set correctly for each source. • If the signal sources are plugged directly into the P1500X make sure that the input level knobs are not turned up too high. If the signal indicator LED is turning RED on any channel that means the input on that channel is clipping and the input level needs to be lowered. It is also possible that the source level will need to be lowered. If distortion is still audible after lowering the source level and input level knob then lower the master volume knob on the P1500X. • Check that the audio source and/or mixer do not have excessive bass or treble added to the mix, overdriven EQ's can clip causing audible distortion.
Bad cable connections	Verify that all connections are good. Verify the connectors are clean and free of any residue build-up. Verify the insulation jacket on all cables has not been torn or crushed.	
Rattling Sounds	Be sure the rattling sounds do not come from the caster wheels (subwoofer only), loudspeaker stands or any furniture or fixtures located near the system.	
Bad AC mains cable location	<p>Avoid using an AC power source that is connected to a light dimmer. Use an AC filter box or use a different AC circuit.</p> <p>Avoid routing the audio signal cables along other power cables, transformers and signal cables to prevent interference.</p>	
Ground loop 'hum'	<p>Turn all volume and input levels to the minimum setting to verify there is no 'hum' coming from the connected audio equipment. If the 'hum' is still present, than remove all audio cable connections and if the 'hum' disappears than there is a potential ground loop problem. Ground lifting the signal cable (with a direct box or coupling transformer) is the safest way to eliminate ground loops within sound setups. Plug all audio equipment AC power connections into the same outlet which shares a common ground (make sure the outlet is capable of supporting the equipment to avoid overloading the circuit). Verify that the distance between AC power source and common ground is as short as possible.</p>	
Equipment 'hiss'	<p>Use a balanced connection (instead of an unbalanced connection) to take advantage of the best noise rejection.</p> <p>Plug all audio equipment AC power connections into the same outlet which shares a common ground (make sure the outlet is capable of supporting the equipment to avoid overloading the circuit).</p>	

Specifications

	P1500X	P1800SX
System Type:	Active 2-way full-range, bass reflex	Active Subwoofer, bass reflex
Frequency Range (-10 dB):	49.8 Hz – 23.5 kHz	31.5 Hz – 272.0 Hz
Frequency Response (±3 dB):	55.0 Hz – 20.5 kHz	38.0 Hz – 183.0 Hz
Nominal Coverage (-6 dB):	90° Horizontal, 65° Vertical	not applicable
Maximum SPL ⁽¹⁾ @ 1m:	134 dB	136 dB
Amplifier Type:	Class D	Class D
Amplifier Rating:	1500 Watts Dynamic 540 Watts Continuous	2000 Watts Dynamic 725 Watts Continuous
Low Frequency Driver:	15"	18"
High Frequency Driver:	1¾" diaphragm, 1" exit	not applicable
Connectors:	CH 1&2 - Neutrik™ XLR/TRS inputs, CH3 Dual ¼" TS THRU 1&2 - XLR, MIX - XLR	CH 1&2 - Neutrik™ XLR/TRS inputs THRU 1&2 - XLR, LINK - XLR
Impedance:	CH 1&2 – 20 kΩ, CH3 – 10 kΩ	CH 1&2 – 20 kΩ
Indicators:	Signal/Clip, Power, Limiter, Protect	Signal/Clip, Power, Limiter, Protect
Enclosure:	Polymer cabinet, flush waveguide	18mm reinforced wood cabinet
Grille:	18 gauge, perforated steel	18 gauge, perforated steel
Mounting & Suspension:	7.5° or flat, 35mm pole socket 4 x M10 suspension, 2 x M10 pull-back	35mm pole socket
Operating Temperature:	-20° to 55°C	-20° to 55°C
Dimensions (H x W x D):	27.5" x 17.0" x 13.5" (699mm x 432mm x 343mm)	24.25" x 20.0" x 24.5" (616mm x 508mm x 622mm)
Weight:	53.0 lbs (24.0 kg)	84.0 lbs (38.1 kg) with casters 77.0 lbs (34.9 kg) without casters
Shipping Dimensions (H x W x D):	32.0" x 21.5" x 18.5" (813mm x 546mm x 470mm)	27.25" x 22.0" x 26.5" (692mm x 559mm x 673mm)
Shipping Weight:	60.5 lbs (27.4 kg)	93.5 lbs (42.4 kg)
Fuse (5mm x 20mm):	T8A/250V (120V version) T4A/250V (240V version)	T8A/250V (120V version) T4A/250V (240V version)
Amplifier Service Part Number:	AMPP00012	AMPP00013

⁽¹⁾ Maximum SPL. In accordance with industry standard practice the Maximum SPL is calculated based upon the following equation: Peak Transducer Sensitivity (dB) + Dynamic Amplifier Power (dB). The amplifier power measurement was performed with the limiter protection circuits engaged. Full range loudspeakers are measured in full space and subwoofers are measured in half space.

Package Contents

	P1500X	P1800SX
	Active Loudspeaker	Active Subwoofer
	Manual	Manual
	Power Cord (2M, 10Amps)	Power Cord (2M, 15Amps)
	Spare Fuse (inside fuse holder)	Spare Fuse (inside fuse holder)
	-	Casters with mounting hardware

Care and Maintenance

Before any cleaning or maintenance, be sure the loudspeaker is unplugged, turned off, and that all cables are removed. Be sure to avoid any moisture coming into the openings of the speaker.

The loudspeaker can be maintained cosmetically using a dry cloth. Avoid using cleaning chemicals as they may harm the finish of the loudspeaker. A direct burst of air should be avoided and may harm the drivers as well as assisting debris into the enclosure.

When storing the loudspeaker, be sure it is above ground to avoid accidental flooding and excess dust build-up. It is suggested to cover the loudspeaker while it is placed in storage or being transported.

Appendix A - Cable Connections

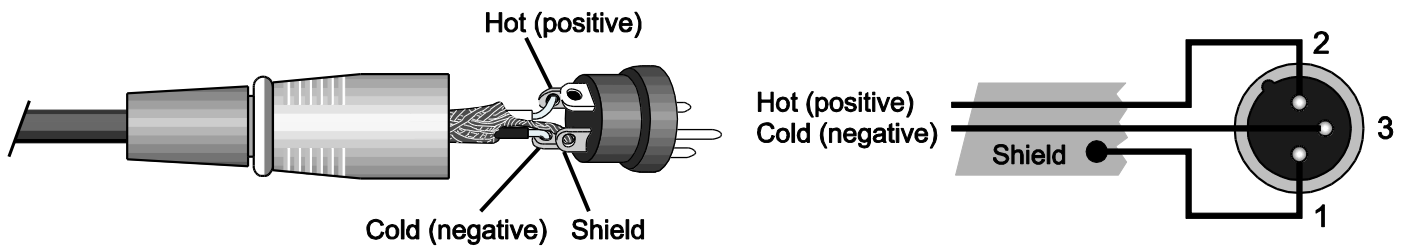

XLR Balanced Input

1/4" TRS Balanced

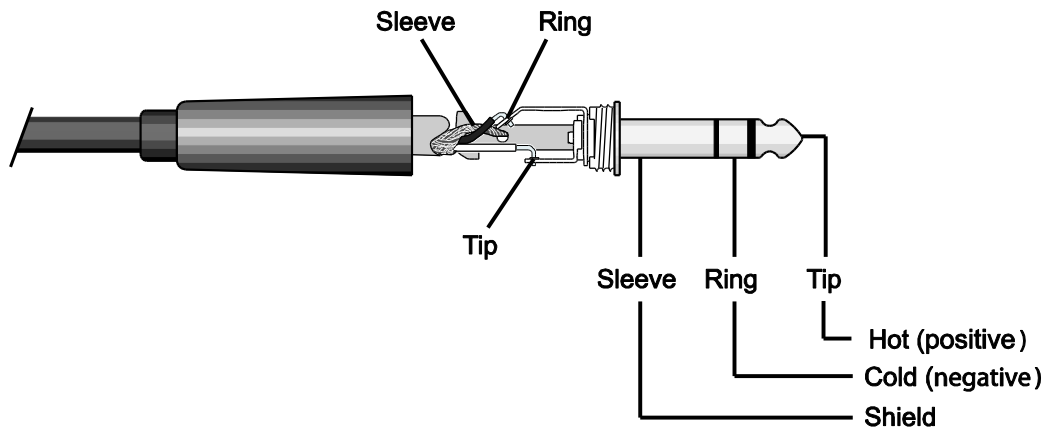

1/4" TS Unbalanced

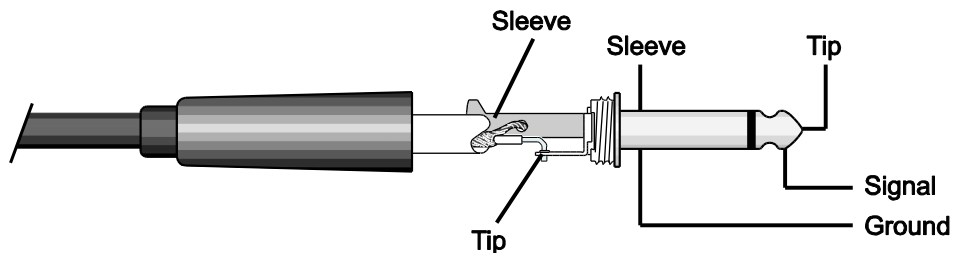

REMOTE DEVICE DESCRIPTION

CABLE

REMOTE SIDE OF CABLE (Connector Type)

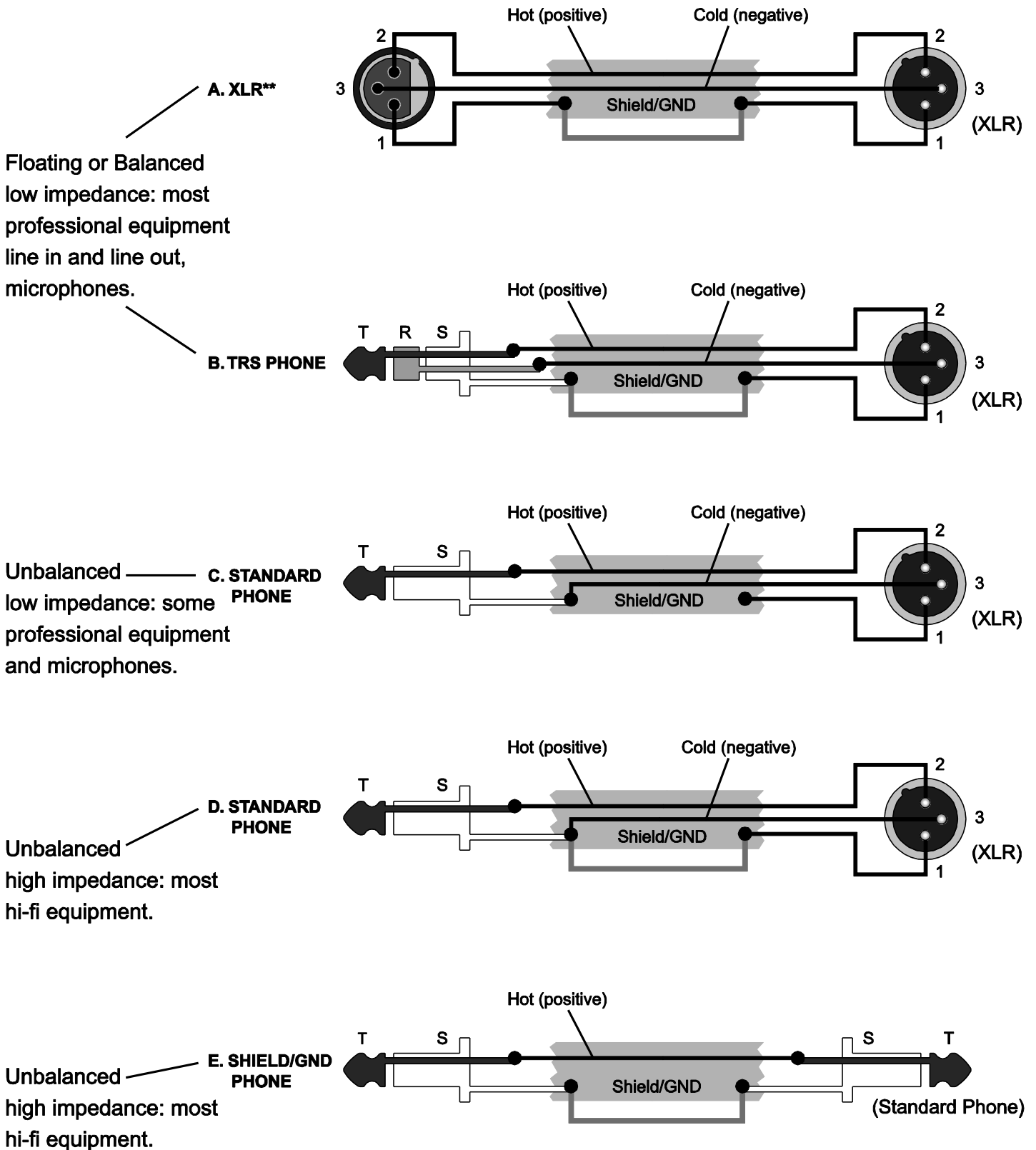

Warranty

Thank you for choosing one of Gibson Pro Audio's brands (Stanton, KRK, or Cerwin Vega!).

Your satisfaction is extremely important to us. We proudly stand behind the quality of our work and appreciate that you put your trust in us. Registering your merchandise will help us guarantee that you are kept up to date on our latest advances.

To Register Merchandise Purchased from an Authorized Gibson Pro Audio Dealer in the U.S.:

Please go to: <http://www.gibson.com> and register online.

Or you may send your warranty card to:

Gibson Customer Service

309 Plus Park Blvd.

Nashville, TN 37217

If you have any questions you may contact customer service at:

1-800-4GIBSON (1-800-444-2766)

e-mail: service@gibson.com

FOR MERCHANDISE PURCHASED FROM AN AUTHORIZED GIBSON PRO AUDIO DISTRIBUTOR OUTSIDE OF THE US, PLEASE CONTACT THE DISTRIBUTOR FROM WHOM YOU PURCHASED YOUR MERCHANDISE FOR TO REGISTER YOUR WARRANTY AND FOR HANDLING AND RESOLUTION OF ALL WARRANTY-RELATED ISSUES.

Gibson Pro Audio Warranty

If at any time your Gibson Pro Audio product (which includes Stanton, KRK, or Cerwin Vega! brands) malfunctions as a result of faulty materials or workmanship, Gibson Pro Audio or one of Gibson Pro Audio's Authorized Service Centers in the US will repair the defect(s) or replace the merchandise, as it deems appropriate at its sole discretion.

Warranty Period (from date of Purchase as listed on the Bill of Sale):

Stanton

One (1) year for all Stanton products.

KRK

Three (3) years from all studio monitors.

One (1) year all headphones, computer audio devices, including room correction devices.

Cerwin Vega!

Five (5) years for all passive speaker systems.

Three (3) years for all active speaker systems.

Three (3) years for all mixers.

Gibson will warrant all replacement parts and repairs for ninety (90) days from the date of original shipment.

In the unlikely event that your merchandise is destroyed, lost or damaged beyond repair while in the possession of Gibson or one of Gibson Pro Audio's Authorized Service Centers for repair, Gibson will replace that merchandise with one of the same or most similar style of a value not in excess of the original purchase price of your merchandise. Any insurance covering the merchandise, including but not limited to collector's value insurance, must be carried by owner at owner's expense.

For the fastest and safest merchandise return, please use the original shipping carton and packaging materials. Gibson cannot be responsible for any damages incurred during the shipping process due to poor or inadequate packing.

THIS WARRANTY IS EXTENDED TO THE ORIGINAL RETAIL PURCHASER ONLY AND MAY NOT BE TRANSFERRED OR ASSIGNED TO SUBSEQUENT OWNERS. IN ORDER TO VALIDATE YOUR WARRANTY, AND AS A CONDITION PRECEDENT TO WARRANTY COVERAGE HEREUNDER, YOU MUST REGISTER YOUR WARRANTY WITHIN FIFTEEN (15) DAYS FOLLOWING THE ORIGINAL DATE OF PURCHASE. YOUR PROOF OF PURCHASE OR SALES RECEIPT MUST ACCOMPANY ALL REQUESTS FOR WARRANTY COVERAGE.

This warranty is subject to the following limitations:

THIS WARRANTY DOES NOT COVER

1. Any merchandise that has been altered or modified in any way or upon which the serial number has been tampered with or altered.
2. Any merchandise whose warranty card has been altered or upon which false information has been given.
3. Any merchandise that has been damaged due to misuse, negligence, or improper operation.
4. Any merchandise that has been damaged by accident, flood, fire, lightning, or other acts of God.
5. Shipping damage of any kind.
6. Any merchandise that has been subjected to extremes of humidity or temperature.
7. Any merchandise that has been purchased from an unauthorized dealer, or upon which unauthorized repair or service has been performed.

GIBSON MAKES NO OTHER EXPRESS WARRANTY OF ANY KIND WHATSOEVER. ALL IMPLIED WARRANTIES, INCLUDING WARRANTIES OF MERCHANTABILITY AND FITNESS FOR A PARTICULAR PURPOSE, EXCEEDING THE SPECIFIC PROVISIONS OF THIS WARRANTY ARE HEREBY DISCLAIMED AND EXCLUDED FROM THIS WARRANTY. SOME STATES AND/OR COUNTRIES DO NOT ALLOW THE EXCLUSION OR LIMITATION OF IMPLIED WARRANTIES SO THAT THE ABOVE MAY NOT APPLY TO YOU.

GIBSON SHALL NOT BE LIABLE FOR ANY SPECIAL, INDIRECT CONSEQUENTIAL, INCIDENTAL OR OTHER SIMILAR DAMAGES SUFFERED BY THE PURCHASER OR ANY THIRD PARTY, INCLUDING WITHOUT LIMITATION, DAMAGES FOR LOSS OF PROFITS OR BUSINESS OR DAMAGES RESULTING FROM USE OR PERFORMANCE OF THE MERCHANDISE, WHETHER IN CONTRACT OR IN TORT, EVEN IF GIBSON OR ITS AUTHORIZED REPRESENTATIVE HAS BEEN ADVISED OF THE POSSIBILITY OF SUCH DAMAGES, AND GIBSON SHALL NOT BE LIABLE FOR ANY EXPENSES, CLAIMS, OR SUITS ARISING OUT OF OR RELATING TO ANY OF THE FOREGOING.

FOR MERCHANDISE PURCHASED FROM AN AUTHORIZED GIBSON PRO AUDIO DISTRIBUTOR OUTSIDE OF THE US, PLEASE CONTACT THE DISTRIBUTOR FROM WHOM YOU PURCHASED YOUR MERCHANDISE FOR THE HANDLING AND RESOLUTION OF ALL WARRANTY ISSUES. FOR THESE PURCHASES, THE ABOVE-DESCRIBED WARRANTY IS NOT APPLICABLE.

How to Obtain Warranty Service

Warranty Service outside the United States:

To initiate a warranty repair, please contact the Authorized Gibson Pro Audio distributor from whom you purchased your merchandise, and follow the distributor's return/warranty policy.

Warranty Service for Merchandise Purchased from an Authorized Gibson Pro Audio Dealer in the U.S:

In the event of malfunction of your Gibson Pro Audio merchandise, the Dealer or Owner must call Customer Service @ 1-800-4GIBSON (1-800-444-2766) and obtain a Return Authorization number from the customer service agent. No merchandise may be returned to Gibson without such prior Return Authorization, and the Return Authorization number must be written on the outside of the shipping package. The Customer Service agent will provide the address and additional shipping instructions. Owner must ship the merchandise, freight, and insurance pre-paid to the address provided by the customer service representative. Only Authorized Gibson Pro Audio Service Centers may perform warranty service and any service performed by unauthorized persons will void this warranty. Gibson disclaims liability for defects or damage caused by services performed by unauthorized persons or non-warranty service not performed by Gibson or an Authorized Gibson Pro Audio Service Center.

When contacting Gibson, you must include a complete written description of the malfunction of the merchandise. If non-warranty work is required or recommended, a quotation will be issued and must be approved by you before any non-warranty work is commenced. You should consider quotations obtained for non-warranty work immediately and advise the Authorized Gibson Pro Audio Service Center or Gibson of your wishes. You are not required to purchase non-warranty work in order to obtain service on materials covered by this warranty. Following its inspection of merchandise upon its arrival, Gibson or the Authorized Gibson Pro Audio Service Center will advise you or your dealer of the approximate date of completion. The repaired merchandise or part will be returned to you or your dealer, freight collect insured.

No representative or other person is authorized to assume for Gibson any liability except as stated in this warranty. This warranty gives you specific rights which vary from state to state or from country to country.

For further information, write:

Customer Service Dept.,
Gibson Customer Service
309 Plus Park Blvd.
Nashville, TN 37217

Or call:

1-800-4GIBSON



CERWIN-VEGA![®]

CERWIN-VEGA! IS A REGISTERED TRADEMARK OF CERWIN-VEGA
CERWIN-VEGA! EST UNE MARQUE DÉPOSÉE DE CERWIN-VEGA
CERWIN-VEGA! ES UNA MARCA COMERCIAL REGISTRADA DE CERWIN-VEGA
CERWIN-VEGA! LST EN REGISTRIERTES WARENZEICHEN VON CERWIN-VEGA

P1500X and P1800SX REV C © 2012 CERWIN-VEGA

A member of the Gibson family of brands.

Membre de la famille des marques Gibson.

Miembro de la familia de marcas Gibson.

Ein Mitglied der Gibson-Markenfamilie.

This document is copyright protected. No part of this manual may be copied or reproduced in any form without prior written consent from CERWIN-VEGA. CERWIN-VEGA shall not be liable for operational, technical, or editorial errors/omissions made in this document.

Ce document est protégé par les lois sur les droits d'auteur. Aucune partie de ce manuel ne peut être copiée ou reproduite sous quelque forme que ce soit sans le consentement écrit préalable de CERWIN-VEGA. CERWIN-VEGA ne peut être tenu responsable des erreurs ou omissions opérationnelles, techniques ou éditoriales faites dans ce document.

Este documento está protegido por derechos de autor. Ninguna parte de este manual puede ser copiada ni reproducida en forma alguna sin el consentimiento previo por escrito de CERWIN-VEGA. CERWIN-VEGA no se responsabilizará de los errores/omisiones funcionales, técnicos o editoriales encontrados en este documento.

Dieses Dokument ist urheberrechtlich geschützt. Kein Teil dieses Handbuchs darf kopiert oder vervielfältigt werden in irgendeiner Form ohne die vorherige schriftliche Zustimmung von Cerwin-Vega. Cerwin-Vega übernimmt keine Haftung für die betriebliche, technische oder redaktionelle Fehler / Auslassungen in diesem Dokument gemacht.

Free Manuals Download Website

<http://myh66.com>

<http://usermanuals.us>

<http://www.somanuals.com>

<http://www.4manuals.cc>

<http://www.manual-lib.com>

<http://www.404manual.com>

<http://www.luxmanual.com>

<http://aubethermostatmanual.com>

Golf course search by state

<http://golfingnear.com>

Email search by domain

<http://emailbydomain.com>

Auto manuals search

<http://auto.somanuals.com>

TV manuals search

<http://tv.somanuals.com>