

# DATA PROJECTOR XJ-S30/XJ-S35

## User's Guide

- Be sure to read the precautions in the separate User's Guide (Basic Operation). For details about setting up the projector and lamp replacement, see the User's Guide (Basic Operation).
- Be sure to keep all user documentation handy for future reference.

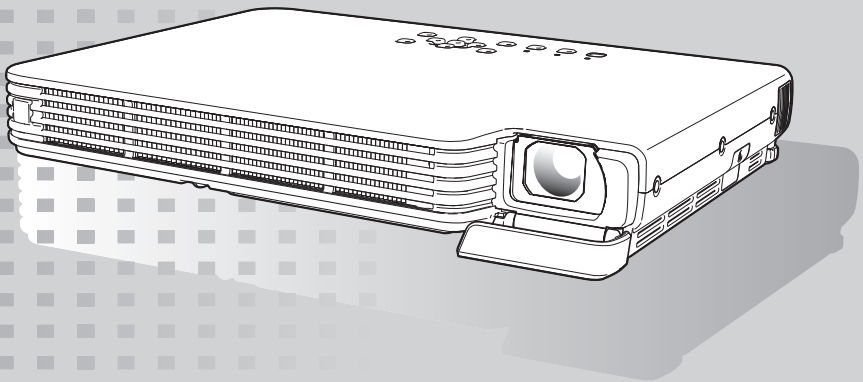

**CASIO**<sup>®</sup>

- DLP is a registered trademark of Texas Instruments of the United States.
- Microsoft, Windows, Windows NT, Windows XP, and the Windows logo are registered trademarks or trademarks of Microsoft Corporation in the United States and other countries.
- Other company and product names may be registered product names or trademarks of their respective owners.

- The contents of this User's Guide are subject to change without notice.
- Copying of this manual, either in part or its entirety is forbidden. You are allowed to use this manual for your own personal use. Any other use is forbidden without the permission of CASIO COMPUTER CO., LTD.
- CASIO COMPUTER CO., LTD. shall not be held liable for any lost profits or claims from third parties arising out of the use of this product or this manual.
- CASIO COMPUTER CO., LTD. shall not be held liable for any loss or lost profits due to loss of data due to malfunction or maintenance of this product, or any other reason.
- The sample screens shown in this manual are for illustrative purposes only, and may not be exactly the same as the screens actually produced by the product.

<b>Contents.....</b>	<b>3</b>
About this manual.....	4
XJ-S35 Users.....	4
<b>Operation During Projection .....</b>	<b>5</b>
Image Operations During Projection .....	5
Adjusting Image Brightness .....	5
Selecting the Color Mode.....	6
Zooming an Image .....	6
Momentarily Cutting Off the Input Source Image .....	7
Freezing an Image .....	7
Displaying a Pointer in the Projected Image .....	8
Changing the aspect ratio of the projected image.....	9
Eco Mode .....	9
Using the [FUNC] Key.....	10
<b>Configuring Advanced Projector Settings.....</b>	<b>11</b>
Basic Setup Menu Operations .....	11
Displaying the Setup Menu .....	11
Configuring Setup Menu Settings .....	11
Basic Setup Menu Example.....	12
Password Protecting the Projector.....	13
Inputting a Password .....	13
Using the Password Feature.....	13
Entering the Password when Turning On the Projector.....	15
Restoring Projector Settings to Their Initial Factory Defaults.....	16
Setup Menu Contents .....	17
Image Adjustment Main Menu .....	18
Screen Settings Main Menu.....	20
Input Settings Main Menu .....	23
Option Settings 1 Main Menu.....	24
Option Settings 2 Main Menu.....	26
USB Settings Main Menu Items (XJ-S35 Only).....	26
Operational Info Main Menu.....	27
Restore All Defaults Main Menu.....	28

# Appendix ..... 29

Remote Controller Signal Range .....	29
Projection Distance and Screen Size .....	30
Connecting to a Component Video Output Device .....	31
Full-screen Display of an RGB Image .....	32
Reattaching the Lens Cover .....	33
Supported Signals .....	34

## About this manual...

- This manual assumes that you are already familiar with the contents of the separate “User’s Guide (Basic Operation)”.
- All of the operations in this manual are explained using the remote controller that comes with the projector. The following key operations can also be performed on the projector instead of the remote controller: [MENU], [▲], [▼], [▶], [◀], [ENTER], [ESC], [⏻], [INPUT], [AUTO], [ZOOM +], [ZOOM -], [FOCUS ▲], [FOCUS ▼].

To perform this remote controller operation:	Use this projector button:
[ENTER]	Button in the center of the cursor keys
[ZOOM +], [ZOOM -]	[ZOOM] button in combination with the [◀] and [▶] buttons
[FOCUS ▲], [FOCUS ▼]	[FOCUS] button in combination with the [▲] and [▼] buttons

## XJ-S35 Users

This manual does not include information about using the XJ-S35 model projector while a USB device is connected to its USB port. For details about connecting USB devices to the XJ-S35 projector and procedures you need to perform to project images from a USB device, see “USB Function Guide” on the bundled CD-ROM.

# Operation During Projection

This section explains the various types of operations you can perform while the projector is projecting an image.

## Image Operations During Projection

You can perform the following operations while projecting an image.

- Image brightness adjustment
- Color mode selection
- Image zooming
- Momentary cut off of the input source image and projection of a black or blue screen, or a logo
- Image freeze
- Pointer display in the projected image
- Aspect ratio switching (between 4:3 and 16:9)

## Adjusting Image Brightness



### Note

(for XJ-S35 model users)

Use the setup menu (page 11) to adjust image brightness when you have an external device connected to the projector's USB port.

### To adjust image brightness

- 1 Press the [BRIGHT] key.**
  - This displays the brightness adjustment window.



- 2 Use the [◀] and [▶] keys to adjust image brightness.**
- 3 To hide the window, press the [ESC] key.**

## Selecting the Color Mode

You can select from among five different color mode settings to optimize the projected image in accordance with image contents and projection conditions.



### Note (for XJ-S35 model users)

Use the setup menu (page 11) to select the color mode when you have an external device connected to the projector's USB port.

### To change the color mode

#### 1 Press the [COLOR MODE] key.

- This displays the color mode selection window. The currently selected color mode is the one whose button is selected (filled in).

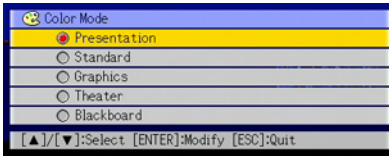

#### 2 Use the [▼] and [▲] keys to move the highlighting to the color mode you want to select, and then press the [ENTER] key.

- This will select the button next to the highlighted color mode name.
- For details on what each color mode does, see “Color Mode” under “Image Adjustment Main Menu” on page 18.

#### 3 To hide the window, press the [ESC] key.

## Zooming an Image

#### 1 Press the [D-ZOOM +] or [D-ZOOM -] key.

- This will cause  to appear in the projected image.

#### 2 Use the cursor keys to move the to the part of the image that you want in the center of the enlarged image.

#### 3 Press (or hold down) the [D-ZOOM +] key.

- Each press of the [D-ZOOM +] key enlarges the image one step. Holding down the [D-ZOOM +] key continually enlarges the image.
- Pressing the [D-ZOOM -] key while an image is enlarged reduces the zooming by one step. Holding down the [D-ZOOM -] key continually reduces the size of the image.
- While an image is zoomed, you can use the cursor keys to scroll the view to other parts of the image.

#### 4 To exit the zoom operation, press the [ESC] key.

## Momentarily Cutting Off the Input Source Image

- 1 Press the [BLANK] key.**
  - This temporarily cuts off the image from the input source and projects a black screen in its place.
- 2 To resume projection of the image from the input source, press the [BLANK] key (or [ESC] key).**



### Note

---

You can specify projection of a black screen or blue screen, or a logo. For details, see “Blank Screen” under “Screen Settings Main Menu” on page 22.

## Freezing an Image

Pressing the [FREEZE] key freezes the projected image.

### To freeze the projected image

- 1 While an image is being projected from an input source, press the [FREEZE] key.**
  - This will capture the image that is on the screen at the moment you press [FREEZE] and stores it in projector memory. That image remains projected on the screen.
- 2 To restore projection of the image from an input source, press the [ESC] key.**

# Displaying a Pointer in the Projected Image

You can select from among eight different pointer styles, including various arrow styles, for display in the projected image. Pointers can be used during a presentation to indicate or highlight a specific part of the image.

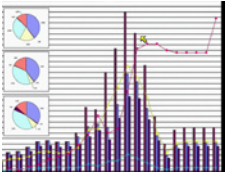

Arrow 1

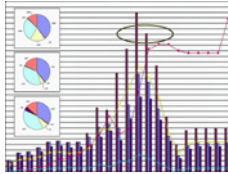

Oval 1

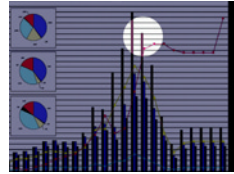

Spot 2



## Note

Depending on the pointer style you are using, the pointer may not display properly when you are using keystone correction. If this happens, use the [KEystone +] and [KEystone -] keys to change the keystone correction value to zero.

## To display a pointer in the image

### 1 Press the [POINTER] key.

- This will cause a pointer to appear in the image.
- You also can use the setup menu to specify the pointer type that appears first when you press the [POINTER] key. For details, see “Pointer” under “Option Settings 2 Main Menu” on page 26.

### 2 Use the cursor keys to move the pointer to the location you want.

- Holding down a cursor key moves the cursor at high speed.

### 3 To modify the pointer as described below, press the [STYLE] key.

For this pointer type:	Pressing [STYLE] will do this:
Arrow 1 / Arrow 2	Rotate the arrow by 90 degrees
Bar 1 / Bar 2	Toggle between flashing and not flashing
Oval 1 / Oval 2	Toggle between flashing and not flashing
Spot 1 / Spot 2	Cycle the darkness (transparency) of the area not covered by the spot among two levels

## To select the pointer type

### 1 Press the [POINTER] key to display the pointer.

### 2 Keep pressing the [POINTER] key until the pointer you want is displayed.

- Each press of the [POINTER] key cycles through the available pointer types.

## To clear the pointer from the image

Press the [ESC] key.



## Changing the aspect ratio of the projected image

Press the [ASPECT] key to toggle the aspect ratio of the displayed image between 4:3 and 16:9.



### Note

---

- The aspect ratio setting affects the projected image only when the input source is VIDEO or component.
- When the input source is a component signal with an aspect ratio of 16:9, the aspect ratio switches automatically to 16:9. When this happens, pressing the [ASPECT] key will not change the aspect ratio.
- You also can change the aspect ratio setting using the setup menu. For details, see “Aspect Ratio” under “Screen Settings Main Menu” on page 20.



### Important!

---

Note that enlarging or reducing the size of an image using the [ASPECT] key for commercial purposes or public presentation may infringe on the legally protected copyright of the copyright holder of the original material.

## Eco Mode

Turning on the Eco Mode reduces lamp brightness to save power. The projector's cooling fan also operates at a slower speed while the Eco Mode is turned on, which results in quieter operation.

Turn on the Eco Mode when your priority is quieter operation. Turn off the Eco Mode when your priority is maximum brightness.

### To turn the Eco Mode on or off

Press [ECO] to toggle the Eco Mode on and off.



### Note

---

#### (for XJ-S35 model users)

Use the setup menu (page 11) to select the lamp mode when you have an external device connected to the projector's USB port.

## Using the [FUNC] Key

Pressing the [FUNC] key displays the menu shown below.

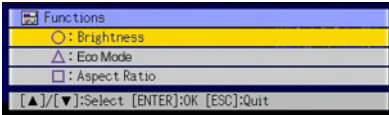

You can use this menu to perform the operations described below.

### ● Adjust image brightness

Highlight “Brightness” and then press the [ENTER] key.

- This performs the same operation as pressing the [BRIGHT] key (○ key) described on page 5.

### ● Turn the Eco Mode on or off

Highlight “Eco Mode” and then press the [ENTER] key.

- This performs the same operation as pressing the [ECO] key (△ key) described on page 9.

### ● Select the aspect ratio of the projected image

Highlight “Aspect Ratio” and then press the [ENTER] key.

- This performs the same operation as pressing the [ASPECT] key (□ key) described on page 9.



### Note

#### (for XJ-S35 model users)

When you have an external device connected to the projector's USB port, use the [FUNC], [○], [△], and [□] keys to control the connected device. For details, see the “USB Function Guide” on the bundled CD-ROM.

# Configuring Advanced Projector Settings

Your projector has a setup menu that you can use to configure advanced settings.

## Basic Setup Menu Operations

### Displaying the Setup Menu

Pressing the [MENU] key displays the menu shown below in the center of the projection screen.

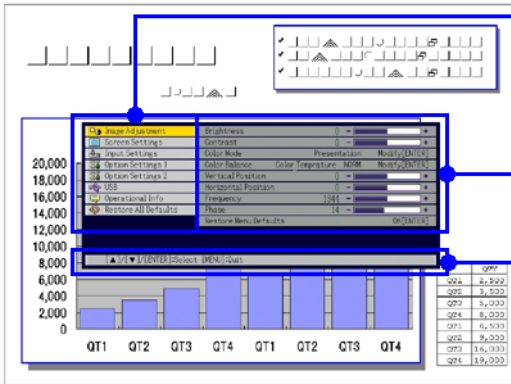

#### Main menu

The main menu includes seven (eight on the XJ-S35) main menu items. The currently selected main menu item is the one that is highlighted.

#### Sub-menu

The sub-menu shows each individual setting under each main menu item, and its current setting.

#### Guidance text

Guidance text provides a brief description of the main key operations available for the operation you are currently performing.



#### Note

You can position the setup menu in the center or on the left edge of the projection screen. For details, see “Menu Position” under “Option Settings 1 Main Menu” on page 24.

### To exit the setup menu

Press the [MENU] key.

## Configuring Setup Menu Settings

- 1 Press the [MENU] key to display the setup menu.
- 2 Use the [▼] and [▲] keys to select the main menu item you want by highlighting it.
- 3 Press the [ENTER] key.
- 4 Use the [▼] and [▲] keys to select the sub-menu item you want by highlighting it.
- 5 Perform the required operation on the selected sub-menu item screen.
  - The guidance text explains the operations you need to perform to configure each setting.
- 6 To return to the main menu from the sub-menu, press the [ESC] key.
- 7 To exit the setup menu, press the [MENU] key.

# Basic Setup Menu Example

The procedure below shows how to configure the following three settings:

- Image Adjustment → Contrast
- Image Adjustment → Color Mode
- Option Settings 1 → Eco Mode



## Note

- Certain settings on the setup menu cannot be changed while there is no input signal to the projector. Because of this, you should configure setup menu settings after selecting an input source and starting projection.
- This example covers basic steps only. For more detailed information, see “Setup Menu Contents” on page 17.

## To configure the “Image Adjustment → Contrast” setting

- 1 Press the [MENU] key to display the setup menu.
- 2 “Image Adjustment” is initially selected on the main menu, so simply press the [ENTER] key.
- 3 Press the [▼] key once to select “Contrast”.

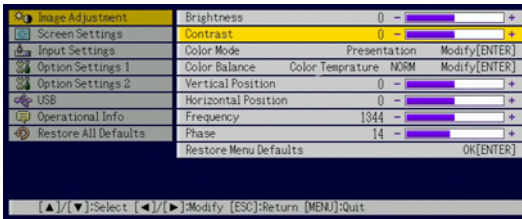

- 4 Use the [◀] (lighter) and [▶] (darker) keys to adjust contrast.

## To configure the “Image Adjustment → Color Mode” setting

- 5 Press the [▼] key once to select “Color Mode”.
- 6 Press the [ENTER] key.

- This displays the color mode menu.

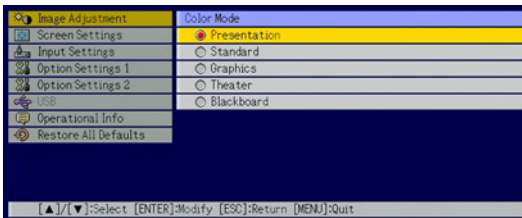

- 7 Use the [▼] and [▲] keys to select the color mode you want.
- 8 After selecting the color mode you want, press the [ESC] key.

## To configure the “Option Settings 1 → Eco Mode” setting

- 9 Press the [ESC] key.
- 10 Press the [▼] key three times to select “Option Settings 1”.
- 11 Press the [ENTER] key.
- 12 Press the [▼] key three times to select “Eco Mode”.



- 13 Use the [◀] and [▶] keys to select “On” or “Off”.
- 14 After you are finished, press the [MENU] key to exit the setup menu.

## Password Protecting the Projector

The password feature lets you keep unauthorized individuals from using the projector. You can specify whether password input is required whenever you turn on the projector, and you can specify and change the password as required. Use the setup menu “Option Settings 1 → Power On Password” setting to configure power on password settings.

### Inputting a Password

The password of your projector is not really a “word” made up of letters, but rather a sequence of remote controller key inputs. The following is the 8-key sequence that represents the initial factory default password.

[INPUT][AUTO][BLANK][FREEZE][▲][▼][◀][▶]

### Using the Password Feature

Note the following precautions whenever you use the password feature.

- The password feature protects against unauthorized use of the projector. Note that it is not an anti-theft measure.
- You will need to enter the initial factory default password the first time you use the projector after turning on the password feature. Change the initial factory default password to a different one of your choice as soon as possible after turning on the password feature.
- Remember that password operations are always performed using the remote controller, so you should take care not to lose or misplace the remote controller.
- Also note that you will not be able to input the password if the remote controller battery is dead. Replace the remote control battery as soon as possible after it starts to go low.

## If you forget your password...

You will not be able to use the projector if you forget the password for some reason. If you forget the password, you will need to bring the following two items to your CASIO distributor to have the password cleared. Note that you will be charged to have the password cleared.

1. Personal identification (original or copy of you driver's license, employee I.D., etc.)
2. Projector unit

Note that your CASIO distributor will not be able to clear the password of your projector unless you bring both of the items listed above.

Also, keep the projector's warranty in a safe place.



### Important!

Having your password cleared using the procedure described above will return all of the settings of your projector, except for the lamp time, to their initial factory defaults.

## Keep a written record of your password!

You will not be able to use the projector if you forget its password. We strongly suggest that you keep a written or other type of record of the password so you can look it up when necessary.

## To change the password

- 1 Press the [MENU] key to display the setup menu.
- 2 Use the [▼] key to select "Option Settings 1", and then press the [ENTER] key.
- 3 Use the [▼] key to select "Power On Password", and then press the [ENTER] key.

- This will display a dialog box prompting you to enter the current password.

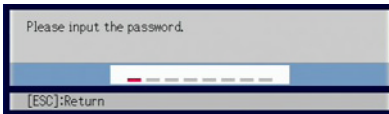

- 4 Enter the current password.

- If the projector is still protected by the factory default password, perform the key operation shown below to enter it.



- 5 After entering the current password, press the [ENTER] key.
  - This displays the Power On Password setting screen.
- 6 Use the [▼] key to select "Change Password", and then press the [ENTER] key.
  - This will display a dialog box prompting you to enter the new password.

## 7 Enter a key sequence up to eight key operations long.

- You can use any of the following keys as part of your password key sequence.  
[INPUT], [AUTO], [BLANK], [FREEZE], [COLOR MODE], [D-ZOOM +], [D-ZOOM -], [KEYSTONE +], [KEYSTONE -], [MENU], [POINTER], [○], [△], [□], [▲], [▼], [◀], [▶], [FUNC]

## 8 After entering the new password, press the [ENTER] key.

- This will display a dialog box prompting you to enter the same password again.

## 9 Re-enter the same password key sequence you entered in step 7 and then press [ENTER].

- The message “Your new password has been registered.” indicates that the password has been changed. Press the [ESC] key.
- If the password you entered in this step is different from the one you entered in step 7, the message “The password you input is wrong.” appears. Press the [ESC] key to return to step 7.

## 10 After you are finished, press the [MENU] key to exit the setup menu.

### To turn password protection on and off

## 1 Display the Power On Password setting screen by performing steps 1 through 5 of the procedure under “To change the password” on page 14.

- At this time, make sure that “Power On Password” is selected on the Power On Password setting screen.

## 2 Use the [◀] and [▶] keys to select “On” or “Off”.

- Changing the power on password setting from “On” to “Off” causes the confirmation dialog box shown below to appear.

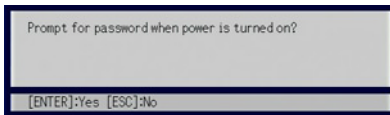

Press the [ENTER] key to confirm that you want to turn on power on password protection, or [ESC] to exit the dialog box without doing anything.

## 3 After you are finished, press the [MENU] key to exit the setup menu.

## Entering the Password when Turning On the Projector

When you turn on the projector while password protection is turned on will cause a password input dialog box to appear on the projection screen. All projector operations will be accessible to you after you input the correct password and press the [ENTER] key.



### Note

You can perform the projection size adjustment operation ([ZOOM +] / [ZOOM -] keys), focus operation ([FOCUS ▲] / [FOCUS ▼] keys), and power off operation ([⏻] key) while the password input dialog box is on the projection screen.

# Restoring Projector Settings to Their Initial Factory Defaults

You can use the procedures in this section to restore all of the settings on a particular main menu or all of the settings on the setup menu to their initial factory defaults.

## To restore all settings on a particular main menu to their initial factory defaults

- 1 Press the [MENU] key to display the setup menu.
- 2 Use the [▼] and [▲] keys to select the main menu whose settings you want to restore to their initial factory defaults.
  - You can select Image Adjustment, Screen Settings, Input Settings, Option Settings 1, or Option Settings 2.
- 3 Press the [ENTER] key.
- 4 Use the [▼] key to select “Restore Menu Defaults”.
- 5 Press the [ENTER] key.
  - This will display a confirmation screen like the screen shown below.

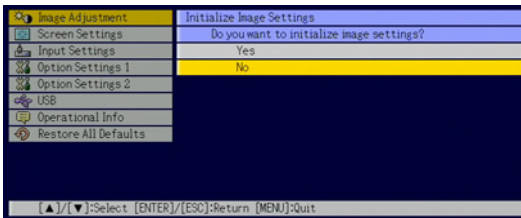

- 6 Use the [▲] key to select “Yes”.
- 7 To restore the settings of the main menu to their initial defaults, press the [ENTER] key.
  - To exit the operation without doing anything, press [ESC] instead of [ENTER].
- 8 After you are finished, press the [MENU] key to exit the setup menu.



### Note

- The language setting and the password are not returned to their initial factory defaults if you select Option Settings 1 in step 3.
- For details about how the above procedure initializes settings, see the explanations of the settings under “Setup Menu Contents” on page 17.



## To restore all settings on the setup menu to their initial factory defaults

- 1 Press the [MENU] key to display the setup menu.
- 2 Use the [▼] key to select “Restore All Defaults”, and then press the [ENTER] key.
  - This displays a confirmation message asking if you want to initialize all settings.
- 3 Use the [▲] key to select “Yes”.
- 4 To restore all settings on the setup menu to their initial defaults, press the [ENTER] key.
  - This will restore all of the settings to their initial factory defaults, except for the Language, Lamp Time, and password settings.
  - To exit the operation without doing anything, press [ESC] instead of [ENTER].
- 5 After you are finished, press the [MENU] key to exit the setup menu.

## Setup Menu Contents

This section contains tables that provide detailed explanations of all of the items included on the setup menu. The following describes the type of information that appears in each of the columns of the tables.

### Setting Name

This column shows the names of the settings as they appear on the sub-menu.

### Input

This column shows the input source for which each setting is supported.

Input source names are abbreviated as R (RGB input), C (component video input), V (video input), and U (USB input, XJ-S35 only). The letter N indicates that the setting can be configured while there is no input signal.

### Setting Unit

The setting unit indicates how a setting is stored.

“Source Specific” in this column indicates that separate settings can be stored for each individual input source. For example, you could store an “Image Adjustment → Brightness” setting of -1 for RGB input and a setting of +1 for VIDEO input.

“Single” in this column indicates that a single setting is stored and applied, regardless of the input source.

### Description

This column provides details about the setting item and how to select it. The initial default setting is indicated by an asterisk (\*).

## Image Adjustment Main Menu



Setting Name	Input	Setting Unit	Description
Brightness	RCVU	Source Specific	Use this sub-menu to adjust the brightness of the projected image. A larger value produces a brighter image.
Contrast	RCVU	Source Specific	Use this sub-menu to adjust the contrast of the projected image. A larger value produces a stronger contrast.
Sharpness	V	Source Specific	Use this sub-menu to adjust the sharpness of the outlines in the projected image. A larger value makes the image sharper, while a smaller value makes it softer.
Saturation	V	Source Specific	Use this sub-menu to adjust the color saturation of the projected image. A larger value increases color saturation.
Tint	V	Source Specific	Use this sub-menu to adjust the tint of the projected image. A larger value makes the overall image more bluish, while a smaller value makes the overall image more reddish. This setting is supported only when the signal is NTSC or NTSC4.43.
Color Mode	RCVU	Source Specific	<p>You can select from among five different color mode settings to optimize the projected image in accordance with image contents and projection conditions.</p> <p><b>Presentation*:</b> Use this setting for standard presentations in a well-lit area. This is the initial default setting when the input source is either RGB or USB.</p> <p><b>Standard:</b> Use this setting when you want to highlight the colors of your presentation.</p> <p><b>Graphics:</b> Use this setting when you want photographs and graphics to appear natural.</p> <p><b>Theater*:</b> Use this setting to bring out the dark portions of your images. This is the initial default setting when the input source is either component video or video.</p> <p><b>Blackboard:</b> Use this setting for easy viewing when projecting onto a blackboard.</p>
Color Balance	RCVU	Source Specific	<p>This sub-menu lets you adjust the color balance of the projected image. Color balance lets you select either "Color Temperature" or "Color" (for individual adjustment of red, green and blue) as the adjustment method.</p> <p><b>Color Temperature:</b> Select this option when you want to adjust the color temperature. Selecting "LO" gives whites a reddish cast, while "HI" gives them a bluish cast. Selecting "NORM*" sets a medium setting between the two colors.</p> <p><b>Color:</b> Select this option when you want to individually adjust the intensity of red, green, and blue. For all of the colors, a larger value makes the color stronger.</p>

Setting Name	Input	Setting Unit	Description
Vertical Position	RCV	Signal Specific	Use this sub-menu to adjust the vertical position of the input source image within the projection area.
Horizontal Position	RCV	Signal Specific	Use this sub-menu to adjust the horizontal position of the input source image within the projection area.
Frequency	R	Signal Specific	<p>When vertical bands appear in the projected image while RGB is selected as the input source, it means that the frequency setting is not correct. When this happens, use this setting to adjust the frequency manually.</p> <p> <b>Important!</b> _____</p> <p>If, for some reason, your manual frequency settings cause the image input from the computer to disappear from the projection, you can press the [AUTO] key to perform an auto adjust operation, which should cause the image to appear.</p>
Phase	R	Signal Specific	When there is flickering in the projected image while RGB is selected as the input source, it means that the phase setting is not correct. When this happens, use this setting to adjust the phase manually.
Video Mode	V	Source Specific	<p>This setting is valid when VIDEO is selected as the input source. Use it to select a mode that is optimized for movies or still images.</p> <p><b>Normal*:</b> Optimized for movies.</p> <p><b>Still Image:</b> Optimized for still images. In particular, this setting should be used when projecting still images from a digital camera connected to the projector's VIDEO terminal.</p>
Restore Menu Defaults	RCVU	Source Specific	<p>Use this sub-menu to return all of the sub-menu items on the Image Adjustment main menu to their initial default settings.</p> <ul style="list-style-type: none"> <li>● Restoring menu defaults when there is no input signal will restore defaults for the currently selected input source.</li> <li>● "Image Adjustment" main menu "Vertical Position", "Horizontal Position", "Frequency", and "Phase" defaults can be restored for the current signal type (XGA/60Hz, SXGA/60Hz,etc.) only.</li> </ul>

## About the “Signal Specific” Setting Unit

For the items that have “Signal Specific” in the “Setting Unit” column of the above table, the setting is saved for the specific type of signal (XGA/60Hz, SXGA/60Hz, etc.) that is being input when the setting is performed, and not for a specific input source.

## Screen Settings Main Menu

Setting Name	Input	Setting Unit	Description
Keystone Correction	RCVUN	Single	Use this sub-menu to correct vertical keystone of the projected image.
Aspect Ratio	CV	Source Specific	<p>Use this sub-menu to select one of the following aspect ratios for the projected image.</p> <p><b>4:3*:</b> This setting specifies a 4:3 aspect ratio, which is the same as a standard television.</p> <p><b>16:9:</b> This setting specifies a 16:9 aspect ratio, which is the same as a movie screen, high-definition TV, etc. Using this setting when the input source image is a 16:9 image that has been squeezed to a 4:3 image causes the image to be projected with its normal 16:9 aspect ratio.</p> <p> <b>Note</b> _____ When the input source is a component signal with an aspect ratio of 16:9, the aspect ratio switches automatically to 16:9. When this happens, the aspect ratio cannot be changed using this setting.</p> <p> <b>Important!</b> _____ Note that enlarging or reducing the size of an image for commercial purposes or public presentation may infringe on the legally protected copyright of the copyright holder of the original material.</p>

Setting Name	Input	Setting Unit	Description
Projection Mode	RCVUN	Single	<p>Use this sub-menu to specify whether projection will be from the front of the screen or the back of the screen.</p> <p><b>AB</b>*: Select this option when projecting from the front of the screen.</p> <p><b>BA</b>: Select this option when projecting from the back of the screen.</p> <p><b>VB</b>: Select this option to flip the back-projected image vertically.</p> <p><b>BV</b>: Select this option to flip the image vertically.</p>
Startup Screen	RCVUN	Single	<p>Use this sub-menu to specify whether or not a startup screen should be projected whenever the projector is turned on.</p> <p><b>Logo</b>: Select this option to project the projector's built-in logo screen at startup.</p> <p><b>None</b>*: Select this option when you do not want to project a startup screen.</p>
No Signal Screen	RCVUN	Single	<p>Use this sub-menu to specify what should be projected when there is no input signal to the projector.</p> <p><b>Blue</b>*: Select this option to project a blue screen.</p> <p><b>Black</b>: Select this option to project a black screen.</p> <p><b>Logo</b>: Select this option to project the projector's built-in logo screen.</p>

Setting Name	Input	Setting Unit	Description
Blank Screen	RCVUN	Single	<p>Use this sub-menu to specify what should be projected after the [BLANK] key is pressed.</p> <p><b>Blue:</b> Select this option to project a blue screen.</p> <p><b>Black*:</b> Select this option to project a black screen.</p> <p><b>Logo:</b> Select this option to project the projector's built-in logo screen.</p>
Restore Menu Defaults	RCVUN	Source Specific	<p>Use this sub-menu to return all of the sub-menu items on the Screen Settings main menu to their initial default settings.</p> <ul style="list-style-type: none"> <li>● Restoring menu defaults when there is no input signal will restore defaults for the currently selected input source.</li> <li>● Note that the "Keystone Correction", "Projection Mode", "Startup Screen", "No Signal Screen", and "Blank Screen" settings are always returned to their initial defaults, regardless of the currently selected input source.</li> </ul>

# Input Settings Main Menu

Setting Name	Input	Setting Unit	Description
RGB Input	RC N	Single	<p>Use this sub-menu to specify manually the type of signal being input from the projector's RGB input terminal.</p> <p><b>Auto*:</b> Automatically detects the signal being input from the RGB input terminal and configures the appropriate input protocol.</p> <p><b>RGB:</b> Select this option when a computer is connected to the RGB input terminal. For details about connecting a computer, see "Connecting a Computer to the Projector" in the "User's Guide (Basic Operation)".</p> <p><b>Component:</b> Select this setting when the projector's RGB input terminal is connected to the component video output terminal of a video device using an optionally available YK-3 component video cable. For information about connection, see "Connecting to a Component Video Output Device" on page 31.</p>
Video Signal	V N	Single	<p>Use this sub-menu to specify manually the type of signal being input from the projector's VIDEO input terminal.</p> <p><b>Auto*:</b> Select this setting to have the projector switch the video signal system automatically in accordance with the input signal from the video device that is connected to the VIDEO input terminal.</p> <p><b>NTSC / NTSC4.43 / PAL / PAL-M / PAL-N / PAL60 / SECAM:</b> Each setting selects the applicable video system. Use these settings when you want to specify only one specific video signal for the VIDEO input terminal.</p>
Signal Name Indicator	RCVUN	Single	<p>Use this sub-menu to specify whether or not the name of the currently selected signal source should be displayed in the projected image.</p> <p><b>On*:</b> Select this option to turn on display of the name of the currently selected signal source in the projected image.</p> <p><b>Off:</b> Select this option to turn off display of the signal source name.</p>
Restore Menu Defaults	RCVUN	Source Specific	<p>Use this sub-menu to return all of the sub-menu items on the Input Settings main menu to their initial default settings.</p> <ul style="list-style-type: none"> <li>● Restoring menu defaults when there is no input signal will restore defaults for the currently selected input source.</li> <li>● Note that the "Signal Name Indicator" setting is always returned to its initial default, regardless of the currently selected input source.</li> </ul>

## Option Settings 1 Main Menu

Setting Name	Input	Setting Unit	Description
Menu Position	RCVUN	Single	Use this sub-menu to specify the display position of the setup menu as either the center or the left side of the screen. <input type="checkbox"/> *: Select this option to display the setup menu in the center of the screen. <input type="checkbox"/> : Select this option to display the setup menu on the upper left corner of the screen.
Auto Keystone Correction	RCVUN	Single	Use this sub-menu to turn auto keystone correction on or off. <b>On</b> *: Select this option to turn on auto keystone correction. <b>Off</b> : Select this option to turn off auto keystone correction.
Auto Adjust	R N	Single	Use this sub-menu to specify whether or not auto adjust should be performed when RGB is selected as the input source. <b>On</b> *: Select this option to turn on auto adjust. <b>Off</b> : Select this option to turn off auto adjust.
Eco Mode	RCVUN	Single	Use this sub-menu to turn the Eco Mode on or off. <b>On</b> : Select this option to reduce lamp brightness and save power. This setting also reduces the speed of the projector's cooling fan, which reduces operation noise. <b>Off</b> : Select this option to project at maximum brightness.
Auto Power Off	RCVUN	Single	Use this sub-menu to turn Auto Power Off on or off. See "Turning Off the Projector" in the "User's Guide (Basic Operation)" for more information. <b>On</b> *: Select this option to turn on Auto Power Off. <b>Off</b> : Select this option to turn off Auto Power Off.
Power On Password	RCVUN	Single	You can configure the projector to require input of a password before operation is enabled. For details, see "Password Protecting the Projector" on page 13.



Setting Name	Input	Setting Unit	Description
Direct Power On	RCVUN	Single	<p>Use this sub-menu to turn Direct Power On on or off. See "Direct Power On" in the "User's Guide (Basic Operation)" for more information.</p> <p><b>On:</b> Select this option to turn on Direct Power On.</p> <p><b>Off*:</b> Select this option to turn off Direct Power On.</p> <p> <b>Important!</b> _____</p> <p>While Direct Power On is enabled, the projector will turn off automatically if no key operation is performed and no signal input is received within about 10 minutes after it is turned on. This is true regardless of the current Auto Power Off setting.</p>
Language	RCVUN	Single	<p>Use this sub-menu to specify the language to use for messages, setup menus, etc.</p> <p>English / French / German / Italian / Spanish / Swedish / Chinese (Simplified) / Chinese (Traditional) / Korean / Japanese</p>
Restore Menu Defaults	RCVUN	Single	<p>This sub-menu returns all of the sub-menu items on the Option Settings 1 main menu to their initial default settings.</p> <ul style="list-style-type: none"> <li>● Restoring menu defaults when there is no input signal will restore defaults for the currently selected input source.</li> <li>● The "Auto Adjust" item is returned to its initial default only when RGB input is selected for the input source. All of the other items are returned to their initial defaults regardless of the currently selected input source.</li> </ul>

## Option Settings 2 Main Menu

Setting Name	Input	Setting Unit	Description
Zoom Memory	RCVUN	Single	Use this sub-menu to turn zoom memory on or off. Zoom memory lets you save the zoom setting when the projector is turned off, so it can be restored automatically the next time the projector is turned on. <b>On*:</b> Select this option when you want to restore the zoom setting that was in effect when the projector was last turned off, whenever it is turned on. <b>Off:</b> Select this option when you want the image to be projected at its maximum size whenever you turn on the projector.
Pointer	RCVUN	Single	Use this sub-menu to specify the type of pointer that appears first when you press the [POINTER] key. <b>Arrow 1* / Arrow 2 / Bar 1 / Bar 2 / Oval 1 / Oval 2 / Spot 1 / Spot 2</b>
Plug and Play (XJ-S35 only)	RCVUN	Single	Use this sub-menu to turn plug-and-play* <sup>1</sup> on or off. <b>On*:</b> Select this option to turn on plug-and-play. This will allow the projector detect when an external USB device is connected and make that device the input source automatically. <b>Off:</b> Select this option to turn off plug-and-play.
Restore Menu Defaults	RCVUN	Single	This sub-menu returns all of the sub-menu items on the Option Settings 2 main menu to their initial default settings.

\*1 When plug-and-play is turned on, the XJ-S35 projector will make that device the input source automatically. For details about plug-and-play, see “USB Function Guide” on the bundled CD-ROM.

## USB Settings Main Menu Items (XJ-S35 Only)

The USB Settings main menu is available only when there is an external device connected to the USB port of the XJ-S35 model projector. For details, see “USB Function Guide” on the bundled CD-ROM.

## Operational Info Main Menu

Setting Name	Input	Setting Unit	Description
Lamp Time	RCVUN	Single	This sub-menu item shows the cumulative number of hours the current lamp has been used to date. Use this value as a reference when deciding whether or not the current lamp needs to be replaced. For details about replacing the lamp, see "Replacing the Lamp" in the "User's Guide (Basic Operation)".
Reset Lamp Time	RCVUN	Single	Use this submenu item to reset the lamp time to 0 hours after replacing the lamp. For details about replacing the lamp and the lamp time reset operation, see "Replacing the Lamp" in the "User's Guide (Basic Operation)".
Input Signal	RCVUN	Source Specific	This sub-menu item shows the currently selected input signal (RGB, Component, or VIDEO). "- - -" is indicated here when there is no input signal.
Signal Name	RCV	Source Specific	This sub-menu item shows the signal name of the signal being input to the projector. For details about signal names, see "Signal Name" under "Supported Signals" on page 34.
Index	RC	Source Specific	This sub-menu item appears only when RGB or component is the input signal. It shows projector internal information.
Resolution	R	Single	This sub-menu item appears only when RGB is the input signal. It shows the number of vertical pixels of resolution of the RGB input signal.
Horizontal Frequency	RCV	Source Specific	This sub-menu item shows the horizontal frequency of the input signal.
Vertical Frequency	RCV	Source Specific	This sub-menu item shows the vertical frequency of the input signal.
Scan System	RC	Source Specific	This sub-menu item appears only when RGB or component is the input signal, and shows the scanning frequency of the input signal. The input signal is interlace or non-interlace for an RGB signal input, and interlace or progressive for a component signal input.

## Restore All Defaults Main Menu

Setting Name	Input	Setting Unit	Description
Restore All Defaults	RCV N	Single	This sub-menu returns all sub-menu items on all main menus to their initial default settings. This operation can be performed regardless of the currently selected input source and regardless of whether or not a signal is currently being input. For details about this procedure, see "To restore all settings on the setup menu to their initial factory defaults" on page 17.
Unit Operating Time	RCVUN	Single	This sub-menu item shows the cumulative operating time of this unit. This time cannot be initialized.

# Appendix

## Remote Controller Signal Range

When performing an operation on the remote controller, point it at the remote control signal receiver on the back or front of the projector. The following illustration shows the range of the remote controller signal.

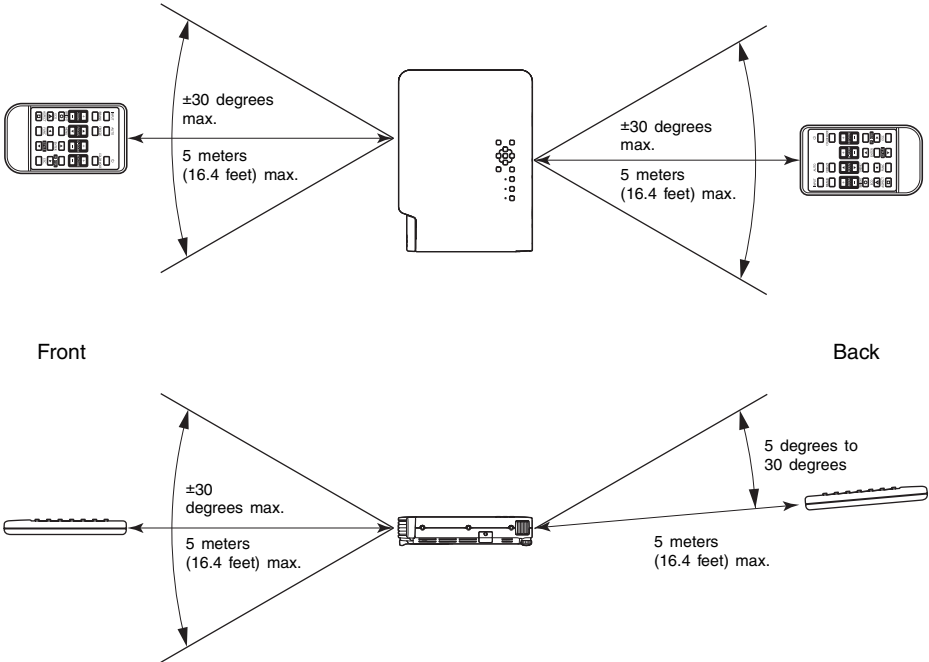

## Remote Controller Range

The allowable distance between the remote controller and the projector is less when there is a sharp angle between the remote controller and the remote control signal receiver.



### Important!

To avoid running down the battery, store the remote control unit so its buttons are not pressed inadvertently.

# Projection Distance and Screen Size

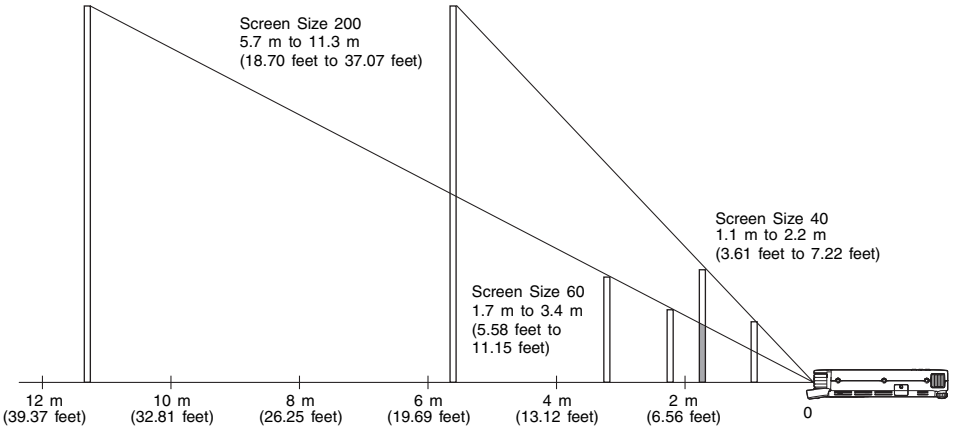

The following table shows the relationship between the distance and projected image size.

Projection Size		Approximate Projection Distance			
Screen Size	Diagonal (cm)	Minimum Distance (m)	Maximum Distance (m)	Minimum Distance (feet)	Maximum Distance (feet)
40	102	1.1	2.2	3.61	7.22
60	152	1.7	3.4	5.58	11.15
80	203	2.3	4.5	7.55	14.76
100	254	2.8	5.6	9.19	18.37
150	381	4.3	8.5	14.11	27.89
200	508	5.7	11.3	18.70	37.07



## Important!

Note that the distances provided above are for reference only.

## Connecting to a Component Video Output Device

Some video devices are equipped with a component video output terminal. You can use an optionally available component video cable (YK-3) to connect the RGB input terminal of the projector to the component video output terminal of a video device.



### Important!

Always turn off the projector and the video device before connecting them.

Projector

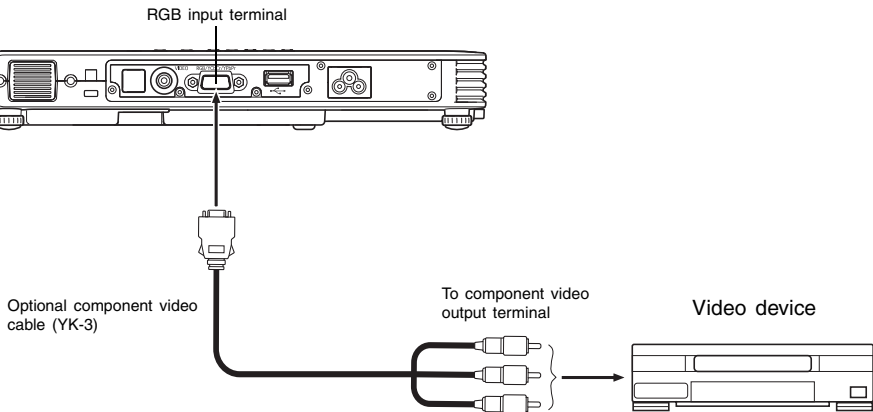

- Component video output terminals come in 3-terminal sets: Y·Cb·Cr or Y·Pb·Pr. Be sure to match the colors of the plugs on the optional YK-3 component video cable with the colors of the terminals (Green: Y; Blue: Cb/Pb; Red: Cr/Pr).
- You can use the optional YK-3 component video cable to connect to pin jack (RCA) type component video output terminals. The projector does not support connection to any other type of terminal.
- Note that connection only to an analog component video output terminal is supported. Connection to a digital output terminal is not supported.

## Full-screen Display of an RGB Image

The projector outputs images using XGA (1024 pixels × 768 pixels) video resolution. When the input signal from the computer connected to the projector is not an XGA signal, “Resize Image To Fit” automatically enlarges or reduces the image so it matches the projector’s video resolution and fills the entire screen. The following shows how different input signals from a computer are adjusted during projection.

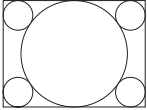
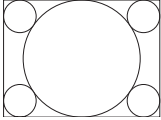
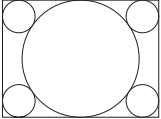
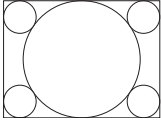
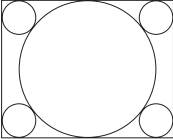
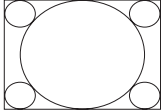
Input Signal Example	Projected Image
<p data-bbox="277 300 400 327">800 × 600</p> 	
<p data-bbox="273 483 407 510">1024 × 768</p> 	
<p data-bbox="266 683 414 710">1280 × 1024</p> 	 <p data-bbox="594 874 1003 1038">When the input signal has a resolution of 1280 × 1024 (aspect ratio: 5:4), the original image is compressed so it conforms to the projection resolution of 1024 × 768 (aspect ratio: 4:3). Because of this, the projected image may appear slightly wider horizontally than the original image.</p>



## Reattaching the Lens Cover

Use the following procedure to replace the lens cover if it should accidentally become detached from the projector.

### 1 Insert the nub (③) of the left tab of the lens cover into the depression (①) of the tab under the lens.

- When performing the above step, make sure that the lens cover is open to 90 degrees in relation to the front of the Data Projector.

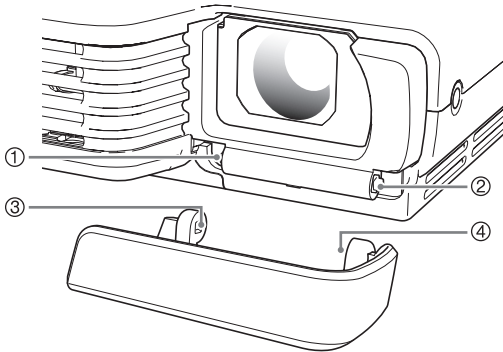

### 2 Keeping the left nub (③) in the left depression (①), gently press the lens cover towards the right as you insert the nub (④) of the right lens cover tab into the depression (②) of the right tab under the lens.

- Do not apply undue force to the lens cover when performing the above step. Pressing too strongly can damage the tabs of the lens cover.

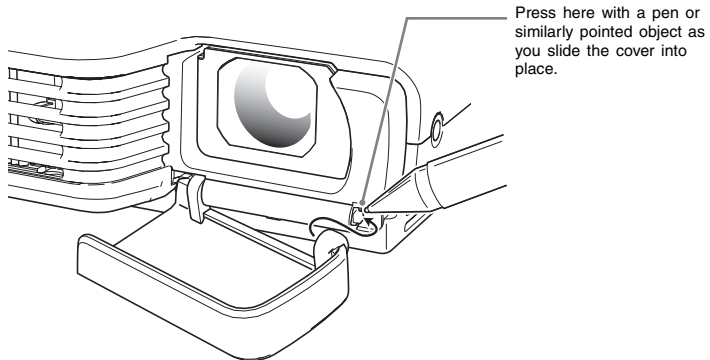

# Supported Signals

## RGB Signal

	Signal Name	Resolution	Horizontal Frequency (kHz)	Vertical Frequency (Hz)
VESA	640 × 480/60	640 × 480	31.5	60
	640 × 480/72	640 × 480	37.9	73
	640 × 480/75	640 × 480	37.5	75
	640 × 480/85	640 × 480	43.3	85
	800 × 600/56	800 × 600	35.2	56
	800 × 600/60	800 × 600	37.9	60
	800 × 600/72	800 × 600	48.1	72
	800 × 600/75	800 × 600	46.9	75
	800 × 600/85	800 × 600	53.7	85
	1024 × 768/60	1024 × 768	48.4	60
	1024 × 768/70	1024 × 768	56.5	70
	1024 × 768/75	1024 × 768	60.0	75
	1024 × 768/85	1024 × 768	68.7	85
	1152 × 864/75	1152 × 864	67.5	75
	1280 × 960/60	1280 × 960	60.0	60
	1280 × 1024/60	1280 × 1024	64.0	60
Other	1152 × 864/70	1152 × 864	64.0	70

## Component Signal

	Signal Name	Horizontal Frequency (kHz)	Vertical Frequency (Hz)
HDTV	1080i60	33.7	60
	720p60	45.0	60
SDTV	576p50	31.3	50
	576i50	16.6	50
	480p60	31.5	60
	480i60	15.7	60

## Video Signal

Signal Name	Horizontal Frequency (kHz)	Vertical Frequency (Hz)
NTSC	15.7	60
NTSC4.43	15.7	60
PAL	15.6	50
PAL-M	15.7	60
PAL-N	15.6	50
PAL60	15.7	60
SECAM	15.6	50

\* Listing of a device in the above table does not guarantee that you will be able to display its images correctly.

**CASIO®**

**CASIO COMPUTER CO.,LTD.**  
6-2, Hon-machi 1-chome  
Shibuya-ku, Tokyo 151-8543, Japan

MA0608-A

## Free Manuals Download Website

<http://myh66.com>

<http://usermanuals.us>

<http://www.somanuals.com>

<http://www.4manuals.cc>

<http://www.manual-lib.com>

<http://www.404manual.com>

<http://www.luxmanual.com>

<http://aubethermostatmanual.com>

Golf course search by state

<http://golfingnear.com>

Email search by domain

<http://emailbydomain.com>

Auto manuals search

<http://auto.somanuals.com>

TV manuals search

<http://tv.somanuals.com>