



LPCW-50

CD/DVD label printer
application version 1.0

For Windows®

User's Guide

- We recommend that you use this product for printing on blank, unrecorded CD-R discs and other media.
- Printing on CD-R discs and other media that already has data recorded on it may cause the data to become corrupted.
- Note that TDK Recording Media Europe S.A. shall not be held liable for any loss or corruption of data recorded on CD-R discs and other media arising through the use of this product.

Be sure to read the Safety Precautions contained in this manual before trying to use for the first time, and always keep this manual on hand for future reference.

Important!

The copyright of this User's Guide and all rights related to the software shall revert to CASIO COMPUTER CO., LTD.

- Microsoft, Windows, Windows Media and Windows NT are registered trademarks or trademarks of Microsoft Corporation in the United States and other countries.
- Pentium is a registered trademark of Intel Corporation in the United States.
- Macintosh, Mac OS and TrueType are registered trademarks of Apple Computer, Inc. in the United States and other countries.
- Easy CD Creator is a trademark of Roxio, Inc. in the United States.
- Other company and product names used herein may also be company and product names of others.

© Copyright 2002 CASIO COMPUTER CO., LTD. All rights reserved

- Be sure to read this manual carefully before attempting to use the product for the first time.

Read This First!

- TDK Recording Media Europe S.A. shall not be held liable for any loss or claims by you or any other person or entity that may arise through the use of this product.
- Reproduction of this manual in any form, either in part or its entirety, is forbidden without the express permission of CASIO COMPUTER CO., LTD. You are granted permission to use this software for your own personal use. Any and all other use of this software without the express permission of CASIO COMPUTER CO., LTD. is forbidden under international copyright laws.
- The contents of the manual are subject to change without notice.
- Due to the time required for printing on paper, contents of the manual may be outdated by the version of software supplied to you. Because of this, the software and the contents of the displays it produces may be different from those described in this manual, or some items described in this manual may no longer be available.

- The CD/DVD LABEL PRINTER application is an application designed to run under Windows 98, 98SE, Me, 2000 Professional, or XP.
- The application may not be able to run correctly on certain system hardware and software configurations.
- See page 17 for information about minimum computer system requirements.

Safety Precautions

Thank you for purchasing this quality TDK product. Before using it, be sure to read the following Safety Precautions. Keep the manual in a convenient location for future reference when necessary.

Warning



This symbol indicates information that, if ignored or applied incorrectly, creates the possibility of death or serious personal injury.

Caution



This symbol indicates information that, if ignored or applied incorrectly, creates the possibility of personal injury or material damage.

Examples of graphic markings



 indicates something you should not do. The symbol shown here indicates you should not try to take the unit apart.



 indicates something you should do. The symbol shown here indicates you should unplug the unit from the wall outlet.

Warning

Smoke, abnormal odor, overheating, and other abnormalities



Continued use of the product while it is emitting smoke or strange odor, or overheating creates the risk of fire and electric shock. Immediately perform the following steps whenever any of the above symptoms are present.

1. Disconnect the USB cable.
2. Unplug the power cord from the wall outlet.
3. Contact your original retailer.

Power cord, AC adaptor, USB cable



Misuse of the power cord, AC adaptor, or USB cable creates the risk of fire and electric shock.

Make sure you follow the precautions listed below.

- Use only items that come bundled with the product.
- Use only a power source whose output matches the rating marked on the plate on the back of the product.
- Never plug the power cord into a wall outlet that is shared by other devices, or into a shared extension cord.

Warning

Power cord, AC adaptor, USB cable



Misuse of the power cord, AC adaptor, or USB cable can damage it and create the risk of fire and electric shock. Make sure you follow the precautions listed below.

- Never place heavy objects on these items or subject them to direct heat.
- Never modify these items or subject them to bending.
- Do not subject these items to twisting or pulling.
- Should the power cord, AC adaptor, or USB cable or its plug ever become damaged, contact your original retailer.



Power cord, AC adaptor, USB cable



Never touch the power cord, AC adaptor, or USB cable or its plugs while your hands are wet. Doing so creates the risk of electric shock.

Dropping and rough treatment



Continued use of the product after it has been damaged due to dropping or other rough treatment creates the risk of fire and electric shock. Immediately perform the following steps if the product should ever become damaged.

1. Disconnect the USB cable.
2. Unplug the power cord from the wall outlet.
3. Contact your original retailer.

Warning

Do not disassemble or modify the product.



Never try to take the product apart or modify it in any way. Doing so creates the risk of electric shock, burn injury, or other personal injury. Leave all internal inspection, maintenance, and repair up to your original retailer.

Water and foreign objects



Water, liquids, or foreign objects (especially metal) getting inside the product creates the risk of fire and electric shock. Immediately perform the following steps if liquid or a foreign object should ever get inside the product.

1. Disconnect the USB cable.
2. Unplug the power cord from the wall outlet.
3. Contact your original retailer.

Do not incinerate.



Never dispose of the product by incineration. Doing so creates the risk of fire and personal injury due to explosion.

Plastic bag precaution



Never place the plastic bags in which the product comes packed over your head. Doing so creates the risk of suffocation. Particular care is required in households where young children are present.

 **Caution**

Power cord, AC adaptor, USB cable



Misuse of the power cord, AC adaptor, or USB cable can damage it and create the risk of fire and electric shock. Make sure you follow the precautions listed below.

- Never locate these items near a stove or other source of intense heat.
- When unplugging the power cord and USB cable, be sure to grasp the plug. Never pull on the cord or cable.
- Plug in the power cord into the wall outlet as far as it will go.
- Plug in the USB cable into the computer and the printer as far as it will go.
- Before leaving the product unattended for long periods (such as when you go on a trip), unplug the power cord and USB cable.
- At least once a year, clean away any dust built up in the area around the prongs of the power cord's plug.



Keep heavy objects off.



Never place a heavy object on top of the product. Doing so can cause the object to lose balance and fall, creating the risk of personal injury.

 **Caution**

Location



Avoid the locations listed below for the product. Such locations create the risk of fire and electric shock.

- Areas subject to high humidity and large amounts of dust
- Food preparation areas or other location subjected to oil steam
- Near heaters, on a heated carpet, in direct sunlight, in a closed vehicle parked in the sun, and other areas subjected to high heat.

Avoid unstable surfaces.



Never place the product on an unstable table, desk, etc. Doing so can cause the product to fall, creating the risk of personal injury.

Connection precaution



Connect only items that come bundled with the product to its connectors. Connecting a non-bundled item creates the risk of fire and electric shock.

High temperature precaution



Never touch the print head or other metal objects near the head. These items become very hot, and touching them creates the risk of burn injury.

Operating Precautions

Observe the following precautions to ensure that the printer provides you with the years of trouble-free operation for which it is designed.

- Avoid use in areas subjected to direct sunlight, high humidity, and temperature extremes.

Operating Temperature Range: 10°C to 35°C (50°F to 95°F)

- Never allow paper clips, pins, or other similar objects to get inside the printer mechanism.
- Never place objects on top of the printer.
- Never try to take the printer apart. Doing so can lead to malfunction.
- Never drop the product, tip it over, or subject it to strong impact.
- Never touch the print head.
- Never use excessive force when pulling the disc tray. The disc tray will not open unless the power cord, AC adaptor, and USB cable are connected to the printer.

Contents

Safety Precautions	2
Operating Precautions	5
Unpacking the Printer	8
About the Bundled CD-ROM and CD-R	8
Using this Manual	9
Button Operations	9
How to use this Manual	11
LPCW-50 Printer Features	12
General Guide	16
Using the CD/DVD LABEL PRINTER Application	17
Your Computer and Minimum System Requirements	17
Installing the CD/DVD LABEL PRINTER Application	18
To install the application	18
To uninstall the application	20
Connecting to a Power Source and a PC	21
To connect to a power source and a PC	21
To disconnect from a power source and a PC	22
Loading and Removing the Ink Ribbon Cassette	23
To load the Ink ribbon cassette into the printer	23
To replace the ink ribbon cassette	26

Label Making Overview

Label Creation Basics	27
To create a label	27
To print a label	31
To save label data	32
To quit the CD/DVD LABEL PRINTER application	32

Label Making with Preset Templates

Automated Label Layout	33
Using the Assistant Feature	35
Using the Assistant screen	35
Using the Main Window	36
Importing Text Data	38
Importing CD-Text Data for a Music Label	38
Importing Media Player Data for a Music Label	39
Importing Easy CD Creator Data for a Music Label	41
Importing File and Folder Name for a Data Label or Digital Image Label	42
Useful Text Input Functions	43
Saving Label Data	44
Opening a Label Data File	45
Creating a Data Index File	46
Configuring Layout Settings	47
To configure layout settings	47
Configuring Text Layout Settings	48

Configuring Font Settings	50
Inserting an Image into a Label	52
To input an image from a file	52
Capturing a PC Screen Image	52
Controlling the Aspect Ratio of an Image	54
About color images...	55

Original Label Making

Creating an Original Label Layout	57
Free Text Label Template Main Window	58
Free Design Label Template Main Window	58
Free Design and Free Text Template Main Windows	59
Toolbars	59
Configuring Font Settings (Free Text Template, Free Design Template)	61
Inserting a Label Background Image (Free Text Layout)	62
Fields (Free Design Template)	63
Field Types	63
Common Text Field and Image Field Operations	63
Inputting Text into a Text Field (Free Design Template) ...	64
To input text manually	64
To input text imported from a file	64
To configure font settings for the text in a field	65
To delete a text field	65

Inserting an Image into a Label (Free Design Template).....	65
To insert an image into a label	65
To delete an image field	65
Resizing a Field (Free Design Template)	66
Aligning and Resizing Fields (Free Design Template)	67
To align fields	68
Configuring Field Properties (Free Design Template).....	69
To reposition and resize a field	69
Useful Text Input Functions (Free Text Template, Free Design Template).....	70

Printing and Other Operations

Printing a Label	72
To print a label	72
Configuring Advanced Settings	76
To configure advanced print settings	76
Registering and Deleting a Phrase Memory Entry	76
To configure advanced layout settings	77
Using Help	78
To use Help	78
Caring for the Printer	79
Phrase Library List	80
Troubleshooting	80
Error Messages	82
Specifications	83

Unpacking the Printer

Make sure that all of the items shown below are present as you unpack the printer. If anything is missing, contact your original retailer.

**TDK LPCW-50
CD/DVD LABEL
PRINTER**

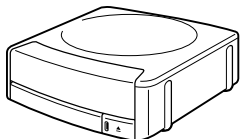

**CD/DVD LABEL PRINTER
Application
CD-ROM**



Power cord *



**AC adaptor
AD-2105S**

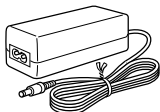

**USB cable
(1.8 meters)
(5.9 feet)**



**TDK ink ribbon
cassette (black)
TR-18BK-T**

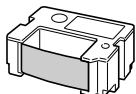

Positioning guide

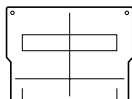

**TDK CD-R 80
*Speed-X***



* The shape of the power cord that comes with the LPCW-50 printer depends on the geographic area where you purchase it.

About the Bundled CD-ROM and CD-R

Handling Precautions

- Handle the disc to avoid finger smudges, dirt, scratches, etc. on either of its surfaces.
- Should the disc become dirty, use an eyeglass cleaning cloth or some other soft dry cloth to wipe it lightly from the center of the disc outwards towards its edge. Never use phonograph record cleaner or any other cleaning agent.
- Never write on either of the disc's surfaces with a pen or pencil or other sharp writing utensils, or affix a sticker to the disc surfaces.
- Use of a disc that is cracked or deformed, or a disc that has adhesive on it is dangerous. Never use such a disc.

Storage Precautions

- Avoid storing discs in areas subjected to high temperature, high humidity, or direct sunlight.
- When you are not using a disc, store it in its original case.
- Avoid storing a disc so its label comes in direct contact with the surface of a vinyl case, bag, etc.

Warning!

Never play a CD-ROM disc on any device that is not specifically designed to play back CD-ROM discs. Audio output at a high volume setting creates the risk of damaged hearing and damage to audio speakers.

Using this Manual

This User's Guide explains operation of the LPCW-50 printer and the CD/DVD LABEL PRINTER application, which is designed to run under Windows® 98, 98SE, Me, 2000 Professional, or XP (referred to in this manual collectively as "Windows").

Note that this User's Guide does not contain information about using Windows, and assumes that you are already familiar with the following standard Windows operations.

- Mouse operations such as click, double-click, right-click, drag, drag and drop, etc.
- Menu operations using the mouse
- Text input using the keyboard
- Standard Windows window operations

If you are not already familiar with these and other basic Windows operations, see the user documentation that came with your PC or Windows package.

Using the Assistant Feature

The CD/DVD LABEL PRINTER application has an Assistant feature that guides you step-by-step through certain operations. (See page 35.)

Help

You can access information about procedures and precautions using the CD/DVD LABEL PRINTER application's Help feature. (See page 78.)

Button Operations

All operations in this manual are performed using the mouse.

- Command operations are indicated as shown below.

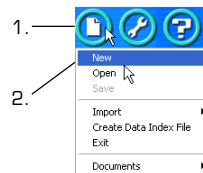

1. Click the  button.

2. On the menu that appears, click **New**.

- Dialog box button operations are indicated as shown below.

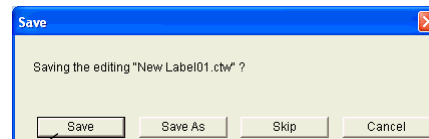

3.

3. Click **Save**.

- All of the sample screens in this manual show operation under the English version of Windows XP. Screens appear differently when running the application under another operating system.
- Note that the screen images shown in this manual may differ somewhat from those that actually appear on your computer screen.

How to use this Manual

The sections of this manual are arranged as shown below. Refer to the indicated pages for details.

Getting Ready

- Unpacking (page 8)
- Installing the Software (page 18)



- Connecting to Your PC (page 21)
- Removing the Packing Materials/Loading the Ink Ribbon Cassette (page 23)

Label Making Overview (page 27)

- This section takes you through the basic label creation and printing process, using a music CD label as an example.

Label Making with Preset Templates

Automated Label Layout (page 33)

- This section describes how to create labels quickly and easily using preset templates.
- You can select a music label, data label, or digital image label template.

Original Label Making

Creating an Original Label Layout (page 57)

- This section describes how to layout text and images to create exactly the type of look you want.
- A Free Text label template gives you wide ranging control over text you input into a label.
- A Free Design label template provides you with maximum freedom when creating your label design.

Troubleshooting Guide (page 80)

- Check this section whenever you run into problems.
- Here you will find details about online help and error messages.

Printing and Other Operations (page 72)

This section explains how to print a completed label.

- Simply place the CD-R onto the tray as instructed by the message that appears on the screen.
- This section also provides details about other settings.

LPCW-50 Printer Features

Your LPCW-50 Printer lets you quickly and easily print labels on a CD-R, CD-RW, and other types of discs.

• Music Discs

Labels can include artist names and track titles (page 33).

You can also import track names from Windows Media™ Player, or Easy CD Creator, or you can import CD-Text from a CD (page 38).

- Screen shots shown in this manual are based on Media Player for Windows XP.

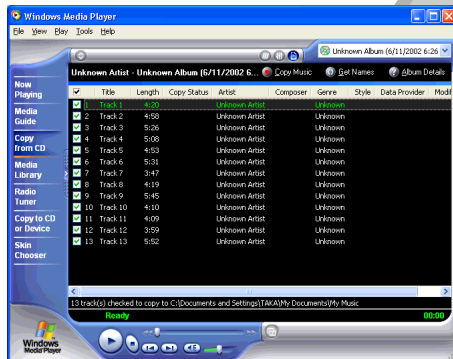

Important! This printer and its software do not include functions for recording to a CD-R, CD-RW or other types of discs.

• Data Discs

You can import the names of folders and files you plan to store on a disc and print them on its label. You can also type in information manually (pages 33 and 42).

Profile data

Domestic business situation Operation flow

Organization chart Business report
New employees research data New order
Operation list (Answer : Admin) Business trip report
Turnover improvement Holiday work
Weekly meeting summary Counter error data

Profile data

©2002 Hitachi Ltd. Operation flow

Organization chart Business report
New employees research data New order
Operation list (Answer : Admin) Business trip report
Turnover improvement Holiday work
Weekly meeting summary Counter error data

• Digital Image Discs

You can import recording dates and image descriptions from your PC and print them on the label. You can also type in information manually (pages 33 and 42).

Bobby's Childhood

7/25/2002 - 7/25/2002 Welcome home
9/30/2002 - 9/30/2002 At the park
12/31/2002 - 12/31/2002 Daddy and Bobby

7/25/2002 - 7/31/2002 Mommy and Bobby
8/16/2002 - 8/16/2002 In the Water
8/30/2002 - 8/30/2002 At camp
9/15/2002 - 9/15/2002 The moonlight night and Bobby

Bobby's Childhood

©2002 Hitachi Ltd. Bobby's Childhood

7/25/2002 - 7/31/2002 Mommy and Bobby
8/16/2002 - 8/16/2002 In the Water
8/30/2002 - 8/30/2002 At camp
9/15/2002 - 9/15/2002 The moonlight night and Bobby

LPCW-50 Printer Features

- Print with TrueType® fonts installed on your PC (page 50).
- Support for both text and images (page 52). Note that images are printed in monochrome.

SIMPLY THE BEST
2001 to 2002



SIMPLY THE BEST
2001 to 2002



- A collection of preset templates lets you produce great looking labels with minimum effort.

rainbow
toi et moi

1. over the ocean
2. blue earth
3. 'cause you're here
4. shining dream
5. a glorious day

BEST ALBUM

JEMMY BROWN

Holy Night



- A Free Text Template allows more control over the appearance and layout of text (Free Text → page 57).

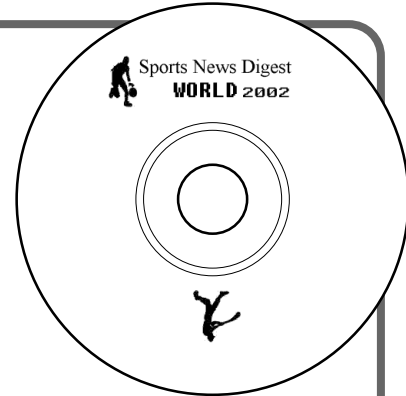

- A Free Design template gives you almost total freedom for laying out text and images to create exactly the look you want (Free Design → page 57).



General Guide

Front

Front cover

Open this cover to load or remove the ink ribbon cassette.

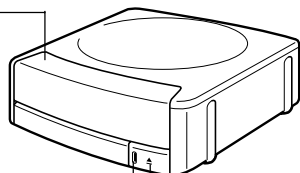

Indicator lamp

- Lights when the printer is connected correctly to a PC.
- Flashes when printing is in progress.

Eject button

Press to open the disc tray.

Carriage

Print head

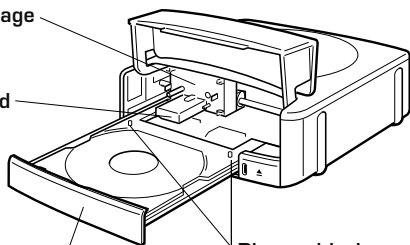

Disc tray

Disc positioning guides

These guides help to position the disc correctly when you place it onto the tray.

Back

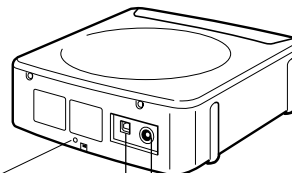

If the disc tray will not open due to printer malfunction, you can open it manually by inserting a thin, pointed object (at least 20 mm long, and less than 1.5 mm thick) into this hole.

Use this hole to manually open the disc tray only when absolutely necessary. Do not use it normally to open the tray.

* Do not use an object with an easily breakable tip. Doing so creates the risk of malfunction.

AC adaptor terminal

Connect the bundled AC adaptor here.

USB port

Connect the bundled USB cable here when connecting to your PC.

Do this first!

The front parts of the printer are secured with tape to protect them during shipment. Make sure you remove the tape before using the printer for the first time.

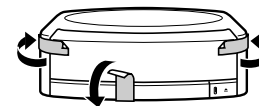

Using the CD/DVD LABEL PRINTER Application

This section describes the computer system required to run the CD/DVD LABEL PRINTER application.

Your Computer and Minimum System Requirements

PC

The following shows an example of a computer that meets the minimum requirements to run the application. Check to make sure that your computer has a similar configuration.

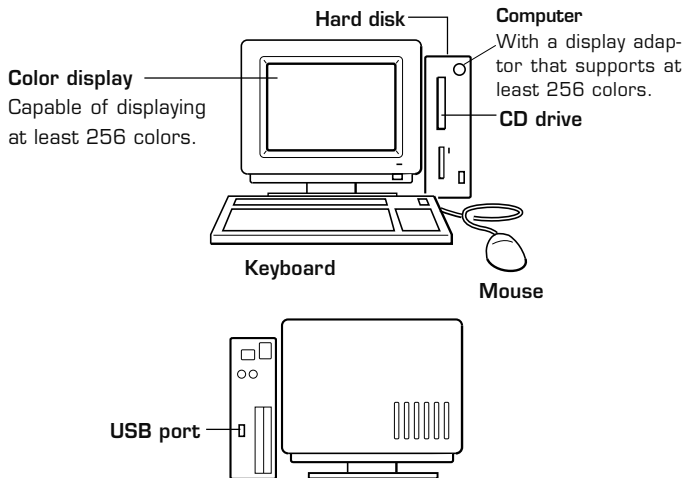

The locations of the various ports may be different on your computer.

Minimum System Requirements

OS: Microsoft® Windows® 98, 98SE, Me, 2000 Professional, or XP

PC: IBM PC/AT or compatible with the following specifications.

- Windows 98, 98SE, Me, 2000 Professional, or XP pre-installed
- Pentium®II 266MHz or higher CPU or CPU recommended for running the OS you are using.
- USB port

Memory: 64MB minimum (128MB minimum recommended)

Hard disk: At least 40MB available for installation of this application, at least 60MB available for running the application.

Display: Color display (256 colors minimum, High-Color recommended), compatible with Windows 98, 98SE, Me, 2000 Professional, or XP, and capable of being connected to your computer.
Resolution: 800 × 600 or higher

Pointing device: Mouse or other equivalent device compatible with Windows 98, 98SE, Me, 2000 Professional, or XP

Keyboard

CD drive

- The application may not run correctly on certain system hardware and software configurations.
- Operation under Windows 3.1, 95, and NT®, on a Macintosh®, and under Mac® OS is not supported.
- Operation of this application is not guaranteed on a computer upgraded to Windows 98, 98SE, Me, 2000 Professional, or XP from another OS.

Installing the CD/DVD LABEL PRINTER Application

This section describes the steps you need to perform to install the CD/DVD LABEL PRINTER application.

Important!

- Be sure to install the CD/DVD LABEL PRINTER application before you connect the printer to your PC. (See page 21.) Connecting before you install the application can result in improper operation.
- Make sure you quit all other applications running on your PC before starting installation. Installing while other applications are running can result in incorrect installation.
- The examples in this manual show installation from a CD drive named drive E:.

To install the application

1. Start up Windows, and place the **CD/DVD LABEL PRINTER Application CD-ROM** into your computer's CD drive.
 - The installer should start up automatically, and display the screen shown below.



Note

Depending on how your PC is configured, the above screen may not appear automatically. If this screen does not appear on your computer, click the Windows **Start** button and then select **Run**. On the dialog box that appears, type in **E:\Setup\Setup.exe** and then click **OK**.

2. Select the language of the version you want to install, and then click **OK**.

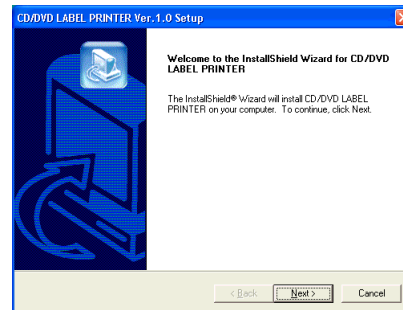

3. Click **Next**.

This causes the **Preceding License Agreement** to appear.

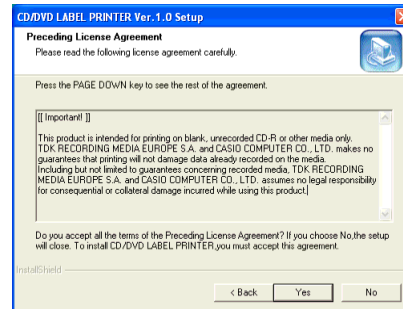

Important!

Be sure to read all of the terms and conditions of the Preceding License Agreement.

4. If you agree to be bound by the agreement, click **Yes**.

This causes the **Software End User License Agreement** to appear.

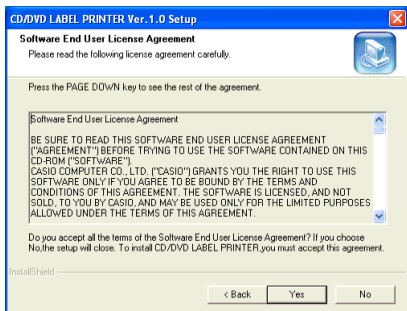

Important!

Be sure to read all of the terms and conditions of the Software End User License agreement.

5. If you agree to be bound by the agreement, click **Yes**.

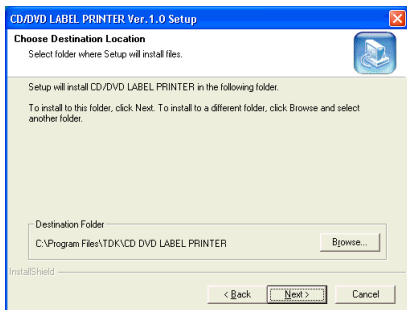

6. Check the installation location, and then click **Next**.

- This starts installation.
- A screen appears to let you know when the installation is complete.

Note

The **InstallShield Wizard Complete** screen may not appear in some cases. If you can see the CD DVD LABEL PRINTER icon on your computer's desktop, it means that the application is installed properly. If you want to change the installation location, click **Browse**.

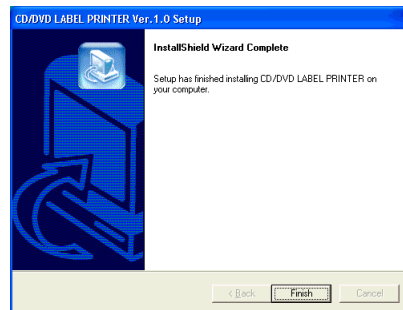

7. Click **Finish**.

A **CD DVD LABEL PRINTER** shortcut icon should be on your Windows desktop.



To uninstall the application

1. Click the Windows **Start** button, and then click **Control Panel**.
2. Click the **Add or Remove Programs** icon.
This causes the **Add or Remove Programs** dialog box to appear.
3. In the list of installed software, click **CD/DVD LABEL PRINTER** to select it.

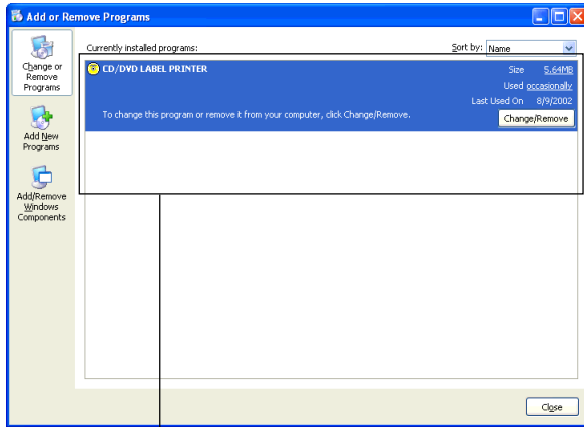

List of installed software

4. Click the **Change/Remove** button.

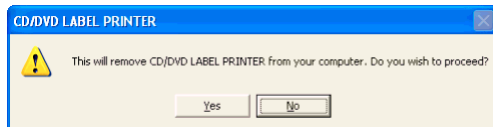

5. Click **Yes**.

This deletes the CD/DVD LABEL PRINTER application.

Note

Some files may cause a separate confirmation dialog box to appear before they can be deleted. If you are unsure about where you should keep a file, select **No**.

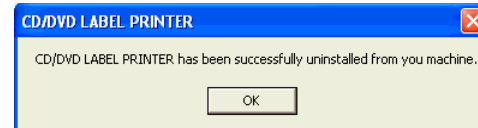

Connecting to a Power Source and a PC

Use the power cord and AC adaptor that come bundled with the printer to connect to a power source. Use the bundled USB cable to connect to a PC.

Important!

Perform the following procedures only after you have installed the CD/DVD LABEL PRINTER application on your computer (See page 18) .

To connect to a power source and a PC

1. Connect the power cord to the AC adaptor.

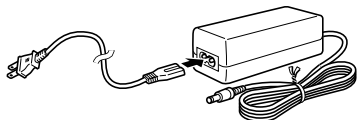

2. Connect the USB cable to the USB port of the PC.

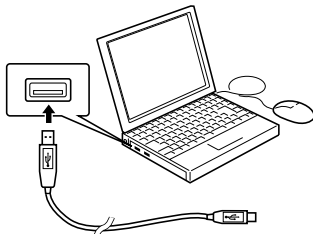

Important!

Be sure you connect directly to the USB port of the PC. Connecting through a hub or chaining through another USB device may cause misoperation.

3. Connect the AC adaptor to the printer's AC adaptor terminal ①, and then plug the power cord into a household power outlet ②.

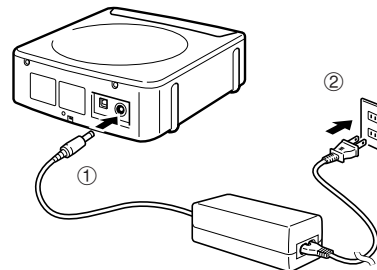

Important!

- Make sure you use a standard household power outlet rated for the voltage specified on the rating plate on the back of the printer.
- Use only the power cord and AC adaptor that come with the printer.

4. Connect the USB cable to the USB port of the printer.

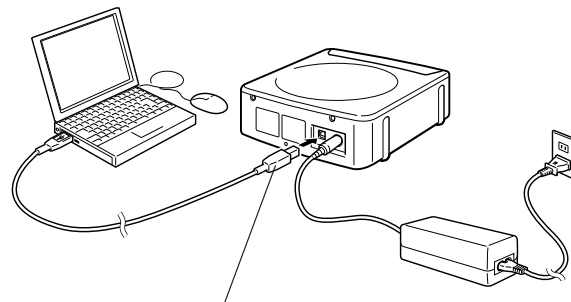

The side with the arrow should be pointing down.

- The first time you connect the USB cable, you have to remove the tape covering the printer's USB port.

Important!

- Do not operate the printer while it is standing up on its side. Also, you should not store the printer standing on its side when you are not using it.
- Note that you cannot load or remove a disc unless both the AC adaptor and USB cable are connected to the printer.

Connecting for the First Time

- A USB driver installation Wizard starts up automatically the first time you connect the printer to your computer after installing the CD/DVD LABEL PRINTER application. Follow the instructions that appear on the display to install the USB driver.
- If you are running Windows XP, the message shown below will appear during USB driver installation. When it does, click **Continue Anyway** to proceed with the installation.



- If you are running Windows 2000, the warning message "Digital Signature Not Found" may appear during USB driver installation. When it does, click **Yes** to proceed with the installation.
- The above messages do not appear on a system running Windows 98, 98SE, or ME.

To disconnect from a power source and a PC

1. Unplug the USB cable from the PC and printer.
2. Unplug the power cord from the wall outlet, and then unplug the AC adaptor from the printer.

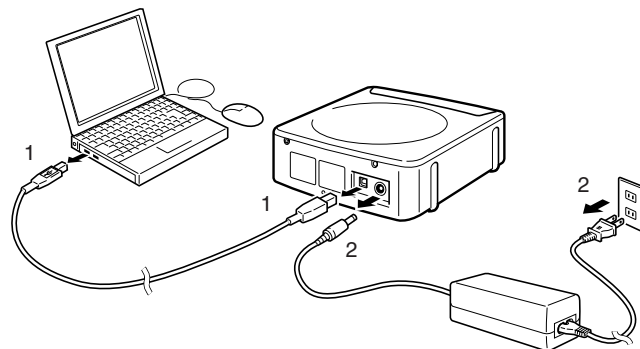

Important!

Never disconnect the AC adaptor, power cord, or USB cable while a print operation is in progress. Doing so creates the risk of malfunction.

Loading and Removing the Ink Ribbon Cassette

You must load an ink ribbon cassette into the printer in order to print.

Important!

- Note that you will not be able to open the disc tray and load the ink ribbon cassette unless the power cord/AC adaptor and USB cable are both connected to the printer. See "Connecting to a Power Source and a PC" on page 21 for more information.
- The carriage is secured in place by packing material to protect it against damage. Before using the printer for the first time, use the procedure on page 24 of this manual to remove the packing material.
- When the ink ribbon cassette requires replacement, purchase a TR-18 ink ribbon cassette.

To load the Ink ribbon cassette into the printer

1. Remove the stopper from the ink ribbon cassette.

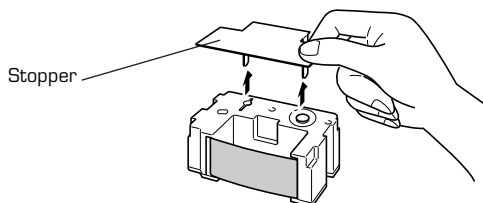

2. Insert a pen or other similar object into the ink ribbon cassette's hub, and rotate the hub to take up any slack.
 - To rotate the hub, it is best to use an object whose surface is not too smooth.
 - If the ribbon is very slack, you may need to rotate the hub a number of times.

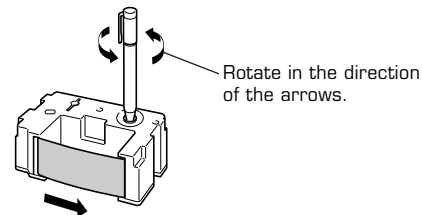

Important!

Loading the ink ribbon cassette while the ribbon is slack can lead to malfunction.

3. Press the **Eject** button on the front of the printer.

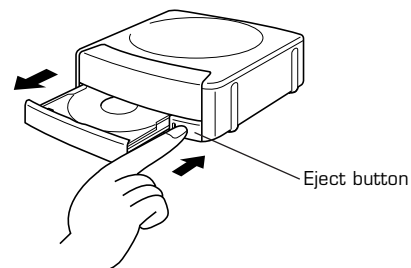

This causes the disc tray to come out part way.

Important!

Make sure there is nothing in front of the printer to interfere with movement of the disc tray.

Note

You can also open the disc tray by clicking the  button (page 37) on the CD/DVD LABEL PRINTER application screen.

4. Gently pull out the disc tray as shown below.

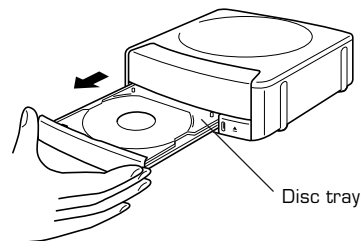

Important!

- Never use excessive force when pulling the tray.
- Do not press down on the tray with excessive force. Doing so can damage the tray.
- If you accidentally pull the disc tray out so far that it detaches from the printer unit, carefully replace the end of the tray onto the rail.

5. Open the front cover.

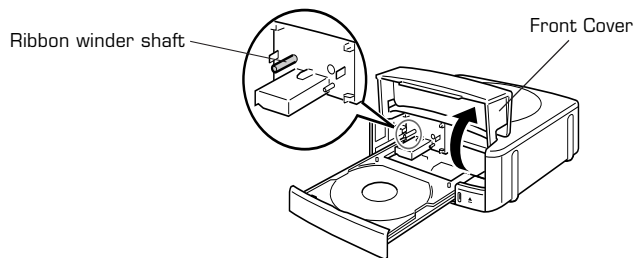

Important!

Do not apply excessive force to the ribbon winder shaft. Doing so can cause the shaft to bend.

Before using the printer for the first time...

When you purchase the printer, the carrier is secured in place by packing materials at the locations shown in the illustration below.

Important!

Be sure to perform the procedures from page 18 through page 24 of this manual before removing the packing material.

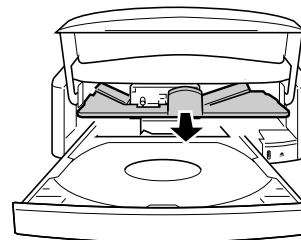

Carefully pull out the packing materials in the direction indicated by the arrows.

Important!

Never perform any of the following actions while the carriage packing material is in place. Doing so creates the risk of printer malfunction.

- Continually pressing the **Eject** button on the front of the printer.
- Continually clicking the  button on the CD/DVD LABEL PRINTER application main window.
- Print operation.

6. Position the ink ribbon cassette so the ink ribbon passes under the print head.

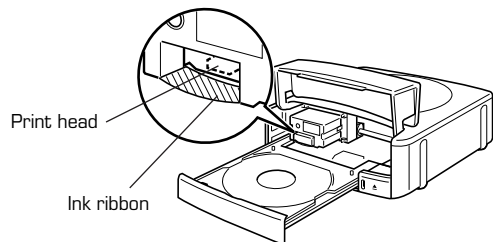

Notes

- Check to make sure that there is no slack in the ink ribbon.
- If the ribbon is slack, perform step 2 of this procedure to tighten it up.

7. Gently press the Ink ribbon cassette against the carriage until you hear it click securely into place.

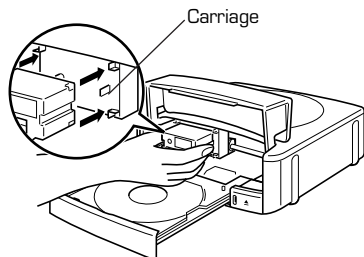

8. Close the front cover.

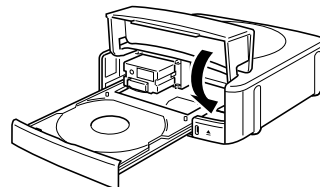

Important!

Always make sure you close the front cover before closing the disc tray.

9. Close the disc tray.

Press the disc tray with your hand until it clicks.

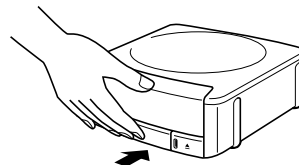

Important!

If you press the **Eject** button while the disc tray is open, the printer will perform an internal process and emit a noise. This does not indicate malfunction.

Note

The color of the disc you are printing on can cause printing to become a different color than that expected from the ink ribbon you are using.

Replacing the Front Cover

If the front cover accidentally becomes detached from the printer, use the following procedure to replace it.

1. Connect the power cord, AC adaptor, and USB cable to the printer, and connect the USB cable to your PC.

Note

See page 21 for more information about making connections.

2. Press the **Eject** button on the front of the printer.
This causes the disc tray to come out part way.

3. Gently pull out the disc tray.

Note

See pages 23 and 24 for details about how to perform steps 2 and 3.

4. While bending the cover guides on the left and right inward, insert the front cover spindles on either side between the printer case and cover guides.

5. Insert the spindles until they enter the holes provided in the printer cover.

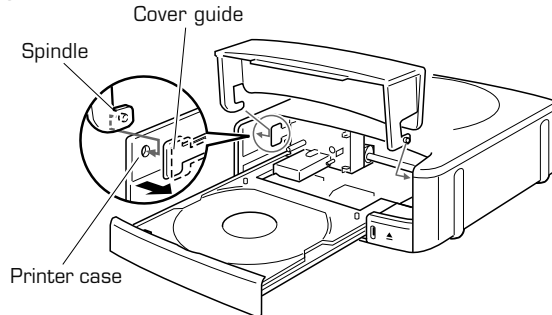

To replace the ink ribbon cassette

1. Press the **Eject** button on the front of the printer.
This causes the disc tray to come out part way.

Important!

Make sure there is nothing in front of the printer to interfere with movement of the disc tray.

2. Gently pull out the disc tray.
3. Open the front cover.
4. Taking care that the carriage does not move, grasp the ink ribbon cassette on either side with your fingers and pull it towards you.

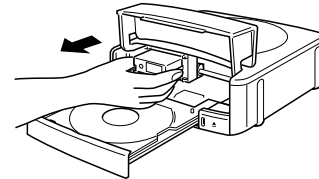

5. Install another ink ribbon cassette.

Storing a Partially Used Ink Ribbon Cassette

Install a stopper on the partially used ink ribbon cassette, place the cassette into its plastic bag, and then into its box. Store it where it will not be exposed to dirt and dust.

Number of Prints Per Ink Ribbon Cassette

- Upper or Lower Label Only:
Approximately 40 prints
- Upper and Lower Label:
Approximately 20 prints

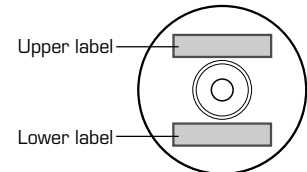

Label Creation Basics

Now that everything is set up, let's try creating a label. This section runs through the basics of label making, from layout, to printing, and saving the label in a file.

Example: Music CD label



To create a label

1. On your Windows desktop, double-click the **CD DVD LABEL PRINTER** short cut icon.



Note

You can also start up the application by clicking the Windows **Start** button and then **All Programs**. Next, point to **TDK**, and then click **CD DVD LABEL PRINTER**. Note that the location of the application may be different on your computer, depending on what you specified when you installed it.

After CD/DVD LABEL PRINTER application starts up, a label template menu appears.

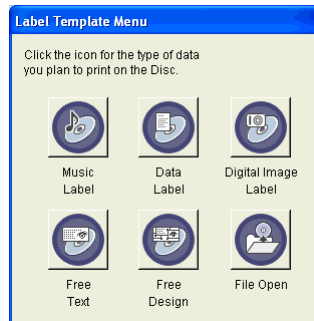

2. Click .

This displays the main window for the music label template.

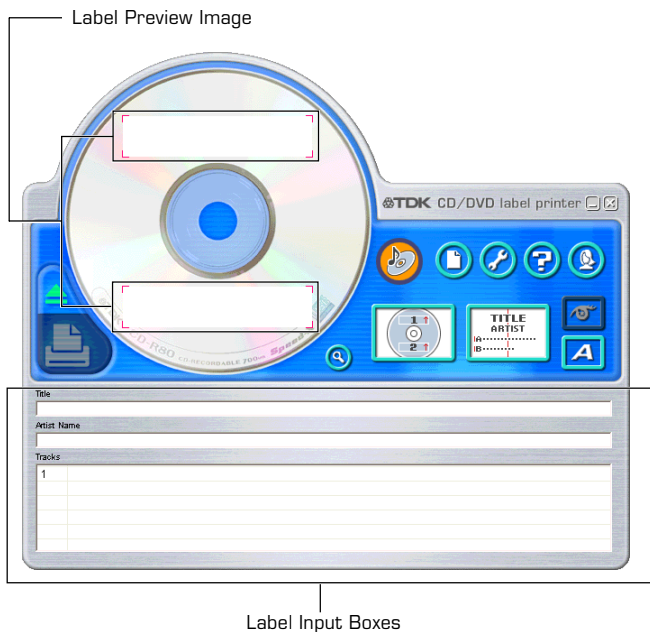

Important!

You must select a label template before you can perform operations on the main window.

3. Input the text data you want.

Move the cursor to the label input boxes, and then type in the disc title, artist names, and track names.

The text you input appears in the preview image on the screen.

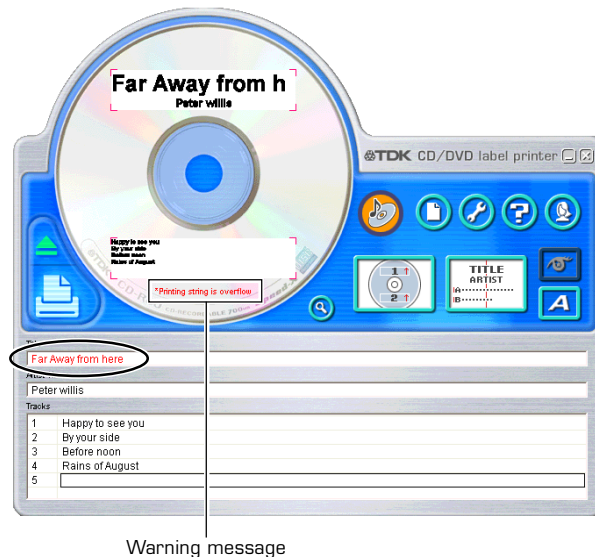

Important!

The warning message "Printing string is overflow" appears when the text data you input does not fit inside the print area.

See "Configuring Text Layout Settings" (page 48) and "Configuring Font Settings" (page 50) for information about adjustments you can make to help the text fit.

Configuring Template Setting

4. Click .

This displays a dialog box for selecting the print pattern.

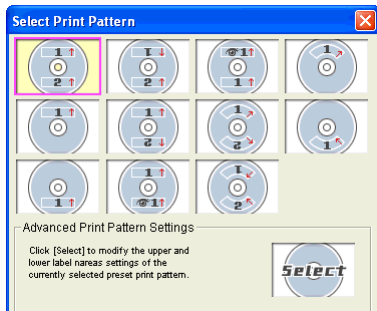

Note

See page 47 for details about print pattern setting.

5. Click .



6. Click .

This displays a dialog box for selecting the text layout.

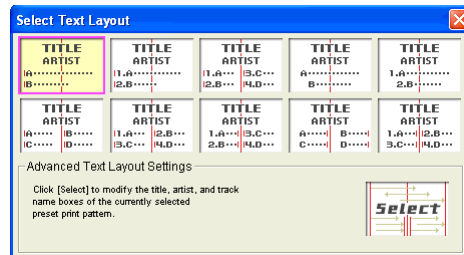

Note

See page 48 for details about changing the text layout pattern.

7. Click .



Selecting a Font

8. Click .

This displays a dialog box for making font settings.

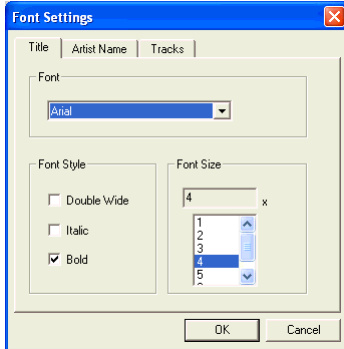

9. Confirm that **Title** tab is selected.

Note

If a different tab is displayed, click **Title**.

10. For **Size**, select **2**.

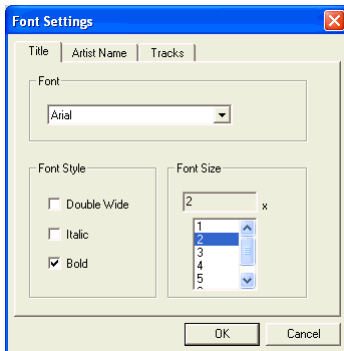

11. Click the **Artist Name** tab.

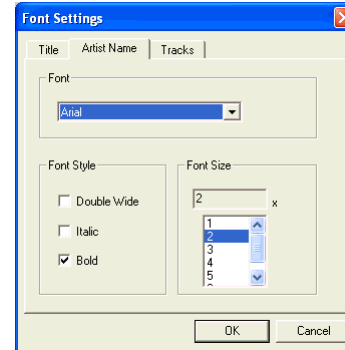

12. Select **2** for **Size**, and then click **OK**.

This completes input of the label data.

Note

See page 50 for details about font settings.



To print a label

Important!

- See the separate "Quick Start Guide" sheet for important information about printing conditions.
- This printer supports printing on 12cm diameter discs only. Attempting to print on a CD-R single or on a business card CD-R can cause damage to the printer.
- We recommend that you use this product for printing on blank, unrecorded media. Printing on media that already had data recorded on it may cause the data to become corrupted.

1. Click .

- Carefully pull out the disc tray to the position shown in the illustration.

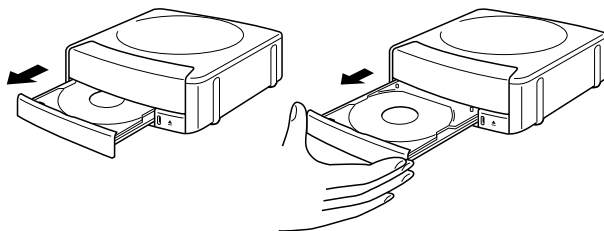

Important!

Make sure there is nothing in front of the printer to interfere with movement of the disc tray.

- This displays a dialog box for printing.

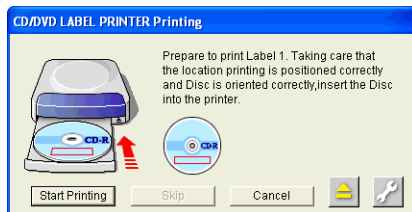

- ### 2.
- In accordance with the instructions on the screen, place the disc onto the tray.

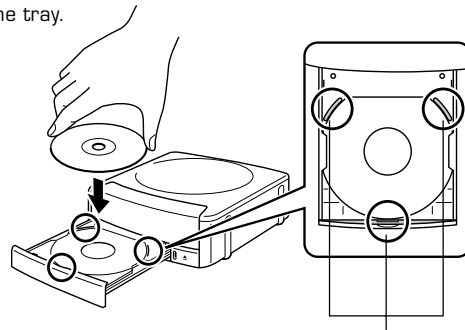

Set the disc onto the tray so it is inside of these raised guides.

When placing the disc on the tray, take special care that it is oriented correctly to allow proper positioning of the label printing.

Important!

- Check to make sure that there is no dirt, dust, or other foreign matter on the disc tray or the disc. Dirt or dust can scratch the recording surface of the disc and make it impossible to record data onto the disc.
- Make sure the label side of the disc is facing up (so you can see it) and the recording side is facing down (towards the tray). Placing the disc onto the tray upside-down will result in printing on the recording side of the disc, which will make the disc unrecordable.
- Printing will be performed inside the area indicated by the guidelines on the disc tray. If the disc already has a logo or other marking on it, position it so printing will be performed in a blank area of the disc.

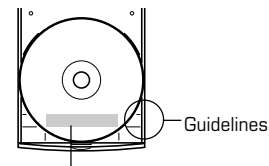

Printing is performed here.

Note

See page 73 for full details about how to position the disc on the tray.

3. Close the disc tray.

Press the disc tray with your hand until it clicks.

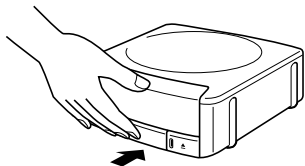

4. Click **Start printing**.

- This starts the print operation.
- The disc tray opens automatically after printing is complete. Carefully pull out the tray and remove the disc.

Important!

Never disconnect the AC adaptor, power cord, or USB cable while a print operation is in progress. Doing so creates the risk of malfunction.

Note

See page 72 for details about printing.

To save label data

1. Click .

2. On the menu that appears, click **Save**.

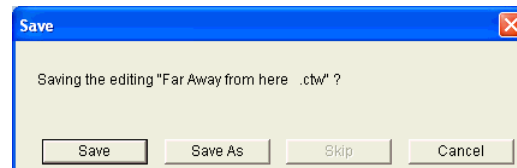

3. Check the file name and then click **Save**.

The label data is saved in your Windows My Documents folder.

Note

See page 44 for details about saving label data.

To quit the CD/DVD LABEL PRINTER application

1. Click .

2. On the menu that appears, click **Exit**.

Note

You can also quit the application by clicking the  button in the upper right corner of a main window.

Important!

You cannot quit the application while a print operation is in progress. Wait until printing is finished before you quit.

Automated Label Layout

A selection of content-specific preset label formats makes label creation as easy as selecting the right format and filling in the blanks. The following procedure shows how to do this, using the music label template as an example.

1. On the main window, click .
2. On the menu that appears, click **New**.
This displays a dialog box for selecting the label template.

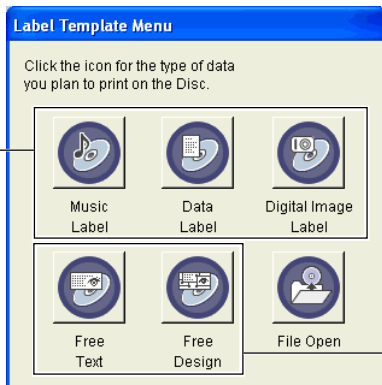

Select one of these preset templates for easy label creation.

Select one of these templates to create an original layout (page 57).

3. Click the label template you want to use.
 - You can select from among five label templates. Selecting a template displays its main window, which contains the elements for the template you select.
 - Input the text you want.

Music Label

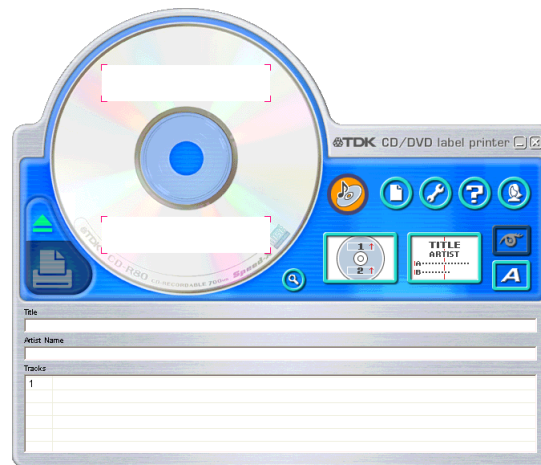

Data Label





Digital Image Label

The screenshot shows a software window titled "Title" with a text input field. Below it is a table with three columns: "Date", "Location", and "Image Information". The first row contains the number "1" in the "Date" column, and the rest of the table is empty.

Date	Location	Image Information
1		

- If you want to create your own original layout, select the Free Text or Free Design template. See “Creating an Original Label Layout” on page 57 for more information.

Using the Assistant Feature

The Assistant feature provides you with step-by-step guidance for creating labels and performing other operations. Clicking the  button on the main window displays the Assistant screen. The Assistant screen does not appear while the Free Text or Free Design label template is displayed.

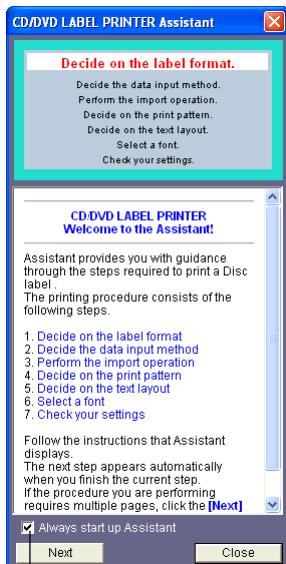

When this option is selected, the Assistant screen appears whenever you start up the CD/DVD LABEL PRINTER application.

Using the Assistant Screen

When you are unsure of CD/DVD LABEL PRINTER application operations...

Follow the instructions on the Assistant screen for quick and easy labels.

Even after you are accustomed to making labels...

Since the Assistant screen changes in accordance with the operation you are performing on the main window, you can refer to it whenever you need a bit of advice.

Using the Main Window

The information in this section describes the main window for the music label template.

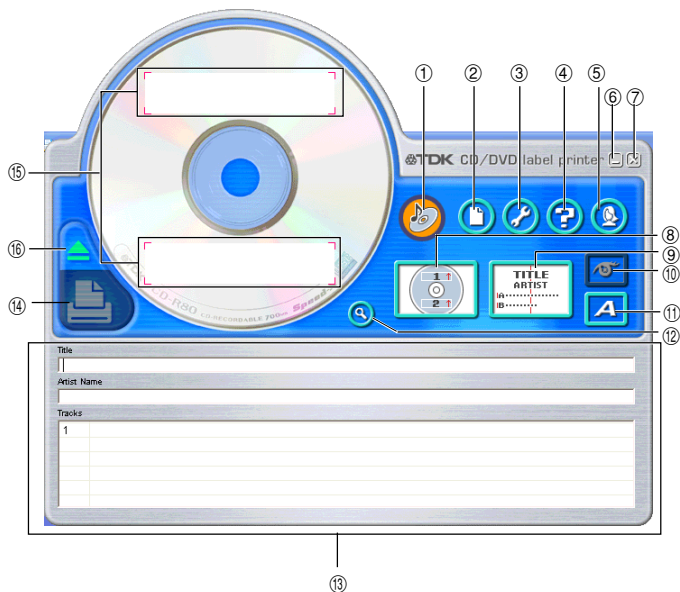



① Label Format Indicator

The icon that appears here indicates the type of label template that is currently displayed in the main window.

Music Label 

Data Label 

Digital Image Label 

Free Text Label 

Free Design Label 

② File Button

Clicking the  button displays a menu of commands that you can use to perform the operations described below.

When you want to do this:	Select this command:
Create a new label (page 33)	New
Open an existing label data	Open
Save label data you are currently working on	Save
Import CD-Text, Media Player, Easy CD Creator data for a music label, or file names and folder names for a data or digital image label Import	Import
Output a list of file names on a printer (page 46)	Create Data Index File
Quit the CD/DVD LABEL PRINTER application	Exit
Click a file name to display the corresponding label data. Note that only the last five files you have saved appear in this list.	Documents

③ Advanced Settings Button

Displays a dialog box for more advanced printing and phrase settings (page 76).

④ Help Button

Displays help.

Clicking the  button displays a menu of commands that you can use to perform the operations described below.

- Display online help
- Access the TDK Website
- Display version information about the software

⑤ **Assistant Button** 

Displays an Assistant window in the upper right corner of the main window.

This button is displayed on the music, data, and digital image label templates only.

⑥ **Minimize Button** 

Minimizes the main window into the menu bar.

⑦ **Exit Button** 

Quits the CD/DVD LABEL PRINTER application.

⑧ **Printing Pattern Panel** 

This panel shows the location and orientation of the printing on the currently selected label. Click this panel when you want to change the location and orientation of the printing.

⑨ **Text Layout Panel** 

This panel shows the currently selected text layout. Click this panel when you want to change the text layout.

⑩ **Image Button** 

Displays a dialog box for selecting graphic images (page 52).

⑪ **Font Button** 

Displays a dialog box for selecting the font type, attributes, and size.

⑫ **Magnifying Glass Button** 

Displays a dialog box with an enlarged preview image.

⑬ **Label Input Boxes**

These boxes are for inputting label text, either manually or by importing it. The text you input immediately appears in the preview image on the screen.

The type of label input boxes that appear on the main window depend on the type of label template.

⑭ **Print Button** 

Click to start a print operation.

⑮ **Label Preview Image**

You can use this image to get an idea of what your label will look like, before you actually print it.

⑯ **Eject Button** 

Opens the disc tray. This button performs the same operations as the Eject button on the front of the printer (page 16).

Important!

The **Eject** button is disabled while a printing operation is in progress.

Importing Text Data

You can import CD-Text data or track and incorporate it into the music label template. CD-Text data or track data can be created using Media Player or Easy CD Creator data.

In the case of a data label template and digital image label template, you can import file names and folder names. Importing text data eliminates the need to type it in manually.

Important!

- You will not be able to import CD-Text if your CD drive does not support CD-Text reading.
- All import data sources (CD-Text, Media Player track data, Easy CD Creator project list, folder name, file name) are included on the **Import** menu of the Free Text template and Free Design template.

Importing CD-Text Data for a Music Label

Before getting started, be sure you have the disc whose CD-Text data you want to import on hand.

What is CD-Text?

CD-Text is text data on a CD that provides the disc title, artist names, track names, and other information. You can import such text using the CD/DVD LABEL PRINTER application and incorporate it into music labels. Note that some CDs may not contain CD-Text data.

1. On the music label template main window, click the  button.
2. Click **Import** and then **Import CD-Text**.
This displays a dialog box for selecting the drive where the CD that contains the text is located.

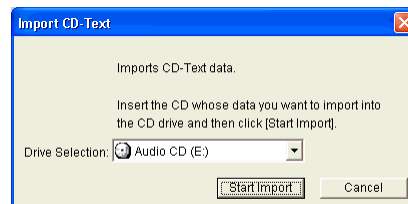

3. Set the disc whose data you want to read into the CD drive of your computer; confirm that the correct drive name is displayed in "Drive Selection" and then click the **Start Import** button.

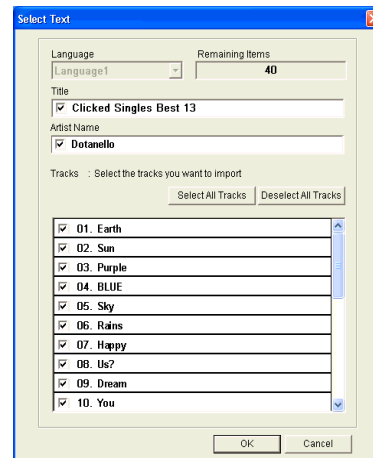

- Language: If the disc whose CD-Text data you are importing has more than one language versions, you will be able to select from up to eight different languages. The selection is dimmed if the disc supports only one language.

Important!

The CD/DVD LABEL PRINTER application supports display of English, Japanese, Korean, and Chinese. Note, however, that your system may not be able to display Japanese, Korean and Chinese correctly if it is not configured for the special characters used by these languages.

- Title: This is the title of the disc.
- Artist Name: This is the name of the artist.
- Tracks: These are the titles of the songs on the disc.
- Select All Tracks: Click here to select all of the track names.
- Deselect All Tracks: Click here to deselect all of the selected track names.
- If you do not want a particular song title to be imported into the label input boxes, uncheck it.

4. After checking the track names in the label input boxes, click **OK**.

The CD-Text data is displayed in the label input boxes and the label preview image.

Important!

Depending on the type of disc you are trying to import from, you may not be able to import CD-Text data correctly.

Importing Media Player Data for a Music Label

What is Media Player?

- Media Player is an application that lets you playback and manage multimedia files that are on your computer or the Internet. CD/DVD LABEL PRINTER application lets you import play lists created using Media Player. This capability is supported for data created using Media Player 7.0 or higher.
- Screen shots shown in this manual are based on Media Player for Windows XP.

Note

Screen contents and operational procedures may be slightly different for other supported Windows versions.

1. Start up Media Player.

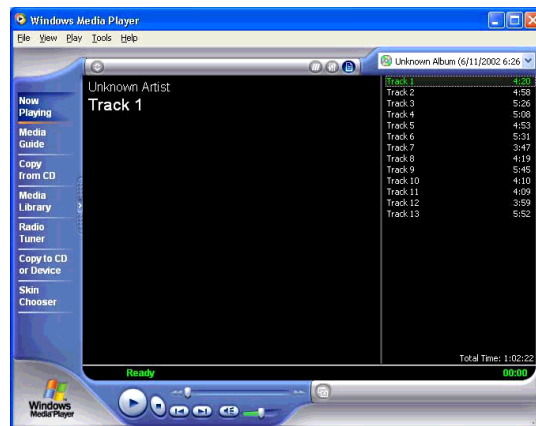

2. Place the disc that contains the play list data you want to import into the CD drive of your computer.

3. After importing the track list, select **Export Playlist to File...** from the File menu, and save data to a playlist file.

With Media Player 7.0, it is not necessary to copy the music.

Note

See Media Player online help for full details about its operation.

4. Start up the CD/DVD LABEL PRINTER application.

5. On the music label main window, click the  button.

6. On the menu that appears, click **Import** and then **Import Media Player Track Data**.

This displays a dialog box for opening a file.

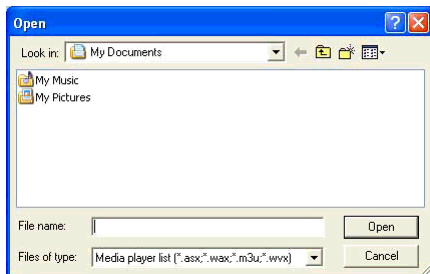

7. Select the playlist you created in step 3, and then click **Open**.

A dialog box for selecting the specific text you want to import appears after all the text on the CD is read.

Note

In some cases, you may not be able to import artist name data from a playlist file created using Media Player on a computer running Windows XP.

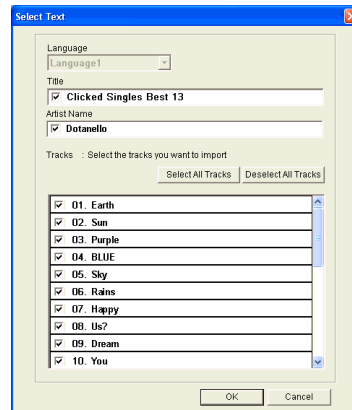

8. After checking the song titles in the label input boxes, click **OK**.

The data you import appears in the label import boxes and the preview image.

Importing Easy CD Creator Data for a Music Label

Note

Easy CD Creator

- Easy CD creator is CD-R and CD-RW writing software. CD/DVD LABEL PRINTER application supports project lists created using Easy CD Creator for incorporation into a music label. This capability is supported for data created using Easy CD Creator 4.0 and 5.0.
- All the screen shots shown in this manual are from Easy CD Creator 5.0.

Important!

- Only project lists created for a music CD can be opened with CD/DVD LABEL PRINTER application.
- Import of project file created by adding an audio file to a track from a computer hard disk is not imported.

1. Start up Easy CD Creator.
2. Place the disc that contains the data you want to import into the CD drive of your computer.
3. Use Easy CD Creator to save the project list.
This saves the project list.

Note

See Easy CD Creator user documentation and online help for details about its operation.

4. Start up CD/DVD LABEL PRINTER application.
5. On the music label template main window, click .

6. On menu that appears, click **Import** and then **Import Easy CD Creator Project List**.

This displays a dialog box for opening a file.

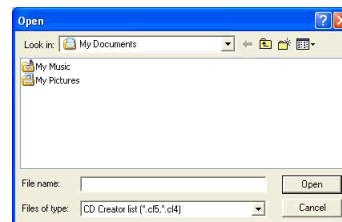

7. Select the project list you create in step 3, and then click **Open**. A dialog box for selecting the specific text you want to import appears after all the text is imported.

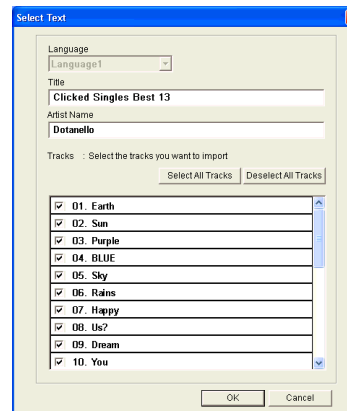

8. After checking the song titles in the label input boxes, click **OK**.
The data you import appears in the label import boxes and the preview image.

Importing File and Folder Name for a Data Label or Digital Image Label

Use the following procedures to import a folder name and file names for data label or digital image label.

To import a folder name

1. On the data label template or digital image label template main window, move the cursor to the label input box where you want to import the folder name, and then click .
2. Click **Import** and then **Import Folder Name**. This displays a dialog box for selecting a folder.



3. Select the folder name you want to import, and then click **OK**. The folder name you import appears in the label input box and the preview image.

To import file names

1. On the data label template or digital image label template main window, move the cursor to the label input box where you want to import the file names, and then click .
2. Click **Import** and then **Import File Name**. This displays a dialog box for selecting files.

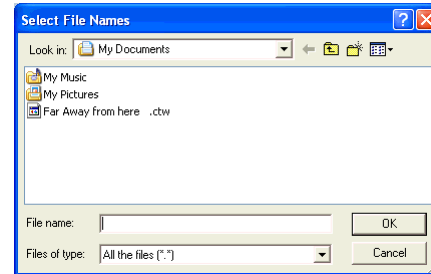

3. Select the names of the files you want to import, and then click **OK**. The file names you import appear in the label input box and the preview image.

Note

- You can select a range of file names by clicking the name at one end of the range to select it, and then holding down your PC keyboard's **Shift** key as you click the name at the other end of the range.
- You can select multiple file names that are not next to each other by holding down your PC keyboard's **Ctrl** key as you click them.
- Note that even when there are multiple file names selected, only one file name appears in the **Title**.

Useful Text Input Functions

Right-clicking the CD/DVD LABEL PRINTER application main window displays a shortcut menu of commands that come in handy during text input.

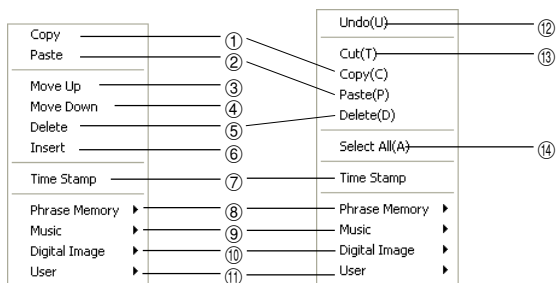

Before text editing

When text has
been edited

- ① **Copy**
Copies the selected text to the clipboard.
- ② **Paste**
Pastes the contents of the clipboard at the current cursor position.
- ③ **Move Up**
Moves the line that is currently selected in a label input box one line up.
- ④ **Move Down**
Moves the line that is currently selected in a label input box one line down.
- ⑤ **Delete**
Deletes the line or text string selected in a label input box.

- ⑥ **Insert**
Inserts a new line above the one that is currently selected in a label input box.
- ⑦ **Time Stamp**
Stamps the current date into the label input box.
The date that is stamped is the one being kept by your PC's clock.
- ⑧ **Phrase Memory**
Shows a list of preset phrases. Clicking a phrase inserts it at the current cursor position.
- ⑨ **Music**
Displays a list of preset phrases you can input into a music label template label input box. Clicking a phrase inserts it at the current cursor position.
- ⑩ **Digital Image**
Displays a list of preset phrases you can input into a digital image label template label input box. Clicking a phrase inserts it at the current cursor position.
- ⑪ **User**
Shows a list of preset phrases registered by you. Clicking a phrase inserts it at the current cursor position. See page 76 for information about registering preset phrases.
- ⑫ **Undo**
Undoes the last operation.
- ⑬ **Cut**
Cuts selected text and places it onto the clipboard.
- ⑭ **Select All**
Selects all the text in a line.

Saving Label Data

1. Click the  button.
2. On the menu that appears, click **Save**.
This displays a dialog box for saving label data.

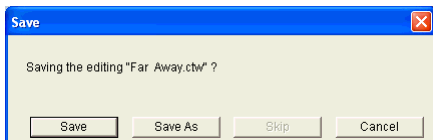

- **Save:** This button appears if this is the first time you are saving the label data. Clicking this button saves the data, assigning the title name as the file name. If the label data you are editing has already been saved, this button name changes to **Overwrite**. Clicking **Overwrite** replaces the existing data with the version you are editing on your PC screen.
- **Save as:** This displays a dialog box for saving the label data under a different file name.
- **Cancel:** This closes the dialog box without saving anything.

3. Click **Save As**.
This displays the **Save As** dialog box.

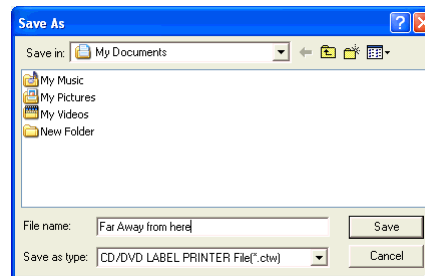

4. Specify the folder in **Save in**, and type a file name into **File name**.
5. Click **Save** to save the data.

Opening a Label Data File

Perform the following steps when you want to open an existing label data file.

1. Click the  button.
2. On the menu that appears, click **Open**.

This displays a dialog box for selecting the file you want to open.

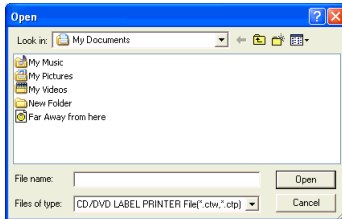

3. Select the name of the file you want to open, and then click **Open**.
The data in the file is displayed in the label input box and the label preview image.

Note

You can also open a label data file by clicking the **File Open** icon on the **Label Template Menu** (Page 33).

Creating a Data Index File

For a disc that contains so much data that it cannot fit on a label, you can use the following procedure to create a data index file that you can print out on a computer printer.

1. Click the  button.
2. On the menu that appears, click **Create Data Index File**.
This displays a dialog box for selecting a folder.

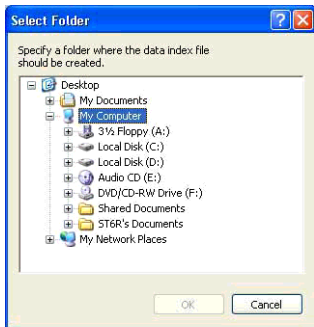

3. Select the folder for which you want to create a data index, and then click **OK**.
This displays the **Save As** dialog box.

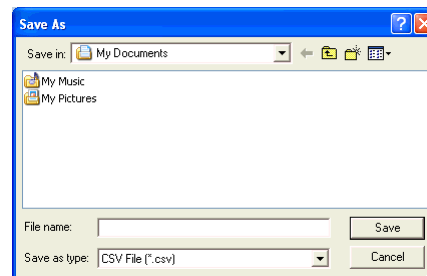

4. Specify the folder in **Save in** and type a file name in to **File name**.
You can specify either CSV or TXT as the file type.
5. Click **Save** to save the data and create a data index file.

Note

You can open a data index file using standard word processor or spreadsheet software, and then print from there.

Configuring Layout Settings

You can control the appearance of your labels using the printing pattern and text layout panels, and the **Font** and **Image** buttons.

Any changes you make to a label are immediately reflected in the label preview image.

To configure layout settings

The print pattern controls the location and the orientation of the printing on a label.



Available Print Patterns

The 11 CD/DVD LABEL PRINTER print patterns are shown below.

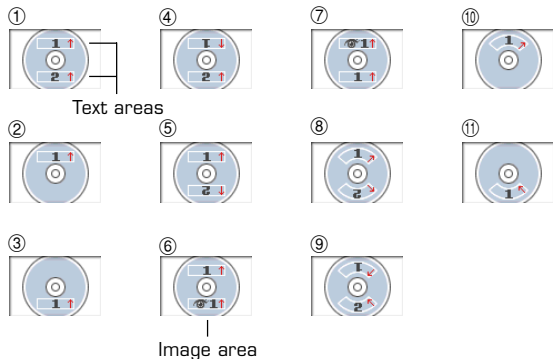

Important!

With print patterns ⑧ through ⑪, only one line of text can be printed in each label print area, regardless of the font size (1x, 2x, 3x) setting.

To configure print pattern settings

1. Click the  panel.

This displays a menu for selecting a print pattern.

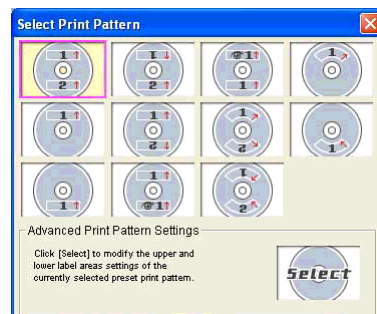

2. Click the print pattern to which you want to change.

This causes the print pattern panel and the label preview image to change in accordance with the print pattern you selected.

To modify a preset print pattern

1. On the main window, click .

This displays a dialog box for selecting a print pattern.

2. Click .

This displays a dialog box for configuring advanced print pattern settings.

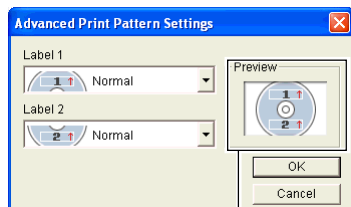

The settings you configure are reflected here.

3. Click the **Label 1** and **Label 2** down arrow buttons and select the setting you want for each of the label areas, and then click **OK**.

This causes the print pattern panel and the label preview image to change in accordance with the settings you configured.

When you specify an image for **Label 1** or **Label 2**, you can specify insertion of Image 1 or Image 2. See **Inserting an Image into a Label** on page 52 for information about Image 1 and Image 2.

To specify this image: Select a print pattern that shows this:

Image 1 



Image 2 

Image 1, Image 2 

Configuring Text Layout Settings

You can select from a number of different layouts for the text on your labels.

About the Layout Panel

This Displays a menu of options.



	Template	Item	Meaning
①	Music Label	Title Artist Name	Centered in the label area.
	Data Label	Title	
	Digital Image Label	Title	
②	Music Label	Tracks	Indicates the following. <ul style="list-style-type: none"> • Text alignment (left, center, right) • Item per line (1 or 2) • Numbered/Non-numbered lines
	Data Label	Contents	
	Digital Image Label	Date Location Image Information	

Available Text Layouts

The 10 CD/DVD LABEL PRINTER text layouts are shown below.



Note

Layouts ③ ④ ⑤ ⑥, ⑨, and ⑩ allow fewer characters per line than the other layouts.

To configure text layout settings

1. Click the  panel.

This displays a menu for selecting a text layout.

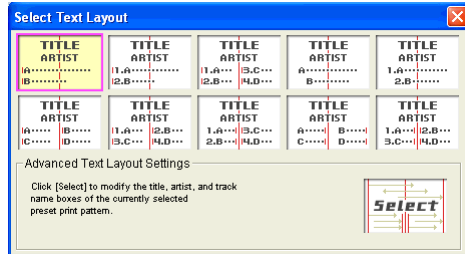

2. Click the text layout to which you want to change.

This causes the text layout panel and the label preview image to change in accordance with the text layout you selected.

To modify a preset text layout

1. On the main window, click .

2. Click .

This displays a menu for selecting a text layout.

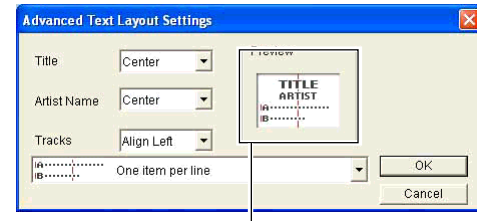

The settings you configure are reflected here.

3. Configure the settings you want for each item, and then click **OK**. This causes the text layout panel and the label preview image to change in accordance with the text layout you selected.

Configuring Font Settings

Use the procedures in this section to control the font, attribute, and size settings of label text.

1. On the main window, click the  button.

This displays a dialog box for configuring font settings.

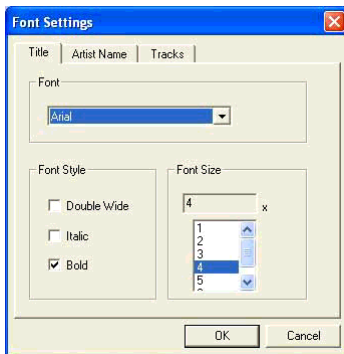

2. Select a tab and then make the settings you want.

The tabs that appear on the above dialog box depend on the type of label template you are using.

When you are using this type of template:	These tabs are:
Music Label	Title, Artist Name, Tracks
Data Label	Title, Contents
Digital Image Label	Title, Date/Location, Image Information

3. Click the ▼ button in **Font**.

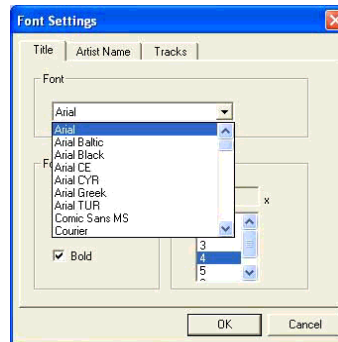

4. Select the font you want from the list that appears.

5. In the **Font Style** group, select one or more of the available options (**Double Wide**, **Italic**, **Bold**).

Note

The standard default is all font styles unchecked.

6. In the **Font Size** group, select the font size you want.

Important!

You can input text for up to six text input areas in a single label. Note that the number of lines you can input is affected by the font size you select. If you specify a 2-line font size for the title font and artist name, when creating a music CD label, for example, you will be able to input only two lines of song title text.

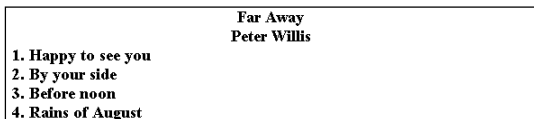

Important!

- With print patterns ③ through ⑪ (page 47) , only one line of text can be printed in each label print area, regardless of the font size {1x, 2x, 3x} setting.
- With print patterns ①, ④, and ⑤ (page 47), selecting certain font sizes can cause text on the upper part of the label preview image to shift to the lower part, or text on the lower part of the image to shift to the upper part.

7. After completing the settings, click **OK**.



The settings you configure are reflected in the preview image on the main window.

Inserting an Image into a Label

You can use either of following two methods to input an image into a label.

- Inputting an image from a file
- Capturing a PC screen image

Important!

- To input an image into a label, you need to select print pattern ⑥ or pattern ⑦ (page 47), or a setting that is marked with  on the **Advanced Print Pattern Settings** dialog box (page 48).
- Even if you are inserting a color image, it is printed in monochrome in accordance with the “Dithering” settings. See page 55 for more information.
- To view the actual print image, click .

To input an image from a file

1. On the main window, click the  button.
This displays the Image dialog box.

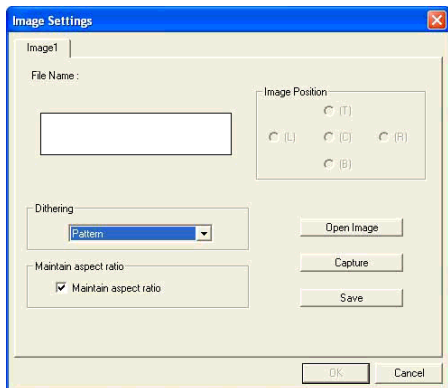

2. Click **Open Image**.

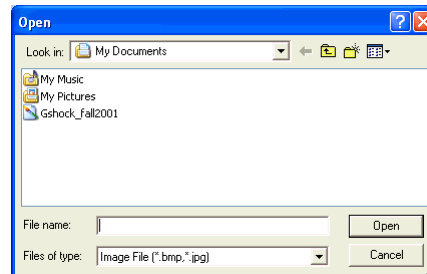

3. Select the file name of the BMP or JPEG image you want to input, and then click **Open**.

This displays the selected image in color in the center of the **Image Settings** dialog box preview area.

4. After making sure the preview shows the image you want, click **OK**.
Note that the layout preview image on the main window shows the image you selected in monochrome.

Note

- See page 55 for information about monochrome conversion dithering settings.

Capturing a PC Screen Image

Perform the following steps to capture a screen image and insert it into a label.

1. On the main window, click the  button.
This minimizes the main window.



2. Display the screen you want to capture.
3. On the Windows task bar, click **CD/DVD LABEL PRINTER**.
This displays the main window.

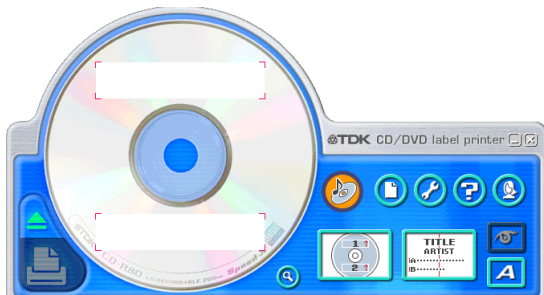

4. On the main window, click the  button.
This displays the Image dialog box.

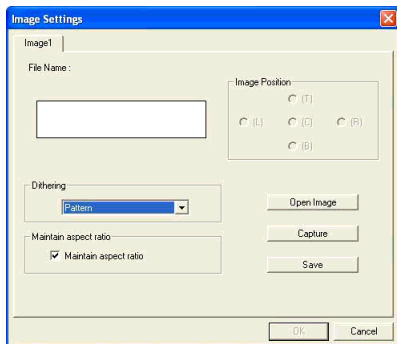

5. Click **Capture**.
This minimizes the main window.

Note

To cancel the capture operation, press the **Esc** key or right-click your mouse.

6. Locate the mouse pointer at one of the corners of the area you want to select for capture. Holding down the left mouse button, drag the pointer to the corner that is diagonally opposite the one you started from.

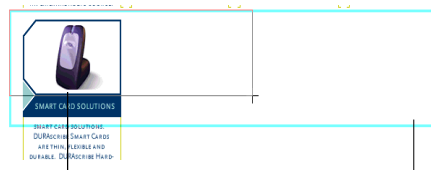

This draws a selection boundary around the area. Guidelines also appear that correspond to the area of the layout size.

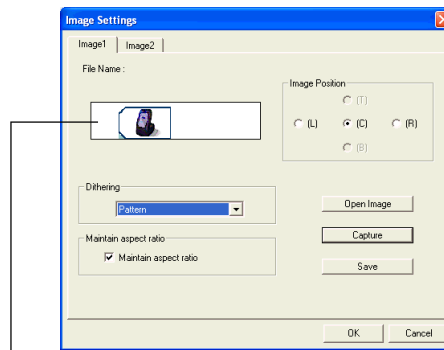

A color image of the selected area appears in the **Image Settings** dialog box preview area.

7. After making sure the preview shows the image you want, click **OK**. Note that the layout preview image on the main window shows a monochrome version of the image you selected.

Note

- See page 55 for information about monochrome conversion dithering settings.

To save a captured image to your PC's hard disc

1. While the captured image is shown on the **Image Settings** dialog box, click **Save**.

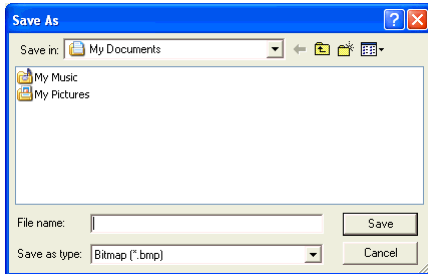

2. Specify the folder in **Save in** and type a file name into **File name**.
 3. Click **Save**.

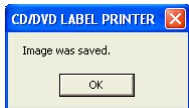

4. Click **OK**.
 Captured images are always saved in BMP format.

Controlling the Aspect Ratio of an Image

Perform the following steps to specify whether the aspect ratio should be maintained when the image is resized, and to specify the position of the image.

1. While an image is displayed in the preview area of the **Image Settings** dialog box, select the **Maintain aspect ratio** setting you want.

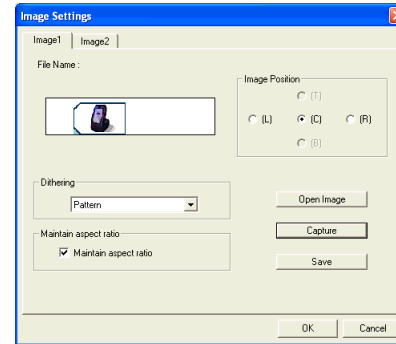

When you want to do this:	Do this:
Enlarge or reduce the image to fit the label area while maintaining the ratio between the image's vertical and horizontal dimensions.	Select the Maintain aspect ratio check box.
Enlarge or reduce the image to fit the label area without maintaining the ratio between the image's vertical and horizontal dimensions.	Clear the Maintain aspect ratio check box.

Maintain Aspect Ratio On

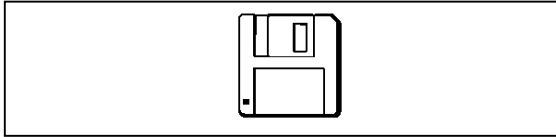

Maintain Aspect Ratio Off

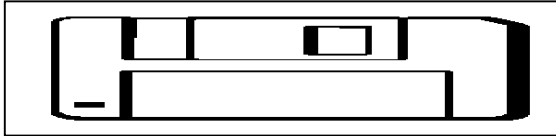

Note that the **Image Position** settings appear dimmed and are not available when the **Maintain aspect ratio** check box is cleared.

2. While an image is displayed in the preview area of the **Image Settings** dialog box, select the setting you want under **Image Position**.
3. When all the settings are the way you want, click **OK**.
 - The settings you configure are reflected in the preview image on the main window.

Note

To view the actual print image, click .

About color images...

When you insert a color image, it is automatically converted to a monochrome image. The colors of the image are expressed as different shades of gray.

1. While the image you inserted is displayed in the layout preview image, click the ▼ button in **Dithering**.

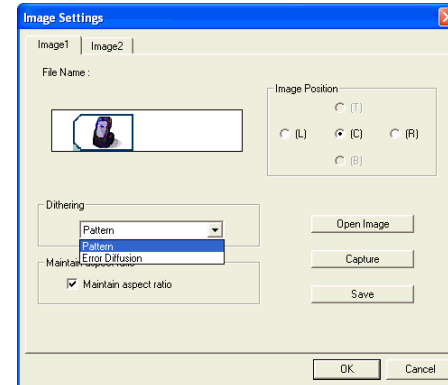

2. Select "Pattern" or "Error Diffusion" and then click **OK**.

The dithering setting you select is reflected in the label preview image on the screen.

Difference between Pattern and Error Diffusion Dithering

With both dithering methods and dark colors are printed blacker, while light colors are a lighter shade of gray. Compared with **Pattern** dithering, **Error Diffusion** takes longer, but the printout looks better.

Pattern

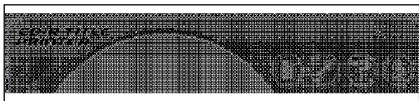

Error Diffusion

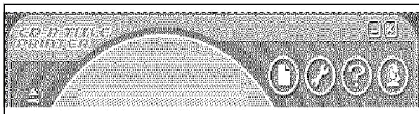

Creating an Original Label Layout

There are two templates for creating an original label layout: the Free Text label template and the Free Design label template. For details about more basic label creation procedures, see the steps under "Automated Label Layout".

Free Text Label Template



- The Free Text label template lets you input text using many of the same techniques available on a word processor application.
- You can specify the font, font size, and other settings on a text string level. Images can be inserted as the background of a label (page 62), and you can even insert different images for the upper label area and the lower label area.

Free Design Label Template

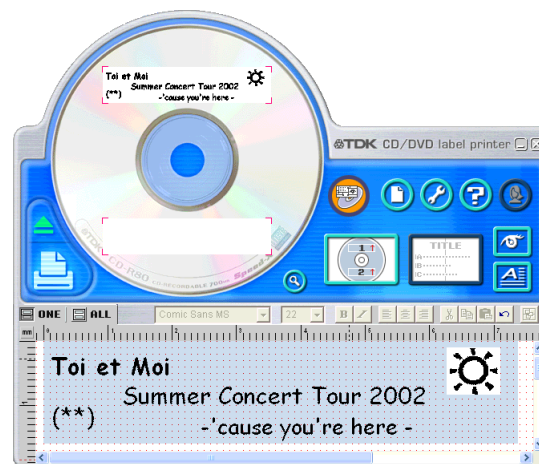

- The Free Design Label Template gives you maximum control over the appearance of the label you are creating.
- It lets you input text and images into individual fields, which you can then place in label areas as you like.
- You can have a total of 40 fields in the upper and lower label areas.

Free Text and Free Design Common Characteristics

- The following characteristics are common to both the Free Text label template and the Free Design label template.
- CD-Text, Media Player, and Easy CD Creator track name data, as well as file names and folder names can be imported into labels.
- Font and font size settings are configured using toolbar buttons.
- The **Text Layout** panel appears dimmed, which means it is not available.

Free Text Label Template Main Window

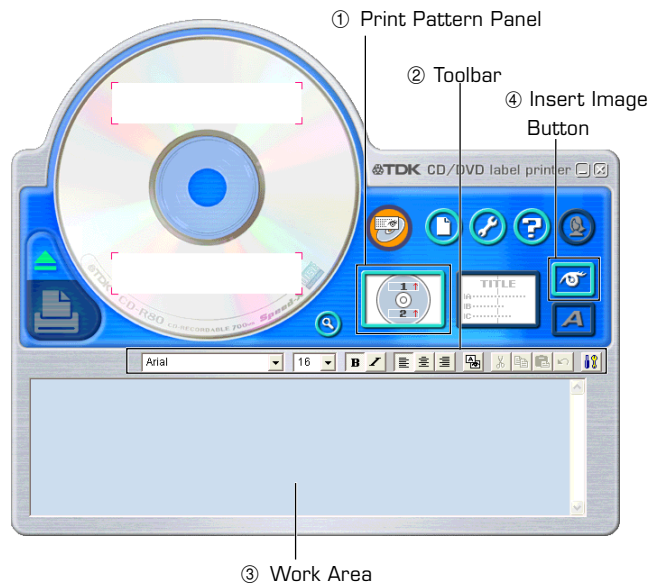

Free Design Label Template Main Window

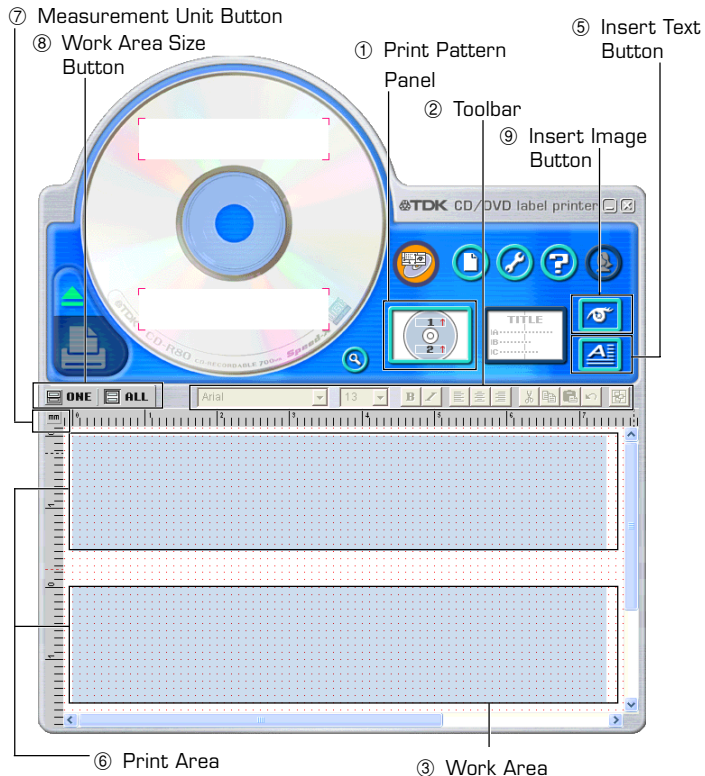

Free Design and Free Text Template Main Windows

Free Text Template

① Print Pattern Panel

This panel shows the location and orientation of the printing on the currently selected label. Click this panel when you want to change the text layout.

② Toolbar

Contains a selection of useful editing tools. Click a tool to use it. See “Toolbars” on the right for more information.

③ Work Area

This is the area where you layout the label.

④ Insert Image Button

Click to insert an image or a background image.

Free Design Template

See “Free Text Template” for information about ①, ②, and ③.

⑤ Insert Text Button

Click to insert a text field.

⑥ Print Area

Indicates the area within the work area that is actually printed. You can move the print area by dragging it.

Any text or images that are outside of the print area are not printed.

⑦ Measurement Unit Button

Shows the currently selected measurement unit.

Each click of the measurement unit button cycles through the units in the following sequence: mm (millimeters) → Pel (pixels) → inch → mm.

⑧ Work Area Size Button

Clicking these buttons changes the size of the work area as described below.

ONE: Clicking this button displays the top label area only in the work area.

ALL: Clicking this button expands the work area so it displays both top label area and the bottom label area.

⑨ Insert Image Button

Click to insert a image field.

Toolbars

The following describes the tools that are available in the toolbars on the Free Text and Free Design label template main windows.

Free Text Template

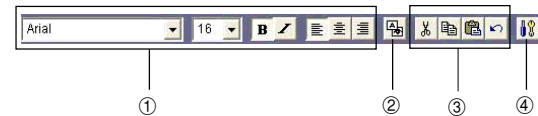

① Font Settings

Use these tools to select the font, font size, etc.

② Show Background Button

On the Free Text label template main window, this button displays the selected background image.

③ Editing Tools

Use these tools to cut, copy, and paste text and fields, and to undo editing operations.

④ Background Image Settings Button

On the Free Text label template main window, this button displays a dialog box for configuring background image settings.

Free Design Template

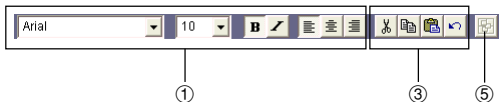

See "Free Text Template" for information about ① and ③.

⑤ **Layout Button**

Alignment

The commands in this submenu align fields on a reference field.

- Left Aligns the selected fields on their left sides.
- Center Horizontally Aligns the selected fields on their horizontal centers.
- Right Aligns the selected fields on their right sides.
- Top Aligns the selected fields on their tops.
- Center Vertically Aligns the selected fields on their vertical centers.
- Bottom Aligns the selected fields on their bottoms.

Uniform Spacing

- Vertical Arranges three or more fields so they are evenly spaced vertically.
- Horizontal Arranges three or more fields so they are evenly spaced horizontally.

Center

- Vertical Centers the selected fields vertically in the print area.
- Horizontal Centers the selected fields horizontally in the print area.

Send

- To Front Sends the selected field to the front of all the fields.
- To Back Sends the selected field to the back of all the fields.
- Forward Sends the selected field one level forward.
- Back Sends the selected field one level back.

Resize

- By Width
- By Height Makes all of the selected fields the same height and/or width.
- By Height and Width

Other

- Maximize Enlarges the field so it fills the print area.
- Center Moves the field to the center of the print area.
- Maintain Aspect Ratio and Center Maximizes the field while maintaining its aspect ratio, and centers it in the print area.

Important!

Certain fonts and font size settings can cause poor printing results.

Configuring Font Settings (Free Text Template, Free Design Template)

This section describes how to configure font settings for text you input manually into the work area, or text you import (page 38).

You can select font, font size, font style, and text alignment from the toolbar.

Font Setting Tools



■ To specify the font





1. Input text into the work area.
2. Highlight the characters whose font setting you want to edit.
3. On the toolbar, click the down arrow button, and then select the font you want from the list that appears.
 - Your font selection is reflected in the work area and the preview image.

■ To specify the font size

1. Input text into the work area.
2. Highlight the characters whose font size you want to specify.
3. On the toolbar, click the down arrow button, and then select the font size you want from the list that appears.
 - Your font size selection is reflected in the work area and the preview image.
 - If the font size you want is not included in the list, select the font size box in the toolbar and type in the size you want.



■ To change font style settings

You can use the following procedure to italicize or bold text.



1. Input text into the work area.
2. Highlight the characters whose font style setting you want to change.
3. Click  to make the selected text bold, or  to make the text italic.
 - Your font style setting is reflected in the work area and the preview image.
 - Selecting bold text and clicking  or italicized text and clicking  removes the corresponding style and returns the text to normal.

■ To change the alignment of text

You can align text so it is left-aligned, centered, or right-aligned.

1. Input text into the work area.
2. Locate the cursor inside the text whose alignment you want to change.
3. Click  to left-align the text,  to center the text, or  to right-align the text.
 - The alignment you specify is reflected in the work area and the preview image.

Inserting a Label Background Image (Free Text Layout)

1. On the main window, click .
2. Click , and then select the image you want to insert.
 - The image appears in the preview image on the main window.
 - One image can be inserted per label area.
After you insert an image into print pattern , you cannot input text. To insert a label background image, choose **1** or **2**.

Note

- See "Inserting an Image into a Label" on page 52 for information about inserting images.
- See "Configuring Layout Settings" on page 47 for information about print patterns.

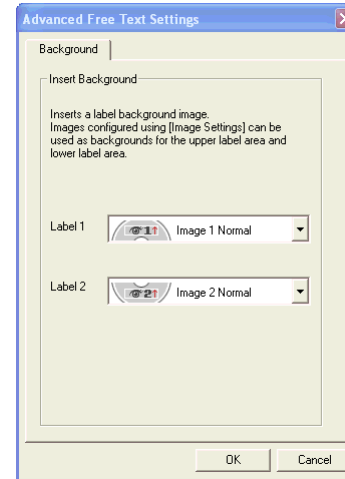

To specify the image orientation

1. On the main window, click .
This displays the **Advanced Free Text Settings** dialog box.



2. Specify the orientation for the images in the upper label area and the lower label area, and then click **OK**.

To turn off display of background images

1. On the main window, click .
This turns off display of the background images. Clicking  again turns display of the background image back on.

Note

- Text overlaid on a background image can become distorted when printed. Because of this, we recommend that you lay out your label so the text is not overlaid on an image.
- Clicking  displays an enlarged preview image, which comes in handy when layout label elements.

Fields (Free Design Template)

This section contains general information about fields. It also explains operations that are common to both text and image fields.

Field Types

A field is a kind of box you can insert into the work area to hold text or an image. Text goes into text fields, while images go into image fields.

Selecting a single field causes it to be enclosed with a gray selection boundary. Selection boundaries do not appear on printouts.

Text Field

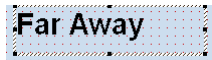
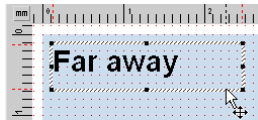

Image Field



■ Selecting a Field

Text Field: Click on the boundary of a field to select it. You can move or delete a field whose boundary appears as shown below.



The shape of the mouse pointer changes when it is located near a field boundary.

If the text field has a white background and the cursor flashing inside it (for text input and editing), click the boundary of the field again.

To select a field for inputting or editing text, click anywhere inside the field boundary.

A text field is selected for text input and editing when it appears as shown below.

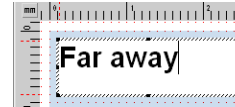

Image Field: Click anywhere inside an image field to select it.

An image field that has a light gray boundary around it can be moved or deleted.

Common Text Field and Image Field Operations

The following operations are the same for both text fields and image fields.

■ To move a field

Select the field and then drag it to the location you want.

Note

- For fine movement of a field, use your keyboard arrow keys. Each press of an arrow key moves the selected field one dot.

To delete a field

Select the field and then press the **Delete** key.

Inputting Text into a Text Field (Free Design Template)

The following describes how to input, edit, and delete text.

To input text manually

1. On the main window, click .

This inserts a text field into the upper label area.

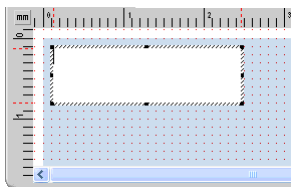

2. Type in the text you want.

To input text imported from a file

Use this procedure below to import text from a CD-Text, Media Player, or Easy CD Creator file, and input it into a label.

1. Using the procedure under "Importing Text Data" on page 38, import the text from a file.

A dialog box for selecting the specific text you want to import appears after all the text is imported.

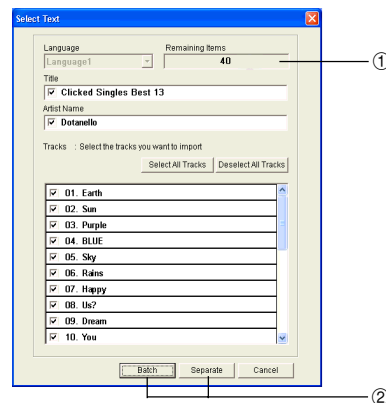

- ① Indicates the number of fields that can still be inserted. A label can contain up to 40 fields total.

The **Separate** and **Batch** buttons appear dimmed and unavailable when there are 40 fields in a label.

- ② **Batch:**

Imports all selected items into a single field.

Separate:

Using this option imports only the titles, artist names, and track names whose check boxes are selected into individual fields.

2. Click **Batch** or **Separate**.

- The text you input here appears in the work area and the label preview image.

Note

- When you import file names and folder names, click **OK**.
- When you import file names and folder names, each name is inserted into its own field.

To configure font settings for the text in a field

1. Highlight the text whose font settings you want to change.
2. Use the toolbar to configure font, font size, and font style settings.

Note

See "Toolbars" on page 59 for more information.

To delete a text field

1. Select the text field you want to delete.
2. Press the **Delete** key on your computer keyboard.
This deletes the text field.

Inserting an Image into a Label (Free Design Template)

Use the procedures in this section to insert an image into a label and to delete a label image.

To insert an image into a label

1. On the main window, click , configure settings for the image you want to insert, and then click **OK**.
 - This inserts the image in the center of the print area.
 - If the selected image is larger than the work area, it is resized to fit while maintaining the relationship between its horizontal and vertical dimensions (aspect ratio).

To delete an image field

1. Select the image field you want to delete.
2. Press the **Delete** key on your computer keyboard.
This deletes the image field.

Resizing a Field (Free Design Template)

Use the procedures in this section when you want to change the size of a field.

Important!

Note that the result obtained when you resize a field depends on whether it is a text field or an image field.

1. Select the field you want to resize so it is enclosed by a gray selection boundary.
2. Use one of the techniques described below to drag one of the four corner handles on the boundary to resize the field.

Example: Simple drag operation

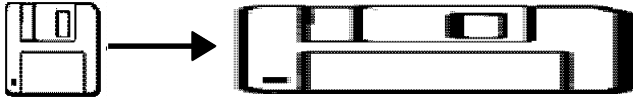

- **Simple Drag Operation**
Simply dragging a corner handle resizes the field, without maintaining its aspect ratio.
- **[Shift] + Drag**
This resizes the field while maintaining its aspect ratio. The field is enlarged or reduced with the corner that is diagonally opposite from the one you are dragging fixed.
- **[Shift] + [Ctrl] + Drag**
This also resizes the field while maintaining its aspect ratio. The field is enlarged and reduced with its center fixed.

Important!

Resizing a text field does not affect the size of the text inside the field.

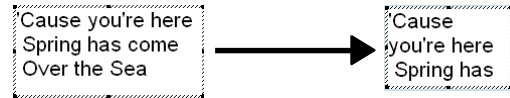

Aligning and Resizing Fields (Free Design Template)

A selection of useful commands makes it possible to instantly position fields on a label and to make multiple fields the same size (See page 60).

Note

You can use the following procedures for both text fields and image fields.

■ What is alignment?

The CD/DVD LABEL PRINTER application lets you align multiple fields vertically or horizontally in relation to a reference field that you specify.

Example: To center fields vertically

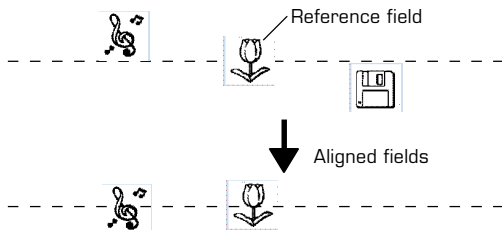

■ To make multiple fields the same size

You can resize multiple fields so they are the same size as a reference field that you specify.

Example: Resizing fields by height and width

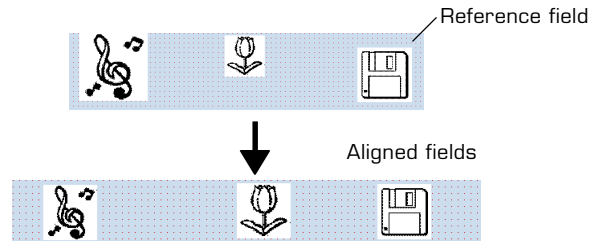

To align fields

1. Drag the mouse on the label so the fields you want to align or resize are enclosed in the selection boundary.

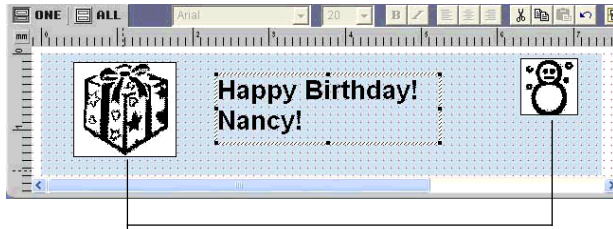
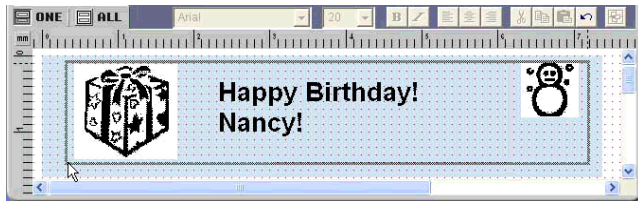

Thin boundary

Selection boundary

- The reference field is surrounded by a relatively thick gray boundary, while other selected fields are surrounded by thin boundaries.

NOTE

- You can also select and deselect fields using **Shift + click**.
- To deselect all of the currently selected fields, simply click anywhere outside of the selected fields.

2. To make a different field the reference field, hold down the **Ctrl** key as you click the new reference field.

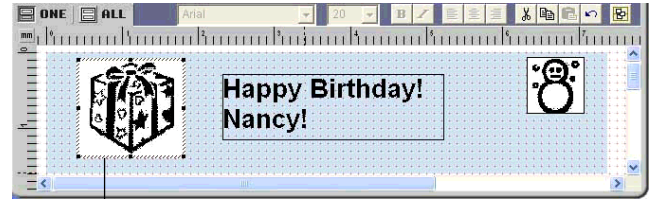

This is the reference field.

3. Click the  button.
This displays a menu.

Note

- See "Toolbars" on page 59.

4. On the menu, select **Align**.
5. On the submenu that appears, select the command you want.
The selected fields are aligned in accordance with the command you select.

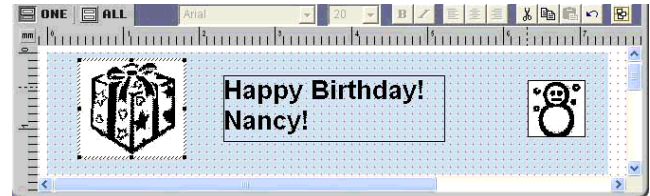

The above shows the result of **Alignment – Center Vertically**

Configuring Field Properties (Free Design Template)

Clicking the  button and then **Properties** displays a dialog box that you can use to change the properties of a field.

Note

The unit of measurement (millimeters, pixels, inches) used on the **Field Properties** dialog box is the same as that selected with the ruler unit of measurement button (Page 59).

To reposition and resize a field

1. Select the field you want to reposition. On the main window, click .

Note

If multiple fields are selected, only the reference field (the one with the gray selection boundary) can be repositioned.

2. On the menu that appears, click **Properties**.
This displays the **Field Properties** dialog box.

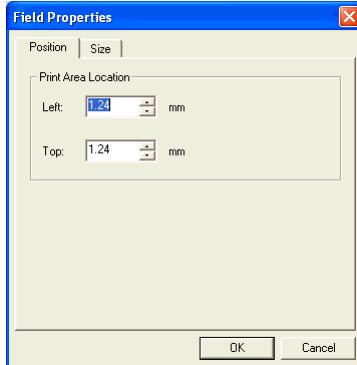

Print Area Location

These values indicate the relative location of the print area from the upper left corner of the work area. Changing the values in the box causes the print area to move to the new location.

3. Input the values you want. The settings you configure are reflected in the preview image on the main window.
4. Click the **Size** tab.

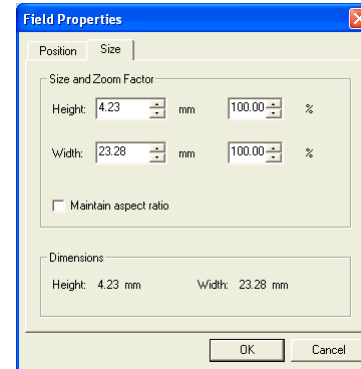

Size and Zoom Factor

Inputting a value in one box automatically changes the value in the other box.

Maintain aspect ratio

When this check box is selected, the field is resized while maintaining the relative ratio between its vertical and horizontal dimensions. When this checkbox is cleared, a field can be resized by changing the horizontal or vertical dimension only.

Dimensions:

These are the dimensions of the image when it was originally captured or imported from a file.

5. Input the values you want and then click **OK**. The settings you configure are reflected in the preview image on the main window.

Useful Text Input Functions (Free Text Template, Free Design Template)

This section describes various useful functions you can access on the shortcut menu that appears when you right-click on the Free Text label template or Free Design label template.

Right-clicking the mouse while the cursor is located in the work area displays one of the shortcut menus shown below.

When a field is not selected

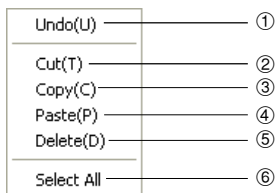

When a field is selected

Free Text Template Free Design template

(When a text field is selected.)

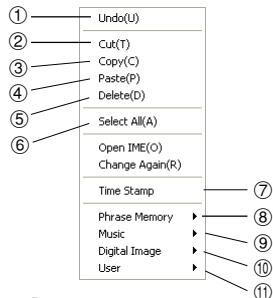

Free Design Template

(When an image field is selected.)

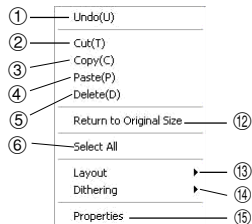

- Undo**
Undoes the last operation you performed.
- Cut**
Cuts the currently selected field from the label and places it onto the clipboard.
- Copy**
Copies the currently selected field and places it onto the clipboard.
- Paste**
Inserts the clipboard contents into the work area.
- Delete**
Deletes the selected field.
- Select All**
Selects all of the fields in the work area.
- Time Stamp**
Stamps the current date into the work area. The date that is stamped is the one being kept by your PC's clock.
- Phrase Memory**
Phrase Memory lets you select and input preset words and expressions from a menu.
- Music**
Displays music phrases and expressions. Select the phrase you want from the submenu that appears to input it.
- Digital Image**
Displays digital image phrases and expressions. Select the phrase you want from the submenu that appears to input it.

⑪ **User**

Shows a list of preset phrases registered by you. Clicking a phrase inserts it at the current cursor position. See page 76 for information about registering preset phrases.

Note

See the "Phrase Library List" on page 80 for more information.

⑫ **Return to Original Size (Image Field only)**

This command change the size of the field so the image within it is the same size it was when captured or imported.

⑬ **Layout**

Use the commands on the submenus to align fields and to move them forward and back.

Note

- See "Toolbars" on page 59.
- See "Aligning and Resizing Field" on page 67.

⑭ **Dithering (Image Field Only)**

Use the submenu that appears to select either **Pattern** or **Error Diffusion** for the dithering method.

⑮ **Properties**

Displays a dialog box that shows the properties of the selected field. You can also configure position and size settings on the properties dialog box.

Note

See "Configuring Field Properties" on page 69 for more information.

Printing a Label

Perform the steps below to print label data on the printer.

Important!

- See the separate "Quick Start Guide" sheet for important information about printing conditions.
- This printer supports printing on 12cm diameter discs only. Attempting to print on a CD-R single or on a business card CD-R can result in damage to the printer.
- We recommend that you use this product for printing on blank, unrecorded media. Printing on media that already had data recorded on it may cause the data to become corrupted.

To print a label

Important!

Check the following points before you start to print.

- Make sure the printer is plugged into a power outlet and connected to your computer (page 21).
- Make sure an ink ribbon cassette is loaded in the printer (page 23).

1. While the label data you want to print is displayed in the label input boxes, click the main window's  button.
 - This causes the disc tray to come out part way. Gently pull out the disc tray the rest of the way.
 - This displays a dialog box for printing.

Note

Note that the disc tray does not open automatically when you have the **Manually open Disc tray before printing** option selected for the **Auto Disc Tray Operation Setting** item on the **Print** tab of the Advanced Settings dialog box. In this case, click the  button on the Print dialog box or press the **Eject** button on the front of the printer. See page 16 for more information.

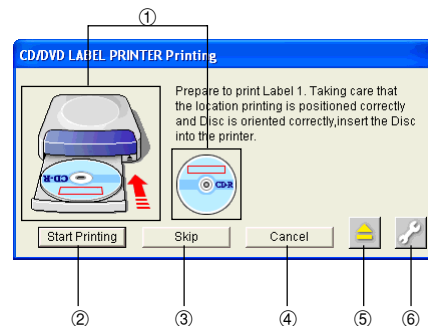

- ① Shows how the disc should be oriented and the print location in accordance with the selected print pattern.
- ② Click to start a print operation.
- ③ Click to skip the Label 1 (first) printing and perform Label 2 (second) printing.
- ④ Stops printing.
- ⑤ **Eject Button.**
Opens the disc tray.
- ⑥ Displays a dialog box for more advanced printing and phrase settings. See page 76 for more information.

2. Place the disc whose label you want to print into the disc tray.

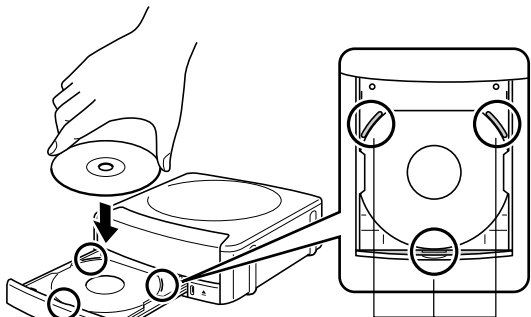

Set the disc onto the tray so it is inside of these raised guides.

Make sure you check the print layout and orientation before placing the disc onto the tray.

Important!

- Check to make sure that there is no dirt, dust, or other foreign matter on the disc tray or the disc. Dirt or dust can scratch the recording surface of the disc and make it impossible to record data onto the disc.
- Place the disc onto the tray so the label side of the disc is facing up (so you can see it) and the recording side is facing down (towards the tray). Placing the disc onto the tray upside-down will result in printing on the recording side of the disc, which will make the disc unrecordable.

3. Place the positioning guide on top of the disc.

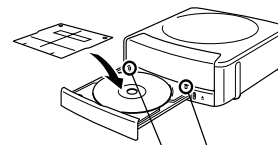

Place the positioning guide here.

Note

If the label of the disc you are using does not have specific printing areas, you can skip steps 3 and 4.

4. After positioning the disc, remove the positioning guide.

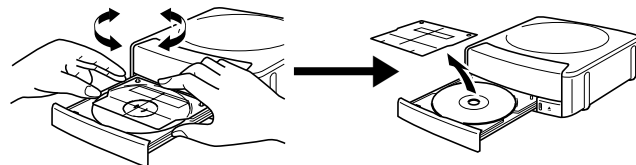

Place the positioning guide while watching the guidelines on the disc tray.

Note

Adjust the position of the disc so printing does not overlap logos, etc. See "Positioning the Disc on the Tray" on page 75 for more information.

Important!

Make sure to remove the positioning guide before printing.

5. Close the disc tray.

Press the disc tray with your hand until it clicks.

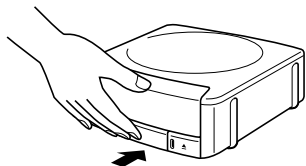

6. Click **Start Printing**.

This starts the first printing.

Important!

Never disconnect the AC adaptor, power cord, or USB cable while a print operation is in progress. Doing so creates the risk of malfunction.

- The disc tray opens slightly after printing is complete. Gently pull out the tray the rest of the way.
- If you are printing only the upper label area (LABEL 1) or only lower label area (LABEL 2), printing ends with this step. Otherwise, you should continue with the following steps below.

When printing in both the upper label area (LABEL 1) and lower label area (LABEL 2)...

7. Rotate the disc 180 degrees and place it back onto the tray.

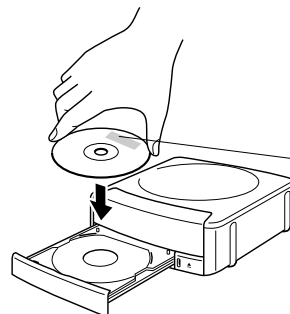

Position the disc so the first printing is located here, and then set the disc onto the tray.

8. Repeat steps 3 and 4 to position the disc.

Note

See "Positioning the Disc on the Tray" on page 75 for more information.

9. Click **Start Printing**.

This starts the second printing.

Important!

- Never disconnect the AC adaptor, power cord, or USB cable while a print operation is in progress. Doing so creates the risk of malfunction.

The disc tray opens automatically after printing is complete. Carefully pull out the tray and remove the disc.

Positioning the Disc on the Tray

Use the positioning guide to adjust the position of the disc on the tray in the following cases.

- When the label of the disc already has logos or other markings
- When performing separate upper block and lower block printings

When the label of the disc already has logos or other markings

Note that you cannot print over a logo. Position the disc so the logo or other markings on the disc label are not inside the shaded area.

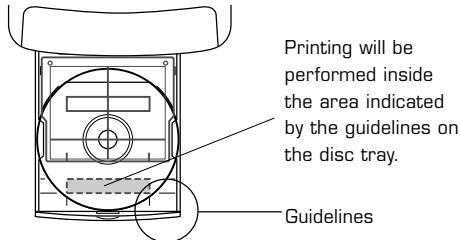

When performing separate upper block and lower block printings

Before performing the second printing, rotate the disc 180 degrees. Next, position the disc so the first printing is within the shaded area.

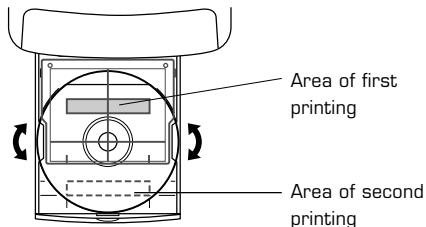

Configuring Advanced Settings

On the main window or the print dialog box, click . This displays a dialog box for making advanced label creation or print settings.

To configure advanced print settings

1. On the main window or Print dialog box, click the  button.
2. Click the **Print** tab.

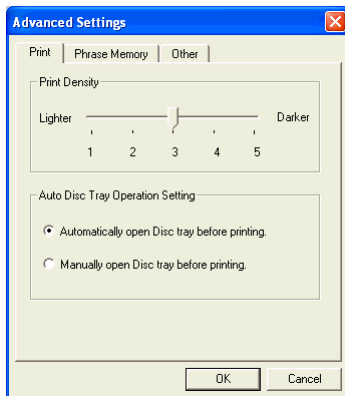

Print Density

Shift the slider left or right to adjust print density when printing is too dark or too light.

Auto Disc Tray Operation Setting

Use this setting to control whether the printer unit's disc tray should be opened automatically or manually before printing is started.

3. After everything is the way you want, click **OK**.

Registering and Deleting a Phrase Memory Entry

You can register frequently used terms and phrases for instant recall whenever you need them. See "Useful Text Input Functions" on pages 43 and 70 for information about using phrase.

1. On the main window or Print dialog box, click the  button.
2. Click the **Phrase Memory** tab.

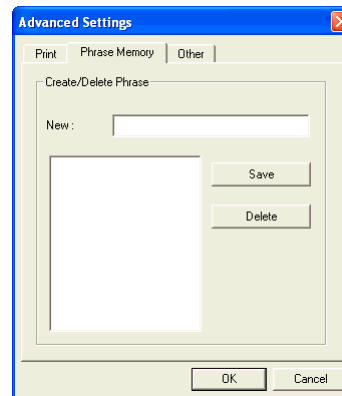

To register a new phrase

Type the phrase you want to register into the text box, and then click **Save**.

To delete a phrase

Click the phrase you want to delete so it is highlighted, and then click **Delete**.

3. After everything is the way you want, click **OK**.

To configure advanced layout settings

Use the following procedure to save the settings of a layout you create, and to control what appears when you click the **Print Pattern** panel and **Text Layout** panel.

1. On the main window or print dialog box, click the  button.
2. Click the **Other** tab.

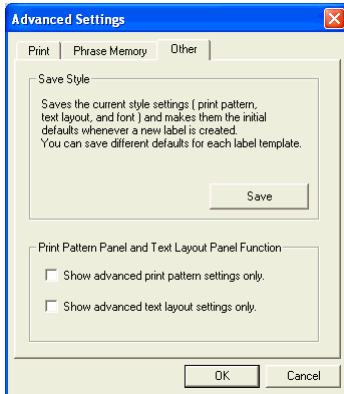

Save Style

Clicking the **Save** button saves the current print pattern, text layout, and font settings and makes the initial default settings.

- The settings you save will be applied the next time you create a label using the same template.
- You can save one setup per label template.

Important!

The **Text Layout** panel (page 48) and font button settings cannot be saved for the Free Text layout and Free Design layout.

Select the check box next to **Show advanced print pattern settings only** if you want the **Advanced Print Pattern Settings** dialog box (page 48) to appear when you click the **Print Pattern** panel. The **Select Print Pattern** dialog box appears when this check box is cleared. Select the check box next to **Show advanced text layout settings only** if you want the **Advanced Text Layout Settings** dialog box (page 49) to appear when you click the **Text Layout** panel. The **Select Text Layout** dialog box appears when this check box is cleared.

3. After everything is the way you want, click **OK**.

Using Help

The online help feature lets you access the following type of information.

- Information about functions and supplementary information
- Software version information
- Connection on the TDK Website

To use Help

1. On the main window, click the  button.
2. Click **Help**.

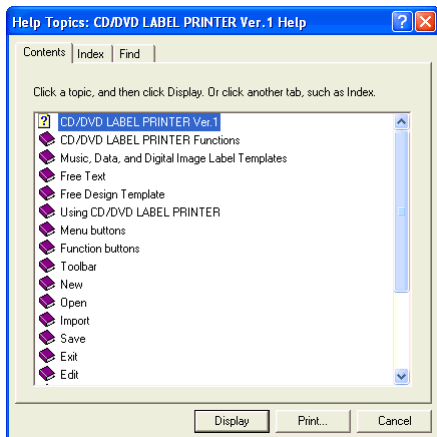

3. Use standard Windows online help procedures to find the information you need.

You can also obtain assistance by accessing the TDK Website. While your computer is connected to the Internet, click  and then click **TDK Website**. This will take you to the TDK Website where you will find the latest news and other information about TDK or USB peripheral products.

Caring for the Printer

A dirty print head can make it impossible to obtain good printing results. Perform the following steps to clean the print head when it becomes dirty.

Important!

- Use only a cotton swab or some other soft material to clean the print head.
- Note that you will not be able to open the disc tray or the front cover unless the power cord, AC adaptor and USB cable are connected to the printer. Open the front cover before disconnecting cables. See page 23 for information about opening the disc tray and front cover, and page 22 for information about disconnecting cables.

1. Press the **Eject** button on the front of the printer or click the  button on the main window.
This causes the disc tray to come out part way.
2. Gently pull out the disc tray as far as it will go.
If there is a disc in the disc tray, remove it.
3. Open the front cover.
If there is an ink ribbon cassette loaded in the printer, remove it.
4. Unplug the USB cable from the PC and printer.
5. Unplug the power cord from the wall outlet, and then unplug the AC adaptor from the printer.

6. Use a cotton swab moistened with alcohol to clean the print head.
You can use a commercially available cassette tape recorder head cleaning kit to clean the print head.

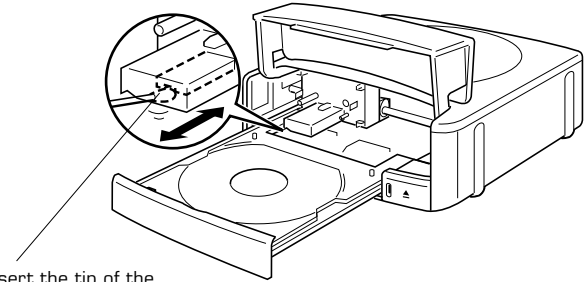

Insert the tip of the cotton swab and slide it lightly back and forth along the depression in the print head.

Cleaning the Printer Exterior

Wipe the exterior of the printer with a cloth moistened with plain water. Wring all excess liquid from the cloth before wiping the printer. Never use benzene, alcohol, thinner, or other volatile agents to clean the printer exterior. Doing so can damage the case.

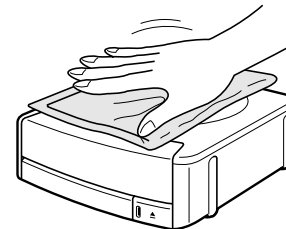

Phrase Library List

The following is a list of the built-in phrase library contents. See page 43 and 70 for information about using phrase.

Phrase Memory

- TEL:
- FAX:
- POST CODE:
- Extension:
- Direct:
- E-mail:
- http://
- Contact:
- Manager:
- Term:
- Issue Date:

Digital Image

- Date Recorded:
- Recorded By:
- Recorded At:
- Image Quality Setting:
 - High:
 - Normal:
 - Economy:

Music

- Big Hit
- Hit Album
- Best Of
- Omnibus
- My Favorites

Troubleshooting

Consult this troubleshooting guide whenever you start to have problems with the printer or application. If you cannot find the solution to your problem below, contact your original retailer.

Symptom	Possible Cause	Recommended Action
● Nothing works.	The software is not installed.	Disconnect the USB cable and re-install the software. Installing the software also installs the driver. After re-installing, connect the USB cable again.
	The USB cable, AC adaptor, or power cord is not connected.	Carefully make all of the required connections (page 21).
	Your PC is not turned on.	Start up your PC.
● The disc tray does not open when the Eject button is pressed.	The USB cable, AC adaptor, or power cord is not connected.	Carefully make all of the required connections (page 21).
	Your PC is not turned on.	Start up your PC.
* If the disc tray does not open when you are trying to remove a disc from the printer, you can use the procedure on page 16 to open the tray manually.		

Symptom	Possible Cause	Recommended Action
<ul style="list-style-type: none"> ● Printing is not clear. ● Printing is poor quality. ● Printing is too light. 	Any of the following can interfere with proper printing. <ul style="list-style-type: none"> • A disc label that is not smooth. • A disc label that has a design or lines printed on it. • A disc label that support ink jet printing only. 	See the separate "Quick Start Guide" sheet for information about recommended media.
	Dirty print head	Clean the print head. (page 79).
	Improper print density	Adjust the print density. (page 76).
● Printing is misaligned.	Improper alignment of the disc in the tray	Use the alignment guide when aligning the disc in the tray (page 72).
● Cannot print.	The ink ribbon is used up.	Replace the ink ribbon cassette with a new one (page 23).
	The driver is not installed correctly.	Disconnect the USB cable and re-install the software. Installing the software also installs the driver. After re-installing, connect the USB cable again.

Symptom	Possible Cause	Recommended Action
● The last part of input data does not print.	Too many characters per line	Use a smaller font size or reduce the number of characters per line.
	Too many lines	Use a smaller font size or reduce the number of lines.
● Cannot import CD-Text.	The music CD you are trying to import from does not have any CD-Text on it.	Type text manually into the label input boxes, or find a Website on the Internet that contains the data you want to include on the label, copy it, and then paste it into the label input boxes.
	Your CD drive does not support reading of CD-Text.	
● Cannot create a data index file.	The specified drive or media where you are trying to save the data is write protected or full.	Remove the write protection or delete data you no longer need to make room from the data index file. Other options include switching to a different drive or different media.

Error Messages

Message	Recommended Action	Page
The label file cannot be imported because it is corrupted or an unsupported format.	Specify a proper label file format.	pages 38 – 42
The text data cannot be imported because it is corrupted or an unsupported format.	Create a new song title list and try again.	page 39
There is still a Disc in the printer. Remove the Disc to quit.	Remove the disc and then quit.	pages 31 and 72
Eject could not be performed because the printer is turned off or it is not connected to the computer. Correct the problem and then try ejecting again.	Make sure the printer is connected correctly to your PC.	page 21
	Make sure the printer is connected correctly to a power source.	
The printer is turned off or it is not connected to the computer.	Make sure the printer is connected correctly to your PC.	page 21
	Make sure the printer is connected correctly to a power source.	

Message	Recommended Action	Page
The printer is turned off or it is not connected to the computer. Check to make sure that the printer model specified by the print settings is correctly connected to the computer. After correcting the problem, try printing again.	Make sure the printer is connected correctly to your PC.	page 21
	Make sure the printer is connected correctly to a power source.	
There is no ink ribbon cassette loaded in the printer. Load an ink ribbon cassette and then try printing again.	Correctly load an ink ribbon cassette into the printer and try printing again.	page 23
The ink ribbon cassette is empty. Replace the ink ribbon cassette and then try again.	Replace the ink ribbon cassette.	page 26
There is not enough ink ribbon cassette for the next printing. Replace the ink ribbon cassette after you finish the current printing.	Replace the ink ribbon cassette before performing the next printing.	page 26
There is no Disc loaded in the printer. Load a Disc and then try printing again.	Make sure that a disc is correctly set on the tray.	pages 31 and 72

Specifications

Printing

Resolution: 200dpi

Approximate Speed: 9.0mm per second (black ink ribbon)

5.1mm per second (silver, red, or blue ink ribbon)

Print System : Thermal transfer

Print Width : Approximately 16mm

Print Length : Approximately 74mm

Actual printing speed depends on printing environment, conditions, etc.

Power Supply

Power Consumption: 13W (Power supplied both through household power plug and USB port.)

Other

Dimensions : 57 (H) × 180 (W) × 186 (D) mm
(2¹/₄"H × 7¹/₁₆"W × 7⁵/₁₆"D)

Weight : Approximately 750g (1.7 lbs)

Operating Temperature : 10°C to 35°C (50°F to 95°F)



TDK Recording Media Europe S.A.

Z.I. Bommelscheuer
P.O. Box 120
L-4902 Bascharage
Grand Duchy of Luxembourg

M00209-A

Free Manuals Download Website

<http://myh66.com>

<http://usermanuals.us>

<http://www.somanuals.com>

<http://www.4manuals.cc>

<http://www.manual-lib.com>

<http://www.404manual.com>

<http://www.luxmanual.com>

<http://aubethermostatmanual.com>

Golf course search by state

<http://golfingnear.com>

Email search by domain

<http://emailbydomain.com>

Auto manuals search

<http://auto.somanuals.com>

TV manuals search

<http://tv.somanuals.com>