

Packing List

Thank you for purchasing the Pocket PC "the Rugged PDA". A list of the items included with this product is given below. Confirm that nothing is missing or damaged.

If anything is missing or damaged, contact the dealer from which you purchased this product.

● Rugged PDA

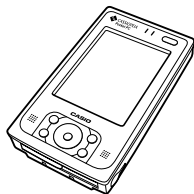

● Battery Pack



● AC Adaptor

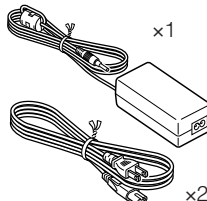

(Two power cords, one for North America and one for Europe.)
However the IT-10M30B provided with only one power cord.

● Stylus

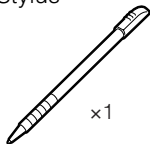

● CD-ROM



● User's Guide



Printed materials other than those listed here may be included with the product also.

Do not dispose of the box and packing materials. Use the box and packing materials for storage and transport.

CASIO® End-User software License Agreement

Please read carefully before using this equipment.

The main CASSIOPEIA unit and the items that come bundled with it include the Software Products (application programs, related documentation, etc.), the rights to which belong to CASIO COMPUTER CO., LTD.

Rights in the "Software Product" are offered only on the condition that you agree to all terms and conditions of this EULA. By installing, copying, downloading, or otherwise using the software product, you agree to be bound by the terms of this EULA.

1. License

The Software Programs, including the Software embedded in the accompanying CD-ROM, the programs embedded in the equipment and the accompanying documentation ("Documentation"), are licensed, **not** sold, to you by CASIO COMPUTER CO., LTD. ("CASIO") for use solely under the terms of this License Agreement.

This non-exclusive license permits you to use the Software on the CD-ROM on a single hardware device at any one time.

Installing the Software onto a network server is a violation of this License Agreement.

2. Copying and Alteration

You may not copy, alter, modify, adapt, translate, or create derivative works based upon the Software or Documentation or any part of them.

3. Transfer

You may transfer all of your rights in the Software under this license to a third party **only** if (a) you transfer the Software CDROM and all Documentation to the third party, (b) you show the third party this End-User Software License Agreement and the third party agrees to abide by its terms and conditions, and (c) you transfer all current and past versions of the Software and Documentation to the third party. By accepting the Software CD-ROM, the third party consents to be legally bound by all terms and conditions of this License Agreement. You may not sublicense, rent, lease, distribute, transmit, make available on a network or transfer the Software or Documentation to a third party except as provided in this paragraph.

4. Reverse Engineering

You may not de-compile, reverse engineer, disassemble, or otherwise reduce the Software Programs to a human readable form.

5. Limitation of Liability

CASIO will in no event be liable for indirect, special, consequential, or incidental damages resulting from any defect, error or omission in the Software or Documentation or from any other events including, but not limited to, any interruption of service, loss of business, loss of profits or good will, legal action or any other consequential damages. You assume all responsibility arising from the use of the Software and/or Documentation. CASIO's liability for damages to you or a third party will in no event exceed the total amount paid by you to obtain the rights to use the Software. **THE SOFTWARE IS FURNISHED AS IS, WITHOUT WARRANTY OF MERCHANTABILITY OR FOR ANY PARTICULAR PURPOSE.** If any of the Software programs is defective the CD-ROM will be replaced without charge if returned to the place of purchase with proof of purchase within thirty days after it is purchased.

6. Termination

This license is effective until terminated. You may terminate this license at any time by informing CASIO in writing of your intention to do so, and destroying the Software CD-ROM and Documentation so that they are unusable.

7. Cancellation

This license shall terminate immediately without any notice from CASIO if you fail to comply with any of its terms.

8. Action Following Termination or Cancellation

Upon termination or cancellation of this license in accordance with paragraph 6 or 7 above, you agree to destroy the Software CD-ROM and the Documentation so that they are no longer usable, and to make no further use of either the Software or the Documentation.

9. Other

- a. This License Agreement shall be governed by and construed in accordance with the laws of Japan.
- b. Any disputes arising under this License Agreement shall be referred to the SOLE AND EXCLUSIVE JURISDICTION OF THE TOKYO DISTRICT COURT IN TOKYO, JAPAN.
- c. The Software and Documentation may not be exported outside the country where they were purchased, either physically or by means of transmission over an international network.

Microsoft® Pocket PC Software 2003 End User License Agreement

- You have acquired a device ("DEVICE") that includes software licensed by CASIO COMPUTER CO., LTD. ("CASIO") from Microsoft Licensing Inc. or its affiliates ("MS"). Those installed software products of MS origin, as well as associated media, printed materials, and "online" or electronic documentation ("SOFTWARE") are protected by international intellectual property laws and treaties. The SOFTWARE is licensed, not sold. All rights reserved.
- IF YOU DO NOT AGREE TO THIS END USER LICENSE AGREEMENT ("EULA"), DO NOT USE THE DEVICE OR COPY THE SOFTWARE. INSTEAD, PROMPTLY CONTACT CASIO FOR INSTRUCTIONS ON RETURN OF THE UNUSED DEVICE(S) FOR A REFUND. **ANY USE OF THE SOFTWARE, INCLUDING BUT NOT LIMITED TO USE ON THE DEVICE, WILL CONSTITUTE YOUR AGREEMENT TO THIS EULA (OR RATIFICATION OF ANY PREVIOUS CONSENT).**
- **GRANT OF SOFTWARE LICENSE.** This EULA grants you the following license:
- SOFTWARE includes software already installed on the DEVICE ("DEVICE Software") and MS software contained on the CD-ROM disk ("Desktop Software").

SYSTEM Software. You may use the DEVICE Software as installed on the DEVICE.

Desktop Software. Desktop Software is included with your DEVICE, and you may install and use the Microsoft® ActiveSync® 3.7 component on one (1) or more computers to exchange information with one (1) or more computing devices that contain a compatible version of the Microsoft® Pocket PC Software 2003 operating system. For other software component(s) contained in the Desktop Software, you may install and use such components only in accordance with the terms of the printed or online end user license agreement(s) provided with such component(s). In the absence of an end user license agreement for particular component(s) of the Desktop Software, you may install and use only one (1) copy of such component(s) on the DEVICE or a single computer with which you use the DEVICE.

Back-up Copy. If Manufacturer has not included a back-up copy of the DEVICE Software with the DEVICE, you may make asingle back-up copy of the DEVICE Software. You may use the back-up copy solely for archival purposes.

Security Update/Digital Rights Management. Content providers are using the digital rights management technology contained in this SOFTWARE ("DRM") to protect the integrity of their content ("Secure Content") so that their intellectual property, including copyright, in such content is not misappropriated. Portions of this SOFTWARE and third party applications such as media players use DRM to play Secure Content ("DRM Software"). If the DRM Software's security has been compromised, owners of Secure Contents ("Secure Content Owners") may request that MS revoke the DRM Software's right to copy, display and/or play Secure Content. Revocation does not alter the DRM Software's ability to play unprotected content. A list of revoked DRM Software is sent to your computer whenever you download a license for Secure Content from the Internet. You therefore agree that MS may, in conjunction with such license, also download revocation lists onto your computer on behalf of Secure Content Owners. MS will not retrieve any personally identifiable information, or any other information, from your computer by downloading such revocation lists. Secure Content Owners may also require you to upgrade some of the DRM components in this Software ("DRM Upgrades") before accessing their content. When you attempt to play such content. MS DRM Software will notify you that a DRM Upgrade is required and then ask for your content before the DRM Upgrade is downloaded. Third party DRM Software may do the same. If you decline the upgrade, you will not be able to access content that requires the DRM Upgrade, however, you will still be able to access unprotected content and Secure Content that does not require the upgrade.

DESCRIPTION OF OTHER RIGHTS AND LIMITATIONS.

- **Speech/Handwriting Recognition.** If the SOFTWARE includes speech and/or handwriting recognition component(s), you should understand that speech and handwriting recognition are inherently statistical processes; that recognition errors are inherent in the processes; that it is your responsibility to provide for handling such errors and to monitor the recognition processes and correct any errors. Neither Manufacturer nor its suppliers shall be liable for any damages arising out of errors in the speech and handwriting recognition processes.
- **Limitations on Reverse Engineering, Decompilation and Disassembly.** You may not reverse engineer, decompile, or disassemble the SOFTWARE, except and only to the extent that such activity is expressly permitted by applicable law notwithstanding this limitation.
- **Single DEVICE.** The DEVICE Software is licensed with the DEVICE as a single integrated product. The DEVICE Software installed in read only memory ("ROM") of the DEVICE may only be used as part of the DEVICE.
- **Single EULA.** The package for the DEVICE may contain multiple versions of this EULA, such as multiple translations and/or multiple media versions (e.g., in the user documentation and in the software). Even if you receive multiple versions of the EULA, you are licensed to use only one (1) copy of the DEVICE Software.
- **Notice Regarding the MPEG-4 Visual Standard.** The SOFTWARE may include MPEG-4 visual decoding technology MPEG LA, L.L.C. requires the following notice.

USE OF THIS SOFTWARE IN ANY MANNER THAT COMPLIES WITH THE MPEG-4 VISUAL STANDARD IS PROHIBITED, EXCEPT FOR USE DIRECTLY RELATED TO (A) DATA OR INFORMATION (i) GENERATED BY AND OBTAINED WITHOUT CHARGE FROM A CONSUMER NOT THEREBY ENGAGED IN A BUSINESS ENTERPRISE, AND (ii) FOR PERSONAL USE ONLY; AND (B) OTHER USES SPECIFICALLY AND SEPARATELY LICENSED BY MPEG LA, L.L.C.

If you have questions regarding this Notice, please contact MPEG LA, L.L.C., 250 Steele Street, Suite 300, Denver, Colorado 80206;

Telephone 303 331.1880; FAX 303 331.1879

- **Rental.** You may not rent or lease the SOFTWARE.
- **LEASED HARDWARE.** In the event that you receive the DEVICE under the terms of a lease from [COMPANY] or [COMPANY'S] third-party representative, the following additional terms shall apply: (i) you may not transfer the SOFTWARE to another user as part of the transfer of the DEVICE, whether or not a permanent transfer of the SOFTWARE with the DEVICE is otherwise allowed in this EULA; (ii) your rights with respect to any SOFTWARE upgrades shall be as determined by the lease you signed for the DEVICE; and (iii) you may not use the SOFTWARE after your lease terminates, unless you purchase the DEVICE from [COMPANY].
- **Software Transfer.** You may permanently transfer all of your rights under this EULA only as part of a sale or transfer of the DEVICE, provided you retain no copies, you transfer all of the SOFTWARE (including all component parts, the media and printed materials, any upgrades or backup copies, this EULA and, if applicable, the Certificate(s) of Authenticity), and the recipient agrees to the terms of this EULA. If the SOFTWARE is an upgrade, any transfer must include all prior versions of the SOFTWARE.
- **Termination.** Without prejudice to any other rights, Manufacturer or MS may terminate this EULA if you fail to comply with the terms and conditions of this EULA. In such event, you must destroy all copies of the SOFTWARE and all of its component parts.

UPGRADES AND RECOVERY MEDIA.

- **DEVICE Software.** If the DEVICE Software is provided by Manufacturer separate from the DEVICE on media such as a ROM chip, CD ROM disk(s) or via web download or other means, and is labeled "For Upgrade Purposes Only" or "For Recovery Purposes Only", you may install one copy of such DEVICE Software onto the DEVICE as a replacement copy for the existing DEVICE Software and use it in accordance with Section 1 of this EULA.
- **Desktop Software.** If any Desktop Software component(s) is provided by Manufacturer separate from the DEVICE on CD ROM disk(s) or via web download or other means, and labeled "For Upgrade Purposes Only" or "For Recovery Purposes Only", you may (i) install and use one copy of such component(s) on the computer(s) you use to exchange data with the DEVICE as a replacement copy for the existing Desktop Software component(s).

COPYRIGHT. All title and intellectual property rights in and to the SOFTWARE (including but not limited to any images, photographs, animations, video, audio, music, text and "applets," incorporated into the SOFTWARE), the accompanying printed materials, and any copies of the SOFTWARE, are owned by MS or its suppliers (including Microsoft Corporation). You may not copy the printed materials accompanying the SOFTWARE. All title and intellectual property rights in and to the content which may be accessed through use of the SOFTWARE is the property of the respective content owner and may be protected by applicable copyright or other intellectual property laws and treaties. This EULA grants you no rights to use such content. All rights not specifically granted under this EULA are reserved by MS and its suppliers (including Microsoft Corporation).

EXPORT RESTRICTIONS. You agree that you will not export or re-export the SOFTWARE to any country, person, or entity subject to U.S. export restrictions. You specifically agree not to export or re-export the SOFTWARE: (i) to any country to which the U.S. has embargoed or restricted the export of goods or services, which as of May 1999 include, but are not necessarily limited to Cuba, Iran, Iraq, Libya, North Korea, Sudan, Syria, and the Federal Republic of Yugoslavia (including Serbia, but not Montenegro), or to any national of any such country, wherever located, who intends to transmit or transport the products back to such country; (ii) to any person or entity who you know or have reason to know will utilize the SOFTWARE or portion thereof in the design, development or production of nuclear, chemical or biological weapons; or (iii) to any person or entity who has been prohibited from participating in U.S. export transactions by any federal agency of the U.S. government.

PRODUCT SUPPORT. Product support for the SOFTWARE is not provided by MS, its parent corporation, Microsoft Corporation, or their affiliates or subsidiaries. For product support, please refer to CASIO support number provided in the documentation for the DEVICE. Should you have any questions concerning this EULA, or if you desire to contact CASIO for any other reason, please refer to the address provided in the documentation for the DEVICE.

NO LIABILITY FOR CERTAIN DAMAGES. EXCEPT AS PROHIBITED BY LAW, MS SHALL HAVE NO LIABILITY FOR ANY INDIRECT, SPECIAL, CONSEQUENTIAL OR INCIDENTAL DAMAGES ARISING FROM OR IN CONNECTION WITH THE USE OR PERFORMANCE OF THE SOFTWARE. THIS LIMITATION SHALL APPLY EVEN IF ANY REMEDY FAILS OF ITS ESSENTIAL PURPOSE.

FOR APPLICABLE LIMITED WARRANTIES AND SPECIAL PROVISIONS PERTAINING TO YOUR PARTICULAR JURISDICTION, PLEASE REFER TO YOUR WARRANTY BOOKLET INCLUDED WITH THIS PACKAGE OR PROVIDED WITH THE SOFTWARE PRINTED MATERIALS.



Safety Precautions

- To use this product safely and correctly, read this User's Guide thoroughly and operate as instructed. After reading this guide, keep it close at hand for easy reference. Please keep all informations for future reference.
- Always observe the warnings and cautions indicated on the product.
- If this Guide is misplaced or damaged so as to be unreadable, you can access "<http://www.casio.co.jp/English/system/>" for the online guide or downloading the guide into your PC.

About the icons

In this Guide various icons are used to highlight safe operations with the product and to prevent injury to the operator and other persons nearby and also to prevent damage to property including the product.

Warning!

Indicates that there is a risk of severe injury if used incorrectly.

Caution!

Indicates that injury or damage may result if used incorrectly.

Icon examples

To bring attention to risks and possible damage, the following icons are used.



The  symbol indicates that it includes some symbol for attracting attention (including warning). In this triangle the actual precautions to be taken (electric shock, in this case) is indicated.



The  symbol indicates a prohibited action. In this symbol the actual prohibited actions (disassembly, in this case) will be indicated.



The  symbol indicates that a restriction. In this symbol the actual restriction (removal of the power plug from an outlet, in this case) is indicated.



Warning!

Handling the Rugged PDA

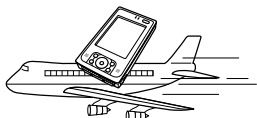

Stop using the Rugged PDA and turn it off in places where its operation is prohibited. The effects of electromagnetic radiation may result in an accident.

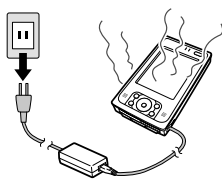

Should the Rugged PDA malfunction, start to emit smoke or a strange odor, or otherwise behave abnormally, immediately shut down the power, remove the battery pack, and unplug the AC adaptor from the power outlet. Continued use creates the danger of fire and electric shock.

Contact your original dealer or authorized CASIO distributor.

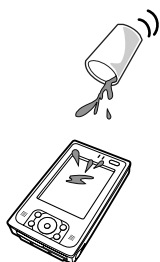

Do not place containers of liquids near the Rugged PDA and do not allow any foreign matter to get into it. Should water or other foreign matter get into the Rugged PDA, immediately shut down the power and unplug the AC adaptor from the power outlet. Continued use creates the danger of shorting, fire and electric shock.

Contact your original dealer or authorized CASIO distributor.



Never bring in the Rugged PDA a bathroom or any other location where the possibility of splashing or high humidity exists. Use of the Rugged PDA in such an area creates the danger of electric shock. Be especially carefully when using the Rugged PDA while rain or snow is falling, or in beach areas.

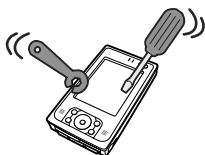

Never try to take the Rugged PDA apart or modify it in any way. Doing so creates the danger of fire and electric shock.

Contact your authorized CASIO distributor for repair and maintenance.

⚠ Warning!

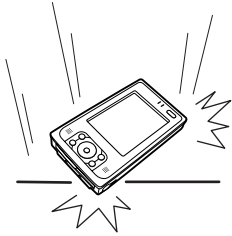

Should you drop the Rugged PDA and damage it, immediately shut down the power and unplug the AC adaptor from the power outlet. Continued use creates the danger of shorting, fire and electric shock.

Attempting to repair the Rugged PDA yourself is extremely dangerous. Contact your authorized CASIO distributor for repair and maintenance.



The liquid inside the LCD is harmful to humans. Never touch it or allow it to get in your mouth.

Should liquid from the LCD panel accidentally get into your mouth immediately wash out your mouth with clean water. If it gets onto your skin, immediately rinse for at least 15 minutes with clean tap water. In either case, consult a physician.

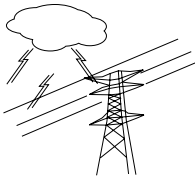

Should lightning strike nearby, stop using the Rugged PDA, and disconnect the modular cable or the power cord from the power outlet. Continued use creates the danger of electric shock or damage.

Power Plug and AC Adaptor



Note

AC cord plug and wall outlet illustrated in this User's Guide show the two-pin plug type. It may not be the same shape of AC cord plug used in your area.

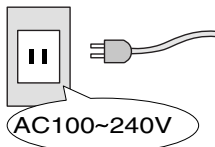

Use only a proper AC electric outlet (100V~240V) when powering the Rugged PDA with the AC adaptor. Use of an outlet with a different voltage from the rating creates the danger of malfunction, fire, and electric shock. Overloading an electric outlet creates the danger of overheating and fire.

⚠ Warning!

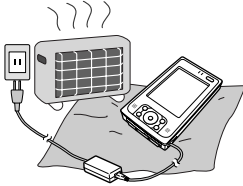

Do not place bedding materials on top of the AC adaptor while it is on or place the Rugged PDA on heated flooring or near other heating apparatus during charging. Doing so might cause it to deform, or result in a fire or malfunction.

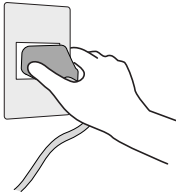

Make sure the power plug and AC adaptor plug are inserted as far as they will go. Loose plugs create the danger of electric shock, overheating, and fire.

Do not use the adaptor if the plug is damaged. Never connect to a power outlet that is loose.

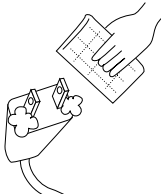

Use a dry cloth to periodically wipe off any dust built up on the prongs of the plug. Humidity can cause poor insulation and create the danger of electric shock and fire if dust stays on the prongs.

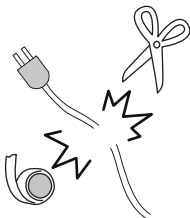

Do not allow the power cord or plug to become damaged, and never try to modify them in any way. Continued use of a damaged power cord can cause deterioration of the insulation, exposure of internal wiring, and shorting, which creates the danger of electric shock and fire.

Contact your authorized CASIO distributor whenever the power cord or plug requires repair or maintenance.

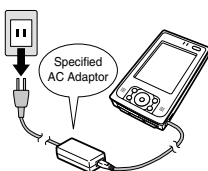

Use only the AC adaptor specified by CASIO for this product. Use of other type of AC adaptor creates the danger of fire.

⚠ Warning!

Battery Pack

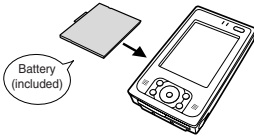

Use only the battery pack that comes with the Rugged PDA. When the battery pack reaches the end of its life, replace it with a new battery pack as specified by CASIO. Other types of the battery pack have different voltage rating and polarity, which creates the danger of fire and bursting of the batteries.

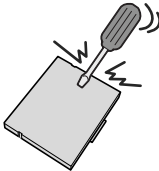

Never try to take the battery pack apart or modify it in any way. Doing so creates the danger of overheating, fire, and bursting of the battery pack.



Never throw the battery pack into fire or otherwise expose it to direct flame. Doing so creates the danger of fire and explosion.



Never allow the positive (+) and negative (-) poles of the battery to become connected by metal. Do not store or transport the battery pack together with metal necklaces, hairpins, or other metal items. Connection of the battery pack poles creates the danger of overheating, fire, and explosion.

When transporting or storing the battery pack, wrap it in plastic to keep the poles away from metal items that might cause a short.



If the amount of time period the battery pack can serve becomes considerably short, stop using it. It may indicate the possibility of a malfunction in the battery pack. Continued charging the battery pack creates the danger of heat emission, explosion, and fire.

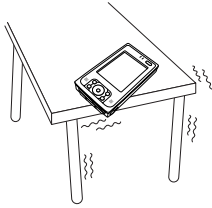

 **Caution!****the Rugged PDA**

Do not place the Rugged PDA on an unstable or uneven surface. Doing so can cause the Rugged PDA to fall, creating the danger of malfunction, fire, and electric shock.

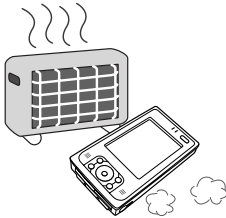

Do not leave the Rugged PDA in the following areas.

- Areas where the Rugged PDA will be subject to large amounts of humidity or dust, or directly exposed to hot or cold air.
- Areas exposed to direct sunlight, in a close motor vehicle, or any other area subject to very high temperatures.

The above conditions can cause malfunction or deformation of the Rugged PDA, which creates the danger of fire.



Keep the Rugged PDA out of the reach of children.

The stylus or other sharp object may cause an unexpected injury.



Avoid use in areas where the brightness around the display is very different from surrounding lighting, or where the sunlight is shining directly on the display. Such the conditions can cause eye fatigue.

⚠ Caution!

Power Cord and Peripherals

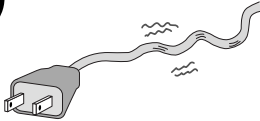

Do not overly bend the power cord, do not allow it to be caught between desks or other furniture, and never place heavy objects on the power cord. Doing so can cause shorting or breaking of the power cord, creating the danger of fire and electric shock.

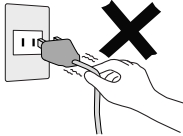

Be sure to grasp the plug when unplugging the power cord from the wall outlet. Pulling on the cord can damage it, break the wiring, or cause short, creating the danger of fire and electric shock.

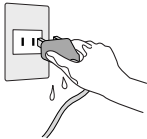

Never touch the plug while your hands are wet. Doing so creates the danger of electric shock. Pulling on the cord can damage it, break the wiring, or cause short, creating the danger of fire and electric shock.



When using headphone, make sure you do not turn up the volume too high. Doing so can cause hearing damage.

The CE marking indicates compliance to applicable European Directives and Norms declared by;



CASIO Europe GmbH

Bornbarch 10, D-22848 Norderstedt, Germany

certify and declare under our sole responsibility that the following equipments:

Product description / Intended use	
EU/EFTA member states intended for use	EU: Austria, Belgium, Germany, Denmark, Spain, Finland, France, United Kingdom, Greece, Ireland, Italy, Luxembourg, The Netherlands, Portugal, Sweden, Czech Republic, Hungary, Poland, Slovenia, Slovakia, Estonia, Latvia, Lithuania, Cyprus, Malta EFTA: Switzerland, Iceland, Norway
Member states with restrictive use	NONE
Manufacturer	CASIO COMPUTER CO., LTD.
Brand	CASIO
Type	IT-10M20, IT-10M20BR

are tested and found to conform with the essential requirements for protection of health and the safety of the user and any other persons and Electromagnetic Compatibility, as included in following standards:

Standard	Issue date
EN60950-1	
EN301 489-1/V1.4.1	2002-08

and are tested and found to conform with the essential radio test suites so that they effectively use the frequency spectrum allocated to terrestrial/space radio communication and orbital resources so to as to avoid harmful interference, as included in following standards:

Standard	Issue date
EN300 328V 1.4.1	2003-04

and therefore comply with the essential requirements and provisions of the Directive 1999/5/EC of the European Parliament and of the council of March 9, 1999 on Radio equipment and Telecommunications Terminal Equipment and the mutual recognition of their conformity and with the provisions of Annex III (Conformity Assessment procedure referred to in article 10).

The technical documentation as required by the Conformity Assessment procedure is kept at the following address:

Company	CASIO Europe GmbH
Address, City	Bornbarch 10, D-22848 Norderstedt
Country	Germany
Phone number	+49(0)40-528-65-0
Fax number	+49(0)40-528-65-424



The information described above dates from January 2004 and may be subjected to future changes.

**GUIDELINES LAID DOWN BY FCC RULES FOR USE OF THIS UNIT IN THE U.S.A.
(not applicable to other areas.)**

NOTICE

This equipment has been tested and found to comply with the limits for a Class B digital device, pursuant to Part 15 of the FCC Rules. These limits are designed to provide reasonable protection against harmful interference in a residential installation. This equipment generates, uses and can radiate radio frequency energy and, if not installed and used in accordance with the instructions, may cause harmful interference to radio communications. However, there is no guarantee that interference will not occur in a particular installation. If this equipment does cause harmful interference to radio or television reception, which can be determined by turning the equipment off and on, the user is encouraged to try to correct the interference by one or more of the following measures:

- Reorient or relocate the receiving antenna.
- Increase the separation between the equipment and receiver.
- Connect the equipment into an outlet on a circuit different from that to which the receiver is connected.
- Consult the dealer or an experienced radio/TV technician for help.

FCC WARNING

Changes or modifications not expressly approved by the party responsible for compliance could void the user's authority to operate the equipment.

Declaration of Conformity

Model Number:	IT-10M20
Trade Name:	CASIO
Responsible party:	CASIO INC.
Address:	570 Mt. Pleasant Avenue, Dover, New Jersey 07801.
Telephone number:	973.361.5400

This device complies with part 15 of the FCC Rules. Operation is subject to the following two conditions: (1) This device may not cause harmful interference, and (2) this device must accept any interference received, including interference that may cause undesired operation.

Industry Canada

“This digital apparatus does not exceed the Class B limits for radio noise emissions from digital apparatus as set out in the interference-causing equipment standard entitled “Digital Apparatus”, ICES-003 of the Department of Communications.”

Industrie Canada

“Cet appareil numérique respecte les limites de bruits radioélectriques applicables aux appareils numériques de Classe B prescrites dans la norme sur le matériel brouilleur : “Appareils Numériques”, NMB-003 édictée par le ministre des Communications.”

Before Using the Rugged PDA

- This product has been designed and manufactured under stringent quality control. Should you suspect the Rugged PDA is defective or malfunctioning, contact your original dealer or authorized distributor. Repair and maintenance are subject to the terms and conditions of the Warranty.

The mis-operation of electronic product may create a risk of injury caused by a fire or electric shock, etc. To avoid the accident, be sure to follow the instructions below.

Follow the cautions

The cautions for the Rugged PDA are described on pages from 5 to 11.

Do not use the Rugged PDA if it does not work correctly

Contact your original dealer or authorized CASIO distributor.

If the Rugged PDA works abnormally

If the Rugged PDA malfunctions, or emits smoke, strange odor or noise, etc., immediately shut down the power, remove the battery pack, and unplug the power cord of the AC adaptor from the power outlet. Contact your original dealer or authorized CASIO distributor.

- CASIO COMPUTER CO., LTD. shall not be held liable for any loss or claims due to the use of this product.
- CASIO COMPUTER CO., LTD. shall not be held liable for any loss or claims (lost profits, interruption of business, corruption or loss of memory data, etc.) by you or any third party due to the use of this product or the inability to use this product for a specific purpose, except as specifically stipulated by law.
- Unauthorized copying of this product or its software is prohibited.

● **Product Application**

- This product is intended for use as a general office computing device.
- CASIO makes no warranties that this product is fault-tolerant.

● **The Rugged PDA**

Power Requirements

- Plug the AC adaptor into a power outlet rated for 100V to 240V AC, 50/60Hz only.
- Do not connect the Rugged PDA to the same outlet of other device that generates electrical noise. Such a device can corrupt data in the Rugged PDA.

The Rugged PDA and AC adaptor may become warm during use.

- This is caused by the CPU operation or the current when the Rugged PDA's battery is charged. This is not malfunction. The heating value changes according to the condition of use.
- When the Rugged PDA or the AC adaptor is warmer than usual, shut down the power, unplug the power cord of the AC adaptor and remove the battery pack. Contact your original dealer or authorized CASIO distributor.

Do not continue operating the Rugged PDA until the battery completely discharges.

- Doing so may result in loss of or damage to your data. Recharge the battery before it discharges completely.

Use the stylus provided.

- When writing on the screen, be sure to use only the stylus provided (or a similar product with a soft tip that is not sharp). Remove any dust or dirt from the screen and the tip of the stylus before writing on the screen. Dirt or dust makes it difficult to write on the screen and may scratch it.

Avoid using the Rugged PDA in the following locations.

- Places where there is a lot of dust.
- Be careful when using the Rugged PDA in locations where the surrounding temperature is extremely hot or cold, such as in a car in direct sunlight, in front of heater.
- Places that are very humid or damp.

Avoid vibration and strong impact.

- Strong vibration or impact may damage the Rugged PDA or important data. It also might damage the LCD screen.

Do not use the Rugged PDA in the rain or places where water may get on it.

- The Rugged PDA is water splash-resistant, however water entering through the gaps around buttons and switches may cause a malfunction.
- If rain or water gets on the Rugged PDA, carefully wipe it with a dry cloth.

● Cautions when carrying the Rugged PDA

- Do not put the Rugged PDA into the hip pocket of your trousers and then sit down. Doing so may break it and cause a malfunction.
- Do not carry the Rugged PDA around in a bag containing hard objects with protrusions. If these objects bump against the Rugged PDA or force is applied from above, the display may be scratched or the Rugged PDA may malfunction.
- Before moving the Rugged PDA, be sure to shut down the power, and make sure that all peripheral devices are disconnected. Then, move the Rugged PDA separately from these devices. Carrying devices around holding them by their connector cables may cause cables to break or devices to malfunction.
- When carrying the Rugged PDA around or when the Rugged PDA is not used, shut down the power, and put it in a protective case, for example, to prevent the display from being scratched.

● Periodically back up data stored on the Rugged PDA

We recommend periodically writing down or transferring data (transfer data with ActiveSync) to a personal computer to create a backup of important data. Data may be lost in the following situations.

- If the battery is completely depleted.
- If incorrect operations are done.
- During repairs to correct a malfunction.

● Options

Non-CASIO options

- Check with each manufacturer for compatibility before using any non-CASIO options with this product.
- CASIO assumes no responsibility for any loss (including but not limited to personal injury, material loss, damage to the Rugged PDA) suffered by you or other arising out of the use of a non-CASIO option.

Use only as directed

- Be sure to connect or disconnect an option only as expressly directed in the documentation that comes with the option.
- Incorrect use of options can cause malfunction and serious damage to the Rugged PDA, which can result in extensive repair work to correct.

● Notes on transfer of ownership of this product

Transferring ownership (selling) this product should be done in compliance with item 1 below.

Accepting ownership (buying) this product should be done in compliance with item 2 below.

1) If you transfer ownership of this product

When transferring ownership of this device to a third party, hand over everything that was included with it (including CD-ROMs, manuals, END-USER LICENSE AGREEMENT, and any backup copies) and completely dispose of all copies of any related software in your possession.

2) If you accept ownership of this product

To accept ownership of this device, you must accept the END-USER LICENSE AGREEMENT for the software. Accepting ownership of this device is considered acceptance of the END-USER LICENSE AGREEMENT.

● Disposal

When it comes time to dispose of the Rugged PDA, do so in accordance with local regulations in your area. Contact your local government authorities for details about proper disposal methods.

When disposing of or transferring ownership of this device, erase all important data and applications in its memory by doing a full reset.

If you do not erase all the data before disposing of or transferring ownership of the device, then someone may recover and use any valuable data in unintended and malicious ways.

● Battery disposal

The product that you have purchased contains a rechargeable battery. The battery is recyclable.

Affix tape to the battery contacts before disposing of the battery. At the end of its useful life, under various state and local laws, it may be illegal to dispose of this battery into the municipal waste stream. Check with your local solid waste officials for details in your area for recycling options or proper disposal.



This mark applies in EU countries only.

● Normal care



Shut down the power and unplug the power cord from the power outlet before cleaning the Rugged PDA. Cleaning the Rugged PDA with the power on creates the danger of electric shock.

- Clean the Rugged PDA by wiping it with a soft, dry cloth. If the Rugged PDA is very dirty, wipe it with a cloth that has been moistened with a weak solution of water and a mild neutral detergent. Wring out all excess of moisture before wiping.
- Thinner, benzene, or other organic agents can cause deformation or discoloration of the Rugged PDA's case, and even malfunction of the Rugged PDA. Never use such agents when cleaning.
- Use only the stylus accompanied with the Rugged PDA (or specified by CASIO) for inputting on the LCD screen. Before using the stylus, remove any dirt from the tip of it and on the screen. Dirt if any may make an input with the stylus more difficult or damage on the screen. Also take care that you do not misplace or lose the stylus.
- Clean the Rugged PDA's LCD screen by wiping it with a soft, clean cloth. Never use water, neutral detergents, or chemically treated cloths to clean the screen. A dirty screen can interfere with response to stylus operations, and smooth movement of the stylus tip. The screen is easily scratched, so take care that you do not apply too much pressure when cleaning it.

● Maintenance



Never remove the Rugged PDA's outer cover or otherwise try to take it apart or modify it in any way. High voltage inside the case creates the danger of electric shock.

In the following instances, immediately shut down the power, remove the battery pack, unplug the power plug from the power outlet, and contact your original dealer or authorized CASIO distributor:

- Damaged power cord or plug
- Liquid leaking from the Rugged PDA
- Unit being dropped
- Damaged unit cover
- Very abnormal function

Never try to make any adjustments except as specifically instructed by this User's Guide. Improper adjustment or modification on the Rugged PDA can permanently damage it and make it impossible to restore normal operation.

Never attempt to repair or modify this product in any way.

Storage

Follow the procedure below to put the Rugged PDA into storage.



If you have used the Rugged PDA for a long period, it will have become dusty. We recommend cleaning it before putting it into storage. You can find information about cleaning in the previous section “Maintenance and Care.”

- 1.** Back up all the data on the Rugged PDA to a computer if it is necessary.
- 2.** Turn off the power, remove all cables and remove the Rugged PDA from the Basic Cradle and AC adaptor.
- 3.** Remove the battery pack and insulate the battery pack terminals with cellophane tape when you store it.
- 4.** Carefully package the Rugged PDA so it does not get dirty or damaged. The box that the Rugged PDA originally came in is a good box into which it can be packed.

Consumables

The following items are consumables.

You will need to inform your original dealer or authorized CASIO distributor of the model number of your unit when purchasing the stylus and battery pack.

● Stylus

- Purchase a new stylus whenever the tip of your stylus becomes damaged.

● Battery Pack

- Long use of the battery pack causes it to deteriorate and lose its ability to recharge. If you feel your battery pack is not providing enough operating time, it may be time to contact your dealer or authorized CASIO distributor about purchasing a new one.

The Rugged PDA includes components that have a limited service life (LCD, etc.). Such components require replacement after very long use.

Contents

Packing List	1
Safety Precautions	5
Before Using the Rugged PDA	15
Maintenance and Care	19
Storage	20
Consumables	20

Chapter 1 Getting Ready

Names of Parts and Their Functions	26
Names of Parts and Their Functions	26
Operating the Rugged PDA	29
Using the Stylus	29
Connecting the Strap	31
Attaching the Screen Protect Sheet	31
Power Supply	33
Battery Pack	33
Attaching and Removing the Battery Pack	34
Charging the Battery Pack	36
Using the AC Adaptor	39
Initial Setup	40
Initial Setup Procedure	40
Various Screen Adjustments	43
When Initial Setup Is Finished	44
Button Operation Settings	64
Connecting to a Computer	65
Compatible Computers	65
Connecting to a Computer	66
Using the CASIO Companion CD	66

Chapter 2 Basic Operations

PIM	68
About Pocket Outlook	68
Calender	70
Contacts	72
Tasks	73
Programs	74
Programs Covered in this Section	74
Adding Programs	75
Pockets Word	75
Pocket Excel	76
Windows Media	77
MSM Messenger	79
Calculator	80
Game	80
Card Backup	81
Pictures	81
File Explorer	82
FLCE	84
Menu	84
Find and Help	85
Setup Overview	87
Personal Tab Settings	87
System Tab Settings	88
Connections Tab Settings	90
Infrared Communication	91
Infrared Communication	91
Transferring Data	91
Bluetooth	94
Wireless LAN	96
Reset and Full Reset	97
Reset	97
Full Reset (Memory Initialization)	98

Chapter 3 Connecting Peripherals

AC Adaptor	102
Connecting the AC Adaptor to the Rugged PDA	102
Connecting the AC Adaptor to the Basic Cradle	102
Specifications	103
Basic Cradle	104
General Guide	104
To Mount the Rugged PDA onto the Basic Cradle	105
To Remove the Rugged PDA from the Basic Cradle	106
Specifications	106
Bridge Satellite Cradle	107
General Guide	107
Using the Bridge Satellite Cradle	109
Linking Multiple Bridge Satellite Cradles	110
Configuring DIP Switch Settings	111
Specifications	112
Dual Battery Charger	113
General Guide	113
Handling Precautions	114
Connecting Dual Battery Chargers Together	114
Charging a Battery Pack	115
Specifications	116
Communication Card Cover	117
Cards	118
Using Compact Flash (CF) Card	118
Loading and Removing a Compact Flash Card	119
Using an SD card or a MultiMedia Card	121

Appendix

Specifications	124
Options List	126

A decorative graphic consisting of two overlapping light gray squares. The front square is positioned lower and to the right, while the back square is higher and to the left. A thick horizontal line passes through the center of the squares, extending across the width of the page.

1

Getting Ready

Names of Parts and Their Functions

Names of Parts and Their Functions

Front

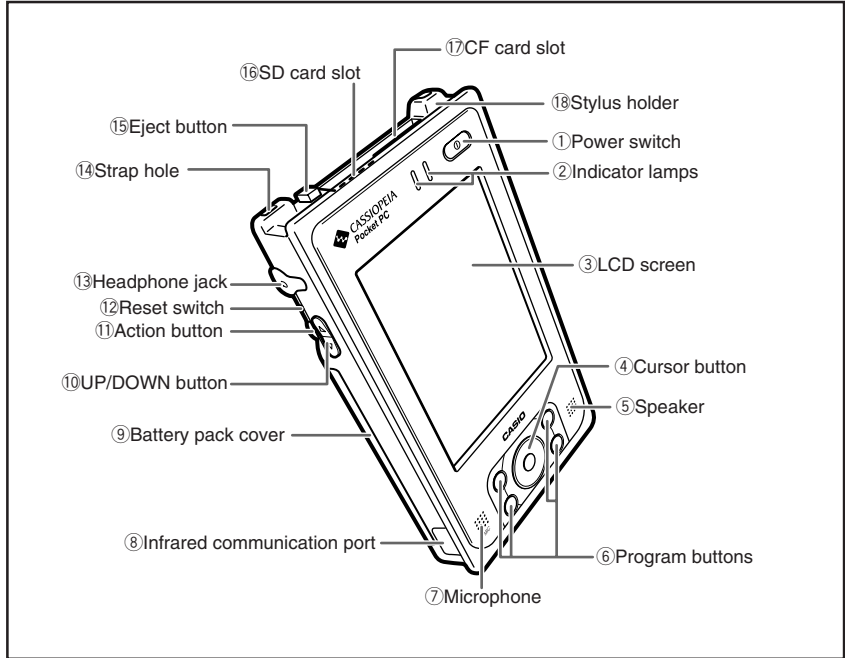

① Power switch (⏻)

Press this key to turn the power on or off. Once the power is turned on, it cannot be turned off for 10 seconds.

② Indicator lamps

Right side: Flashes green when the CF card or SD card is being used. It also flashes red for the alarm and is used as an indicator.







Left side: When the AC adaptor or Basic Cradle is attached, it lights orange when the battery is charging and lights green when the battery is fully charged.

③ LCD screen

The LCD screen displays information and the stylus can be used to enter information or operate the Rugged PDA.

④ Cursor button

Moves the cursor and similar items up, down, left and right on the computer screen. Pressing the center of this button straight down performs the same operation as the Enter key.

- ⑤ Speaker
Sounds such as the alarm come out of the speaker. Sound does not come out of the speaker when earphones or headphones are connected to the headphone jack.
- ⑥ Program buttons
Pushing the program buttons starts the program assigned to that button. The four default settings are, from the upper left, Menu [, Calendar [, Contacts [, and Inbox [].
- ⑦ Microphone (MIC)
Direct your voice here when recording on the Pocket Word or Memo screen.
- ⑧ Infrared communication port
Used for data communications by the IrDA interface. (See page 91)
- ⑨ Battery pack cover
This is the cover for the battery pack. Be sure to keep the battery pack cover locked.
- ⑩ UP/DOWN button ()
Moves the cursor and similar items up and down on the computer screen. (See page 29)
- ⑪ Action button
Operates as the Enter key on the computer. Also, it has several functions when the Cursor button ④ is pressed at the same time. (See page 29)
- ⑫ Reset switch
This switch resets the Rugged PDA, similar to turning off and on the power switch. Reset the Rugged PDA when some abnormality occurs, such as if the buttons or tap operations stop working. (See page 97)
- ⑬ Headphone jack ()
You can attach commercially available earphones or headphones (3.5 mm dia) to the headphone jack.
Remove the rubber cover to use it.
- ⑭ Strap hole
You can attach a commercially available strap.
- ⑮ Eject button
Use the eject button to remove CF (Compact Flash) card.
- ⑯ SD card slot
You can insert either one SD card or one multimedia card.
- ⑰ CF card slot
You can insert a CF (Compact Flash) card.
- ⑱ Stylus holder
The stylus is stored here.

Rear

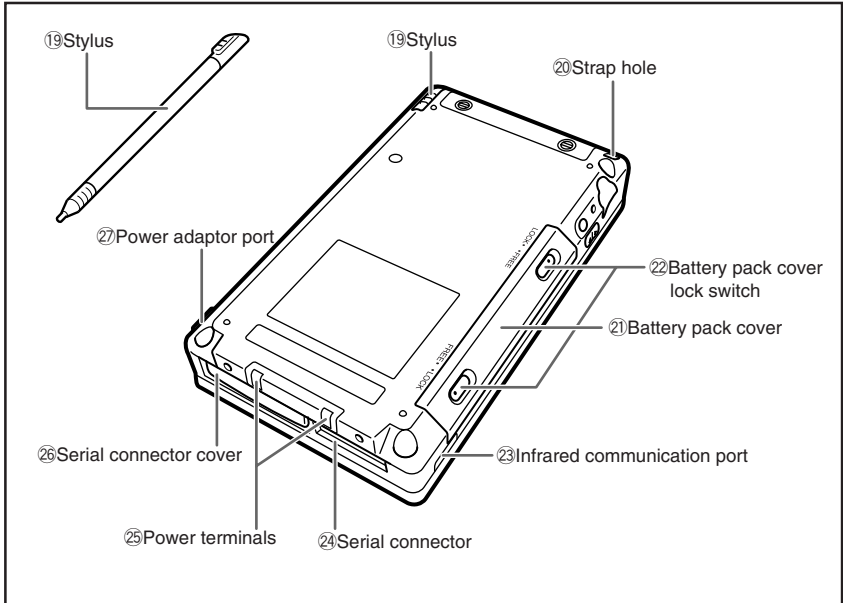

①⑨ Stylus

Use this pen for entering items on the touch panel screen. (See page 29)

②⑩ Strap hole

You can attach a commercially available strap. (See page 31)

②① Battery pack cover

This is the cover for the battery pack.

②② Battery pack cover lock switch

Be sure to keep the lock switch locked. Locking the lock switch prevents the battery pack from falling out.

②③ Infrared communication port

Used for data communications by the IrDA interface. (See page 91)

②④ Serial connector

Connect peripheral device via RS-232/USB interface.
Remove the rubber cover and store it before use.

②⑤ Power terminals

Terminals for supplying power from the Cradle.

②⑥ Serial connector cover

Use this rubber cover when not using the serial I/F.

②⑦ Power adaptor port (⚡-⚡)



Connect the power cord from the AC adaptor to this port.

Remove the rubber cover to use it. (See page 37)

Operating the Rugged PDA

About Buttons on the Side

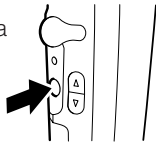
The buttons on the side of the Rugged PDA can be used for the following operations.

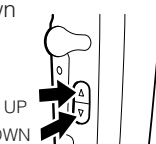
Pressing the Action button	Operates in the same way as the Enter key on a computer. For example, press the Action button to accept the item selected on the menu.	
Pressing the UP/DOWN button	Moves the cursor and similar items up and down on the computer screen. For example, to scroll the screen down, press the  (DOWN) button.	

Using the Stylus

Entering data and most other operations on the Rugged PDA are done with the stylus. The stylus holder is located on the upper left of the back of the Rugged PDA.

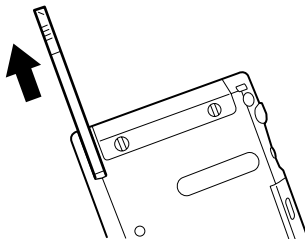

To use the stylus, remove it from the holder and use it when you make an input on the screen.

Important



- Take care to avoid misplacing the stylus. Be sure to put back the stylus into its holder when you are not using it.
- Take care to avoid damaging or breaking the tip of the stylus.
- Never use pen, pencil, or other writing tool to avoid scratches on the screen.
- Keep the tip of the stylus and the Rugged PDA screen clean and free of dirt. Performing stylus operations when the stylus or screen is dirty can damage the screen.
- Use of an optional screen protect sheet is recommended to protect the screen against scratching.

Stylus Operations

The Rugged PDA has hardware buttons that control actions, scroll functions, and a stylus for selecting items and entering information.

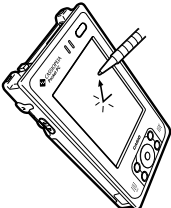
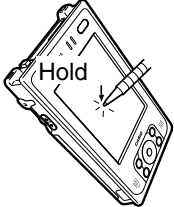
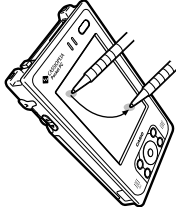
Tap	Touch the screen once with the stylus to open items and select options.	
Tap and hold	Tap and hold the stylus on an item to see a list of actions available for that item. Before a pop-up menu appears, you will see a blue circle of dots to notify you of where on the screen you are pressing. On the pop-up menu that appears, tap the action you want to perform.	
Drag	Hold the stylus on the screen and drag across the screen to select text and images. Drag in a list to select multiple items.	

Connecting the Strap

It is possible to attach a commercially available strap.
See the illustration below.

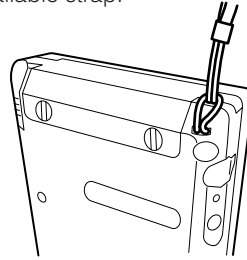

Attaching the Screen Protect Sheet

Follow the procedure below to attach the optional screen protect sheet (HA-C90PS5B).

Important



Do not press strongly on the LCD screen when attaching the screen protect sheet. Doing so may break the screen.

- ① Before you attach the protect sheet to the LCD screen, hold it up to the LCD screen to check the positioning.
- ② Use a lens-cleaning cloth to clean off the LCD screen.
- ③ Pull the clear film (the triangle indicates adhesive surface) in the direction of the arrow about half way off of the protect sheet as shown in Fig. 2. It is easy to peel off if you use the pad of your thumb.

Note: Do not let your fingers touch the adhesive surface when you are doing this.

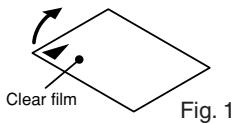

Fig. 1

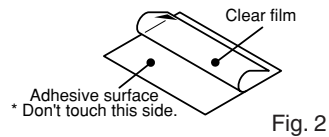

Fig. 2

- ④ With the adhesive side facing down, put the edge of the protect sheet along the edge of the screen frame as shown in Fig. 3.

* Do not put it too far under the edge.



Fig. 3

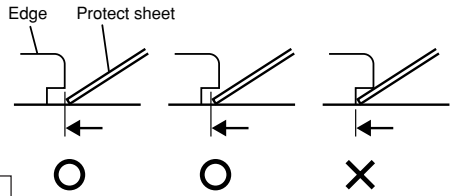

Fig. 4

* Stick about 1 cm of the protect sheet's long side to the frame's edge and then remove the rest of the clear film.

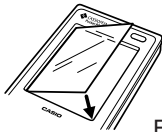

Fig. 5

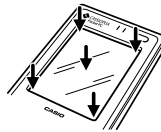

Fig. 6

* If the protect sheet is caught on the edge, press it down with the stylus provided.

* Release the protect sheet and let it fall on its own to stick to the LCD screen as shown in Fig. 5.

* Press the protect sheet down completely.

* Air bubbles caught under the protect sheet will not affect the input operability.

Removing the protect sheet

- ① Stick a piece of tape to the edge on the protect sheet to remove it.

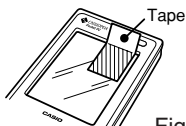

Fig. 7

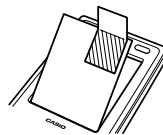

Fig. 8

Power Supply

The Rugged PDA uses an AC adaptor to connect to an outside power source or to recharge the batteries. Attach the battery pack and charge the Rugged PDA's battery until it is full to do the initial setup when using it for the first time or after not using it for a long period, and when the battery is low.

Caution!



Use the battery pack provided or a battery pack specified by the manufacture. Using a battery pack that is not specified by the manufacturer may cause a fire.

Battery Pack

The Rugged PDA operates on a battery pack (lithium-ion battery) as its main battery, and has an internal backup battery to protect its memory when removing the battery pack. Note the following points when using the Rugged PDA.

Important! Read This Information!

- Turn off the Rugged PDA before replacing batteries.
- When the battery discharges beyond a set level, "Main battery remaining capacity low" or "Backup battery remaining capacity low" message appears. If this kind of messages appears, immediately charge either the battery pack or the backup battery depending on the displayed message.
- The "Main battery remaining capacity low" message's title bar can be shown in either blue when the remaining capacity is 30% or less or red when the remaining capacity is 10% or less. Do not replace the battery pack when the "Backup battery remaining capacity low" message appears. Data in the memory may be lost if it is replaced while the message appears on the screen.

Important



If the Rugged PDA with the battery pack being discharged has been left over for a long period, or if the battery pack is replaced incorrectly, data in the memory may be lost accidentally. We recommend backing up data in the memory to other memory device, such as the hard disk of a computer or a memory card. Refer to Help for ActiveSync for information about how to back up data to a computer.

Attaching and Removing the Battery Pack

Attaching

1. Turn off the Rugged PDA, and turn it over. Slide the battery pack cover lock switches with the end of the stylus to FREE (①), and remove the battery pack cover.

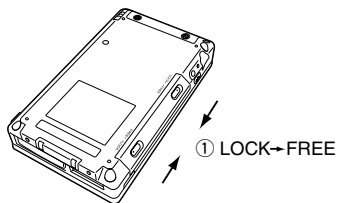

2. Align the battery pack with the slot and insert it into the slot (②). Next, reattach the battery pack cover, and slide the lock switch from FREE to LOCK (③).

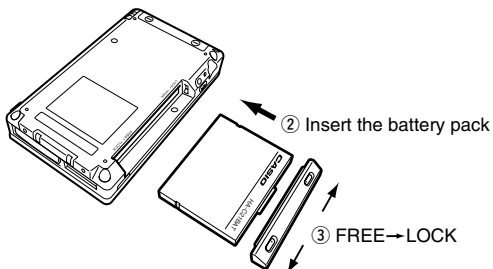

- Be sure to slide the battery pack cover lock switch to the LOCK position. If it is not attached correctly, it may fall out while you are carrying the Rugged PDA and cause a malfunction or injury.

Removing

1. Turn off the Rugged PDA, and turn it over.
2. Slide the battery pack cover lock switches with the end of the stylus to FREE (①), and remove the battery pack cover. Next, remove the battery pack (②).

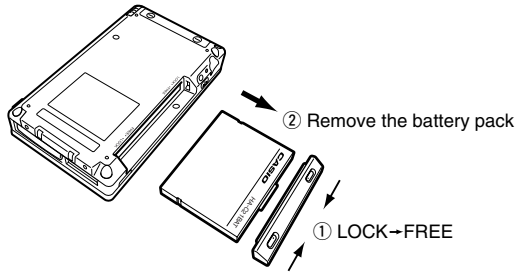

- The internal backup battery can maintain the data in the memory for up to 30 minutes (if the backup battery is full) when the battery pack is removed. If the backup battery is being discharged, the data in the memory may be lost, it is best to attach or remove the battery pack quickly.
- After removing the battery pack, cover the positive and negative terminals with cellophane tape or something similar so they are insulated before storing it.

Charging the Battery Pack

The AC adaptor is used not only to supply power from the AC power outlet but also to charge the battery pack. The battery pack is also charged while the Rugged PDA is in use (power is on) if the AC adaptor (provided) is connected with the battery pack inserted in the Rugged PDA.

A warning label like the one shown below is affixed to the battery pack. This warning label is intended to make you aware of possible dangers that you should always keep in mind whenever handling the battery pack.



⚠ DANGER!

- Never dispose of the battery by incineration and never expose it to heat.
- Never try to take the battery apart or otherwise try to modify it.
- Never allow (+) and (-) battery terminals to become shorted. For details, refer to Hardware Manual.

Important



- Charge the battery in a location where the temperature is between 0°C to 40°C. Charging the battery in an extremely cold location or in direct sunlight causes the battery to deteriorate or to leak fluid.
- If the battery is correctly charged, but the Rugged PDA operates for only a short time, the battery pack may have reached the end of its service life. If this happens, you need a new one to replace with the run-down battery pack.
- The battery pack may become warm while it is being charged or being used. This is normal for the battery pack and is not a malfunction.



Note

The internal backup battery and the battery pack (main battery) have low capacity remained at time of purchase. Fully charge the batteries before using the Rugged PDA for the first time.

Charging the Battery with the AC Adaptor

Pull back the rubber cover from the AC adaptor jack and insert the cable. The battery pack takes about 5 hours (when the Rugged PDA is turned off) to fully charge, and then the left side indicator LED lights green. Under the same conditions, the built in backup battery takes four hours to fully charge.

Warning!



Use the AC adaptor specified by CASIO. Using the AC adaptor that is not specified may cause a fire.

Remove the AC adaptor cable in the following order ① → ② → ③.

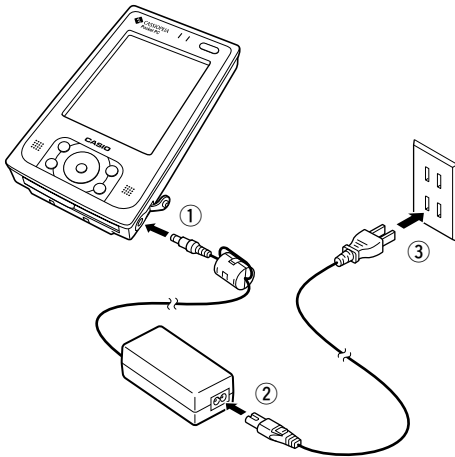

When the battery pack is fully charged, remove the AC adaptor cable and be sure to replace the rubber cover to its original position.

If the left side indicator LED goes out during charging, then the internal protection circuit may have terminated charging. If this happens, remove the AC adaptor and the battery pack from the Rugged PDA and then reattach them again and then start charging again. If this happens frequently it may indicate a malfunction, contact your original dealer or authorized CASIO distributor.

Note

- You can use the Rugged PDA while it is charging. However, the time to charge the Rugged PDA may vary greatly depending on the operations performed on the Rugged PDA (and the surrounding temperature or other factors).
- Charging requires a longer than normal time when doing initial setup after purchase or when charging a newly purchased battery pack for the first time.

Checking Remaining Battery Power

- You can check the remaining power level in the batteries on the "Power" screen. The battery loses power slowly even if the Rugged PDA is not being used. The battery may lose all power if the Rugged PDA is stored for a long period of time. We recommend checking the power level in the battery from time to time.

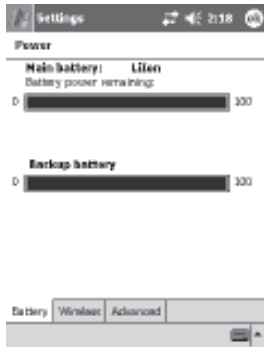

- Tap the  → **Settings** → **System** → **Power** icons, in that order, to display the screen on the left.

Check the remaining battery power while the Rugged PDA is not connected to the AC adaptor.

- When the battery discharges beyond a certain level, an icon(status icon) indicating each battery's remaining capacity appears in the navigation bar.



— Status Icon (See page 45)

Important



Even if you are not using the Rugged PDA you should charge the batteries once every two weeks to prevent them from deteriorating.

Using the AC Adaptor

The battery attached to the Rugged PDA charges when the AC adaptor is attached. Besides charging the battery pack with the AC adaptor, we recommend attaching the AC adaptor to the Rugged PDA when performing one of the following operations that consume power from the battery pack.

- When using the Rugged PDA hooked up to a computer.
- When operating wireless LAN on the Rugged PDA.
- When using the Rugged PDA with a compact flash card (especially when backing up data on the Rugged PDA to the card).

Warning!



Use the AC adaptor specified by CASIO. Using the AC adaptor that is not specified may cause a fire.

Important



- Be careful not to trip on the AC adaptor's power cord.
- Hold the Rugged PDA's power cord by the connector (not the cable) and pull it straight out of the power adaptor jack.
- Dust may collect on the AC adaptor's power cord if it is plugged into an electric power socket for a long time. Clean off the dust periodically.

Initial Setup

Initial Setup Procedure

The first time you use the Rugged PDA, fully charge the battery, then perform the following procedure (if possible connect the AC adaptor to the Rugged PDA during this operation) according to the instructions appeared on the screen to set the initial setup.

Doing Initial Setup

1. Push the power switch to turn the power ON.

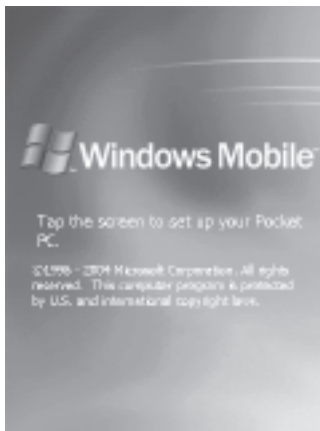

After the startup screen appears, the setup screen appears.

2. Tap on the screen to display the "Align screen" screen.



Use the stylus to tap the center of the (+) in sequence each time it appears.

3. Set the time zone in which the Rugged PDA is used.



4. Initial setup is finished.
Tap the appropriate area on the screen.

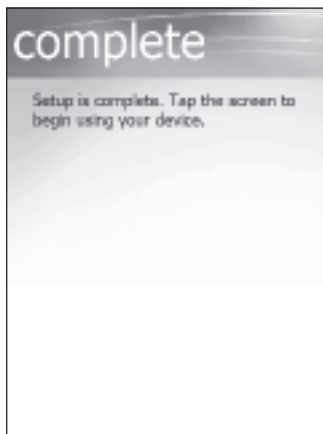

5. The "Today" screen appears, you can start using the Rugged PDA.

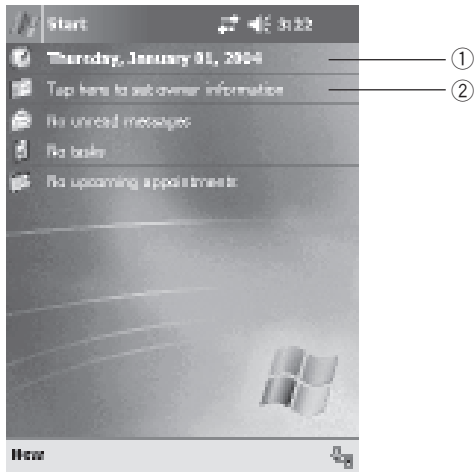

- After initial setup, or after Full reset, set the ①"Clock&Alarms," ②"Owner information" or ③"Password" if necessary.

①Clock&Alarms

On the "Today" screen, tap the date ①, and then use the ▲ and ▼ buttons to input the your **world's time zones, time, and date**.

②Owner information

On the "Today" screen, tap **Tap here to set owner information** (②), and input information about the owner of the Rugged PDA (name, address, phone number, etc.)

③Password

 → **Settings → Personal** tab, tap **Password** and configure the required settings.

Important



If tapping on the screen has no effect, or if the screen is blank, first do a "Full reset (initialize memory)." (See page 98)

Various Screen Adjustments

Do the following adjustments, if the screen is difficult to see or to operate after the initial setup.

Adjusting the Screen Brightness

You can adjust the screen brightness with the Action button and the Cursor button to make the screen easier to see when operating the Rugged PDA in dark locations. Pressing the Action button and the right side together makes the screen brighter, in the same way, pushing the left side makes the screen darker. (See page 88)

Calibrating the Screen

You can calibrate the screen if it is not responsive or if the position you tap and the operation you wish to perform do not match.

Press the power button and the Action button at the same time to display the screen for calibrating the screen.



Use the stylus to tap the center of the target (+ sign). The target moves each time you tap it, the calibration ends after you tap five times.

Screen orientation

You can change the screen to one of three orientations vertical, horizontal (right-handed), horizontal (left-handed) for easier operation.

To do the changes, tap the  and then **Settings**. In the **System** tab, tap **Screen** and follow the on screen instructions.

When Initial Setup Is Finished

This section describes the Rugged PDA's basic operations after initial setup is finished.

Today Screen

When you turn on the Rugged PDA for the first time each day (or after 4 hours of inactivity), you'll see the Today screen. You can also display it by tapping the Today's icon. On the Today screen, you can see at a glance important information for the day.

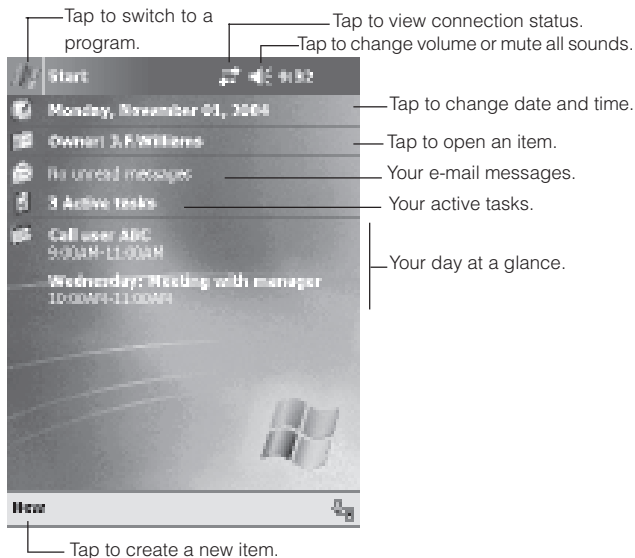

Following are some of the status icons you may see.



Note













To display the Today screen from another screen, tap  in the upper left corner of the display and then tap **Today** at the top of the menu that appears.

Status Icons

Status icons in the navigation bar* or the command bar* indicate the current status of the Rugged PDA. Clicking a status icon displays the applicable setting screen, which you can use to configure settings.

* The bar along the top of the display is the navigation bar, while the bar along the bottom of the display is the command bar.

The table below explains the meaning of each of the status icons.

Status Icon	Meaning
	Specified sound output (screen tap sound, alarm sound, etc.) is turned on. Tapping this icon turns off all the sound outputs.
	All the sound outputs are off. Tapping this icon turns on all the sound outputs.
	Main battery is low.
	Main battery is very low.
	Connecting.
	Synchronization is starting or stopping.
	Synchronization is in progress.
	Notification that an instant message is received.
	Notification that an e-mail message is received.
	The Rugged PDA is connected to the Internet via a cellular phone, etc.
	The Rugged PDA is connected to a computer using the basic cradle and cable, etc.
	Indicates the current Bluetooth on/off status. A red X indicates that Bluetooth is turned off.
	Indicates connection to a network is being established.



If more notification icons need to be displayed than there is room to display them, the Notification icon, , will display. Tap the icon to view all notification icons.

Navigation Bar and Command Bar

The navigation bar is located at the top of the screen. It displays the active program and current time, and allows you to switch to programs and close screens.

Use the command bar at the bottom of the screen to perform tasks in programs. The command bar includes menu names, buttons, and the Input Panel button. To create a new item in the current program, tap **New**. To see the name of a button, tap and hold the stylus on the button. Drag the stylus off the button so that the command is not carried out.

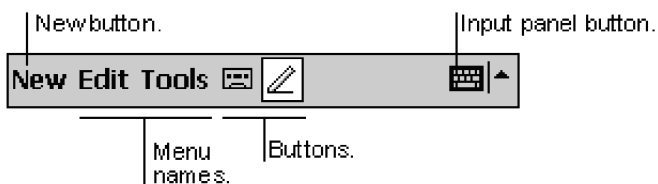
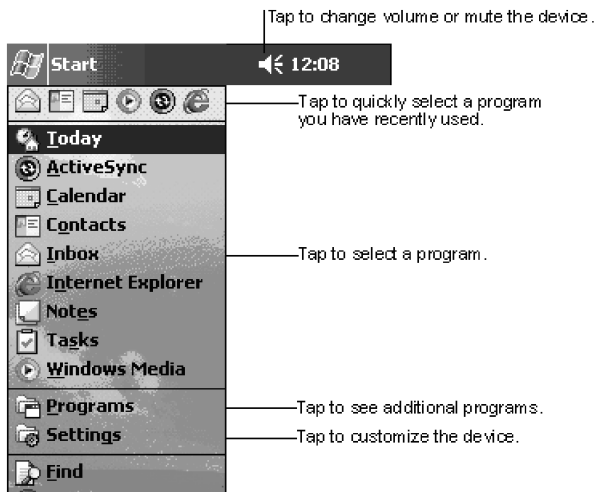

A scroll bar and a scroll button are displayed on the right side (and bottom) of the screen depending on the program. You can display parts of the screen that are hidden by tapping the scroll button or dragging the scroll bar.

Pop-up Menus

With pop-up menus, you can quickly choose an action for an item. For example, you can use the pop-up menu in the contact list to quickly delete a contact, make a copy of a contact, or send an e-mail message to a contact. The actions in the pop-up menu vary from program to program. To access a pop-up menu, tap and hold the stylus on the item name that you want to perform the action on. When the menu appears, lift the stylus, and tap the action you want to perform. Or tap anywhere outside the menu to close the menu without performing an action.

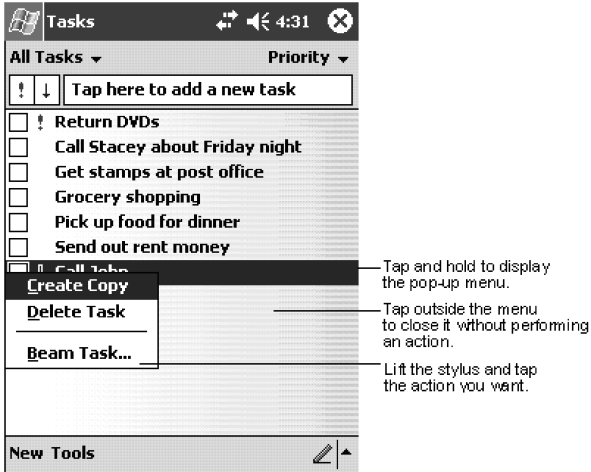

The Rugged PDA reminds you in a variety of ways when you have something to do. For example, if you've set up an appointment in Calendar, a task with a due date in Tasks, or an alarm in Clock, you'll be notified in any of the following ways:

- A message box appears on the screen.
- A sound, which you can specify, is played.
- A light flashes on the Rugged PDA.
- The device vibrates.

To choose reminder types and sounds for the Rugged PDA, tap  and then **Settings**. In the **System** tab, tap **Sounds & Notifications**. The options you choose here apply throughout the Rugged PDA.

Enter Information on the Rugged PDA

You have several options for entering new information:

- Use the input panel to enter typed text, either by using the soft keyboard or other input method.
- Write directly on the screen.
- Draw pictures on the screen.
- Speak into the Rugged PDA microphone to record a message.

Use Microsoft® ActiveSync® to synchronize or copy information from your desktop computer to the Rugged PDA. For more information on ActiveSync, see ActiveSync Help on your desktop computer.

Entering Text Using the Input Panel

Use the input panel to enter information in any program on the Rugged PDA. You can either type using the soft keyboard or write using Letter Recognizer, Block Recognizer, or Transcriber. In either case, the characters appear as typed text on the screen.

To show or hide the input panel, tap the Input Panel button. Tap the arrow next to the Input Panel button to see your choices.

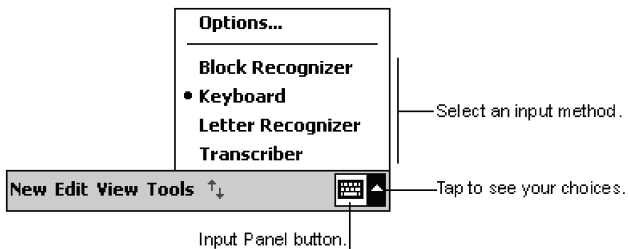

When you use the input panel, the Rugged PDA anticipates the word you are typing or writing and displays it above the input panel. When you tap the displayed word, it is inserted into your text at the insertion point. The more you use the Rugged PDA, the more words it learns to anticipate.

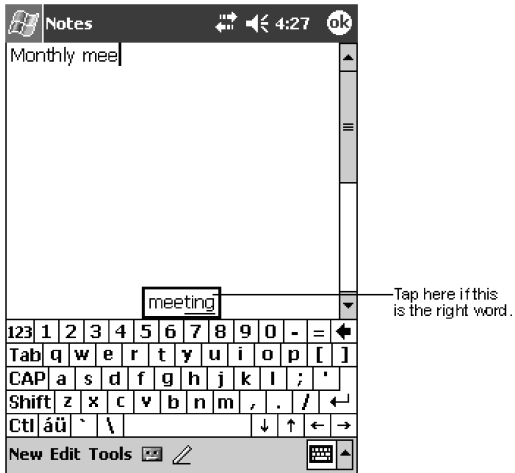

To change word suggestion options, such as the number of words suggested at one time, tap , **Settings**, **System** tab, **Input**, and then the **Word Completion** tab.

Word Completion options:

The Rugged PDA intelligently will attempt to guess at or predict the full word that you're entering by doing a dictionary lookup. When you purchase the Rugged PDA, a default set of words is installed. However, as you begin using the Rugged PDA and begin using words not in that dictionary, they are automatically added to a custom user dictionary that is also searched by the word completion feature. To change how word completion works, select the arrow icon in the SIP chooser area  and tap **Options**. Tap the **Word Completion** tab.



These options allow you to turn word completion on or off, allow you to adjust at what point the full word should be predicted, and whether or not text should be replaced while you type.

To type with the soft keyboard:

1. Tap the arrow next to the Input Panel button and then **Keyboard**.
2. On the soft keyboard that is displayed, tap the keys with your stylus.

The soft keyboard can be used in two modes: large and small. Large mode gives the advantage of larger keys and therefore higher accuracy; small mode gives you special commands like backspace and forward space in the form of on-screen keys rather than stylus-based gestures.

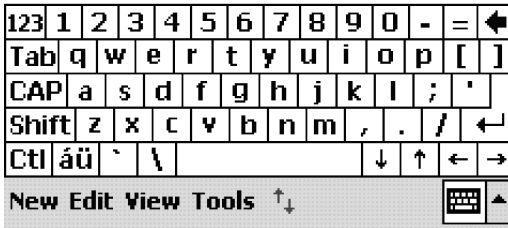

By default, small keyboard with on-screen special commands is provided. This looks much like a standard QWERTY keyboard found on your desktop PC.



Here is the large keyboard without gestures enabled. Notice the absence of numerical keys.

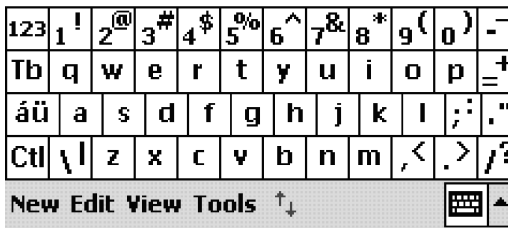

Finally, here is large keyboard with gestures enabled.

1. To space forward, swipe horizontally in a forward direction with stylus on the keyboard.
2. To move backwards, swipe horizontally in a backwards direction with stylus on the keyboard.
3. To carriage return, swipe vertically downwards with stylus on the keyboard.
4. To shift + key, swipe vertically upwards with stylus on the keyboard and hit any key on the keyboard.

To adjust soft keyboard options:

Select the arrow icon in the SIP chooser area  and tap **Options**. Be sure **Keyboard** is selected as the input method.





This screen allows you to make the keyboard small or large and enable gestures with large keyboard as described above.

To use Letter Recognizer:

With Letter Recognizer you can write letters using the stylus just as you would on paper.

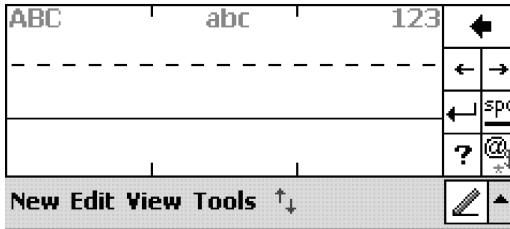
1. Tap the arrow next to the Input Panel button and then **Letter Recognizer**.
2. Write a letter in the box.



As you can see, the screen has been broken into three segments. The first allows you to enter upper-case letters; the second lower-case letters, and the third numbers. This is done to increase accuracy of recognition of your handwriting. Click on the  button to open a panel of symbols and special characters to enter into your text.

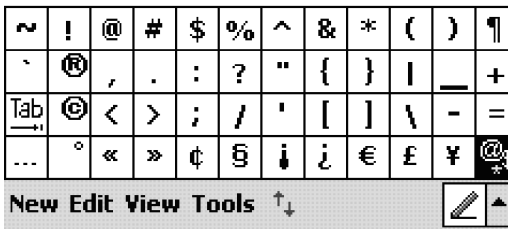

This is the resulting panel. Foreign characters as well as general purpose special characters are included. Tap the  button to return to the Letter Recognizer pane.

When you write a letter, it is converted to typed text that appears on the screen.

To adjust Letter Recognizer options:

Select the arrow icon in the SIP chooser area  and tap **Options**. Be sure **Letter Recognizer** is selected as the input method.



Select the **Options** button.

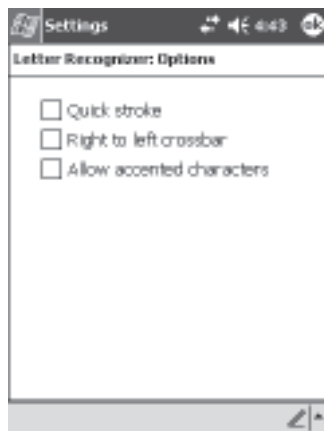

Quick Stroke lets you write all letters using one stroke. While this method will allow you to write faster, it requires learning how to form letters in a new way.

Right to left crossbar should be enabled if you form crossbars on the letters 't', 'f', and '+' from right to left instead of left to right.

Allow accented characters will force the recognizer to predict whether your inputted characters should have accent marks. For example, á.

To use Block Recognizer:

With Block Recognizer you can input character strokes using the stylus that are similar to those used on other devices.

1. Tap the arrow next to the Input Panel button and then **Block Recognizer**.
2. Write a letter in the box.

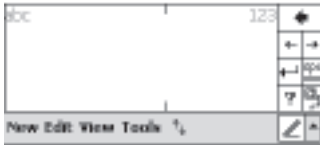

When you write a letter, it is converted to typed text that appears on the screen. Click on the  button to open a panel of symbols and special characters to enter into your text.

To adjust Block Recognizer options

Currently there are no options for this input method.

To use Transcriber:

With Transcriber you can write anywhere on the screen using the stylus just as you would on paper. Unlike Letter Recognizer and Block Recognizer, you can write a sentence or more of information. Then, pause and let Transcriber change the written characters to typed characters.

1. Tap the arrow next to the Input Panel button and then **Transcriber**.
2. Write anywhere on the screen.

For specific instructions on using Transcriber, with Transcriber open, tap the question mark in the lower right hand corner of the screen.

To select typed text

If you want to edit or format typed text, you must select it first.

- Drag the stylus across the text you want to select.

You can cut, copy, and paste text by tapping and holding the selected words and then tapping an editing command on the pop-up menu, or by tapping the command on the **Edit** menu.

Entering a date in an application

Many applications ask you for a date as input, such as "September 14, 1981". All the standard Rugged PDA applications use the same form to assist in this process.

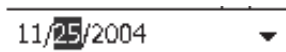

First, click on the arrow to the right of the date field.



Next, select the date by moving among months using the arrows in the upper left- and right-hand corners. You can always select the current day by clicking

Today: ...

Writing on the Screen

In any program that accepts writing, such as the Notes program, and in the **Notes** tab in Calendar, Contacts, and Tasks, you can use your stylus to write directly on the screen. Write the way you do on paper. You can edit and format what you've written and convert the information to text at a later time.

To write on the screen:

- Tap the Pen button to switch to writing mode. This action displays lines on the screen to help you write.

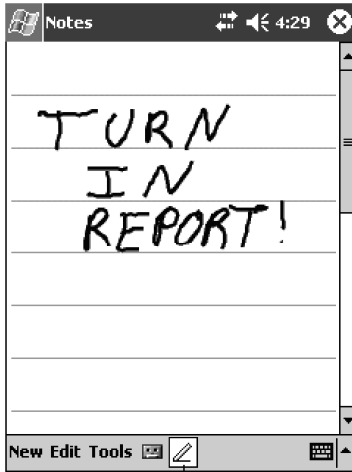

Tap the Pen button and use your stylus like a pen.



Some programs that accept writing may not have the Pen button. See the documentation for that program to find out how to switch to writing mode.

To select writing:

If you want to edit or format writing, you must select it first.

1. Tap and hold the stylus next to the text you want to select until the insertion point appears.
2. Without lifting, drag the stylus across the text you want to select.

If you accidentally write on the screen, tap **Tools**, then **Undo** and try again. You can also select text by tapping the Pen button to deselect it and then dragging the stylus across the screen.

You can cut, copy, and paste written text in the same way you work with typed text: tap and hold the selected words and then tap an editing command on the pop-up menu, or tap the command on the **Edit** menu.

To convert writing to text:

- Tap **Tools** and then **Recognize**.

If you want to convert only certain words, select them before tapping **Recognize** on the **Tools** menu (or tap and hold the selected words and then tap **Recognize** on the pop-up menu). If a word is not recognized, it is left as writing.

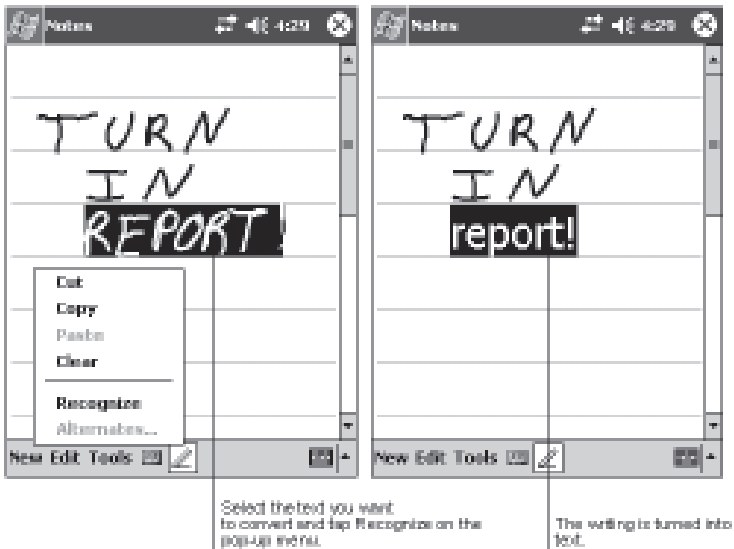

If the conversion is incorrect, you can select different words from a list of alternates or return to the original writing. To do so, tap and hold the incorrect word (tap one word at a time). On the pop-up menu, tap **Alternates**. A menu with a list of alternate words appears. Tap the word you want to use, or tap the writing at the top of the menu to return to the original writing.

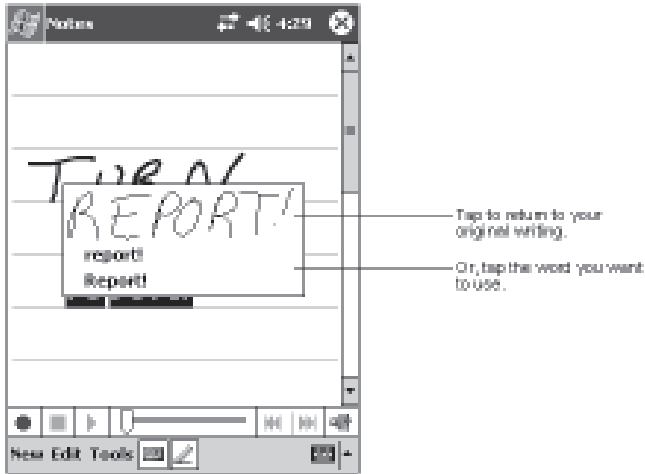

Tips for getting good recognition:

- Write neatly.
- Write on the lines and draw descenders below the line. Write the cross of the "t" and apostrophes below the top line so that they are not confused with the word above. Write periods and commas above the line.
- For better recognition, try increasing the zoom level to 300% using the **Tools** menu.
Write the letters of a word closely and leave big gaps between words so that the device can easily tell where words begin and end.
- Hyphenated words, foreign words that use special characters such as accents, and some punctuation cannot be converted.
- If you add writing to a word to change it (such as changing a "3" to an "8") after you attempt to recognize the word, the writing you add will not be included if you attempt to recognize the writing again.

Drawing on the Screen

You can draw on the screen in the same way that you write on the screen. The difference between writing and drawing on the screen is how you select items and how they can be edited. For example, selected drawings can be resized, while writing cannot.

To create a drawing:

- Cross three ruled lines on your first stroke. A drawing box appears. Subsequent strokes in or touching the drawing box become part of the drawing. Drawings that do not cross three ruled lines will be treated as writing.

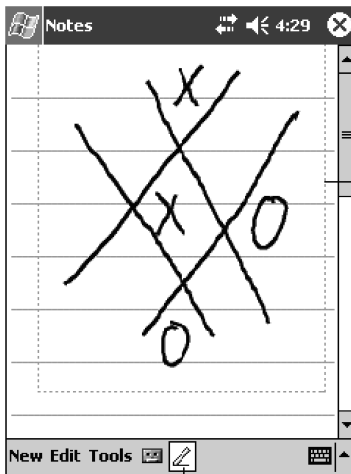

The drawing box indicates the boundaries of the drawing.

Pen button.



You may want to change the zoom level so that you can more easily work on or view your drawing. Tap **Tools** and then select a zoom level.

To select a drawing:

If you want to edit or format a drawing, you must select it first.

- Tap and hold the stylus on the drawing until the selection handle appears. To select multiple drawings, deselect the Pen button and then drag to select the drawings you want.

You can cut, copy, and paste selected drawings by tapping and holding the selected drawing and then tapping an editing command on the pop-up menu, or by tapping the command on the **Edit** menu. To resize a drawing, make sure the Pen button is not selected, and drag a selection handle.

Support for Clip-on Keyboards

The Rugged PDA works to make your computing session more productive when you've installed a snap-on keyboard on the Rugged PDA. Not only does entering text become much faster with a physical keyboard, but a large number of standard keyboard shortcut commands (like CTRL+C, copy; CTRL+Z, undo; CTRL+V, paste; etc.) are just a few easy clicks away. Additionally, most the Rugged PDA applications built for the latest operating system now support keyboard mnemonics, meaning menu items are accessible without ever needing to use the stylus on the screen.

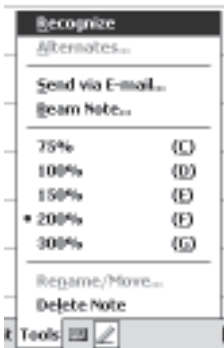

Consider the above pop-up menu from the Notes application. As you can see, by merely tapping the "R" key on the keyboard, any selected text will be recognized. No need to use the stylus! Keyboard support will allow you to keep one hand free to perform other tasks.

Recording a Message

In any program where you can write or draw on the screen, you can also quickly capture thoughts, reminders, and phone numbers by recording a message. In Calendar, Tasks, and Contacts, you can include a recording in the **Notes** tab. In the Notes program, you can either create a stand-alone recording or include a recording in a written note. If you want to include the recording in a note, open the note first. In the Inbox program, you can add a recording to an e-mail message.

To create a recording:

- 1.** Hold your device's microphone near your mouth or other source of sound.
- 2.** Press and hold the Record hardware button on your device until you hear a beep.
- 3.** While holding down the Record button, make your recording.
- 4.** To stop recording, release the Record button. Two beeps will sound. The new recording appears in the note list or as an embedded icon.



You can also make a recording by tapping the **Record** button on the Recording toolbar.

To play a recording, tap it in the list or tap its icon in the note.

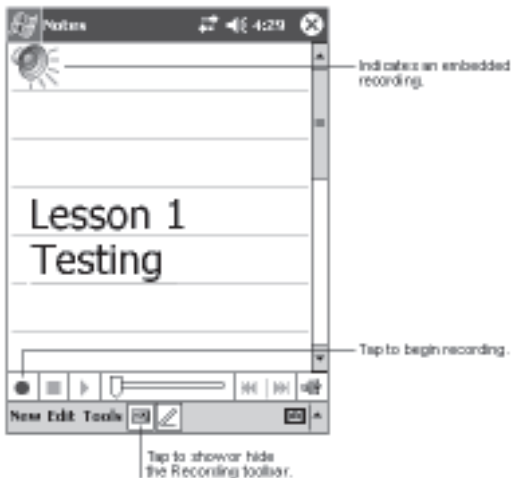

Using My Text

When using Inbox or MSN Messenger, use My Text to quickly insert preset or frequently used messages into the text entry area. To insert a message, tap **My Text** and tap a message.



Note

You can add text after inserting a My Text message before sending it.

To edit a My Text message, in the **Tools** menu, tap **Edit** and then tap **My Text Messages**.



Select the message you wish to edit and make desired changes. Click **ok** to save changes.

Button Operation Settings

Pushing the Program button on the front of the Rugged PDA while it is turned off automatically turns the power on. You can use the "Program Button" to set whether or not pushing the Program button turns on the power. Using the Program button to disable the power on operation can be used to prevent the power from coming on if the Program button is accidentally pressed when the Rugged PDA is in your bag or pocket.

Tap  → **Settings** → **Personal** → **Program Button** then follow the on screen instructions to do the operations.



Note

On the "Program Button" screen, tap **OK** to change the settings, then turn off the Rugged PDA and then on again. This enables the settings.

Connecting to a Computer

Connecting to a computer allows you to share data with the computer, transfer files to and from the computer and back up files to the computer.

Compatible Computers

Computers must meet the following minimum conditions to connect to and exchange data with the Rugged PDA. The following conditions describe the operating environment necessary to use ActiveSync (the computer program that exchanges data between the Rugged PDA and the computer), which is included on the Companion CD provided with the Rugged PDA.

Minimum operating system requirements

- Microsoft® Windows® XP, Windows® 2000, Windows® Millennium Edition, Microsoft® Windows® 98, Windows® NT
- Desktop or laptop computer with Microsoft® Outlook 98 or later able to run Inbox, Calendar, Contacts, Tasks and Notes at the same time.
- Microsoft® Internet Explorer 4.01 Service Pack 1 or later version
- 12 to 65 MB of available hard disk space (actual requirements vary depending on system configuration and selected functions)
- USB port/RS-232C port (Windows 98, Windows 2000, Windows Me or Windows XP only)
- Infrared communication port if using infrared connection
- CD-ROM drive
- 256 color VGA graphics card or compatible video graphics adapter
- Keyboard
- Microsoft Mouse or compatible pointing device

Windows XP, Windows 2000, Windows Me, Windows 98, Windows NT options

- Audio card/speakers for audio
- Microsoft® Office 97, Microsoft® Office 2000 or Microsoft Office XP
- Modem for remote synchronization
- Ethernet LAN connection for remote synchronization



- ActiveSync may not be compatible with all types of computers.
- Refer to Help for ActiveSync for information about how to use the infrared communication port to connect the Rugged PDA with a computer.

Connecting to a Computer

Do not connect the Rugged PDA to the computer before installing ActiveSync. The Rugged PDA and the computer can be connected in the following way.

- When connecting via the Basic Cradle or Bridge Satellite Cradle, connect the Basic Cradle or Bridge Satellite Cradle to the USB port or RS-232C port on the computer, and then put the Rugged PDA in the optional cradle. Leaving the Rugged PDA connected to the computer via the Basic Cradle or Bridge Satellite Cradle makes it easy to connect the Rugged PDA to the computer whenever it is necessary.



Note

When connecting the Rugged PDA to the computer, tap  → **ActiveSync** → **Tools** → **Options**, in that order to check the connection to the computer. For more information refer to Help for the Rugged PDA.

Using the CASIO Companion CD

The Companion CD-ROM contains software.

Put the CD-ROM into the CD drive of the computer and it will start automatically and display a menu. From the menu screen, you can install the application or look at the various documents.

Follow the procedure below to access information on the Companion CD-ROM.

Important



To use the Companion CD-ROM, you must agree to the **END-USER LICENSE AGREEMENT**. Read the **END-USER LICENSE AGREEMENT** and agree with it before using the Companion CD-ROM.

You need to install Active Sync 3.7 to the computer before you can connect the Rugged PDA to the computer and exchange data.



2

Basic Operations

PIM

The letters "PIM" stand for "Personal Information Manager," which is a program for controlling personal information. The Rugged PDA comes with Microsoft Pocket Outlook (Pocket Outlook) built in. Pocket Outlook is the pocket version of Microsoft Outlook, which is used as the PIM on many of today's personal computers. "Pocket Outlook" is a general term that encompasses the five programs of the Rugged PDA: Calendar, Contacts, Tasks, Notes, and Inbox.



The PC version of Outlook includes the following functions: Calendar, Contacts, Tasks, Notes, Mail, and Outlook Today (which corresponds to "Today" on the Rugged PDA. Your Rugged PDA's Pocket Outlook is designed to sync with the PC version of Outlook.

About Pocket Outlook

"Pocket Outlook" is a general term that encompasses the five programs of the Rugged PDA: Calendar, Contacts, Tasks, Notes, and Inbox. It provides the programs described below.



Calendar This program helps you manage your schedule. Appointments and meetings in Calendar can be viewed using a variety of different formats, and you can set alarms to notify you of upcoming appointment times.



Contacts Use Contacts to store and manage the names, addresses, phone numbers, and e-mail addresses of friends, co-workers, customers, etc.



Tasks Tasks helps you manage jobs you need to perform.



Notes Notes is a program that lets you easily jot down or record voice memos of your ideas.



Inbox This program provides you with the means to send and receive mail, and to manage your e-mail messages.

Syncing with a PC

The Rugged PDA can be connected to a PC for syncing the program contents of the Rugged PDA Pocket Outlook with Outlook or Exchange running on the PC. This data can also be directly synced with an Exchange server.

Notification Settings

The following settings can be used to set up the Rugged PDA to notify you of upcoming tasks and appointments.

- Message box display
- Alarm with selectable alarm sound
- Flashing red indicator

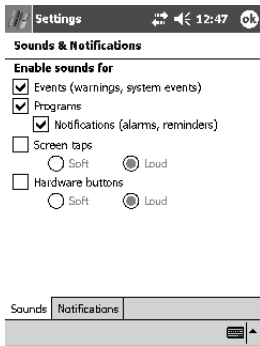





Sounds



Notifications

Calendar

Calendar is a program that helps you manage your schedule. Appointments and meetings in Calendar can be viewed using a variety of different formats, and you can set alarms to notify you of upcoming appointment times. Command bar buttons are used to select the Calendar view you want.

-  Agenda View
-  Day View
-  Week View
-  Month View
-  Year View

Agenda View / Day View

Agenda View and Day View both show the appointments for a specific day. Agenda View can be used to view a list of appointments only, while Day View arranges appointments in a timetable.



Tap go to Today.

Tap go to Display or edit the appointment details.

Tap go to create a new appointment.

Week View

Week View shows appointments for a full week.

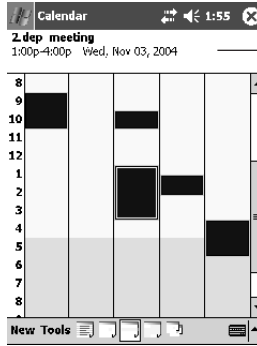
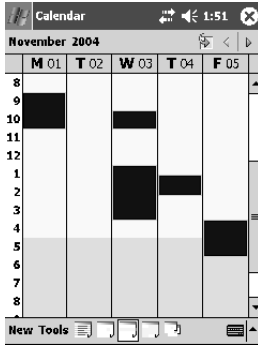

The details of the appointment you tap appear here.



Month View / Year View

Month View shows a full month calendar, while Year View shows calendars for a full year. The Month View also shows whether or not you have appointments scheduled on each day.

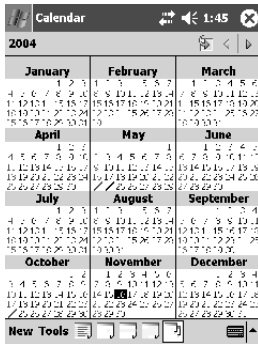

Indicates a morning (AM) appointment.

Indicates an afternoon (PM) appointment.

Indicates an all-day appointment.

Contacts

Use Contacts to store and manage the names, addresses, phone numbers, and e-mail addresses of friends, co-workers, customers, etc.

The Contacts screen lists the names and phone numbers of the entries, as shown below.

Each line of the list represents one record of "Contacts data."

Typing characters here immediately recalls the names that contain the characters.

Tap here to display a list of categories (company, personal, etc.), which you can use to select the one you want.

Tapping and holding here displays a pop-up menu of data handling commands.

Tap here to create a new Contacts record.

Tap here to change the sort order (name order, company order) of the list.

Tap here to select options, etc.

The far right characters ("w," "f," "m," etc.) indicate the contact information (phone number, etc.) that is currently displayed. You can specify the contact information that should appear in this list by tapping here and selecting the information you want from the list that appears.

The screenshot shows the Contacts application interface. At the top, there is a header bar with the title "Contacts" and a search icon. Below the header, there is a "Find a name" search bar. The main area displays a list of contacts with columns for name, phone number, and a small icon. A pop-up menu is visible over the list, showing options like "Beam Contact..." and "Delete Contact". At the bottom, there is a "New View Tools" bar with a plus icon and a scroll indicator.

#	ab	cde	fgh	ijk	lmn	opq	rst	uvw	xyz
Bloome, Dolna	(425)	4356	7688	w					
Debedson, Jo...	(425)	6675	4355	f					
Dohne, Ann	(425)	8901	6789	w					
Kerry, John	(425)	080	2133	2769	m				
Renschist, Will...	(425)	5688	3289	w					
Thompson, D	(425)	3452	8543	w					

Tasks

Tasks lets you keep track of jobs and tasks you need to do. The list shown below appears first whenever you start up Tasks.

Click here to select the category ("Pending," "Completed," etc.) of the tasks you want to display.

Completed tasks can be indicated with a check mark.

This symbol indicates priority.

----- High ----- Low

Tap here to create a new Tasks record.

Tap here to select the input bar, options, etc.

You can use this menu to sort the displayed tasks list by "Priority," "Due Date," etc. (A task is red if its due date is already past.)

Tapping and holding here displays a pop-up menu of data handling commands.

Tap here to toggle display of the input panel on and off.

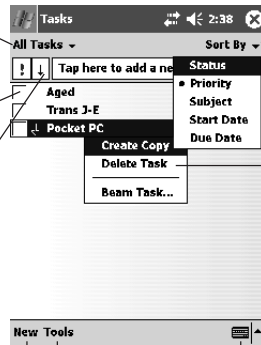

Programs

Programs Covered in this Section

In addition to Inbox and other programs that let you use the Internet, and PIM programs and Calendar, the Rugged PDA also comes bundled with the programs described below.

Pocket Word

This is the pocket version of Microsoft Word word processing program.

Pocket Excel

This is the pocket version of the Microsoft Excel spreadsheet program.

Windows Media

This is a program for playing back MP3 and Windows Media Audio music files. It can also play back Windows Media Video format files.

MSN Messenger

This is an instant messaging program.

Calculator

The program can be used to operate nine-digit calculator.

Games

The Rugged PDA comes with two games: Solitaire and Jawbreaker.

Card Backup

This program lets you back up the Rugged PDA data to a memory card. Backed up data can be restored when you need it.

File Explorer

The program provides you with a variety of different file management tools.

FLCE

This program can be used to transfer specific files to a specific folder.

Menu

This program makes it possible to start up programs and open files by tapping buttons on the screen.

Pictures

This application is for browsing images recorded with a digital camera.

Find and Help

This program lets you find character strings in registered data. Help provides you with useful advice about basic operations.

Adding Programs

The Rugged PDA comes with a built-in Microsoft Windows CE operating system (OS). You can install programs that are compatible with Windows CE. Note that the Rugged PDA must be connected to a PC in order to add programs.

- For information about connecting the Rugged PDA to a PC, see "Connecting to a Computer" on page 65.
- In order to add programs to the Rugged PDA, the PC connected to it must have ActiveSync installed. For information about using ActiveSync, see ActiveSync help.
- Note that CASIO does not provide any support for commercially available programs, etc. Contact the developer of the program or your retailer for support.

Pocket Word

With Pocket Word, you can store typed characters, drawings made with the stylus, and sounds within the same file. Other features include a variety of styles and attributes for text and graphics, find and replace capabilities, etc. You can transfer word and text files from your PC and open them in Pocket Word, and also transfer Pocket Word files to your PC and open them in Word.



Note

Only files in the "My Documents" folder in the Rugged PDA main memory or a "My Documents" folder on a memory card can be opened from Pocket Word. Files in folders that are not inside of the "My Documents" folder do not appear in the file list and so they cannot be opened. (See "Accessing Files on a Memory Card" on page 119 for more information.)

Four Pocket Word Modes

Pocket Word has the four modes described below. You can switch between modes as required to input text into a document.

- Typing Mode Use this mode to input and edit text using the input panel. In this mode, you can also use a variety of text styles and attributes, including bold, italic, text color, numbering and bullets, etc.
- Writing Mode Use this mode when you want to handwrite text and figures on the screen with the stylus. This mode comes in handy when jotting down a quick memo. As with input panel input, you can edit text later if you want, change the thickness and color of lines, etc.
- Drawing Mode This mode is for freehand drawing of figures on the screen with the stylus.
When drawing, you can specify line color and thickness, and the fill color. You can change your specifications after the drawing is complete, and also move or reshape figures.
- Recording Mode Use this mode to embed an audio recording in a document.

Pocket Excel

Pocket Excel is a spreadsheet program that lets you perform basic calculations, high-level function calculations, and arrange data in tabular form. Use it to keep track of your traveling and other expenses during business trips. Or create a database of product data you can take along anywhere. The range of possible uses for Pocket Excel is virtually unlimited. Data can be exchanged between Pocket Excel and the PC version of Excel.



- A file created with Pocket Excel is called a "book."
- Only files in the "My Documents" folder in the Rugged PDA main memory or a "My Documents" folder on a memory card can be opened from Pocket Excel. Files in folders that are not inside of the "My Documents" folder do not appear in the file list and so they cannot be opened. See "Accessing Files on a Memory Card" on page 119 for more information.

Pocket Excel Screen

- To maximize the amount of data on the display, tap **View** and then **Full Screen**. This will hide the tool bar, scroll bars, and other display elements, and use the entire display area to display data.

	C	G	H
1	TUE	WED	THU
2	10-Nov	11-Nov	12-Nov
3			
4	\$ 3,450	\$ 1,255	\$ 2,780
5	785.0	243.0	521.3
6	35.0	11.5	20.6
7			

- In attention to the full screen, you can also turn display of each individual display elements on or off. On the **View** menu, tap each element from **Toolbar** to **Row/Column Headings** to toggle its display on and off.
- You can tap **Freeze Panes** on the **View** menu to freeze specific rows/columns so they do not change when you scroll the screen. For example, you might freeze the first line in the upper right of the screen so it remains unchanged while the rows below it scroll.

Assigning a Password to a File

If you tap **Password** on the **Tools** menu and specify a password, the file will not open unless the correct password is input first. A password helps to keep file contents private. It is a good idea to password protect files that you don't want others to view.

Windows Media

Windows Media (Pocket PC Version) is a program for playing back digital audio files and video files. Playback of Windows Media and MP3 files in the Rugged PDA memory or on a network is supported.

Windows Media running on a PC can be used to copy files to the Rugged PDA.

Important



Movie and audio playback consumes large amounts of battery power. Continued playback over a long period can cause the Rugged PDA case to become warm. This does not indicate malfunction.

Using the Player Screen

After starting up Windows Media, you can use onscreen buttons that are similar to those found on a CD player to control playback.

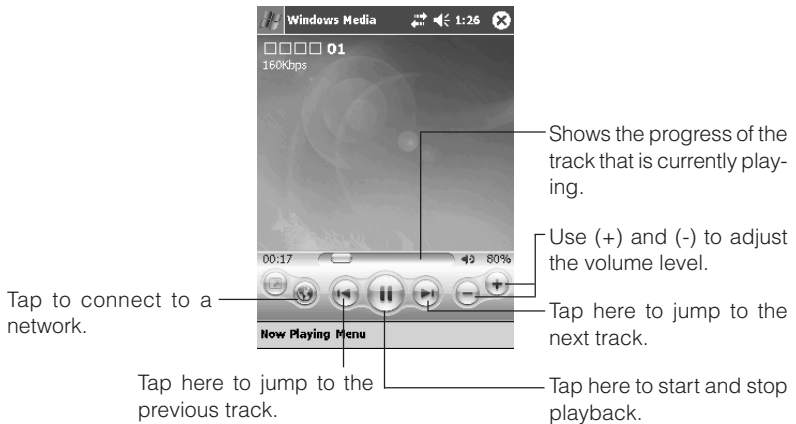

- Once started, Windows Media playback continues even if you switch to a different program.
- Tap the stop button to stop playback. If you turn off the Rugged PDA power while playback is in progress, power will turn back on again automatically when the built-in clock reaches midnight.
- Windows Media Player may not be able to play back certain MP3 file formats.

MSN Messenger

The MSN® Messenger of the Rugged PDA is a program that uses instant messages. The following functions are supported.

- Checking to see who is online
- Sending and receiving instant messages
- Using instant message to chat within a contact group

A Microsoft Passport™ account or Microsoft Exchange mail account is required to use the MSN Messenger service. You also need to obtain a passport. If you have a Hotmail® account or an MSN account, you already have a passport.

You can get a Passport account from the following URL.

Sign up for a Microsoft Passport account at <http://www.passport.com>.

Get a free Microsoft Hotmail e-mail address at <http://www.hotmail.com>.

The main MSN Messenger window classifies all members into two groups: on line and off line. While you are connected you can chat, and send and receive mail from this window. You can also disable chat, delete members, and perform other operations.

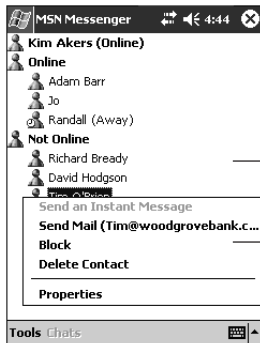

— Tapping a member name starts a chat session with that member.

— Tapping and holding displays a pop-up menu.



- To view online members while remaining off line, tap **My Status** on the **Tools** menu, and then select **Appear Offline**.
- Blocking contact from a member makes you appear offline on that member's screen. To unblock a member, tap and hold the member's name and then tap **Unblock** on the pop-up menu that appears.

Calculator

You can operate the nine-digit on-screen calculator by tapping its keys.

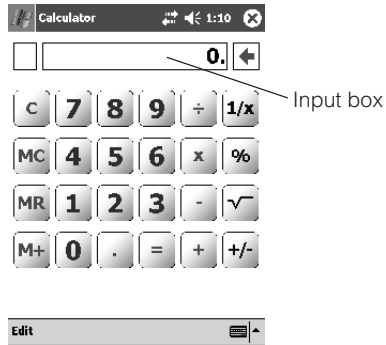

- Tap [=] to execute a calculation.
- You can also use the input panel to input values for calculation.

Game

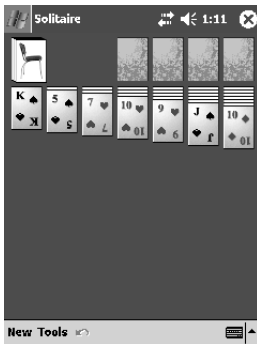

Solitaire

The object of Solitaire is to use all the cards in the deck to build up the four suit stacks in ascending order, beginning with the aces.

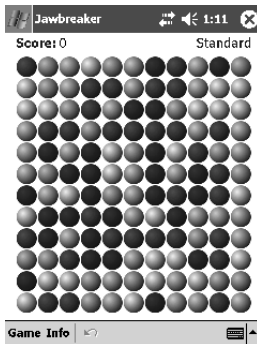

Jawbreaker

The objective is to align similar jawbreakers in order to form large blocks of jawbreakers before bursting them. The more jawbreakers in the block before they are burst, the greater number of points you will receive.

Card Backup

The Rugged PDA data can be backed up to a Compact Flash (CF) card, and SD/MMC card, or to the Rugged PDA's FlashDisk. Backed up data can be restored to the Rugged PDA when required.

Periodic backup is recommended to protect against the corruption or loss of important data.

The following data can be backed up.

- Files Files in the folders in the database.
- Database The following Microsoft Pocket Outlook database data can be backed up: Calendar, Notes, Contacts, Recordings, Tasks, Inbox.
- Registry information (operating system and program settings)

The Rugged PDA can also be backed up and restored using Active Sync running on a connected PC.

Important



- "Settings" information (password, dialup connection settings, etc.) cannot be backed up/restored.
- Certain applications may not run correctly after restore. If this happens, reinstall the application.

Pictures

You can set an image as the background for the Today screen by using an application for viewing JPEG images taken with a digital camera.

File Explorer

You can use File Explorer to perform the following operations on files stored in main memory or on a memory card.

- Create a new folder.
- Delete a file or folder.

Note that a file or folder delete operation cannot be undone.

- Move a file or folder.

Moving a folder moves all of the files and folders inside along with it.

After performing a cut operation on a file, you will be able to paste it only once.

Unlike Copy, multiple pasting of the same file is not supported.

Some folders and files cannot be renamed or deleted.

- Duplicate a file or folder.

Pasting a file in the folder where the original file is located creates a duplicate of the original file. The duplicated file name will be the same as the original file, with "Copy of" added at the beginning.

After copying a file, it can be pasted any number of times until you perform another file "copy" or "cut" operation.

- Rename a file or folder.
- Send a file using Inbox.

From File Explorer, you can specify a file to attach to an e-mail message and create an outgoing message to send from Inbox.

- Send a file using infrared communication.

From File Explorer, you can send a file from the Rugged PDA to another Pocket PC using infrared communication.

Using File Explorer

Tap  → **Programs** → **File Explorer** to start up File Explorer. This will initially display a list of files and folders located in the My Documents folder in the Rugged PDA main memory.

Tap here to move up one level from the currently displayed level.

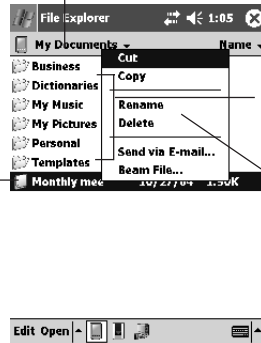

Tapping a file starts up the associated application and opens the file.

Tapping a folder displays its contents.

Tapping and holding the area to the right of the file and folder icons displays a pop-up menu, which contains commands for file and folder operations.



Note

- Some system files will not appear in File Explorer. You can view such files using ActiveSync on your computer.
- File Explorer does not display file name extensions. Also, the file size may not be visible in the case of very large files.
- To view file name extensions or file sizes that are not visible on the File Explorer screen, connect the Rugged PDA to a PC and use ActiveSync Explorer. For information about using ActiveSync, see ActiveSync help.
- If you want to view this information on the Rugged PDA, tap **Tools** → **Add Attachment** on the mail message composition window. You will be able to see the file **Size** and **Type** on the file list that appears. See help for information about mail operations.

FLCE

FLCE is a program for transferring a specified file to a specified folder. In addition, file transfer can be performed not only between two Rugged PDAs but also between the Rugged PDA and a PC connected via the cradle or via USB cable directly. The file and folder specified for transmission, the operation method and the destination are specified with the relevant parameters.

Important



Before starting up FLCE, make sure that the battery pack on the Rugged PDA is sufficiently charged.

A low battery power during data communication can cause unstable communication, loss of data being used and the power shut down on the Rugged PDA.

Menu



Menu can be used to start up programs and open files by tapping buttons on the screen. You can assign programs and files to buttons as you like.

To start up Menu, press the  button on the front of the Rugged PDA. This will turn on the Rugged PDA and start up Menu.

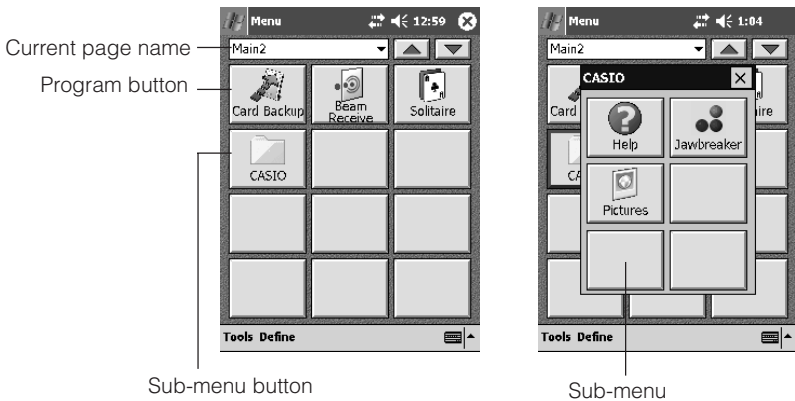
- One Menu screen is called a "page." Menu lets you create up to 10 pages of buttons. Each page can have up to 12 buttons, which means quite a large number of programs and files can be grouped by type for easy management.
- In place of a program or file, you can also assign a sub-menu to a button.



Starting Up a Program from Menu

- To start up a program assigned to a Menu button, tap the button. To start up a program assigned to a button on a sub-menu, first tap the sub-menu button and then tap the program button on the sub-menu that appears.
- To display another Menu page, tap the down arrow button to the right of the page name and then select the page you want. You can also tap the  and  buttons to scroll through Menu page.

Find and Help

Using Find

Search lets you instantly find data you stored using the Rugged PDA's built-in programs. You can search by file name or file contents.

The Find feature on your device helps you quickly locate information.

- On the  → **Programs**, tap **Find**. Enter the text you want to find, select a data type, and then tap **Go** to start the search. You can specify to search among Pocket Office documents, PIM information, or Notes documents.

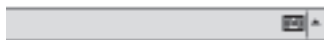

- Besides Pocket Outlook (Calendar, Contacts, Tasks, Inbox, Notes) data, search also searches the files and folders located in the My Documents folder (only).
- You can use File Explorer to check the files in the Rugged PDA main memory (or on a memory card inserted in the Rugged PDA card slot). For information about File Explorer, see page 82.

Viewing Help

Help is your source of useful information about how to use the Rugged PDA. You can reference help to learn the basics you need to know in order to use the Rugged PDA's built-in programs. It is the perfect way to look up operational information when you are on the road and don't have your user's guide with you. Help can be accessed at any time by tapping **Help** on the menu that appears when you tap the  button. The window that appears first shows help information about the program or screen you are currently using.

Setup Overview

The basic operating environment of the Rugged PDA can be configured, and its hardware, system, and other components can be adjusted as required.

Tapping  → **Settings** displays a screen like the one shown below.

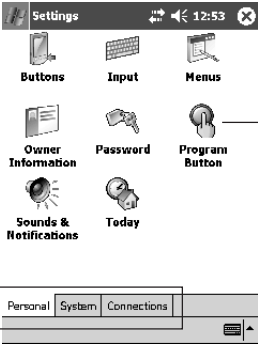









Settings are grouped on three tabs named **Personal**, **System**, and **Connections**. Tap a tab to display its settings.

Tapping an icon displays the setting screen for that item.

Personal Tab Settings

The **Personal** tab contains settings that you can use to personal the Rugged PDA to suit your particular needs.





Items	Description
Buttons 	Use this item to specify the program that starts up when the Rugged PDA program button is pressed.
Input 	Use this item to configure Writing mode input options, to configure Recording mode sound quality and recording format settings, etc.
Menus 	Use this item to specify the programs that appear in the Start menu, and the contents of the pop-up menu that appear when you press the New button on the Today screen.
Owner Information 	Use this item to input your personal information. You can also configure the Rugged PDA to display the information you input whenever it is turned on.
Password 	Use this item to register a Rugged PDA password. Once you do, data cannot be accessed until you input the password when you turn on power.
Program Button 	Use this item to specify whether the Rugged PDA should turn on when the program button is pressed.



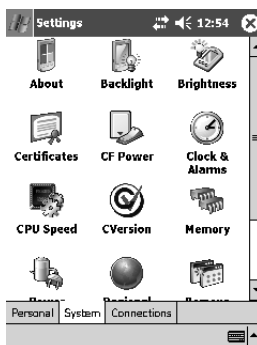







Items	Description
Sounds & Notifications 	Use this item to adjust the audio volume level, and to customize the different sounds produced for various specific events.
Today 	Use this item to select the information you want to appear on the Today screen.

System Tab Settings

The **System** tab contains various setting for the Rugged PDA hardware and system settings.







Items	Description
About 	This item displays version and copyright information about the system built into the Rugged PDA. You can also set the device ID (Rugged PDA name), which is used to distinguish the Rugged PDA from other terminals.
Backlight 	Use this item to configure the auto dimmer time and other settings.
Brightness 	Use this item to adjust screen brightness.
Certificates 	Use this item to check the identity of a communication partner, and to manage your digital ID for securing your own identity.

Items	Description
CF Power 	Use this item to configure Compact Flash card and wireless LAN settings, and power saving settings.
Clock & Alarms 	Use this item to specify a home city and a visiting city, and to configure date and time settings. This item can also be used to configure alarm settings.
CPU Speed 	Use this setting to switch the CPU clock frequency in order to reduce power consumption so that the life of the battery pack can be extended.
CVersion 	This item displays version information about the CPU, etc.
Memory 	Use this item to change the main memory allocation for data storage and program execution, and to exit programs that are currently running. You can also check how much unused memory is available on a memory card (when using one).
Power 	Use this item to check the current remaining levels of the battery pack and backup battery. You can also specify the auto power off trigger time for powering down the Rugged PDA when you do not perform any operation.
Regional Settings 	Use this item to specify the region where you are using the Rugged PDA, and the date, time, number, and monetary unit display format. You can configure individual settings for each display format, if you want.
Remove Programs 	Use this item to delete add-on programs installed on the Rugged PDA.
Screen 	Use this item to switch between portrait and landscape touch screen orientation, and to adjust the tap points (touch screen calibration).
Storage Manager 	This item displays the file capacity of a peripheral device connected to the Rugged PDA.

Connections Tab Settings

The **Connections** tab includes setting items that control the Rugged PDA connection to the Internet or an external computer using a cable or modem.



Items	Description
Beam 	Use this item to enable and disable receipt of infrared communication.
Bluetooth Connection 	Use this item to enable data exchange using Bluetooth short-distance wireless communication.
Connections 	Use this item to configure settings for connecting to the Internet or a company network, and dialup connection settings.
Network Cards 	Use this item to select a network card for data communication.
Pegasus Settings 	Use this item to configure wireless LAN settings.

Infrared Communication

Infrared Communication

The Rugged PDA has an infrared communication port that can be used for IR transfer of data between two Rugged PDAs, or between the Rugged PDA and other type of Pocket PC. You can also use infrared communication to transfer data and perform data synchronization between the Rugged PDA and a PC.



Infrared Communication port



Note

The information in this section covers infrared communication operations between two Rugged PDAs only.

For information about infrared communication to transfer or synchronize data between the Rugged PDA and a PC, see ActiveSync help.

Transferring Data

This section explains how to use infrared communication to transfer data between two Rugged PDAs. To transfer data, you will need to perform different operations respectively at the original and destination sides.

Important



Note that you cannot use infrared communication when the Rugged PDA is connected to a PC by cable. Before trying to perform infrared communication, first disconnect the cable from the Rugged PDA or remove the Rugged PDA from the Cradle.

To Transfer Data

Perform the following procedure to transfer data.

1. Position the two Rugged PDAs no further than about 30 cm from each other, and so their infrared communication ports are facing each other.

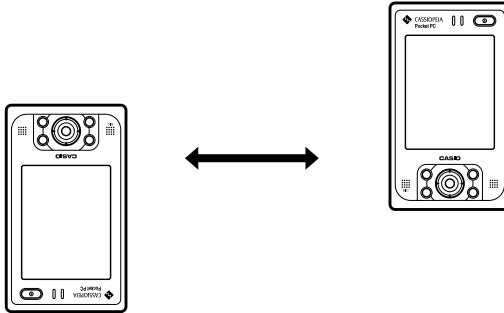

2. On the original side, tap and hold the data item or file you want to send. Then on the shortcut menu that appears, tap **Beam File...**
 - The data send operation can be performed from the program that created the data or from File Explorer.
3. Data transfer will start. A message will remain on the display to indicate that data transfer is in progress.
4. Completion of data transfer will be indicated by a message on the displays of both the original and the destination sides.
 - Tap the **Close** button on the message screen.

Data Send Operation

Data can be sent using infrared communication using either of the two methods described below.

- Sending from the program used to created the data or file
Files created using Calendar, Contacts, Tasks, Notes, Pocket Word, or Pocket Excel can be sent from the applicable program.
- Sending from File Explorer
File Explorer can be use to send files stored in the Rugged PDA main memory or on a memory card.

● To send from a program

1. Start up the program whose data you want to send.
 - To send Contacts data, for example, tap  → **Contacts**.
2. Tap and hold the data you want to send.

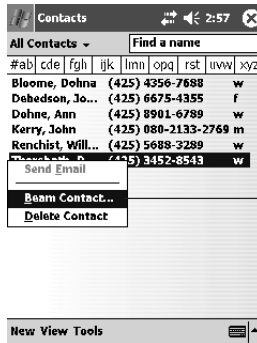

On the pop-up menu, tap **Beam Contact...**

● To send from File Explorer

1. Start up File Explorer.
2. Tap and hold the file you want to send.
3. On the shortcut menu, tap **Beam Contact...**

Important



- You cannot send a folder using infrared communication.
- Only files can be sent from File Explorer. To send Contacts, Calendar, or Tasks data, perform the send operation from the applicable program.

To Receive Data

1. Aligning the infrared communication ports of the two Rugged PDAs, position them close to each other taking care there is nothing blocking the path between them.
2. On the sending unit, perform the required send procedure. The data will be received automatically by the destination side.
 - When a confirmation message asking whether you want to receive the data appears, perform the required operation as instructed by the message.

Bluetooth®

Bluetooth® is wireless communication technology that uses the 2400MHz to 2483.5MHz band to transfer data. The Rugged PDA comes with Bluetooth® technology built in, which provides it with the capability of performing high-speed, high-stability short-range wireless communication.

Two Rugged PDAs with Bluetooth® integrated do not need to be aligned with each other in order to connect.

When Bluetooth® is turned on, two Rugged PDAs that are within three meters distance of each other will be able to perform the following types of data send and receive operations.

- Calendar, Tasks, Contacts, etc. exchange
- File transfer
- Connection to a Bluetooth® wireless LAN
- Connection with another Bluetooth® device

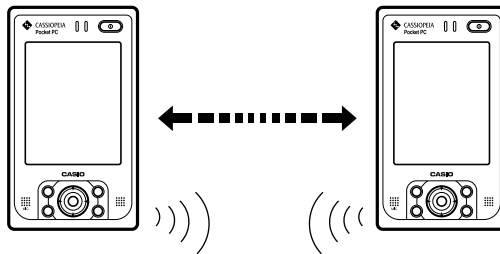

Important Precautions

The radio waves emitted by a Bluetooth® device can affect the operation of medical equipment, etc. In some cases, this can even lead to a serious accident. To prevent this, turn off either the Rugged PDA or the Bluetooth® functions in the areas described below. In hospital, train, aircraft, in gasoline station or any other area where flammable gas is generated, near automatic door, or fire alarm devices.

Tips to Help Ensure Successful Communication

Note the following information, which can help you ensure successful Bluetooth® data communication.

- Make sure the Rugged PDA is visible from and within about 3 meters of the other Bluetooth® devices. The communication range may be shorter depending on the local environment (if there are walls and furniture in the path, or radio wave is emitted by other Bluetooth® device, etc.), and the structure of the building where you are located.

Ferrocement structures in particular can cause problems, because iron reinforcements between floors and in walls can make communication impossible. Perform data communication at least two meters from other devices (electric appliances, AV equipment, office equipment, digital cordless telephones, facsimiles, etc.) Microwave ovens in particular can cause problems, so the distance should be increased to at least three meters. Turning on the power of another device that is too close can interfere with proper communication, TV and radio interference, and reception interference (in particular, distortion of certain UHF or broadcast satellite channel TV images). If proper communication is not possible in the vicinity of a transmitter, wireless device, or other device, move to another location. Very strong radio waves in the area can make proper communication impossible.

Wireless LAN Radio Interference

Since Bluetooth® devices and wireless LANs (IEEE802.11b/g) use the same frequency band, using the Rugged PDA in the vicinity of a wireless LAN enabled device can generate radio interference, which can result in slower communication speeds and even make connection impossible. If this happens, take the following steps.

- Move the Rugged PDA so it is at least 10 meters from the wireless LAN enabled device.
- If you must use one of the two devices within 10 meters of the other, turn off either the Rugged PDA or the wireless LAN.

Important





The Bluetooth Version 1.2 built into the Rugged PDA allows simultaneous use of wireless LAN and Bluetooth communication. However, communication may not be possible due to the surrounding electromagnetic fields.

Wireless LAN

The IT-10M20BR* supports connection to an 802.11b wireless LAN, or to a wireless LAN compatible peripheral. For example, you could connect to a hot spot at a train station or other public facility, access the Internet and send or receive e-mail, or access a company network. See "Tips to Help Ensure Successful Communication" on page 95 for more information.

Using a Wireless Communication

 Warning	
	<ul style="list-style-type: none">• The use of wireless communication devices and electronic devices in aircraft is recommended to consult first with flight attendant prior to the use.
	<ul style="list-style-type: none">• Do not use wireless communication devices in the vicinity of automatic doors, fire alarm devices, or other automatic control equipment. Radio waves from wireless communication devices can cause mis-operation of the equipment, leading to serious accident.



This wireless transmitter uses the 2.4GHz band. It employs the DS-SS modulation system and has an interfering range of 40m.

You need to turn on wireless LAN in order to use it. On the Rugged PDA, tap  → **Settings** → **System**. On the **CF Power** tab, select the **W-LAN Power Enable** check box. After that, you will need to start up Pegasus Settings and configure network settings required for connection.

* : the model is not available in the USA and Canada.

Reset and Full Reset

Reset

You should reset the Rugged PDA whenever it stops operating correctly due to user mis-operation or some abnormality. The following are examples of symptoms that indicate reset is required.

- Nothing happens when you tap the screen or press a button.
- The busy icon continues to rotate for a long time without stopping.

"Reset" is the same thing as restarting a computer. Resetting the Rugged PDA will result in loss of any input or edited data that has not been saved yet, but saved data and settings are, as a rule, retained.

Important



- Whenever possible, be sure to quit all programs ( → **Settings** → **System** → **Memory** → **Running Programs**) before resetting.
- Though saved data is normally not lost when you reset the Rugged PDA, certain data abnormalities or other problems can cause all data to be cleared from memory. Whenever possible, it is recommended that you back up data to a memory card or some other medium before resetting.

To Reset the Rugged PDA

1. Use the stylus to press the reset switch about one second on the left side of the Rugged PDA.
 - To avoid damaging the tip of the stylus, be sure to press straight down on the button.
 - Use only the stylus to press the reset switch. Using a ballpoint pen or other object can damage the reset switch and cause malfunction.

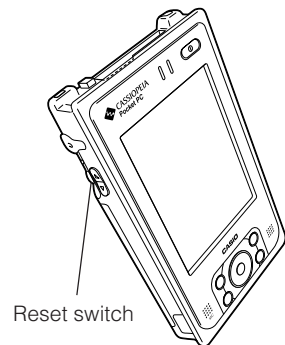

2. The Rugged PDA restarts and displays the Today screen.
 - The reset process starts as soon as you press the reset switch.
 - If there is no problem with memory data, the Today screen will appear a few seconds after the startup screen. All saved data in memory and all settings in effect prior to the reset will remain unchanged, and you should be able to access them normally.

Important



If reset does not restore normal the Rugged PDA operation, try performing a full reset (which will initialize memory).

Full Reset (Memory Initialization)

Performing a full reset initializes the Rugged PDA memory, causing all data stored in it to be lost, and returns all settings to their initial defaults.

A full reset is required in the following cases.

- You want to clear the Rugged PDA memory and return to its initial default settings.
- You forgot your password and cannot access the Rugged PDA data.
- The Rugged PDA does not operate correctly due to a memory abnormality.
- After leaving the Rugged PDA without the battery pack installed for a few weeks, you reload the battery pack and want to use the Rugged PDA again.

To Perform a Full Reset

- If there is a memory card loaded in the Rugged PDA, remove it before performing the full reset.
- Performing the following procedure will delete all data currently stored in memory. If possible, back up the Rugged PDA data to a PC, memory card, or some other medium.

1. While holding down the power button, press the reset switch on the left side of the Rugged PDA.
2. Perform the operations as instructed by the message that appears on the display.

Proceeding with this operation initializes memory.

Press **Action** to proceed or **Cursor** to cancel.

- The screen will change as shown below. Configure the Rugged PDA initial settings.
(1) Startup Screen → (2) Calibrate Screen

3. After configuring settings, press the power button to turn off the Rugged PDA.

- If you have back up data, you can restore it after performing the above procedure and confirming that the Rugged PDA is operating normally. For information about restoring back up data, see ActiveSync help.

Important



- Even if you back up data to a PC, do not restore the backed up data to the Rugged PDA after performing the operation below. Data that is backed up while the Rugged PDA system is unstable can contain the elements that caused the instability. Restoring such data from the PC may cause symptoms of the system instability to resurface.
- In order to avoid resurfacing of unstable system operation, use the following method to back up data on a PC, perform Calendar, Contacts, and other data synchronization to transfer the data to the PC. Next, transfer other files to the PC one by one using drag and drop.

- Even if you have performed a full reset on your Rugged PDA the screen still freezes, perform the following operations.

1. While you are holding down the center of the Cursor button and the Power switch, press the Reset switch on the left side with stylus.

2. Indicator lamp on the right side lights in red. Wait until it goes off, and then press the Power switch.

Your Rugged PDA shows the following screens sequentially. Follow each guidance appeared in the screen and perform the initial setup.

Setup screen (“Windows Mobile”) → Align screen (for display calibration)

3. When you have completed the initial setups in the step above, press the Power switch to turn off. If you wish to restore backed up data in PC or memory card, make sure first that all the initial setups described in the step 2 are complete and your Rugged PDA runs normally, and then restore the backed up data into the Rugged PDA. For restoration method, refer to “Help” of ActiveSync.



3

Connecting Peripherals

AC Adaptor (AD-S15050AE)

The AC adaptor can be used with the Rugged PDA or the optional Basic Cradle (HA-C60IO).

Before using the AC adaptor, be sure to read "Safety Precautions" (page 5) to ensure you use it correctly.

The case of the AC adaptor may become warm during use. This does not indicate malfunction. To ensure safety, be sure to unplug the AC adaptor from the power outlet if you do not use it for a long time.

Connecting the AC Adaptor to the Rugged PDA

Connect the AC adaptor as shown in the illustration below (① → ② → ③).

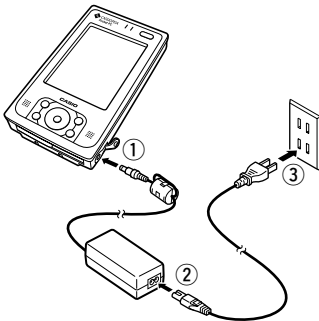

Connecting the AC Adaptor to the Basic Cradle (HA-C60IO)

Connect the AC adaptor as shown in the illustration below (① → ② → ③).

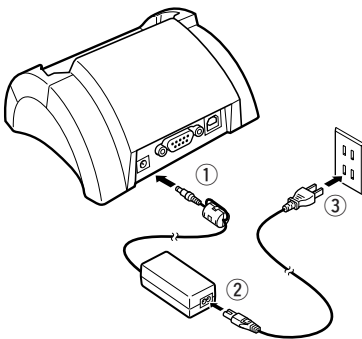







Specifications

Items	Specifications
Rated Voltage/Frequency	Input 100 to 240V 50/60Hz
Rated Output Voltage	DC5V
Power Cord Length	200cm(Input) 150cm(Output)
Dimensions	40(W) × 94(D) × 31(H) mm
Weight	Approx. 250g (with power cords)
Operating environment	Temperature 0 - 40°C, Humidity 30 - 80% (no condensation)

Two power cords are provided with the Rugged PDA, use the power cord that is appropriate for your region.

Basic Cradle (HA-C60IO)

Data can be transferred between a PC and the Rugged PDA using the Basic Cradle's USB interface or RS-232C interface. Also, the Rugged PDA charges while it is mounted on the Basic Cradle.

 Warning	
 	Never bring in Rugged PDA a bathroom or any other location where the possibility of splashing or high humidity exists.
 	Mounting the Rugged PDA on the Basic Cradle while it is wet creates the risk of fire, electric shock, and serious accident.
 	Use only the specified AC adaptor with the Basic Cradle. Use of other type of AC adaptor creates the risk of fire.

General Guide

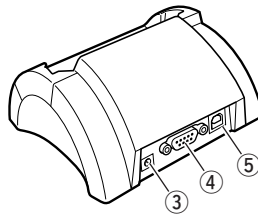
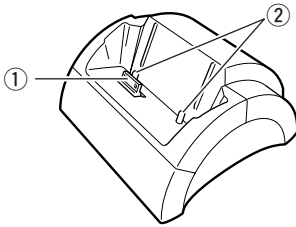

① Serial connector

This connector mates with the serial connector on the bottom of the Rugged PDA.

The power is also supplied to the Rugged PDA via this connector.

② Alignment pegs

Align the Rugged PDA with these two pegs when mounting it on the Basic Cradle.

③ Power adaptor port (DC IN 5V)

Connect the AC adaptor's power cord here.

④ RS-232C port (RS-232C)

This port is used when connecting to a PC for data transfer.

⑤ USB port ()

This port is used when connecting to a PC for data transfer.

Important



Keep the serial connector clean by wiping it with a soft, dry cloth or a cotton swab. A dirty serial connector can cause poor contact and decrease charging efficiency.

To Mount the Rugged PDA onto the Basic Cradle

1. Place the Basic Cradle on a desk or some other flat, stable surface.

2. Turn off the Rugged PDA.

Rotate the serial connector cover on the bottom of the Rugged PDA one turn, and store it on the opposite side.

Aligning the Rugged PDA with the grooves of the Basic Cradle (①), slide it straight down onto the cradle (②).

Taking care to ensure the serial connectors and pegs are aligned correctly, press the Rugged PDA down onto the Basic Cradle so it connects securely.

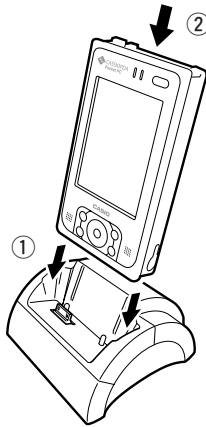

3. Connect the specified AC adaptor (AD-S15050AE) to the Basic Cradle (③).

4. Connect the USB cable that comes with the Basic Cradle or an optional RS-232C cable (DT-887AX or DT-882RSC or DT-883RSC) (④).

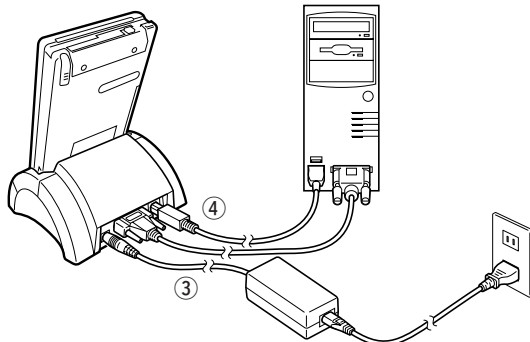

3

To Remove the Rugged PDA from the Basic Cradle

1. While holding the Basic Cradle with one hand, remove the Rugged PDA straight up.

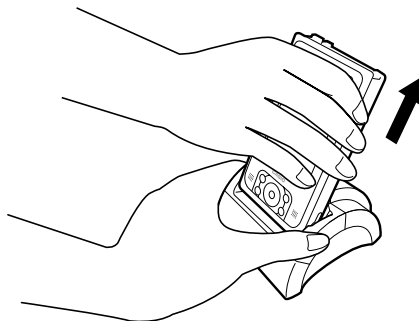







Specifications

Items		Specifications
Interface		USB × 1port (TYPE-B)
		RS-232C × 1port
Charging	Charging system	Fixed voltage (with current limiter)
	Charging time	Approx. 5 hours
Power		AC adaptor (AD-S15050AE)
		AC100 - 240V 50/60Hz, DC5V
Dimensions		114(W) × 107(D) × 60(H) mm
Weight		Approx. 150g
Operating environment		Temperature 0 - 40°C, Humidity 30 - 80% (no condensation)

Bridge Satellite Cradle (HA-C61IO)

Data can be transferred between a PC and the Rugged PDA using the Bridge Satellite Cradle's USB interface or RS-232C interface, and the Rugged PDA's infrared communication port.

The Bridge Satellite Cradle also can be used to charge the Rugged PDA.

 warning	
   	Never bring in Rugged PDA a bathroom or any other location where the possibility of splashing or high humidity exists. Mounting the Rugged PDA on the Bridge Satellite Cradle while it is wet creates the risk of fire, electric shock, and serious accident.
 	Use only the specified AC adaptor with the Bridge Satellite Cradle. Use of other type of AC adaptor creates the risk of fire.

3

General Guide

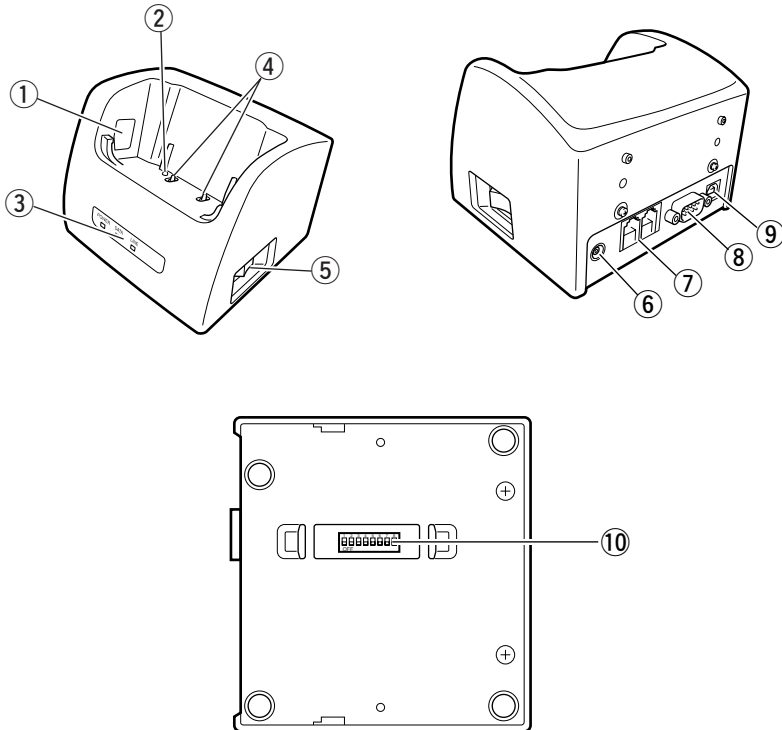

① Infrared communication port

Align this port with the infrared communication port of the Rugged PDA for IrDA data communication.

② The Rugged PDA detection switch

This switch detects when the Rugged PDA is correctly mounted on the Bridge Satellite Cradle.

③ Status lamp

POWER	OFF: Power OFF Green: Power on, the Rugged PDA is mounted correctly Red: Power on, the Rugged PDA is not mounted
DATA	Indicates the data communication status. Off: No communication Flashing Green: Communicating Red: Bridge Satellite Cradle connection problem
LINE	Off: System not operational Green: System operational

④ Power contacts

These terminals supply power to the Rugged PDA.

⑤ Power switch

Turns Bridge Satellite Cradle power on and off.

⑥ Power adaptor port (DC IN 12V )

Connect the AC adaptor's power cord here.

⑦ RS-422 ports (C-OUT, C-IN)

Use these ports when connecting up to eight Bridge Satellite Cradles in series.

⑧ RS-232C port (RS-232C)

This port is used when connecting to a PC for data transfer.

⑨ USB port ()

This port is used when connecting to a PC for data transfer.

⑩ DIP switches

Use these switches to configure Bridge Satellite Cradle basic settings (See page 111).

Important



Keep the power contacts clean by wiping them with a soft, dry cloth or a cotton swab. Dirty power contacts can cause poor contact and decrease charging efficiency.

Using the Bridge Satellite Cradle

The optional AC adaptor (AD-S42120AE) is used to supply power to the Bridge Satellite Cradle. Note that you cannot use the AC adaptor (AD-S15050AE) that comes with the Rugged PDA.

1. Turn off the Bridge Satellite Cradle and the PC you will be connecting to it.
2. Connect the specified AC adaptor to the Bridge Satellite Cradle connector.
On the back of the Bridge Satellite Cradle, remove the cover cap from the USB port or the RS-232C connector. Take care not to lose the cap. Connect an optional USB cable (DT-380USB) to the USB port, and an optional RS-232 cable (DT-887AX or DT-882RSC or DT-883RSC) to the RS-232C connector.

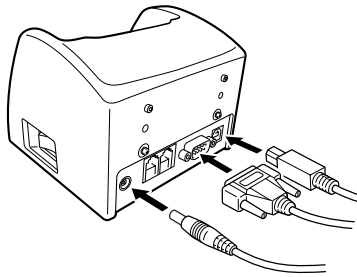

3. Turn on Bridge Satellite Cradle power.
The POWER lamp on the front of the cradle will light red.
4. Mount the Rugged PDA on the Bridge Satellite Cradle.
The POWER lamp on the front of the cradle will change to green.

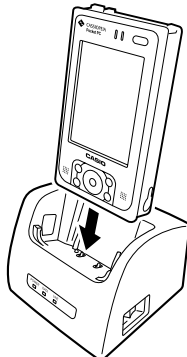

3

- If the system is operational and the communication mode is entered successfully, the LINE (system indicator) lamp will light green.
- When communication starts, the DATA (communication indicator) lamp will flash green while data communication is being performed.

The Rugged PDA is charged while it is mounted on the Bridge Satellite Cradle, regardless of whether the power on the Rugged PDA is off or on. When charging starts, the left side of the indicator lamp on the top of the Rugged PDA lights amber. The indicator lamp changes to green when charging is complete.

Important



The infrared communication function uses a high-sensitivity communication element. To ensure proper communication, avoid using devices that generate radio waves (cellular phones, etc.) in the vicinity of the Rugged PDA while communication is in progress. Make sure the power contacts of the Bridge Satellite Cradle do not become wet. Moisture can cause shorts, which create the risk of fire and serious accident.

Linking Multiple Bridge Satellite Cradles

The C-OUT port of the Bridge Satellite Cradle that is connected to the PC can be connected to the C-IN port of another Bridge Satellite Cradle using the optional daisy chain connection cable (DT-888RSC). You can daisy chain up to eight Bridge Satellite Cradles.

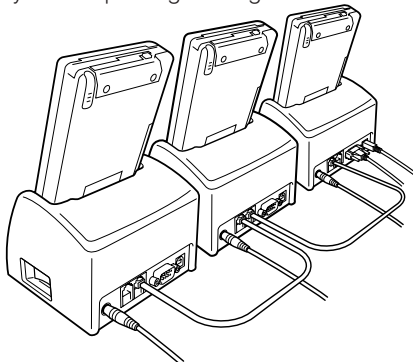

Important



The RS-232C port and USB port cannot be used simultaneously.

Important



Do not connect to a telephone line. Never connect the wrong type of cable (telephone modular cable, etc.) to the C-OUT and C-IN ports. Improper connection can damage the connector and cause malfunction.

Configuring DIP Switch Settings

The DIP switches are located under the cover on the bottom of the Bridge Satellite Cradle.

Make sure Bridge Satellite Cradle power is turned off before changing DIP switch settings.

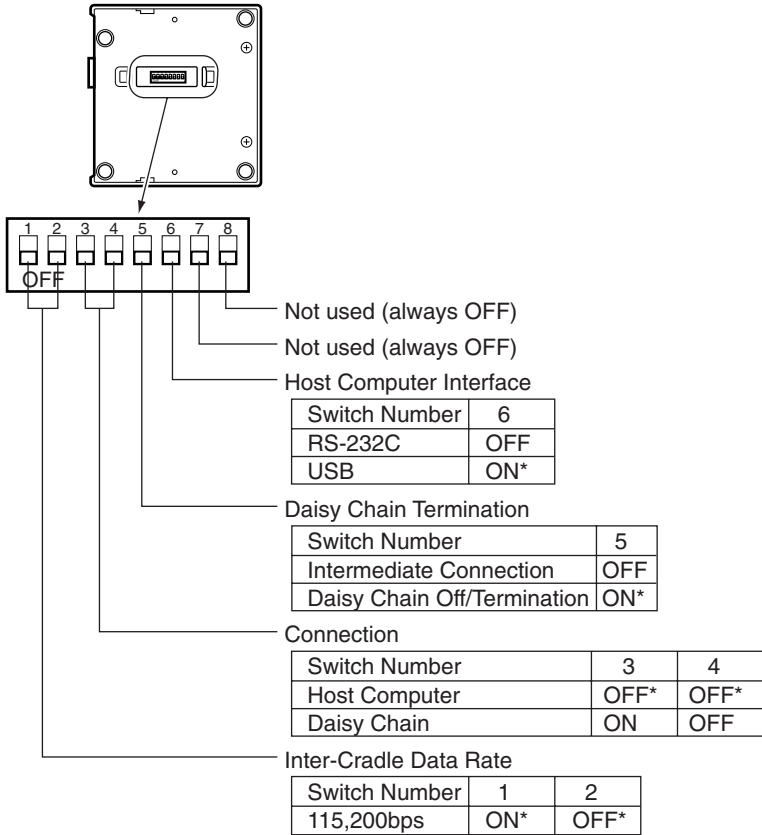

* Initial default setting

Important











Though it is possible for the user to configure DIP switch settings, it is recommended that this operation be left up to qualified personnel of your authorized CASIO distributor.

Specifications

Items		Specifications
Interface		USB × 1port (TYPE-B)
		RS-232C × 1port
		RS-422 × 2port (IN/OUT port)
		Infrared (IrDA)
Charging	Charging system	Fixed voltage (with current limiter)
	Charging time	Approx. 5 hours
Power		AC adaptor (AD-S42120AE) AC100 - 240V 50/60Hz, DC12V
Dimensions		110(W) × 103(D) × 87.5(H) mm
Weight		Approx. 380g
Operating environment		Temperature 0 - 40°C, Humidity 30 - 80% (no condensation)

Dual Battery Charger (HA-C32DCHG)

A battery pack (HA-C21BAT) can be charged by loading it into the Dual Battery Charger.

⚠ Warning	
 	Use only the specified AC adaptor (AD-S42120AE) with the Dual Battery Charger. Use of other type of AC adaptor creates the risk of fire.
  	Use only the battery pack specified (HA-C21BAT) for the Rugged PDA. Using a non-specified battery pack may cause it to smoke, or flame resulting in electric shock or fire.
  	Never bring in the Dual Battery Chager a bathroom or any other location where the possibility of splashing or high humidity exists. Mounting the Battery pack on the Dual Battery Charger while it is wet creates the risk of fire, electric shock, and serious accident.

3

General Guide

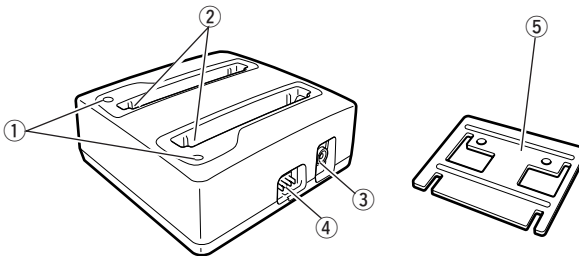

- ① Charging status indicator lamp
 - Green: Charging complete
 - Red: Charging
 - Flashing Red: Charging problem
 - Flashing Green: Charge standby
 - Off: No battery pack
- ② Power contacts
 - These contacts provide connection with the battery packs.
- ③ Power Adaptor Port (DC IN 12V )
 - Connect the AC adaptor's power cord here.
- ④ Series Connection Terminal
 - This terminal makes it possible to link multiple charger units together.
- ⑤ Coupling plate

Handling Precautions

Battery Charger

- Water or any other liquid on the power contacts creates the risk of electric shock and fire. Dirt causes poor contact and decreases charging efficiency. After unplugging the AC adaptor from the battery charger to ensure safety, wipe the power contacts with a dry cloth, cotton swab, etc.
- A battery pack in the charger may become warm. This is normal.
- Do not place anything on top of the battery charger while charging is in progress.
- Do not remove the battery pack or disconnect the AC adaptor while charging is in progress.
- Repeated loading and unloading of a battery pack can cause it to deteriorate.

Battery Pack

- A battery pack is not charged when you purchase it. Before using a new battery pack or one that you have not used for a very long time, fully charge it first.
- A battery pack is a consumable item. If the amount of operation you get from the battery pack after charging it is very short or if the battery pack does not recover no matter how many times you charge it, it probably means that the battery pack has reached the end of its life. Replace the battery pack with a new one.

Connecting Dual Battery Chargers Together

You can connect up to three battery chargers together for simultaneous charging of six battery packs. You need only one AC adaptor, even if you have multiple battery chargers connected together. Do not connect more than three battery chargers together.

- 1.** Use a screwdriver or a similar tool to remove the connection terminal covers. Do not use the stylus.

Positioning the battery chargers in the same direction, insert the male connector of one into the female connector of the other.

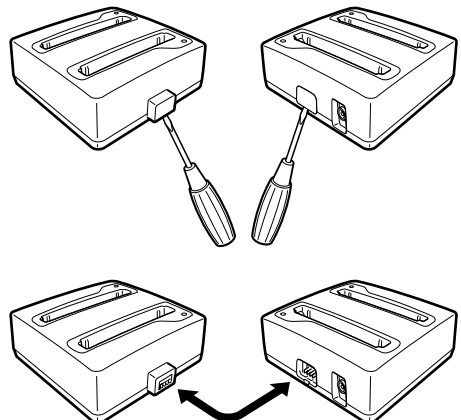

2. Turn over the battery chargers, and secure them together with the coupling plate and screws that come with the chargers.

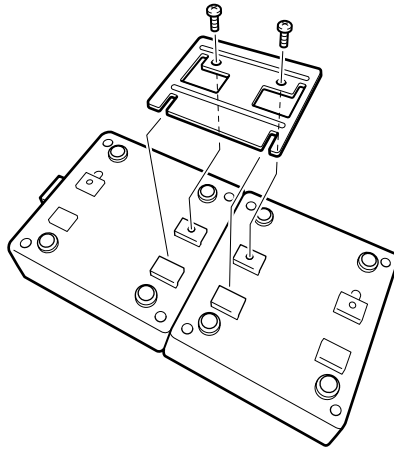

3

Charging a Battery Pack

The optional AC adaptor (AD-S42120AE) is used to supply power to the battery charger.

A battery pack can be inserted into either of the slots, or two battery packs can be charged at the same time.

1. Connect the AC adaptor to the AC adaptor port of the battery charger.
2. Insert a battery pack into the battery charger.
Note that a battery pack must be oriented correctly when you insert it into the battery charger. Orienting the battery pack as indicated by the illustration on the battery charger, make sure its power terminals are positioned correctly as you insert it straight down into the battery charger.

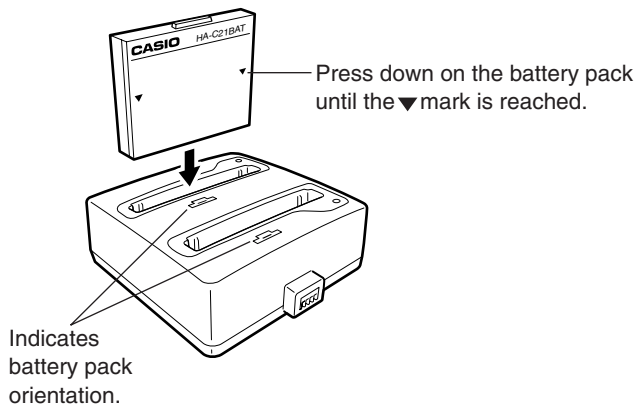

3. The charge status indicator lamp will light red, indicating that charging has started.

A green flashing charge status indicator lamp while a battery pack is inserted in the battery charger indicates charge standby. The indicator lamp will turn red and charging will start when the ambient temperature returns to the range of 0° to 40°C. A green charge status indicator lamp indicates that charging is complete. Remove the battery pack from the battery charger.

The time required for charging depends on whether you are charging one battery pack or two battery packs per battery charger.

About two hours is required for a full charge when charging one battery pack per charger, while about four hours is required for a full charge in the case of two battery packs per charger.

If two battery packs are inserted into a single battery charger, it will take four hours to charge the two battery packs fully. If two battery chargers are connected together and one battery pack is inserted into each of the chargers, however, it will take only about two hours to charge the two battery packs fully.

Important



- If the charge status indicator lamp starts to flash red during charging, immediately remove the battery pack(s) and check the following points.
 - a) Is the operating temperature in the range of 0°C to 40°C?
 - Wait until the operating temperature is within the allowable range and charge again.
 - b) Are the power contacts dirty or rusty?
 - Wipe the power contacts with a dry cloth, etc.
 - c) Does the same thing continue to happen even if you move to another location for charging?
 - It could mean that the battery pack is defective.

Specifications

Items	Specifications
Charging system	Fixed-voltage fixed-current system
Charging time	One battery pack per battery charger: Approx. 2 hours Two battery packs per battery charger: Approx. 4 hours
Power	AC adaptor AD-S42120AE AC100 - 240V 50/60Hz, DC12V
Dimensions	100(W) × 104(D) × 42(H) mm
Weight	Approx. 170g
Operating environment	Temperature 0 - 40°C, Humidity 30 - 80% (no condensation)

Communication Card Cover (HA-C92TCV)

Loading a communication card into the card slot of the Rugged PDA makes it possible to perform mobile Internet browsing in a train station, hotel, etc.

A communication card cover is provided to cover the raised card antenna to avoid unexpected accidents, to protect the antenna from impact, and to keep out dust and rain while using the card.

- 1.** Use a coin or similar object to remove the two screws that secure the card cover, and remove it from the Rugged PDA. Store the card cover in a safe place and make sure you do not lose it.

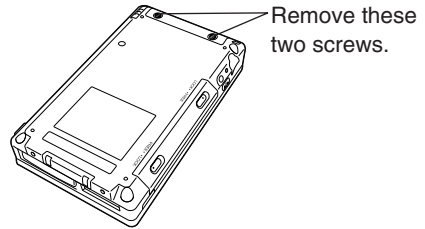

- 2.** Taking care that the card is oriented correctly, carefully slide it into the card slot as far as it will go.

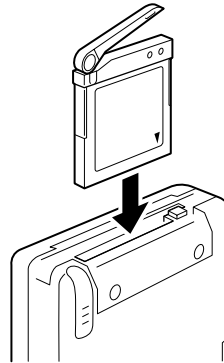

- 3.** Being careful with the raised communication card antenna, install the communication card cover and secure it in place with the two different kinds of screw, each with two screws.

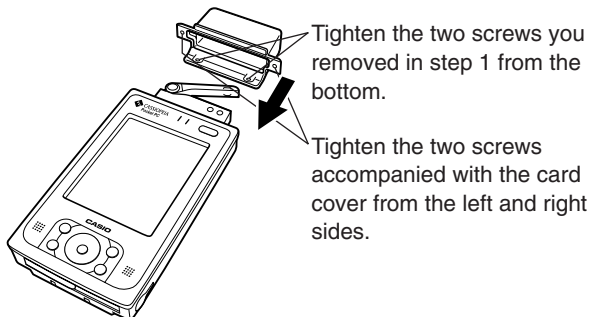

3

Cards

Using a Compact Flash (CF) Card

The Rugged PDA supports use of Type I and Type II (3.3V) Compact Flash cards. The following are the types of Compact Flash cards supported by the Rugged PDA.

Memory Card

A memory card works the same way as the data storage memory of the Rugged PDA. You can use a memory card to store files created with the Rugged PDA, and install programs on a memory card. Since data stored on a memory card is retained even when the card is removed from the Rugged PDA, a memory card can be used to transfer data between the Rugged PDA and a PC or other devices, or to backup the Rugged PDA data.

Modem Card

A modem card can be used to connect the Rugged PDA to a general telephone line (household modular jack, public phone equipped with a modular jack, etc.)

LAN Card

A LAN card (Ethernet card) makes it possible to connect the Rugged PDA to an Ethernet network.

Communication Card

A cell phone or PHS communication card provides data communication capabilities using a cell phone or PHS circuit.

Important



- Before using a modem, LAN, communication, or similar card, make sure that the Rugged PDA's battery pack is charged sufficiently. Low battery power during communication can cause unstable communication, loss of the data that is being used, and powering down of the Rugged PDA.
- Never turn off power or remove a memory card from the Rugged PDA while data is being written to or read from the card. Doing so can damage the memory card or its data.

Accessing Files on a Memory Card

In order for the Rugged PDA's built-in programs to access files on a memory card, a folder named "My Documents" must be created on the memory card (using File Explorer), and the files to be accessed must be moved to the "My Documents" folder. Note the following points.

- Create the "My Documents" folder in the top directory of the memory card. Do not create it inside of any other folder. Use single-byte characters to input the "My Documents" name, and be sure to include a single-byte space between the words "My" and "Documents."
- Placing a file inside of the "My Documents" folder allows it to be opened by various types of programs (Notes, Pocket Word, Pocket Excel). The programs cannot open any file that is outside of the "My Documents" folder.

Important



When there are memory cards loaded in both the CF card slot and the SD card slot, applications and setting operations are able to access only one card or the other (normally the first one that was loaded).

Loading and Removing a Compact Flash Card

Precautions when Loading and Removing Cards

- The card has a front and back, and it must be oriented correctly when loading it into the card slot. Attempting to force the card while it is oriented incorrectly can damage the connectors or the slot. Exercise care when loading a card.
- When inputting or editing data, it is recommended that you store any unsaved data in main memory before loading or removing a card.
- In some cases, the Rugged PDA may not be able to recognize a card correctly (indicated when programs cannot be started up using normal operations). If this happens, try reloading the Compact Flash card, and then press the reset switch.
- Using an I/O card that consumes a large amount of the current while battery power is low can cause the Rugged PDA to power down momentarily and then power back up again immediately.

Attaching

- 1.** Check to make sure that the Rugged PDA is turned off.
 - If it is turned on, press the power button to turn it off.
- 2.** Carefully note which side of the card is the front and which side is the back. With the front of the card facing the display side of the Rugged PDA and with the card carefully positioned in the slot, load it into the slot.
 - You may feel some resistance when sliding the card into the slot. Carefully slide the card along the grooves on both sides of the slot as far as it will go, until it is securely in place.

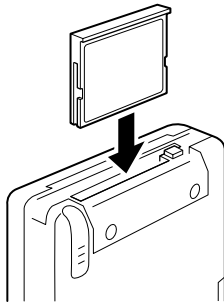

Make sure the card is not at an angle as you load it.

After loading the card, turn on the Rugged PDA and check the status of the card slot.

Removing

- 1.** Stop access of the Compact Flash card and turn off the Rugged PDA.
- 2.** Use the stylus to press the eject button next to the slot where the Compact Flash card is loaded.
This will cause the Compact Flash card to pop part way out of the slot. Grasp it with your fingers and pull it the rest of the way out.

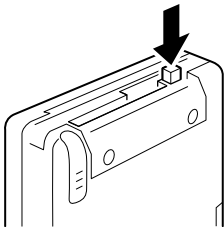

- Never pull on a connection cable to remove a Compact Flash card. Doing so can break the cable and cause malfunction.
- If the eject button is not raised, press and release it.

Using an SD card or a MultiMedia Card

The Rugged PDA supports use of SD cards and MultiMedia cards.



For information about using a memory card, see "Accessing Files on a Memory Card" on page 119.

Precautions when Loading and Removing Cards

- A card has its front and back, it must be oriented correctly when loading it into the card slot. Attempting to force the card while it is oriented incorrectly can damage the connectors and/or the slot. Exercise care when loading it. Exercise care when loading it.
- When inputting or editing data, it is recommended that you store any unsaved data in main memory before loading or removing a card.

Attaching

- 1.** Check to make sure that the Rugged PDA is turned off.
 - If it is turned on, press the power button to turn it off.
- 2.** Carefully note which side of the card is the front and which side is the back. With the front of the card facing the display side of the Rugged PDA and with the card carefully positioned in the slot, load it into the slot.
 - You may feel some resistance when sliding the card into the slot. Carefully slide the card in as far as it will go, until it is securely in place.
 - Make sure to load the card straight down, not angle it.

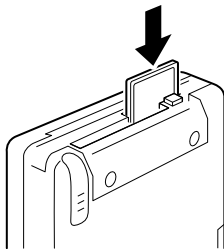

Removing

- 1.** Stop access of the card and turn off the Rugged PDA.
- 2.** Use your finger to press gently in on the card until you hear a click, and then release it. This will cause the card to pop out part way. Grasp the card with your fingers and pull it the rest of the way out.

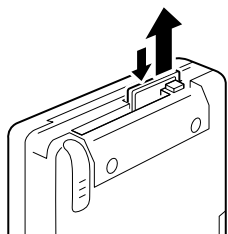



Appendix

Specifications

Item	IT-10M20	IT-10M20BR ¹
OS	Microsoft® Windows Mobile 2003 second edition software for Pocket PC	
CPU	Intel® PXA270 Application Processor 416MHz	
Display functions	480 X 640 dots	
	3.7-inch transfective TFT color LCD (65,536 colors) ² Resistive film touch panel with built-in LED backlight	
Memory	ROM	64MB Flash memory
	RAM	64MB OS, including enough memory to start program
Bluetooth ³		
Wireless LAN ³		
Standard external interfaces		Ver.1.2 Communication speed 1Mbps, 3dbm max Communication range: Approximately 3m
Infrared	IEEE802.11b Standard Wireless frequency: 2,400 - 2,483.5MHz Communication Speed: 11Mbps max Communication range: 50m (indoors), 150m (outdoors)	
CF card	IrDA FIR (4Mbps max) / SIR (115.2kbps max) ⁴ Communication range: 30cm (or 11.81") max	
SD card	1slot Compact flash card TYPE I / II (3.3V)	
Basic Cradle	1slot SD card / multimedia card	
Headphone	Connect to Basic Cradle to supply power to the Rugged PDA.	
Headphone	Compatible with 3.5 mm diameter mini stereo plug	
Speaker	Monaural	
Microphone	Monaural	
Power input	AC adaptor DC5V (100- 240V AC, 50/60Hz input)	
Operating battery ⁵		
Type	Lithium ion battery pack (HA-C21BAT) 2300mAh	
Operating period	Approx. 27 hours ^{6,7}	
Charge period	Approx. 5 hours	
Backup battery		
Memory backup	NiMH battery built-in <ul style="list-style-type: none"> • Approx. 30 minutes with the battery pack fully charged • Approx. 4 hours to charge fully with the battery pack installed 	
Drop Durability	1.0m (or 3.3ft)	
Dust/Water-splash proof	Complies with IEC60529, level IP54 (with all slots and connectors closed)	
Weight	Approx. 290g (or 10.2 oz) (with the battery pack installed)	
Dimensions	80 (W) X 140 (D) X 25 (H) mm (or 3.14"(W) X 5.51"(D) X 0.98"(H))	
Operating environment	Temperature: 0°C-40°C(32°F-104°F) Humidity: 10-85%	

- *1 The model is not available in the USA and Canada.
- *2 Though TFT screens are made using extremely high-grade technology, uneven brightness or fine dots sometimes occurs on these screens. Also, some dots on the screen do not light or stay continually lit. These, however, are not malfunctions.
- *3 The distance varies depending on the surrounding environment (such as walls, appliances and other sources of radio waves).
- *4 Incompatibility between devices may make it impossible to connect FIR.
- *5 Operating time and charging time using the battery pack sometimes differ from the above values depending on the operating environment and the options that are connected.
- *6 Time until 10% power remaining warning message (red title bar) appears, for a new battery (normal temperature), continuous data input (60 characters input in one minute) and display in a 1:10 ratio, backlight off, CPU speed set to low power consumption.
- *7 The battery pack discharges a small amount of current for maintaining the memory even when the power is turned off.

Options List

The dedicated options shown below are available for use with the Rugged PDA.

AC Adaptor: AD-S15050AE

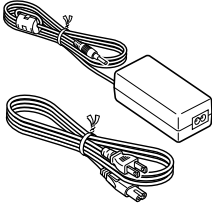

Basic Cradle: HA-C60IO

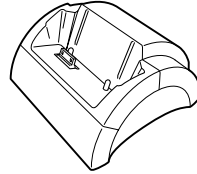

- Connect AC adaptor (AD-S15050AE) to use

Battery Pack: HA-C21BAT



Bridge Satellite Cradle: HA-C61IO

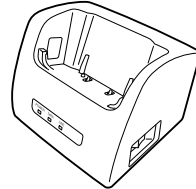

Dual Battery Chager:
HA-C32DCHG

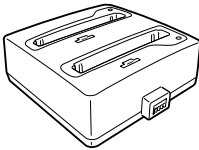

- AC adaptor is not included

AC Adaptor: AD-S42120AE

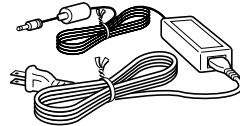

- Connect to Dual Battery Charger or Bridge Satellite Cradle to use.

Screen Protect Sheet:
HA-C90PS5B

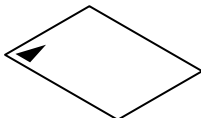

- Five sheets in one set.

Communication Card Cover:
HA-C92TCV

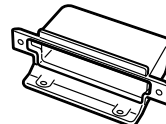

Free Manuals Download Website

<http://myh66.com>

<http://usermanuals.us>

<http://www.somanuals.com>

<http://www.4manuals.cc>

<http://www.manual-lib.com>

<http://www.404manual.com>

<http://www.luxmanual.com>

<http://aubethermostatmanual.com>

Golf course search by state

<http://golfingnear.com>

Email search by domain

<http://emailbydomain.com>

Auto manuals search

<http://auto.somanuals.com>

TV manuals search

<http://tv.somanuals.com>