

LD-50

USER'S GUIDE



P
英
LD50-E-1

CASIO®

GUIDELINES LAID DOWN BY FCC RULES FOR USE OF THE UNIT IN THE U.S.A. (not applicable to other areas).

NOTICE

This equipment has been tested and found to comply with the limits for a Class B digital device, pursuant to Part 15 of the FCC Rules. These limits are designed to provide reasonable protection against harmful interference in a residential installation. This equipment generates, uses and can radiate radio frequency energy and, if not installed and used in accordance with the instructions, may cause harmful interference to radio communications. However, there is no guarantee that interference will not occur in a particular installation. If this equipment does cause harmful interference to radio or television reception, which can be determined by turning the equipment off and on, the user is encouraged to try to correct the interference by one or more of the following measures:

- Reorient or relocate the receiving antenna.
- Increase the separation between the equipment and receiver.
- Connect the equipment into an outlet on a circuit different from that to which the receiver is connected.
- Consult the dealer or an experienced radio/TV technician for help.

FCC WARNING

Changes or modifications not expressly approved by the party responsible for compliance could void the user's authority to operate the equipment.

Welcome...

To the happy family of satisfied CASIO electronic musical instrument owners! To get the most out of the many features and functions of the instrument, be sure to carefully read this manual and keep it on hand for future reference.

Important!

Please note the following important information before using this product.

- Before using the optional AD-5 Adaptor to power the unit, be sure to check the AC Adaptor for any damage first. Carefully check the power cord for breakage, cuts, exposed wire and other serious damage. Never let children use an AC adaptor that is seriously damaged.
- Never attempt to recharge batteries.
- Do not use rechargeable batteries.
- Never mix old batteries with new ones.
- Use recommended batteries or equivalent types.
- Always make sure that positive (+) and negative (-) poles are facing correctly as indicated near the battery compartment.
- Replace batteries as soon as possible after any sign they are getting weak.
- Do not short-circuit the battery terminals.
- The product is not intended for children under 3 years.
- Use only the following CASIO AC adaptor: AD-5.
- The AC adaptor is not a toy.
- Be sure to disconnect the AC adaptor before cleaning the product.



CASIO ELECTRONICS CO., LTD.
Unit 6, 1000
North Circular Road
London NW2 7JD, U.K.

This mark is valid in the EU countries only.
Please keep all information for future reference.

Main Features

LIGHTING GUIDE SYSTEM teaches you to play by following the drum pad lights.

A circle of light around each drum pad illuminates to let you know when it's time to strike the pad. You can select from a variety of "play levels" that let you control the number of pads that light, so you can practice at a pace that suits your skill level.

Touch Response

The volume of the sound produced is varied in accordance with how hard you strike a pad. This makes it possible to add a range of nuances to your percussion play.

50 versatile rhythms

Select from among 50 different preset rhythms, including latin, rock, jazz, and much more.

4 built-in sound effect pads

A simple operation assigns sound effects from a selection of groups: Beat, Animal, Sci-Fic, Arena, and Comedy. Used in combination with the drum pads, the sound effect pads make your performances more exciting and fun.

Informative display screen

An easy-to-understand display screen provides you with a wealth of information about the Digital Drum's operations.

Quick and easy dial operation

Simply rotate the dial to select a rhythm and to change other settings and selections.

Safety Precautions

Symbols

Various symbols are used in this user's guide and on the product itself to ensure that the product is used safely and correctly, and to prevent injury to the user and other persons as well as damage to property. Those symbols along with their meanings are shown below.

DANGER

This symbol indicates information that, if ignored or applied incorrectly, creates the danger of death or serious personal injury.

WARNING

This indication stipulates matters that have the risk of causing death or serious injury if the product is operated incorrectly while ignoring this indication.

CAUTION

This indication stipulates matters that have the risk of causing injury as well as matters for which there is the likelihood of occurrence of physical damage only if the product is operated incorrectly while ignoring this indication.

Symbol Examples



This triangle symbol (\triangle) means that the user should be careful. (The example at left indicates electrical shock caution.)



This circle with a line through it (\odot) means that the indicated action must not be performed. Indications within or nearby this symbol are specifically prohibited. (The example at left indicates that disassembly is prohibited.)



The black dot (\bullet) means that the indicated action must be performed. Indications within this symbol are actions that are specifically instructed to be performed. (The example at left indicates that the power plug must be unplugged from the electrical socket.)

DANGER

Alkaline Batteries

Perform the following steps immediately if fluid leaking from alkaline batteries ever gets into your eyes. 

1. Do not rub your eyes! Rinse them with water.
2. Contact your physician immediately. Leaving alkaline battery fluid in your eyes can lead to loss of sight.

WARNING



Smoke, Strange Odor, Overheating

Continued use of the product while it is emitting smoke, a strange odor, or heat creates the risk of fire and electric shock. Take the following steps immediately.

1. Turn off power.
2. If you are using the AC adaptor for power, unplug it from the wall outlet.
3. Contact your original retailer or an authorized CASIO Service Provider.



AC Adaptor

Misuse of the AC adaptor creates the risk of fire and electric shock. Always make sure you observe the following precautions.

- Be sure to use only the AC adaptor that is specified for this product.
 - Use only a power source whose voltage is within the rating marked on the AC adaptor.
 - Do not overload electrical outlets and extension cords.
- 
- 

AC Adaptor

Misuse of the AC adaptor's electric cord can damage or break it, creating the risk of fire and electric shock. Always make sure you observe the following precautions.

- Never place heavy objects on the cord or subject it to heat.
 - Never try to modify the cord or subject it to excessive bending.
 - Never twist or stretch the cord.
 - Should the electric cord or plug become damaged, contact your original retailer or authorized CASIO Service Provider.
- 
- 

AC Adaptor

Never touch the AC adaptor while your hands are wet. Doing so creates the risk of electric shock.



Batteries

Misuse of batteries can cause them to leak, resulting in damage to nearby objects, or to explode, creating the risk of fire and personal injury. Always make sure you observe the following precautions.

- Never try to take batteries apart or allow them to become shorted.
- Never expose batteries to heat or dispose of them by incineration.
- Never mix old batteries with new ones.
- Never mix batteries of different types.
- Do not charge the batteries.
- Make sure the positive (+) and negative (-) ends of the batteries are facing correctly.



Do not incinerate the product.

Never throw the product into fire. Doing so can cause it to explode, creating the risk of fire and personal injury.



Water and Foreign Matter

Water, other liquids, and foreign matter (such as pieces of metal) getting into the product create the risk of fire and electric shock. Take the following steps immediately.

1. Turn off power.
2. If you are using the AC adaptor for power, unplug it from the wall outlet.
3. Contact your original retailer or an authorized CASIO Service Provider.



Disassembly and Modification

Never try to take this product apart or modify it in any way. Doing so creates the risk of electric shock, burn injury, or other personal injury. Leave all internal inspection, adjustment, and maintenance up to your original retailer or authorized CASIO Service Provider.



Dropping and Impact

Continued use of this product after it has been damaged by dropping or subjecting it to strong impact creates the risk of fire and electric shock. Take the following steps immediately.

1. Turn off power.
2. If you are using the AC adaptor for power, unplug it from the wall outlet.
3. Contact your original retailer or an authorized CASIO Service Provider.



Plastic Bags

Never place the plastic bag the product comes in over your head or in your mouth. Doing so creates the risk of suffocation. Particular care concerning this precaution is required where small children are present.



Location

Avoid locating the product on an unstable stand, on an uneven surface, or any other unstable location. An unstable location can cause the product to fall over, creating the risk of personal injury.



CAUTION

AC Adaptor

Misuse of the AC adaptor creates the risk of fire and electric shock. Always make sure you observe the following precautions.

- Do not locate the electric cord near a stove or other sources of heat.
- Never pull on the cord when unplugging from the electrical outlet. Always grasp the AC adaptor when unplugging.



AC Adaptor

Misuse of the AC adaptor creates the risk of fire and electric shock. Always make sure you observe the following precautions.

- Insert the AC adaptor into the wall outlet as far as it will go.
- Unplug the AC adaptor from the wall outlet during lightening storms or before leaving on a trip or other long-term absence.
- At least once a year, unplug the AC adaptor from the wall outlet and wipe away any dust that is built up in the area around the prongs of the plug.



Relocating the Product

Before relocating the product, always unplug the AC adaptor from the wall outlet and disconnect all other cables and connecting cords. Leaving cords connected creates the risk of damage to the cords, fire, and electric shock.



Cleaning

Before cleaning the product, always unplug the AC adaptor from the wall outlet first. Leaving the AC adaptor plugged in creates the risk of damage to the AC adaptor, fire, and electric shock.



Batteries

Misuse of batteries can cause them to leak, resulting in damage to nearby objects, or to explode, creating the risk of fire and personal injury. Always make sure you observe the following precautions.

- Use only batteries that are specified for use with this product.
- Remove batteries from the product if you do not plan to use it for a long time.



Connectors

Connect only the specified devices and equipment to the product's connectors. Connection of a non-specified device or equipment creates the risk of fire and electric shock.



Location

Avoid the following locations for this product. Such locations create the risk of fire and electric shock.

- Areas subject to high humidity or large amounts of dust
- In food preparation areas or other areas subject to oil smoke
- Near air conditioning equipment, on a heated carpet, in areas exposed to direct sunlight, inside of a vehicle parked in the sun, or any other area that subjects the product to high temperatures



Display Screen

- Never push on the display screen's LCD panel or subject it to strong impact. Doing so can cause the LCD panel's glass to crack, creating the risk of personal injury.
- Should the LCD panel ever crack or break, never touch the liquid inside of the panel. LCD panel liquid can cause skin irritation.
- Should LCD panel liquid ever get inside your mouth, immediately wash out your mouth with water and contact your physician.
- Should LCD panel liquid ever get into your eyes or onto your skin, rinse with clear water for at least 15 minutes, and then contact a physician.



Sound Volume

Do not listen to music at very loud volumes for long periods. Particular care concerning this precaution is required when using headphones. High volume settings can damage your hearing.



Heavy Objects

Never place heavy object on top of the product.

Doing so can make the product top heavy, causing the product to tip over or the object to fall from it, creating the risk of personal injury.



Care of your Instrument

Avoid heat, humidity or direct sunlight.

Do not overexpose the instrument to direct sunlight, or place it near an air conditioner, or in any extremely hot place.

Do not use near a TV or radio.

This instrument can cause video or audio interference with TV and radio reception. If this happens, move the instrument away from the TV or radio.

Do not use lacquer, thinner or similar chemicals for cleaning.

Clean the instrument with a soft cloth dampened in a weak solution of water and a neutral detergent. Soak the cloth in the solution and squeeze until it is almost dry.

Avoid use in areas subjected to temperature extremes.

Extremely high or low temperature can cause figures on the LCD screen to become dim and difficult to read. This condition should correct itself when the instrument is brought back to normal temperature.

Important!

When using batteries, be sure to replace them or shift to one of the alternate power sources whenever you notice any of the following symptoms.

- Instrument does not turn on
- Dim, difficult to read display
- Abnormally low speaker/headphone volume
- Distortion of sound output
- Occasional interruption of sound when playing at high volume
- Sudden power failure when playing at high volume
- Dimming of the display when playing at high volume
- Abnormal rhythm pattern and demo tune play
- Dimming of digital drum lights when notes sound

Contents

Welcome.....	E-1	Other Settings.....	E-18
Main Features	E-2	Using the LIGHTING GUIDE SYSTEM	E-18
Safety Precautions	E-3	Selecting a Play Level	E-19
Care of your Instrument.....	E-6	Selecting a Sound Effect Set	E-20
Contents.....	E-7	Selecting a Drum Set.....	E-20
General Guide.....	E-8	Configuring a User Drum Set	E-21
Control Panel	E-8	Selecting an Effect	E-22
Top	E-9	Troubleshooting	E-23
Back	E-9	Specifications	E-24
Display	E-10	Appendix	A-1
Connections.....	E-11	Percussion Sound List	A-1
Phones/Output Jack	E-11	Sound Effect List	A-2
Accessories and Options	E-11	Drum Set List	A-2
Power Supply.....	E-12	Rhythm and Auto Drum Kit List	A-3
Using Batteries	E-12		
Using the AC Adaptor	E-13		
Low Battery Icon	E-13		
Basic Operations.....	E-14		
Getting Ready	E-14		
Adjusting the Main Volume	E-14		
Playing the Demo Song	E-14		
Using Rhythms	E-15		
Selecting a Rhythm.....	E-15		
Adjusting Rhythm Volume	E-15		
Starting and Stopping Rhythm Play	E-16		
Using Synchro Start.....	E-16		
Adjusting the Rhythm Tempo	E-17		

General Guide

- Key, button, and other names are indicated in the text of this manual using bold type.

■ Control Panel

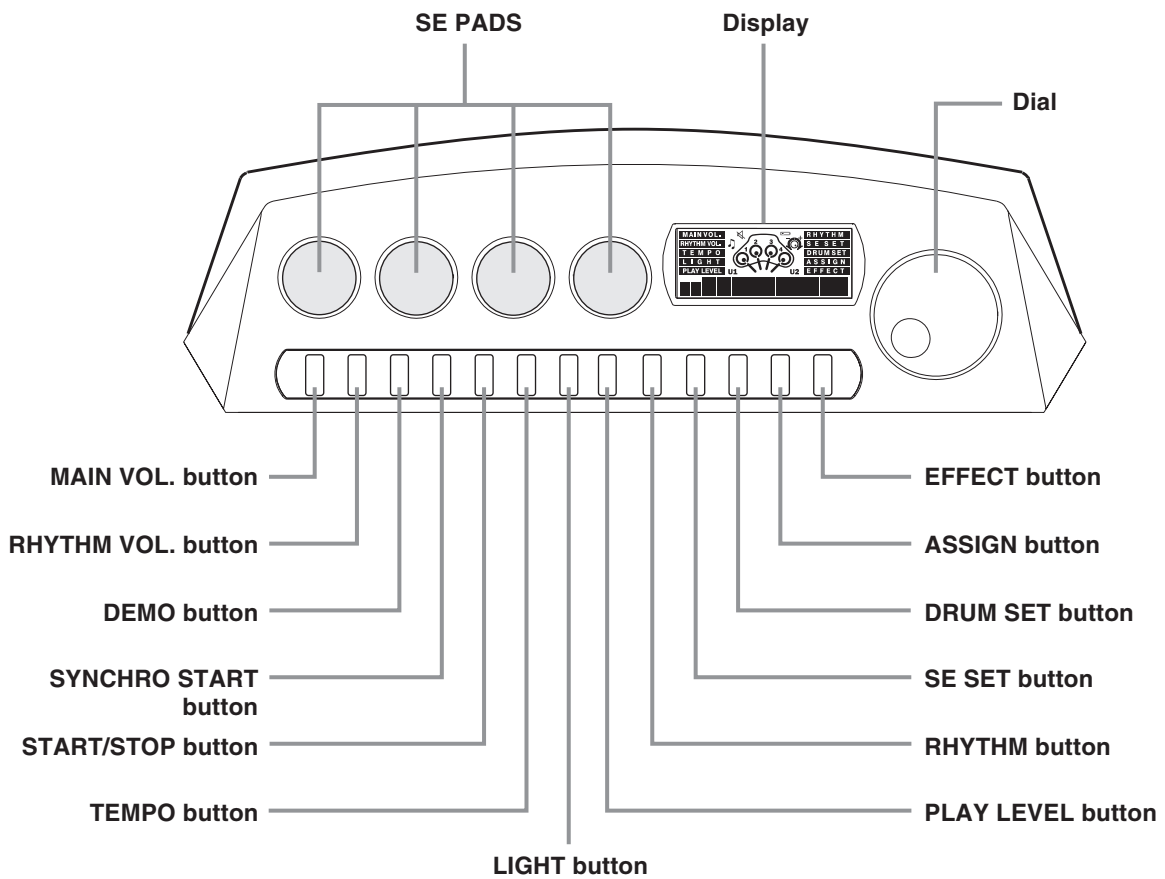

■ Top

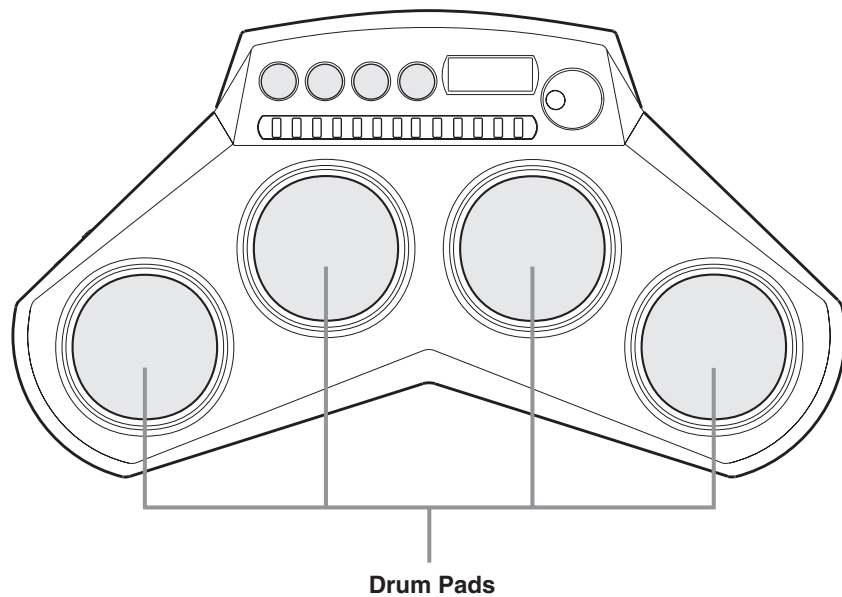

■ Back

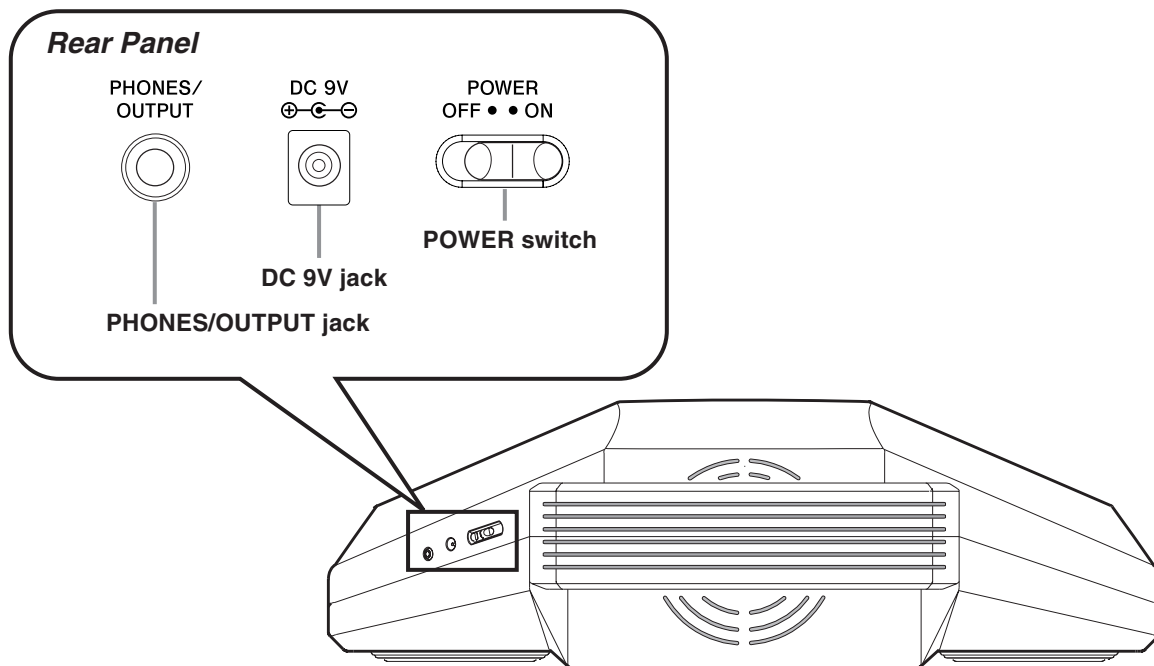

■ Display

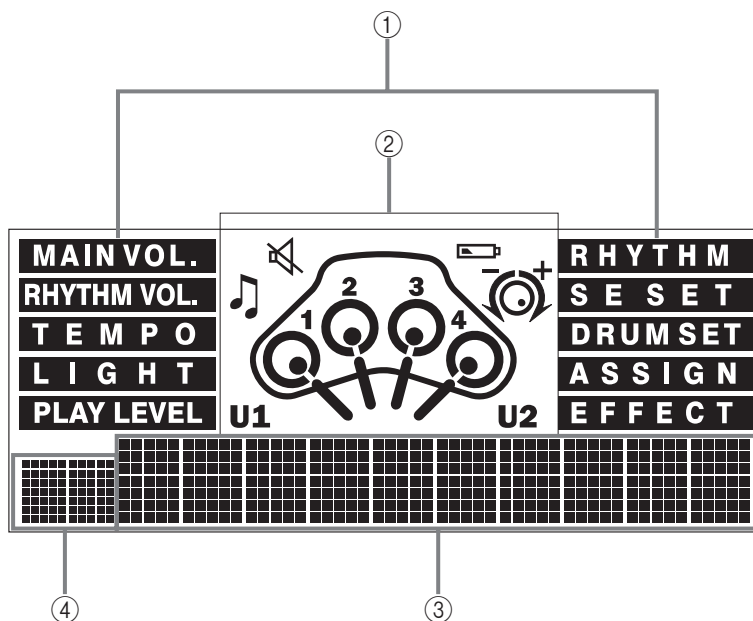

- ① MAIN VOL., RHYTHM VOL., TEMPO, LIGHT, PLAY LEVEL, RHYTHM, SE SET, DRUM SET, ASSIGN, and EFFECT are screen indicators that appear whenever you are using one of the applicable functions.
- ②
 - Icons appear in this area to indicate demo play, rhythm play, muting, and low battery warning.
 - A dial icon appears when you are performing an operation whose setting can be made using the dial. Drum animations also appear while you are using the LIGHTING GUIDE SYSTEM mode.
 - The U1 and U2 indicators appear when you configure one of the user drum sets.
- ③ This area is used to display rhythm names, drum set names, and other text.
- ④ This area shows rhythm numbers, tempo setting values, and other numeric information.

■ NOTE

- Display examples shown in this User's Guide are intended for illustrative purposes only. The actual text and values that appear on the display may differ from the examples shown in this User's Guide.

Connections

■ Phones/Output Jack

Before connecting headphones or other external equipment, be sure to first turn down the volume settings of the digital drum and the connected equipment. You can then adjust volume to the desired level after connections are complete.

Rear Panel

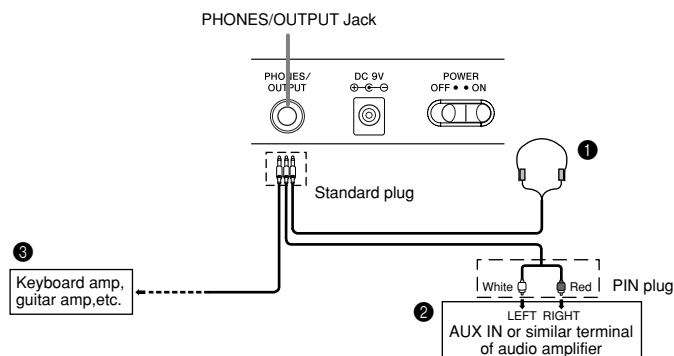

Connecting Headphones (1)

Connecting headphones cuts off output from the digital drum's built-in speaker, so you can play even late at night without disturbing anyone.

Audio Equipment (2)

Connect the digital drum to an audio equipment using a commercially available connecting cord with a standard plug on one end and two PIN plugs on the other end. In this configuration, you normally set the input selector of the audio equipment to the terminal (usually marked AUX IN or something similar) where the cord from the digital drum is connected. See the user documentation that comes with your audio equipment for full details.

Musical Instrument Amplifier (3)

Use a commercially available connecting cord to connect the digital drum to a musical instrument amplifier.

■ NOTE

- Be sure to use a connecting cord that has standard plugs on the ends you connect to the digital drum and amplifier.

Connection Example

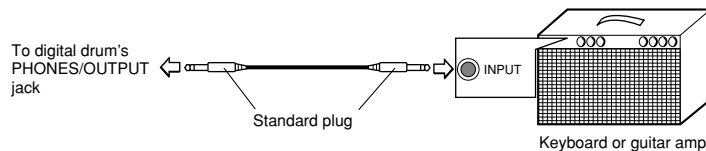

■ Accessories and Options

Use only the accessories and options specified for this digital drum. Use of non-authorized items creates the danger of fire, electrical shock, and personal injury.

Power Supply

This digital drum can be powered by current from a standard household wall outlet (using the specified AC adaptor) or by batteries. Always make sure you turn the digital drum off whenever you are not using it.

■ Using Batteries

Always make sure you turn off the digital drum before loading or replacing batteries.

To load batteries

1. Remove the battery compartment cover.
2. Load 6 AA-size batteries into the battery compartment.
 - Make sure that the positive (+) and negative (-) ends are facing correctly.
3. Insert the tabs on the battery compartment cover into the holes provided and close the cover.

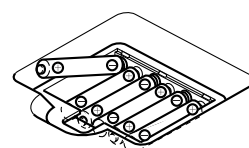

The digital drum may not function correctly if you load or replace batteries with power turned on. If this happens, turning the digital drum off and then back on again should return functions back to normal.

Important Battery Information

- The following shows the approximate battery life provided by different battery types.
 - Standard battery life: Approximately 5 hours (AM3/LR6)Both of the above values are standard battery life at normal temperature, with the digital drum volume at a medium setting. Temperature extremes or playing at very loud volume settings can shorten battery life.
- Any of the following symptoms indicate low battery power. Replace batteries as soon as possible whenever any of the following occurs.
 - Instrument does not turn on
 - Dim, difficult to read display
 - Abnormally low speaker/headphone volume
 - Distortion of sound output
 - Occasional interruption of sound when playing at high volume
 - Sudden power failure when playing at high volume
 - Dimming of the display when playing at high volume
 - Abnormal rhythm pattern and demo tune play
 - Dimming of digital drum lights when notes sound

Caution!

Improper handling of batteries can cause them to burst and leak, which creates the danger of personal injury or damage due to contact with battery acid. Be sure to note the following important precautions.

- Always make sure that the positive (+) and negative (-) poles are facing correctly as indicated inside the battery compartment.
- To avoid damage caused by leaking batteries, be sure to remove batteries from the digital drum whenever you leave it unattended for long periods (such as when leaving on a trip).
- Never mix batteries of different types.
- Never mix old batteries with new ones.
- Never discard batteries by incinerating them, do not allow their poles to be shorted (connected to each other), never take batteries apart, and do not expose batteries to direct heat.
- Replace batteries as soon as possible after any sign they are getting weak.
- Never attempt to recharge batteries.

■ Using the AC Adaptor

Make sure that you use only the AC adaptor specified for this digital drum.

Specified AC Adaptor: AD-5

Also note the following important warnings and precautions when using the AC adaptor.

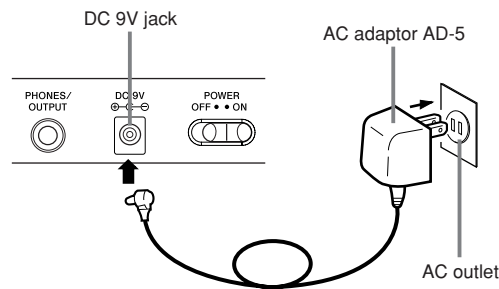

Warning!

- Take care to avoid any damage to or breakage of the power cord. Never place any heavy objects on the power cord or expose it to direct heat. Doing so creates the danger of power cord damage, fire, and electrical shock.
- Use only the specified AC adaptor. Use of another type of adaptor creates the danger of fire and electrical shock.

Caution!

- For safety sake, be sure to unplug the AC adaptor from the wall outlet whenever leaving the digital drum unattended for a long time (such as when leaving on a trip).
- Always turn off the digital drum and unplug the AC adaptor from the wall outlet when you are not using the digital drum.

Important!

- Make sure that the digital drum is turned off before connecting or disconnecting the AC adaptor.
- Using the AC adaptor for a long time can cause it to become warm to the touch. This is normal and does not indicate malfunction.

■ Low Battery Icon

A low battery icon lets you know when batteries are running low and need to be replaced.

- When the low battery icon flashes on the display, it means you need to replace batteries or switch over to AC adaptor power soon.

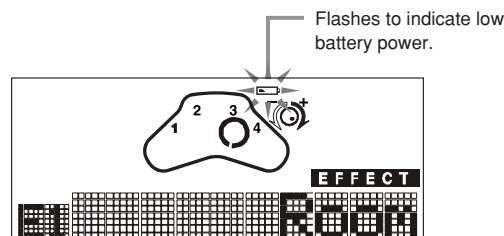

Basic Operations

This section provides the most basic information you need to get your Digital Drum running.

■ Getting Ready

To turn power on and off

Slide the POWER switch to turn power on and off.

■ Adjusting the Main Volume

The main volume controls overall volume, including non-drum sounds, background drum sounds, the sounds of the four pads, and sound effects.

1. Press the **MAIN VOL.** button.

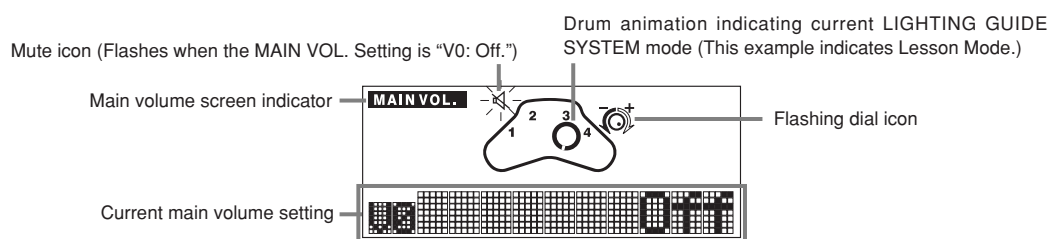

2. Rotate the dial left to decrease main volume, or right to increase it.
 - You can set the main volume in the range of V0 (mute) to V9. The initial default setting is V7.
3. After you are finished, you can press another button to change to another mode.

■ Playing the Demo Song

The demo song provides you with a demonstration of the various capabilities of your Digital Drum.

To start demo song play

1. Press the **DEMO** button.
 - You can stop demo tune play by pressing the DEMO button.
2. To exit the demo song, press **START/STOP**.
 - The following shows the default settings during demo song play.

Item	Default Setting
Drum Set	A0 : Auto
LIGHTING GUIDE SYSTEM Mode	F2 : Dual Light
Play Level	L0 : Off

Using Rhythms

This section explains how to select rhythms and control their playback.

■ Selecting a Rhythm

Use the following procedure to select from among the 50 rhythm patterns built into your Digital Drum. See “Rhythm and Auto Drum Kit List” on page A-3 for a list of available rhythms.

To select a rhythm

1. Press the **RHYTHM** button.

Drum animation indicating current LIGHTING GUIDE SYSTEM mode (This example indicates Lesson Mode.)

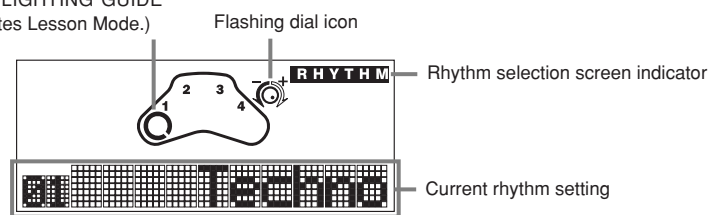

- Note that the rhythm selection screen always appears first whenever you turn on LD-50 power.

2. Rotate the dial left or right to cycle through the available rhythms until the one you want is displayed.
3. After you are finished, you can press another button to change to another mode.

■ Adjusting Rhythm Volume

Rhythm volume controls non-drum sounds and background drum sounds. It can be used to enhance the sounds assigned to the four pads and hit sounds.

To adjust rhythm volume

1. Press the **RHYTHM VOL.** button.

Drum animation indicating current LIGHTING GUIDE SYSTEM mode (This example indicates Lesson Mode.)

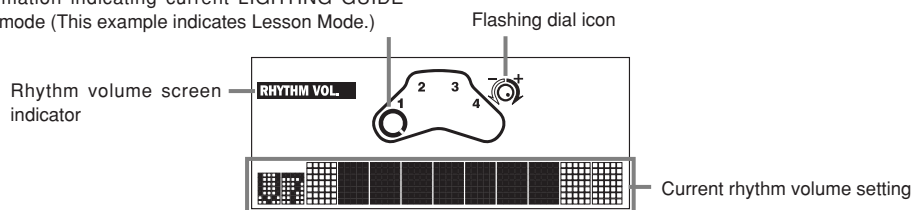

2. Rotate the dial left to decrease rhythm volume, or right to increase it.
 - You can set the rhythm volume in the range of V0 (mute) to V9. The initial default setting is V7.
3. After you are finished, you can press another button to change to another mode.

■ Starting and Stopping Rhythm Play

Perform the following steps to start and stop rhythm play.

To start and stop rhythm play

1. Select the rhythm you want to play (page E-15).
2. Press the **START/STOP** button to start rhythm play.

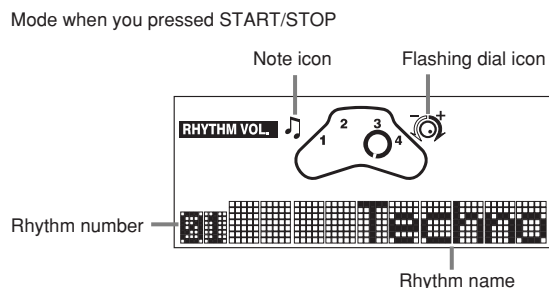

3. To stop rhythm play, press the **START/STOP** button.
 - The following shows the default settings during rhythm play.

Item	Default Setting
Drum Set	A0 : Auto
LIGHTING GUIDE SYSTEM Mode	F2 : Dual Light
Play Level	L0 : Off

■ Using Synchro Start

With synchro start, you can put your Digital Drum into standby state from which rhythm play starts automatically whenever you strike any of the drum pads.

To start rhythm play using synchro start

1. Press the **SYNCHRO START** button.

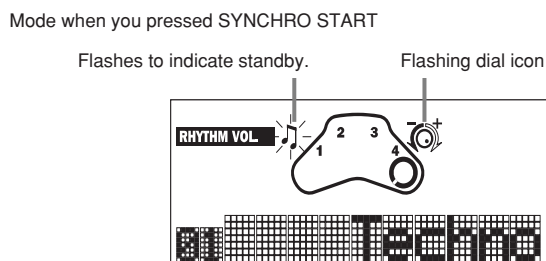

- Your Digital Drum automatically exits synchro start standby if you press any button or if you do not perform any operation for about 30 seconds.
- You can rotate the dial and change the setting of the currently display screen (RHYTHM VOL. in this example), if you want.

2. Strike any of the drum pads to start rhythm play.

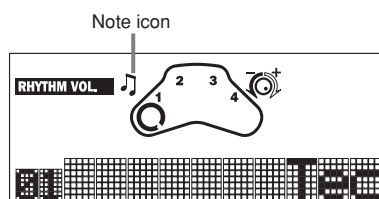

- The rhythm starts to play and the note icon stops flashing.

■ Adjusting the Rhythm Tempo

Perform the following steps to change the tempo of the rhythm. This setting also affects demo play (page E-14).

To adjust the rhythm tempo

1. Press the **TEMPO** button.

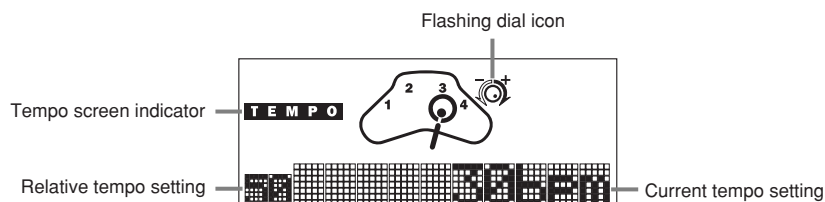

- The relative tempo setting shows how much the current tempo setting varies from the initial default setting of the selected rhythm. A setting of 00 means that the current tempo setting is the default tempo, while any other value (from 1 to 50) indicates that the tempo has been slowed down or sped up from the default.
2. Rotate the dial left to decrease tempo, or right to increase it.
 - As you do, the relative tempo setting changes accordingly. A negative relative tempo value indicates the tempo is slower than the default setting, while a positive value indicates a tempo that is faster than the default.
 3. After you are finished, you can press another button to change to another mode.

Other Settings

This section describes more advanced setting you can use to make drum pad play more enjoyable.

■ Using the LIGHTING GUIDE SYSTEM

The LIGHTING GUIDE SYSTEM of your Digital Drum lets you select from among various modes that make drum pad play more enjoyable.

To select the LIGHTING GUIDE SYSTEM mode

1. In any mode, press **LIGHT**.

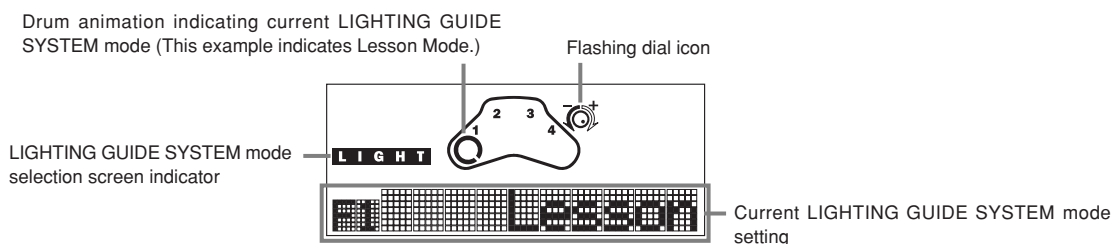

2. Rotate the dial left or right to cycle through the available LIGHTING GUIDE SYSTEM modes until the one you want is displayed.
 - The following describes what each LIGHTING GUIDE SYSTEM mode setting does.

When you want this type of pad lighting:	Select this mode:
Pads flash to let you know which one you must strike next	F1 : Lesson
Pads flash to let you know which one you must strike next, and light when you strike them	F2 : Dual Light
Pads light whenever you strike them	F3 : Synchro
Pads do not light	F4 : Off

Important!

- Note that the pads themselves do not light and flash. Instead, the rings around the pads do.

3. After you are finished, you can press another button to change to another mode.

■ Selecting a Play Level

The play level lets you control how many pads light during LIGHTING GUIDE SYSTEM lesson and dual light mode play. This means you set up the Digital Drum to allow practice that suits your own particular skill level.

To select a play level

1. While a rhythm is playing, press **PLAY LEVEL**.

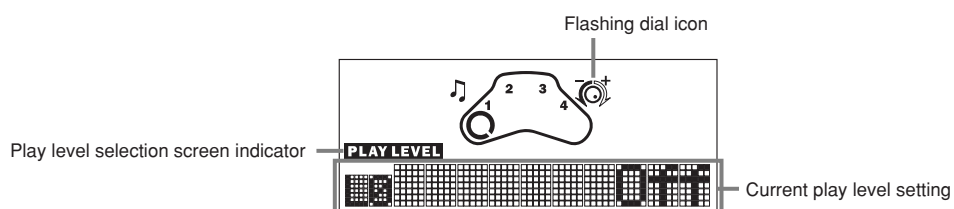

2. Rotate the dial left or right to cycle through the available play level settings until the one you want is displayed.

- The following describes what each play level setting does.

When you want to do this:	Select one of these levels:
Practice with only one pad	L1 : Pad 1 L1 : Pad 2 L1 : Pad 3 L1 : Pad 4
Practice with two pads	L2 : Pad 1 & 2 L2 : Pad 1 & 3 L2 : Pad 1 & 4 L2 : Pad 2 & 3 L2 : Pad 2 & 4 L2 : Pad 3 & 4
Practice with three pads	L3 : Pad 1 & 2 & 3 L3 : Pad 1 & 2 & 4 L3 : Pad 1 & 3 & 4 L3 : Pad 2 & 3 & 4
Practice with all four pads	L4 : 1 & 2 & 3 & 4
Turn off	L0 : Off

3. After you are finished, you can press another button to change to another mode.

■ Selecting a Sound Effect Set

The four sounds that make up the sound effect set you select are assigned to the four sound effect pads. See “Sound Effect List” on page A-2 for a list of available sound effect sets and their contents.

To select a sound effect set

1. Press the **SE SET** button.

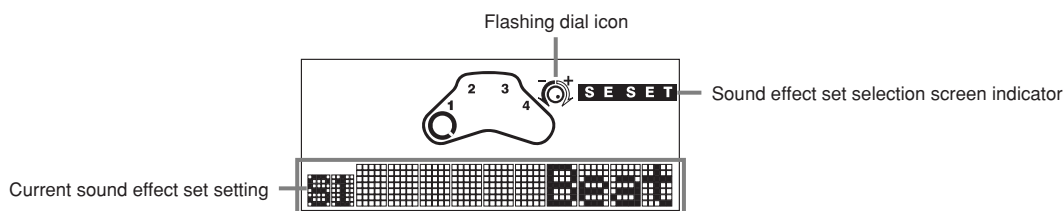

2. Rotate the dial left or right to cycle through the available sound effect sets until the one you want is displayed.
3. After you are finished, you can press another button to change to another mode.

■ Selecting a Drum Set

The four sounds that make up the drum set you select are assigned to the four drum pads. See “Drum Set List” on page A-2 for a list of available drum sets and their contents. Note that there are three basic types of drum sets.

● Auto Drum Sets

Selecting “A0 : Auto” causes drum pad assignments to change automatically to match the rhythm you select (page E-15).

● Preset Drum Sets

Selecting any one of the preset drum sets (P1 to P7) assigns the sounds for that drum set to be assigned to the drum pads.

● User Drum Sets

Selecting a user drum set (U1 or U2) assigns sounds defined by you using the procedure under “Configuring a User Drum Set” on page E-21.

To select a drum set

1. Press the **DRUM SET** button.

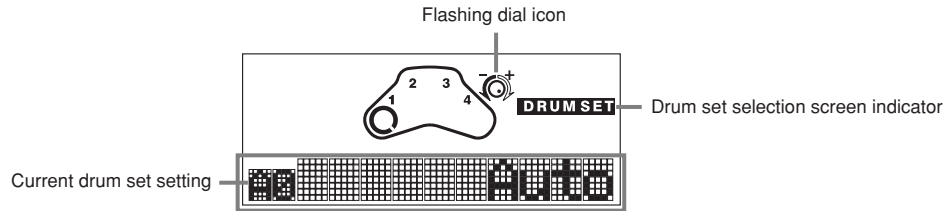

2. Rotate the dial left or right to cycle through the available drum sets until the one you want is displayed.
3. After you are finished, you can press another button to change to another mode.

■ Configuring a User Drum Set

The following procedure describes how you can configure up to two of your own drum sets that consist of the percussion sounds and sound effects you want.

After you configure a user drum set, you can select it using the procedure under “To select a drum set” on this page.

■ NOTE

- User drum sets revert to their initial factory defaults whenever your Digital Drum is turned off.
- See “Drum Set List” on page A-2 for information about the initial factory default settings of the user drum sets.

To configure a user drum set

1. In any mode, press the **ASSIGN** button.

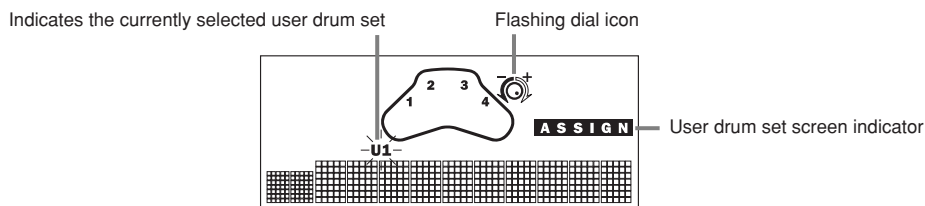

2. Rotate the dial to select either User Area 1 (U1) or User Area 2 (U2), and then press the **ASSIGN** button.

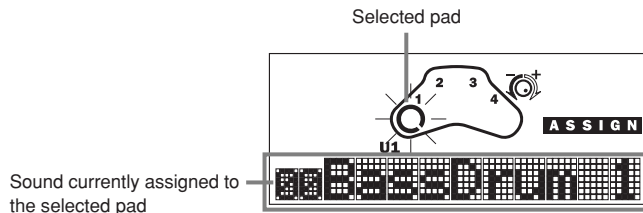

3. Rotate the dial left or right to scroll through the available percussion sounds and sound effects on the display.
 - See "Percussion Sound List" on page A-1 and "Sound Effect List" on page A-2 for information on the sounds you can assign to a drum pad.
 - You can strike the selected drum pad to sound the percussion sound or sound effect whose name is on the display.
4. When the name of the sound you want to assign to the selected drum pad is on the display, press the **ASSIGN** button to advance to the next drum pad.
5. Repeat steps 3 and 4 for the other three drum pads.
6. After you are finished, you can press another button to change to another mode.
 - You can exit the above setting procedure at any time by pressing any button other than **ASSIGN**.
 - The setting procedure will also be cancelled automatically if you do not perform any operation for about 30 seconds.

■ Selecting an Effect

The effect you select with the following procedure is applied to the percussion sounds listed under "Percussion Sound List" on page A-1.

To select an effect

1. Press the **EFFECT** button.

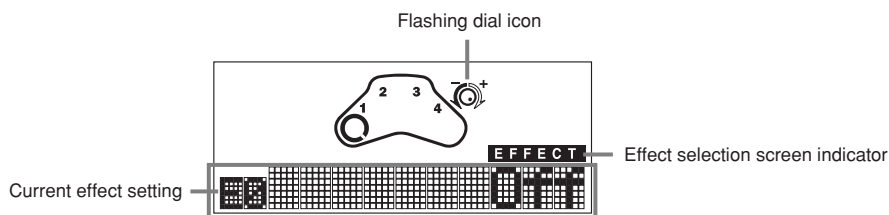

2. Rotate the dial left or right to cycle through the available effects until the one you want is displayed.
 - Available effects are E1: Room, E2: Stage, E3: Hall, and E0: Off.
3. After you are finished, you can press another button to change to another mode.

Troubleshooting

If this happens:	It could mean this:	So you should do this:	See page
No sound is produced when I strike a pad.	The Drum Set is not being supplied power.	Check that batteries are loaded correctly, or that the AC adaptor is connected properly and plugged into an electrical outlet. Check for dead batteries.	Pages E-12,13
	Drum Set power is not turned on.	Use the POWER switch to turn on power.	Page E-14
	Main volume setting is too low.	Adjust the main volume setting.	Page E-14
The Drum Set does not produce any rhythm sound.	Rhythm volume setting is too low.	Adjust the rhythm volume setting.	Page E-15
Pads do not light when I strike them.	The LIGHTING GUIDE SYSTEM setting is OFF.	Change the LIGHTING GUIDE SYSTEM setting to Synchro or Dual Light.	Page E-18
The low battery icon flashes on the display (under battery power).	Battery power is low.	Replace batteries with a full set of new ones, or use the AC adaptor for power.	Pages E-12, 13
The Drum Set emits a loud sound and then stops working (under battery power).	Battery power is low.	Replace batteries with a full set of new ones, or use the AC adaptor for power.	Pages E-12, 13
Display screen characters are dim and difficult to read (under battery power).	Battery power is low.	Replace batteries with a full set of new ones, or use the AC adaptor for power.	Pages E-12, 13

Specifications

Model:	LD-50								
Percussion Pads:	4 (with touch response)								
Lighting Guide System:	Lesson, Dual Light, Synchro								
Sounds:	47 assignable percussion sounds + 20 assignable sound effects								
Display:	MAIN VOL., RHYTHM VOL., TEMPO, LIGHT, PLAY LEVEL, RHYTHM, SE SET, DRUM SET, ASSIGN, EFFECT, U1/U2 indicators; note icon; mute icon; low battery icon; dial icon; drum animation								
Main volume:	10 levels								
Rhythm volume:	10 levels								
Rhythms:	50								
Demos:	1								
Auto Percussion Set:	In accordance with rhythms and demo								
Preset Percussion Sets:	7								
User Percussion Sets:	2 (Cleared by power off.)								
Play Level:	Rhythm or Demo (during Lesson or Dual Light mode in Auto Percussion Set)								
Tempo:	±50 levels from default value of selected rhythm or demo								
Effects:	3 types (for percussion sounds only)								
Sound Effects:	4 x 5 sets								
Rhythm Controllers:	START/STOP, SYNCHRO START, TEMPO								
Speaker:	10 cm diameter (Output: 3.0W)								
Dial:	Controls Main Vol., Rhythm Vol., Tempo, Light, Play Level, Rhythm, SE Set, Drum Set, Assign, and Effect settings.								
I/O Terminals:	<table style="width: 100%; border: none;"> <tr> <td style="width: 60%;">Power Supply:</td> <td>DC 9V jack</td> </tr> <tr> <td>Headphones/Output:</td> <td>Stereo standard jack (Output is monaural.)</td> </tr> <tr> <td>Output impedance:</td> <td>220Ω</td> </tr> <tr> <td>Output voltage:</td> <td>3.5V (RMS) MAX</td> </tr> </table>	Power Supply:	DC 9V jack	Headphones/Output:	Stereo standard jack (Output is monaural.)	Output impedance:	220Ω	Output voltage:	3.5V (RMS) MAX
Power Supply:	DC 9V jack								
Headphones/Output:	Stereo standard jack (Output is monaural.)								
Output impedance:	220Ω								
Output voltage:	3.5V (RMS) MAX								
Power Supply:	<table style="width: 100%; border: none;"> <tr> <td colspan="2">2-way AC/DC power sources;</td> </tr> <tr> <td style="padding-left: 20px;">Batteries</td> <td>6 AA-size</td> </tr> <tr> <td style="padding-left: 20px;">Battery life</td> <td>approximately 5 hours on LR6 (AM3) alkaline batteries</td> </tr> <tr> <td style="padding-left: 20px;">AC adaptor</td> <td>AD-5</td> </tr> </table>	2-way AC/DC power sources;		Batteries	6 AA-size	Battery life	approximately 5 hours on LR6 (AM3) alkaline batteries	AC adaptor	AD-5
2-way AC/DC power sources;									
Batteries	6 AA-size								
Battery life	approximately 5 hours on LR6 (AM3) alkaline batteries								
AC adaptor	AD-5								
Power Consumption:	9 V --- 7.7 W								
Dimensions:	49.5 x 28.0 x 17.0 cm (19 ⁸ / ₁₆ " x 11 ⁵ / ₁₆ " x 6 ¹¹ / ₁₆ ")								
Weight:	Approximately 2.0 kg (4.4 lbs) (without batteries)								

* Designs and specifications are subject to change without notice.

Appendix

Percussion Sound List

Type	Percussion Sound No.	Display Name
Bass Drums	01	BassDrum 2
	00	BassDrum 1
Snare Drums	05	SnareDrum2
	03	SnareDrum1
Tom Toms	15	High Tom
	10	Low Tom
	13	HighMidTom
	12	LowMidTom
	08	HiFloorTom
	06	LoFloorTom
	Hi-Hats	07
11		Open HiHat
09		PedalHiHat
Cymbals	16	Ride Cym. 1
	24	Ride Cym. 2
	14	CrashCym. 1
	22	CrashCym. 2
	17	ChineseCym
	20	Splash Cym
Percussion	28	O. Hi Conga
	29	Low Conga
	27	M. Hi Conga
	32	High Agogo
	33	Low Agogo
	34	Cabasa
	21	Cowbell
	30	Hi Timbale
	31	Lo Timbale
	04	Hand Clap
	02	Side Stick
	18	Ride Bell
	19	Tambourine
	23	Vibra-Slap
	25	High Bongo
	26	Low Bongo
	35	Maracas
	36	ShtWhistle
	37	LngWhistle
	38	ShortGuiro
	39	Long Guiro
	40	Claves
	41	Hi W. Block
42	Lo W. Block	
43	Mute Cuica	
44	Open Cuica	
45	M.Triangle	
46	O.Triangle	

Sound Effect List

Sound Effect Set No.	Sound Effect Display Name	Name	Sound Effect No.	SE PADS Assignment
S1	Beat	One	47	1
		Two	48	2
		Three	49	3
		Four	50	4
S2	Arena	Stadium	54	4
		Sing	51	1
		Whistle	53	3
		Yeah-Ha	52	2
S3	Sci-Fic	Laser Gun	55	1
		Car	56	2
		Punch	57	3
		Zip	58	4
S4	Comedy	Slide	60	2
		Eat	59	1
		Laugh	61	3
		Band Hit	62	4
S5	Animal	Crow	66	4
		Tiger	63	1
		Dog	64	2
		Horse	65	3

Drum Set List

Drum Set No.	Name	Display Name	Pad 1	Pad 2	Pad 3	Pad 4
A0	AUTO	Auto	Selected automatically in accordance with rhythm. See the "Rhythm and Auto Drum Kit List" on page A-3.			
P1	BASIC KIT	Basic Kit	BassDrum 2	SnareDrum1	Low Tom	CrashCym. 2
P2	JUNGLE KIT	Jungle Kit	BassDrum 1	SnareDrum1	High Tom	Low Tom
P3	HI-HAT DRUM KIT	Hi-Hat Kit	BassDrum 1	SnareDrum1	CloseHiHat	Open HiHat
P4	ELECTRO DRUM KIT	ElectroKit DRUM 1	BassDrum 2	SnareDrum2	Low Tom	CrashCym. 1
P5	PERCUSSION KIT 1	Perc.Kit 1	High Agogo	Low Agogo	Cowbell	ChineseCym
P6	PERCUSSION KIT 2	Perc.Kit 2	High Bongo	Low Bongo	LngWhistle	Hi W. Block
P7	EFFECT KIT	Effect Kit	Car	Laser Gun	Stadium	Eat
U1	USER 1	User 1	BassDrum 1	SnareDrum1	CloseHiHat	Ride Cym. 1
U2	USER 2	User 2	BassDrum 2	SnareDrum2	CloseHiHat	Open HiHat

NOTE

- Drum sets U1 and U2 are user drum sets, which can be changed using the procedure under "Configuring a User Drum Set" on page E-21. The above factory defaults are restored whenever power is turned off.

Rhythm and Auto Drum Kit List

RHYTHM GROUP	Perc.	Bass Drums		Snare Drums		Tom Toms					Hi-Hats			Cymbals					Percussion							
		BassDrum 2	BassDrum 1	SnareDrum2	SnareDrum1	High Tom	Low Tom	HighMidTom	LowMidTom	HiFloorTom	LoFloorTom	CloseHiHat	Open HiHat	PedalHiHat	Ride Cym. 1	Ride Cym. 2	CrashCym. 1	CrashCym. 2	ChineseCym	Splash Cym	O. Hi Conga	Low Conga	M. Hi Conga	High Agogo	Low Agogo	
TECHNO	01 TECHNO	1			2											4										
	02 EUROBEAT	1			2									3		4										
	03 FLASH	1		2												3										
	04 HIENERGY	1			2																					
	05 TECHNOPOP	1			2									3		4										
HIP-HOP	06 HIPHOP	1		2										3		4										
	07 TRIPHOP	1			2						3	4														
	08 GROOVYBOX	1			2											3										
	09 DJ SAM	1		2											3		4									
	10 RAVE		1		2									4		3										
POP	11 POP	1														4					2					
	12 BACKSTREET SOUND	1			2											3										
	13 LEISURE	1			2						3					4										
	14 DANCE FLOOR	1			2							4														
	15 ELECTRO	1			2																					
DRUMN BASS	16 DRUM'N BASS	1			2									3		4										
	17 TRANCE	1		2	3																					
	18 PSYCHO	1			3																					
HOUSE	19 AMBIENT	1		2	3											4										
	20 HOUSE	1			2						3					4										
	21 ACIDHOUSE																									
	22 DOWNTOWN	1			2			4																		
	23 CLUBDANCE	1			2																					
70'S	24 70'S	1			2									4		3										
	25 R&B		1		2									4												
	26 SOUL		1		2		3									4										
	27 FUNKY		1		2																					
	28 ROCK	1			2												4									
ROCK	29 HARDROCK		1		2																					
	30 VISUALROCK	1			2											3	4									
	31 METALZONE	1			2						3						4									
	32 GRUNGE	1		2								3					4									
	33 SAMBA																		4	2	3					
LATIN	34 ELEC SAMBA		1															4								
	35 SALSA																		4							
	36 BOSSA NOVA	1			2									3				4			3	4				
	37 TANGO	1			2							4	3													
	38 MAMBO	1			2																3	4				
	39 RHUMBA																				3	4				
	40 CHA-CHA-CHA	1																			3	4				
	41 MERENGUE	1			2																3	4				
WORLD MUSIC	42 ELEC LATIN	1			2																3	4				
	43 ACIDJAZZ	1			2																					
	44 SLOWJAZZ		1													3										
	45 ACIDFUNK		1		2																					
	46 FUSION	1			2						3						4									
WORLD MUSIC	47 WORLD MUSIC		1		2						3															
	48 COUNTRY	1			3											4										
	49 REGGAE													4												
WORLD MUSIC	50 ORIENTAL			4											3						1					
	51 DEMO																									
DEMO	00 DEMO SONG	1			2																					

RHYTHM GROUP	Perc.	Percussion																							
		Cabasa	Cowbell	Hi Timbale	Lo Timbale	Hand Clap	Side Stick	Ride Bell	Tambourine	Vibra-Slap	High Bongo	Low Bongo	Maracas	ShitWhistle	LngWhistle	ShortGuiro	Long Guiro	Claves	Hi W. Block	Lo W. Block	Mute Cuica	Open Cuica	M.Triangle	O.Triangle	
TECHNO	01 TECHNO					3																			
	02 EUROBEAT																								
	03 FLASH									4															
	04 HIENERGY							4	3																
	05 TECHNOPOP																								
HIP-HOP	06 HIPHOP																								
	07 TRIPHOP																								
	08 GROOVYBOX							4																	
	09 DJ SAM																								
	10 RAVE																								
POP	11 POP					3																			
	12 BACKSTREET SOUND								4																
	13 LEISURE																								
	14 DANCE FLOOR		3																						
	15 ELECTRO		3							4															
DRUM'N BASS	16 DRUM N BASS																								
	17 TRANCE																								4
	18 PSYCHO					2			4																
	19 AMBIENT																								
	20 HOUSE																								
HOUSE	21 ACIDHOUSE			1						4	3	2													
	22 DOWNTOWN							3																	
	23 CLUBDANCE									3															4
	24 70'S																								
	25 R&B		3																						
70'S	26 SOUL																								
	27 FUNKY		4			3																			
	28 ROCK							3																	
	29 HARDROCK							3	4																
	30 VISUALROCK																								
ROCK	31 METALZONE																								
	32 GRUNGE																								
	33 SAMBA											1													
	34 ELEC SAMBA		2								3														
	35 SALSA										2	1													
LATIN	36 BOSSA NOVA																								
	37 TANGO																								
	38 MAMBO																								
	39 RHUMBA										1	2													
	40 CHA-CHA-CHA		2																						
ACID JAZZ	41 MERENGUE																								
	42 ELEC LATIN		4			3																			
	43 ACIDJAZZ					3			4																
	44 SLOWJAZZ						2	4																	
	45 ACIDFUNK					3			4																
WORLD MUSIC	46 FUSION																								
	47 WORLD MUSIC								4																
	48 COUNTRY						2																		
	49 REGGAE						2	1	3																
	50 ORIENTAL											2													
DEMO	00 DEMO SONG		3		4																				

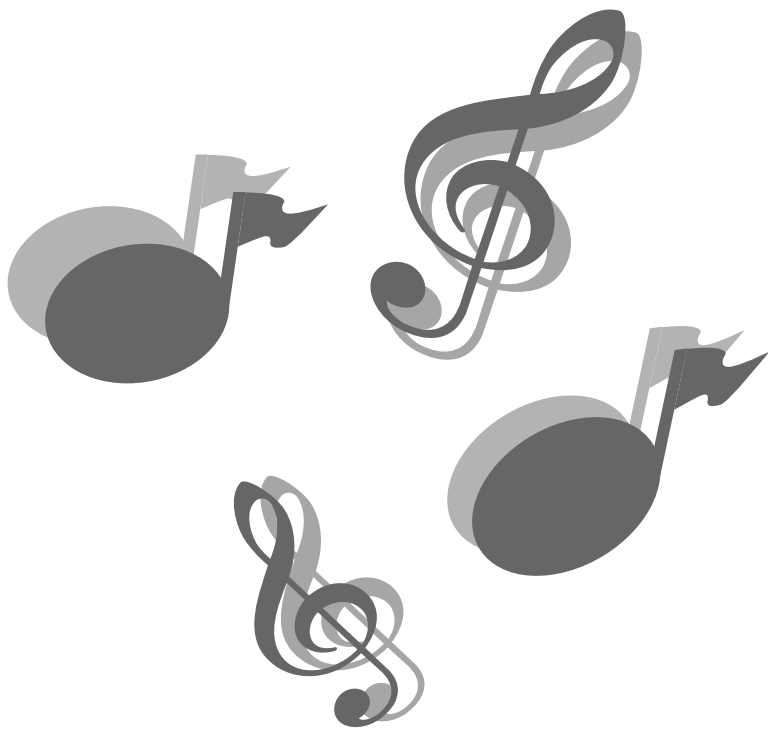
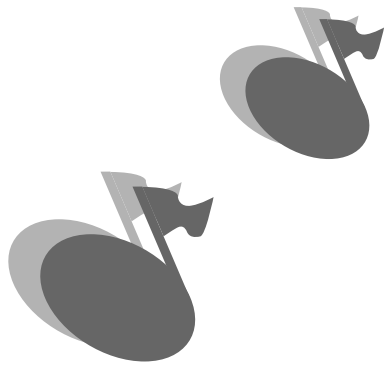



This recycle mark indicates that the packaging conforms to the environmental protection legislation in Germany.

CASIO®

CASIO COMPUTER CO.,LTD.
6-2, Hon-machi 1-chome
Shibuya-ku, Tokyo 151-8543, Japan

MA0106-A  Printed in China
LD50-E-1

Free Manuals Download Website

<http://myh66.com>

<http://usermanuals.us>

<http://www.somanuals.com>

<http://www.4manuals.cc>

<http://www.manual-lib.com>

<http://www.404manual.com>

<http://www.luxmanual.com>

<http://aubethermostatmanual.com>

Golf course search by state

<http://golfingnear.com>

Email search by domain

<http://emailbydomain.com>

Auto manuals search

<http://auto.somanuals.com>

TV manuals search

<http://tv.somanuals.com>