

CTK-810 WK-110

USER'S GUIDE
GUÍA DEL USUARIO



GUIDELINES LAID DOWN BY FCC RULES FOR USE OF THE UNIT IN THE U.S.A. (not applicable to other areas).

NOTICE

This equipment has been tested and found to comply with the limits for a Class B digital device, pursuant to Part 15 of the FCC Rules. These limits are designed to provide reasonable protection against harmful interference in a residential installation. This equipment generates, uses and can radiate radio frequency energy and, if not installed and used in accordance with the instructions, may cause harmful interference to radio communications. However, there is no guarantee that interference will not occur in a particular installation. If this equipment does cause harmful interference to radio or television reception, which can be determined by turning the equipment off and on, the user is encouraged to try to correct the interference by one or more of the following measures:

- Reorient or relocate the receiving antenna.
- Increase the separation between the equipment and receiver.
- Connect the equipment into an outlet on a circuit different from that to which the receiver is connected.
- Consult the dealer or an experienced radio/TV technician for help.

FCC WARNING

Changes or modifications not expressly approved by the party responsible for compliance could void the user's authority to operate the equipment.

Declaration of Conformity

Model Number: CTK-810/WK-110

Trade Name: CASIO COMPUTER CO., LTD.

Responsible party: CASIO, INC.

Address: 570 MT. PLEASANT AVENUE, DOVER, NEW JERSEY 07801

Telephone number: 973-361-5400

This device complies with Part 15 of the FCC Rules, Operation is subject to the following two conditions:

(1) This device may not cause harmful interference, and (2) this device must accept any interference received, including interference that may cause undesired operation.

Important!

Please note the following important information before using this product.

- Before using the optional AD-5 Adaptor to power the unit, be sure to check the AC Adaptor for any damage first. Carefully check the power cord for breakage, cuts, exposed wire and other serious damage. Never let children use an AC adaptor that is seriously damaged.
- Never attempt to recharge batteries.
- Do not use rechargeable batteries.
- Never mix old batteries with new ones.
- Use recommended batteries or equivalent types.
- Always make sure that positive (+) and negative (-) poles are facing correctly as indicated near the battery compartment.
- Replace batteries as soon as possible after any sign they are getting weak.
- Do not short-circuit the battery terminals.
- The product is not intended for children under 3 years.
- Use only CASIO AD-5 adaptor.
- The AC adaptor is not a toy.
- Be sure to disconnect the AC adaptor before cleaning the product.



This mark applies in EU countries only.



CASIO Europe GmbH
Bornbarch 10, 22848 Norderstedt, Germany

Safety Precautions

Congratulations on your selection of the CASIO electronic musical instrument.

- Before using the instrument, be sure to carefully read through the instructions contained in this manual.
- Please keep all information for future reference.

Symbols

Various symbols are used in this user's guide and on the product itself to ensure that the product is used safely and correctly, and to prevent injury to the user and other persons as well as damage to property. Those symbols along with their meanings are shown below.

DANGER

This symbol indicates information that, if ignored or applied incorrectly, creates the danger of death or serious personal injury.

WARNING

This indication stipulates matters that have the risk of causing death or serious injury if the product is operated incorrectly while ignoring this indication.

CAUTION

This indication stipulates matters that have the risk of causing injury as well as matters for which there is the likelihood of occurrence of physical damage only if the product is operated incorrectly while ignoring this indication.

Symbol Examples



This triangle symbol (\triangle) means that the user should be careful. (The example at left indicates electrical shock caution.)



This circle with a line through it (\odot) means that the indicated action must not be performed. Indications within or nearby this symbol are specifically prohibited. (The example at left indicates that disassembly is prohibited.)



The black dot (\bullet) means that the indicated action must be performed. Indications within this symbol are actions that are specifically instructed to be performed. (The example at left indicates that the power plug must be unplugged from the electrical socket.)

DANGER

Alkaline Batteries

Perform the following steps immediately if fluid leaking from alkaline batteries ever gets into your eyes. 

1. Do not rub your eyes! Rinse them with water.
 2. Contact your physician immediately.
- Leaving alkaline battery fluid in your eyes can lead to loss of sight.





WARNING



Smoke, Strange Odor, Overheating

Continued use of the product while it is emitting smoke, a strange odor, or heat creates the risk of fire and electric shock. Take the following steps immediately.

1. Turn off power.
2. If you are using the AC adaptor for power, unplug it from the wall outlet.
3. Contact your original retailer or an authorized CASIO Service Provider.

AC Adaptor

- Misuse of the AC adaptor creates the risk of fire and electric shock. Always make sure you observe the following precautions.
 - Be sure to use only the AC adaptor that is specified for this product.
 - Use only a power source whose voltage is within the rating marked on the AC adaptor. 
 - Do not overload electrical outlets and extension cords. 
- Misuse of the AC adaptor's electric cord can damage or break it, creating the risk of fire and electric shock. Always make sure you observe the following precautions.
 - Never place heavy objects on the cord or subject it to heat. 
 - Never try to modify the cord or subject it to excessive bending.
 - Never twist or stretch the cord.
 - Should the electric cord or plug become damaged, contact your original retailer or authorized CASIO Service Provider. 

- Never touch the AC adaptor while your hands are wet. Doing so creates the risk of electric shock. 
- Use the AC adaptor where it will not be splashed with water. Water creates the risk of fire and electric shock. 
- Do not place a vase or any other container filled with liquid on top of the AC adaptor. Water creates the risk of fire and electric shock. 

Batteries

Misuse of batteries can cause them to leak, resulting in damage to nearby objects, or to explode, creating the risk of fire and personal injury. Always make sure you observe the following precautions.

- Never try to take batteries apart or allow them to become shorted. 
- Never expose batteries to heat or dispose of them by incineration.
- Never mix old batteries with new ones.
- Never mix batteries of different types.
- Do not charge the batteries.
- Make sure the positive (+) and negative (-) ends of the batteries are facing correctly.

Do not incinerate the product.

Never throw the product into fire. Doing so can cause it to explode, creating the risk of fire and personal injury. 

Water and Foreign Matter

Water, other liquids, and foreign matter (such as pieces of metal) getting into the product create the risk of fire and electric shock. Take the following steps immediately. 

1. Turn off power.
2. If you are using the AC adaptor for power, unplug it from the wall outlet.
3. Contact your original retailer or an authorized CASIO Service Provider.

Disassembly and Modification

Never try to take this product apart or modify it in any way. Doing so creates the risk of electric shock, burn injury, or other personal injury. Leave all internal inspection, adjustment, and maintenance up to your original retailer or authorized CASIO Service Provider. 

Dropping and Impact

Continued use of this product after it has been damaged by dropping or subjecting it to strong impact creates the risk of fire and electric shock. Take the following steps immediately.



1. Turn off power.
2. If you are using the AC adaptor for power, unplug it from the wall outlet.
3. Contact your original retailer or an authorized CASIO Service Provider.

Plastic Bags

Never place the plastic bag the product comes in over your head or in your mouth. Doing so creates the risk of suffocation. Particular care concerning this precaution is required where small children are present.



Keep off of the product and stand.*

Climbing onto the product or stand can cause it to tip over or become damaged. Particular care concerning this precaution is required where small children are present.



Location

Avoid locating the product on an unstable stand, on an uneven surface, or any other unstable location. An unstable location can cause the product to fall over, creating the risk of personal injury.



⚠ CAUTION

AC Adaptor

- Misuse of the AC adaptor creates the risk of fire and electric shock. Always make sure you observe the following precautions.
 - Do not locate the electric cord near a stove or other sources of heat.
 - Never pull on the cord when unplugging from the electrical outlet. Always grasp the AC adaptor when unplugging.
- Misuse of the AC adaptor creates the risk of fire and electric shock. Always make sure you observe the following precautions.
 - Insert the AC adaptor into the wall outlet as far as it will go.
 - Unplug the AC adaptor from the wall outlet during lightening storms or before leaving on a trip or other long-term absence.
 - To keep dust from building up in the area between the prongs of the power plug, unplug it from the power outlet and use a dry cloth or vacuum cleaner to remove dust at least once a year.
 - Never use detergent to clean the power cord, especially the plug and jack parts.



Relocating the Product

Before relocating the product, always unplug the AC adaptor from the wall outlet and disconnect all other cables and connecting cords. Leaving cords connected creates the risk of damage to the cords, fire, and electric shock.



Cleaning

Before cleaning the product, always unplug the AC adaptor from the wall outlet first. Leaving the AC adaptor plugged in creates the risk of damage to the AC adaptor, fire, and electric shock.



Batteries

Misuse of batteries can cause them to leak resulting in damage to nearby objects, or to explode, creating the risk of fire and personal injury. Always make sure you observe the following precautions.

- Use only batteries that are specified for use with this product.
- Remove batteries from the product if you do not plan to use it for a long time.

Connectors

Connect only the specified devices and equipment to the product's connectors. Connection of a non-specified device or equipment creates the risk of fire and electric shock.



Location

Avoid the following locations for this product. Such locations create the risk of fire and electric shock.



- Areas subject to high humidity or large amounts of dust.
- In food preparation areas or other areas subject to oil smoke.
- Near air conditioning equipment, on a heated carpet, in areas exposed to direct sunlight, inside of a vehicle parked in the sun, or any other area that subjects the product to high temperatures.

Display Screen

- Never push on the display screen's LCD panel or subject it to strong impact. Doing so can cause the LCD panel's glass to crack, creating the risk of personal injury.
- Should the LCD panel ever crack or break, never touch the liquid inside of the panel. LCD panel liquid can cause skin irritation.
- Should LCD panel liquid ever get inside your mouth, immediately wash out your mouth with water and contact your physician.
- Should LCD panel liquid ever get into your eyes or onto your skin, rinse with clear water for at least 15 minutes, and then contact a physician.



Sound Volume

Do not listen to music at very loud volumes for long periods. Particular care concerning this precaution is required when using headphones. High volume settings can damage your hearing.



Heavy Objects

Never place heavy object on top of the product.

Doing so can make the product top heavy, causing the product to tip over or the object to fall from it, creating the risk of personal injury.



Correct Stand* Assembly

An incorrectly assembled stand can tip over, causing the product to fall and creating the risk of personal injury.



Make sure you assemble the stand correctly, following the assembly instructions that come with it. Make sure you mount the product on the stand correctly.

* Stand is available as an option.

IMPORTANT!

When using batteries, be sure to replace them or shift to one of the alternate power sources whenever you notice any of the following symptoms.

- Dim power supply indicator
- Instrument does not turn on.
- Dim, difficult to read display
- Abnormally low speaker/headphone volume
- Distortion of sound output
- Occasional interruption of sound when playing at high volumes
- Sudden power failure when playing at high volumes
- Dimming of the display when playing at high volume
- Continued sound output even after you release a key
- A totally different tone may sound
- Abnormal rhythm pattern and demo tune play

Company and product names used in this manual may be registered trademarks of others.



Main Features

❑ 515 tones

A wide selection of tones includes stereo piano and synthesized sounds, drum sets, and much more. Other features include digital effects that control the acoustical characteristic of tones.

❑ PIANO SETTING button

The press of a button optimizes the keyboard setup for piano play.

❑ 3-Step Lesson System

- 3-Step Lesson System: Now you can learn the parts that make up the keyboard's built-in tunes and SMF data you download over the Internet step-by-step. Guidance that appears on the monitor screen helps lead you down the path to music proficiency.
- Evaluation System: The keyboard can be configured to evaluate your 3-Step Lesson progress. You can even have the keyboard display your points, both part way through and at the end of a lesson.

❑ 100 built-in tunes

❑ 120 rhythms

A selection of rhythms cover rock, pops, jazz and just about any other musical style imaginable.

❑ Auto Accompaniment

Simply play a chord and the corresponding rhythm, bass, and chord parts play along automatically. One Touch Presets instantly recalls the most suitable tone and tempo settings to match the rhythm you are using.

❑ Registration Memory

Keyboard setups can be stored in memory for later recall and instant settings whenever you need them. Up to 32 setups (4 setups × 8 banks) can be stored in registration memory.

❑ Recording and Play Back

With lesson recording you can record as you play along with built-in tunes for later playback. Performance recording lets you record your performances, including Auto Accompaniment, in real time.

❑ Storing and Playing Back Tune Data You Transferred from Your Computer

You can connect your keyboard to a computer, use special CASIO conversion software to convert SMF data you purchase or create to CASIO format, and then transfer it to the keyboard.



Contents

Safety Precautions E-1

Main Features E-5

General Guide E-8

Attaching the Score Stand E-12

Quick Reference E-13

To play the keyboard E-13

Power Supply E-15

Using batteries E-15

Using the AC Adaptor E-16

Auto Power Off E-17

Memory Contents E-17

Connections E-18

Phones/Output Terminal E-18

Connecting to a Computer or Other
Equipment E-18

Sustain/Assignable jack Terminal E-19

Accessories and Options E-19

Basic Operations E-20

To play the keyboard E-20

Selecting a Tone E-20

Using Tone Effects E-21

PIANO SETTING Button E-21

Playing a Built-in Tune E-22

To play back a Song Bank tune E-22

Adjusting the Tempo E-23

To pause playback E-23

To fast reverse E-23

To fast forward E-23

Looping a Musical Phrase E-24

To change the melody tone E-24

To play all tunes in succession E-24

3-Step Lesson E-25

Evaluation Mode E-26

Using the Lesson Functions and
Evaluation Mode E-26

Step 1 – Master the timing. E-27

Step 2 – Master the notes. E-27

Step 3 – Play at normal speed. E-28

Evaluating Your Keyboard Play E-28

Voice Fingering Guide E-29

Using the Metronome E-29

Auto Accompaniment E-30

Selecting a Rhythm E-30

Playing a Rhythm E-31

Adjusting the Tempo E-31

Using Auto Accompaniment E-31

Using an Intro Pattern E-35

Using a Fill-in Pattern E-35



Using a Rhythm Variation E-35

Using a Fill-in Pattern with a Variation
Rhythm E-35

Synchro Starting Accompaniment with
Rhythm Play E-35

Finishing with an Ending Pattern E-36

Using One-touch Preset E-36

Registration Memory E-37

Registration Memory Features E-37

To Save a Setup in Registration
Memory E-38

To Recall a Setup from Registration
Memory E-38

Recording and Play Back ... E-39

Parts and Tracks E-39

Recording Play Along with a
Built-in Tune E-40

Playing Back a Lesson Recording E-41

Recording a Performance E-41

Playing Back a Performance
Recording E-43

Overdubbing a Performance
Recording E-44

Deleting a Specific Part/Track E-44

Keyboard Settings E-45

Using Layer E-45

Using Split E-45

Using Layer and Split Together E-46

Transposing the Keyboard E-47

Adjusting Accompaniment and
Song Bank Volume E-47

Using Touch Response E-48

Tuning the Keyboard E-48

**Connection to a
Computer E-49**

Connecting to a Computer E-49

Expanding the Selections in the
Song Bank Tunes E-50

Using the SMF Data on the Bundled
CD-ROM E-51

General MIDI Tone E-51

Changing the Settings E-51

Troubleshooting E-54

Specifications E-56

Operating Precautions E-57

Appendix A-1

Tone List A-1

Drum Assignment List A-5

FINGERED Chord Chart A-7

Rhythm List A-8

Song List A-9

**MIDI messages that can be sent
and received using the USB port**

General Guide

CTK-810

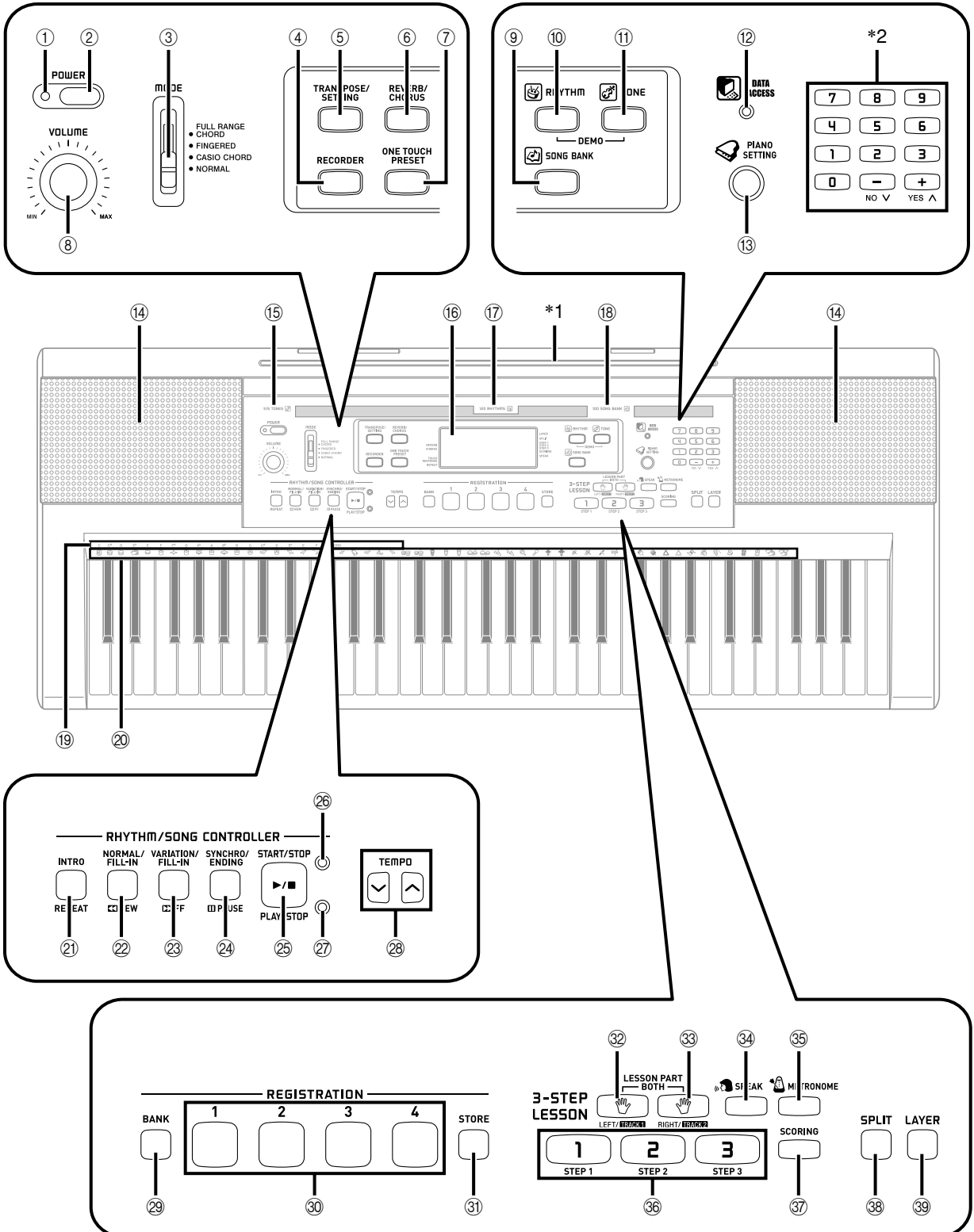



- ① Power indicator
- ② POWER button
- ③ MODE switch
- ④ RECORDER button
- ⑤ TRANSPOSE/SETTING button
- ⑥ REVERB/CHORUS button
- ⑦ ONE TOUCH PRESET button
- ⑧ VOLUME knob
- ⑨ SONG BANK button
- ⑩ RHYTHM button
- ⑪ TONE button
- ⑫ DATA ACCESS lamp
- ⑬ PIANO SETTING button
- ⑭ Speaker
- ⑮ TONE list
- ⑯ Display
- ⑰ RHYTHM list
- ⑱ SONG BANK list
- ⑲ CHORD root names
- ⑳ Percussion instrument list

● **RHYTHM/SONG CONTROLLER**

- ㉑ INTRO button, REPEAT button
- ㉒ NORMAL/FILL-IN button, REW button
- ㉓ VARIATION/FILL-IN button, FF button
- ㉔ SYNCHRO/ENDING button, PAUSE button
- ㉕ START/STOP button, PLAY/STOP button
- ㉖ Rhythm controller indicator
- ㉗ Song controller indicator

㉘ TEMPO buttons

- ㉙ BANK button
- ㉚ REGISTRATION buttons
- ㉛ STORE button

● **3-STEP LESSON SYSTEM**

- ㉜ LEFT/TRACK 1 button
- ㉝ RIGHT/TRACK 2 button
- ㉞ SPEAK button
- ㉟ METRONOME button
- ㊱ STEP 1 to 3 button
- ㊲ SCORING button

㊳ SPLIT button

- ㊴ LAYER button

■ WK-110

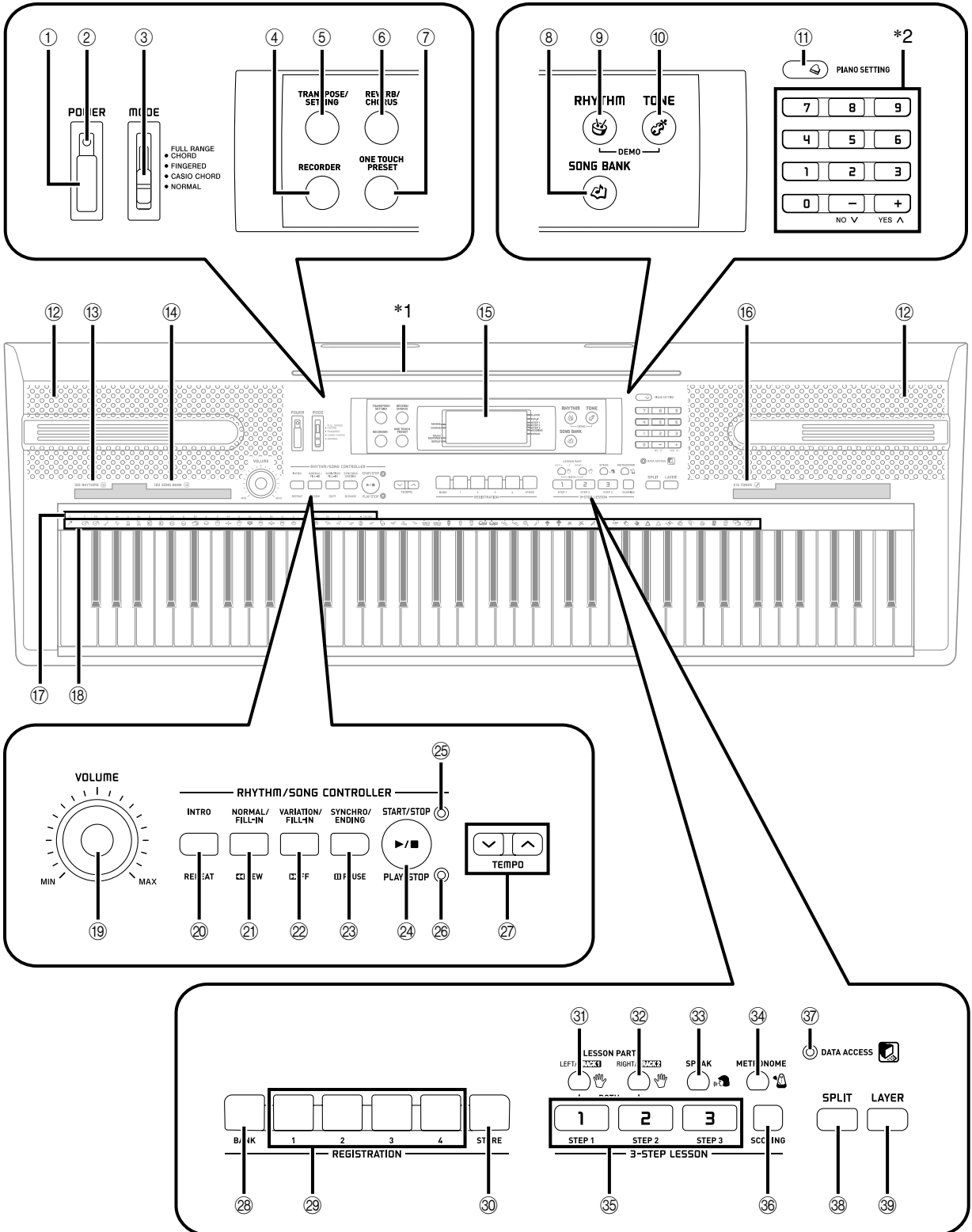



- ① POWER button
- ② Power indicator
- ③ MODE switch
- ④ RECORDER button
- ⑤ TRANSPOSE/SETTING button
- ⑥ REVERB/CHORUS button
- ⑦ ONE TOUCH PRESET button
- ⑧ SONG BANK button
- ⑨ RHYTHM button
- ⑩ TONE button
- ⑪ PIANO SETTING button
- ⑫ Speaker
- ⑬ RHYTHM list
- ⑭ SONG BANK list
- ⑮ Display
- ⑯ TONE list
- ⑰ CHORD root names
- ⑱ Percussion instrument list
- ⑲ VOLUME knob

● RHYTHM/SONG CONTROLLER

- ⑳ INTRO button, REPEAT button
- ㉑ NORMAL/FILL-IN button, REW button
- ㉒ VARIATION/FILL-IN button, FF button
- ㉓ SYNCHRO/ENDING button, PAUSE button
- ㉔ START/STOP button, PLAY/STOP button
- ㉕ Rhythm controller indicator
- ㉖ Song controller indicator
- ㉗ TEMPO buttons
- ㉘ BANK button
- ㉙ REGISTRATION buttons
- ㉚ STORE button

● 3-STEP LESSON SYSTEM

- ㉛ LEFT/TRACK 1 button
- ㉜ RIGHT/TRACK 2 button
- ㉝ SPEAK button
- ㉞ METRONOME button
- ㉟ STEP 1 to 3 button
- ㊱ SCORING button
- ㊲ DATA ACCESS lamp
- ㊳ SPLIT button
- ㊴ LAYER button

NOTE

- Illustrations in this User's Guide shows the WK-110.

*1 Attaching the Score Stand

Insert the score stand into the slot at the top of the keyboard as shown in the illustration.

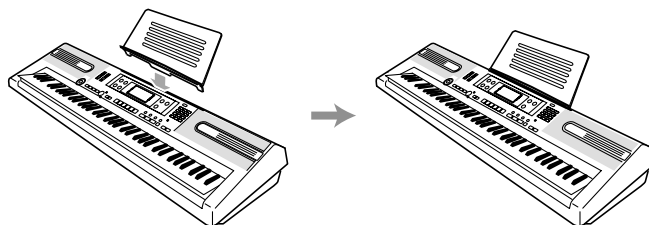

*2

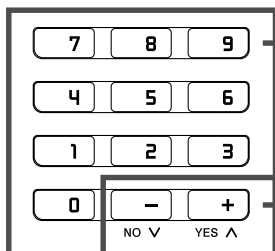

④① Number buttons

④① [+]/[-] buttons

- For input of numbers to change a displayed number or setting.
- Negative values cannot be input using the number buttons. Use [+] (increase) and [-] (decrease) instead.

Rear Panel

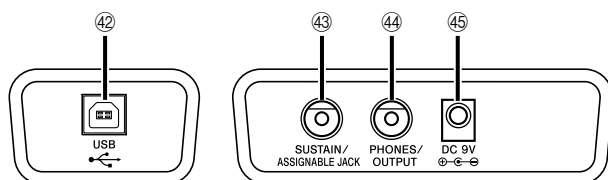

④② USB port

④③ SUSTAIN/ASSIGNABLE JACK terminal

④④ PHONES/OUTPUT terminal

④⑤ DC 9V jack

Controller Indicators

Rhythm controller indicator (CTK-810: ②⑧, WK-110: ②⑤)

Pressing the RHYTHM button to enter the Rhythm Mode causes the Rhythm controller indicator to light. This indicates that buttons ②① through ②⑤ (WK-110: ②① through ②④) are currently functioning as rhythm control buttons.

Song controller indicator (CTK-810: ②⑨, WK-110: ②⑥)

Pressing the SONG BANK button, or pressing the RHYTHM and TONE buttons at the same time to start demo tune play causes the Song controller indicator to light. This indicates that buttons ②① through ②⑤ (WK-110: ②① through ②④) are currently functioning as playback control buttons.

NOTE

- Display examples shown in this User's Guide are intended for illustrative purposes only. The actual text and values that appear on the display may differ from the examples shown in this User's Guide.
- Viewing a liquid crystal display screen from an angle can change the appearance of display contrast. The display contrast of this keyboard is set to allow easy viewing for a person seated on a chair in front of the keyboard. Note that display contrast is fixed, and cannot be adjusted.

Quick Reference

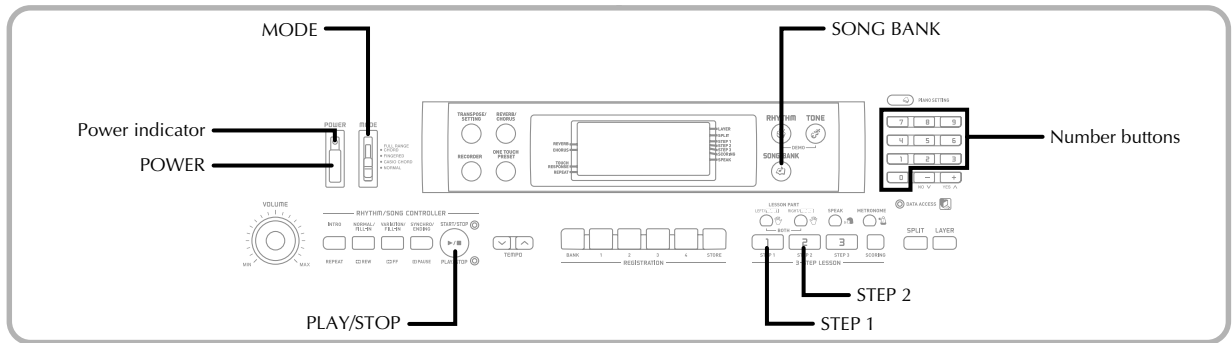

This section provides a quick overview of keyboard operation using steps one and two of the 3-step lesson feature. With the 3-step lesson feature, the on-screen keyboard guide keys light to show the next note of the tune.

To play the keyboard

- 1 Press the POWER button to turn on power.
 - This causes the power indicator to light.



- 2 Set the MODE switch to NORMAL.

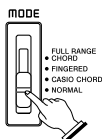

- 3 Press the SONG BANK button.

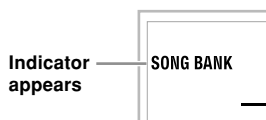

- 4 Find the tune you want to play in the SONG BANK List, and then use the number buttons to input its three-digit number.

- See page A-9 for the SONG BANK List.

Example: To select "047 ALOHA OE", input 0, 4 and then 7.



- 5 Press the STEP 1 button or STEP 2 button.
 - The keyboard sounds a count beat and waits for you to play something on the keyboard. The keys that you need to press first flash on the display.

- 6 Play the melody along with the selected tune's accompaniment.

- Play in accordance with the keyboard keys, fingerings and notes that appear on the display.

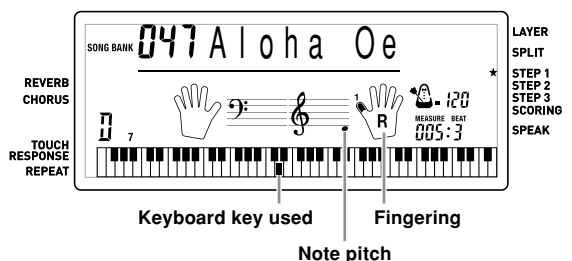

If you selected lesson Step 1

- Play the notes on the keyboard.
- Accompaniment (left-hand part) plays in time with the notes.
- With Step 1, the correct melody note is played no matter which keyboard key you press.

If you selected lesson Step 2

- Play the correct notes on the keyboard.
- While an on-screen keyboard guide key is lit, press the corresponding key on the actual keyboard. In the case of a two-hand tune, the keyboard guide indication turns off when you press a keyboard key, and the on-screen keyboard guide key lights for the next note to be played.
- Accompaniment (left-hand part) plays in time with the notes, as long as you press the correct keyboard keys.

- 7 To stop play at any time, press the PLAY/STOP button.

Power Supply

This keyboard can be powered by current from a standard household wall outlet (using the specified AC adaptor) or by batteries. Always make sure you turn the keyboard off whenever you are not using it.

Using batteries

Always make sure you turn off the keyboard before loading or replacing batteries.

NOTE

- The keyboard may not function correctly if you load or replace batteries with power turned on. If this happens, turning the keyboard off and then back on again should return functions back to normal.

To load batteries

<CTK-810>

- 1 Remove the battery compartment cover.

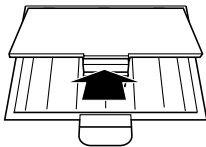

- 2 Load 6 AA-size batteries into the battery compartment.

- Make sure that the positive (+) and negative (-) ends are facing correctly.

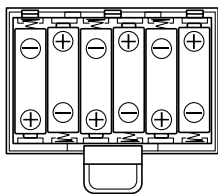

- 3 Insert the tabs on the battery compartment cover into the holes provided and close the cover.

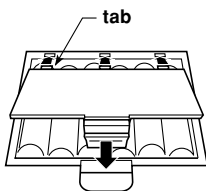

<WK-110>

- 1 Remove the battery compartment cover.

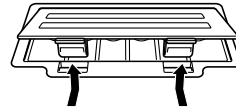

- 2 Load six D-size batteries into the battery compartment.

- Make sure that the positive (+) and negative (-) ends are facing correctly.

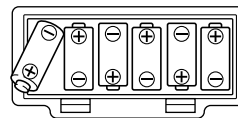

- 3 Insert the tabs on the battery compartment cover into the holes provided and close the cover.

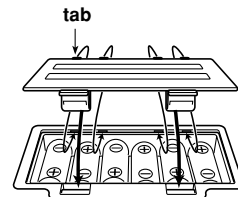

Important Battery Information

- The following shows the approximate battery life.
Alkaline batteries <CTK-810> 2.5 hours
Manganese batteries <WK-110> 6 hours
The above value is standard battery life at normal temperature, with the keyboard volume at medium setting. Temperature extremes or playing at very loud volume settings can shorten battery life.

⚠ WARNING

Misuse of batteries can cause them to leak, resulting in damage to nearby objects, or to explode, creating the risk of fire and personal injury. Always make sure you observe the following precautions.

- Never try to take batteries apart or allow them to become shorted. ⓧ
- Never expose batteries to heat or dispose of them by incineration.
- Never mix old batteries with new ones.
- Never mix batteries of different types.
- Do not charge the batteries.
- Make sure the positive (+) and negative (-) ends of the batteries are facing correctly.

⚠ CAUTION

Misuse of batteries can cause them to leak resulting in damage to nearby objects, or to explode, creating the risk of fire and personal injury. Always make sure you observe the following precautions.

- Use only batteries that are specified for use with this product. ⓧ
- Remove batteries from the product if you do not plan to use it for a long time.

NOTE

- Do not use an oxyride battery or any other type of nickel-based primary battery with this product. Incompatibility between such batteries and product specifications can result in shorter battery life and product malfunction.

Using the AC Adaptor

Make sure that you use only the AC adaptor specified for this keyboard.

Specified AC Adaptor: AD-5

[Rear Panel]

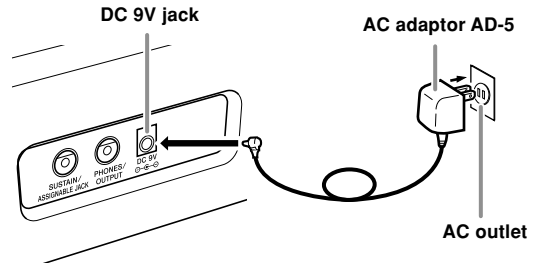

Note the following important precautions to avoid damage to the power cord.

● **During Use**

- Never pull on the cord with excessive force.
- Never repeatedly pull on the cord.
- Never twist the cord at the base of the plug or connector.
- The power cord should not be stretched tight while it is in use.

● **During Movement**

- Before moving the keyboard, be sure to unplug the AC adaptor from the power outlet.

● **During Storage**

- Loop and bundle the power cord, but never wind it around the AC adaptor.

IMPORTANT!

- Make sure that the keyboard is turned off before connecting or disconnecting the AC adaptor.
- Using the AC adaptor for a long time can cause it to become warm to the touch. This is normal and does not indicate malfunction.



Auto Power Off

When you are using battery power, keyboard power turns off automatically whenever you leave it on without performing any operation for about 6 minutes. When this happens, press the POWER button to turn power back on.

NOTE

- Auto Power Off is disabled (it does not function) when you are using the AC adaptor to power the keyboard.

To disable Auto Power Off

Hold down the TONE button while turning on the keyboard to disable Auto Power Off.

NOTE

- When this function is turned off, the keyboard does not turn off automatically no matter how long it is left with no operation being performed.
- Auto Power Off is enabled again when you manually turn off power and then turn it back on again.

Memory Contents

Registration memory contents, recorder memory contents, and song bank data you transfer from a computer to keyboard memory are all retained when the keyboard is turned off, either by pressing the power button or by Auto Power Off.

Electrical Power

The memory contents described above are retained as long as the keyboard is being supplied with electrical power. Unplugging the AC adaptor when batteries are not loaded or when loaded batteries are dead cuts off the keyboard's electrical power supply. This clears all data stored in memory.

Power Requirements

Note the following precautions whenever you want to ensure that current memory contents are not lost.

- Make sure the keyboard is being supplied power through the AC adaptor before replacing its batteries.
- Before unplugging the AC adaptor, make sure that fresh batteries are loaded in the keyboard.

Make sure that keyboard power is turned off before replacing batteries or unplugging the AC adaptor.

Connections

Phones/Output Terminal

PREPARATION

- Before connecting headphones or other external equipment, be sure to first turn down the volume settings of the keyboard and the connected equipment. You can then adjust volume to the desired level after connections are complete.

[Rear Panel]

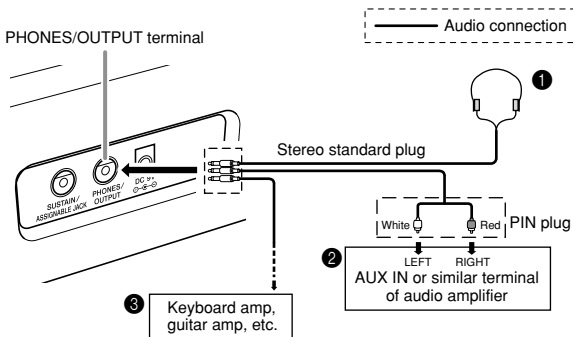

Connecting Headphones (Figure 1)

Connecting headphones cuts off output from the keyboard's built-in speakers, so you can play even late at night without disturbing anyone.

Audio Equipment (Figure 2)

Connect the keyboard to an audio equipment using a commercially available connecting cord with a standard plug on one end and two PIN plugs on the other end. Note that the standard plug you connect to the keyboard must be a stereo plug, otherwise you will be able to output only one of stereo channels. In this configuration, you normally set the input selector of the audio equipment to the terminal (usually marked AUX IN or something similar) where the cord from the keyboard is connected. See the user documentation that comes with your audio equipment for full details.

Musical Instrument Amplifier (Figure 3)

Use a commercially available connecting cord to connect the keyboard to a musical instrument amplifier.

NOTE

- Be sure to use a connecting cord that has a stereo standard plug on the end you connect to the keyboard, and a connector that provides dual channel (left and right) input to the amplifier to which you are connecting. The wrong type of connector at either end can cause one of the stereo channels to be lost.

When connected to a musical instrument amplifier, set the volume of the keyboard to a relatively low level and make output volume adjustments using the amplifier's controls.

Connection Example

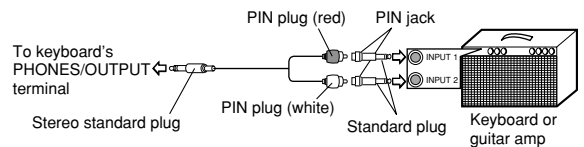

Connecting to a Computer or Other Equipment

You can also connect the keyboard to a computer. See "Connecting to a Computer" on page E-49 for details.



Sustain/Assignable jack Terminal

You can connect an optional sustain pedal (SP-3 or SP-20) to the SUSTAIN/ASSIGNABLE JACK terminal to enable the capabilities described below.

For details on how to select the pedal function you want, see "SUSTAIN/ASSIGNABLE JACK (Default: SUS)" on page E-53.

SUSTAIN/ASSIGNABLE JACK Terminal

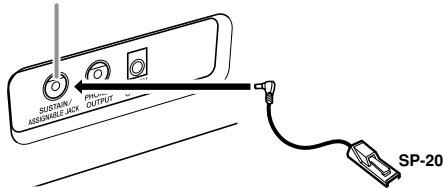

Sustain Pedal

- With piano tones, depressing the pedal causes notes to linger, much like a piano's damper pedal.
- With organ tones, depressing the pedal causes notes to continue to sound until the pedal is released.

Sostenuto Pedal

- As with the sustain pedal function described above, depressing the sostenuto pedal causes notes to be sustained.
- This difference between a sostenuto pedal and sustain pedal is the timing. With a sostenuto pedal, you press the keys and then depress the pedal before you release the keys.
- Only the notes that are sounding when the pedal is depressed are sustained.

Soft Pedal

Depressing the pedal softens the sound of the notes being played.

Rhythm Start/Stop Pedal

In this case, the pedal performs the same functions as the START/STOP button.

Accessories and Options

Use only the accessories and options specified for this keyboard. Use of non-authorized items creates the danger of fire, electrical shock, and personal injury.

Basic Operations

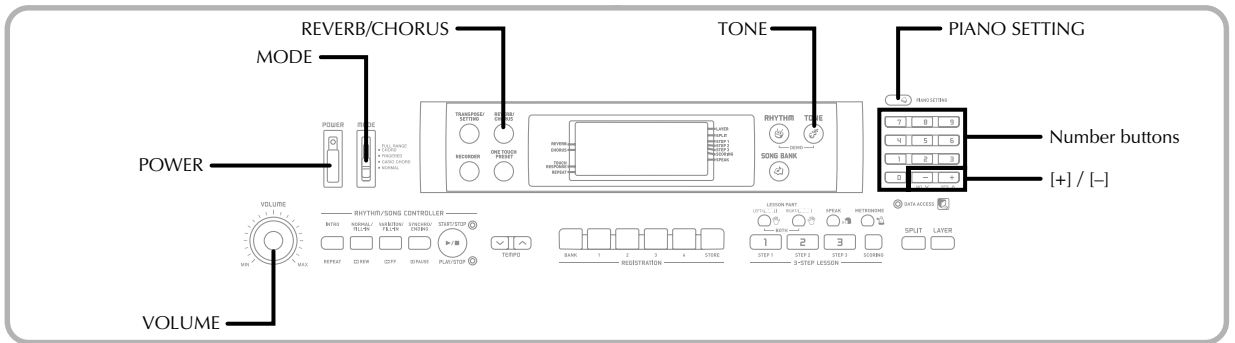

This section provides information on performing basic keyboard operations.

To play the keyboard

- 1 Press the POWER button to turn the keyboard on.
- 2 Set the MODE switch to NORMAL.
- 3 Use the VOLUME knob to set the volume to a relatively low level.
- 4 Play something on the keyboard.

Selecting a Tone

This keyboard comes with 515 built-in tones. Use the following procedure to select the tone you want.

To select a tone

- 1 Find the tone you want to use in the TONE List and note its tone number.
 - Not all of the available tones are shown on the tone list printed on the keyboard console. For a complete list, see the “Tone List” on page A-1.
- 2 Press the TONE button.

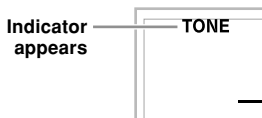

- 3 Use the number buttons to input the three-digit tone number of the tone you want to select.

Example: To select “111 ACOUSTIC BASS”, input 1, 1 and then 1.



NOTE

- Always input all three digits for the tone number, including leading zeros (if any). If you input one or two digits and stop, the display will automatically clear your input after a few seconds.
- You can also increment the displayed tone number by pressing [+], and decrement it by pressing [-].
- When one of the drum sets is selected (tone numbers 501 through 515), each keyboard key is assigned a different percussion sound. See page A-5 for details.

Polyphony

The term polyphony refers to the maximum number of notes you can play at the same time. The keyboard has 32-note polyphony, which includes the notes you play as well as the rhythms and auto-accompaniment patterns that are played by the keyboard. This means that when a rhythm or auto-accompaniment pattern is being played by the keyboard, the number of notes (polyphony) available for keyboard play is reduced. Also note that some of the tones offer only 16-note polyphony.

- When rhythm or auto accompaniment is playing, the number of sounds simultaneously played is reduced.

Using Tone Effects

Reverb: Makes your notes resonate

Chorus: Adds more breadth to your notes

1 Press the REVERB/CHORUS button to cycle through the effect settings as shown below.

- You can find out the current effect setting by looking at the REVERB and CHORUS indicators.

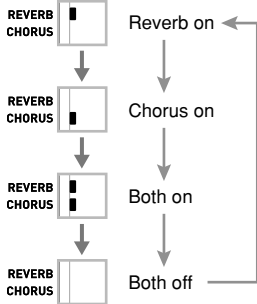

2 After turning on the effect you want, use the number buttons or the [+]/[-] buttons to select the effect type you want.

- Note that you need to select an effect type with the number buttons or the [+]/[-] buttons within a few seconds after turning on an effect. If you don't, the display will exit the setting screen.

Effect List

Reverb	1: Room 1 2: Room 2 3: Hall 1 4: Hall 2
Chorus	1: Chorus 1 2: Chorus 2 3: Chorus 3 4: Chorus 4

PIANO SETTING Button

Pressing this button changes the setup of the keyboard to optimize it for piano play.

Settings

Tone Number: "001"

Rhythm Number: "101"

Layer: Off

Split: Off

Reverb: On (Type 3)

Chorus: Off

Transpose: 00

Touch Response:

Off: Returns to initial default

On: No change

Assignable Jack: SUS

Local Control: On

To optimize keyboard settings for piano play

- Set the MODE switch to NORMAL.
- Press the PIANO SETTING button.
- Now try playing something on the keyboard.
 - The notes you play will sound with a piano tone.
 - If you want to play with rhythm accompaniment, press the START/STOP button. This causes a rhythm that is optimized for piano will start to play.
 - To stop rhythm play, press the START/STOP button again.

NOTE

- Pressing the PIANO SETTING button while a rhythm is playing stops rhythm play and then changes the keyboard setup.
- The setup of the keyboard does not change if you press the PIANO SETTING button when any one of the following exists.
 - During real-time recording of the Song Memory
 - During demo tune play

Playing a Built-in Tune

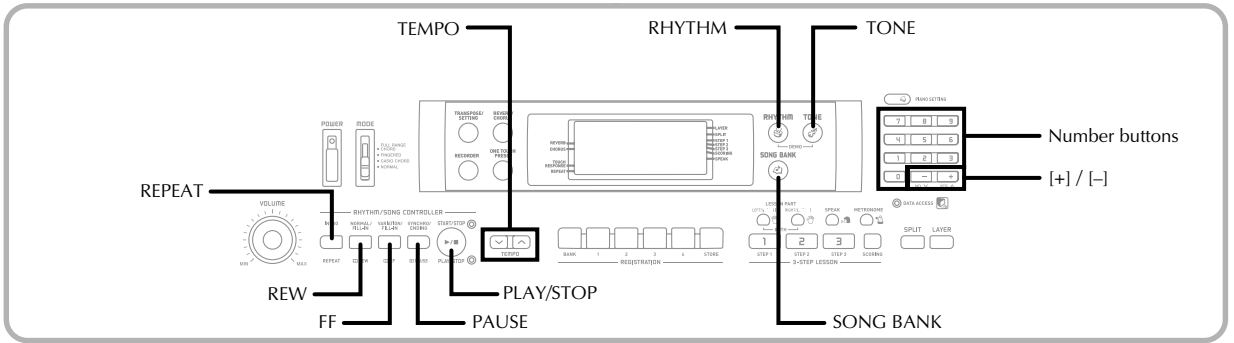

Your keyboard comes with a total of built-in 100 tunes. You can play back built-in tunes for your own listening pleasure, or you can use them for practice. Built-in tunes are divided between the two groups described below.

	Tune Numbers	Left-hand Part	Right-hand Part
Auto-accompaniment Tunes	<CTK-810> 001, 004 through 050 <WK-110> 003 through 050	Auto-accompaniment (percussion, bass, chords)	Melody
Two-hand tune	<CTK-810> 002, 003, and 051 through 100 <WK-110> 001, 002, and 051 through 100	Left-hand notes	Right-hand notes

In addition to the built-in tunes, you can also play back the tunes you download over the Internet (page E-50).

To play back a Song Bank tune

PREPARATION

- Adjust the main volume (page E-20).

- Find the tune you want to play in the SONG BANK List, and note its number.
 - See page A-9 for the SONG BANK List.
- Press the SONG BANK button to enter the Song Bank Mode.

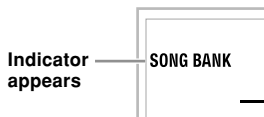

- Use the number buttons to input the tune's three-digit number.

Example: To select "047 ALOHA OE", input 0, 4 and then 7.



NOTE

- Tune Number 001 is the initial default Song Bank tune setting whenever you turn on keyboard power.
- You can also increment the displayed tune number by pressing [+], and decrement is by pressing [-].

- Press the PLAY/STOP button to start play of the tune.

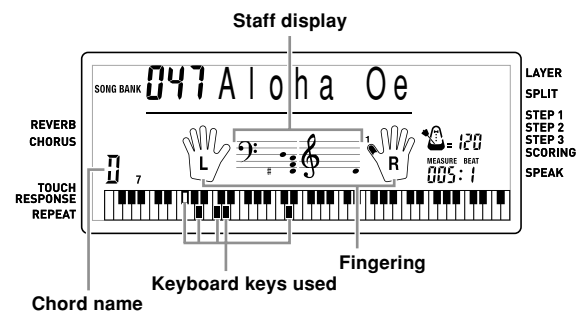

- Press the PLAY/STOP button to stop playback of the Song Bank tune.
 - The tune you select continues to play until you stop it.

Adjusting the Tempo

Each tune has a preset default tempo (beats per minute) that is set automatically whenever you select a tune. While the tune is playing, you can change the tempo setting to a value in the range of 30 to 255.

To set the tempo

- 1 Use the TEMPO buttons to set the tempo.

- ∧ : Increases the tempo value.
- ∨ : Decreases the tempo value.

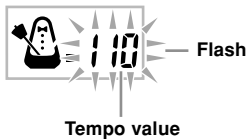

NOTE

- While the tempo value is flashing, you can also use the number buttons or [+] and [-] to input a three-digit value. Note that you must input leading zeros, so 90 is input as 090.
- Pressing both the ∧ and ∨ TEMPO buttons at the same time automatically returns the currently selected rhythm to its default tempo.

To pause playback

- 1 Press the PAUSE button while a tune is playing to pause it.
- 2 Pressing the PAUSE button again resumes play from the point where it was paused.

To fast reverse

- 1 While a tune is playing or paused, hold down the REW button to skip in a reverse direction at high speed.
 - The fast reverse operation skips back one measure at a time.
 - The measure and beat numbers on the display change while the fast reverse operation is being performed.



Measure number Beat number

- 2 Releasing the REW button starts song playback from the measure whose number is shown on the display.

NOTE

- Fast reverse does not work while tune play is stopped.

To fast forward

- 1 While a tune is playing or paused, hold down the FF button to skip forward at high speed.
 - The fast forward operation skips forward one measure at a time.
 - The measure and beat numbers on the display change while the fast forward operation is being performed.



Measure number Beat number

- 2 Releasing the FF button starts song playback from the measure whose number is shown on the display.

NOTE

- Fast forward does not work while tune play is stopped.

Looping a Musical Phrase

You can select one or more measures and “loop” them, which means that they play again and again until you stop playback.

- 1 While the tune is playing, press the REPEAT button while the measure you want to start from is playing.

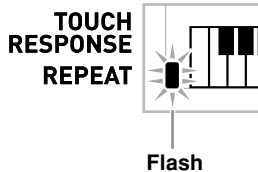

- 2 When playback is within the measure you want to specify as the end of the loop, press the REPEAT button again.

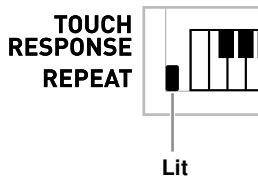

- To cancel repeat play of a loop, press the REPEAT button again so the repeat indicator is not displayed.

To change the melody tone

- 1 Press the TONE button.

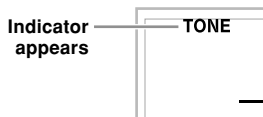

- 2 Find the tone you want in the TONE List, and then use the number buttons to input its three-digit number.

Example: To select “131 VIOLIN”, input 1, then 3, then 1.

- You can select any one of the keyboard’s built-in tones.



NOTE

- You can also use the [+] and [-] buttons to change the melody tones.
- Specifying the tune number for the same tune that is currently selected returns the melody tone to the default setting for that tune.

To play all tunes in succession

- 1 Press the RHYTHM button and TONE button at the same time.
 - Playback starts from Song Bank tune number 001.
- 2 To stop tune play, press the PLAY/STOP button.

NOTE

- While a tune is playing, you can use the number buttons or [+] and [-] to change to another tune.
- You can play along with the tunes on the keyboard.

3-Step Lesson

With the 3-Step Lesson System, you can practice built-in tunes and SMF data you download over the Internet, and even plot your progress according to the evaluation points the keyboard awards you.

* See "Expanding the Selections in the Song Bank Tunes" on page E-50 for information about the SMF data you download over the Internet.

Lesson Progress

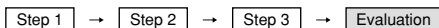

3-Step Lesson

The 3-step lesson feature takes you through the three distinct steps described below to help you learn to play tunes on the keyboard.

Step 1 – Master the timing.

Step 2 – Master the notes.

Step 3 – Play at normal speed.

Lesson Parts

3-Step Lesson lets you practice the right-hand part, left-hand part, or the parts for both hands.

Display Contents During 3-step Lesson Play

Whenever you select an Auto Accompaniment tune for 3-step lesson play, the on-screen keyboard guide and staff notation shows the note you should play and its length. The on-screen keyboard guide also shows the notes you play on the keyboard. The following describes the information that appears on the display.

Note Pitch

The key you should press lights on the on-screen keyboard guide, while the actual pitch of the note appears in the display's staff notation area. The fingers you should use to play the notes are also shown on the display.

Note Length

The key stays lit on the on-screen keyboard guide for as long as the note should be sustained. The staff notation and fingerings also remain on the display for the length of the note.

Next Note

An on-screen keyboard guide key flashes to indicate the next note to be played, while a number appears on the display near the finger you should use to play the next note.

Series of Same Pitch Notes

The on-screen keyboard guide key turns off momentarily between the notes, and lights again for each successive note. The staff notation and fingerings also turn off and back on again.

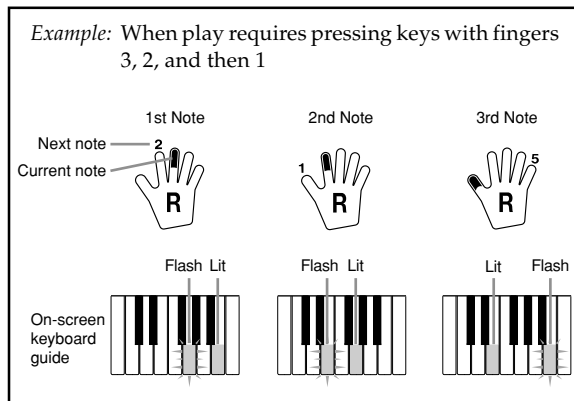

NOTE

- Note length is not indicated when you are using two-hand tunes with 3-step lesson Steps 1 and 2. As soon as you press a key that is lit on the on-screen keyboard guide, it goes out and the next key you need to press starts to flash.
- Note length is indicated by the on-screen keyboard guide when you use two-hand tunes with Step 3. In this case, the next key to be pressed does not flash when you press a lit key.
- During Step 3, the next finger number does not appear on the display. Only the current finger number is shown.

3-step Lesson Tempo Setting

Use the procedure under "Adjusting the Tempo" on page E-23 to adjust the tempo for 3-step lesson play.

Evaluation Mode

The keyboard can be configured to evaluate your 3-Step Lesson progress. A perfect score is 100. You can even have the piano display your points, both part way through and at the end of a lesson.

Evaluation Mode Display

Level Indicator (9 Levels): This indicator shows the evaluation of your current performance at a glance. The more segments that appear, the higher your points.

Example: 50 points



Timing Indicator: In the Evaluation Mode, the configuration of the star changes with each note to let you know how your timing is. The more stars, the better your timing.



Using Tone Guide

When the keyboard senses that your timing is off, it will let you know by changing the notes you play to a tone that is different from the one you currently have selected.

Evaluation Results

After you finish playing, the keyboard calculates an evaluation of your total performance, from beginning to end, and displays your total score on the monitor screen.

Evaluation Rank Display Messages

Display Message	
"Bravo!"	↑ <High> Evaluation Ranges ↓ <Low>
"Great!"	
"Not bad!"	
"Again!"	

"****" : indicates that the Evaluation Mode was exited before an evaluation result could be obtained.

Using the Lesson Functions and Evaluation Mode

Perform the following steps to master your favorite tunes.

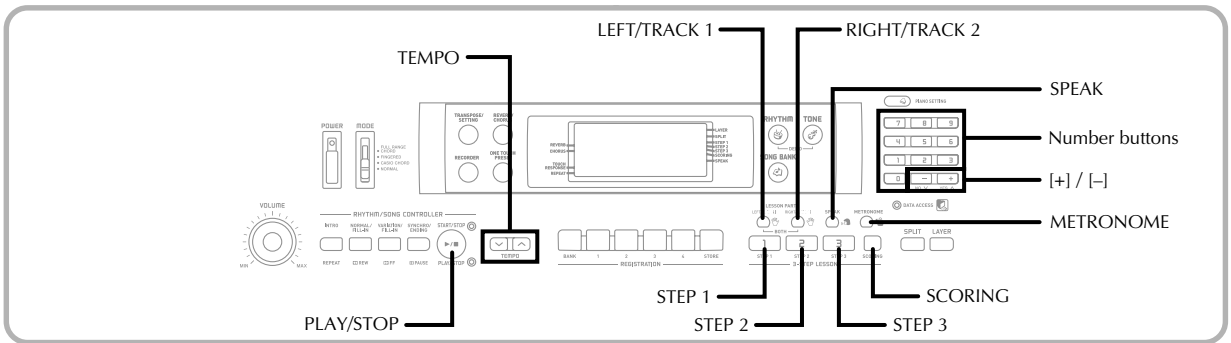

Step 1 – Master the timing.

- 1 Select the tune you want to use.
- 2 Press the RIGHT/TRACK 2 button or the LEFT/TRACK 1 button to specify the part you want to practice.
 - Indicator appears on the display whose part is selected for practice.

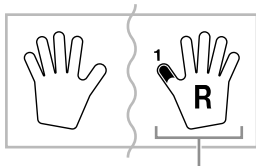

Indicator appears

- If you want to practice both hands, press both buttons at the same time.
- 3 Press the STEP 1 button to start Step 1 play.

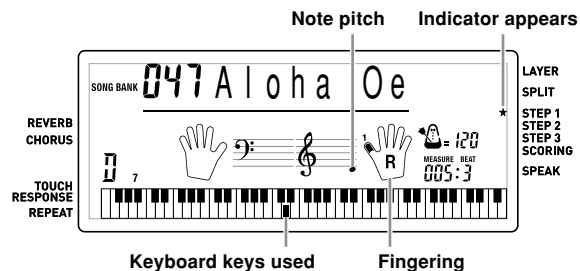

- After a count sounds, the keyboard stands by and waits for you to play the first note of the tune.
- Voice fingering guide will use a simulated human voice to call out fingering numbers during one-hand part practice. See “Voice Fingering Guide” on page E-29 for details.

- 4 Press any keyboard keys to play the notes.
 - The key for the next note to be played flashes on the on-screen keyboard guide and the keyboard waits for you to play it. When you press any key to play the note, the on-screen key remains lit as the note plays.
 - Accompaniment (left-hand part) waits until you press any key to play a note.
 - If you accidentally press more than one key in succession, accompaniment is played for the corresponding number of notes.
 - Pressing more than one key at the same time counts as a single note. Pressing a key while another key is held down is counted as two notes.
- 5 To stop play at any time, press the STEP 1 or PLAY/STOP button.

Step 2 – Master the notes.

- 1 Select the tune you want to use.
- 2 Press the RIGHT/TRACK 2 button or the LEFT/TRACK 1 button to specify the part you want to practice.
 - Indicator appears on the display whose part is selected for practice.
 - If you want to practice both hands, press both buttons at the same time.

- 3 Press the STEP 2 button to start Step 2 play.

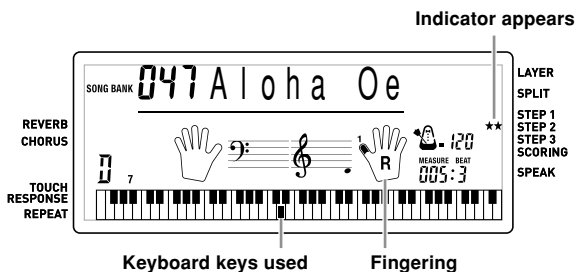

- After a count sounds, the keyboard stands by and waits for you to play the first note of the tune.
- Voice fingering guide will use a simulated human voice to call out fingering numbers during one-hand part practice. See "Voice Fingering Guide" on page E-29 for details.

- 4 Play the notes as indicated by the on-screen keyboard guide.

- The key for the next note to be played flashes on the on-screen keyboard guide and the keyboard waits for you to play it. When you press any key to play the note, the on-screen key remains lit as the note plays.
- If multiple keys light on the on-screen keyboard guide when you are using a two-hand tune, it means that you must press all of the keys that are lit.

- 5 To stop play at any time, press the STEP 2 or PLAY/STOP button.

Step 3 – Play at normal speed.

- 1 Select the tune you want to play.
- 2 Press the RIGHT/TRACK 2 button or the LEFT/TRACK 1 button to specify the part you want to practice.
 - Indicator appears on the display whose part is selected for practice.
 - If you want to practice both hands, press both buttons at the same time.

- 3 Press the STEP 3 button to start Step 3 play.

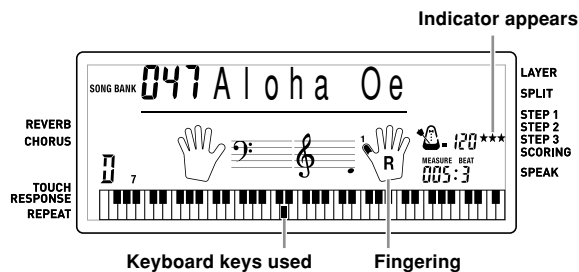

- Accompaniment (left hand part) starts to play at normal speed.

- 4 Play the notes as indicated by the on-screen keyboard guide.

- 5 To stop play at any time, press the STEP 3 or PLAY/STOP button.

Evaluating Your Keyboard Play

- 1 Press the SCORING button.
 - This causes the SCORING indicator to appear on the display.

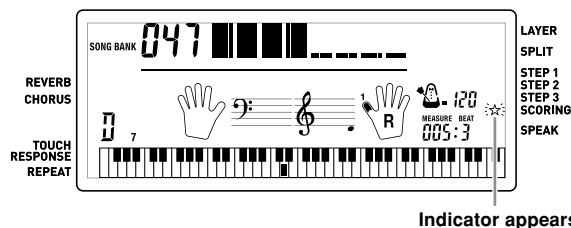

- A count beat sounds and then evaluation mode starts.

- 2 Play in accordance with the guidance on the monitor screen.

- To stop evaluation, press the PLAY/STOP button. This displays only the points accumulated up to that point.

- 3 After you finished playing, your evaluation result appears on the display.

- For information about evaluation ranks, see "Evaluation Results" on page E-26.
- Pressing the SONG BANK button returns to the tune selection screen.

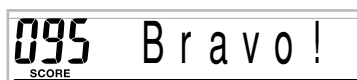

Voice Fingering Guide

Voice fingering guide uses a simulated human voice to call out fingering numbers during Step 1 and Step 2 one-hand part practice. If you need to press a key with your thumb, for example, voice fingering guide says, "One!" In the case of a chord to be played with your thumb, middle and little finger, voice fingering guide says, "One, three, five!" Voice Fingering Guide calls out fingerings only when you do not press the proper key when you should.

Voice Fingering Guide

- One : Thumb
- Two : Forefinger
- Three : Middle finger
- Four : Ring finger
- Five : Little finger

To turn voice fingering guide on or off

Press the SPEAK button to toggle voice fingering guide on (voice fingering guide indicator displayed) and off (indicator not displayed).



NOTE

- Note that Voice Fingering is disabled in the Evaluation Mode.
- Exiting the Evaluation Mode automatically restores the Voice Fingering setting that was in effect when you entered the Evaluation Mode.

Using the Metronome

The metronome feature of this keyboard produces a bell sound for the first beat of each measure, followed by click sounds for each successive beat of the measure. It is the perfect tool for practicing tunes without accompaniment (rhythm).

To start the metronome

- 1 Press the METRONOME button to start sounding the metronome.
 - This causes "Beat" to appear on the display. Perform step 2 within five seconds after "Beat" appears.



- 2 Use the number buttons or [+] and [-] to change the number of beats per measure.
 - You can specify 0, or a value from 2 to 6 as the number of beats per measure.

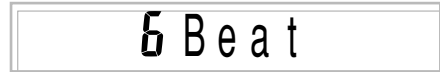

NOTE

- The bell (indicating the first beat of a measure) does not sound while 0 beat per measure is specified. All beats are indicated by a click sound. This setting lets you practice with a steady beat, without worrying about how many beats there are in each measure.

- 3 Use the TEMPO buttons to set the tempo.

- Press ^ to increase the tempo (make it faster) or v to decrease it (make it slower).

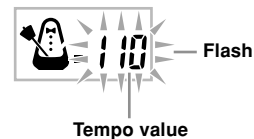

NOTE

- While the tempo value is flashing, you can also use the number buttons or [+] and [-] to input a three-digit value. Note that you must input leading zeros, so 90 is input as 090.
- Pressing both the ^ and v TEMPO buttons at the same time automatically returns the currently selected rhythm or tune to its default tempo.

- 4 To turn off the metronome, press the METRONOME button.

NOTE

- The metronome is disabled whenever you are using Step 1 or Step 2 of the 3-step lesson.

Auto Accompaniment

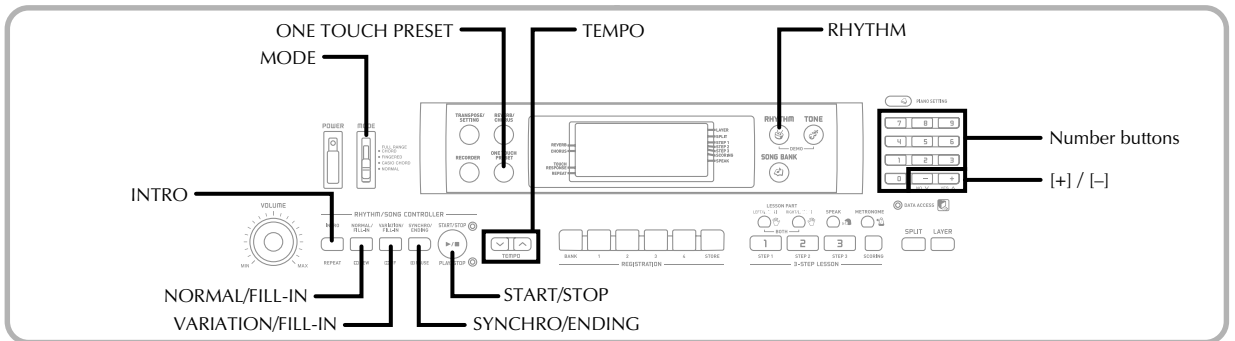

This keyboard automatically plays bass and chord parts in accordance with the chords you finger. The bass and chord parts are played using sounds and tones that are automatically selected to select the rhythm you are using. All of this means that you get full, realistic accompaniments for the melody notes you play with your right hand, creating the mood of an one-person ensemble.

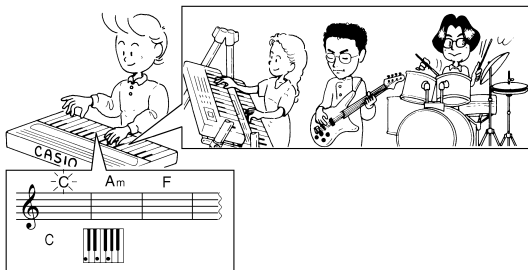

Selecting a Rhythm

This keyboard provides you with 120 exciting rhythms that you can select using the following procedure.

To select a rhythm

- Find the rhythm you want to use in the RHYTHM List and note its rhythm number.
 - Not all of the available rhythms are shown on the rhythm list printed on the keyboard console. For a complete list, see the "Rhythm List" on page A-8.
- Press the RHYTHM button to enter the Rhythm Mode.

Indicator appears



- Use the number buttons to input the three digit rhythm number for the rhythm you want to select.

Example: To select "095 HAWAIIAN", input 0, 9 and then 5.



NOTE

- You can also increment the displayed rhythm number by pressing [+], and decrement it by pressing [-].
- Some rhythms (No. 110, 112 to 120) consist of chord accompaniments only, without any drums or other percussion instruments. Such rhythms do not sound unless CASIO CHORD, FINGERED, or FULL RANGE CHORD is selected as the accompaniment mode.

Playing a Rhythm

Use the following procedure to start and stop rhythm play.

To play a rhythm

- 1 Set the MODE switch to NORMAL.
- 2 Press the START/STOP button to start play of the currently selected rhythm.
- 3 To stop rhythm play, press the START/STOP button again.

NOTE

- All of the keyboard keys are melody keys while the MODE switch is set to NORMAL.

Adjusting the Tempo

The tempo (beats per minute) can be set to a value in the range of 30 to 255. The tempo value you set is use for Song Bank, 3-step lesson, and Auto Accompaniment chord play, as well as playback from the recorder and metronome operation.

To set the tempo

- 1 Use the TEMPO buttons to set the tempo.
 - ∧ : Increase the tempo value.
 - ∨ : Decreases the tempo value.

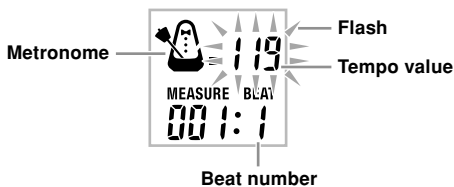

NOTE

- While the tempo value is flashing, you can also use the number buttons or [+] and [-] to input a three-digit value. Note that you must input leading zeros, so 90 is input as 090.
- Pressing both the ∧ and ∨ TEMPO buttons at the same time automatically returns the currently selected rhythm to its default tempo.

Using Auto Accompaniment

The following procedure describes how to use the keyboard's Auto Accompaniment feature. Before starting, you should first select the rhythm you want to use and set the tempo of the rhythm to the value you want.

To use Auto Accompaniment

- 1 Set the MODE switch to CASIO CHORD, FINGERED, or FULL RANGE CHORD.
- 2 Press the START/STOP button to start play of the currently selected rhythm.
- 3 Play a chord.
 - The actual procedure you should use to play a chord depends on the current MODE switch position. Refer to the following pages for details on chord play.

CASIO CHORD	Page E-32
FINGERED	Page E-33
FULL RANGE CHORD	Page E-34

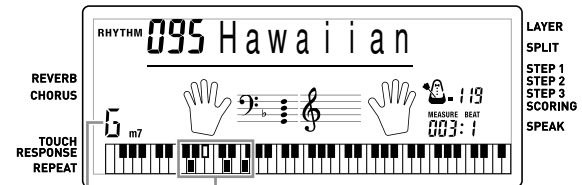

(The chord form that appears here may show notes that differ from those actually pressed on the keyboard. With some chords, inverted chord forms may be displayed.)

Chord name

- 4 To stop Auto Accompaniment play, press the START/STOP button again.

NOTE

- If you press the SYNCHRO/ENDING button and then the INTRO button in place of the START/STOP button in step 2, accompaniment will start with an intro pattern when you perform the operation in step 3. For details about these buttons, see pages E-35 and E-36.
- If you press the SYNCHRO/ENDING button in place of the START/STOP button in step 4, an ending pattern will play before accompaniment play is ended. For details about this button, see page E-36.
- You can adjust the accompaniment part volume level independently of the main volume. For details, see "Adjusting Accompaniment and Song Bank Volume" on page E-47.

CASIO CHORD

This method of chord play makes it possible for anyone to easily play chords, regardless of previous musical knowledge and experience. The following describes the CASIO CHORD "Accompaniment keyboard" and "Melody keyboard", and tells you how to play CASIO CHORDs.

CASIO CHORD Accompaniment Keyboard and Melody Keyboard

<WK-110>

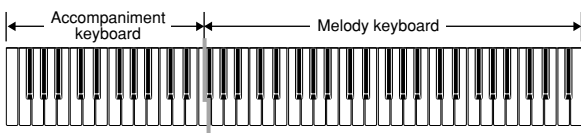

<CTK-810>



NOTE

- The accompaniment keyboard can be used for playing chords only. No sound will be produced if you try playing single melody notes on the accompaniment keyboard.
- The split point (page E-46) is the point that separates the Auto Accompaniment area and the melody area of the keyboard. You can change the location of the split point, which also changes the sizes of the keyboard areas.

Chord Types

CASIO CHORD accompaniment lets you play four types of chords with minimal fingering.

Chord Types	Example
Major chords Major chord names are marked above the keys of the accompaniment keyboard. Note that the chord produced when you press an accompaniment keyboard does not change octave, regardless of which key you use to play it.	C Major (C)
Minor chords (m) To play a minor chord, keep the major chord key depressed and press any other accompaniment keyboard key located to the right of the major chord key.	C minor (Cm)
Seventh chords (7) To play a seventh chord, keep the major chord key depressed and press any other two accompaniment keyboard keys located to the right of the major chord key.	C seventh (C7)
Minor seventh chords (m7) To play a minor seventh chord, keep the major chord key depressed and press any other three accompaniment keyboard keys located to the right of the major chord key.	C minor seventh (Cm7)

NOTE

- It makes no difference whether you press black or white keys to the right of a major chord key when playing minor and seventh chords.

FINGERED

FINGERED provides you with a total of 15 different chord types. The following describes the FINGERED "Accompaniment keyboard" and "Melody keyboard", and tells you how to play a C-root chord using FINGERED.

FINGERED Accompaniment Keyboard and Melody Keyboard

<WK-110>



<CTK-810>



NOTE

- The accompaniment keyboard can be used for playing chords only. No sound will be produced if you try playing single melody notes on the accompaniment keyboard.
- The split point (page E-46) is the point that separates the Auto Accompaniment area and the melody area of the keyboard. You can change the location of the split point, which also changes the sizes of the keyboard areas.

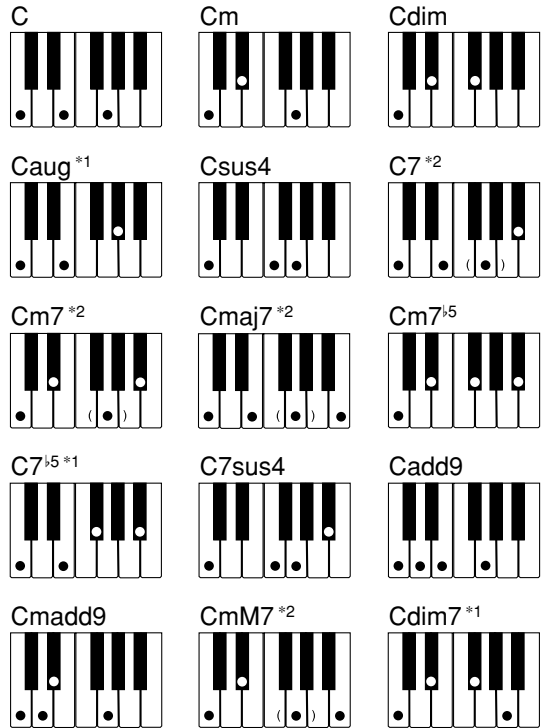

See the FINGERED Chord Chart on page A-7 for details on playing chords with other roots.

- *1: Inverted fingerings cannot be used. The lowest note is the root.
- *2: The same chord can be played without pressing the 5th G.

NOTE

- Except for the chords specified in note*1 above, inverted fingerings (i.e. playing E-G-C or G-C-E instead of C-E-G) will produce the same chords as the standard fingering.
- Except for the exception specified in note*2 above, all of the keys that make up a chord must be pressed. Failure to press even a single key will not play the desired FINGERED chord.

FULL RANGE CHORD

This accompaniment method provides a total of 38 different chord types: the 15 chord types available with FINGERED plus 23 additional types. The keyboard interprets any input of three or more keys that matches a FULL RANGE CHORD pattern to be a chord. Any other input (that is not a FULL RANGE CHORD pattern) is interpreted as melody play. Because of this, there is no need for a separate accompaniment keyboard, so the entire keyboard, from end to end, can be used for both melody and chords.

FULL RANGE CHORD Accompaniment Keyboard and Melody Keyboard

<WK-110>

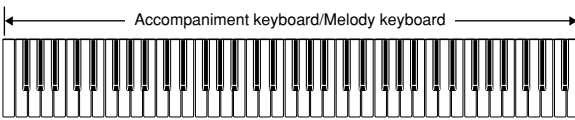

<CTK-810>

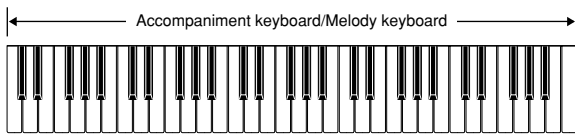

< Chords Recognized by This Keyboard >

Chord Types	Number of Types
Corresponding FINGERED Chord	15 (page E-33)
Other Chords	23 The following are examples of chords that use C as the bass note. C ₆ • Cm ₆ • C ₆₉ C [#] / _C • D/ _C • E/ _C • F/ _C • G/ _C • A ^b / _C • B ^b / _C B/ _C • C [#] m/ _C • Dm/ _C • Fm/ _C • Gm/ _C • Am/ _C • B ^b m/ _C Ddim/ _C • A ^b ₇ / _C • F ₇ / _C • Fm ₇ / _C • Gm ₇ / _C • A ^b _{add9} / _C

Example: To play the chord C major.

Any of the fingerings shown in the illustration below will produce C major.

<WK-110>

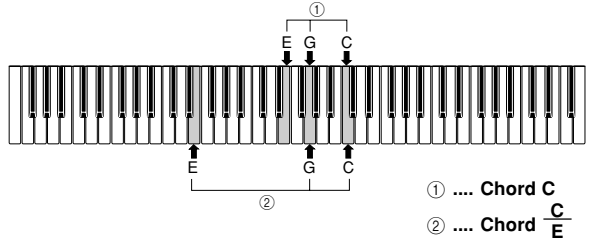

<CTK-810>

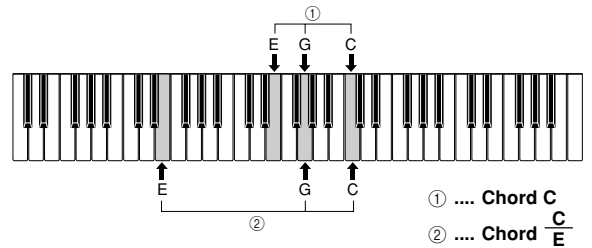

NOTE

- As with the FINGERED mode (page E-33), you can play the notes that form a chord in any combination (①).
- When the composite notes of a chord are separated by 6 or more notes, the lowest sound becomes the bass (②).

< Music Example >

Tone: 001, Rhythm: 102, Tempo: 070

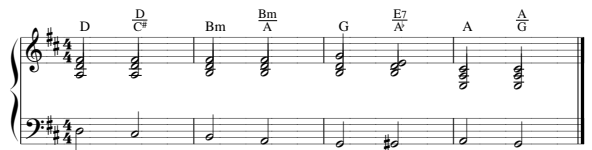



Using an Intro Pattern

This keyboard lets you insert a short intro into a rhythm pattern to make startup smoother and more natural.

The following procedure describes how to use the Intro feature. Before starting, you should first select the rhythm you want to use, and set the tempo.

To insert an intro

- 1 Press the INTRO button to start the selected rhythm with an intro pattern.
 - With the above setup, the intro pattern is played and the auto accompaniment with intro pattern starts as soon as you play chords on the accompaniment keyboard.

NOTE

- The standard rhythm pattern starts to play after the intro pattern is complete.
- Pressing the VARIATION/FILL-IN button while an intro pattern is playing causes the variation pattern to sound after the intro pattern is complete.

Using a Fill-in Pattern

Fill-in patterns let you momentarily change the rhythm pattern to add some interesting variation to your performances.

The following procedure describes how to use the Fill-in feature.

To insert a fill-in

- 1 Press the START/STOP button to start rhythm play.
- 2 Press the NORMAL/FILL-IN button to insert a fill-in pattern for the rhythm you are using.

NOTE

- The fill-in pattern does not play if you press the NORMAL/FILL-IN button while an intro pattern is playing.

Using a Rhythm Variation

In addition to the standard rhythm pattern, you can also switch to a secondary "variation" rhythm pattern for a bit of variety.

To insert the variation rhythm pattern

- 1 Press the START/STOP button to start rhythm play.
- 2 Press the VARIATION/FILL-IN button to switch to the variation pattern for the rhythm you are using.

NOTE

- To switch back to the standard rhythm pattern, press the NORMAL/FILL-IN button.

Using a Fill-in Pattern with a Variation Rhythm

You can also insert a fill-in pattern while a variation rhythm pattern is playing.

To insert a fill-in into a rhythm variation

- 1 While a variation rhythm pattern is playing, press the VARIATION/FILL-IN button to insert a fill-in pattern for the variation rhythm you are using.

Synchro Starting Accompaniment with Rhythm Play

You can set up the keyboard to start rhythm play at the same time you play the accompaniment on the keyboard.

The following procedure describes how to use synchro start. Before starting, you should first select the rhythm you want to use, set the tempo, and use the MODE switch to select the chord play method you want to use (NORMAL, CASIO CHORD, FINGERED, FULL RANGE CHORD).

To use synchro start

- 1 Press the SYNCHRO/ENDING button to put the keyboard into synchro start standby.



Flash

- 2 Playing a chord and the rhythm pattern starts to play automatically.

NOTE

- If the MODE switch is set to NORMAL, only the rhythm plays (without a chord) when you play on the accompaniment keyboard.
- If you press the INTRO button before playing anything on the keyboard, the rhythm starts automatically with an intro pattern when you play something on the accompaniment keyboard.
- Pressing the VARIATION/FILL-IN button before playing anything on the keyboard causes play to start with the variation pattern when something is played on the keyboard.
- To cancel synchro start standby, press the SYNCHRO/ENDING button one more time.

Finishing with an Ending Pattern

You can end your performances with an ending pattern that brings the rhythm pattern you are using to a natural-sounding conclusion.

The following procedure describes how to insert an ending pattern. Note that the actual ending pattern played depends on the rhythm pattern you are using.

To finish with an ending pattern

- 1 While the rhythm is playing, press the SYNCHRO/ENDING button.
 - This causes the ending pattern to play, which brings rhythm accompaniment to an end.

Using One-touch Preset

One-touch preset automatically makes the settings listed below in accordance with the rhythm pattern you are using.

- Keyboard tone
- Layer, Split, or Layer Split on/off
- Layered tone (when layer is turned on), split tone (when split is turned on), or layered split tone (when layer and split are turned on)
- Tempo
- Reverb and chorus settings

To use one-touch preset

- 1 Select the rhythm you want to use.
- 2 Use the MODE switch to select the accompaniment mode you want to use.
- 3 Press the ONE TOUCH PRESET button.
 - This automatically configures the one-touch preset settings in accordance with the rhythm you selected, and enters synchro start standby.
- 4 Play a chord. This will cause the rhythm pattern to start to play automatically.
 - Accompaniment is played using the one touch preset settings.

Registration Memory

Registration Memory Features

Registration memory lets you store up to 32 keyboard setups (4 sets × 8 banks) for instant recall whenever you need them. The following is a list of settings that are saved in registration memory.

Registration Memory Settings

- Tone
- Rhythm
- Tempo
- Layer on/off
- Split on/off
- Split point
- Effect settings
- Touch Response settings
- Assignable jack setting
- Synchro standby state

NOTE

- Each bank of registration memory initially contains data when you first use the keyboard. Simply replace the existing data with your own data.

Setup Names

You can assign setups into one of 32 areas, which you can select using BANK button and the four REGISTRATION buttons. Area names range from 1-1 through 8-4 as shown below.

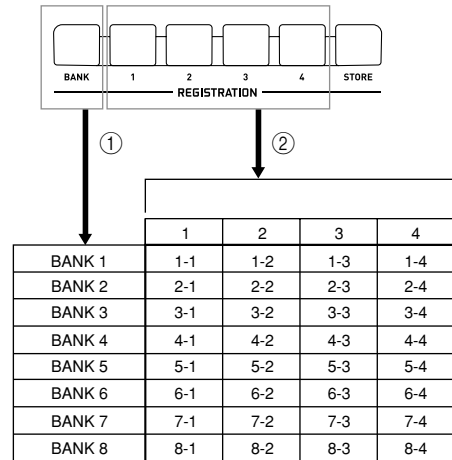

- ① Use the BANK button to select the bank. Each press of BANK cycles through the bank numbers from 1 to 8.
- ② Pressing one of the REGISTRATION buttons (1 to 4) selects the corresponding area in the currently selected bank.

NOTE

- Whenever you save a setup and assign it a setup name, any setup data previously assigned to that name is replaced with the new data.

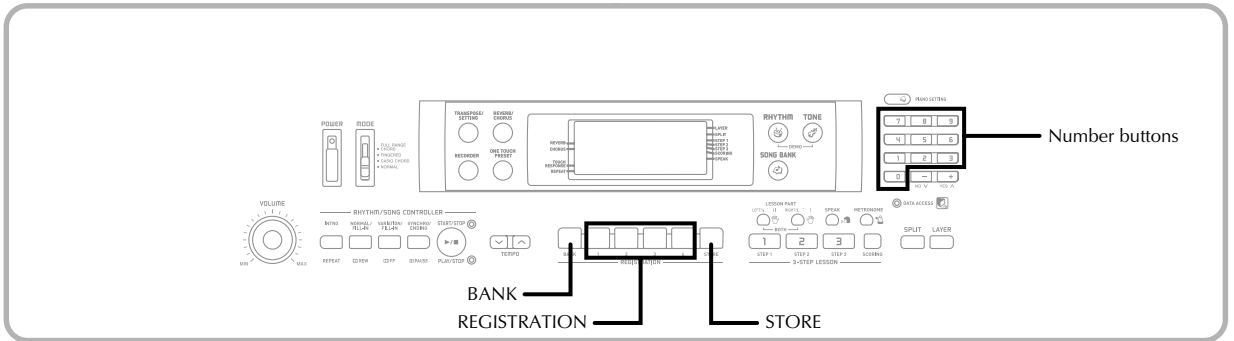

To Save a Setup in Registration Memory

- 1 Select a tone and rhythm, and otherwise set up the keyboard the way you want.
 - See “Registration Memory Settings” on page E-37 for details on what data is stored in the registration memory.
- 2 Use the BANK button or the number buttons to select the bank you want.
 - If you do not perform any operation for about three seconds after pressing the BANK button, the display returns to the contents in step 1, above.
 - Bank 1 selected.

1- Bank

- 3 While holding down the STORE button, press a REGISTRATION button (1 to 4).
 - The following display appears when you press the 2 button.

1-2 Store

- 4 Release the STORE and REGISTRATION buttons.

NOTE

- The setup is saved as soon as you press a REGISTRATION button in step 3, above.

To Recall a Setup from Registration Memory

- 1 Use the BANK button or the number buttons to select the bank.
 - If you do not perform any operation for about three seconds after pressing the BANK button, the keyboard automatically clears the registration memory recall screen.

1- Bank

- 2 Press the REGISTRATION button (1 to 4) for the area whose setup you want to recall.

1-2 Recall

- The setup name along with the message “Recall” appears on the display.

NOTE

- If you press a REGISTRATION button without using the BANK button to select a bank first, the last bank number selected is used.

Recording and Play Back

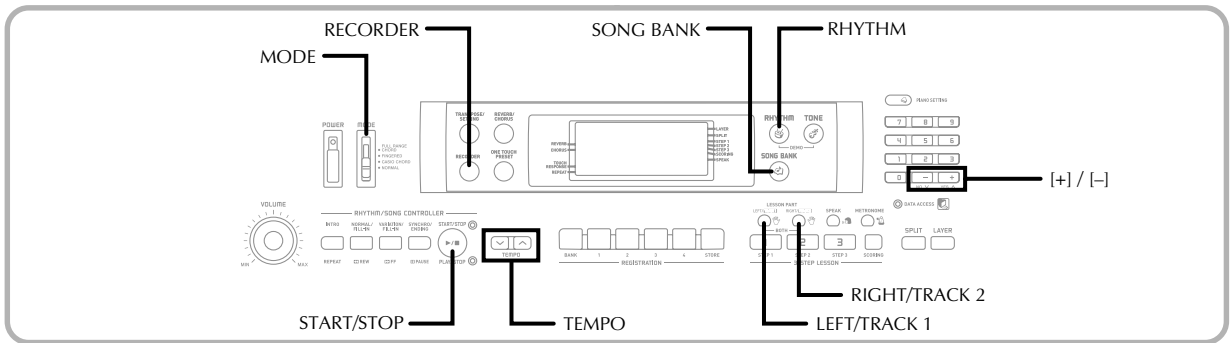

You can record your lesson play (lesson recording) and keyboard play along with the Auto Accompaniment you are using (performance recording).

Parts and Tracks

How data is recorded to the keyboard and the type of data that is recorded depends on whether you are performing a performance recording operation or a lesson recording operation.

Lesson Recording

With lesson recording, you use the LEFT/TRACK 1 button and the RIGHT/TRACK 2 button to select recording of only the left-hand part, only the right-hand part, or both the left-hand and right-hand parts.

Performance Recording

With performance recording, the keyboard operates like a tape recorder or sequencer. In this case, you can use the LEFT/TRACK 1 button and the RIGHT/TRACK 2 button to select the track you want to record to. Performance recording records the data shown in the illustration below, using two memory tracks.

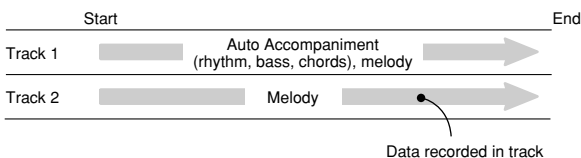

- Since each track is independent of the other, you can edit a recording by re-recording only one of the tracks.

Using the RECORDER Button

Each press of the RECORDER button cycles through the recording options in the sequence shown below.

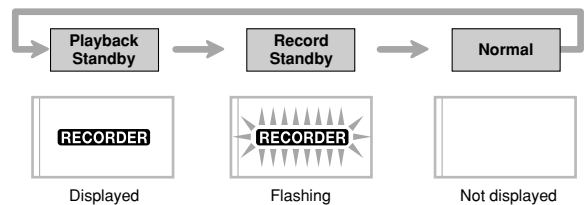

Memory Capacity

This keyboard can hold a total of approximately 12,000 notes, which can be divided between a lesson recording and a performance recording. Note that you can use up all 12,000 notes for either the lesson recording or the performance recording. If you do, you will not be able to record anything for the other type of recording.

- The recorder shares the same memory area with the song bank area used for storing song data transferred from a computer. Because of this, you may not be able to store the full 12,000 notes of data.
- When the number of remaining notes becomes less than about 100 while you are recording, the RECORDER indicator and the track/part indicator (L, R) will start to flash at high speed.
- Recording will stop automatically if memory becomes full.

If you are using Auto Accompaniment or a rhythm, they will also stop playing at this time.

IMPORTANT!

- Never turn off the keyboard while it is recording or standing by for recording to the keyboard. Doing so will cause all of the song data currently stored in the Song Bank user area to be deleted.

Recorded Data Storage

- Anything previously stored in the keyboard is replaced whenever you make a new recording.
- Recorder contents are retained even when power is turned off, as long as the keyboard is being supplied battery or AC adaptor power. If you remove the batteries or should the batteries go dead while the keyboard is not being supplied power by the AC adaptor, recorder contents will be deleted. Be sure to supply power to the keyboard with the AC adaptor when replacing batteries.
- Turning off the keyboard while a record operation is in progress causes the contents of the track you are currently recording to be lost.

CASIO COMPUTER CO., LTD. assumes no responsibility for any loss or damage to you or any third party arising out of the loss or corruption of data.

Recording Play Along with a Built-in Tune

You can use the lesson recording procedure to record notes you play along with one of the keyboard's built-in tunes. When you start a lesson recording, the keyboard plays the song minus the part(s) you selected as the recording part(s).

Selecting Parts

Press the part/track button that corresponds to the part(s) you want to select as the recording part(s).

To select this part:	Press this button:
Left-hand	LEFT/TRACK 1
Right-hand	RIGHT/TRACK 2
Both hands	LEFT/TRACK 1 + RIGHT/TRACK 2

The part that is currently selected is indicated by the part/track indicators (L and R) that appear on the display as described below.

Part/Track Indicators in Recording Standby

Press the part/track button of the part you want to play on the keyboard (recording part). This causes its part/track indicator to flash.

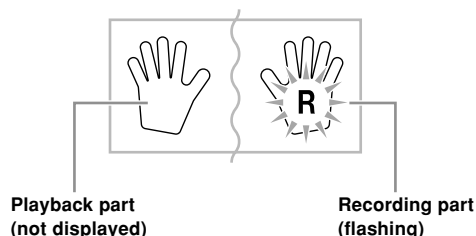

Example: The above indicates the left-hand part is the playback part, and the right-hand part is the recording part.

To record as you play along with a built-in tune

- 1 Press the SONG BANK button to select the mode that includes the tune you want to play along with.

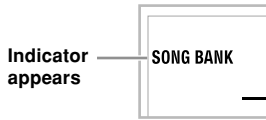

- 2 Use the RECORDER button to select record standby.
 - This causes the RECORDER indicator to flash on the display.
- 3 Select the tune you want to play along with.
 - See “To play back a Song Bank tune” on page E-22 for information about selecting Song Bank tunes.
- 4 Use the LEFT/TRACK 1 button or RIGHT/TRACK 2 button to select the part(s) (left-hand, right-hand) you want to mute in the built-in tune playback and play along on the keyboard.
 - If you want to mute and play both parts, press both buttons at the same time.
- 5 Configure the following settings as required.
 - Tone (page E-20)
 - Tempo (page E-23)
- 6 Press the controller block START/STOP button.
 - This starts recording.
- 7 Play the notes for the part(s) you selected in step 4 on the keyboard.
- 8 Recording stops automatically when playback of the built-in tune is finished.
 - To interrupt recording part way through, press the controller block START/STOP button. This will play back everything you recorded up to that point.
 - If you want to hear what you recorded immediately, press the controller block START/STOP button again.

Lesson Recording Data

In addition to the notes you play on the keyboard and the accompaniment of the built-in song you selected, the following data is also stored by a lesson recording operation.

- Tone setting
- Tempo setting
- Tune name
- Recording part selection
- Pedal operations
- Layer and split settings, and their tone settings
- Effect setting

Playing Back a Lesson Recording

- 1 Press the SONG BANK button to select the bank of the built-in tune that you originally used to record the lesson recording.
- 2 Use the RECORDER button to select playback standby.
- 3 Press the controller block START/STOP button.
 - This starts playback of lesson recording contents.
 - You can adjust the tempo at this point, if you want.
- 4 To stop playback, press the controller block START/STOP button again.

Recording a Performance

Use this procedure when you want to record what you play on the keyboard in real time. Performance recording records both the notes you play and any accompaniment patterns that you use.

Selecting a Track

Press the part/track button that corresponds to the track you want to select.

To select this track:	Press this button:
Track 1	LEFT/TRACK 1
Track 2	RIGHT/TRACK 2

The track that is currently selected is indicated by the part/track indicator (L or R) that appears on the display as described below.

Part/Track Indicators in Playback Standby

Each press of a part/track button toggles playback of that track on (part/track indicator displayed) and off (indicator not displayed).

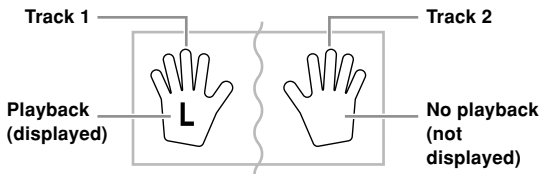

Example: The above indicates that Track 1 will be played back, while Track 2 will not.

Part/Track Indicators in Recording Standby

The part/track indicator will be displayed if its track already contains data.

Press the part/track button of the track to which you want to record (record track). This causes its part/track indicator to flash. The part/track indicator of the other track will remain displayed (without flashing) to indicate that it will playback during recording (playback track).

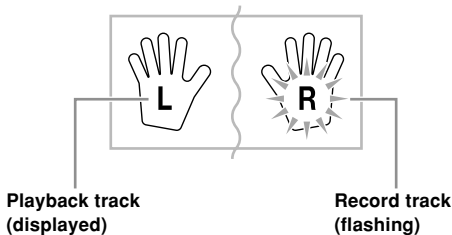

Example: The above indicates Track 1 is the playback track, and Track 2 is the record track.

To record your keyboard performances

IMPORTANT!

- Recording to a track that already contains data causes the existing data to be replaced by your new performance.

- 1 Press the RHYTHM button to enter the rhythm mode.

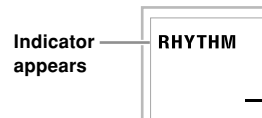

- 2 Use the RECORDER button to select record standby.
 - This causes the RECORDER indicator to flash on the display.

- 3 Press the LEFT/TRACK 1 button to select Track 1.
 - This causes the L indicator to flash, indicating that Track 1 is the recording track.

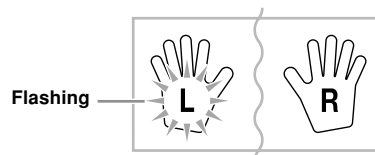

- 4 Configure the following settings as required.
 - Tone (page E-20)
 - Rhythm (page E-30)
 - MODE switch setting (page E-31)
 - Use a slower tempo if you feel you might have trouble playing properly at a faster tempo (page E-23).

- 5 Press the controller block START/STOP button.
 - This starts recording.

- 6 Play the notes you want on the keyboard.
 - Besides notes, any chords you play on the keyboard are recorded, along with their Auto Accompaniment patterns. Melody notes you play are also recorded.
 - Any pedal operations you perform while playing are also recorded.

- 7 To stop recording, press the controller block START/STOP button again.
 - If you make a mistake, you need to go back and re-record from step 2.
 - If you want to immediately hear what you recorded, press the controller block START/STOP button again.

Track 1 Data

In addition to notes played on the keyboard and chord accompaniments, the following data is also stored in Track 1 during performance recording.

- Tone number
- Rhythm number
- INTRO button, SYNCHRO/ENDING button, NORMAL/FILL-IN button, VARIATION/FILL-IN button operations
- Pedal operations
- Layer and split settings, and their tone settings
- Split point
- Tempo setting
- Effect setting

Track 1 Recording Variations

■ To record without rhythm

Skip step 5 of the above procedure.

- Recording without rhythm starts as soon as you press a keyboard key.

■ To start recording with synchro start

In place of step 5 of the above procedure, press the SYNCHRO/ENDING button.

- Now Auto Accompaniment and recording will start when you play a chord within the accompaniment keyboard range.

■ To insert an intro, ending, or fill-in into a recording

During recording, press the INTRO button, SYNCHRO/ENDING button, NORMAL/FILL-IN button, or VARIATION/FILL-IN button as required.

■ To start recording with an intro using synchro start

In place of step 5 of the above procedure, press the SYNCHRO/ENDING button and then the INTRO button.

- Now Auto Accompaniment and recording will start with an intro pattern when you play a chord within the accompaniment keyboard range.

■ To start Auto Accompaniment part way into a recording

In place of step 5 of the above procedure, press the SYNCHRO/ENDING button, and play something within the melody range of the keyboard.

- This records the melody without any accompaniment. Auto Accompaniment will start when you play a chord within the accompaniment keyboard range.

Playing Back a Performance Recording

Perform the following procedure when you want to play back a tune you recorded with performance recording.

- 1 Press the RHYTHM button to enter the rhythm mode.

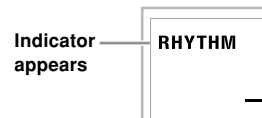

- 2 Use the RECORDER button to select playback standby.
- 3 Press the controller block START/STOP button.
 - This starts playback of performance recording contents. During playback, you can press the LEFT/TRACK 1 or RIGHT/TRACK 2 button to mute either track and listen to the contents of the other track only.
 - You can adjust the tempo at this point, if you want.
- 4 To stop playback, press the controller block START/STOP button again.

NOTE

- During performance recording playback, the entire range of the keyboard operates as a melody keyboard, regardless of the MODE switch setting. You can play along with performance recording playback, if you want. You could use layer and split (page E-45 through E-47) at this time to assign multiple tones to the keyboard.
- Note that pause, skip forward, and skip back operations cannot be performed during performance recording playback.
- You can send playback of performance recording contents as MIDI data.

Overdubbing a Performance Recording

You can use the following procedure to record a melody in Track 2 so it combines with a recording you previously made in Track 1.

- 1 Press the RHYTHM button to enter the rhythm mode.

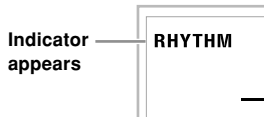

- 2 Use the RECORDER button to select record standby.
- 3 Press the RIGHT/TRACK 2 button to select Track 2 as the recording track.

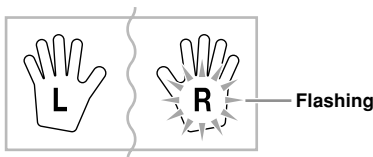

- 4 Select the tone you want to use.
- 5 Press the controller block START/STOP button.
 - This starts playback of Track 1 and recording in Track 2.
- 6 Play the melody notes you want as you listen to the playback from Track 1.
- 7 To stop recording, press the controller block START/STOP button again.
 - If you make a mistake, you need to go back and re-record from step 2.
 - If you want to immediately hear what you recorded, press the controller block START/STOP button again.

NOTE

- Track 2 is a melody-only track, which means that chord accompaniment cannot be recorded there. Because of this, the entire range of the keyboard becomes a melody keyboard when recording the Track 2, regardless of the current MODE switch setting.
- If you want to record without playback from a recorded track, enter playback standby, deselect the playback track, and then enter record standby. Note, however, that you cannot turn off rhythm and Auto Accompaniment.

Track 2 Data

In addition to notes played on the keyboard, the following data is also recorded to Track 2.

- Tone number
- Pedal operations

Deleting a Specific Part/Track

You can use the following procedure to delete a specific part/track from a lesson recording or performance recording.

Getting Ready

- When deleting a lesson recording part
 - Press the SONG BANK button.
- When deleting a performance recording track
 - Press the RHYTHM button.

- 1 Press the RECORDER button to enter record standby.
- 2 Select the part/track you want to delete by pressing the LEFT/TRACK 1 button or RIGHT/TRACK 2 button.
- 3 Hold down the RECORDER button.
 - This causes a confirmation message to appear on the display.
 - To cancel the delete operation, press the [-] (NO) button.
- 4 Press the [+] (YES) button to delete the part/track.
 - This causes the keyboard to return to playback standby.

NOTE

- Pressing the RECORDER button while the part/track delete screen is on the display returns to record standby.

Keyboard Settings

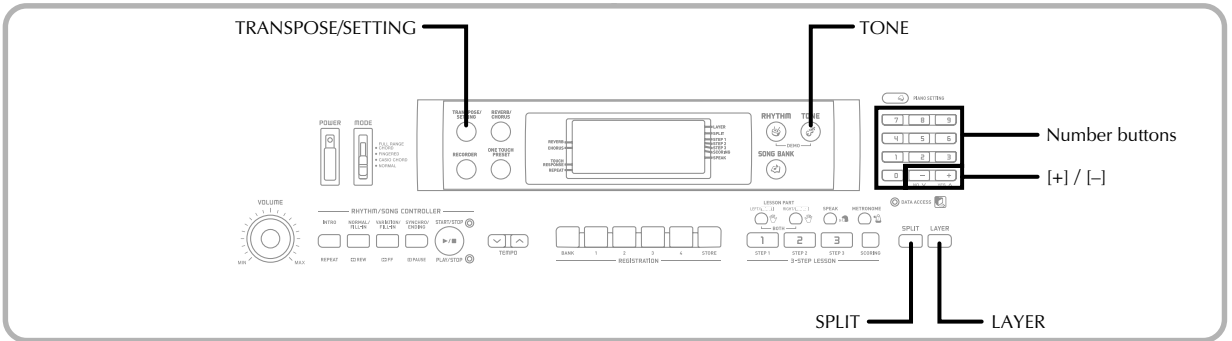

This section describes how to use layer (to play two tones with a single key) and split (to assign different tones to either end of the keyboard), and how to make touch response, transpose, and tuning settings.

Using Layer

Layer lets you assign two different tones (a main tone and a layered tone) to the keyboard, both of which play whenever you press a key. For example, you could layer the FRENCH HORN tone on the BRASS tone to produce a rich and brassy sound.

To layer tones

- 1 First select the main tone.
Example: To select "180 BRASS" as the main tone, press the TONE button and then use the number buttons or [+] and [-] buttons to input 1, 8 and then 0.



- 2 Press the LAYER button.
Example: WK-110



- 3 Select the layered tone.
Example: To select "178 FRENCH HORN" as the layered tone, use the number buttons or [+] and [-] buttons to input 1, 7 and then 8.



- 4 Now try playing something on the keyboard.
 - Both tones are played at the same time.
- 5 Press the LAYER button again to unlayer the tones and return the keyboard to normal.

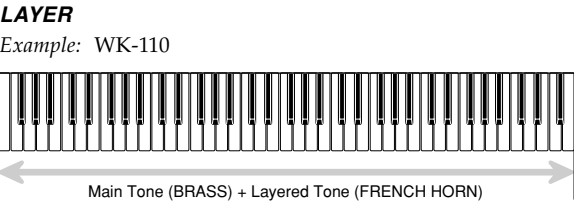

Using Split

With split you can assign two different tones (a main tone and a split tone) to either end of the keyboard, which lets you play one tone with your left hand and another tone with your right hand. For example, you could select STRINGS as the main (high range) tone and PIZZICATO STRINGS as the split (low range) tone, putting an entire string ensemble at your fingertips. Split also lets you specify the split point, which is the location on the keyboard where the changeover between the two tones occurs.

To split the keyboard

- 1 First select the main tone.

Example: To select "146 STRINGS" as the main tone, press the TONE button and then use the number buttons or [+] and [-] buttons to input 1, 4 and then 6.



- 2 Press the SPLIT button.

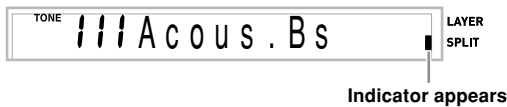

- 3 Select the split tone.

Example: To select "134 PIZZICATO STRINGS" as the split tone, use the number buttons or [+] and [-] buttons to input 1, 3 and then 4.



- 4 Specify the split point. While holding down the SPLIT button, press the keyboard where you want the leftmost key of the high end range to be.

Example: To specify G3 as the split point, press the G3 key.

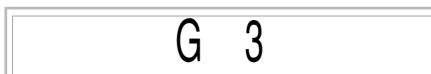

- 5 Now try playing something on the keyboard.
 - Every key from F#3 and below is assigned the PIZZICATO STRINGS tone, while every key from G3 and above is assigned the STRINGS tone.
- 6 Press the SPLIT button again to unsplit the keyboard and return it to normal.

SPLIT

Example: WK-110

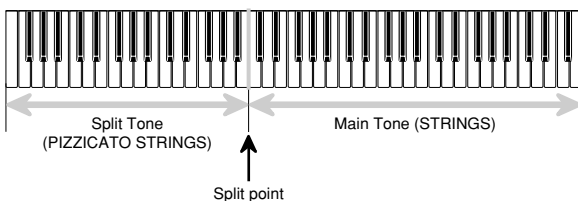

Using Layer and Split Together

You can use layer and split together to create a layered split keyboard. It makes no difference whether you layer tones first and then split the keyboard, or split the keyboard and then layer tones. When you use layer and split in combination, the high range of the keyboard is assigned two tones (main tone + layered tone), and the low range two tones (split tone + layered split tone).

To split the keyboard and then layer tones

- 1 Press the TONE button and then input the tone number of the main tone.

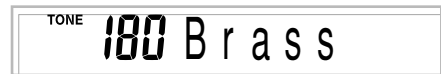

- 2 Press the SPLIT button and then input the number of the split tone.

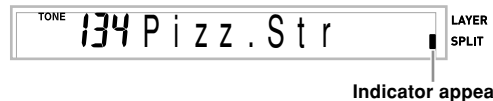

- After specifying the split tone, press the SPLIT button to unsplit the keyboard.

- 3 Press the LAYER button and then input the number of the layered tone.
 - Note that you can reverse steps 2 and 3, specifying the layered tone first and then the split tone.



- 4 Press the SPLIT button or the LAYER button so both of the SPLIT and LAYER indicators are displayed.
- 5 Input the number of the layered split tone.

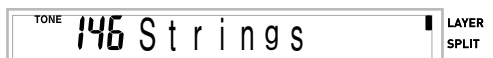

- 6 Specify the split point.
 - While holding down the SPLIT button, press the keyboard where you want the leftmost key of the low end range to be.

- Play something on the keyboard.
 - Press the LAYER button to unlayer the keyboard, and the SPLIT button to unsplit it.

LAYER SPLIT

Example: WK-110

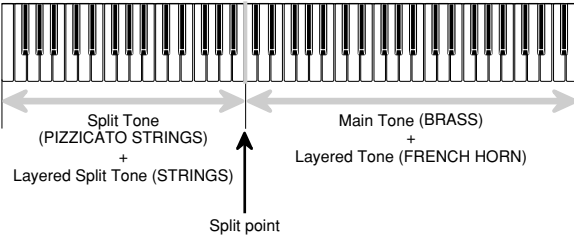

About TRANSPOSE/SETTING button

Each press of the TRANSPOSE/SETTING button cycles through the setting screens. If you accidentally pass the screen you want to use, keep pressing the TRANSPOSE/SETTING button until the screen appears again.

Transposing the Keyboard

Transpose lets you raise and lower the overall key of the keyboard in semitone units. If you want to play an accompaniment for a vocalist who sings in a key that's different from the keyboard, for example, simply use transpose to change the key of the keyboard.

To transpose the keyboard

- Press the TRANSPOSE/SETTING button until the transpose setting screen appears.



- Use the number buttons or the [+]/[-] buttons to change the key of the keyboard.

Example: To transpose the keyboard five semitones upwards.



NOTE

- The keyboard can be transposed within a range of -12 (one octave downwards) to +12 (one octave upwards).
- The default transpose setting is "00" when keyboard power is turned on.

- If you leave the transpose screen on the display for about five seconds without doing anything, the screen is automatically cleared.
- The transpose setting also affects playback from memory and Auto Accompaniment.
- To return the keyboard to its default key, perform the above procedure and press both of the [+] and [-] buttons at the same time in step 2.
- The effect of a transpose operation depends on the pitch of each note and on the tone you are currently using. If a transpose operation causes a note to be outside of the allowable range for a tone, the same note in the nearest octave within the range will be substituted.

Adjusting Accompaniment and Song Bank Volume

You can adjust the volume of the accompaniment and Song Bank tunes independently of the notes you play on the keyboard. You can specify a volume level in the range of 000 (minimum) to 127 (maximum).

To adjust the accompaniment volume

- Press the TRANSPOSE/SETTING button until the accompaniment volume adjustment screen appears.



Current accompaniment volume setting

- Use the number buttons or the [+]/[-] buttons to change the current volume setting value.

Example: 110



NOTE

- The current accompaniment volume value that appears in Step 1 automatically clears from the display if you do not input anything within about five seconds.

To adjust built-in tune volume

Enter the Song Bank mode, and then perform the procedure under "To adjust the accompaniment volume".

- In this case, a song volume screen will appear in place of the accompaniment volume screen.

Using Touch Response

When touch response is turned on, the relative volume of sound output by the keyboard is varied in accordance with the amount of pressure applied, just like an acoustic piano.

Touch response provides a choice of three settings, described below.

OFF: This setting turns off touch response. Keyboard pressure does not have any effect on the output notes.

1: This setting provides touch response that is suited for normal play.

2: This setting increases touch response, so stronger keyboard pressure has a greater effect than the "1" setting.

- 1 Press the TRANSPOSE/SETTING button until the TOUCH RESPONSE SELECT screen appears.



- 2 Use the [+], [-], and [0] and [1] buttons to change the setting.

Example: To select touch response 2.



- Touch response is on when touch response indicator is on.

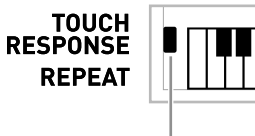

Indicator appears

- Touch response is off when touch response indicator is off.



NOTE

- Recording playback and accompaniment do not affect the touch response setting.

Tuning the Keyboard

Use the following procedure to fine tune the keyboard to match the tuning of another musical instrument.

To tune the keyboard

- 1 Press the TRANSPOSE/SETTING button until the tuning screen appears.



- 2 Use the [+], [-], and the number buttons to adjust the tuning value.

Example: To lower tuning by 20



NOTE

- The keyboard can be tuned within a range of -50 cents to +50 cents.
 - * 100 cents is equivalent to one semitone.
- The default tuning setting is "00" when keyboard power is turned on.
- If you leave the tuning screen on the display for about five seconds without doing anything, the screen is automatically cleared.
- The tuning setting also affects playback from recorder and Auto Accompaniment.
- To return the keyboard to its default tuning, perform the above procedure and press the [+], and [-] buttons at the same time in step 2.

Connection to a Computer

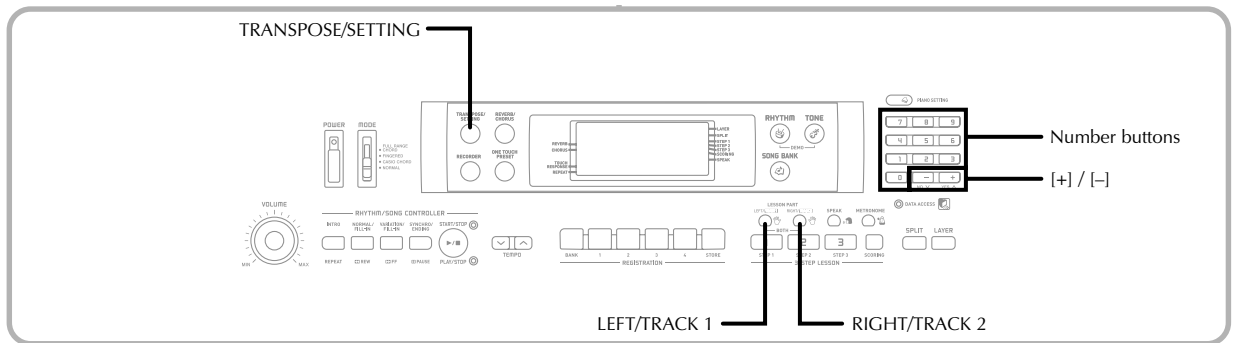

Connecting to a Computer

The keyboard's USB port makes it quick and simple to connect to a computer. After installing the USB MIDI driver onto your computer from the CD-ROM that comes with the keyboard, you will be able to use commercially available MIDI software on your computer to exchange data between the keyboard and your computer.

To install the USB MIDI driver

- 1 On the computer to which you plan to connect, install the USB MIDI driver that comes on the CD-ROM that comes bundled with the keyboard.
 - For information about installing the USB MIDI driver, see the "CASIO USB MIDI Driver User's Guide" (manual_e.pdf) on the "USB Manual and Driver CD-ROM".

NOTE

- Before starting actual installation of USB MIDI driver, be sure to read the contents of the "readme.txt" file in the "English" folder on the CD-ROM.
- Use Adobe Reader or Acrobat Reader to access the USB MIDI driver user's guide.*
- * You need to have Adobe Reader or Acrobat Reader installed on your computer in order to view the contents of the "CASIO USB MIDI Driver User's Guide" (manual_e.pdf). If your computer does not have either Adobe Reader or Acrobat Reader installed, use the procedure below to install it.

Installing Adobe Reader (Acrobat Reader**)

- Place the "USB Manual and Driver CD-ROM" into your computer's CD-ROM drive.
- On the CD-ROM, navigate to the folder named "Adobe", open the folder named "English", and then double-click "ar601enu.exe" ("ar505enu.exe"). Follow the instructions that appear on your computer screen to install Adobe Reader.

** Adobe Reader cannot be installed on a computer running Windows 98. If your computer is running under Windows 98, double-click "ar505enu.exe" to install Acrobat Reader.

Minimum Computer system Requirements

Supported Operating Systems

Operation is supported under Windows® XP Professional, Windows® XP Home Edition, Windows® 2000 Professional, Windows® Me, Windows® 98SE, and Windows® 98.

● Universal

- IBM AT or compatible computer
- USB port that provides normal operation under Windows
- CD-ROM drive (for installation)
- At least 2MB of free hard disk space (not including space required for Adobe Reader)

● Windows XP

- 300MHz or higher Pentium processor
- At least 128MB of memory

● Windows 2000

- 166MHz or higher Pentium processor
- At least 64MB of memory

● Windows Me, Windows 98SE, Windows 98

- 166MHz or higher Pentium processor
- At least 32MB of memory

NOTE

- Company and product names used herein are trademarks of their respective owners.

Using the USB port

Note that you need to purchase a commercially available USB cable to connect the keyboard to a computer using the USB port.

To connect to a computer using the USB port

- 1 Use a commercially available USB cable to connect the keyboard to the computer.

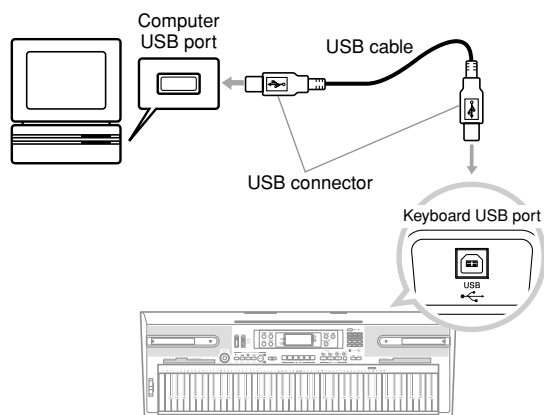

DATA ACCESS Lamp

- The DATA ACCESS lamp lights whenever the keyboard is exchanging data with a connected computer over a USB cable connection. Never disconnect the USB cable while the DATA ACCESS lamp is lit.

Expanding the Selections in the Song Bank Tunes

You can transfer song data from your computer to the keyboard. You can store up to 5 tunes as Song Bank tunes 101 through 105. For SMF data you purchase or create, you need to use an SMF Converter to convert it to CASIO format before transferring it to the keyboard.

To install the SMF Converter

- 1 On the computer to which you plan to connect, install the SMF Converter that comes on the CD-ROM that comes bundled with the keyboard.
 - On the CD-ROM, double-click "SMFConv-e.exe", and then follow the instructions that appear on your computer screen to install SMF Converter.

- Before installing SMF Converter, be sure to read the contents of the "smfreadme.txt" file in each language folder on the CD-ROM.

For information about using SMF Converter, double-click "index.html" in the [help] folder, which was created when you installed SMF Converter. You can also access user documentation from the Windows [Start] menu by clicking [Programs] - [CASIO] - [SMF Converter] - [manual].

- A browser that supports frames (like Internet Explorer 4 or Netscape Navigator 4.04 or higher) is required to view the SMF Converter manual.

Minimum Computer System Requirements

- Operating System:

Windows 98SE

Windows Me

Windows XP Home Edition/XP Professional

- Storage

At least 10MB free HDD space

- USB interface

- You can also obtain a copy of the SMF Converter by downloading it at the Web page shown below. After downloading, install the software on your computer.

CASIO MUSIC SITE

<http://music.casio.com/>

- In addition to the software itself, the CASIO MUSIC SITE will also provide you with information about its installation and use. You can also find out about the latest news about your keyboard and other CASIO musical instruments, and much more.



Song Data Storage

Song data saved as Song Bank tunes are retained even when power is turned off, as long as the keyboard is being supplied battery or AC adaptor power. If you remove the batteries or should the batteries go dead while the keyboard is not being supplied power by the AC adaptor, song data will be deleted. Be sure to supply power to the keyboard with the AC adaptor when replacing batteries.

NOTE

- This keyboard supports SMF 0 and 1 format data.
- Voice Fingering Guide, on-screen fingering indicators, and voice announcement of evaluation points are not supported for SMF data you purchase or create.

Using the SMF Data on the Bundled CD-ROM

The CD-ROM that comes bundled with the keyboard contains demos as well as 25 tunes (SMF data) that you can use for step lessons. It also contains PDF format files that contain the sheet music of the included tunes. For a full list of the tunes that are included, open the "List.txt" file located inside the "MusicDataFolder" on the CD-ROM. For each tune, "List.txt" shows the tune name, SMF file name, PDF file name of the music score, and the type of lesson* for which the tune can be used.

★ A tune marked with an asterisk (*) can be used for a both-hand lesson. A tune that is not marked with an asterisk can be used for a right-hand lesson.

NOTE

- You can load SMF data from the CD-ROM to the keyboard using the SMF converter tool (page E-50).
- You will need to have Adobe Reader or Acrobat Reader installed on your computer in order to view the contents of a music score PDF file. If neither of these applications is installed on your computer, see "Installing Adobe Reader (Acrobat Reader)" on page E-49.

General MIDI Tone

The General MIDI standard defines the tone numbering sequence, the drum sound numbering sequence, the number of MIDI channels that can be used, and other general factors that determine the sound source configuration. Because of this, musical data produced on a General MIDI sound source can be played back using similar tones and identical nuances as the original, even when played on another manufacturer's sound source.

This keyboard conforms with General MIDI standards, so it can be connected to a computer and used to play back General MIDI data that has been purchased, downloaded from the Internet, or obtained from any other source.

Changing the Settings

This section tells you how to make the settings required when connecting to a computer.

KEYBOARD CHANNEL (Default: 1)

The keyboard channel is the channel used to send messages from this keyboard to a computer. You can specify one channel from 1 to 16 as the keyboard channel.

- 1 Press the TRANSPOSE/SETTING button until the KEYBOARD CHANNEL screen appears.

01 Keybd Ch

- 2 Use the [+], [-], and the number buttons to change the channel number.

Example: To specify channel 4

04 Keybd Ch

NAVIGATE CHANNEL (Default: 4)

When messages are received from a computer for play on this keyboard, the navigate channel is the channel whose note data appears on the display. You can select one channel from 01 to 16 as the navigate channel. Since this setting lets you use the data on any channel of commercially available SMF data to light on the on-screen keyboard guide, you can analyze how different parts of an arrangement are played.

- 1 Press the TRANSPOSE/SETTING button until the NAVIGATE CHANNEL screen appears.

04 Navi. Ch

- 2 Use the [+], [-], and the number buttons [0] through [9] to change the channel number.
Example: To specify channel 2

02 Navi. Ch

To turn off specific sounds before playing back tune data that is being received

<<Navigate channel on/off>>

- 1 While playing tune data, press the RIGHT/TRACK 2 button.
 - This cuts the sound of the navigate channel, but on-screen keyboard guide keys continue to light in accordance with the channel's data as it is received. Press RIGHT/TRACK 2 button again to turn the channel back on.

<<Next lower channel from navigate channel on/off>>

- 1 While playing tune data, press the LEFT/TRACK 1 button.
 - This cuts the sound of the channel whose number is one less than the navigate channel, but on-screen keyboard guide keys continue to light in accordance with the channel's data as it is received. Press LEFT/TRACK 1 button again to turn the channel back on.
- Example:* If the navigate channel is channel 4, the above operation turns off channel 3.

LOCAL CONTROL (Default: On)

oFF: Anything played on the keyboard is output as a message from the USB port, without being sounded by the internal sound source.

- Note that no sound is produced by the keyboard if LOCAL CONTROL is turned off and no external device is connected.

- 1 Press the TRANSPOSE/SETTING button until the LOCAL CONTROL screen appears.

Example: When LOCAL CONTROL is on

on Local

- 2 Use the [+] and [-] or [0] and [1] buttons to turn the setting on and off.

Example: To turn LOCAL CONTROL off

off Local

ACCOMP OUT (Default: Off)

on: Auto Accompaniment is played by the keyboard and the corresponding message is output from the USB port.

oFF: Auto Accompaniment messages are not output from the USB port.

- 1 Press the TRANSPOSE/SETTING button until the ACCOMP OUT screen appears.

Example: When ACCOMP OUT is off

off AcompOut

- 2 Use the [+] and [-] or [0] and [1] buttons to turn the setting on and off.

Example: To turn ACCOMP OUT on

on AcompOut



SUSTAIN/ASSIGNABLE JACK (Default: SUS)

SUS(sustain): Specifies a sustain*¹ effect when the pedal is depressed.

SoS (sostenuto): Specifies a sostenuto*² effect when the pedal is depressed.

SFt (soft): Specifies reduction of the sound's volume when the pedal is depressed.

rHy (rhythm): Specifies START/STOP button operation when the pedal is depressed.

- 1 Press the TRANSPOSE/SETTING button until the SUSTAIN/ASSIGNABLE JACK screen appears.

Example: When sustain is currently set

SUS Jack

- 2 Use the [+] and [-] or [0], [1], [2], and [3] buttons to change the setting.

Example: To select rhythm

rHY Jack

*1 Sustain

With piano tones and other sounds that decay, the pedal acts as a damper pedal, with sounds being sustained longer when the pedal is depressed. With organ tones and other continuous sounds, notes played on the keyboard continue to sound until the pedal is released. In either case, the sustain effect is also applied to any notes that are played while the pedal is depressed.

*2 Sostenuto

This effect performs the same way as sustain, except that it is applied only to notes that are sounding already when the pedal is depressed. It does not affect notes that are played after the pedal is depressed.

Troubleshooting

Problem	Possible Cause	Action	See page
No keyboard sound	<ol style="list-style-type: none"> 1. Power supply problem. 2. Power is not turned on. 3. Volume setting is too low. 4. The MODE switch is in the CASIO CHORD or FINGERED position. 5. LOCAL CONTROL is off. 	<ol style="list-style-type: none"> 1. Correctly attach the AC adaptor, make sure that batteries poles (+/-) are facing correctly, and check to make sure that batteries are not dead. 2. Press the POWER button to turn on power. 3. Use the VOLUME knob to increase volume. 4. Normal play is not possible on the accompaniment keyboard while the MODE switch is set to CASIO CHORD or FINGERED. Change the MODE switch setting to NORMAL. 5. Turn on LOCAL CONTROL. 	<p>Pages E-15, 16</p> <p>Page E-20</p> <p>Page E-20</p> <p>Page E-31</p> <p>Page E-52</p>
Any of the following symptoms while using battery power.	Low battery power	Replace the batteries with a set of new ones or use the AC adaptor.	Pages E-15, 16
<ul style="list-style-type: none"> • Dim power supply indicator • Instrument does not turn on • Dim, difficult to read display • Abnormally low speaker/headphone volume • Distortion of sound output • Occasional interruption of sound when playing at high volumes • Sudden power failure when playing at high volumes • Dimming of the display when playing at high volume • Continued sound output even after you release a key • A totally different tone may sound • Abnormal rhythm pattern and demo tune play 			
Auto Accompaniment does not sound.	Accompaniment volume is set to 000.	Use the TRANSPOSE/SETTING button to increase the volume.	Page E-47
Sound output does not change when key pressure is varied.	Touch response is turned off.	Press the TRANSPOSE/SETTING button to turn it on.	Page E-48
On-screen keyboard guide keys stay on.	Keyboard is waiting for play of the correct note during Step 1 or Step 2 play.	<ol style="list-style-type: none"> 1. Press the lit key to continue with Step 1 or Step 2 play. 2. Press the PLAY/STOP button to quit Step 1 or Step 2 play. 	Pages E-27, 28 Pages E-27, 28
When playing with another instrument, keys or tunings do not match.	Transpose or tuning is set to a value other than 00.	Use the TRANSPOSE/SETTING button to display the applicable setting screens and set both transpose and tuning to 00.	Page E-47



Problem	Possible Cause	Action	See page
Cannot record Auto Accompaniment or rhythm.	Track other than Track 1 is selected as the recording track.	Use the track select buttons to select Track 1. (Track 2 is melody track.)	Page E-41
Cannot record chord accompaniment data on a computer.	ACCOMP OUT is turned off.	Turn on ACCOMP OUT.	Page E-52
After transferring song data from my computer, playback stops part way through.	Digital noise from the USB cable or power cord caused data communication between your computer and keyboard to be interrupted.	Stop playback, disconnect the USB cable from and then reconnect it to the keyboard's USB port, and then try playing back the tune again. If this does not correct the problem, exit the MIDI software you are using, and then disconnect the USB cable from and then reconnect it to the keyboard's USB port. Next, restart your MIDI software and try playback again.	Page E-50
A tone's quality and volume sounds slightly different depending where it is played on the keyboard.	<p>This is an unavoidable result of the digital sampling process,* and does not indicate malfunction.</p> <p>* Multiple digital samples are taken for the low range, middle range, and high range of the original musical instrument. Because of this, there may be a very slight difference in tonal quality and volume between sample ranges.</p>		

Specifications

Models:	CTK-810/WK-110
Keyboard:	CTK-810: 61 standard-size keys, WK-110: 76 standard-size keys (with touch response on/off)
Tones:	515; with layer and split
Polyphony:	32 notes maximum (16 for certain tones)
Auto Accompaniment Rhythm Patterns: Tempo: Chords: Rhythm Controller: Accomp Volume: One Touch Presets:	120 Variable (226 steps, ♩ = 30 to 255) 3 fingering methods (CASIO CHORD, FINGERED, FULL RANGE CHORD) START/STOP, INTRO, NORMAL/NORMAL FILL-IN, VARIATION/ VARIATION FILL-IN, SYNCHRO/ENDING 0 to 127 (128 steps) Recalls settings for tone, tempo, layer, split, reverb, and chorus.
3-step Lesson: Playback: Evaluation Mode: Voice Fingering Guide:	3 lessons (Step 1, 2, 3) Repeat play of a single tune Scoring On/Off
Song Bank Number of Tunes: Controllers:	Song Bank: 100, download songs: Up to 5 (Capacity: Approximately 70 KB*) * Calculated based on 1 KB = 1024 bytes. PLAY/STOP, PAUSE, FF, REW, REPEAT, LEFT/RIGHT
Musical Information Function:	Tone, Auto Accompaniment, Song Bank, numbers and names; staff notation, tempo, metronome, measure and beat number, step lesson display, chord name, fingering, pedal operation, Keyboard, Voice Fingering Guide, Evaluation Mode, Recorder indicator
Metronome: Beat Specification:	On/Off 0, 2 to 6
Registration Memory: Number of Setups:	32 (4 setups × 8 banks)
Recorder Number of Songs: Recorded Data: Recording Method: Memory Capacity:	Two (1 Lesson Recording, 1 Performance Recording) Lesson Recording: Right-hand part, left-hand part, both-hand parts Performance Recording: Track 1 (chord accompaniment), Track 2 (melody) Real-time Approximately 12,000 notes (total for two songs)
Other Functions Transpose: Tuning:	25 steps (-12 semitones to +12 semitones) 101 steps (A4 = approximately 440Hz ±50Cents)
Terminals USB port: Sustain/Assignable Jack: Headphone/Output Terminal:	TYPE B Standard jack (sustain, sostenuto, soft, rhythm start/stop) Stereo standard jack <CTK-810> Output Impedance: 150Ω, Output Voltage: 4.5V (RMS) MAX <WK-110> Output Impedance: 200Ω, Output Voltage: 5.2V (RMS) MAX
Power Jack:	9V DC
Power Supply: Batteries: Battery Life: AC Adaptor: Auto Power Off:	2-way CTK-810: 6 AA-size batteries, WK-110: 6 D-size batteries CTK-810: Approximately 2.5 hours continuous operation on alkaline batteries WK-110: Approximately 6 hours continuous operation on manganese batteries AD-5 Turns power off approximately 6 minutes after last key operation. Enabled under batter power only, can be disabled manually.

Speaker Output:	2.5W + 2.5W
Power Consumption:	9V \approx 7.7W
Dimensions:	CTK-810: 94.5 × 37.3 × 13.1 cm (37 ¹ / ₄ × 14 ¹¹ / ₁₆ × 5 ¹ / ₈ inch) WK-110: 118.7 × 40.0 × 15.3 cm (46 ³ / ₄ × 15 ³ / ₄ × 6 inch)
Weight:	CTK-810: Approximately 4.8 kg (10.6 lbs)(without batteries) WK-110: Approximately 7.0 kg (15.4 lbs)(without batteries)

- Design and specifications are subject to change without notice.

Operating Precautions

Be sure to read and observe the following operating precautions.

■ Location

Avoid the following locations for this product.

- Areas exposed to direct sunlight and high humidity
- Areas subjected to temperature extremes
- Near a radio, TV, video deck, or tuner

The above devices will not cause malfunction of the product, but interference from the product can cause audio or video interference of a nearby device.

■ User Maintenance

- Never use benzene, alcohol, thinner, or other chemical agents to clean the product.
- To clean the product or its keyboard, wipe with a soft cloth moistened in a weak solution of water and a mild neutral detergent. Wring all excess moisture from the cloth before wiping.

■ Included and Optional Accessories

Use only accessories that are specified for use with this product. Use of unauthorized accessories creates the risk of fire, electric shock, and personal injury.

■ Weld Lines

Lines may be visible on the exterior of the product. These are "weld lines" that result from the plastic molding process. They are not cracks or scratches.

■ Musical Instrument Etiquette

Always be aware of others around you whenever using this product. Be especially careful when playing late at night to keep the volume at levels that do not disturb others. Other steps you can take when playing late at night are closing the window and using headphones.

- Any reproduction of the contents of this manual, either in part or its entirety, is prohibited. Except for your own, personal use, any other use of the contents of this manual without the consent of CASIO is prohibited under copyright laws.
- IN NO EVENT SHALL CASIO BE LIABLE FOR ANY DAMAGES WHATSOEVER (INCLUDING, WITHOUT LIMITATION, DAMAGES FOR LOSS OF PROFITS, BUSINESS INTERRUPTION, LOSS OF INFORMATION) ARISING OUT OF THE USE OF OR INABILITY TO USE THIS MANUAL OR PRODUCT, EVEN IF CASIO HAS BEEN ADVISED OF THE POSSIBILITY OF SUCH DAMAGES.
- The contents of this manual are subject to change without notice.

Tone List/Lista de sonidos

- ①: No./N°
- ②: Bank Select MSB/MSB de selección de banco
- ③: Tone Name/Nombre de sonido
- ④: Maximum Polyphony/Polifonía máxima
- ⑤: Program Change/Cambio de programa
- ⑥: Range Type/Tipo de gama

①	②	③	④	⑤	⑥
PIANO					
001	STEREO GRAND PIANO	0	2	16	A
002	GRAND PIANO	0	1	32	A
003	BRIGHT PIANO	1	2	16	A
004	MELLOW PIANO	0	3	16	A
005	MODERN PIANO	1	3	16	A
006	DANCE PIANO	1	1	16	A
007	STRINGS PIANO	0	8	16	A
008	SYNTH-STR PIANO	1	5	16	A
009	HONKY-TONK	3	2	16	A
010	1 OCTAVE PIANO	3	9	16	A
011	2 OCTAVE PIANO	3	8	16	A
012	ELEC.GRAND PIANO	2	2	16	A
013	MODERN E.G.PIANO	2	3	16	A
014	STEREO PIANO	0	4	16	A
015	STEREO PIANO WIDE	0	9	16	A
016	PIANO PAD	0	5	16	A
017	HARPSICHORD	6	2	32	A
018	COUPLD HARPSICHORD	6	8	16	A
019	HARPSICHORD PAD	6	1	16	A
ELECTRIC PIANO					
020	ELEC.PIANO 1	4	2	32	A
021	ELEC.PIANO 2	5	3	16	A
022	FM ELEC.PIANO	5	5	16	A
023	DYNO ELEC.PIANO	4	7	32	A
024	60'S ELEC.PIANO	4	5	32	A
025	CHORUS EP 1	4	9	16	A
026	CHORUS EP 2	4	6	16	A
027	MODERN E.PIANO	5	2	16	A
028	SOFT E.PIANO	4	8	16	A
029	E.PIANO PAD 1	5	8	16	A
030	SYNTH-STR. E.PIANO	4	3	16	A
031	E.PIANO PAD 2	4	1	16	A
032	CLEAN E.PIANO	4	4	32	A
033	HARPSICHORD E.PIANO	5	4	16	A
034	SOFT CLAVI	7	2	32	A
035	CLAVI & DRAWBAR	7	1	32	A
036	CLAVI & DRAWBAR	7	3	16	A
037	DETUNE CLAVI	7	8	16	A
038	SEQUENCE CLAVI	7	9	16	A
CHROMATIC PERC.					
039	CELESTA	8	2	32	A
040	GLOCKENSPIEL	9	2	32	B
041	MUSIC BOX	10	2	16	A
042	VIBRAPHONE	11	2	32	A
043	MARIMBA	12	2	32	A
044	GLOCKENSPIEL PAD	9	3	16	A
045	SYNTH-VIBRAPHONE	11	3	16	A
046	SYNTH-MARIMBA	12	3	16	A

①	②	③	④	⑤	⑥
047	VIBRAPHONE & MARIMBA	13	2	16	A
048	TUBULAR BELL	14	2	16	A
049	DULCIMER	15	2	16	A
050	BRIGHT CELESTA	8	1	32	A
051	CHORUS CELESTA	8	8	16	A
052	CHORUS GLOCKENSPIEL	9	8	16	B
053	CHORUS VIBRAPHONE	11	8	16	A
ORGAN					
054	DRAWBAR ORGAN 1	16	2	16	A
055	DRAWBAR ORGAN 2	16	1	16	A
056	DRAWBAR ORGAN 3	16	3	16	A
057	ROTARY DRAWBAR	17	32	32	A
058	PERC.ORGAN 1	17	2	16	A
059	PERC.ORGAN 2	17	3	16	A
060	ELEC.ORGAN 1	16	8	16	A
061	ELEC.ORGAN 2	16	4	16	A
062	JAZZ ORGAN 1	17	4	16	A
063	ROCK ORGAN	18	2	16	A
064	CHURCH ORGAN	19	2	16	A
065	CHAPEL ORGAN	19	8	32	A
066	FEED ORGAN	20	2	16	A
067	ACCORDION 1	21	2	16	A
068	OCTAVE ACCORDION	21	8	16	A
069	BANDNEON	22	2	16	A
070	HARMONICA 1	23	2	32	A
071	HARMONICA 2	22	8	16	A
072	THEATER	19	6	16	A
073	OCTAVE BANDNEON	23	3	16	A
074	DRAWBAR ORGAN 4	16	5	16	A
075	JAZZ ORGAN 2	17	6	16	A
076	ROCK ORGAN 2	18	1	16	A
077	DRAWBAR ORGAN 5	16	6	16	A
078	JAZZ ORGAN 3	17	8	16	A
079	PERC.ORGAN 3	17	1	16	A
080	8'ORGAN	17	5	16	A
081	ROCK ORGAN 3	18	3	16	A
082	ROCK ORGAN 4	18	4	16	A
083	FULL DRAWBAR	16	9	32	A
084	ORGAN PAD	17	7	16	A
085	SEQUENCE ORGAN	7	16	16	A
086	PIPE ORGAN 1	19	1	32	A
087	PIPE ORGAN 2	19	3	32	A
088	ORGAN & HARPSICHORD	19	4	16	A
089	PIPE ORGAN PAD	19	5	16	A
090	ACCORDION 2	21	3	32	A
091	BANDNEON SOLO	23	1	16	A
092	BANDNEON & VIOLIN	23	4	16	A
GIUITAR					
093	NYLON STR. GUITAR	24	2	32	C

①	②	③	④	⑤	⑥
094	STEEL STR.GUITAR 1	25	2	32	C
095	STEEL STR.GUITAR 2	25	4	32	C
096	12 STR.GUITAR	25	8	16	C
097	JAZZ GUITAR	26	2	32	C
098	OCT JAZZ GUITAR	26	8	16	C
099	CLEAN GUITAR 1	27	2	32	C
100	CLEAN GUITAR 2	27	3	32	C
101	MUTE GUITAR	28	2	32	C
102	CRUNCH ELEC.GUITAR	27	8	16	C
103	OVERDRIVE GT	29	2	32	C
104	DISTORTION GT	30	2	32	C
105	POWER DIST. GT	30	5	16	C
106	RHYTHM DIST. GT	30	4	16	C
107	FEEDBACK GT	31	8	16	C
108	CHORUS STEEL GT	25	9	16	C
109	DIST.GT & BASS	30	6	16	C
110	STEEL GT HARMONICS	25	3	16	C
BASS					
111	ACOUSTIC BASS	32	2	32	C
112	RIDE BASS	32	32	16	C
113	FINGERED BASS	33	2	32	C
114	PICKED BASS	34	2	32	C
115	FRETLESS BASS	35	2	32	C
116	SLAP BASS	37	2	32	C
117	DOUBLED STRINGS BASS	37	3	16	C
118	SAW SYNTH-BASS	38	2	32	C
119	SQR SYNTH-BASS	39	2	32	C
120	VOCODER BASS	38	3	32	C
121	DIGI ROCK BASS	39	1	32	C
122	SOUL SYNTH-BASS	38	4	32	C
123	TRANCE BASS	38	4	32	C
124	MELLOW FINGERED BASS	33	3	32	C
125	BASS & KICK	39	3	16	C
126	CLAVI BASS	39	4	16	C
127	RHYTHM PICKED BASS	34	3	32	C
128	RHYTHM FINGERED BASS	33	4	32	C
129	SINE BASS	39	6	32	A
130	ORGAN BASS	39	5	32	A
STR/ORCHESTRA					
131	VIOLIN	40	2	32	A
132	SLOW VIOLIN	40	8	32	A
133	CELLO	42	2	32	C
134	PIZZICATO STRINGS	45	2	32	A
135	HARP 1	46	2	32	A
136	DOUBLE VIOLIN	40	1	16	A
137	SLOW CELLO	42	8	32	C
138	VIOLIN SECTION	40	4	16	A
139	SLOW VIOLIN SECTION	40	9	16	A
140	PIZZICATO ENSEMBLE	45	1	16	A

1	2	3	4	5	6
247	CALLIOPE 1	82	2	16	A
248	VENT LEAD	82	5	16	A
249	CHIFF LEAD 1	83	2	16	A
250	DROP LEAD	83	4	16	A
251	EP LEAD	85	1	16	A
252	VOICE LEAD 1	85	2	16	A
253	BASS+LEAD	87	2	16	A
254	SQUARE LEAD 2	80	3	16	A
255	SLOW SQUARE LEAD	80	4	16	A
256	SLOW SQUARE PULSE	80	6	16	A
257	SEQUENCE SQUARE	80	7	16	A
258	SEQUENCE PULSE 1	80	16	16	A
259	SQUARE LEAD 3	80	1	32	A
260	SQUARE LEAD 4	80	32	16	A
261	SAW LEAD 2	81	1	32	A
262	SLOW SAW LEAD	81	4	16	A
263	PULSE SAW LEAD	81	5	16	A
264	SLOW SAW PULSE	81	6	16	A
265	FIFTH SEQUENCE	86	1	16	A
266	SEQUENCE PULSE 2	81	9	16	A
267	SEQUENCE SAW 2	81	16	16	A
268	CALLIOPE 2	82	3	16	A
269	VENT SYNTH	82	1	16	A
270	PURE LEAD	82	4	16	A
271	DISTORTION LEAD	84	8	16	A
272	OCTAVE CHARANG	84	2	16	A
273	VOICE LEAD 2	85	3	16	A
274	CHURCH LEAD	85	4	16	A
275	DOUBLE VOICE LEAD	85	8	16	A
276	VOICE CHOIR LEAD	85	5	16	A
277	EP & VOICE LEAD	85	6	16	A
278	SYNTH-VOICE LEAD	85	7	16	A
279	FIFTH SAW LEAD	86	2	16	A
280	FIFTH SQUARE LEAD	86	3	16	A
281	BASS+SAW LEAD	87	1	16	A
282	SYNTH-BASS+LEAD	87	3	16	A
SYNTH-PAD					
283	FANTASY 1	88	2	16	A
284	FANTASY 2	88	3	16	A
285	WARM PAD	89	2	16	A
286	WARM VOX	89	8	16	A
287	SINE PAD	89	3	16	A
288	POLY/SYNTH 1	90	2	16	A
289	POLY SAW	90	8	16	A
290	POLY/SYNTH PAD 1	90	5	16	A
291	SPACE STRINGS PAD	91	3	16	A
292	BOWED PAD	92	2	16	A
293	GLASS PAD	92	3	16	A
294	ETHNIC PAD	93	2	16	A
295	HALO PAD 1	94	2	16	A
296	HALO PAD 2	94	3	16	A
297	RAIN DROP 1	96	2	16	A
298	SOUND TRACK 1	97	2	16	A
299	RAVE	97	8	16	A
300	CRYSTAL	98	2	32	A

1	2	3	4	5	6
194	TUBA 2	58	3	32	C
195	FRENCH HORN SOLO	60	8	32	C
196	MELLOW BRASS	61	1	32	A
197	ANALOG SYNTH-BRASS 2	62	9	16	A
198	SYNTH-BRASS PAD	63	3	16	A
REED/PIPE					
199	SOPRANO SAX	64	2	32	A
200	ALTO SAX 1	65	1	16	C
201	ALTO SAX 2	65	2	32	C
202	BREATHY A SAX	65	8	16	C
203	HARD A SAX	65	3	16	C
204	RICH A SAX	65	6	16	C
205	TENOR SAX 1	66	1	16	C
206	TENOR SAX 2	66	2	32	C
207	BREATHY T.SAX	66	8	16	C
208	T.SAXYS	66	9	16	C
209	BARITONE SAX	67	2	32	C
210	OBOE	68	2	32	A
211	CLARINET	71	2	32	A
212	BREATHY S.SAX	64	8	16	A
213	SOFT A SAX	65	5	32	C
214	SOLO A SAX	65	4	32	C
215	SAX SECTION	65	9	16	C
216	SAX SECTION SFZ	65	7	16	C
217	DETUNE T.SAX	66	3	16	C
218	SOFT T.SAX	66	5	32	C
219	SOLO T.SAX	66	4	32	C
220	SOLO OBOE	68	4	32	A
221	VELO.CLARINET	71	4	32	A
222	PICCOLO 1	72	2	16	B
223	FLUTE 1	73	2	32	A
224	FLUTE 2	73	1	16	A
225	PURE FLUTE	73	8	16	A
226	PIPE SECTION 1	72	4	16	A
227	RECORDER	74	2	32	A
228	PAN FLUTE 1	75	2	32	A
229	BOTTLE BLOW	76	2	16	A
230	SHAKUHACHI	77	2	16	A
231	WHISTLE 1	78	2	32	A
232	OCARINA	79	2	32	A
233	PICCOLO 2	72	3	16	B
234	PIPE SECTION 2	73	4	16	A
235	SOFT FLUTE	73	5	16	A
236	WHISTLE 2	78	3	32	A
237	PAN FLUTE 2	75	3	16	A
SYNTHLEAD					
238	SQUARE LEAD 1	80	2	16	A
239	SQUARE PULSE LEAD	80	5	16	A
240	SEQUENCE LEAD	83	5	16	A
241	SAW LEAD 1	81	2	16	A
242	MELLOW SAW LEAD	81	8	16	A
243	SEQUENCE SAW 1	81	32	16	A
244	SINE LEAD	80	8	32	A
245	VELO.SINE LEAD	80	9	32	A
246	SS LEAD	81	3	16	A

1	2	3	4	5	6
141	CELLO SECTION	42	4	16	C
142	OCTAVE PIZZICATO	45	3	16	A
143	DOUBLE VIOLA	41	2	16	A
144	HARP 2	46	1	32	A
145	CHORUS HARP	46	8	16	A
ENSEMBLE					
146	STRINGS	48	2	32	A
147	SLOW STRINGS 1	49	2	32	A
148	WIDE STRINGS	48	16	16	A
149	OCTAVE STRINGS 1	48	32	16	A
150	CHAMBER	48	3	16	A
151	STRINGS SFZ	48	8	32	A
152	SYNTH-STRINGS 1	50	2	32	A
153	SYNTH-STRINGS 2	51	2	32	A
154	SYNTH-STRINGS 3	51	3	16	A
155	CHOIR/AAHS	52	2	32	A
156	CHOIRS 1	52	8	32	A
157	VOICE DOO	53	2	32	A
158	SYNTH-VOICE 1	54	2	32	A
159	SYNTH-VOICE PAD	54	8	16	A
160	ORCHESTRA HIT	55	2	16	A
161	HARP & STRINGS	50	4	16	A
162	FLUTE & STRINGS	51	4	16	A
163	ORCHESTRA STRINGS	48	4	16	A
164	SLOW STRINGS 2	49	3	32	A
165	STRINGS VOICE	49	4	16	A
166	OCTAVE STRINGS 2	48	1	16	A
167	FAST SYNTH STRINGS	50	3	32	A
168	SLOW CHOR	52	9	32	A
169	CHOIR STRINGS	52	3	16	A
170	CHOIRS 2	52	4	16	A
171	VOICE UUH	53	3	32	A
172	SYNTH-VOICE 2	54	1	32	A
173	CHORUS SYNTH-VOICE	54	9	16	A
BRASS					
174	TRUMPET	56	2	32	A
175	TROMBONE	57	2	32	C
176	TUBA 1	58	2	32	C
177	MUTE TRUMPET	59	2	32	A
178	FRENCH HORN	60	2	16	C
179	HORN ORCHESTRA	60	16	16	C
180	BRASS	61	2	32	A
181	BRASS SECTION 1	61	3	16	A
182	BRASS SFZ	61	8	16	A
183	BRASS & STRINGS	61	4	16	A
184	HARD BRASS	61	5	16	A
185	BRASS SECTION 2	61	6	16	A
186	ANALOG SYNTH-BRASS 1	62	8	16	A
187	SYNTH-BRASS 1	62	2	32	A
188	SYNTH-BRASS 2	63	2	16	A
189	TRANCE BRASS	62	1	16	A
190	MELLOW TRUMPET	56	8	32	A
191	VELO.TRUMPET	56	4	32	A
192	VELO.TROMBONE	57	4	16	C
193	MELLOW TROMBONE	57	1	32	C

1	2	3	4	5	6
409	GM SLAP BASS 1	36	0	32	A
410	GM SLAP BASS 2	37	0	32	A
411	GM SYNTH-BASS 1	38	0	32	A
412	GM SYNTH-BASS 2	39	0	32	A
413	GM VIOLA	40	0	32	A
414	GM VIOLIN	41	0	32	A
415	GM CELLO	42	0	32	A
416	GM CONTRABASS	43	0	32	A
417	GM TREMOLO STRINGS	44	0	32	A
418	GM PIZZICATO	45	0	32	A
419	GM HARP	46	0	32	A
420	GM TIMPANI	47	0	32	A
421	GM STRINGS 1	48	0	32	A
422	GM STRINGS 2	49	0	32	A
423	GM SYNTH-STRINGS 1	50	0	32	A
424	GM SYNTH-STRINGS 2	51	0	32	A
425	GM CHOIR AAHS	52	0	32	A
426	GM VOICE DOO	53	0	32	A
427	GM SYNTH-VOICE	54	0	16	A
428	GM ORCHESTRA HIT	55	0	16	A
429	GM TRUMPET	56	0	32	A
430	GM TROMBONE	57	0	32	A
431	GM TUBA	58	0	32	A
432	GM MUTE TRUMPET	59	0	32	A
433	GM FRENCH HORN	60	0	16	A
434	GM BRASS	61	0	32	A
435	GM SYNTH-BRASS 1	62	0	32	A
436	GM SYNTH-BRASS 2	63	0	16	A
437	GM SOPRANO SAX	64	0	32	A
438	GM ALTO SAX	65	0	32	A
439	GM TENOR SAX	66	0	32	A
440	GM BARITONE SAX	67	0	32	A
441	GM OBOE	68	0	32	A
442	GM ENGLISH HORN	69	0	32	A
443	GM BASSOON	70	0	32	A
444	GM CLARINET	71	0	32	A
445	GM PICCOLO	72	0	32	A
446	GM FLUTE	73	0	32	A
447	GM RECORDER	74	0	32	A
448	GM PAN FLUTE	75	0	32	A
449	GM BOTTLE BLOW	76	0	16	A
450	GM SHAKUHACHI	77	0	16	A
451	GM WHISTLE	78	0	32	A
452	GM OCARINA	79	0	32	A
453	GM SQUARE LEAD	80	0	16	A
454	GM SAW LEAD	81	0	16	A
455	GM CALLIOPE	82	0	16	A
456	GM CHIFF LEAD	83	0	16	A
457	GM CHARANG	84	0	16	A
458	GM VOICE LEAD	85	0	16	A
459	GM FIFTH LEAD	86	0	16	A
460	GM BASS+LEAD	87	0	16	A
461	GM FANTASY	88	0	16	A
462	GM WARM PAD	89	0	16	A
463	GM POLY SYNTH	90	0	16	A

1	2	3	4	5	6
355	DI ZI	72	16	32	A
356	YANG QIN & ER HU	111	8	16	A
357	ZHENG	107	1	16	A
358	SUO NA	111	32	32	A
359	PI PA 1	105	32	32	A
360	SHENG	109	8	32	A
361	KOTO PAD	107	5	16	A
362	SITAR 2	104	3	32	A
363	TAMBRA	104	4	16	A
364	SITAR PAD	104	4	32	A
365	RABAB	105	8	16	A
366	PI PA 2	105	4	16	A
367	SHAMISEN 2	106	3	16	A
368	DETUNE KOTO	107	4	16	A
369	SYNTH KOTO	107	3	16	A
370	SHAMISEN & TAIKO	106	4	16	A
371	XIAO	77	32	16	A
372	SANTUR	15	16	32	A
GM TONES					
373	GM PIANO 1	0	0	32	A
374	GM PIANO 2	1	0	16	A
375	GM PIANO 3	2	0	32	A
376	GM HONKY-TONK	3	0	16	A
377	GM E.PIANO 1	4	0	32	A
378	GM E.PIANO 2	5	0	16	A
379	GM HARPSICHORD	6	0	32	A
380	GM CLAVI	7	0	32	A
381	GM CELESTA	8	0	32	A
382	GM GLOCKENSPIEL	9	0	32	A
383	GM MUSIC BOX	10	0	16	A
384	GM VIBRAPHONE	11	0	32	A
385	GM MARIMBA	12	0	32	A
386	GM XYLOPHONE	13	0	32	A
387	GM TUBULAR BELL	14	0	32	A
388	GM DULCIMER	15	0	16	A
389	GM ORGAN 1	16	0	16	A
390	GM ORGAN 2	17	0	16	A
391	GM ORGAN 3	18	0	16	A
392	GM PIPE ORGAN	19	0	16	A
393	GM REED ORGAN	20	0	32	A
394	GM ACCORDION	21	0	16	A
395	GM HARMONICA	22	0	32	A
396	GM BANDONEON	23	0	16	A
397	GM NYLON STR.GUITAR	24	0	32	A
398	GM STEEL STR.GUITAR	25	0	32	A
399	GM JAZZ GUITAR	26	0	32	A
400	GM CLEAN GUITAR	27	0	32	A
401	GM MUTE GUITAR	28	0	32	A
402	GM OVERDRIVE GT	29	0	32	A
403	GM DISTORTION GT	30	0	32	A
404	GM GT HARMONICS	31	0	32	A
405	GM ACOUSTIC BASS	32	0	32	A
406	GM FINGERED BASS	33	0	32	A
407	GM PICKED BASS	34	0	32	A
408	GM FRETLESS BASS	35	0	32	A

1	2	3	4	5	6
301	SOFT CRYSTAL	98	1	16	A
302	ATMOSPHERE	99	2	16	A
303	BRIGHTNESS 1	100	2	16	A
304	GOBLIN	101	2	16	A
305	ECHO PAD	102	2	16	A
306	STAR THEME 1	103	2	16	A
307	SPACE PAD	103	8	16	A
308	NEW AGE PAD	88	1	16	A
309	SOFT PAD	89	4	16	A
310	HORN PAD	89	5	16	A
311	THICK PAD	89	1	16	A
312	POLY SYNTH 2	90	1	16	A
313	OLD TAPE PAD	89	6	16	A
314	POLY SYNTH PAD 2	90	4	16	A
315	HEAVEN	91	2	16	A
316	UTOPIA	91	1	16	A
317	SQUARE PAD	92	1	16	A
318	SOFT METAL PAD	93	3	16	A
319	HARD METAL PAD	93	4	16	A
320	TINE PAD	93	1	16	A
321	CHORUS PAD	94	1	16	A
322	ORGAN CHOIR PAD	94	4	16	A
323	SWEEP PAD	95	2	16	A
324	SWEEP CHOIR	95	1	16	A
325	CLAVI PAD	96	1	16	A
326	RAIN DROP 2	96	3	16	A
327	SOUND TRACK 2	97	3	16	A
328	SPACE VOICE	97	1	16	A
329	CHORAL BELL	98	16	16	A
330	GLOCKENSPIEL CHIME	98	5	16	A
331	CHRISTMAS BELL	98	3	16	A
332	VIBRAPHONE BELL	98	8	16	A
333	NYLON+EP	99	5	16	A
334	CELESTA PAD	99	1	16	A
335	BRIGHT BELL PAD	100	1	16	A
336	BRIGHTNESS 2	100	3	16	A
337	ECHO VOICE	102	1	16	A
338	ECHO DROP	102	3	16	A
339	POLY DROP	102	4	16	A
340	STAR THEME 2	103	1	16	A
ETHNIC/CHINESE					
341	SITAR 1	104	2	16	A
342	WARM SITAR	104	1	16	A
343	BANJO	105	2	32	A
344	MUTE BANJO	105	1	32	A
345	SHAMISEN 1	106	2	32	A
346	TSUGARU	106	1	32	A
347	KOTO	107	2	16	A
348	THUMB PIANO	108	2	32	A
349	SHANAI	111	2	32	A
350	STEEL DRUMS	114	2	32	A
351	ER HU 1	110	8	32	A
352	ER HU 2	110	9	32	A
353	YANG QIN 1	15	8	32	A
354	YANG QIN 2	15	9	16	A

NOTE

The meaning of each range type is described below.

NOTA

El significado de cada tipo de gama se describe debajo.

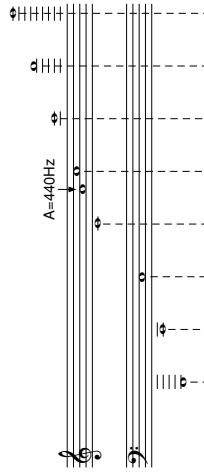

Range Type / Tipo de gama	C-1	C0 E0	C1 E1	C2 E2	C3	C4	C5	C6	G6 C7	G7 C8	G8 C9	G9
A (Standard type) (Tipo estándar)												
B (¹⁰⁰ GLOCKENSPIEL/ ¹⁰⁵ CHORUS GLOCKENSPIEL/ ²²² PICCOLO 1/ ²²³ PICCOLO 2)												
C (Low pitch) (instruments) (Instrumentos de altura tonal baja)												
D (Sound Effect) (Efecto de sonido)												

No scale for tones.
Sin escala para los sonidos.

- aKeyboard range
.....Gama del teclado
- bAvailable range (using transpose or message receive)
.....Gama disponible (usando la transposición o recepción de mensajes)
- cNotes in these ranges are produced by playing the notes in range b that are in the nearest octave as the result of transpose and message receive operations.
.....Las notas en estas gamas se producen ejecutando las notas en la gama b que se encuentre en la octava más cercana como resultado de las operaciones de transposición y recepción de mensajes.

1	2	3	4	5	6
464	GM SPACE CHOIR	91	0	16	A
465	GM BOWED GLASS	92	0	16	A
466	GM METAL PAD	93	0	16	A
467	GM HALO PAD	94	0	16	A
468	GM SWEEP PAD	95	0	16	A
469	GM RAIN DROP	96	0	16	A
470	GM SOUND TRACK	97	0	16	A
471	GM CRYSTAL	98	0	16	A
472	GM ATMOSPHERE	99	0	16	A
473	GM BRIGHTNESS	100	0	16	A
474	GM GOBLINS	101	0	16	A
475	GM ECHOES	102	0	16	A
476	GM SF	103	0	16	A
477	GM SITAR	104	0	16	A
478	GM BANJO	105	0	32	A
479	GM SHAMISEN	106	0	32	A
480	GM KOTO	107	0	32	A
481	GM THUMB PIANO	108	0	32	A
482	GM BAGPIPE	109	0	16	A
483	GM FIDDLE	110	0	32	A
484	GM SHANAI	111	0	32	A
485	GM TINKLE BELL	112	0	32	A
486	GM AGOGO	113	0	32	A
487	GM STEEL DRUMS	114	0	16	A
488	GM WOOD BLOCK	115	0	32	D
489	GM TAIKO	116	0	32	D
490	GM MELODIC TOM	117	0	32	D
491	GM SYNTH-DRUM	118	0	32	D
492	GM REVERSE CYMBAL	119	0	32	D
493	GM GT FRET NOISE	120	0	32	A
494	GM BREATH NOISE	121	0	32	A
495	GM SEASHORE	122	0	16	D
496	GM BIRD	123	0	16	D
497	GM TELEPHONE	124	0	32	D
498	GM HELICOPTER	125	0	32	D
499	GM APPLAUSE	126	0	16	D
500	GM GUNSHOT	127	0	32	D
DRUM SET					
501	STANDARD SET 1	0	120		D
502	STANDARD SET 2	1	120		D
503	STANDARD SET 3	2	120		D
504	STANDARD SET 4	4	120		D
505	ROOM SET	8	120		D
506	POWER SET	16	120		D
507	ROCK SET	65	120		D
508	HIPHOP SET	64	120		D
509	ELECTRONIC SET	24	120		D
510	SYNTH SET 1	25	120		D
511	SYNTH SET 2	30	120		D
512	TRANCE SET	31	120		D
513	JAZZ SET	32	120		D
514	BRUSH SET	40	120		D
515	ORCHESTRA SET	48	120		D

Drum Assignment List/Lista de asignación de batería

Key/No	DRUMS SET LIST										ORCHESTRA SET				
	STANDARD SET 1	STANDARD SET 2	STANDARD SET 3	STANDARD SET 4	ROOM SET	POWER SET	ROCK SET	HIP-HOP SET	ELECTRONIC SET	SYNTH SET 1		SYNTH SET 2	TRANCE SET	JAZZ SET	BRUSH SET
C-1	CA12			Standard Kick 1											
D-3				Standard Kick 3											
E-1	EA14			Standard Snare 1											
F-6	FA17			Standard Snare 3											
G-8	GA19			Standard Open Hi-Hat 1											
H-10	HA19			Standard Open Hi-Hat 2											
I-12	IA11														
J-15	JA14														
K-17	KA16														
L-18	LA19														
M-20	MA20														
N-22	NA20														
O-24	OA23														
P-25	PA25														
Q-27	QA26														
R-28	RA28														
S-29	SA29														
T-30	TA31														
U-31	UA31														
V-32	VA33														
W-33	WA33														
X-34	XA33														
Y-35	YA35														
Z-36	ZA36														
AA-37	AA37														
AB-38	AB38														
AC-39	AC39														
AD-40	AD40														
AE-41	AE41														
AF-42	AF42														
AG-43	AG43														
AH-44	AH44														
AI-45	AI45														
AJ-46	AJ46														
AK-47	AK47														
AL-48	AL48														
AM-49	AM49														
AN-50	AN50														
AO-51	AO51														
AP-52	AP52														
AQ-53	AQ53														
AR-54	AR54														
AS-55	AS55														
AT-56	AT56														
AU-57	AU57														
AV-58	AV58														
AW-59	AW59														
AX-60	AX60														
AY-61	AY61														
AZ-62	AZ62														
BA-63	BA63														
BB-64	BB64														
BC-65	BC65														
BD-66	BD66														
BE-67	BE67														
BF-68	BF68														
BG-69	BG69														
BH-70	BH70														
BI-71	BI71														
BJ-72	BJ72														
BK-73	BK73														
BL-74	BL74														
BM-75	BM75														
BN-76	BN76														
BO-77	BO77														
BP-78	BP78														
BQ-79	BQ79														
BR-80	BR80														
BS-81	BS81														
BT-82	BT82														
BV-83	BV83														
BW-84	BW84														
BX-85	BX85														
BY-86	BY86														
BZ-87	BZ87														
CA-88	CA88														
CB-89	CB89														
CC-90	CC90														
CD-91	CD91														
CE-92	CE92														
CF-93	CF93														
CG-94	CG94														
CH-95	CH95														
CI-96	CI96														
CJ-97	CJ97														
CK-98	CK98														
CL-99	CL99														
CM-100	CM100														

Key/ Note number	DRUMS SET LIST															
	STANDARD SET 1	STANDARD SET 2	STANDARD SET 3	STANDARD SET 4	ROOM SET	POWER SET	ROCK SET	HIP-HOP SET	ELECTRONIC SET	SYNTH SET 1	SYNTH SET 2	TRANCE SET	JAZZ SET	BRUSH SET	ORCHESTRA SET	
F7 105	---	---	---	---	---	---	---	---	---	---	---	---	---	---	---	---
F7 106	---	---	---	---	---	---	---	---	---	---	---	---	---	---	---	---
F7 107	---	---	---	---	---	---	---	---	---	---	---	---	---	---	---	---
F7 108	---	---	---	---	---	---	---	---	---	---	---	---	---	---	---	---
F7 109	---	---	---	---	---	---	---	---	---	---	---	---	---	---	---	---
F7 110	---	---	---	---	---	---	---	---	---	---	---	---	---	---	---	---
F7 111	---	---	---	---	---	---	---	---	---	---	---	---	---	---	---	---
F7 112	---	---	---	---	---	---	---	---	---	---	---	---	---	---	---	---
F7 113	---	---	---	---	---	---	---	---	---	---	---	---	---	---	---	---
F7 114	---	---	---	---	---	---	---	---	---	---	---	---	---	---	---	---
F7 115	---	---	---	---	---	---	---	---	---	---	---	---	---	---	---	---
F7 116	---	---	---	---	---	---	---	---	---	---	---	---	---	---	---	---
F7 117	---	---	---	---	---	---	---	---	---	---	---	---	---	---	---	---
F7 118	---	---	---	---	---	---	---	---	---	---	---	---	---	---	---	---
F7 119	---	---	---	---	---	---	---	---	---	---	---	---	---	---	---	---
F7 120	---	---	---	---	---	---	---	---	---	---	---	---	---	---	---	---
F7 121	---	---	---	---	---	---	---	---	---	---	---	---	---	---	---	---
F7 122	---	---	---	---	---	---	---	---	---	---	---	---	---	---	---	---
F7 123	---	---	---	---	---	---	---	---	---	---	---	---	---	---	---	---
F7 124	---	---	---	---	---	---	---	---	---	---	---	---	---	---	---	---
F7 125	---	---	---	---	---	---	---	---	---	---	---	---	---	---	---	---
F7 126	---	---	---	---	---	---	---	---	---	---	---	---	---	---	---	---
F7 127	---	---	---	---	---	---	---	---	---	---	---	---	---	---	---	---
F7 128	---	---	---	---	---	---	---	---	---	---	---	---	---	---	---	---

NOTE

• “ ← ” Indicates the same sound as STANDARD SET 1.

NOTA

• “ ← ” Indica el mismo sonido que STANDARD SET 1.

FINGERED Chord Chart

Cuadro de acordes digitados

Chord Type Root	M	m	7	m7	dim7	M7	dim	m7 ⁻⁵
C								
C [♯] /(D [♭])								
D								
(D [♭])/E [♯]								
E								
F								
F [♯] /(G [♭])								
G								
(G [♯])/A [♯]								
A								
(A [♯])/B [♯]								
B								

Chord Type Root	aug	sus4	7sus4	m add9	mM7	7-5	add9
C							
C [♯] /(D [♭])							
D							
(D [♭])/E [♯]							
E							
F							
F [♯] /(G [♭])							
G							
(G [♯])/A [♯]							
A							
(A [♯])/B [♯]							
B							

<CTK-810 only>

* These chords can be fingered if you expand the accompaniment area of the keyboard by changing the split point. For details, see "Using Split" on page E-45.

<Sólo CTK-810>

* Estos acordes se pueden digitar si expande el área de acompañamiento del teclado cambiando el punto de división. Para más información, vea "Usando la división" en la página S-45.

Rhythm List**Lista de ritmos**

8 BEAT / 16 BEAT	
001	STRAIGHT 8 BEAT
002	MELLOW 8 BEAT
003	MODERN 8 BEAT
004	GUITAR 8 BEAT
005	8 BEAT POP
006	8 BEAT
007	60'S 8 BEAT
008	16 BEAT 1
009	16 BEAT 2
010	16 BEAT SHUFFLE 1
011	16 BEAT SHUFFLE 2
BALLAD	
012	MODERN BALLAD
013	SLOW BALLAD
014	16 BEAT BALLAD
015	SOUL BALLAD
016	POP BALLAD 1
017	POP BALLAD 2
018	6/8 BALLAD
019	ROCK BALLAD 1
020	ROCK BALLAD 2
DANCE	
021	HIP-HOP
022	RAP POP
023	DANCE POP
024	DISCO POP
025	TECHNO POP
026	TRANCE
027	MODERN R&B 1
028	MODERN R&B 2
029	MODERN DANCE
030	DISCO SOUL
POPS	
031	POP 1
032	POP 2
033	POP ROCK
034	GUITAR POP
035	FAST SOUL
036	SLOW SOUL
037	60'S SOUL
ROCK	
038	SHUFFLE ROCK 1
039	SHUFFLE ROCK 2
040	BLUES
041	SOFT ROCK
042	LATIN ROCK
043	MODERN ROCK
044	SLOW ROCK
045	NEW ORLNS R&R
046	ROCK WALTZ

JAZZ	
047	SLOW BIG BAND
048	MIDDLE BIG BAND
049	FAST BIG BAND
050	SWING 1
051	SWING 2
052	SLOW SWING
053	JAZZ WALTZ 1
054	JAZZ WALTZ 2
055	FOX TROT
056	QUICKSTEP
057	JAZZ COMBO 1
EUROPEAN	
058	SCHLAGER
059	POLKA
060	POP POLKA
061	WALTZ 1
062	SLOW WALTZ
063	VIENNESE WALTZ
064	FRENCH WALTZ
065	SERENADE
066	TANGO
067	MARCH 1
068	MARCH 2
LATIN	
069	BOSSA NOVA 1
070	BOSSA NOVA 2
071	BEGUINE
072	SAMBA 1
073	SAMBA 2
074	MAMBO
075	RHUMBA
076	CHA-CHA-CHA
077	MERENGUE
078	BOLERO
079	SALSA
080	REGGAE
081	POP REGGAE
082	PUNTA
083	SKA
VARIOUS	
084	COUNTRY 8 BEAT
085	COUNTRY BALLAD
086	COUNTRY SHUFFLE
087	BLUEGRASS
088	DIXIE
089	TEX-MEX
090	FAST GOSPEL
091	SLOW GOSPEL
092	PASODOBLE
093	FOLKLORE

094	SIRTAKI
095	HAWAIIAN
096	ADANI
097	BALADI
098	ENKA
099	SYMPHONY
100	STR QUARTET
FOR PIANO	
101	PIANO 8 BEAT
102	PIANO BALLAD 1
103	PIANO BALLAD 2
104	EP BALLAD 1
105	EP BALLAD 2
106	BLUES BALLAD
107	JAZZ COMBO 2
108	JAZZ COMBO 3
109	RAGTIME
110	PIANO ROCK & ROLL
111	BOOGIE-WOOGIE
112	ARPEGGIO 1
113	ARPEGGIO 2
114	ARPEGGIO 3
115	6/8 MARCH
116	MARCH 3
117	STRIDE PIANO
118	WALTZ 2
119	WALTZ 3
120	WALTZ 4

NOTE

- Some rhythms (No. 110, 112 to 120) consist of chord accompaniments only, without any drums or other percussion instruments. Such rhythms do not sound unless CASIO CHORD, FINGERED, or FULL RANGE CHORD is selected as the accompaniment mode.

NOTA

- Algunos ritmos (Nº 110, 112 a 120) consisten solamente de los acompañamientos de acordes, sin ninguna batería ni otros instrumentos de percusión. Tales ritmos no suenan a menos que CASIO CHORD, FINGERED o FULL RANGE CHORD se seleccione como el modo de acompañamiento.

Song List/Lista de canciones

SONG BANK List

Lista SONG BANK

DEMO TUNES	
	CTK-810
001	GROOVEE!
002	WHATEVER WILL BE WILL BE (QUE SERA SERA)
003	ARIANFOR
	WK-110
001	ARIANFOR
002	WHATEVER WILL BE WILL BE (QUE SERA SERA)
003	GROOVEE!
EVENT	
004	WE WISH YOU A MERRY CHRISTMAS
005	JINGLE BELLS
006	SILENT NIGHT
007	JOY TO THE WORLD
008	O CHRISTMAS TREE
WORLD	
009	WHEN THE SAINTS GO MARCHING IN
010	GREENSLEEVES
011	SWING LOW, SWEET CHARIOT
012	AMAZING GRACE
013	AULD LANG SYNE
014	TWINKLE TWINKLE LITTLE STAR
015	LIGHTLY ROW
016	UNDER THE SPREADING CHESTNUT TREE
017	COME BIRDS
018	THE MUFFIN MAN
019	LONG LONG AGO
020	DID YOU EVER SEE A LASSIE?
021	LONDON BRIDGE
022	THE FARMER IN THE DELL
023	ON THE BRIDGE OF AVIGNON
024	SIPPIN' CIDER THROUGH A STRAW
025	GRANDFATHER'S CLOCK
026	MICHAEL ROW THE BOAT ASHORE
027	ANNIE LAURIE
028	MY BONNIE
029	MY DARLING CLEMENTINE
030	HOME SWEET HOME
031	ON TOP OF OLD SMOKEY
032	I'VE BEEN WORKING ON THE RAILROAD
033	LITTLE BROWN JUG
034	AURA LEE
035	OH! SUSANNA
036	HOUSE OF THE RISING SUN
037	SHE WORE A YELLOW RIBBON
038	CAMPTOWN RACES
039	SWANEE RIVER (OLD FOLKS AT HOME)
040	JEANNIE WITH THE LIGHT BROWN HAIR
041	YANKEE DOODLE
042	RED RIVER VALLEY
043	TURKEY IN THE STRAW
044	MY OLD KENTUCKY HOME
045	HOME ON THE RANGE
046	JAMAICA FAREWELL
047	ALOHA OE
048	SAKURA SAKURA
049	SANTA LUCIA
050	WALTZING MATILDA

CONCERT PIECES	
051	FÜR ELISE
052	TURKISH MARCH (MOZART)
053	PIANO SONATA op.27-2 "MOONLIGHT" 1st Mov.
054	ETUDE op.10-3 "CHANSON DE L'ADIEU"
055	GYMNOPÉDIES no.1
056	THE ENTERTAINER
057	MAPLE LEAF RAG
058	HUNGARIAN DANCES no.5
059	TRÄUMEREI
060	LA FILLE AUX CHEVEUX DE LIN
061	HUMORESKE (DVOŘÁK)
062	PROMENADE FROM "TABLEAUX D'UNE EXPOSITION"
063	MOMENTS MUSICAUX op.94-3
064	LE CYGNE FROM "LE CARNAVAL DES ANIMAUX"
065	VALSE op.64-1 "PETIT CHIEN"
066	CHANSON DU TOREADOR FROM "CARMEN"
067	LARGO (HÄNDEL)
068	WEDDING MARCH FROM "MIDSUMMER NIGHT'S DREAM"
069	AMERICAN PATROL
070	CSIKOS POST
071	DOLLY'S DREAMING AND AWAKENING
072	LA CHEVALERESQUE
073	PIANO SONATA K.545 1st Mov.
074	LA PRIÈRE D'UNE VIERGE
075	MARCIA ALLA TURCA
076	NOCTURNE op.9-2 (CHOPIN)
077	LIEBESTRÄUME no.3
078	MARCHE MILITAIRE no.1
079	BLUMENLIED
080	GRANDE VALSE BRILLANTE op.18-1
ETUDES	
081	MINUET IN G MAJOR
082	GAVOTTE (GOSSEC)
083	ARABESQUE (BURGMÜLLER)
084	CHOPSTICKS
085	FRÖHLICHER LANDMANN
086	INVENTIONEN no.1
087	AVE MARIA (GOUNOD)
088	JESUS BLEIBET MEINE FREUDE
089	CANON (PACHELBEL)
090	SONATINA op.36-1 1st Mov.
091	PIANO SONATA op.13 "PATHÉTIQUE" 2nd Mov.
092	PRELUDE op.28-7 (CHOPIN)
093	JE TE VEUX
094	RÊVERIE
095	ODE TO JOY
096	SERENADE FROM "EINE KLEINE NACHTMUSIK"
097	MARCH FROM "THE NUTCRACKER"
098	GOING HOME FROM "FROM THE NEW WORLD"
099	BEAUTIFUL DREAMER
100	DANNY BOY
101 - 105	User Songs/Canciones del usuario

Models CTK-810/WK-110

Version: 1.0

MIDI messages that can be sent and received using the USB port Los mensajes MIDI pueden enviarse y recibirse usando el puerto USB

Function ...	Transmitted	Recognized	Remarks
Basic Channel Default Changed	1 1-16	1-16 1-16	
Mode Default Messages Altered	Mode 3 X *****	Mode 3 X *****	
Note Number: True voice	36 - 96 (CTK-810) 28 - 103 (WK-110) *****	0-127 0 - 127 *1	*1: See Tone List on page A-1. *1: Vea la lista de sonidos en la página A-1.
Velocity Note ON Note OFF	0 9nH v = 1-127 X 8nH v = 64	0 9nHv = 1-127 X 9nHv = 0, 8nHv = XX	XX = no relation XX = sin relación
After Touch Key's Ch's	X X	X O*2	
Pitch Bender	X	O	
Control Change 0, 32 1 6, 38 7 10 11 64 66	O X X X X X O*4 O*4	O O*2 O*3 O O O O O O	Bank select Modulation Data entry Volume Pan Expression Hold1 Sostenuto

67 91 93 100, 101 120 121	O*4 X O X X X O	O*4 X O X X X O	Soft pedal Reverb send Chorus send RPN LSB, MSB All sound off Reset all controller
Program Change:	True #	O 0-127 ***** *****	O 0-127 ***** *****
System Exclusive	O*5	O*5	O*5 *6
System Common : Song Pos : Song Sel : Tune	X X X	X X X	X X X
System Real Time : Clock : Commands	O O	O O	X X
Aux Messages : Local ON/OFF : All notes OFF : Active Sense : Reset	X O X X	X O X X	X O O X
Remarks	<small> ⁸² Modulation and after touch for each channel are the same effect. ⁸³ FINE TUNE, COARSE TUNE receive, and PITCH BEND SENSE, RPN Null receive ⁸⁴ In accordance with sustain/assignable jack setting ⁸⁵ • Reverb Type [F0] [7F] [04] [05] [01] [01] [01] [01] [01] [01] [00] [wv] [F7] • v=00: Room; 01: Room; 04: Hall; 03: Hall • Chorus type [F0] [7F] [04] [05] [01] [01] [01] [01] [01] [01] [02] [00] [wv] [F7] v=00: Chorus1; 01: Chorus2; 02: Chorus3; 03: Chorus4 • Master Fine Tune [F0] [7F] [04] [03] [ll] [mm] [F7] • Master Coarse Tune [F0] [7F] [04] [04] [ll] [mm] [F7] • [ll] indicates low-order bytes, [mm] indicates high order bytes. ⁸⁶ • GM on/off GM ON: [F0] [7E] [09] [01] [F7] GM OFF: [F0] [7E] [09] [02] [F7] • Master Volume [F0] [7F] [04] [01] [ll] [mm] [F7] Low-order bytes [ll] are assumed to be 00h. ⁸⁷ La modulación y después del toque para cada canal tienen el mismo efecto. ⁸⁸ FINE TUNE, recepción COARSE TUNE, y PITCH BEND SENSE, recepción RPN Null ⁸⁹ De acuerdo con el ajuste de la toma asignable • Tipo de reverberación [F0] [7F] [04] [05] [01] [01] [01] [01] [01] [01] [02] [00] [wv] [F7] • Tipo de Chorus [F0] [7F] [04] [05] [01] [01] [01] [01] [01] [01] [02] [00] [wv] [F7] v=00: Chorus1; 01: Chorus2; 02: Chorus3; 03: Chorus4 • Afinación fina maestro [F0] [7F] [04] [03] [ll] [mm] [F7] • Afinación aproximada maestro [F0] [7F] [04] [04] [ll] [mm] [F7] • [ll] indica bytes de orden inferior, y [mm] indica bytes de orden superior. ⁹⁰ • GM ON/OFF GM ON: [F0] [7E] [09] [01] [F7] GM OFF: [F0] [7E] [09] [02] [F7] • Volumen maestro [F0] [7F] [04] [01] [ll] [mm] [F7] Los bytes de orden inferior [ll] se suponen que son 00h. </small>		

Mode 1 : OMNI ON, POLY
Mode 2 : OMNI ON, MONO
Mode 3 : OMNI OFF, POLY
Mode 4 : OMNI OFF, MONO

O : Yes
X : No



This recycle mark indicates that the packaging conforms to the environmental protection legislation in Germany.

Esta marca de reciclaje indica que el empaquetado se ajusta a la legislación de protección ambiental en Alemania.

CASIO®

CASIO COMPUTER CO.,LTD.
6-2, Hon-machi 1-chome
Shibuya-ku, Tokyo 151-8543, Japan

MA0702-A Printed in China
CTK810/WK110ES1A

Free Manuals Download Website

<http://myh66.com>

<http://usermanuals.us>

<http://www.somanuals.com>

<http://www.4manuals.cc>

<http://www.manual-lib.com>

<http://www.404manual.com>

<http://www.luxmanual.com>

<http://aubethermostatmanual.com>

Golf course search by state

<http://golfingnear.com>

Email search by domain

<http://emailbydomain.com>

Auto manuals search

<http://auto.somanuals.com>

TV manuals search

<http://tv.somanuals.com>