

# CASIO®

Digital Camera

# EX-F1

# User's Guide

E

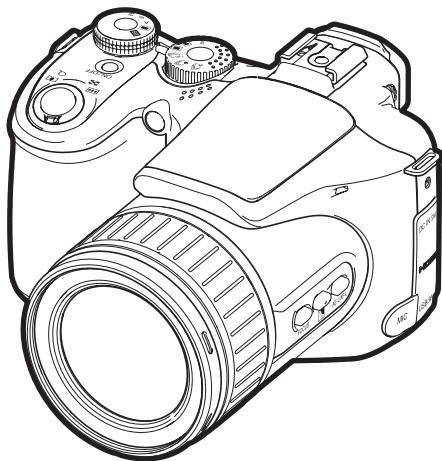

K860PCM1DMX

Thank you for purchasing this CASIO product.

- Before using it, be sure to read the precautions contained in this User's Guide.
- Keep the User's Guide in a safe place for future reference.
- For the most up-to-date information about this product, visit the official EXILIM Website at <http://www.exilim.com/>

# EXILIM

Download from [www.Somanuals.com](http://www.Somanuals.com). All Manuals Search And Download.

## Unpacking

As you unpack your camera, check to make sure that all items shown below are included. If anything is missing, contact your original retailer.



- A shoe cap is installed on the hot shoe at the factory.

Digital camera

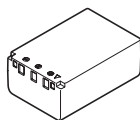

Rechargeable lithium ion battery (NP-100)

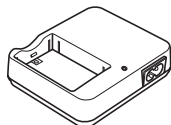

Charger unit (BC-100L)

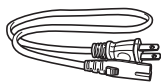

- The shape of the power cord plug varies according to country or geographic area.

Power cord

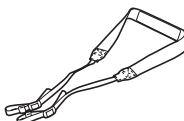

Strap



Lens cap



Lens hood



Remote shutter release



USB cable

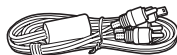

AV cable



CD-ROM

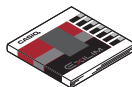

Basic Reference

## Read this first!

- The contents of this manual are subject to change without notice.
- The contents of this manual have been checked at each step of the production process. Feel free to contact us if you notice anything that is questionable, erroneous, etc.
- Any copying of the contents of this User's Guide, either in part or its entirety, is forbidden. Except for your own personal use, any other use of the contents of this manual without the permission of CASIO COMPUTER CO., LTD. is forbidden under copyright laws.
- CASIO COMPUTER CO., LTD. shall not be held liable for any damages or lost profits suffered by you or any third party due to the use or malfunction of this product.
- CASIO COMPUTER CO., LTD. shall not be held liable for any damages, lost profits, or claims by third parties arising out of the use of ArcSoft TotalMedia Extreme for CASIO, ArcSoft TotalMedia Theatre for CASIO, ArcSoft TotalMedia Studio for CASIO, or YouTube Uploader for CASIO.
- CASIO COMPUTER CO., LTD. shall not be held liable for any damages or lost profits caused by loss of memory contents due to malfunction, repair, or any other reason.
- Note that the example screens and product illustrations shown in this User's Guide may differ somewhat from the screens and configuration of the actual camera.

### LCD Panel

The liquid crystal panel used for the monitor screen and viewfinder employs high-precision technology that provides a pixel yield of 99.99%. This means that some very small number of pixels may not light or may remain lit at all times. This is due to the characteristics of the liquid crystal panel, and does not indicate malfunction.

#### Take test shots

Before shooting your final image, shoot a test shot to ensure that the camera is recording correctly.

# Contents

Unpacking .....	2
Read this first! .....	3

## ■ Quick Start Basics 9

---

What is a digital camera? .....	9
What you can do with your CASIO camera .....	10
Attaching the Lens Cap and Strap .....	11
First, charge the battery prior to use.....	11
■ To charge the battery .....	11
■ To load the battery .....	13
Configuring the Display Language the First Time You Turn On the Camera ..	15
Preparing a Memory Card .....	16
■ Supported Memory Cards .....	16
■ To load a memory card .....	16
■ To format (initialize) a new memory card .....	17
To shoot a snapshot .....	18
Holding the Camera Correctly .....	20
Viewing Snapshots .....	21
Deleting Images .....	22
■ To delete a single file .....	22
■ To delete all files .....	22
Snapshot Shooting Precautions .....	23
■ Auto Focus Restrictions .....	23
Turning the Camera On and Off .....	24
■ To turn power on .....	24
■ To turn off the camera .....	24

## ■ Snapshot Tutorial 25

---

Selecting a Recording Mode .....	25
Using the Control Panel .....	28
Changing the Image Size .....	(Size) 29
Using Flash .....	(Flash) 31
Specifying ISO Sensitivity .....	(ISO) 34
Adjusting White Balance .....	(White Balance) 34
Correcting Image Brightness .....	(EV Shift) 36
Specifying the Metering Mode .....	(Metering) 37
Specifying the Auto Focus Area .....	(AF Area) 37
Shooting with the REC Light .....	(REC Light) 39
Changing the Control Panel Date/Time Style .....	39
Shooting with Zoom .....	40
■ Optical Zoom/Digital Zoom Switch Point .....	41
Selecting a Focus Mode .....	(Focus) 43
Correcting for Back Lighting .....	45
Locking the Auto Exposure and Auto Focus Setting .....	45

■ Specifying the [AE-L/AF-L] button Operation .....	45
Using Continuous Shutter .....	46
■ Selecting the Continuous Shutter (CS) Mode .....	46
■ Using Flash Continuous Shutter .....	48
■ Using Prerecord (Still image) .....	50
■ Using High-speed Continuous Shutter .....	52
■ Shooting with Slow Motion View .....	53
■ Shooting with Bracketing Continuous Shutter .....	54
■ Specifying the Method for Saving Continuous Shutter Images .....	58
■ Continuous Shutter Precautions .....	60

## ■ Recording Movies 62

---

To record a movie .....	62
■ Audio .....	63
Movie Mode Settings .....	64
■ Recording a High-definition Movie .....	64
■ Recording a High-speed Movie .....	65
Shooting a Snapshot while Shooting a Movie .....	66

## ■ Using BEST SHOT 67

---

What is BEST SHOT? .....	67
■ Some Sample Scenes .....	67
To shoot with BEST SHOT .....	67
■ Creating Your Own BEST SHOT Setups .....	69
Shooting with Digital Anti Shake .....	(Digital Anti Shake) .. 70
Shooting with Digital Panning .....	(Digital Panning) .. 71
Shooting an Image in Accordance with Subject Movement .....	(Move Out CS/Move In CS) .. 72
Using Prerecord Movie .....	(Prerecord (Movie)) .. 76

## ■ Advanced Settings 77

---

Using On-screen Menus .....	77
REC Mode Settings .....	(REC) .. 79
■ Using the Self-timer .....	(Self-timer) .. 79
■ Using the Auto Focus Assist Light .....	(AF Assist Light) .. 80
■ Reducing the Effects of Camera and Subject Movement .....	(Anti Shake) .. 81
■ Shooting with Face Detection .....	(Face Detection) .. 82
■ Shooting with Continuous Auto Focus .....	(Continuous AF) .. 83
■ Specifying the [AE-L/AF-L] button Operation .....	(AE/AF Lock) .. 83
■ Shooting with AE Bracketing .....	(AE Bracketing) .. 83
■ Shooting with White Balance Bracketing .....	(WB Bracketing) .. 83
■ Shooting with Focus Bracketing .....	(Focus Bracketing) .. 84
■ Turning Digital Zoom On or Off .....	(Digital Zoom) .. 84
■ Shooting with Quick Shutter .....	(Quick Shutter) .. 84
■ Assigning a Function to the Function Ring .....	(Ring Setup) .. 85
■ Configuring the Continuous Shutter Image Save Method (Save CS Images) ..	85
■ Turning on Image Review .....	(Review) .. 85

■ Displaying the On-screen Grid . . . . . (Grid) . . . . .	86
■ Configuring Power On Default Settings . . . . . (Memory) . . . . .	86
Image Quality Settings . . . . . (Quality) . . . . .	87
■ Specifying Snapshot Image Quality . . . . . (☐ Quality (Snapshot)) . . . . .	87
■ Configuring HD Movie Settings . . . . . (HD 📺 Quality) . . . . .	87
■ Setting the High-speed Movie Frame Rate . . . . . (HS 📺 Speed) . . . . .	88
■ Reducing Underexposure and Overexposure . . . . . (Dynamic Range) . . . . .	88
■ Specifying Flash Intensity . . . . . (Flash Intensity) . . . . .	89
■ Turning On Flash Assist . . . . . (Flash Assist) . . . . .	89
■ Using Built-in Color Filters . . . . . (Color Filter) . . . . .	89
■ Controlling Image Sharpness . . . . . (Sharpness) . . . . .	90
■ Controlling Color Saturation . . . . . (Saturation) . . . . .	90
■ Adjusting Image Contrast . . . . . (Contrast) . . . . .	90
Using the Remote Shutter Release . . . . .	91
Using an External Flash . . . . .	92
Installing the Lens Hood or a Lens Filter . . . . .	94
■ Installing the Lens Hood . . . . .	94
■ Installing a Filter . . . . .	95

## ■ Viewing Snapshots and Movies 96

---

Viewing Snapshots . . . . .	96
Viewing a Movie . . . . .	96
Viewing Continuous Shutter Images . . . . .	97
■ Deleting Continuous Shutter Images . . . . .	99
■ Dividing Up a CS Group . . . . .	99
■ Copying a CS Group Image . . . . .	100
Zooming an On-screen Image . . . . .	101
Displaying 12 Images on the Same Screen . . . . .	101
Viewing Snapshots and Movies on a TV Screen . . . . .	102
■ Viewing High-quality Movies on a Hi-Vision Television . . . . .	104

## ■ Other Playback Functions (PLAY) 106

---

Playing a Slideshow on the Camera . . . . . (Slideshow) . . . . .	106
Creating a Snapshot of Movie Frames . . . . . (MOTION PRINT) . . . . .	107
Editing a Movie on the Camera . . . . . (Movie Editing) . . . . .	108
Adjusting White Balance . . . . . (White Balance) . . . . .	110
Adjusting the Brightness of an Existing Snapshot . . . . . (Brightness) . . . . .	111
Selecting Images for Printing . . . . . (DPOF Printing) . . . . .	111
Protecting a File Against Deletion . . . . . (Protect) . . . . .	112
Rotating an Image . . . . . (Rotation) . . . . .	113
Resizing a Snapshot . . . . . (Resize) . . . . .	113
Cropping a Snapshot . . . . . (Trimming) . . . . .	114
Copying Files . . . . . (Copy) . . . . .	114
Dividing Up a Continuous Shutter Group . . . . . (Divide Group) . . . . .	115
Selecting the PLAY Mode Screen Layout . . . . . (Display Layout) . . . . .	115
Copying a Continuous Shutter Group . . . . . (Select Frame) . . . . .	115

## ■ Printing

116

Printing Snapshots . . . . .	116
Connecting Directly to a PictBridge Compatible Printer . . . . .	117
Using DPOF to Specify Images to be Printed and the Number of Copies . . . . .	119

## ■ Using the Camera with a Computer

122

Things you can do using a computer... . . . . .	122
Using the Camera with a Windows Computer . . . . .	123
■ Viewing and Storing Images on a Computer . . . . .	124
■ Playing Back and Saving Movies to Disc . . . . .	126
■ Uploading Movie Files to YouTube . . . . .	127
■ Viewing User Documentation . . . . . (PDF Files) . . . . .	129
■ User Registration . . . . .	129
Using the Camera with a Macintosh . . . . .	130
■ Connecting the Camera to Your Computer and Saving Files . . . . .	130
■ Transferring Images Automatically and Managing Them on Your Macintosh . . . . .	132
■ Playing a Movie . . . . .	133
■ Viewing User Documentation . . . . . (PDF Files) . . . . .	133
■ User Registration . . . . .	133
Files and Folders . . . . .	134
Memory Card Data . . . . .	135

## ■ Other Settings

(Set Up) 137

Adjusting Monitor Screen Brightness . . . . . (Screen) . . . . .	137
Adjusting Viewfinder Brightness . . . . . (EVF Brightness) . . . . .	137
Configuring Camera Sound Settings . . . . . (Sounds) . . . . .	138
Specifying the File Name Serial Number Generation Rule . . . . . (File No.) . . . . .	138
Configuring World Time Settings . . . . . (World Time) . . . . .	139
Time Stamping Snapshots . . . . . (Timestamp) . . . . .	140
Setting the Camera's Clock . . . . . (Adjust) . . . . .	140
Specifying the Date Style . . . . . (Date Style) . . . . .	141
Specifying the Display Language . . . . . (Language) . . . . .	141
Configuring Sleep State Settings . . . . . (Sleep) . . . . .	142
Configuring Auto Power Settings . . . . . (Auto Power Off) . . . . .	142
Configuring [📷] and [▶] Settings . . . . . (REC/PLAY) . . . . .	143
Controlling Monitor Screen Priority . . . . . (LCD Priority) . . . . .	143
Configuring USB Protocol Settings . . . . . (USB) . . . . .	144
Selecting the Screen Aspect Ratio and Video Output System (Video Out) . . . . .	144
Selecting the HDMI Terminal Output Method . . . . . (HDMI Output) . . . . .	145
Formatting Built-in Memory or a Memory Card . . . . . (Format) . . . . .	145
Resetting the Camera to Factory Defaults . . . . . (Reset) . . . . .	145

## ■ ■ **Configuring Monitor Screen Settings** **146**

---

Turning Display Information On and Off . . . . . (Info) . . . . .	146
Selecting Monitor Screen and Viewfinder Settings . . . . .	146
Using the On-screen Histogram to Check Exposure . . . . . (+Histogram) . . . . .	147
■ How to Use the Histogram . . . . .	148

## ■ ■ **Appendix** **149**

---

Precautions during Use . . . . .	149
Power Supply . . . . .	157
■ Charging . . . . .	157
■ To replace the battery . . . . .	158
■ Battery Precautions . . . . .	158
■ Using the Camera in another Country . . . . .	159
■ Using Household Power . . . . .	159
Using a Memory Card . . . . .	160
■ To replace the memory card . . . . .	160
Computer System Requirements for Bundled Software . . . . .	162
General Guide . . . . .	163
Monitor Screen Contents . . . . .	165
Reset Initial Default Settings . . . . .	168
When things don't go right... . . . . .	170
■ Troubleshooting . . . . .	170
■ Display Messages . . . . .	174
Number of Snapshots and Movie Recording Time . . . . .	177
Specifications . . . . .	180



# Quick Start Basics

## What is a digital camera?

A digital camera stores images on a memory card, so you can record and delete images a countless number of times.

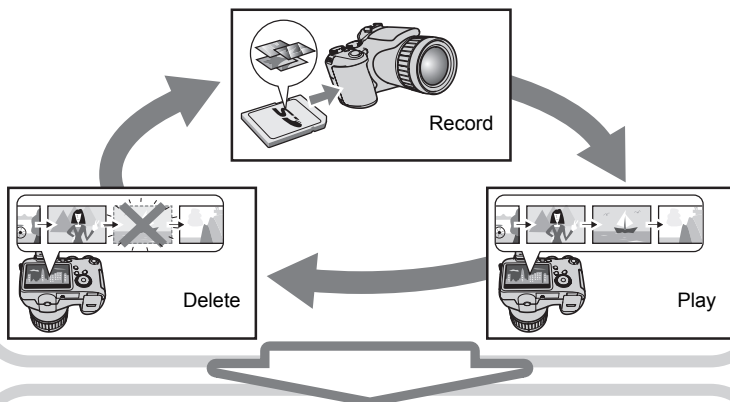

You can use the images you record in a variety of different ways.

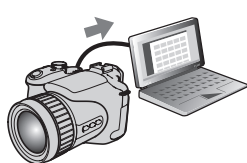

Store images on your computer.

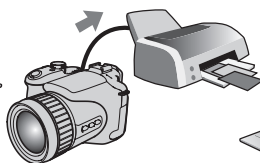

Print images.



Attach images to e-mail.

## What you can do with your CASIO camera

Your CASIO camera is packed with a powerful selection of features and functions to make recording of digital images easier, including the following three main functions.



### High-speed Continuous Shutter Prerecord (Still image)

Now you can shoot continuous high-resolution images at the amazing speed of 60 images per second. Prerecord (Still image) pre-records images to ensure you are almost never too late with the shutter button.

See page **46** for more information.

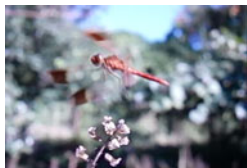

### High-speed Movies

Movies can be recorded at up to 1200 frames per second. This makes it possible to clearly view phenomena that are invisible to the human eye, in slow motion.

See page **64** for more information.

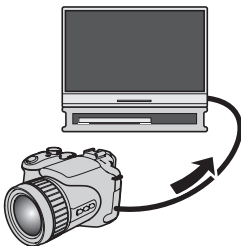

### Full HD Movie Recording

You can record movies in high-quality full HD and play them back on a Hi-Vision TV.  
(1920×1080 pixels 60 fields/s)

See page **64** for more information.

## Attaching the Lens Cap and Strap

Be sure to attach the lens cap and strap to the camera before using it.

### ■ Attaching the Lens Cap

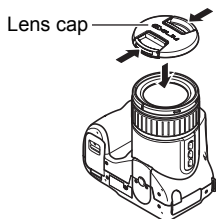

### ■ Attaching the strap

- Attach either end of the strap to the two strap rings on the sides of the camera as shown in the illustration.
- After you are finished pull on the strap to test it and to make sure it does not come loose.

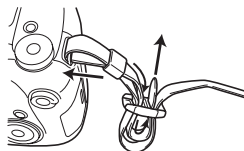

## First, charge the battery prior to use.

Note that the battery of a newly purchased camera is not charged. Perform the steps under "To charge the battery" to bring the battery to a full charge.

- Your camera requires a special CASIO rechargeable lithium ion battery (NP-100) for power. Never try to use any other type of battery.

### To charge the battery

1. Aligning the positive  $\oplus$  and negative  $\ominus$  terminals of the battery with those of the charger unit, load the battery into the charger unit.

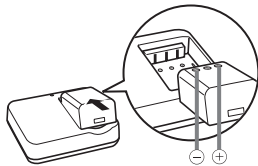

## 2. Plug the charger unit into a household power outlet.

About 4 hours 30 minutes are required to reach full charge. The [CHARGE] lamp will light green when charging is complete.

Unplug the power cord from the power outlet and then remove the battery from the charger.

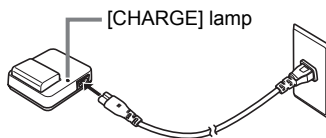

Lamp Status	Description
Lit Red	Charging
Off	Charger unit or battery problem due to abnormally high or low ambient temperature (page 157)
Lit green	Charging complete or standing by

### Other Charging Precautions

- Charge the battery in an area where the temperature is within the range of 5°C to 35°C (41°F to 95°F). Outside this temperature range charging can take longer than normal or even fail.
- Use the special charger (BC-100L) to charge the special lithium ion battery (NP-100). Never use any other type of charger device. Attempting to use a different charger can result in unexpected accident.
- A battery that is still warm due to normal use may not charge fully. Give the battery time to cool before charging it.
- A battery discharges slightly even when it is not loaded in the camera. Because of this, it is recommended that you charge the battery immediately before you need to use it.
- Charging the camera's battery may cause interference with TV and radio reception. If this happens, plug the charger into an outlet that is further away from the TV or radio.
- Actual charging time depends on current battery capacity and charging conditions.

## To load the battery

### 1. Open the battery cover.

Slide the lock in the direction indicated by the arrow and the battery cover will open.

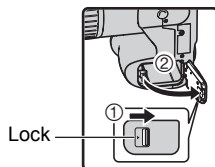

### 2. Load the battery.

While holding the stopper to the side in the direction indicated by the arrow, slide the battery into the camera, terminals end first. Press the battery in until the stopper secures it in place.

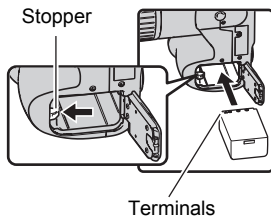



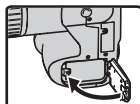

### 3. Close the battery cover.

- For information about how to replace the battery, see page 158.



## Checking Remaining Battery Power

As battery power is consumed, a battery indicator on the monitor screen indicates remaining power as shown below.

<b>Remaining Power</b>	High ←————→ Low
<b>Battery Indicator</b>	 →  →  → 
<b>Indicator Color</b>	Cyan → Amber → Red → Red

 indicates battery power is low. Charge the battery as soon as possible.

Recording is not possible when  is indicated. Charge the battery immediately.

- The level shown by the battery indicator may change when you switch between the REC mode and PLAY mode.
- Leaving the camera for about one day with no power supplied while the battery is dead will cause its date and time settings to be cleared. You will have to re-configure the settings after power is restored.
- See page 183 for information about battery life and memory capacity.

## Battery Power Conservation Tips

- When you do not need to use the flash, select  (flash off) for the flash setting (page 31).
- Enable the Auto Power Off and the Sleep features to protect against wasting battery power when you forget to turn off the camera (pages 142, 142).

## Configuring the Display Language the First Time You Turn On the Camera

The first time you load a battery into the camera, a screen appears for configuring the display language, date, and time settings. Failure to set the date and time correctly will cause the wrong date and time data to be recorded with images.

**1. Press [ON/OFF] to turn on the camera.**

**2. Use [▲], [▼], [◀], and [▶] to select the language you want and then press [SET].**

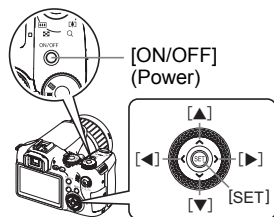

**3. Use [▲], [▼], [◀], and [▶] to select the area where you will be using the camera and then press [SET].**

The selected area is highlighted in red.



**4. Use [▲] and [▼] to select the city where you will be using the camera and then press [SET].**

**5. Use [▲] and [▼] to select the summer time (DST) setting you want and then press [SET].**

**6. Use [▲] and [▼] to select a date style and then press [SET].**

Example: 19. 12. 09

YY/MM/DD → 09/12/19

DD/MM/YY → 19/12/09

MM/DD/YY → 12/19/09

**7. Set the date and the time.**

Use [◀] and [▶] to select the setting you want to change and then use [▲] and [▼] to change it.

To switch between 12-hour and 24-hour format, press [DISP].

**8. Press [SET].**

- If you make a mistake, you can change the settings later (pages 140, 141).

### NOTE

- Each country controls its local time offset and the use of summer time, and so they are subject to change.

## Preparing a Memory Card

Though the camera has built-in memory that can be used to store images and movies, you probably will want to purchase a commercially available memory card for greater capacity. The camera does not come with a memory card. Images recorded while a memory card is loaded are saved to the memory card. When no memory card is loaded, images are saved to built-in memory.

- For information about memory card capacities, see page 177.

### Supported Memory Cards

- SD Memory Card
- SDHC Memory Card
- MMC (MultiMediaCard)
- MMC*plus* (MultiMediaCard*plus*)



Use one of the above types of memory card.

### Memory Card Handling Precautions

Certain types of cards can slow down processing speeds. In particular, you may experience problems saving high-quality movies. Use of certain types of memory cards increase the time it takes to record movies, which can cause movie frames to be lost. The "● REC" indicator on the monitor screen turns yellow to indicate that frames are being lost. Use of a memory card with a maximum transfer speed of at least 10MB per second is recommended.

### To load a memory card

#### 1. Press [ON/OFF] to turn off the camera and then open the memory card slot cover.

Pressing the memory card slot cover, slide it in the direction indicated by the arrow.

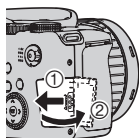

#### 2. Load a memory card.

Positioning the memory card so its front is facing in the same direction as the monitor screen side of the camera, slide it into the card slot as far as it will go, until you hear it click securely into place.



Front

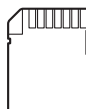

Back

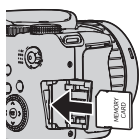

#### 3. Close the memory card slot cover.

Pressing the memory card slot cover against the camera, slide it closed.

- For information about how to replace the memory card, see page 160.

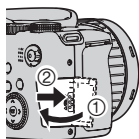





### **IMPORTANT!**

- Never insert anything besides a supported memory card (page 16) into the memory card slot.
- Should water or any foreign object ever get into the card slot, immediately turn off the camera, remove the battery, and contact your retailer or nearest CASIO authorized service center.

## **To format (initialize) a new memory card**

---

You need to format a new memory card before using it for the first time.

- 1. Turn on the camera and press [MENU].**

---

- 2. Select the “Set Up” tab, select “Format” and then press [▶].**

---

- 3. Use [▲] and [▼] to select “Format” and then press [SET].**



### **IMPORTANT!**

- Formatting a memory card that already has snapshots or other files on it, will delete its contents. Normally you do not need to format a memory card again. However, if storing to a card has slowed down or if you notice any other abnormality, re-format the card.
- Be sure to use the camera to format a memory card. Formatting a memory card on a computer and then using it in the camera can slow down data processing by the camera. In the case of an SD or SDHC memory card, formatting on a computer can result in non-conformity with the SD format, causing problems with compatibility, operation, etc.

## To shoot a snapshot

1. Remove the lens cap and then press **[CAMERA]** (REC) to turn on the camera.

2. Set the mode dial to **[CAMERA]** (Auto).

3. Set the CS dial to **[CAMERA]** (Single Shot).

- You can use either monitor screen or viewfinder to compose the image. Each press of the [EVF/LCD] button cycles through the available monitor screen and viewfinder on/off settings (page 146). If the image in the viewfinder appears blurry, use the diopter dial to adjust it.

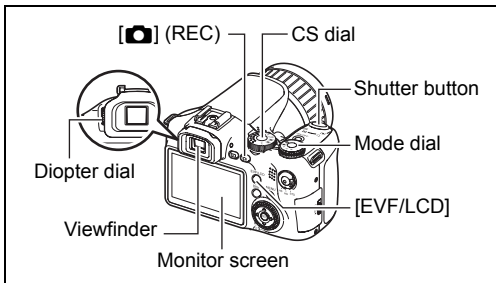
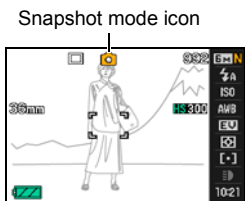

4. Point the camera at the subject.

You can zoom the image, if you want.

Zoom controller

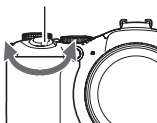

**[TELEPHOTO]** Telephoto

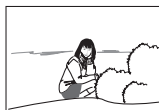

**[WIDE ANGLE]** Wide Angle

5. Half-press the shutter button to focus the image.

When focus is complete, the camera will beep, the back lamp will light green, and the focus frame will turn green.

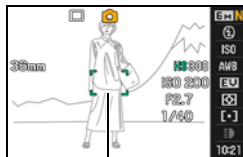
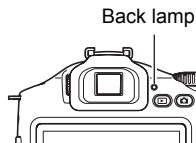

Focus frame

## Half-press

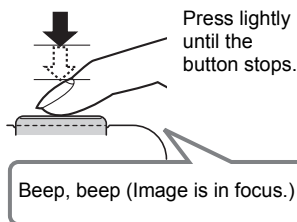

When you half-press the shutter button, the camera automatically adjusts exposure and focuses on the subject it is currently pointed at. Mastering how much pressure is required for a half-press and a full-press of the shutter button is an important technique for good-looking images.

## 6. Continuing to keep the camera still, press the shutter button the rest of the way down.

This records the snapshot.

## Full-press

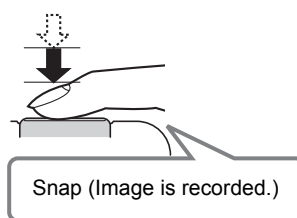

### Shooting a Movie

Press [●] to start movie recording. Press [●] again to stop movie recording. See page 62 for details.

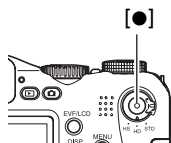

## ★ IMPORTANT!

- While the “Anti Shake” setting is “ Auto” or “ Camera AS”, half pressing the shutter will cause the camera to vibrate and emit an operation sound. This is normal and does not indicate malfunction (page 81).

## ■ Using Quick Shutter

Fully pressing the shutter button without waiting for Auto Focus to operate will record using Quick Shutter (page 84).

- With Quick Shutter, the camera focuses faster than normal Auto Focus, which means you can capture quick moving action more easily. Note, however, that some images may be out of focus when Quick Shutter is used.
- Whenever possible, take a little extra time to half-press the shutter button in order to ensure proper focus.

## ■ If the image does not focus...

If the focus frame stays red and the back lamp is flashing green, it means that the image is not in focus (because the subject is too close, etc.) Point the camera at the subject and try to focus again.

## ■ If the subject is not in the center of the frame...

“Focus lock” (page 44) is the name of a technique you can use when you want to shoot an image in which the subject to be focused on is not within the focus frame in the center of the screen.

### Holding the Camera Correctly

Your images will not come out clearly if you move the camera when you press the shutter button. When pressing the shutter button, be sure to hold the camera as shown in the illustration near by, and keep it still by pressing your arms firmly against your sides as you shoot.

Holding the camera still, carefully press the shutter button and take care to avoid all movement as the shutter releases and for a few moments after it releases. This is especially important when available lighting is low, which slows down the shutter speed.

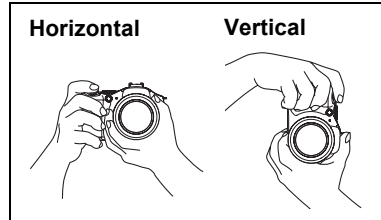

#### NOTE

- Take care that your fingers and the strap do not cover any of the areas indicated in the illustration.
- To protect against accidentally dropping the camera, attach the strap and make sure it is around your neck while you are operating the camera.
- Never swing the camera around by its strap.
- The supplied strap is intended for use with this camera only. Never use it for any other purpose.

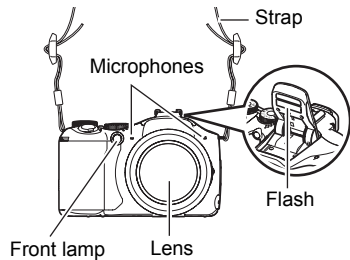

## Viewing Snapshots

Use the following procedure to view snapshots on the camera's monitor screen.

- For information about how to play back movies, see page 96.
- For information about images recorded using continuous shutter (CS), see page 97.
- For information about high-speed movies, see page 64.

### 1. Press [▶] (PLAY) to enter the PLAY mode.

- This will display one of the snapshots currently stored in memory.
- Information about the displayed snapshot also is included (page 166).
- You also can clear the information to view only the snapshot.
- You can zoom in on the image by sliding the zoom controller towards [⏏] (page 101). If you are recording a snapshot that is very important to you, it is recommended that you zoom the image and check its details after recording it.

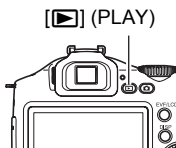

### 2. Use [◀] and [▶] to scroll between images.

- Holding down either button scrolls at high speed.
- You also can scroll between images using the control dial.

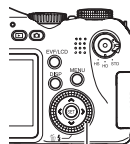

Control dial

## Deleting Images

If memory becomes full, you can delete images you no longer need in order to free up storage and record more images.

- Remember that a file (image) delete operation cannot be undone.
- For information about images recorded using continuous shutter (CS), see page 99.

### To delete a single file

1. Press [▶] (PLAY) to enter the PLAY mode and then press [▼] (🗑️ ⚡).
2. Use [◀] and [▶] to scroll through the files until the one you want to delete is displayed.
3. Use [▲] and [▼] to select “Delete” and then press [SET].
  - To delete other files, repeat steps 2 and 3.
  - To exit the delete operation, press [MENU].
  - If a CS group (page 97) is displayed when you perform the above procedure, all of the images in the currently display CS group will be deleted.

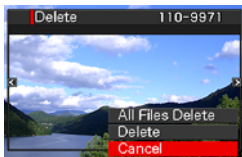

### To delete all files

1. Press [▶] (PLAY) to enter the PLAY mode and then press [▼] (🗑️ ⚡).
2. Use [▲] and [▼] to select “All Files Delete” and then press [SET].
3. Use [▲] and [▼] to select “Yes” and then press [SET] to delete all files. This will cause the message “There are no files” to appear.

## Snapshot Shooting Precautions

### Operation

- Never open the battery cover while the back lamp is flashing green. Doing so can result in the image you just shot being saved incorrectly, damage to other images stored in memory, malfunction of the camera, etc.
- If unwanted light is shining directly onto the lens, install the lens hood that comes with the camera or shade the lens with your hand.

### Monitor Screen when Shooting Snapshots

- The image that appears on the monitor screen is for image composition. The actual image will be recorded at the quality set for the image quality setting (page 87).

### Shooting Indoors under Fluorescent Lighting

- Minute flickering of fluorescent lighting can affect the brightness or color of an image.

### Auto Focus Restrictions

- Any of the following can make proper focus impossible.
  - Solid color wall or other very low contrast subject
  - Strongly back lit subject
  - Very shiny subject
  - Blinds or other subject with a repeating horizontal pattern
  - Multiple subjects at varying distances from the camera
  - Subject in a dark location
  - Subject that is too far away for light from the AF assist lamp to reach
  - Camera movement while shooting
  - Fast-moving subject
  - Subjects outside the focus range of the camera
- If you cannot focus properly, try using focus lock (page 44) or Manual Focus (page 43).

## Turning the Camera On and Off

### To turn power on

To enter the REC mode, press [ON/OFF] (Power) or [RECORD] (REC). To enter the PLAY mode, press [PLAY] (PLAY).

The camera will turn on.

- Pressing [PLAY] (PLAY) while in the REC mode switches to the PLAY mode.
- The Sleep function or Auto Power Off (pages 142, 142) will turn off power automatically if you do not perform any operation for a preset amount of time.

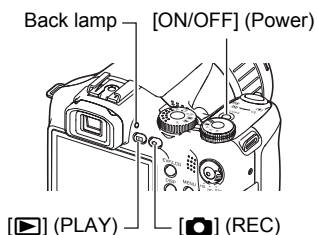

### To turn off the camera

Press [ON/OFF] (Power).

- You can configure the camera so power does not turn on when you press [RECORD] (REC) or [PLAY] (PLAY). You also can configure the camera to turn off when you press [RECORD] (REC) or [PLAY] (PLAY) (page 143).



## Selecting a Recording Mode

Your camera has a variety of different recording modes. Before recording an image, rotate the mode dial to select the recording mode that suits the type of image you are trying to record.

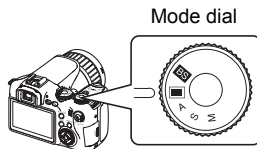

### Auto

Use this setting for easy image recording. This is the mode you normally should use (page 18).

### BEST SHOT mode

Simply select one of a collection of built-in sample scenes and the camera sets up automatically for beautiful images every time (page 67).

### A (Aperture Priority) mode

In this mode, you select the aperture and other settings are adjusted accordingly. Use [◀] and [▶] to select the desired aperture value.

- The ISO sensitivity, shutter speed and aperture value on the monitor screen will turn orange when you half-press the shutter button if the image is over-exposed or under-exposed.
- If you are using manual focus (page 43), you also can press [SET], select "Focus", and then use [◀] and [▶] to focus manually.
- You also can adjust aperture and focus using the control dial.

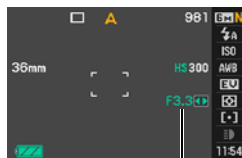

Aperture value

## S S (Shutter Speed Priority) mode

In this mode, you select the shutter speed and other settings are adjusted accordingly.

Use [◀] and [▶] to select the desired shutter speed.

- The ISO sensitivity, shutter speed and aperture value on the monitor screen will turn orange when you half-press the shutter button if the image is over-exposed or under-exposed.
- If you are using manual focus (page 43), you also can press [SET], select "Focus", and then use [◀] and [▶] to focus manually.
- You also can adjust shutter speed and focus using the control dial.

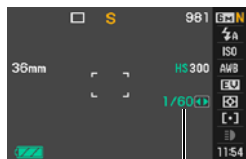

Shutter speed

## M M (Manual Exposure) mode

This mode gives you total control over aperture and shutter speed settings.

- ① Press [SET], select the aperture setting, and then use [◀] and [▶] to change it.
  - ② Press [SET], select the shutter speed setting, and then use [◀] and [▶] to change it.
- If you are using manual focus (page 43), you also can press [SET], select "Focus", and then use [◀] and [▶] to focus manually.
  - You also can adjust aperture, shutter speed, and focus using the control dial.
  - The ISO sensitivity, shutter speed and aperture value on the monitor screen will turn orange when you half-press the shutter button if the image is over-exposed or under-exposed.

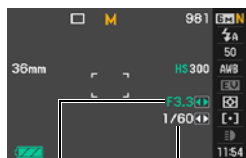

Aperture value

Shutter speed



## **IMPORTANT!**

- You may not be able to achieve the brightness you want when shooting an image that is very dark or very bright. If this happens, use the M mode to adjust the aperture or shutter speed manually.
- Due to the characteristics of the camera's semiconductor, slow shutter speeds can cause digital noise in images. The camera performs an automatic noise reduction process whenever the shutter speed is 1 second or slower (except for images shot with Bracketing CS). Storage of images shot at slower shutter speeds takes longer because of the time required for noise reduction. Do not perform any key operation while the image storage operation is in progress.
- Due to the characteristics of the imaging element used by the camera, very fast moving objects in an image may appear distorted.
- Depending on the shutter speed setting and the recording mode you used, the brightness of what appears on the monitor screen when you record the image may be different from the brightness of the recorded image.
- Image AS (page 81) does not work in the S mode and M mode. You can, however, turn on Camera AS, if you like.
- The recording mode changes to  (Auto) automatically whenever you shoot a movie with the "STD" or "HD" movie mode (page 64).
- The aperture, shutter speed, and ISO sensitivity settings configured with the snapshot A Mode, S Mode, or M Mode are used when shooting a movie with the "HS" movie mode (page 64). Note, however, that the shutter speed range is limited in accordance with the frame rate specified for the high-speed movie.
- When recording with some modes, light source flicker can cause horizontal bands to appear in the image.

## Using the Control Panel

The control panel can be used to configure camera settings.

- 1. In the REC mode, use [▲] and [▼] to select the setting you want to change.**

This will select one of the control panel icons and display its settings.

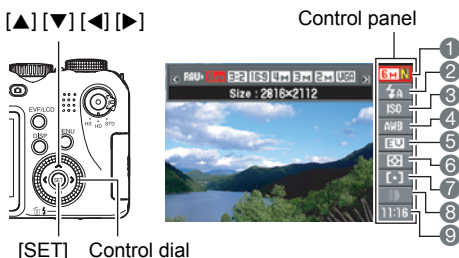

- ① Image size/Quality\* (pages 29, 87)
- ② Flash mode (page 31)
- ③ ISO sensitivity (page 34)
- ④ White balance (page 34)
- ⑤ EV shift (page 36)
- ⑥ Metering mode (page 37)
- ⑦ AF area (page 37)
- ⑧ REC light (Single Shot mode) (page 39)  
Continuous shutter (CS) speed (High-speed CS, Prerecord (Still image), Flash CS modes) (pages 48, 50, 52)  
Bracketing mode (Bracketing mode) (page 54)  
View speed (Slow Motion View mode) (page 53)
- ⑨ Date/Time (page 39)  
Prerecord (Still image) Time (Prerecord (Still image) mode) (page 50)  
Flash continuous shutter (CS) images (Flash CS mode (with flash)) (page 49)

\* Image quality cannot be changed using the control panel.

- 2. Use [◀] and [▶] to change the setting.**

• You also can change this setting using the control dial.

- 3. If you want to configure another setting, repeat steps 1 and 2.**

- 4. After all of the settings are the way you want, press [SET].**

This will apply the settings and return to the REC mode.

### NOTE

- You also can configure settings other than those listed above (page 77).

## Changing the Image Size (Size)

### ■ Pixels

A digital camera image is a collection of small dots called "pixels". The more pixels there are in an image, the more detail there will be. However, you generally can do with fewer pixels when printing an image (L size) through a print service, attaching an image to e-mail, when viewing the image on a computer, etc.

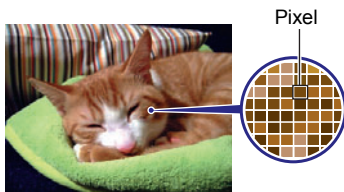

### ■ About image sizes

The size of an image indicates how many pixels it contains, and is expressed as horizontal pixels  $\times$  vertical pixels.

- ① 2816  $\times$  2112 size image = Approximately 6 million pixels
- ② 640  $\times$  480 size image = Approximately 300,000 pixels

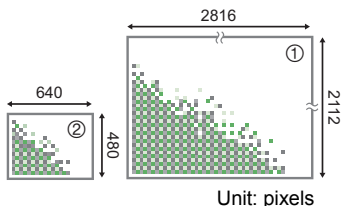

### Image Size Selection Tips

Note that larger images have more pixels, so they take up more memory space.



Large Number of Pixels

→ More detail, but takes up more memory. Best when you plan to print large-size prints (such as A3 size).



Small Number of Pixels

→ Less detail, but takes up less memory. Best when you want to send images by e-mail, etc.

- For information about image size, image quality, and number of images that can be stored, see page 177.
- For information about movie image size, see page 87.
- For information about resizing existing snapshots, see page 113.

## ■ To select the image size

1. In the REC mode, use [▲] and [▼] to select the top control panel option (Image Size).

2. Use [◀] and [▶] to select an image size and then press [SET].

Image Size (Pixels)	Suggested Print Size and Application	Description
RAW+	RAW+JPEG (Select when you want to process image data yourself.)	Saves the image as both normal JPEG data and RAW image data. A 6M size image (2816×2112 pixels) is stored for the JPEG data. RAW image data is unprocessed data output by the image sensor and is saved in DNG (digital negative) format. Though the image of such data is virtually undeteriorated, it cannot be viewed on the camera's monitor screen or printed. After transferring RAW image data to your computer, you can use software that supports the general-purpose DNG format to process the image and convert it to image data that suits your particular needs. Since both RAW image data and JPEG data are saved by the camera, you can view the JPEG version on the camera's monitor screen.
6M (2816×2112)	A3 Print	Good detail for better clarity even for images cropped (page 114) from the original
3:2 (2816×1872)	A3 Print	
16:9 (2816×1584)	HDTV	
4M (2304×1728)	A4 Print	Good detail
3M (2048×1536)	A4 Print	
2M (1600×1200)	3.5"×5" Print	Best when preserving memory capacity is relatively more important than image quality.
VGA (640×480)	E Mail	Image files are smaller, which is better when attaching images to e-mail. However, images are relatively coarser.





- The initial factory default image size setting is 6M (6 million pixels).
- Selecting 3:2 (2816×1872 pixels) records images with an aspect ratio of 3:2, which matches the standard aspect ratio of print paper.
- The letters "HDTV" stand for "High Definition Television". An HDTV screen has an aspect ratio of 16:9, which makes them wider than the usual 4:3 aspect ratio of television screens of the past. Your camera can record images that are compatible with the aspect ratio an HDTV screen.
- You should regard the print paper sizes suggested here as guidelines only (200 dpi print resolution).
- You can shoot directly to RAW image data only while the  (Single Shot) is selected with the CS dial and "RAW+" is selected as the image size. Consecutive mode and BEST SHOT mode shooting produces "6M" image size JPEG images only, which is selected automatically.

## Using Flash (Flash)

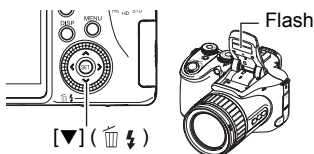
1. In the REC mode, press [**▼**] (  ) once.

2. Use [**◀**] and [**▶**] to select the flash setting you want and then press [**SET**].



 <b>Auto Flash</b>	Flash fires automatically in accordance with exposure (amount of light and brightness) conditions.
 <b>Flash Off</b>	Flash does not fire.
 <b>Flash On</b>	Flash always fires. This setting can be used to brighten a subject that normally comes out dark due to daylight or backlight (daylight synchro flash).
 <b>Red Eye Reduction</b>	Flash fires automatically. This type of flash can be used to reduce the chance of redness in the subject's eyes.
 <b>External Flash</b>	Fires a commercially available external flash unit. Flash always fires. <ul style="list-style-type: none"> <li>• See page 92 for more information about using an external flash.</li> </ul>

### 3. Press the shutter button to shoot.

- If the camera senses that flash is necessary, the flash unit will pop up automatically when you half-press or full-press the shutter button.

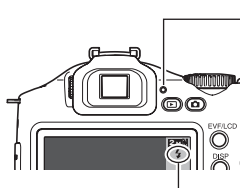

#### Back lamp

Flashes red while the flash is charging to indicate that image recording is disabled.

- You will not be able to take another flash snapshot until the lamp stops flashing red, which indicates that charging is complete.

 indicates the flash will fire.

- Note that the flash unit does not close automatically. After you are finished using it, you need to close it by hand.



#### NOTE

- Take care to ensure nothing is close to or in contact with the flash unit when it fires. Also make sure that the flash unit and the area around it is not dirty. Objects, dust, or dirt near the flash unit can be burned when the flash fires.
- Take care so your fingers and the strap do not block the flash.
- The desired effect may not be obtained when the subject is too far away or too close.
- Flash charging time depends on operating conditions (battery condition, ambient temperature, etc.) With a fully charged battery it takes anywhere from a few seconds to 9 seconds.
- Shooting with flash turned off when lighting is dim results in a slow shutter speed, which can cause image blur due to camera movement. Under such conditions, secure the camera with a tripod, etc.
- With red eye reduction, the flash is fired automatically in accordance with exposure. It does not fire in areas where lighting is bright.
- The presence of outdoor sunlight, fluorescent lighting, or some other light source can cause abnormal image colors.
- Select "Flash Off" for the flash setting when shooting in areas where flash photography is prohibited.
- Approximate Flash Range (ISO Sensitivity: AUTO)  
Wide Angle: 0.5 m to 6.7 m (1.6' to 22.0')  
Telephoto: 1.1 m to 3.9 m (3.6' to 12.8')  
\* The above values depend on the optical zoom setting.



## Red-eye Reduction

Using the flash to shoot at night or in a dimly lit room can cause red spots inside the eyes of people who are in the image. This is caused when the light from the flash reflects off of the retina of the eye. When red-eye reduction is selected as the flash mode, an LED light will light immediately before the flash fires. This causes the irises in the eyes of any people in the image to become smaller, which reduces the chance of red eye.

Note the following important points when using red-eye reduction.

- Red-eye reduction does not work unless the people in the image are looking directly at the camera (flash).
- Red-eye reduction may not work very well if the subjects are located far away from the camera.

## Other Useful Flash Features

- Changing the flash intensity (page 89)
- Compensating for insufficient flash intensity (page 89)
- Using an external flash (page 92)

## Specifying ISO Sensitivity (ISO)

ISO sensitivity is a measure of sensitivity to light.

**1. In the REC mode, use [▲] and [▼] to select the third control panel option from the top (ISO Sensitivity).**

**2. Use [◀] and [▶] to select the setting you want and then press [SET].**

<b>AUTO</b>	Adjusts sensitivity automatically according to conditions		
<b>ISO 100</b>	Lower sensitivity	Slow shutter speed	Less noise
<b>ISO 200</b>	↑ ↓	↑ ↓	↑ ↓
<b>ISO 400</b>			
<b>ISO 800</b>			
<b>ISO 1600</b>			
	Higher sensitivity	Fast shutter speed (Set for shooting in dimly lit areas.)	Some coarseness (increased digital noise)

- “AUTO” ISO sensitivity always is applied for movies, regardless of the current ISO sensitivity setting.
- “ Image AS” (page 81) can be used only when the ISO sensitivity setting is “AUTO”.
- An ISO setting of ISO 400 or greater is not supported when the “Image Size” setting is “RAW+”. If the ISO setting is “ISO 400” or greater when you change the “Image Size” setting to “RAW+”, an ISO setting of ISO 200 will be used for recording.

## Adjusting White Balance (White Balance)

You can adjust white balance to match the source of light available where you are shooting and avoid the blue cast that results when shooting outdoors when it is cloudy, and the green cast that results when shooting under fluorescent lighting.

**1. In the REC mode, use [▲] and [▼] to select the fourth control panel option from the top (White Balance).**

2. Use [◀] and [▶] to select the shooting condition you want and then press [SET].

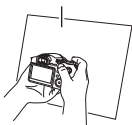
<b>AWB Auto WB</b>	Configures the camera to adjust white balance automatically
<b>☀ Daylight</b>	For shooting outdoors on a clear day
<b>☁ Overcast</b>	For shooting outdoors on an overcast rainy day, in the shade, etc.
<b>🌳 Shade</b>	For shooting on a clear day in the shade of trees or buildings
<b>☀N Day White Fluorescent</b>	For shooting under white or day white fluorescent lighting
<b>☀D Daylight Fluorescent</b>	For shooting under daylight fluorescent lighting
<b>💡 Tungsten</b>	For shooting under light bulb lighting
<b>MWB Manual WB</b>	<p>For configuring the camera manually to suit a particular light source.</p> <p>① Select “<b>MWB Manual WB</b>”.</p> <p>② Under the lighting conditions you plan to use when shooting, point the camera at a blank white piece of paper so it fills the entire monitor screen and then press the shutter button.</p> <p>③ Press [SET].</p> <p>The white balance setting is retained even if you turn off the camera.</p> <div style="text-align: right;"> <p>Blank white paper</p>  </div>

- When “**AWB Auto WB**” is selected for the white balance setting, the camera automatically determines the white point of the subject. Certain subject colors and light source conditions can cause problems when the camera tries to determine the white point, which makes proper white balance adjustment impossible. If this happens, select the white balance setting that matches your shooting conditions (Daylight, Overcast, etc.)

## Correcting Image Brightness (EV Shift)

You can manually adjust an image's exposure value (EV value) before shooting it.

- Exposure Compensation Range:  $-2.0\text{EV}$  to  $+2.0\text{EV}$
- Unit:  $1/3\text{EV}$

**1. In the REC mode, use [▲] and [▼] to select the fifth control panel option from the top (EV Shift).**

**2. Use [◀] and [▶] to adjust the exposure compensation value.**

[▶]: Increases the EV value. A higher EV value is best for light-colored subjects and backlit subjects.

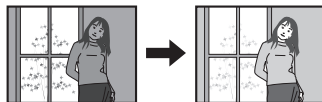

[◀]: Decreases the EV value. A lower EV value is best for dark-color subjects and for shooting outdoors on a clear day.

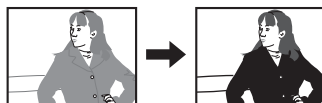

To cancel exposure compensation, change the EV value to 0.0.

**3. Press [SET].**

This applies the exposure compensation value. The exposure compensation value you set remains in effect until you change it.

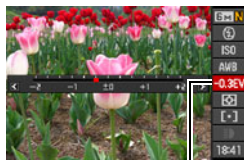

Exposure compensation value

### NOTE



- When shooting under very dark or very bright conditions, you may not be able to obtain satisfactory results even after performing exposure compensation.

## Specifying the Metering Mode (Metering)

The metering mode determines what part of the subject is metered for exposure.

**1. In the REC mode, use [▲] and [▼] to select the sixth control panel option from the top (Metering).**

**2. Use [◀] and [▶] to select the setting you want and then press [SET].**

 <b>Multi</b>	Multi-pattern metering divides the image into sections and measures the light in each section for a balanced exposure reading. This type of metering provides error-free exposure settings for a wide range of shooting conditions.
 <b>Center Weighted</b>	Center weighted metering concentrates on the center of the focus area to measure light. This type of metering is best when you want some level of control over contrast.
 <b>Spot</b>	Spot metering takes readings at a very small area. Use this metering method when you want exposure to be set according to the brightness of a particular subject, without being affected by surrounding conditions.



## Specifying the Auto Focus Area (AF Area)



You can use the following procedure to change the Auto Focus metering area for shooting snapshots.

- When recording movies, the AF metering area is always “ Spot”.

**1. In the REC mode, use [▲] and [▼] to select the third control panel option from the bottom (AF Area).**

## 2. Use [◀] and [▶] to select the setting you want and then press [SET].

 Spot	This mode takes readings of a small area in the center of the image. This setting works well with focus lock (page 44).
 Free	You can move the focus frame by using [▲], [▼], [◀], and [▶] to move the focus point and then pressing [SET]. To change the focus point position, select “Free” again and then use [▲], [▼], [◀] and [▶] to select the position you want.
 Tracking	When you half-press the shutter button while this setting is selected, the focus frame will follow the movement of the subject.

“ Spot” or “ Tracking”

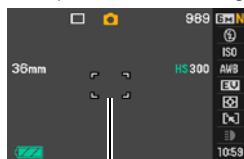

Focus frame

“ Free”

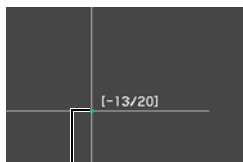

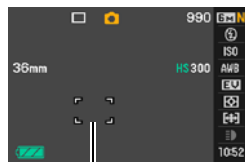

Focus point

→  
[SET]





Focus frame

- “ Tracking” cannot be used in combination with the following features. Prerecord (Still image), Slow Motion View, some BEST SHOT scenes (Move Out CS, Move In CS, For YouTube, Prerecord (Movie))
- “ Free” cannot be selected for the AF area while Face Detection is enabled.

## Shooting with the REC Light (REC Light)

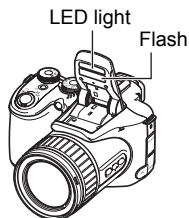
You can use the REC light for illumination when recording a movie where lighting is dim. Turning on the REC light causes the LED light to light and stay on.



1. In the REC mode, set the CS dial to  (Single Shot).
2. Use [▲] and [▼] to select the second control panel option from the bottom (REC Light).
3. Use [◀] and [▶] to select “On” and then press [SET].

When “On” is selected, the LED light remains lit.

- The effectiveness of the REC light is reduced in the case of far away subjects.
- You will be able to use the LED light during movie recording only if you open the flash before you start recording.
- To toggle the LED light off and on during recording, press the [▼] button. You cannot turn the LED light off and on during High-speed Movie recording.

## Changing the Control Panel Date/Time Style

1. In the REC mode, use [▲] and [▼] to select the bottom control panel option (Date/Time).

You can use [◀] and [▶] to select date or time display.

### NOTE

- You can select either of two display styles (page 141) for the date: Month/Day or Day/Month.
- The time is displayed using 24-hour format.

## Shooting with Zoom

Your camera provides you with 12X optical zoom (that changes the lens focal distance), which can be used in combination with digital zoom (that digitally processes the center portion of the image to enlarge it) for total zoom capabilities of 12X to 180.7X. The image deterioration point depends on the image size (page 42).

### 1. In the REC mode, slide the zoom controller to zoom.





 Telephoto

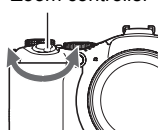

 Wide Angle

Zoom controller



 (Telephoto) : Enlarges the subject and narrows the range

 (Wide Angle) : Reduces the size of the subject and broadens the range

- Sliding the zoom controller as far as it will go in either direction will zoom at high speed.



### 2. Press the shutter button to shoot the image.

#### NOTE

- The higher the digital zoom factor, the coarser the recorded image. Note that the camera also has a function that lets you record using digital zoom without image deterioration (page 42).
- Use of a tripod is recommended to protect against image blur due to camera movement when shooting with telephoto.
- Performing a zoom operation changes the lens aperture.
- Digital zoom is disabled while "RAW+" is selected for the "Image Size" setting (page 30).



## Optical Zoom/Digital Zoom Switch Point

If you hold the zoom controller towards  (Telephoto), the zoom operation will stop when the optical zoom factor reaches its maximum. Momentarily releasing the zoom controller and then holding it again towards  (Telephoto) will switch to digital zoom, which you can use to set an even higher zoom factor.

- If you do want to use digital zoom, change the "Digital Zoom" setting to "On" (page 84).
- During zoom, a zoom bar on the monitor screen shows the current zoom setting.

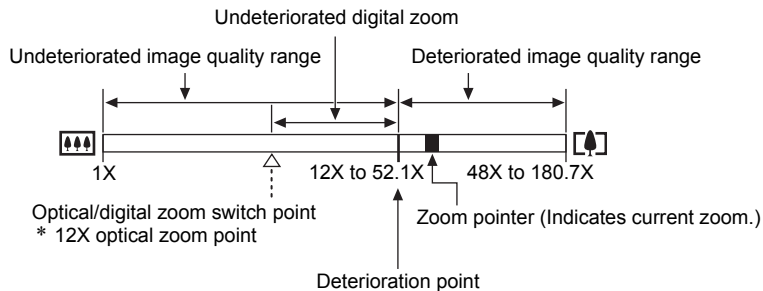
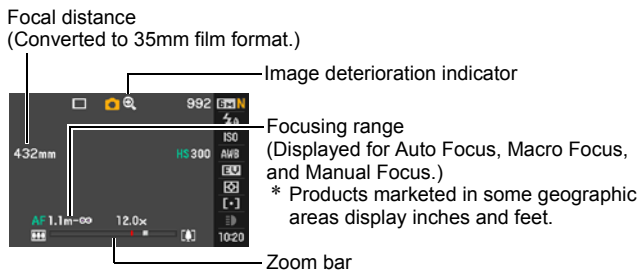

- The deterioration point depends on the current image size setting (page 29). The smaller the image size setting, the higher the zoom factor you can use before reaching the image deterioration point.
- Though digital zoom generally causes a deterioration of image quality, some digital zoom without image deterioration is possible with image sizes of "4M" and smaller. The range in which you can use digital zoom without image deterioration is indicated on the display. The deterioration point depends on the image size.
- Maximum zoom (including digital zoom) during movie recording is 48X.
- Movie recording with little deterioration up to 48X is possible only when "STD" is selected as the movie mode.

Image Size	Maximum Zoom Factor	Deterioration Point
6M	48X	12X
3:2	48X	12X
16:9	48X	12X
4M	58X	14.6X
3M	65.4X	16.4X
2M	83X	21X
VGA	180.7X	52.1X

## Selecting a Focus Mode (Focus)

Each press of [FOCUS] will cycle through the available focus mode settings.

[FOCUS]

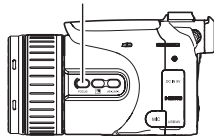

Settings	Type of Shot	Focus Mode		Approximate Focus Range*	
		Snapshot	Movies	Snapshot	Movies
<b>AF</b> Auto Focus	General recording	Automatic		Approximately 40 cm to ∞ (infinity) (1.3' to ∞)	
<b>MF</b> Macro Focus	Close ups	Automatic		Approximately 5 cm to 50 cm (2.0" to 19.7")	
<b>∞</b> Infinity Focus	Scenery and other distant subjects	Fixed		Infinity	
<b>MF</b> Manual Focus	When you want to focus manually	Manual		Approximately 5 cm to ∞ (infinity) (2.0" to ∞)	

• Range is affected by optical zoom.

\* The focus range is the distance from the lens surface.

### To focus with manual focus

**1. On the monitor screen, compose the image so the subject you want to focus on is within the yellow boundary.**



Yellow boundary

**2. Watching the image on the monitor screen use [◀] and [▶] to adjust focus.**

- At this time the image that is within the boundary will enlarge and fill the monitor screen, which aids in focusing. If you do not perform any operation for two seconds while the enlarged image is displayed, the screen in step 1 will re-appear.
- You also can change this setting using the function ring.

## NOTE

- An Auto Macro feature detects how far the subject is from the lens and automatically selects either Macro Focus or Auto Focus accordingly.
- When proper focusing with Macro Focus is not possible because the subject is outside the macro range, the camera will switch to the Auto Focus range automatically (Auto Macro).
- Auto Macro can be used when recording snapshots only.
- Use of the flash together with Macro Focus can cause the light of the flash to become blocked, which may result in unwanted lens shadows in your image.
- Whenever you perform an optical zoom operation while shooting with Auto Focus, Macro Focus, or Manual Focus, a value will appear on the monitor screen to tell you the focus range, as shown below.

Example: ○○ cm to ∞

\* ○○ is the actual focusing range value.

\* Products marketed in some geographic areas display inches and feet.

- Always be sure to select Auto Focus (AF) as the focus mode whenever using face detection (page 82).

## Using Focus Lock

“Focus lock” is a technique you can use when you want to compose an image in which the subject you want to focus on is not within the focus frame in the center of the screen.

- To use focus lock, select “[] Spot” or “[] Tracking” for the Auto Focus area (page 37).

**1. Align the monitor screen’s focus frame with the subject you want to focus on and then half-press the shutter button.**

Subject to be focused on

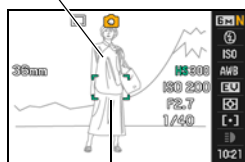

Focus frame

**2. Keeping the shutter button half-pressed (which maintains the focus setting), move the camera to compose the image.**

- When “[] Tracking” is selected as the Auto Focus area, the focus frame will move automatically and follow the subject.

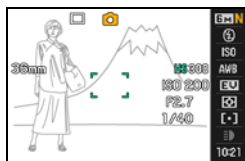

**3. When you are ready to shoot the image, press the shutter button the rest of the way down.**

- Focus lock also locks exposure (AE).

## Correcting for Back Lighting

Back lighting correction compensates for the overexposure that can occur when shooting a backlit subject. Press  (Back Lighting Correction button) to toggle back lighting correction on and off.

- When a main subject is overexposed due to backlighting, the camera uses EV shift exposure correction and dynamic range correction to adjust appropriately.
- This function is disabled in the M (Manual Exposure) mode.

 (Back Lighting Correction button)

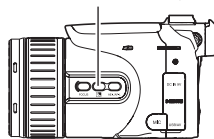

## Locking the Auto Exposure and Auto Focus Setting

Pressing [AE-L/AF-L] temporarily locks the current exposure and/or focus settings. Press [AE-L/AF-L] again to unlock the settings.

- Pressing [AE-L/AF-L] while the shutter button is half-pressed will lock the current exposure or focus setting.

[AE-L/AF-L]

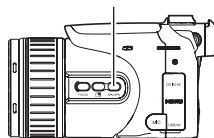

## Specifying the [AE-L/AF-L] button Operation

Use the following procedure to specify the operation that the [AE-L/AF-L] button performs.

1. In the REC mode, press [MENU].
2. Use [◀] and [▶] to select “REC”.
3. Use [▲] and [▼] to select “AE/AF Lock” and then press [▶].
4. Use [▲] and [▼] to change the setting, and then press [SET] to apply it.

AE Lock	Exposure lock
AF Lock	Focus lock
AE/AF Lock	Exposure and focus lock

### NOTE



- AE Lock and AF Lock are not supported while “ Tracking” is selected for the “AF Area” setting.
- Performing an EV shift operation while AE Lock is in effect will cause Auto Exposure to be unlocked.
- Performing a zoom operation while AF Lock is in effect will cause Auto Focus to be unlocked.
- During movie recording, you cannot lock/unlock the current exposure and focus settings by pressing [AE-L/AF-L].
- You cannot use AE Lock or AF Lock with “Prerecord (Movie)” if you are recording a movie.

## Using Continuous Shutter

### Selecting the Continuous Shutter (CS) Mode

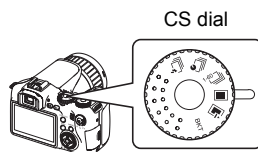
Your camera has a variety of continuous shutter (CS) modes that you can select with the CS dial.



 <b>Flash CS</b>	<p>This mode will record consecutive images while firing the flash or LED light.</p> <ul style="list-style-type: none"><li>• With flash, you can specify consecutive recording of three to 20 images as the maximum number of images recorded if you keep the shutter button depressed.</li><li>• With the LED light, holding down the shutter button will record from one to 60 consecutive images.</li></ul>
 <b>Pre-record (Still image)</b>	<p>In this mode, half-pressing the shutter button starts continual pre-recording of images to a temporary buffer. Then when you press the shutter button the rest of the way down, the camera stores pre-recorded images and performs continuous shutter recording of new images until you release the shutter button. You can specify anywhere from one second to up to 60 seconds as the continuous shutter shooting time, which is the amount of time for which pre-recorded images are saved plus the amount of time that continuous shutter recording is performed after the shutter button is pressed all the way down. You even can specify that the camera should save only images that were pre-recorded for a period of from one to 60 seconds when the shutter button is pressed all the way down. Use this mode when you want to make sure you do not miss fast-moving action.</p>
 <b>High-speed CS</b>	<p>This mode continues to shoot images as long as you keep the shutter button depressed, and you can change the shooting speed while recording is in progress. You can record up to 60 images when any setting other than AUTO-N is specified. When AUTO-N is specified, consecutive image recording is possible until the memory card is full.</p>

<b>Single Shot</b>	Continuous shutter recording is disabled when this mode is selected. Each press of the shutter button records a single image.
<b>Slow Motion View</b>	With this mode, half-pressing the shutter causes the camera to pre-record images and play them back at slow speed. Up to two seconds worth of pre-recorded images are in memory at one time, with the older images deleted automatically as new ones are stored. Fully pressing the shutter button will record the pre-recorded images. This mode lets you view the pre-recorded images in slow motion, and perform final recording when the image you want appears. You can specify one of eight playback speeds for pre-recorded images.
<b>[BKT] Bracketing</b>	With this mode, you can record multiple images while sequentially altering settings for each shot. Settings that can be altered are EV shift, white balance, and distance to the subject.



## Using Flash Continuous Shutter

This mode will record consecutive images while firing the flash or LED light.

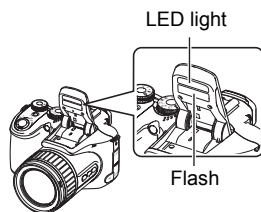
- The flash is used when the continuous shutter speed setting is from one image to seven images per second. The LED light is used when setting is from 10 images to 60 images per second.
- With flash, you can specify consecutive recording of three to 20 images. Recording will stop if you release the shutter button.
- With the LED light, holding down the shutter button will record from one to 60 consecutive images. Recording will stop if you release the shutter button.



### Shooting at 10 to 60 Images Per Second with the LED Light

1. Set the mode dial to  (Auto).
2. Set the CS dial to  (Flash CS).
3. Use [**▲**] and [**▼**] to select the second control panel option from the bottom (Flash CS fps).
4. Use [**◀**] and [**▶**] to select the continuous shutter (CS) speed you want and then press [**SET**].

The LED light is used for flash when the CS speed is within the range of 10 to 60 fps.

- You also can change this setting using the control dial.

CS speeds with LED light



### 5. Hold down the shutter button to shoot.

Holding down the shutter button while flash continuous shutter is selected shoots up to 60 images at high speed. Releasing the shutter button stops shooting.

### 6. Save the CS images (page 58).



## ■ Shooting at 1 to 7 Images Per Second with Flash

1. Set the mode dial to  (Auto).

---

2. Set the CS dial to  (Flash CS).

---

3. Use [▲] and [▼] to select the second control panel option from the bottom (Flash CS fps).

---

4. Use [◀] and [▶] to select the continuous shutter (CS) speed you want and then press [SET].

Flash Unit CS Speeds



The flash unit fires when the CS speed is within the range of 1 to 7 fps.

- You also can change this setting using the control dial.
- 

5. Use [▲] and [▼] to select the bottom item (Flash CS Images).

---

6. Use [◀] and [▶] to select the number of flash continuous shutter (CS) images you want to shoot and then press [SET].



You can select any one of the following values: 3, 5, 10, 15, or 20.

---

7. Press the shutter button to shoot.

---

8. If you keep the shutter button depressed, the camera will shoot the number of images you specified. Recording will stop if you release the shutter button before the specified number of images is reached.

---

9. Save the CS images (page 58).

---

### NOTE

- When shooting with Flash CS, there may be times when a message appears telling you to wait, because you have reached the limit of the flash. This is to protect the flash from damage. You will be able to resume using flash after the message disappears.

## Using Prerecord (Still image)

In this mode, half-pressing the shutter button starts continual pre-recording of images to a temporary buffer. Then when you press the shutter button the rest of the way down, the camera stores what is currently in the buffer and starts continuous shutter recording of new images. Recording continues until you release the shutter button or until a total of up to 60 images (buffer images plus new images) are recorded. You can configure this mode to specify how many of the 60 images are recorded in the buffer and how many are recorded after you fully press the shutter button. You can use this mode when you want to make sure you do not miss fast-moving action.

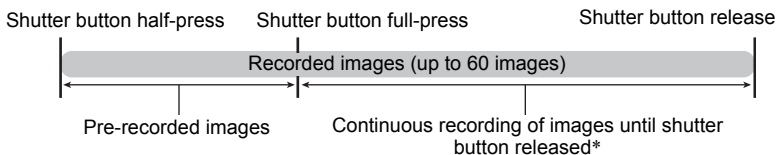

\* You can record up to 60 images (pre-recorded buffer images plus real-time images) for each Prerecord (Still Image) operation.

- You can specify anywhere from one second up to 60 seconds as the continuous shutter shooting time, which is the amount of time of the pre-record buffer plus the amount of time that continuous shutter recording is performed after the shutter button is pressed all the way. The maximum shooting time depends on the selected CS speed. You can select a CS speed in the range of 1 to 60 fps. 60 images per second (60 fps): You can shoot up to 60 images in one second. 1 image per second (1 fps) : You can shoot up to 60 images over 60 seconds.
- You can configure the mode so all 60 images are stored from the buffer, which pre-records images before you fully press the shutter button.
- The minimum interval for images pre-recorded in the buffer is 0.5 seconds and the minimum number of pre-recorded images is one.

**1. Set the mode dial to  (Auto).**

**2. Set the CS dial to  (Prerecord (Still image)).**

**3. Use [▲] and [▼] to select the second control panel option from the bottom (Prerecord (Still image) Speed).**

---

**4. Use [◀] and [▶] to select the continuous shutter (CS) speed you want and then press [SET].**

- You also can change this setting using the control dial.

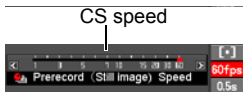

---

**5. Use [▲] and [▼] to select the bottom control panel option (Prerecord (Still image) Time).**

---

**6. Use [◀] and [▶] to specify how many of the 60 images and for how long images should be pre-recorded in the buffer.**

Number of pre-record images and pre-record time

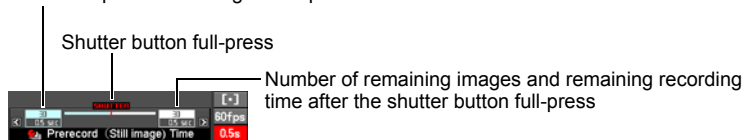

- You also can change this setting using the control dial.

---

**7. Press [SET].**

- The approximate number of recordable CS images will appear on the monitor screen.

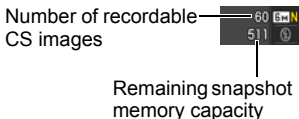

---

**8. Half-press the shutter button.**

This will cause the camera to start pre-recording images.

- The camera will not emit a shutter sound when you half-press the shutter button while Prerecord (Still image) is selected.

---

**9. Press the shutter button the rest of the way down.**

This will record the images in the pre-record buffer and start recording new images in real-time. Images continue to be shot as long as you keep the shutter button depressed.

---



**10. Image recording will stop when you release the shutter button or after a total of 60 images are recorded.**

---

**11. Save the CS images (page 58).**

## Using High-speed Continuous Shutter

With High-speed Continuous Shutter (CS), images continue to be shot as long as you keep the shutter button depressed. You can specify a CS speed of one to 60 images per second, and even change the speed while CS image recording is in progress.

1. Set the mode dial to  (Auto).
2. Set the CS dial to  (High-speed CS).
3. Use [▲] and [▼] to select the second control panel option from the bottom (High-speed CS fps).
4. Use [◀] and [▶] to select the continuous shutter (CS) speed you want and then press [SET].

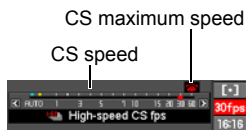

<b>AUTO-N</b>	This setting allows CS recording to continue as long as memory is available. The camera measures light levels and configures the CS speed setting automatically.
<b>AUTO-H</b>	Records up to 60 CS images. The camera measures light levels and configures the fastest possible CS speed setting automatically. The upper limit of the speed is the CS speed currently selected with the control dial.
<b>1 to 60 fps</b>	Enables specification of the number of CS images recorded per second. Up to 60 CS images can be recorded per second.

- You also can use the control dial to set the CS speed upper limit. You can use the control dial to ensure that the CS speed can only go up to the level that suits your needs.
- The number of continuous shutter shots you can record and the approximate time in seconds that it will take to shoot all of the shots are indicated on the display.

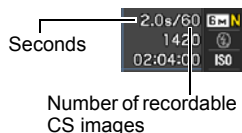

---

## 5. Hold down the shutter button to shoot.

Images continue to be shot as long as you keep the shutter button depressed. Releasing the shutter button stops shooting.

- When “AUTO-N” is selected as the CS speed, you can continue recording until the memory card becomes full. When any other CS speed setting is selected, recording will stop automatically after a maximum of 60 images are recorded, even if you keep the shutter button depressed.
- When “CS fps” is selected for “Ring Setup” (page 85), you can use the function ring to change the CS speed while image recording is in progress.

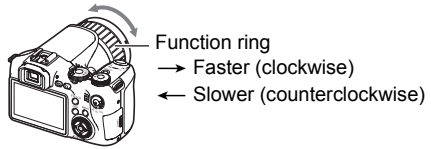



---

## 6. Save the CS images (page 58).

### Shooting with Slow Motion View

When you half-press the shutter button while Slow Motion View is selected, the camera will start to pre-record images continually and play them back at slow speed. Up to two seconds worth of pre-recorded images are in memory at one time, with the older images deleted automatically as new ones are stored. Fully pressing the shutter button will save the pre-recorded images. This mode lets you view the pre-recorded images in slow motion, and perform final recording when the image you want appears. You can specify one of eight playback speeds for pre-recorded images.

1. In the REC mode, set the mode dial to  (Auto).
2. Set the CS dial to  (Slow Motion View).
3. Use [▲] and [▼] to select the second control panel option from the bottom (Slow Motion View Speed).

---

**4. Use [◀] and [▶] to select the Slow Motion View playback speed you want and then press [SET].**



You can select one of eight speeds, from 1 to 8. A higher level number specifies a faster playback speed.

- You also can change this setting using the control dial.

---

**5. Half-press the shutter button.**

This will start slow motion playback of pre-recorded images on the monitor screen.

- Releasing the half-pressed shutter button will stop slow motion playback of the pre-recorded images.

---

**6. When you want to save a pre-recorded image, press the shutter button the rest of the way.**

This will save the pre-recorded image that is on the monitor screen when you press the shutter button.

---

**NOTE**

- Slow Motion View does not operate correctly if you press the shutter button all the way down. Be sure to half-press the shutter button. After images are pre-recorded, press the shutter button the rest of the way down.

---

## Shooting with Bracketing Continuous Shutter

With this mode, you can record multiple images while sequentially altering settings for each shot. Settings that can be altered are EV shift, white balance, and distance to the subject.

### ■ Using Auto Bracketing with Exposure Selected as the Variable (AE Bracketing)

#### Specifying the Bracket Increment and Number of Images

**1. In the REC mode, press [MENU].**

---

**2. Use [◀] and [▶] to select “REC”.**

---

**3. Use [▲] and [▼] to select “AE Bracketing” and then press [▶].**

---

**4. Use [▲] and [▼] to specify the number of images you want to record.**

Select either 3 or 5.

- You also can change this setting using the control dial.



---

**5. Use [◀] and [▶] to specify the bracket increment.**

---

**6. When the settings are the way you want, press [SET].**

Bracketing range

### Recording

---

**1. In the REC mode, set the mode dial to  (Auto).**

---

**2. Set the CS dial to [BKT] (Bracketing).**

---

**3. Use [▲] and [▼] to select the second control panel option from the bottom (Bracketing).**

---

**4. Use [◀] and [▶] to select “AEB” and then press [SET].**



---

**5. Press the shutter button to shoot.**

Pressing the shutter button once records the preset number of images.

---

**6. Save the CS images (page 58).**

## ■ Using Auto Bracketing with White Balance Selected as the Variable (White Balance Bracketing)

### Specifying the Bracket Increment and Number of Images

1. In the REC mode, press [MENU].
2. Use [◀] and [▶] to select “REC”.
3. Use [▲] and [▼] to select “WB Bracketing” and then press [▶].
4. Use [▲] and [▼] to specify the number of images you want to record.  
Select either 3 or 5.
  - You also can change this setting using the control dial.
5. Use [◀] and [▶] to specify the white balance increment.
6. When the settings are the way you want, press [SET].

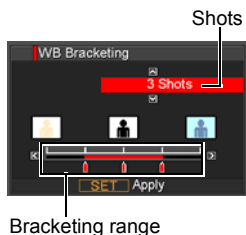

### Recording

1. In the REC mode, set the mode dial to  (Auto).
2. Set the CS dial to [BKT] (Bracketing).
3. Use [▲] and [▼] to select the second control panel option from the bottom (Bracketing).
4. Use [◀] and [▶] to select “WBB”, and then press [SET].
5. Press the shutter button to shoot.  
Pressing the shutter button once records the preset number of images.
6. Save the CS images (page 58).



## ■ Using Auto Bracketing with Focus Selected as the Variable (Focus Bracketing)

### Specifying the Bracket Increment and Number of Images

1. In the REC mode, press [MENU].
2. Use [◀] and [▶] to select “REC”.
3. Use [▲] and [▼] to select “Focus Bracketing” and then press [▶].
4. Use [▲] and [▼] to specify the number of images you want to record.  
Select either 3 or 5.
  - You also can change this setting using the control dial.
5. Use [◀] and [▶] to specify the increment range.
6. When the settings are the way you want, press [SET].

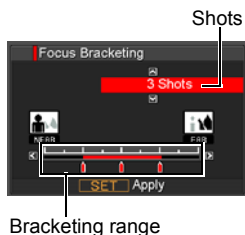

### Recording

1. In the REC mode, set the mode dial to  (Auto).
2. Set the CS dial to [BKT] (Bracketing).
3. Use [▲] and [▼] to select the second control panel option from the bottom (Bracketing).
4. Use [◀] and [▶] to select “AFB” and then press [SET].
5. Press the shutter button to shoot.  
Pressing the shutter button once records the preset number of images.
6. Save the CS images (page 58).

## Specifying the Method for Saving Continuous Shutter Images

You can specify the method to use for saving images recorded with the following continuous shutter (CS) modes.

Flash CS, Prerecord (Still image), High-speed CS, Bracketing

1. In the REC mode, press [MENU].
2. Use [◀] and [▶] to select “REC”.
3. Use [▲] and [▼] to select “Save CS Images”, and then press [▶].
4. Use [▲] and [▼] to change the setting.

### Normal (Batch)

All images that were shot are saved after the continuous shutter operation is finished.

- In the case of Prerecord (Still image) (page 50), the images that were shot are played back in reverse sequence and then saved.

## Select & Save

After continuous shutter shooting is finished, the shot images are played back at slow speed so you can select the images you want to save.

- Images shot with Prerecord (Still Image) (page 50) are played back automatically in reverse sequence, and then played slowly in forward sequence. Images recorded with other CS modes are played back in forward sequence.
- When you shooting with Prerecord (Still Image), the first image saved when you press the shutter all the way is indicated by an "S" mark so you can tell where the continuous shutter operation started.

- ① While the shot images are playing back and an image appears that you want to save, press the shutter button. Each image that you select by pressing the shutter button will have a mark appended to it.
- ② After selecting all of the images you want to save, press [▲].



### Buttons Used for Image Selection

[◀] [▶]	During playback, changes the playback direction and playback speed. While playback is paused, scrolls forward or back.
Control dial	During playback, changes the playback direction and playback speed. While playback is paused, scrolls forward or back.
[SET]	Toggles between pause and play.
Shutter button	Press all the way down to select an image for saving.
[▲]	Saves the selected images and exits the image select operation.

- ③ Use [▲] and [▼] to select the save method you want and then press [SET].  
Save Selected : Saves selected images.  
Save All : Saves all the images.  
Cancel Save : Does not save any of the images.

## Always Ask

After continuous shutter shooting is finished, a prompt appears allowing you to select Normal (Batch) or Select & Save.

Select the save method you want to use and then press [SET].

Save Selected: Saves selected images.

Save All : Saves all the images.

Cancel Save : Does not save any of the images.

## 5. Press [SET] to apply the setting.

### Continuous Shutter Precautions

- If there is not enough available capacity on the memory card, you may not be able to record the number of CS images indicated on the monitor screen. Make sure your memory card has sufficient remaining capacity before shooting with using continuous shutter.
- With continuous shutter, exposure and focus for the first image are applied for successive images as well.
- Continuous shutter cannot be used in combination with any of the following. Movie Mode, some BEST SHOT scenes (Digital Anti Shake, Move Out CS, Move In CS, Digital Panning)
- When using a continuous shutter mode, keep the camera still until shooting is finished.
- In the Prerecord (Still image) and High-speed CS modes, the flash setting automatically becomes  (flash off).
- Zoom is disabled during continuous shutter operations.
- Automatic noise reduction at slow shutter speeds is not performed when shooting with Bracketing CS.
- When the High-speed CS speed setting is anything other than "AUTO-N", the maximum number of images per continuous shutter session is limited for Prerecord (Still image), Flash CS, and Bracketing, even if there is memory card capacity available to store more images.

<b>High-speed CS speed setting not "AUTO-N"</b>	Up to 60 images
<b>Prerecord (Still image)</b>	Up to 60 images
<b>Flash CS with flash</b>	Up to 3 to 20 images
<b>Flash CS with LED light</b>	Up to 60 images
<b>Bracketing</b>	Up to 5 images

The number of images will be restricted even further or shooting may be impossible when remaining memory card capacity is less than the allowable number of images for a particular CS mode.

- The Flash CS mode switches between the flash and the LED light automatically in accordance with the CS speed. You cannot switch between the flash and the LED light manually. In the Flash CS mode, either the flash or the LED light will fire whenever an image is shot.

- The Triple Self-time cannot be used in the High-speed CS, Flash CS, and Bracketing modes.
- The Self-timer cannot be used in the Prerecord (Still image) and Slow Motion View modes.
- When the flash is fired for Flash CS, the greater the number of images setting, the smaller the flash range (shooting range). When the LED light is fired, the faster the shooting speed setting, the smaller the flash range (shooting range).
- The flash is disabled in the Bracketing mode.
- With some BEST SHOT scenes (Digital Anti Shake, Move Out CS, Move In CS, Digital Panning), the current CS dial setting is ignored.
- Continuous shutter recording is disabled while one of the following BEST SHOT scenes is selected.  
For YouTube, Prerecord (Movie)

# Recording Movies

## To record a movie

### 1. Set the Movie mode switch to [STD] (Standard).

- Recording is performed with an aspect ratio of 4:3, an image size of 640×480 pixels, and a frame rate of 30 frames per second. Image quality and image size settings cannot be changed.
- For information about the movie mode, see page 64.

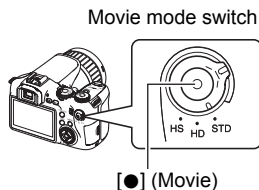

### 2. In the REC mode, press [●] (Movie).

This will start recording and display **REC** on the monitor screen.

Movie recording includes stereo audio.

Remaining recording time

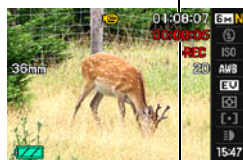

Recording time

### 3. Press [●] again to stop recording.

- The maximum file size allowed for a single movie file is 4GB. Movie recording stops automatically when the file size becomes 4GB.

## Shooting with BEST SHOT

With BEST SHOT (page 67), you can select the sample scene that matches the type of movie you are trying to shoot and the camera will change its setup accordingly, for beautiful movies every time. Selecting the BEST SHOT scene named Night Scene, for example, will configure the camera so night scenes appear clearer and brighter.

## Minimizing the Effects of Camera Movement during Movie Recording

You can configure the camera to minimize the effects of camera movement during movie recording (page 81). Note, however, that this does not prevent image blur due to subject movement.

## Audio

Your camera has built-in microphones that can be used to record audio during movie recording. An external microphone jack also supports connection of a commercially available external microphone. Note, however, that the built-in microphones are disabled while an external microphone is being used.

### ■ Recording Precautions

The camera also records audio. Note the following points when shooting a movie.

- Take care that the microphones are not blocked by your fingers, etc.
- Good recording results are not possible when the camera is too far away from what you are trying to record.
- Operating camera buttons while shooting can cause button noise to be picked up in the audio.

External microphone jack [MIC]

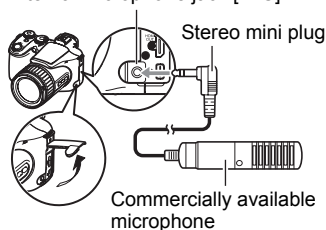

Microphones

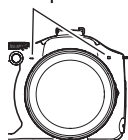

### NOTE

- Spending a long time using movie recording will cause the camera to become slightly warm to the touch. This is normal and does not indicate malfunction.
- Use of certain types of memory cards increase the time it takes to record movies, which can cause movie frames to be lost. The "● REC" indicator on the monitor screen turns yellow to indicate that frames are being lost. To avoid loss of movie frames, use of a memory card with a maximum transfer speed of at least 10MB per second is recommended.
- The effects of camera movement in an image become more pronounced when you shoot close up or with a large zoom factor. Because of this, use of a tripod is recommended under these conditions.
- Face Detection is disabled during movie recording.

## Movie Mode Settings

Your CASIO digital camera has three movie modes, each of which is described below. Before recording, rotate the movie mode switch to select the mode that suits the type of subject you are trying to record.

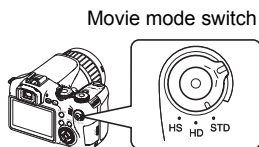

<b>STD</b>	Use this mode for standard movie recording. This is the mode you normally should use (page 62). In this mode, recording is performed with an aspect ratio of 4:3, an image size of 640×480 pixels, and a frame rate of 30 frames per second. Image quality and image size settings cannot be changed.
<b>HD</b>	Use this mode to record high-definition (Hi-Vision) movies (page 64). The aspect ratio of movies recorded with this mode is 16:9.
<b>HS</b>	Use this mode to record a high-speed movie at up to 1200 frames per second (page 65). The aspect ratio of movies recorded with this mode depends on the movie recording speed. <ul style="list-style-type: none"><li>• Audio is not recorded in this mode.</li></ul>

### Recording a High-definition Movie

**1. Before recording, use the HD movie quality setting to specify the movie quality (page 87).**

The size of the movie image and the maximum movie length will depend on the quality setting you select.

**2. Set the movie mode switch to [HD].**

**3. Record the movie the same way as you would a normal movie (page 62).**

Press [●] to start and stop recording.



## Recording a High-speed Movie

### 1. Before recording, set the frame rate (recording speed) of the movie (page 88).

The image size, aspect ratio, and maximum movie length will depend on the frame rate.

### 2. Set the movie mode switch to [HS].

### 3. Record the movie the same way as you would a normal movie (page 62).

Press [●] to start and stop recording.

#### NOTE

- When recording certain types of movies, the image that appears on the monitor screen may be smaller than normal. When recording an HD movie or high-speed movie, there are black bands along the top, bottom, left, and right of the screen.
- When recording a high-speed movie, light source flicker can cause horizontal bands to appear in the image. This does not indicate malfunction of the camera.
- Movie recording is disabled while any one of the following BEST SHOT scenes is selected.  
Digital Anti Shake, Move Out CS, Move In CS, Digital Panning
- During high-speed recording, recording is performed using the same setup as the  (Auto) recording mode, regardless of which BEST SHOT scene is selected.
- Snapshot in Movie is not supported during high-speed movie recording.
- During High-speed Movie recording, Auto Focus and exposure remain fixed at the levels they were when you initially started recording. Zoom, back lighting correction, monitor screen content switching, and AE Lock/AF Lock are all disabled.
- To focus the image, half-press the shutter button for Auto Focus or focus manually before starting the High-speed Movie recording operation.
- When recording a high-speed movie, you can record movies with the **A** (Aperture Priority) mode, **S** (Shutter Speed Priority) mode, or **M** (Manual Exposure) mode (page 25). Note, however, that you cannot set a shutter speed that is slower than the High-speed Movie frame rate. The **A**, **S**, and **M** mode settings are not supported when recording with “Prerecord (Movie)”.

## Shooting a Snapshot while Shooting a Movie

### 1. While a movie is being recorded, press the shutter button.

Movie recording continues after the snapshot is recorded.



Number of recordable snapshots

### NOTE

- You can shoot up to 20 snapshots per movie. The number of snapshots is also limited by the amount of free space available on the memory card.
- Note that the flash cannot be used when shooting a Snapshot in Movie.
- A snapshot cannot be shot during recording of the following types of movies. High-speed Movie, while recording with certain movie BEST SHOT scene (For YouTube).
- You cannot use Snapshot in Movie to shoot a snapshot when recording with "Prerecord (Movie)" while the movie is being recorded to the buffer before you press [●]. You will be able to shoot snapshots during real-time movie recording, which starts when you press [●].

# Using BEST SHOT

## What is BEST SHOT?

BEST SHOT provides you with a collection of sample “scenes” that show a variety of different types of shooting conditions. When you need to change the setup of the camera, simply find the scene that matches what you are trying to achieve, and the camera sets up for it automatically. This helps to minimize the chance of ruined images due to poor exposure and shutter speed settings.

## Some Sample Scenes

			
Portrait	Scenery	Night Scene	Night Scene Portrait

## To shoot with BEST SHOT

**1. In the REC mode, use the mode dial to select **BS**.**

**2. Press [SET].**

This will display a menu of BEST SHOT scenes.

**3. Use [▲], [▼], [◀], and [▶] to move the boundary to the scene you want to select.**

- The scene menu has multiple pages. Use [▲] and [▼] to scroll between menu pages.
- You can access information about the currently selected scene. See page 68 for details.

Currently selected scene (with boundary)

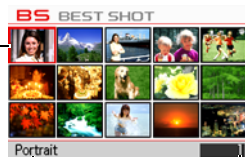

Scene name

Scene number

**4. Press [SET] to configure the camera with the settings for the currently selected scene.**

This returns to the REC mode.

- The settings of the scene you selected remain in effect until you select a different scene.
- To select a different BEST SHOT scene, repeat the above procedure from step 1.

**5. Press the shutter button (if you are shooting a snapshot) or [●] (if you are shooting a movie).**

## NOTE

- The BEST SHOT YouTube scene sets up the camera for recording movies that are optimized for uploading to YouTube. Movies recorded with the YouTube scene are stored in a special folder to make them easy to locate for uploading (page 127). When the Movie Mode setting (page 64) is “**HS**” (High-speed Movie) or “**STD**”, the YouTube scene movie is recorded with the current movie size, recording speed and quality settings. You cannot shoot with the “For YouTube” scene while “**HD**” is selected as the movie mode or while “1200 fps” is selected for high-speed movie.

## ■ Using the Scene Information Screen

To find out more about a scene, select it with the boundary on the scene menu and then slide the zoom controller in either direction.

- To return to the scene menu, slide the zoom controller again.
- To scroll between scenes, use [◀] and [▶].
- To configure the camera with the settings for the currently selected scene, press [SET]. To return to the scene information screen for the currently selected BEST SHOT scene, press [SET].

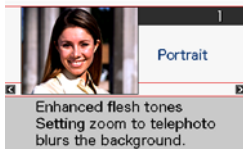

## ■ BEST SHOT Precautions

- The following BEST SHOT scenes cannot be used for shooting a snapshot. For YouTube, Prerecord (Movie)
- To focus before starting to record a movie with the “For YouTube” scene, select “On” for the “Continuous AF” setting on the “REC” tab or use manual focus. After focusing, start recording.
- A slow shutter speed setting is used when the “Night Scene” or “Fireworks” scene is selected. The camera automatically performs a digital noise reduction process at slow shutter speeds. It is a good idea to use a tripod to avoid image blur.
- Your camera includes a sample scene that optimizes settings for auction site images. Depending on your camera model, the sample scene is named either “For eBay” or “Auction”. Images you record using the auction site sample scene are stored in a special folder so you can easily find them on your computer (page 135).
- BEST SHOT scene images were not shot using this camera.
- Images shot using a BEST SHOT scene may not produce the results you expected due to shooting conditions and other factors.
- You can modify the camera settings that are configured after you select a BEST SHOT scene. Note, however, that the BEST SHOT settings revert to their defaults when you select another BEST SHOT scene or turn off the camera.
- The CS dial setting is ignored and the  (Single Shot) setting is used while the “Splashing Water”, “Night Scene”, “Night Scene Portrait”, or “Fireworks” BEST SHOT scene is selected.

## Creating Your Own BEST SHOT Setup

You can save up to 999 camera setups as user BEST SHOT scenes for instant recall whenever you need them.

- 1. On the BEST SHOT scene menu, select the scene named BEST SHOT (Register User Scene).**
- 2. Use [◀] and [▶] to select the snapshot whose setup you want to save.**
- 3. Use [▲] and [▼] to select “Save”, and then press [SET].**  
Your BEST SHOT scene will be assigned the name “Recall User Scene”, along with a scene number.

### NOTE

- You can create BEST SHOT setup for snapshots only. You cannot create a movie BEST SHOT setup.
- You can check the settings of the currently selected BEST SHOT scene by displaying the camera's setting menus and looking at its settings.
- User snapshot scenes are assigned numbers in the sequence: SU1, SU2, and so on.
- The following are the settings that are saved for each user snapshot BEST SHOT scene.  
Face Detection, Focus, EV Shift, White Balance, Flash, ISO, Metering, Dynamic Range, Flash Intensity, Flash Assist, Color Filter, Sharpness, Saturation, Contrast
- User BEST SHOT scenes are stored in built-in memory (page 135) in the SCENE folder (snapshots).
- Formatting the camera's built-in memory (page 145) deletes all user BEST SHOT scenes.
- Use the following procedure when you want to delete a user BEST SHOT scene.
  - ① Display the information screen (page 68) of the user BEST SHOT scene you want to delete.
  - ② Press [▼] (  ), select “Delete”, and then press [SET].

## Shooting with Digital Anti Shake (Digital Anti Shake)

When you press the shutter button while Digital Anti Shake is enabled, the camera records multiple images and automatically combines them in a way that produces a final image with minimal blur. You can shoot with this feature to minimize the effects of camera movement when shooting with optical anti shake does not produce the desired results.

- 1. In the REC mode, set the mode dial to .**

---

- 2. Press [SET] and then select “Digital Anti Shake”.**

---

- 3. When you are ready to shoot, press the shutter button all the way down.**
  - After you press the shutter button all the way, the message “Busy... Please wait...” will appear on the monitor screen to indicate that recording is in progress. Keep the camera still while this message is displayed. The recording process takes some time to complete after the message appears.

### NOTE

- The CS dial setting is ignored when recording with this BEST SHOT scene.
- Shooting with this BEST SHOT scene makes the shooting range narrower than normal.
- Digital Anti Shake will not operate correctly while the camera is mounted on a tripod.

## Shooting with Digital Panning (Digital Panning)

When you point the camera at a moving object and pan as you press the shutter button, the camera will perform a continuous shutter operation, recording multiple images. Then it will automatically correct for blurring of the subject only in the recorded images and combine them into a single image that shows a clear subject on a blurred background. This feature lets you shoot powerful panning images simply by following the subject.

- 1. In the REC mode, set the mode dial to .**

---

- 2. Press [SET] and then select “Digital Panning”.**

---

- 3. When you are ready to shoot, press the shutter button all the way down.**
  - Lines will appear on the monitor screen, dividing it into nine areas. As you shoot, move the camera to keep the subject within the middle area as much as possible.

### NOTE

- The CS dial setting is ignored when recording with this BEST SHOT scene.
- Shooting with this BEST SHOT scene makes the shooting range narrower than normal.
- Under certain lighting conditions, shooting with Digital Panning can result in overexposure.

## Shooting an Image in Accordance with Subject Movement (Move Out CS/Move In CS)

You can use these features to shoot an image automatically whenever the subject moves into or moves out of a frame on the monitor screen. You also can configure the camera to record images of what happened immediately before and after the subject moves.

<b>Move Out CS</b>	Automatically records what happened immediately before and after the subject moves outside of a boundary on the monitor screen.
<b>Move In CS</b>	Automatically records what happened immediately before and after the subject moves into a boundary on the monitor screen.

### ■ To setup the camera

1. In the REC mode, set the mode dial to **BS**.
2. Press [SET] and then select “Move Out CS” or “Move In CS”.
3. Use [▲] and [▼] to select the fourth control panel option from the bottom (⊕ Trigger Area Boundary), and then press [SET].

4. Configure the boundary location and size settings.

[▲][▼][◀][▶]	Moves the boundary.
<b>Control Dial</b>	Resizes the boundary.

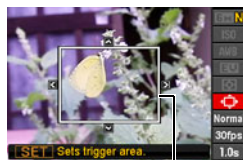

5. Press [SET].
6. Use [▲] and [▼] to select the third control panel option from the bottom (Trigger Sense).
7. Use [◀] and [▶] to select the subject movement sensitivity, and then press [SET].
  - You can select any one of three sensitivity levels: “High”, “Normal”, or “Low”.
  - Move Out CS Setting Guide
    - High: For a subject that moves out of the boundary quickly
    - Low : For a subject that moves out of the boundary slowly
  - Move In CS Setting Guide
    - High: For a subject that moves into the boundary quickly or for a small subject (relative to the boundary)
    - Low : For a subject that moves into the boundary slowly or for a large subject (relative to the boundary)



8. Use [▲] and [▼] to select the second control panel option from the bottom (Prerecord (Still image) Speed).

9. Use [◀] and [▶] to select the CS speed setting you want, and then press [SET].

- You select a value in the range of 1 frame per second to 60 frames per second for the CS speed.

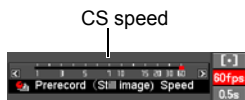

10. Use [▲] and [▼] to select the bottom control panel option (Prerecord (Still image) Time).

11. Use [◀] and [▶] to specify the pre-record time, which is the amount of time before and after subject movement for which you want to record images.

Number of pre-recorded images and recording time

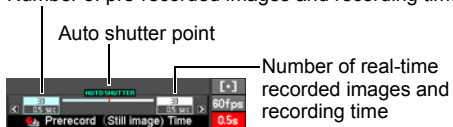

- The approximate number of recordable CS images will appear on the monitor screen.

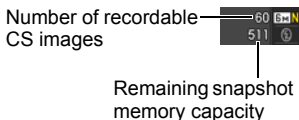

## ■ To shoot using Move Out CS

**1. Compose the image so the subject is within the boundary on the monitor screen.**

---

**2. Half-press the shutter button.**

- The camera will adjust exposure and focus automatically.
- 

**3. When the boundary on the monitor screen turns green, press the shutter button the rest of the way down.**

At this time the camera will go into recording standby and start pre-recording images and storing them in a buffer, in accordance with the Prerecord Time setting you configured in step 10 under “To setup the camera” on page 72. After the buffer becomes full, new images keep being added while older images are continually being deleted.

The camera will start saving images automatically the moment it detects that the subject has moved out of the boundary.

- “● AUTO” flashes on the monitor screen during recording standby and auto recording.
- 

**4. Image recording will continue until the end of the Prerecord Time is reached.**

- While the camera is in Move Out CS recording standby, you can cancel standby by pressing the shutter button all the way down. You then will be able to shoot images normally.
  - To stop an ongoing image recording operation, press [SET] or [●].
- 

**5. Save the CS images (page 58).**



## ■ To shoot using Move In CS

**1. Compose the image at a location where you expect the subject to enter the boundary on the monitor screen.**

**2. Half-press the shutter button.**

- The camera will adjust exposure and focus automatically.
- In this case, use of manual focus (page 43) to preset a fixed focus is recommended.

**3. When the boundary on the monitor screen turns green, press the shutter button the rest of the way down.**

At this time the camera will go into recording standby and start pre-recording images and storing them in a buffer, in accordance with the Prerecord Time setting you configured in step 10 under "To setup the camera" on page 72. After the buffer becomes full, new images keep being added while older images are continually being deleted.

The camera will start saving images to memory automatically the moment it detects the subject has moved into the area within the boundary.

- "● AUTO" flashes on the monitor screen during recording standby and auto recording.

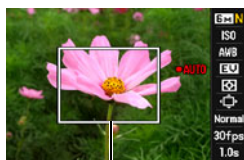

Boundary

**4. Image recording will continue until the end of the Prerecord Time is reached.**

- While the camera is in Move In CS recording standby, you can cancel standby by pressing the shutter button all the way down. You then will be able to shoot images normally.
- To stop an ongoing image recording operation, press [SET] or [●].

**5. Save the CS images (page 58).**

### NOTE

- Compose the image so the entire subject and its background are within the boundary. Recording may not be performed correctly if there is little difference between the subject and the part of the background enclosed by the boundary. Also, Move Out CS may not record correctly if the subject is not in the center of the boundary.
- Move In CS and Move Out CS do not operate correctly if you press the shutter button all the way down. Be sure to half-press the shutter button. After images are pre-recorded, press the shutter button the rest of the way down.
- After pressing the shutter button all the way to put the camera into record standby, keep the camera still. Recording may not be performed correctly if you move the camera during record standby.
- The CS dial setting is ignored when recording with this BEST SHOT scene.

- The sleep mode and Auto Power Off are disabled while the camera is in record standby.
- The camera may not start recording automatically or camera power may turn off when battery power is low. Always make sure that the battery is sufficiently charged or use the AC adaptor before using these features.
- To save all of the continuous shutter images, select “Save All” (page 58) as the continuous shutter image save method. If you do, make sure that the memory card loaded in the camera has enough free space to store them.
- Zoom is disabled, and focus and exposure are fixed while the camera is in recording standby.

## Using Prerecord Movie (Prerecord (Movie))

With this feature, the camera pre-records up to five seconds of whatever is happening in front of the lens in a buffer that is continually updated. Pressing [●] saves the prerecorded action (buffer contents) followed by real-time recording. Real-time recording continues until you stop it.

### ■ To set up the camera to shoot with Prerecord Movie

**1. In the REC mode, set the mode dial to [BS].**

**2. Press [SET] and then select “Prerecord (Movie)”.**

At this point the back lamp will flash. Up to five seconds of buffer contents will be stored, followed by real-time movie recording.

### ■ To shoot a Prerecord Movie

**1. With the camera pointed at the subject, press [●].**

This will save five seconds of action pre-recorded in the buffer and start real-time recording.

- When recording a high-speed movie, half press the shutter button before pressing [●] and pre-focus the subject. However, the movie that is temporarily recorded in the buffer is deleted.

**2. Press [●] again to stop recording.**

- To turn off Prerecord Movie recording, set the mode dial to [■].
- When shooting with the High-speed Movie “30-300fps” setting, you cannot change the speed (fps) setting when recording to the buffer before pressing [●]. You can change the speed (fps) setting after you press [●] to start real-time recording.

# Advanced Settings

The following are menu operations you can use to configure various camera settings.

## Using On-screen Menus

### ■ Example Menu Screen Operation

Press [MENU] to display the menu screen.

- Menu contents are different in the REC mode and PLAY mode.

Example: REC mode menu

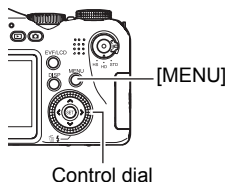

### Menu Screen Operation Buttons

[◀] [▶]	Selects tabs. [▶] is also used to display the options available for a setting.
[▲] [▼]	Selects a setting option.
[SET]	Registers the selected setting.
[MENU]	Exits the menu screen.
Control dial	Can be used in place of [▲], [▼], [◀], and [▶] to select on-screen items.

#### 1. In the REC mode, press [MENU].

This will display the menu screen.

#### 2. Use [◀] and [▶] to select the tab where the item you want to configure is located.

3. Use [▲] and [▼] to select the menu item you want, and then press [▶].

4. Use [▲] and [▼] to change the setting.

5. After the setting is the way you want, press [SET].

- Pressing [◀] registers the selected setting and returns to the menu.
- To configure settings on another tab after pressing [◀] to return to the menu, use [▲] to move the highlighting up to the tabs, and then use [◀] and [▶] to select the tab you want.

Example:  
When "Self-timer" is selected on the "REC" tab



### ■ Menu Operations in This Manual

Menu operations are represented in this manual as shown below. The following operation is the same one described under "Example Menu Screen Operation" on page 77.

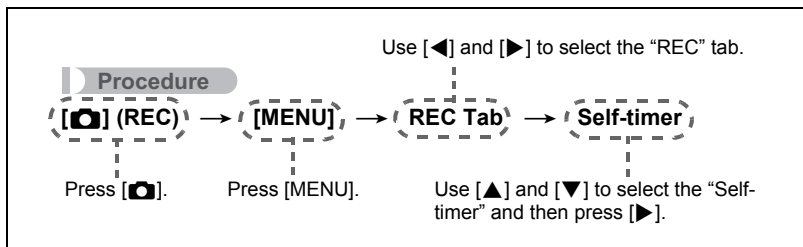

## REC Mode Settings (REC)

### Using the Self-timer (Self-timer)

#### Procedure

[] (REC) → [MENU] → REC Tab → Self-timer

With the Self-timer, pressing the shutter button starts a timer. The shutter is released and the image is shot after a fixed amount of time.

<b>10 sec</b>	10-second Self-timer
<b>2 sec</b>	2-second Self-timer • When shooting under conditions that slow down the shutter speed, you can use this setting to prevent image blur due to camera movement.
<b>X3 (Triple Self-timer)</b>	Shoots three images: one image 10 seconds after the shutter button is pressed, and the next two images as soon as the camera is ready after shooting the previous image. How long it takes for the camera to get ready to shoot depends on the image size and quality settings, whether or not a memory card is loaded in the camera, and the flash charge condition.
<b>Off</b>	Self-timer is disabled.

- The front lamp flashes while the Self-timer countdown is in progress.
- You can interrupt an ongoing Self-timer countdown by pressing [SET].

Front lamp

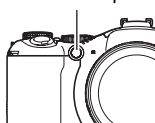

#### NOTE

- The Self-timer cannot be used together with the following features. Snapshot in Movie, Prerecord (Still image), Slow Motion View, Move Out CS, Move In CS
- The Triple Self-timer cannot be used together with the following features. High-speed CS, Flash CS, Bracketing, Movie

## Using the Auto Focus Assist Light (AF Assist Light)

### Procedure

[] (REC) → [MENU] → REC Tab → AF Assist Light

Half-pressing the shutter button while this setting is selected causes the front lamp to light, which provides illumination for focusing in areas where lighting is dim. Leaving this function turned off is recommended when shoot portraits from short distances, etc.

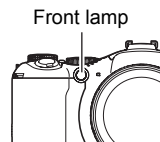

### **IMPORTANT!**

- Never look directly into the front lamp while it is lit.
- Make sure your finger is not covering the front lamp.







## Reducing the Effects of Camera and Subject Movement (Anti Shake)









### Procedure

[] (REC) → [MENU] → REC Tab → Anti Shake

You can turn on the camera's Anti Shake feature to reduce image blur due to subject movement or camera movement when shooting a moving subject using telephoto, when shooting a fast-moving subject, or when shooting under dim lighting conditions.

 <b>Auto</b>	Minimizes the effects of camera and subject movement
 <b>Camera AS</b>	Minimizes the effects of camera movement only
 <b>Image AS</b>	Minimizes the effects of subject movement only
 <b>DEMO</b>	Half-pressing the shutter button demonstrates the effect of "  Camera AS". However, the image is not recorded.
<b>Off</b>	Turns off all Anti Shake settings

### NOTE

- Only " Camera AS" can be used during movie recording.
- The ISO sensitivity setting (page 34) must be "AUTO" for " Image AS" to work.
- If the flash fires, the Anti Shake icon  will remain on the display, even though Anti Shake does not function during flash photography.
- Shooting with Anti Shake can cause an image to appear somewhat coarser than normal and can cause slight deterioration of image resolution.
- Anti Shake may not be able to eliminate the effects of camera or subject movement when movement is severe.
- " Camera AS" may not work properly when the camera is mounted on a tripod. Either turn off Anti Shake or select " Image AS".
- When the image size setting is "RAW+" (page 30), this setting becomes " Camera AS" when the Anti Shake setting is " Auto", and "Off" when the Anti Shake setting is " Image AS".

## Shooting with Face Detection (Face Detection)

### Procedure

[**📷**] (REC) → [MENU] → REC Tab → Face Detection

The face detection feature adjusts focus and brightness to the faces in the image.

**1. Use [◀] and [▶] to select “On” and then press [SET].**

**2. Point the camera at the subject (s).**

The camera will detect human faces and display a frame around each one.



**3. Half-press the shutter button.**

The camera will focus and the frames around the faces it focuses on will turn green.

**4. Press the shutter button the rest of the way down.**

### Tips for Best Face Detection Results

- The camera performs center focus if it cannot detect a face.
- Always make sure that Auto Focus (AF) is selected as the focus mode when shooting with face detection.
- Detection of the following types of faces is not supported.
  - A face that is obstructed by hair, sunglasses, a hat, etc., or a face in dark shade
  - A profile or a face that is at an angle
  - A face that is very far away and small, or very close and large
  - A face in an area that is very dark
  - A face of a pet or some other non-human subject

### **IMPORTANT!**

- Face detection cannot be used in combination with any of the following features.
  - Some BEST SHOT scenes (Digital Panning, Move Out CS, Move In CS, For YouTube, Prerecord (Movie))
  - Movie Mode
  - Prerecord (Still image)
  - Slow Motion View

## Shooting with Continuous Auto Focus (Continuous AF)



---

### Procedure

[] (REC) → [MENU] → REC Tab → Continuous AF

Continuous Auto Focus automatically updates the focus setting while recording is in progress.

Turning on Continuous Auto Focus causes auto focus to update continuously.

- Before you half-press the shutter button, the camera focuses at the center of the screen. If “[] Free” is selected for the “AF Area” setting (page 37) when you half-press the shutter button, focusing is performed for the area specified by “[] Free”. If “Face Detection” is turned on, focusing is performed in the area where a face is detected.

## Specifying the [AE-L/AF-L] button Operation (AE/AF Lock)

---

### Procedure

[] (REC) → [MENU] → REC Tab → AE/AF Lock

See page 45 for details.

## Shooting with AE Bracketing (AE Bracketing)

---

### Procedure

[] (REC) → [MENU] → REC Tab → AE Bracketing

See page 54 for details.

## Shooting with White Balance Bracketing (WB Bracketing)

---

### Procedure

[] (REC) → [MENU] → REC Tab → WB Bracketing

See page 56 for details.

## Shooting with Focus Bracketing (Focus Bracketing)

### Procedure

[] (REC) → [MENU] → REC Tab → Focus Bracketing

See page 57 for details.

## Turning Digital Zoom On or Off (Digital Zoom)

### Procedure

[] (REC) → [MENU] → REC Tab → Digital Zoom

Select "On" when you want to use digital zoom (page 41).

- Digital zoom is disabled while shooting with the following features.
  - Some BEST SHOT scenes (Digital Anti Shake, Digital Panning)

## Shooting with Quick Shutter (Quick Shutter)

### Procedure

[] (REC) → [MENU] → REC Tab → Quick Shutter

When Quick Shutter is turned on, you can press the shutter button all the way without waiting for Auto Focus. This will record the image using a high-speed focus operation that is much faster than Auto Focus.

<b>On</b>	Turns on Quick Shutter <ul style="list-style-type: none"><li>• Some images may be out of focus when Quick Shutter is used.</li></ul>
<b>Off</b>	Turns off Quick Shutter so focus is performed using normal Auto Focus before the image is recorded. <ul style="list-style-type: none"><li>• If you fully press the shutter button while Quick Shutter is turned off, images will continue to be shot without focusing.</li><li>• Whenever possible, take a little extra time to half-press the shutter button in order to ensure proper focus.</li></ul>

### NOTE

- Quick Shutter is disabled when the zoom factor is greater. Recording is performed using Auto Focus at this time.

## Assigning a Function to the Function Ring (Ring Setup)

### Procedure

[] (REC) → [MENU] → REC Tab → Ring Setup

Use this item to specify the function that function ring performs during recording.

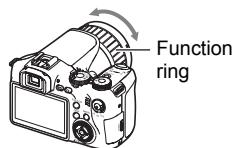

<b>CS fps</b>	Function ring changes the continuous shutter (CS) speed when shooting with continuous shutter (page 46).
<b>Zoom</b>	Function ring changes the zoom factor (page 40).
<b>Focus</b>	Function ring adjusts focus during manual focus (page 43).
<b>Off</b>	No function ring operation

- When “Zoom” is assigned to the function ring, rotating the function ring will not perform a zoom operation when any one of the following conditions exists.
  - High-speed movie recording
  -  selected for the focus setting
  - During “Prerecord (Movie)” recording

## Configuring the Continuous Shutter Image Save Method (Save CS Images)

### Procedure

[] (REC) → [MENU] → REC Tab → Save CS Images

See page 58 for details.

## Turning on Image Review (Review)

### Procedure

[] (REC) → [MENU] → REC Tab → Review

While Review is turned on, the camera will display a image for about one second immediately after you press the shutter button to record it.

- Image review is available only when shooting single images. It does not work with continuous shutter.

## Displaying the On-screen Grid (Grid)

### Procedure

[**📷**] (REC) → [MENU] → REC Tab → Grid

The on-screen grid can be displayed on the REC mode monitor screen for easy vertical and horizontal alignment when composing images.



## Configuring Power On Default Settings (Memory)

### Procedure

[**📷**] (REC) → [MENU] → REC Tab → Memory

When you turn off the camera, it remembers the current settings of all enabled memory items and restores them when you turn it back on. Any memory item that is disabled will be returned to its initial default setting whenever you turn off the camera.

Setting	Disabled (Initial Default Setting)	Enabled
Flash	Auto	Setting at power off
Self-timer	Off	
Flash Intensity	0	
Digital Zoom	Off	
MF Position	Position before manual focus was selected.	
Zoom Position*	Full wide	

\* Optical zoom setting only.

## Image Quality Settings (Quality)

### Specifying Snapshot Image Quality (Quality (Snapshot))

#### Procedure

[CAMERA] (REC) → [MENU] → Quality Tab → Quality (Snapshot)

<b>Fine</b>	Gives image quality priority
<b>Normal</b>	Normal
<b>Economy</b>	Gives the number of images priority

- The "Fine" setting helps to bring out details when shooting a finely detailed image that includes dense tree branches or leaves, or an image of a complex pattern.
- Memory capacity (the number of images you can record) will be affected by the quality settings you configure (page 177).

### Configuring HD Movie Settings (HD Quality)

#### Procedure

[CAMERA] (REC) → [MENU] → Quality Tab → HD Quality

You can configure movie quality settings when recording a HD movie (page 64). Selecting a high image quality setting (FHD) will make it possible to record beautiful Full HD movies, but it also reduces the amount of time you can record per movie.

Image Quality (Pixels)		Frame Rate
FHD	1920×1080	60 fields/s
HD	1280×720	30 fps

## Setting the High-speed Movie Frame Rate (HS Speed)

### Procedure

[] (REC) → [MENU] → Quality Tab → HS Speed

You can configure frame rate settings when recording a high-speed movie (page 64). A fast frame rate (such as 1200 fps) will result in a smaller image size.

Frame Rate	Image Size (Pixels)
300 fps	512×384
600 fps	432×192
1200 fps	336×96
30-300 fps	512×384

- With the “30-300 fps” high-speed movie setting, shooting starts with a frame rate of 30 fps. You can change the frame rate to 300 fps at some point during the movie. To adjust the frame rate, press [SET]. If “CS fps” is specified for the function ring setting, you can adjust the frame rate by rotating the function ring (page 85).

## Reducing Underexposure and Overexposure (Dynamic Range)

### Procedure

[] (REC) → [MENU] → Quality Tab → Dynamic Range

You can adjust the Dynamic Range setting in order to capture the bright areas of an image while reducing the chance of overexposure and underexposure.

<b>Expand +2</b>	Suppresses overexposure and underexposure more than “Expand +1”
<b>Expand +1</b>	Suppresses overexposure and underexposure
<b>Off</b>	No suppression of overexposure and underexposure

- The dynamic range setting is ignored during high-speed movie recording.



## Specifying Flash Intensity (Flash Intensity)

---

### Procedure

[] (REC) → [MENU] → Quality Tab → Flash Intensity

You can specify one of 13 flash intensity settings, from -2.0 EV (weakest) to +2.0 EV (strongest).

- Flash intensity may not change when the subject is too far away or too close.

## Turning On Flash Assist (Flash Assist)

---

### Procedure

[] (REC) → [MENU] → Quality Tab → Flash Assist

The subject in an image will look too dark if flash intensity is not enough to reach a subject that is too far away. When this happens, you can use flash assist to supplement the brightness of the subject so it appears as if flash illumination was sufficient. Select “Auto” to turn on Flash Assist.

Flash Assist may not produce the desired result if you use it after changing the initial default settings of any of the following.

Flash Intensity, EV Shift, ISO, Contrast



Flash assist turned off



Flash assist turned on

## Using Built-in Color Filters (Color Filter)

---

### Procedure

[] (REC) → [MENU] → Quality Tab → Color Filter

Settings: Off, B/W, Sepia, Red, Green, Blue, Yellow, Pink, and Purple

## Controlling Image Sharpness (Sharpness)

---

### Procedure

**[CAMERA] (REC) → [MENU] → Quality Tab → Sharpness**

You can specify one of five sharpness settings from +2 (sharpest) to -2 (least sharp).

## Controlling Color Saturation (Saturation)

---

### Procedure

**[CAMERA] (REC) → [MENU] → Quality Tab → Saturation**

You can specify one of five saturation settings from +2 (most saturated) to -2 (least saturated).

## Adjusting Image Contrast (Contrast)

---

### Procedure

**[CAMERA] (REC) → [MENU] → Quality Tab → Contrast**

You can specify one of five contrast settings from +2 (most contrast between light and dark) to -2 (least contrast between light and dark).

## Using the Remote Shutter Release

You can use the remote shutter release that comes with the camera when recording. By mounting the camera on a tripod and using the remote shutter release, you can eliminate the chance of blurred images due to accidental hand movement. The shutter button of the remote shutter release operates the same way as the camera's shutter button.

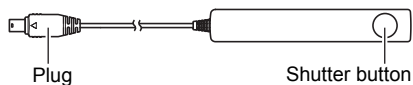

### ■ Connection

1. Turn off the camera.
2. Open the terminal cover and connect the remote shutter release plug to the USB/AV port.

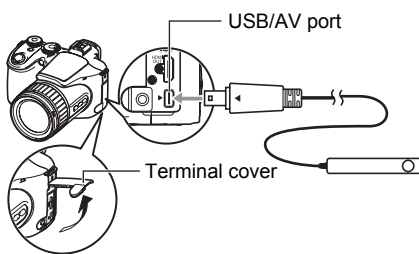

## Using an External Flash

Use of a commercially available flash unit makes it possible to obtain a higher level of brightness than you get when using the built-in flash alone. An external flash also makes it possible to extend the effective range of flash photography.

### **IMPORTANT!**

- Some flash performance may be lost when using a ring flash or other type of unit with a long flash time.
- The aperture value and ISO sensitivity available with some flash units may not match the values supported by your camera. In such a case, make adjustments in the aperture setting of the external flash and the camera until proper brightness is achieved.
- An external flash unit cannot be used with Flash CS (page 48).

### **■ Before Using an External Flash Unit**

Be sure to perform the following steps before using an external flash unit.

**1. In the REC mode, set the CS dial to  (Single Shot).**

**2. Press [] (  ) once.**

**3. Use [] and [] to select  (External Flash) and then press [SET].**

Now if you connect an external flash unit it will fire whenever you shoot a snapshot. The built-in flash will not fire.

### **IMPORTANT!**

- Be sure to select  (External Flash) for the flash mode setting when using an external flash. If you don't, the built-in flash will pop up during shooting, which can lead to malfunction if it comes into contact with the external flash unit.
- Note that the brightness of what you see on the monitor screen will be different from the brightness of the image you record. Make sure you check the settings of your external flash and of the camera before recording.

## ■ Using an External Flash Unit

### ★ IMPORTANT!

- Always make sure that the external flash unit is turned off before attaching it to or detaching it from the camera. Leaving the flash unit on can cause it to fire unexpectedly.

### 1. Remove the shoe cap.

- Keep the shoe cap in a safe place where it will not become lost.
- Replace the shoe cap when you are not using the external flash shoe. The shoe cap protects the shoe contact from dirt and damage.

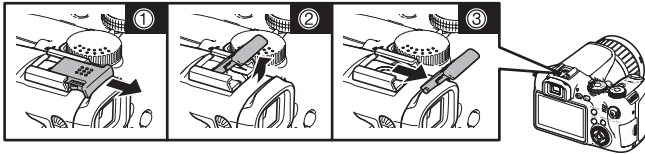

### 2. Attach the external flash unit to the external flash shoe.

### 3. Turn on camera power and make the required camera settings.

REC mode: M (Manual Exposure) mode  
Shutter Speed: Around 1/60 (Select the aperture to match the type of image you are shooting.)

White Balance:  (Daylight)

Flash Mode:  (External Flash) (page 92)

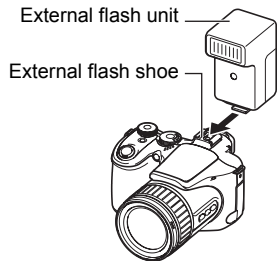

### 4. Turn on the external flash unit, and set it up for the camera's aperture value and sensitivity value.

- Depending on shooting conditions, proper exposure may not be attained even if you properly set the auto aperture value and ISO sensitivity of the flash unit to match those of the camera. If this happens, adjust the auto aperture value, ISO sensitivity, or other settings of the flash unit. Also try adjusting the aperture of the camera and the ISO sensitivity to match the flash setting.

## ■ External Flash Precautions

- After recording an image, check it on the monitor screen. If it is not what you expected, use the controls on the external flash unit to adjust flash intensity, and adjust the aperture and ISO sensitivity settings on the camera. Note that you cannot control external flash unit intensity using camera settings.
- Close up images often tend to be overexposed. If you are having overexposure problems, try adjusting the aperture and ISO sensitivity settings of the external flash unit and the camera. You can also try using the camera's built in flash to correct for overexposure.
- Camera aperture (F) values are based on the widest optical zoom (1X). Using telephoto can cause slight lens darkness. Adjust the aperture and ISO sensitivity settings of the external flash unit and the camera as required when using optical zoom.
- If you do not plan to use the external flash, detach it from the camera and select some setting other than  (External Flash) as the flash mode. The built-in flash will not operate properly while an external flash is attached.

## Installing the Lens Hood or a Lens Filter

Use the procedures in this section to install the lens hood that comes with the camera or a commercially available filter.

### Installing the Lens Hood

Installing the lens hood that comes with the camera shuts out unwanted light when shooting in very strong sunlight or against backlighting, which helps to reduce the chance of ghosting and flaring.

When installing the lens hood, align the guide mark on the hood with the guide mark on the camera lens, and press the hood until you hear it click into place.

To remove the lens hood, press the buttons on the left and right and pull it towards you.

The lens hood can be attached backwards when transporting the camera.

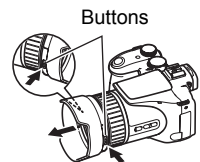
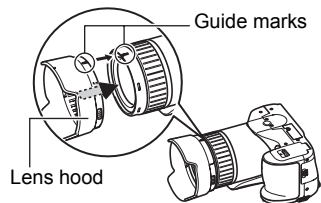

## NOTE

---

- Depending on the angle of the light, the lens hood may not have the desired effect.
- Using the flash with the lens hood attached can cause vignetting (darkening of the corners of the image). Remove the lens hood before using the flash.
- Use of a commercially available lens hood may cause vignetting (darkening of the corners of the image).

## Installing a Filter

---

This camera supports use of commercially available 62mm filters.

## NOTE

---

- Carefully read the user documentation that comes with filters for information about how to use them properly.
- Keep the following points in mind when purchasing a filter.
  - Use of a filter can cause blackening around the edges of images.
  - Use of a filter may interfere with proper operation of Auto Focus and flash.
  - Filters may not deliver the same results as those obtained with a film camera.
- Do not use multiple filters.

# Viewing Snapshots and Movies

## Viewing Snapshots

See page 21 for the procedure for viewing snapshots.

## Viewing a Movie

1. Press [▶] (PLAY) and then use [◀] and [▶] to display the movie you want to view.
2. Press [SET] to start playback.



## Movie Playback Controls

[◀] [▶]	During playback, changes the playback direction and playback speed. While playback is paused, scrolls forward or back.
Control dial	During playback, changes the playback direction and playback speed. While playback is paused, scrolls forward or back.
[SET]	Toggles between pause and play.
[DISP]	Cycles through information display formats.
Zoom controller	Zooms the image. <ul style="list-style-type: none"><li>• You can use [▲], [▼], [◀], and [▶] to scroll the zoomed image on the monitor screen.</li></ul>
[▲] [▼]	Adjusts audio volume during playback. Pressing [▼] while playback is paused starts movie editing (page 108).

- Playback may not be possible for movies not recorded with this camera.



## Viewing Continuous Shutter Images

Each time you perform a continuous shutter (CS) operation, the camera creates a CS group that includes all of the images for that particular CS session. You can use the following procedure to play back the images in a particular CS group.

1. Press **[▶]** (PLAY) and then use **[◀]** and **[▶]** to display the CS group whose images you want to view.
2. Press **[SET]** to start playback the images in the CS group.

This will play back the images in the CS group you selected.

Current image number/number of images in the group

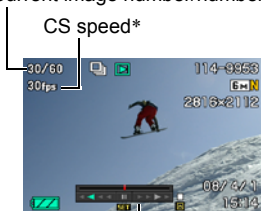

Playback guide

Number of image files in the CS group

CS group icon



First image in the CS group

\* The CS speed does not appear on the monitor screen in the high-speed CS mode while "AUTO-N" or "AUTO-H" is selected as the CS speed, or on images shot in the bracketing mode.

## Playback Controls

<b>[◀] [▶]</b>	During playback, changes the playback direction and playback speed. While playback is paused, scrolls forward or back.
<b>Control dial</b>	During playback, changes the playback direction and playback speed. While playback is paused, scrolls forward or back.
<b>[SET]</b>	Toggles between pause and play.
<b>[DISP]</b>	Cycles through information display formats.
<b>Zoom controller</b>	Zooms the image. <ul style="list-style-type: none"><li>• You can use [▲], [▼], [◀], and [▶] to scroll the zoomed image on the monitor screen.</li></ul>
<b>[▲]</b>	Exits CS group playback.
<b>[▼]</b>	Displays the delete menu.

## Deleting Continuous Shutter Images

---

You can use the following procedures to delete images while playback is in progress or paused.

### ■ Deleting a Specific CS Group File

1. While CS image playback is in progress or paused, press [▼].
2. Use [◀] and [▶] to display the image you want to delete.
3. Use [▲] and [▼] to select “Delete” and then press [SET].
  - To delete other files, repeat steps 2 and 3.
  - To exit the delete operation, press [MENU].

### ■ Deleting All Files in a CS Group

1. While CS image playback is in progress or paused, press [▼].
2. Use [▲] and [▼] to select “Del Group Images” and then press [SET].
3. Use [▲] and [▼] to select “Yes”, and then press [SET].

## Dividing Up a CS Group

---

Use the following to divide up a CS Group into individual images.

### ■ Dividing Up a Specific CS Group

1. While a CS group folder is displayed, press [MENU].
2. Use [◀] and [▶] to select “PLAY”.
3. Use [▲] and [▼] to select “Divide Group” and then press [▶].
4. Use [◀] and [▶] to display the CS group folder whose CS group you want to divide up.
5. Use [▲] and [▼] to select “Divide” and then press [SET].
  - To divide up other CS group files, repeat steps 4 and 5.

## ■ Dividing Up All CS Groups

1. While a CS group folder is displayed, press [MENU].

---

2. Use [◀] and [▶] to select “PLAY”.

---

3. Use [▲] and [▼] to select “Divide Group” and then press [▶].

---

4. Use [▲] and [▼] to select “Divide All Groups” and then press [SET].

---

5. Use [▲] and [▼] to select “Yes”, and then press [SET].
  - Once a CS group is divided, it cannot be regrouped.

## ■ Copying a CS Group Image

Use the following procedure to copy an image in a CS group to a location outside of the group.

1. While a CS group folder is displayed, press [SET].

---

2. While an image inside the CS group is displayed, press [MENU].

---

3. Use [◀] and [▶] to select “PLAY”.

---

4. Use [▲] and [▼] to select “Select Frame”, and then press [▶].

---

5. Use [◀] and [▶] to display the image you want to copy.

---

6. Use [▲] and [▼] to select “Copy”, and then press [SET].

### NOTE

- The functions below cannot be performed on snapshots inside a CS group folder. Before using either of these functions, perform the above procedure (Select Frame) to copy the image first.  
Cropping, Rotation, Resize

## Zooming an On-screen Image

1. In the PLAY mode, use [◀] and [▶] to scroll through the images until the one you want is displayed.

2. Slide the zoom controller towards [🔍] (🔍) to zoom.

You can use [▲], [▼], [◀], and [▶] to scroll the zoomed image on the monitor screen. Slide the zoom controller towards [🔍] to unzoom the image.

- If display indicators are turned on, an indicator in the lower right corner of the monitor screen shows what part of the zoomed image is currently displayed.
- To exit the zoom screen, press [MENU].
- Though the maximum image zoom factor is 8X, certain image sizes may not allow zooming up to the full 8X.

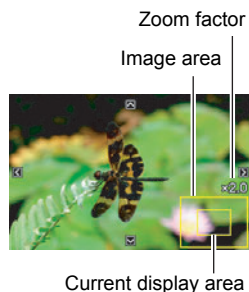

## Displaying 12 Images on the Same Screen

1. In the PLAY Mode, slide the zoom controller towards [🔍] (🔍).

Use [◀] and [▶] to scroll, 12 images at a time.

To view a particular image, use [▲], [▼], [◀], or [▶] to move the selection boundary to the image you want and then press [SET].

- In the case of a movie or a continuous shutter (CS) file, the first frame of the file will be displayed.

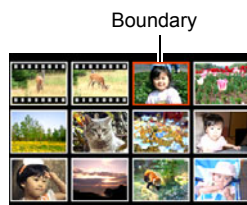

## Viewing Snapshots and Movies on a TV Screen

### 1. Use the AV cable that comes with the camera to connect it to the TV.

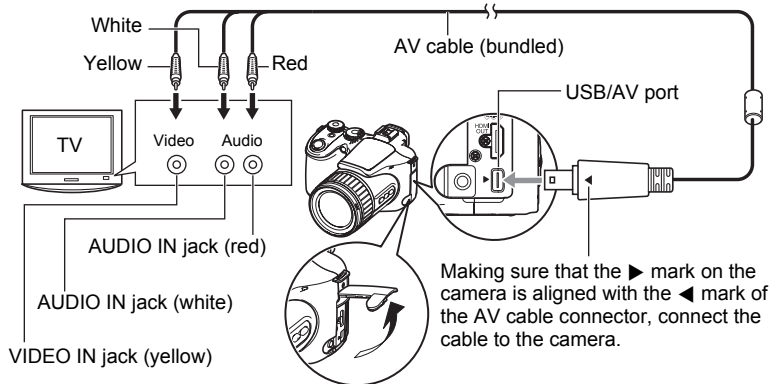

- Make sure that you insert the cable connector into the USB/AV port until you feel it click securely into place. Failure to insert the connector fully can result in poor communication or malfunction.
- Note that even while the connector is fully inserted, you still will be able to see the metal part of the connector as shown in the illustration.
- Before connecting to a TV to display images, be sure to configure the camera's [RECORD] (REC) and [PLAY] (PLAY) buttons for "Power On" or "Power On/Off" (page 143).
- Make sure that the camera is turned off before plugging in or unplugging the cable. Check the user documentation that comes with the TV for information about requirements before plugging into or unplugging from the TV.

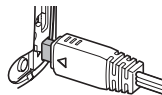

### 2. Turn on the TV and select its video input mode.

If the TV has more than one video input, select the one where the camera is connected.

### 3. Press [PLAY] (PLAY) to turn on the camera.

This will cause an image to appear on the TV screen, without anything appearing on the camera's monitor screen.

- Pressing [ON/OFF] or [RECORD] (REC) will not turn on the camera while the AV cable is connected.
- You also can change the aspect ratio of the screen and the video output system (page 144).

### 4. Now you can display images and play back movies as you normally do.

## Recording Camera Images to a DVD Recorder or Video Deck

Use one of the following methods to connect the camera to the recording device using the camera's bundled AV cable.

- DVD recorder or video deck: Connect to the VIDEO IN and AUDIO IN terminals.
- Camera: USB/AV port

You can play a slideshow of snapshots and movies on the camera and record it on a DVD or video tape. You can record movies by selecting "☐ Only" for the slideshow "Images" setting (page 106). When recording images to an external device, use [DISP] to clear all indicators from the monitor screen (page 146).

For information about connecting a monitor to the recording device and about how to record, see the user documentation that comes with the recording device you are using.

## Viewing High-quality Movies on a Hi-Vision Television

Use a commercially available HDMI cable to connect the camera to the TV. For information about playback, see page 102.

- Use a commercially available HDMI cable that is marked with the logo shown to the right.

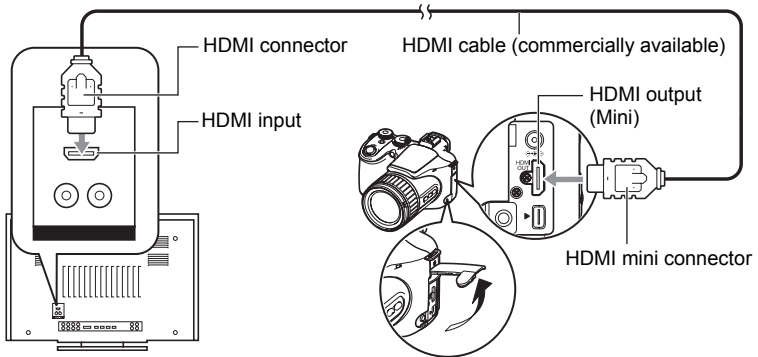

### NOTE

- Use a HDMI cable that with a plug that is compatible with the camera's HDMI mini connector on one end, and a plug that is compatible with your TV's HDMI connector on the other end.
- Proper image and/or audio output and other operations may not be possible with some devices.
- Connecting the camera to the HDMI connector of another device can damage both the camera and the other device. Never connect two HDMI output connectors to each other.
- Make sure that the camera is turned off before plugging in or unplugging the cable. Check the user documentation that comes with the TV for information about requirements before plugging into or unplugging from the TV.
- When cables are connected to both the USB/AV port and the HDMI output connector, the HDMI output connector connection is given priority.
- Movie recording is not possible during HDMI output.
- Nothing appears on the camera's monitor screen while it is outputting to a TV.
- Disconnect the HDMI cable when you are not using HDMI output. The camera's monitor screen may not operate normally while the HDMI cable is connected.



## ■ Selecting the HDMI Terminal Output Method (HDMI Output)

### Procedure

#### [MENU] → Set Up Tab → HDMI Output

Use this setting to select the digital signal format when connecting to a TV with an HDMI cable.

<b>Auto</b>	This setting will cause the format to change automatically in accordance with the connected TV. Normally, you should use this mode.
<b>1080i</b>	1080i format output*
<b>480p</b>	480p format output
<b>576p</b>	576p format output

\* 1080i corresponds to 1080 60i, but not 1080 50i. Because of this, the required output method may be 576p when outputting to a digital TV in a PAL reception area that does not support 1080i 60i. If you are in a PAL reception area and nothing is displayed automatically, change the setting to 576p.

- If an image does not appear when "Auto" is selected as the output method, try changing this setting to something else.

### NOTE

- Audio is stereo.
- Some TVs may not be able to output images and/or audio correctly.
- Audio is initially output by the camera at maximum volume. When you first start displaying images, set the TV volume control at a relatively low level and then adjust it as required.
- All icons and indicators that appear on the monitor screen also appear on the TV screen. You can use [DISP] to change the display contents.

# Other Playback Functions (PLAY)





This section explains menu items that you can use to configure settings and perform other playback operations.

For information about menu operations, see page 77.

## Playing a Slideshow on the Camera (Slideshow)

### Procedure

[▶] (PLAY) → [MENU] → PLAY Tab → Slideshow

<b>Start</b>	Starts the slideshow
<b>Images</b>	Specifies the type of images to be included in the slideshow All images: Snapshots, movies, continuous shutter images All images except  : All non-continuous shutter (CS) images  Only: Snapshots only  Only: Movies only One Image: One single selected image (selected using [◀] and [▶])
<b>Time</b>	Time from the start to the end of the slideshow 1 to 5 minutes, 10 minutes, 15 minutes, 30 minutes, 60 minutes
<b>Interval</b>	Amount of time each image remains displayed Use [◀] and [▶] to select a value from 1 to 30 seconds, or "MAX". If you specify a value from 1 to 30 seconds, movies play from beginning to end. When the slideshow reaches a movie file while "MAX" is selected, only the first frame of the movie will be displayed.
<b>Effect</b>	Select the effect you want. Pattern 1 to 5: Plays background music and applies an image change effect. <ul style="list-style-type: none"><li>• Patterns 1 through 4 have different background music, but they all use the same image change effect.</li><li>• Pattern 5 can be used for playback of snapshots only (except for those that are part of a CS group), and the "Interval" setting is ignored.</li><li>• Movies that include audio are played back without BGM. Movies that do not include audio are played back with BGM.</li><li>• The currently selected image change effect setting is disabled automatically in following cases.<ul style="list-style-type: none"><li>– When playing a slideshow for which " Only" or "One Image" is selected for the "Images" setting</li><li>– When the interval setting is 1 second or 2 seconds.</li><li>– Before and after playback of a movie</li><li>– During CS group playback</li></ul></li></ul> Off: No image change effect or background music

- To stop the slideshow, press [SET] or [MENU]. Pressing [MENU] stops the slideshow and returns to the menu screen.
- Adjust audio volume by pressing [▲] or [▼] during playback.
- All button operations are disabled while the slideshow is transitioning from one image to another.
- The time required for transition from one image to another may be longer in the case of an image that was not recorded with this camera.

## Creating a Snapshot of Movie Frames (MOTION PRINT)

### Procedure

[▶] (PLAY) → Movie Screen → [MENU] → PLAY Tab → MOTION PRINT

1. Use [▲] and [▼] to select either “9 frames” or “1 frame”.

When “9 frames” is selected, the frame you select in step 2 will be in the center of the MOTION PRINT image.



9 frames



1 frame

2. Use [◀] and [▶] to scroll through the movie frames and display the one you want to use as the image of the MOTION PRINT image.

Holding down [◀] or [▶] scrolls at high speed.

3. Press [SET].



- Only the frames of movies recorded on this camera can be used in a MOTION PRINT image.



## Editing a Movie on the Camera (Movie Editing)

### Procedure

[] (PLAY) → Movie Screen of Movie to be Edited → [MENU] → PLAY Tab → Movie Editing



The Movie Editing feature lets you use one of the following procedures to edit out a specific part of a movie.

 <b>Cut (To-Point Cut)</b>	Cuts everything from the beginning of the movie up to the current location.
 <b>Cut (Point-To-Point Cut)</b>	Cuts everything between two points.
 <b>Cut (From-Point Cut)</b>	Cuts everything from the current location to the end of the movie.

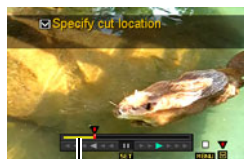

1. Use [] and [] to select the editing method you want to use and then press [SET].
2. Use the following operations to select the frame (point) from which or to which you want to cut the movie (the cut point).



Cut range (yellow)

[  ] [  ]	During playback, changes the playback direction and playback speed. While playback is paused, scrolls forward or back.
Control dial	During playback, changes the playback direction and playback speed. While playback is paused, scrolls forward or back.
[SET]	Toggles between pause and play.

### 3. When the frame where you want the cut point to be is displayed, press [▼].

 <b>Cut (To-Point Cut)</b>	While the frame you want the cut to be up to is displayed, press [▼].
 <b>Cut (Point-To-Point Cut)</b>	<ol style="list-style-type: none"><li>① While the frame you want the first (From) cut to be is displayed, press [▼].</li><li>② Select another frame.</li><li>③ While the frame you want the second (To) cut to be is displayed, press [▼].</li></ol>
 <b>Cut (From-Point Cut)</b>	While the frame you want the cut to be from is displayed, press [▼].

### 4. Use [▲] and [▼] to select “Yes” and then press [SET].

The selected cut operation will take considerable time to complete. Don't try to perform any camera operation until the “Busy... Please wait...” message disappears from the monitor screen. Note that a cut operation can take a long time if the movie being edited is long.

#### NOTE







- When you edit a movie, only the result is saved. The original movie is not retained. An editing operation cannot be undone.
- A movie that is shorter than five seconds cannot be edited.
- Editing of movies recorded with a different type of camera is not supported.
- You will not be able to edit a movie if the amount of remaining memory capacity is less than the size of the movie file you want to edit. If there is not enough memory available, delete files you no longer need to free up more.
- Splitting of a movie into two movies and splicing of two different movies into a single movie are not supported.
- You also can start a movie editing operation while the movie you want to edit is playing back. Press [SET] to pause playback, and then press [▼] to display the menu of editing options. Perform editing using the same procedures as described above.

## Adjusting White Balance (White Balance)

### Procedure

[] (PLAY) → Snapshot Screen → [MENU] → PLAY Tab → White Balance

You can use the white balance setting to select a light source type for a recorded image, which will affect the colors of the image.

 Daylight	Outdoors, fair weather
 Overcast	Outdoors, cloudy to rain, in tree shade, etc.
 Shade	Very high temperature light, such as building shade, etc.
 Day White Fluorescent	White or day white fluorescent lighting, without suppressing color cast
 Daylight Fluorescent	Daylight fluorescent lighting, while suppressing color cast
 Tungsten	Suppressing of the appearance of light bulb lighting
Cancel	No white balance adjustment

### NOTE

- You also can adjust the white balance when recording images (page 34).
- Altering the white balance of an image causes the original image and the altered version to be stored as separate files.
- When you display an altered image on the camera's monitor screen, the date and time indicates when the image was originally recorded, not when the image was altered.
- The corrected version of an image cannot be output to a TV (page 102).

## Adjusting the Brightness of an Existing Snapshot (Brightness)

### Procedure

**[▶] (PLAY) → Snapshot Screen → [MENU] → PLAY Tab → Brightness**

You can select one of five brightness levels, from +2 (brightest) to -2 (least bright).

### NOTE

- Altering the brightness of an image causes the original image and the altered version to be stored as separate files.
- When you display an altered image on the camera's monitor screen, the date and time indicates when the image was originally recorded, not when the image was altered.
- The corrected version of an image cannot be output to a TV (page 102).

## Selecting Images for Printing (DPOF Printing)

### Procedure



**[▶] (PLAY) → Snapshot Screen → [MENU] → PLAY Tab → DPOF Printing**

See page 119 for details.

## Protecting a File Against Deletion (Protect)

### Procedure

[▶] (PLAY) → [MENU] → PLAY Tab → Protect

<b>On</b>	<p>Protects specific files.</p> <ol style="list-style-type: none"><li>① Use [◀] and [▶] to scroll through the files until the one you want to protect is displayed.</li><li>② Use [▲] and [▼] to select "On" and then press [SET]. An image that is protected is indicated by the  icon.</li><li>③ To protect other files, repeat steps 1 and 2. To exit the protect operation, press [MENU]. To unprotect a file, select "Off" instead of "On" in step 2 above.</li></ol>	
<b>All Files: On</b>	<p>Protects all files.</p> <ol style="list-style-type: none"><li>① Use [▲] and [▼] to select "All Files: On" and then press [SET].</li><li>② Press [MENU]. To unprotect all files, select "All Files: Off" instead of "All Files: On" in step 1 above.</li></ol>	

- Note that even if a file is protected, it will be deleted if you perform the format operation (page 145).
- Performing the above procedure while a CS group folder is displayed will protect all the images in the CS group folder. You can protect individual images in a CS group by performing the above procedure while the image is displayed.



## Rotating an Image (Rotation)

### Procedure

[▶] (PLAY) → Snapshot Screen → [MENU] → PLAY Tab → Rotation

1. Use [▲] and [▼] to select “Rotation” and then press [SET].  
Each press of [SET] will rotate the displayed image 90 degrees left.
2. When the displayed image is at the orientation you want, press [MENU].

### NOTE

- Rotation of movie images is not supported.
- Note that this procedure does not actually change the image data. It simply alters how the image is displayed on the camera's monitor screen.
- An image that has been protected or zoomed cannot be rotated.
- The original (unrotated) version of the image will be displayed on the 12-image screen.

## Resizing a Snapshot (Resize)

### Procedure

[▶] (PLAY) → Snapshot Screen → [MENU] → PLAY Tab → Resize

You can reduce the size of a snapshot and save the result as a separate snapshot. The original snapshot is also retained. You can resize an image to one of three image sizes: 3M, 2M, VGA.

- Resizing a 16:9 or 3:2 size snapshot will create an image with an aspect ratio of 4:3, with both sides cut off.
- The recording date of the resized version of the snapshot will be the same as the recording date of the original snapshot.

## Cropping a Snapshot (Trimming)

### Procedure

[**▶**] (PLAY) → Snapshot Screen → [MENU] → PLAY Tab → Trimming

You can crop a snapshot to trim parts you do not need, and save the result in a separate file. The original snapshot is also retained.

Use the zoom controller to zoom the image to the size you want, use [**▲**], [**▼**], [**◀**], and [**▶**] to display the portion of the image you want to cut out, and then press [SET].

- The image produced by cropping a 3:2 or 16:9 image will have an aspect ratio of 4:3.
- The recording date of the cropped image will be the same as the recording date of the original snapshot.



## Copying Files (Copy)

### Procedure

[**▶**] (PLAY) → Snapshot Screen → [MENU] → PLAY Tab → Copy

Files can be copied from the camera's built-in memory to a memory card or from a memory card to built-in memory.

<b>Built-in → Card</b>	Copies all files from built-in camera memory to a memory card. This option copies all the files in built-in camera memory. It cannot be used to copy a single file.
<b>Card → Built-in</b>	Copies a single file on the memory card to camera built-in camera memory. Files are copied to the folder in built-in memory whose name has the largest serial number. <ul style="list-style-type: none"><li>• You cannot copy a continuous shutter (CS) group image (page 100).</li></ul> <ol style="list-style-type: none"><li>① Use [<b>◀</b>] and [<b>▶</b>] to select the file you want to copy.</li><li>② Use [<b>▲</b>] and [<b>▼</b>] to select "Copy" and then press [SET].</li></ol>

### NOTE

- You can copy snapshots or movies you recorded with this camera.

## Dividing Up a Continuous Shutter Group (Divide Group)

### Procedure

[**▶**] (PLAY) → [MENU] → PLAY Tab → Divide Group



See page 99 for details.

## Selecting the PLAY Mode Screen Layout (Display Layout)

### Procedure

[**▶**] (PLAY) → [MENU] → PLAY Tab → Display Layout

Use this procedure to select how display images are shown on the monitor screen.

PLAY Mode		
Normal	100% of the display image is always visible. With some aspect ratios, black bands may appear above and below, or to the left and right of the image.	
Wide	With this setting, the display image is the maximum possible size that allows the entire image to be displayed horizontally. With some aspect ratios, the top and bottom of the image will be cut off.	

## Copying a Continuous Shutter Group (Select Frame)

### Procedure

[**▶**] (PLAY) → [MENU] → PLAY Tab → Select Frame

See page 100 for details.

# Printing

## Printing Snapshots

### Professional Print Service

You can take a memory card that contains the images you want to print to a professional print service and have them printed.



### Printing on a Home Printer

#### Printing Images on a Printer with Memory Card Slot

You can use a printer equipped with a memory card slot to print images directly from a memory card. For details, see the user documentation that comes with your printer.



#### Connecting Directly to a PictBridge Compatible Printer

You can print on a printer that supports PictBridge (page 117).



### Printing with a Computer

After transferring the images to your computer, use commercially available software to print.

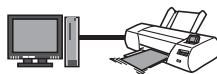

- You can specify which images you want to print, the number of copies, and date stamp settings before printing (page 119).

## Connecting Directly to a PictBridge Compatible Printer

You can connect the camera directly to a printer that supports PictBridge and print images without going through a computer.

### ■ To set up the camera before connecting to a printer

1. Turn on the camera and press [MENU].

2. On the “Set Up” tab, select “USB” and then press [▶].

3. Use [▲] and [▼] to select “PTP (PictBridge)”, and then press [SET].

### ■ Connecting the Camera to a Printer

Use the USB cable that comes bundled with the camera to connect the camera to your printer's USB port.

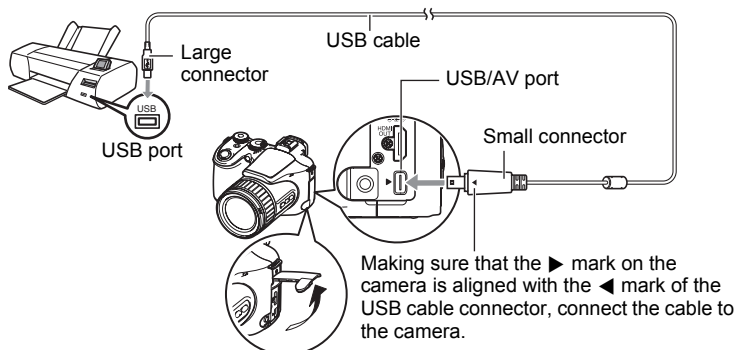

- The camera does not draw power over the USB cable. Make sure the camera's battery is sufficiently charged before connecting.
- Make sure that you insert the cable connector into the USB/AV port until you feel it click securely into place. Failure to insert the connector fully can result in poor communication or malfunction.
- Note that even while the connector is fully inserted, you still will be able to see the metal part of the connector as shown in the illustration.
- When connecting the USB cable to a USB port, make sure you align the connector correctly with the port.
- Make sure that the camera is turned off before plugging in or unplugging the cable. Check the user documentation that comes with the printer for information about requirements before plugging into or unplugging from the printer.

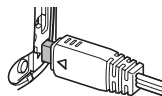

## ■ To print

### 1. Turn on the printer and load paper.

---

### 2. Turn on the camera.

This will display the print menu screen.

---

### 3. Use [▲] and [▼] to select “Paper Size”, and then press [▶].

---

### 4. Use [▲] and [▼] to select a paper size and then press [SET].

- The following are the available paper sizes.  
3.5"×5", 5"×7", 4"×6", A4, 8.5"×11", By Printer
  - Selecting “By Printer” prints using a paper size selected on the printer.
  - See the documentation that comes with your printer for information about paper settings.
- 

### 5. Use [▲] and [▼] to specify the print option you want.

1 Image : Prints one image. Select and then press [SET]. Next, use [◀] and [▶] to select the image you want to print.

DPOF Printing: Prints multiple images. Select and then press [SET]. With this option, images will be printed in accordance with DPOF settings (page 119).

- To toggle date stamping on and off, press [DISP]. The date stamp will be printed when “On” is indicated on the monitor screen.
- 

### 6. Use [▲] and [▼] to select “Print” and then press [SET].

Printing will start and the message “Busy... Please wait...” will appear on the monitor screen. The message will disappear after a short while, even though printing is still being performed. Pressing any camera button will cause the printing status to re-appear. The print menu screen will re-appear when printing is complete.

- If you selected “1 Image”, you can repeat the procedure from step 5, if you want.
- 

### 7. After printing is complete, turn off the camera and disconnect the USB cable from the printer and camera.

## Using DPOF to Specify Images to be Printed and the Number of Copies



### ■ Digital Print Order Format (DPOF)

DPOF is a standard that allows you to include image type, number of copy, and time stamp on/off information on the memory card with the images. After configuring settings, you can use the memory card to print on a home printer that supports DPOF or take the memory card to a professional print service.

- Whether or not you will be able to use DPOF settings for printing depends on the printer you are using.
- Some professional print services may not support DPOF.

### ■ Configuring DPOF Settings Individually for Each Image

#### Procedure

[] (PLAY) → Snapshot Screen → [MENU] → PLAY Tab → DPOF Printing → Select images

1. Use [] and [] to scroll through the files until the image you want to print is displayed.

---

2. Use [] and [] to specify the number of copies.  
You can specify a value up to 99. Specify 00 if you do not want to print the image.
  - If you want to include the date in the images, press [DISP] so “On” is shown for date stamping.
  - Repeat steps 1 and 2 to configure settings for other images, if you want.

---

3. Press [SET].

### ■ Configuring the Same DPOF Settings for All the Images

#### Procedure

[] (PLAY) → Snapshot Screen → [MENU] → PLAY Tab → DPOF Printing → All images

1. Use [] and [] to specify the number of copies.  
You can specify a value up to 99. Specify 00 if you do not want to print the image.
  - If you want to include the date in the images, press [DISP] so “On” is shown for date stamping.

---

2. Press [SET].

## **DPOF settings are not cleared automatically after printing is complete.**

The next DPOF print operation you execute will be performed using the last DPOF settings you configured for the images. To clear DPOF settings, specify "00" for the number of copies of all images.

## **Tell your print service about your DPOF settings!**

If you take a memory card to a professional print service, be sure to tell them that it includes DPOF settings for the images to be printed and the number of copies. If you don't, the print service may print all the images without regard to your DPOF settings, or they may ignore your date stamp setting.

## **■ Date Stamping**

You can use one of the following three methods to include the recording date in the printout of an image.

<b>Configuring camera settings</b>	Configure DPOF settings (page 119). You can turn date stamping on and off each time you print. You can configure settings so some images include the date stamp and some don't.
	Configure the Camera's Timestamp setting (page 140). <ul style="list-style-type: none"><li>• The camera's Timestamp setting imprints the date into a snapshot when you shoot it, so the date is always included when you print. It cannot be deleted.</li><li>• Do not turn on DPOF date stamping for an image that includes a date stamped with the camera's Timestamp function. Doing so can cause the two stamps to be overprinted.</li></ul>
<b>Configuring computer settings</b>	You can use commercially available image management software to date stamp images.
<b>Professional print service</b>	Request date stamping when ordering prints from a professional print service.



## ■ Standards Supported by the Camera

- PictBridge

This is a standard of the Camera and Imaging Products Association (CIPA).



- PRINT Image Matching III

Using image editing software and printing on a printer that supports PRINT Image Matching III makes it possible to use information about shooting conditions that is recorded with the image, and produce exactly the type of image you want. PRINT Image Matching and PRINT Image Matching III are trademarks of Seiko Epson Corporation.



- Exif Print



Printing on a printer that supports Exif Print (Exif 2.2) uses information about shooting conditions recorded with the image to enhance printed image quality. Contact your printer manufacturer for information about models that support Exif Print, printer upgrades, etc.



# Using the Camera with a Computer

## Things you can do using a computer...

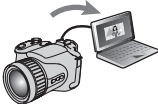
You can perform the operations described below while the camera is connected to a computer.

<b>Save images to a computer and view them there</b> 	<ul style="list-style-type: none"><li>• Save images and view them manually (USB connection) (pages 124, 130).</li></ul>
<b>Playback movies</b> 	<ul style="list-style-type: none"><li>• Play back movies using ArcSoft TotalMedia Theatre for CASIO* (page 126).</li></ul>
<b>Save movies to a DVD disc</b> 	You can save full HD movies you recorded with the camera directly to a DVD disc, in full HD format. The DVD disc can be played back on a device capable of AVCHD playback. See "To install ArcSoft TotalMedia Extreme for CASIO" on page 126.*

\* Windows only

The procedures you need to perform when using the camera with your computer and when using the bundled software are different for Windows and the Macintosh.

- Windows users should refer to "Using the Camera with a Windows Computer" on page 123.
- Macintosh users should refer to "Using the Camera with a Macintosh" on page 130.

## Using the Camera with a Windows Computer

Install the required software in accordance with the version of Windows you are running and what you want to do.

When you want to do this:	Operating System Version	Install this software:	See page:
Save images to a computer and view them there manually	Vista / XP / 2000	Installation not required.	124
Play movies	Vista / XP (SP2)	<b>ArcSoft TotalMedia Theatre for CASIO</b>	126
Store movies to a disc	Vista / XP (SP2)	<b>ArcSoft TotalMedia Studio for CASIO</b>	126
Upload movie files to YouTube	Vista / XP (SP2) / 2000 (SP4)	<b>YouTube Uploader for CASIO</b>	127
View the User's Guide	Vista / XP (SP2) / 2000 (SP4)	<b>Adobe Reader 8</b> (Not required if already installed.)	129
	2000 / Me / 98SE / 98	– • If your computer does not already have Adobe Reader or Adobe Acrobat Reader installed, go to the Adobe Systems Incorporated website to download and the version of Adobe Reader or Adobe Acrobat Reader that is compatible with your computer's operating system.	–

### ■ Computer System Requirements for Bundled Software

Computer system requirements are different for each of the applications. See the "Read me" file that comes with each application for details. Information about computer system requirements also can be found under "Computer System Requirements for Bundled Software" on page 162 of this manual.

## ■ Precautions for Windows Vista Users

- The bundled software will not run under 64-bit versions of Windows Vista.
- The bundled software requires Administrator privileges to run.
- Operation on a self-made computer or under a dual-processor environment is not supported.
- Operation may not be possible under certain computer environments.

## Viewing and Storing Images on a Computer

You can connect the camera to your computer in order to view and store images (snapshot and movie files).

### ■ To connect the camera to your computer and save files

1. Turn on the camera and press [MENU].
2. On the “Set Up” tab, select “USB” and then press [▶].
3. Use [▲] and [▼] to select “Mass Storage”, and then press [SET].
4. Turn off the camera and then use the USB cable that comes with the camera to connect it to your computer.

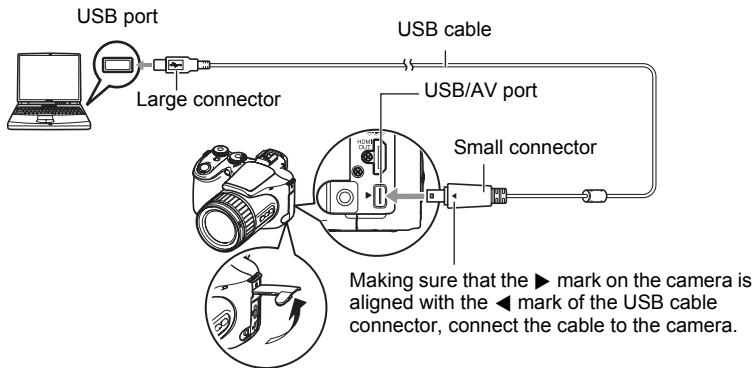

- The camera does not draw power over the USB cable. Make sure the camera's battery is sufficiently charged before connecting.
- Make sure that you insert the cable connector into the USB/AV port until you feel it click securely into place. Failure to insert the connector fully can result in poor communication or malfunction.
- Note that even while the connector is fully inserted, you still will be able to see the metal part of the connector as shown in the illustration.
- When connecting the USB cable to a USB port, make sure you align the connector correctly with the port.

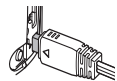

---

## 5. Turn on the camera.

---

## 6. Copy images to your computer.

### Windows XP

- ① Select "Open folder to view files" and then click "OK".
- ② Drag the "DCIM" folder to your Windows desktop to copy it.

### Windows Vista

- ① Select "Open folder to view files".
- ② Drag the "DCIM" folder to your Windows desktop to copy it.

### Windows 2000

- ① Double-click "My Computer".
  - ② Double-click "Removable Disk".
  - ③ Drag the "DCIM" folder to your Windows desktop to copy it.
- 

## 7. After you finish copying images, disconnect the camera from the computer.

### Windows Vista, Windows XP

On the camera, press [ON/OFF] to turn off the camera. After making sure that the back lamp is unlit, disconnect the camera from the computer.

### Windows 2000

Click card services in the task tray on your computer screen, and disable the drive number assigned to the camera. Next, on the camera, press [ON/OFF] to turn off the camera. After making sure that the back lamp is unlit, disconnect the camera from the computer.

## ■ To view images you copied to your computer

### 1. Double-click the copied "DCIM" folder to open it.

---

### 2. Double-click the folder that contains the images you want to view.

---

### 3. Double-click the image file you want to view.

- For information about file names, see "Memory Folder Structure" on page 135.
- An image that was rotated on the camera will be displayed on your computer screen in its original (unrotated) orientation.



## **IMPORTANT!**

- Never use your computer to modify, delete, move, or rename any image files that are in the camera's built-in memory or on its memory card. Doing so can cause problems with the camera's image management data, which will make it impossible to play back images on the camera and can drastically alter remaining memory capacity. Whenever you want to modify, delete, move, or rename an image, do so only on images that are stored on your computer.
- Never unplug the USB cable, or operate the camera while viewing or storing images. Doing so can cause data to become corrupted.

---

## **Playing Back and Saving Movies to Disc**

To playback movies or save movies to a disc on your computer, you will need to install ArcSoft TotalMedia Extreme for CASIO.

To play back a movie on your computer, first install ArcSoft TotalMedia Theatre for CASIO and then copy the movie to your computer.

### **■ To install ArcSoft TotalMedia Extreme for CASIO**

- 1. On the CD-ROM menu screen, select “ArcSoft TotalMedia Extreme for CASIO”.**

---

- 2. After reading the information about installation conditions and system requirements for installation in the “Read me” file, install ArcSoft TotalMedia for CASIO.**

The following software will be installed.

ArcSoft TotalMedia Extreme for CASIO : Launcher software

ArcSoft TotalMedia Theatre for CASIO : Movie playback software

ArcSoft TotalMedia Studio for CASIO : Software for saving movies to disc

## ■ Minimum Computer System Requirements for Movie Playback

Operating System	: Windows Vista, XP (SP2)
CPU	: Intel Pentium EE 3.2 GHz, Intel Core Duo, AMD Athlon 64 FX series, AMD Athlon 64 X2 series
Hard Disk Drive Space	: Equivalent 120MB free hard disk drive space
Memory	: 512MB RAM (1GB recommended)
Graphics card	: NVIDIA Geforce: 7 series or above or ATI: X1000 series or above
Graphics card memory	: 256MB or above

- The above are recommended system environments. Configuring one of these environments does not guarantee proper operation.
- Certain settings and other installed software may interfere with proper playback of movies.
- Even if a computer system that conforms to the minimum requirements described above, there may be cases when frames will be dropped and playback will not be possible.

## ■ Recommended Computer System Requirements for Writing Movie Files to Disc

Operating System	: Windows Vista, XP (SP2)
CPU	: Pentium III 800 MHz or higher (PIV 1.6 GHz or higher recommended)
Hard Disk Drive Space	: 1GB free hard disk drive space (4GB or higher recommended)
Memory	: 512MB RAM (1GB recommended)

## ■ Uploading Movie Files to YouTube

---

Installing YouTube Uploader for CASIO from the CD-ROM that comes with your camera simplifies uploading of movie files you recorded with the "For YouTube" BEST SHOT scene to YouTube.

## ■ What is YouTube?

YouTube is a movie sharing site managed by YouTube, LLC where you can upload movies and view movies uploaded by others.

## ■ To install YouTube Uploader for CASIO

1. On the CD-ROM menu screen, select “YouTube Uploader for CASIO”.

---

2. After reading the information about installation conditions and system requirements for installation in the “Read me” file, install YouTube Uploader for CASIO.

## ■ To upload a movie file to YouTube

- Before you can use YouTube Uploader for CASIO, you need to go to the YouTube website (<http://www.youtube.com/>) and register as a user there.
- Do not upload any video that is copyrighted (including neighboring copyrights) unless you yourself own the copyright or you have obtained the permission of the applicable copyright holder(s).
- The maximum allowed for each upload is a file size of 100 MB or a movie length of 10 minutes.

1. Record the movie you want to upload using the “For YouTube” BEST SHOT movie scene.

---

2. If it isn't already, connect your computer to the Internet.

---

3. Connect the camera to your computer (page 124).

---

4. Turn on the camera.

YouTube Uploader for CASIO will start up automatically.

- If this is the first time you are using the application, configure the YouTube user ID and network environment settings, and then click the [OK] button.
- 

5. The left side of the display will have an area for inputting a title, category, and other information required for uploading to YouTube. Enter the required information.

---

6. The right side of the display shows a list of movie files in camera memory. Select the check box next to the movie file you want to upload.

---

7. When everything is ready, click the [Upload] button.

This will upload the movie file(s) to YouTube.

- After uploading is complete, click the [Exit] button to exit the application.



## Viewing User Documentation (PDF Files)

---

**1. Start up your computer, and place the bundled CD-ROM into its CD-ROM drive.**

Normally, this should cause the menu screen to appear automatically. If your computer does not display the menu screen automatically, navigate to the CD-ROM on your computer and then double-click the "AutoMenu.exe" file.

---

**2. On the menu screen, click the "Language" down arrow button and then select the language you want.**

---

**3. Click "Manual" to select it and then click "Digital Camera".**



### **IMPORTANT!**

- You must have Adobe Reader or Adobe Acrobat Reader installed on your computer in order to view the contents of a PDF file. If you do not already have Adobe Reader or Adobe Acrobat Reader installed, install Adobe Reader from the bundled CD-ROM.

## User Registration

---

You can perform user registration over the Internet. To do so, of course, you need to be able to connect to the Internet with your computer.

**1. On the CD-ROM menu screen, click the "Register" button.**

- This starts up your Web browser and accesses the user registration website. Follow the instructions that appear on your computer screen to register.

## Using the Camera with a Macintosh

Install the required software in accordance with what version of the Macintosh OS you are running and what you want to do.

When you want to do this:	Operating System Version	Install this software:	See page:
Save images to your Macintosh and view them there manually	Mac OS 9	Installation not required.	130
	Mac OS X		
Save images to your Macintosh automatically/ Manage images	Mac OS 9	Use commercially available software.	132
	Mac OS X	Use iPhoto, which comes bundled with your operating system.	
Play movies (Excluding Full HD movies) • Full HD movie playback is not supported (as of January 2008).	Mac OS 9	Playback not supported.	133
	Mac OS X	Movie file playback is supported under OS X v10.3.9 or higher when QuickTime 7 or higher is installed.	133

## Connecting the Camera to Your Computer and Saving Files



### IMPORTANT!

- The camera does not support operation with Mac OS 8.6 or earlier, or Mac OS X 10.0. Operation is supported with Mac OS 9, X (10.1, 10.2, 10.3, 10.4) only. Use the standard USB driver that comes with your supported operating system.

### ■ To connect the camera to your computer and save files

1. Turn on the camera and press [MENU].
2. On the “Set Up” tab, select “USB” and then press [▶].
3. Use [▲] and [▼] to select “Mass Storage”, and then press [SET].

---

**4. Turn off the camera and then use the USB cable that comes with the camera to connect it to your Macintosh.**

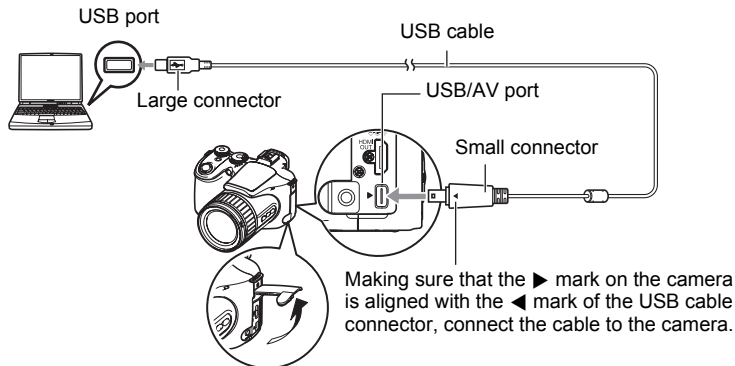

- The camera does not draw power over the USB cable. Make sure the camera's battery is sufficiently charged before connecting.
- Make sure that you insert the cable connector into the USB/AV port until you feel it click securely into place. Failure to insert the connector fully can result in poor communication or malfunction.
- Note that even while the connector is fully inserted, you still will be able to see the metal part of the connector as shown in the illustration.
- When connecting the USB cable to a USB port, make sure you align the connector correctly with the port.

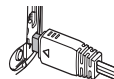

---

**5. Turn on the camera.**

The camera's back lamp will light green at this time. In this mode, your Macintosh recognizes the memory card loaded in the camera (or the camera's built-in memory if it does not have a memory card loaded) as a drive. The appearance of the drive icon depends on the Mac OS version you are using.

---

**6. Double-click the camera's drive icon.**

---

**7. Drag the "DCIM" folder to the folder to which you want to copy it.**

---

**8. After the copy operation is complete, drag the drive icon to Trash.**

---

**9. On the camera, press [ON/OFF] to turn off the camera. After making sure that the green back lamp is unlit, disconnect the camera from the computer.**

## ■ To view copied images

1. Double-click the camera's drive icon.

---

2. Double-click the "DCIM" folder to open it.

---

3. Double-click the folder that contains the images you want to view.

---

4. Double-click the image file you want to view.
  - For information about file names, see "Memory Folder Structure" on page 135.
  - An image that was rotated on the camera will be displayed on your Macintosh screen in its original (unrotated) orientation.



### **IMPORTANT!**

- Never use your computer to modify, delete, move, or rename any image files that are in the camera's built-in memory or on its memory card. Doing so can cause problems with the camera's image management data, which will make it impossible to play back images on the camera and can drastically alter remaining memory capacity. Whenever you want to modify, delete, move, or rename an image, do so only on images that are stored on your computer.
- Never unplug the USB cable, or operate the camera while viewing or storing images. Doing so can cause data to become corrupted.

## **Transferring Images Automatically and Managing Them on Your Macintosh**

If you are running Mac OS X, you can use the iPhoto application that comes bundled with the operating system to manage your images. If you are running Mac OS 9, you will need to use commercially available software.

## Playing a Movie

---

You can use QuickTime, which comes bundled with your operating system, to play back movies on a Macintosh. To play back a movie, first copy it to your Macintosh and then double-click the movie file (excluding Full HD movies).

- Playback of Full HD movies is not supported on a Macintosh.

### ■ Minimum System Requirements for Movie Playback

The minimum system requirements described below are necessary to play back movies recorded with this camera on a Macintosh.

Operating System : Mac OS X 10.3.9 or higher

QuickTime Version: QuickTime 7 or higher

- The above are recommended system environments. Configuring one of these environments does not guarantee proper operation.
- Even if your Macintosh meets the minimum requirements described above, certain settings and other installed software may interfere with proper playback of movies.
- Movie file playback is not supported under OS 9.

## Viewing User Documentation (PDF Files)

---

You must have Adobe Reader or Adobe Acrobat Reader installed on your computer in order to view the contents of a PDF file. If you don't, go to the Adobe Systems Incorporated website and install Acrobat Reader.

- 1. On the CD-ROM, open the "Manual" folder.**
- 2. Open the "Digital Camera" folder and then open the folder for the language whose user's guide you want to view.**
- 3. Open the file named "camera\_xx.pdf".**
  - "xx" is the language code (Example: camera\_english.pdf is for English.)

## User Registration

---

Internet registration only is supported. Visit the following CASIO website to register:  
<http://world.casio.com/qv/register/>

## Files and Folders

The camera creates a file and saves it each time you shoot a snapshot, record a movie, or perform any other operation that stores data. Files are grouped by storing them in folders. Each file and folder has its own unique name.

- For details about how folders are organized in memory, see “Memory Folder Structure” (page 135).

Name and Maximum Number Allowed	Example
<b>File</b>	
Each folder can contain up to 9999 files named CIMG0001 through CIMG9999. The extension on the file name depends on the file type.	26th file name:  CIMG0026.JPG Serial number      Extension (4 digits)
<b>Folders</b>	
Folders are named from 100CASIO to 999CASIO There can be up to 900 folders in memory. <ul style="list-style-type: none"><li>• The BEST SHOT mode (page 67) includes a sample scene that optimizes settings for auction site images. Depending on your camera model, the sample scene is named either “For eBay” or “Auction”.<ul style="list-style-type: none"><li>– Images recorded with the “For eBay” scene are stored in a folder named “100_EBAY”.</li><li>– Images recorded with the “Auction” scene are stored in a folder named “100_AUCT”.</li></ul></li><li>• BEST SHOT also has a scene named “For YouTube” that optimizes movie settings for recording movies for uploading to YouTube. Images recorded with the “For YouTube” scene are stored in a folder named “100YOUTB”.</li></ul>	100th folder name:  100CASIO Serial number (3 digits)

- You can view folder and file names on your computer. For details about how file names are displayed on the camera’s monitor screen, see page 166.
- The total number of folders and files allowed depends on the image size and quality, and capacity of the memory card being used for storage.

## Memory Card Data

The camera stores images you shoot in accordance with the Design Rule for Camera File System (DCF).

### ■ About DCF

DCF is a standard that makes it possible to view and print images recorded on one manufacturer's camera on DCF-compliant devices produced by other manufacturers. You can transfer DCF-compliant images recorded with another camera to this camera and view them on this camera's monitor screen.

### ■ Memory Folder Structure

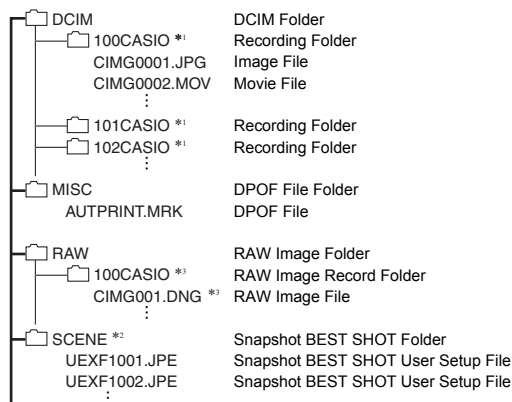

\*1 Other folders are created when the following BEST SHOT scenes are used for recording: "For eBay" or "Auction" (scene name depends on camera model), or "For YouTube". The following shows the name of the folder created for each scene.

- "For eBay" scene: 100\_EBAY
- "Auction" scene: 100\_AUCT
- "For YouTube" scene: 100YOUTB

\*2 This folder or file can be created in built-in memory only.

\*3 RAW image data is stored with the same file name in a folder with the same folder name as the corresponding JPEG memory that is recorded at the same time.

## ■ Supported Image Files

- Image files shot with this camera
- DCF-compliant image files

This camera may not be able to display an image, even if it is DCF-compliant. When displaying an image recorded on another camera, it may take a long time for the image to appear on this camera's monitor screen.

## ■ Built-in Memory and Memory Card Data Handling Precautions

- Whenever copying memory contents to your computer, you should copy the DCIM folder and all of its contents. A good way to keep track of multiple DCIM folders is to change their names to dates or something similar after you copy them to your computer. If you later decided to return a DCIM folder to the camera, however, be sure to change its name back to DCIM. The camera is designed to recognize only a root file with the name DCIM. Note the camera also will not be able to recognize the folders inside the DCIM folder unless they have the names they originally had when you copied them from the camera to your computer.
- Folders and files must be stored in accordance with the "Memory Folder Structure" shown on page 135 in order for the camera to be able to recognize them correctly.
- You also can use a PC card adapter or a memory card reader/writer to access camera files directly from the camera's memory card.



## Other Settings (Set Up)

This section explains menu items that you can use to configure settings and perform other operations in both the REC mode and PLAY mode.

For information about menu operations, see page 77.

### Adjusting Monitor Screen Brightness (Screen)

#### Procedure

[MENU] → Set Up Tab → Screen

<b>Auto 2/ Auto 1</b>	With this setting, the camera detects available light levels and automatically adjusts the brightness of the monitor screen accordingly. "Auto 2" changes monitor screen brightness relatively more quickly than "Auto 1" when surrounding light is bright.
<b>+2</b>	Brightness that is greater than +1, which makes the screen easier to view. This setting consumes more power.
<b>+1</b>	Bright setting for outdoor use, etc. Brightness that is greater than 0.
<b>0</b>	Normal monitor screen brightness for indoor use, etc.
<b>-1</b>	Low monitor screen brightness for nighttime use, indoor use under dark conditions, etc.

### Adjusting Viewfinder Brightness (EVF Brightness)

#### Procedure



[MENU] → Set Up Tab → EVF Brightness

You can use the above procedure to change the brightness of the viewfinder. You can select one of three levels from +2 (brightest) to 0 (normal).

## Configuring Camera Sound Settings (Sounds)

### Procedure

[MENU] → Set Up Tab → Sounds

<b>Startup</b>	
<b>Half Shutter</b>	Specifies the startup sound
<b>Shutter</b>	Sound 1 - 5: Built-in sounds (1 through 5) Off: Sound off
<b>Operation</b>	
 <b>Operation</b>	Specifies the sound volume. This setting is also used as the audio level during video output (page 144).
 <b>Play</b>	Specifies the volume of movie audio output. This volume setting is not used during video output (from the USB/AV port) (page 144).

- Setting a volume level of 0 mutes output.

## Specifying the File Name Serial Number Generation Rule (File No.)

### Procedure

[MENU] → Set Up Tab → File No.

Use the following procedure to specify the rule that governs generation of the serial number used in file names (page 134).

<b>Continue</b>	Tells the camera to remember the last used file number. A new file will be named using the next sequential number, even if files are deleted or if a blank memory card is loaded. If a memory card is loaded and that card already has files stored on it and the largest sequential number in the existing file names is greater than the largest sequential number remembered by the camera, numbering of new files will start from the largest sequential number in the existing file names plus 1.
<b>Reset</b>	Restarts the serial number from 0001 whenever all files are deleted or when the memory card is replaced with a blank one. If a memory card is loaded and that card already has files stored on it, numbering of new files will start from the largest sequential number in the existing file names number plus 1.

## Configuring World Time Settings (World Time)

### Procedure

#### [MENU] → Set Up Tab → World Time

You can use the World Time screen to view the current time in a zone that is different from your Home City when you go on a trip, etc. World Time displays the current time in 162 cities in 32 time zones around the globe.

**1. Use [▲] and [▼] to select “World” and then press [▶].**

- To change the geographic area and city for the time where you normally use the camera, select “Home”.

---

**2. Use [▲] and [▼] to select “City” and then press [▶].**

- To change the “World” setting to summer time, use [▲] and [▼] to select “DST” and then select “On”. Summer time is used in some geographical areas to advance the current time setting by one hour during the summer months.

---

**3. Use [▲], [▼], [◀], and [▶] to select the geographic area you want and then press [SET].**

---

**4. Use [▲] and [▼] to select the city you want and then press [SET].**

---

**5. Press [SET].**

## Time Stamping Snapshots (Timestamp)

### Procedure

#### [MENU] → Set Up Tab → Timestamp

You can configure the camera to stamp the recording date only, or date and time in the lower right corner of each snapshot.

- Once date and time information is stamped into a snapshot, it cannot be edited or deleted.

Example: December 19, 2009, 1:25 p.m.

<b>Date</b>	2009/12/19
<b>Date&amp;Time</b>	2009/12/19 1:25pm
<b>Off</b>	No stamping of date and/or time

- Even if you do not stamp the date and/or time with Timestamp, you can do so later using the DPOF function or some printing application (page 120).
- Stamping is performed in accordance with the date and time settings (page 140) and the display style settings (page 141).

## Setting the Camera's Clock (Adjust)

### Procedure

#### [MENU] → Set Up Tab → Adjust

<b>[▲] [▼]</b>	Change the setting at the cursor location
<b>[◀] [▶]</b>	Move the cursor between settings
<b>[DISP]</b>	Toggles between 12-hour and 24-hour format

When the date and time settings are what you want, press [SET] to apply them.

- You can specify a date from 2001 to 2049.
- Be sure to select your Home City (page 139) before setting the time and date. If you set the time and date while the wrong city is selected for your Home City, the times and dates of all of the World Time cities (page 139) will be wrong.

## Specifying the Date Style (Date Style)

### Procedure

[MENU] → Set Up Tab → Date Style

You can select from among three different styles for the date.

Example: December 19, 2009

YY/MM/DD	09/12/19
DD/MM/YY	19/12/09
MM/DD/YY	12/19/09

- This setting also affects the control panel date format as shown below (page 28).  
YY/MM/DD or MM/DD/YY: MM/DD  
DD/MM/YY: DD/MM

## Specifying the Display Language (Language)

### Procedure

[MENU] → Set Up Tab → Language

■ Specify the display language you want.

- ① Select the tab on the right.
- ② Select "Language".
- ③ Select the language you want.



## Configuring Sleep State Settings (Sleep)

### Procedure

**[MENU] → Set Up Tab → Sleep**

This feature turns off the monitor screen whenever no camera operation is performed for a preset amount of time. Press any button to turn the monitor screen back on.

Trigger Time Settings: 30 sec, 1 min, 2 min, Off (Sleep is disabled while "Off" is selected.)

Sleep is disabled under any of the following conditions.

- In the PLAY Mode
- While the camera is connected to a computer or other device
- During a slideshow
- During movie recording and playback
- During Move Out CS or Move In CS auto record standby
- When both sleep and Auto Power Off are turned on, Auto Power Off takes priority.

## Configuring Auto Power Settings (Auto Power Off)

### Procedure

**[MENU] → Set Up Tab → Auto Power Off**

Auto Power Off turns off the camera whenever no camera operation is performed for a preset amount of time.

Trigger Time Settings: 2 min, 5 min, 10 min (The trigger time is always 5 minutes in the PLAY mode.)

Auto Power Off is disabled under any of the following conditions.

- While the camera is connected to a computer or other device
- During a slideshow
- During CS group playback
- During movie recording and playback
- During Move Out CS or Move In CS auto record standby

## Configuring [📷] and [▶] Settings (REC/PLAY)

### Procedure

[MENU] → Set Up Tab → REC/PLAY

<b>Power On</b>	Camera turns on whenever [📷] (REC) or [▶] (PLAY) is pressed.
<b>Power On/Off</b>	Camera turns on or off whenever [📷] (REC) or [▶] (PLAY) is pressed.
<b>Disable</b>	Camera does not turn on or off whenever [📷] (REC) or [▶] (PLAY) is pressed.

- With “Power On/Off”, the camera turns off when you press [📷] (REC) in the REC mode or [▶] (PLAY) in the PLAY mode.
- Change this setting to anything besides “Disable” before connecting to a TV for image viewing.

## Controlling Monitor Screen Priority (LCD Priority)

### Procedure

[MENU] → Set Up Tab → LCD Priority

You can use this setting to control when the monitor screen turns on.

<b>On</b>	With this setting, the monitor screen turns on during image playback and menu display.
<b>Off</b>	With this setting, the monitor screen turns on during image playback and whenever the [EVF/LCD] button is pressed.

## Configuring USB Protocol Settings (USB)

### Procedure

[MENU] → Set Up Tab → USB

You can use the procedure below to select the USB communication protocol, which is used when exchanging data with a computer, printer, or other external device.

<b>Mass Storage</b>	Select this setting when connecting to a computer. With this setting, the computer sees the camera as an external storage device. Use this setting for normal transfer of images from the camera to a computer.
<b>PTP (PictBridge)</b>	Select this setting when connecting to a printer that supports PictBridge (page 117). This setting simplifies the transfer of image data to the connected device.

## Selecting the Screen Aspect Ratio and Video Output System (Video Out)

### Procedure

[MENU] → Set Up Tab → Video Out

You can use the procedure in this section to select either NTSC or PAL as the video output system. You can also specify an aspect ratio of 4:3 or 16:9.

<b>NTSC</b>	Video system used in Japan, the U.S., and other countries
<b>PAL</b>	Video system used in Europe and other areas
<b>4:3</b>	Normal TV screen aspect ratio
<b>16:9</b>	Wide screen aspect ratio

- Select the aspect ratio (4:3 or 16:9) that matches the type of TV you plan to use. Images will not display correctly if you select the wrong aspect ratio.
- Images will not display correctly unless the camera's video signal output setting matches the video signal system of the TV or other video equipment.
- Images cannot be displayed correctly on a TV or video equipment that is not NTSC or PAL.
- REC mode video output is supported only when the aspect ratio setting is 16:9.



## Selecting the HDMI Terminal Output Method (HDMI Output)

### Procedure

**[MENU] → Set Up Tab → HDMI Output**

See page 105 for details.

## Formatting Built-in Memory or a Memory Card (Format)

### Procedure

**[MENU] → Set Up Tab → Format**

If a memory card is loaded in the camera, this operation will format the memory card. It will format built-in memory if no memory card is loaded.

- The format operation will delete all contents on the memory card or in built-in memory. It cannot be undone. Make sure you do not need any data currently on the card or in built-in memory before you format it.
- Formatting built-in memory will delete the following data.
  - Protected images
  - BEST SHOT mode user setups
- Formatting a memory card will delete the following data.
  - Protected images
- Make sure that the battery is charged fully before starting a formatting operation. Formatting may not be performed correctly and the camera may stop operating normally if the camera powers down while formatting is in progress.
- Never open the battery cover while formatting is in progress. Doing so can cause the camera to stop operating normally.

## Resetting the Camera to Factory Defaults (Reset)

### Procedure



**[MENU] → Set Up Tab → Reset**

See page 168 for details about the camera's factory default settings.

# Configuring Monitor Screen Settings

## Turning Display Information On and Off (Info)

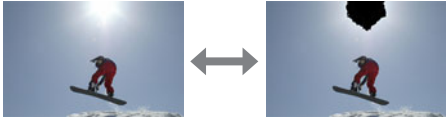
Each press of [DISP] will cycle through different types of display information. You can configure separate settings for the REC mode and PLAY mode.

<b>Information On</b>	Displays information about image settings, etc.
<b>Information On with Display Highlighting</b>	Setting contents displayed, and overexposed areas in images flash on the screen. 
<b>Information On with Histogram</b>	Turns on display of camera setting and other indicators, along with a histogram (page 147)  Histogram
<b>Information Off</b>	No information displayed

- Display information cannot be turned off during movie recording.
- The display information setting cannot be changed during High-speed Movie recording.

## Selecting Monitor Screen and Viewfinder Settings

Each press of the [EVF/LCD] button cycles through the available monitor screen and viewfinder on/off settings.

- Both the monitor screen and viewfinder cannot be turned on at the same time.
- Switching from the monitor screen to the viewfinder will cause the information displayed in the viewfinder to disappear. To re-display the information in the viewfinder, press [DISP].

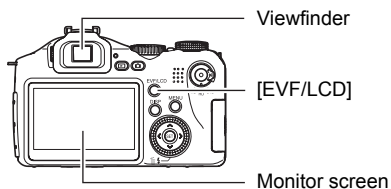

## Using the On-screen Histogram to Check Exposure (+Histogram)

Displays a histogram on the monitor screen which you can use to check the exposure of an image before you shoot it. You also can display the histogram in the PLAY mode for information about the exposure levels of images.

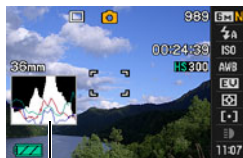

Histogram

### NOTE

- A centered histogram does not necessarily guarantee optimum exposure. The recorded image may be over-exposed or under-exposed, even though its histogram is centered.
- Due to the limitations of exposure compensation, you may not be able to achieve an optimum histogram configuration.
- Use of the flash and certain shooting conditions can cause the histogram to indicate exposure that is different from the actual exposure of the image when it is shot.
- The histogram cannot be displayed during High-speed Movie recording.

## How to Use the Histogram

A histogram is a graph that represents the lightness of an image in terms of the number of pixels. The vertical axis indicates the number of pixels, while the horizontal axis indicates lightness. If the histogram appears too lopsided for some reason, you can use EV shift to move it left or right in order to achieve better balance. Optimum exposure can be achieved by EV shifting so the graph is as close to the center as possible. For snapshots, you can even display individual histograms for R (red), G (green), and B (blue).

### Example Histograms

A histogram towards the left side results when the overall image is dark. A histogram that is too far to the left may result in “black out” of the dark areas of an image.



A histogram towards the right side results when the overall image is light. A histogram that is too far to the right may result in “white out” of the light areas of an image.



An overall well-balanced histogram results when the overall image is at optimal lightness.



## Precautions during Use

### ■ Avoid Use While In Motion

- Never use the camera to record or play back images while operating an automobile or other vehicle, or while walking. Looking at the monitor while in motion creates the risk of serious accident.

### ■ Directly Viewing the Sun or Bright Light

- Never look at the sun or any other bright light through the camera's viewfinder. Doing so can damage your eyesight.

### ■ Flash

- Never use the flash unit in areas where flammable or explosive gas may be present. Such conditions create the risk of fire and explosion.
- Never fire the flash in the direction of a person operating a motor vehicle. Doing so can interfere with the driver's vision and creates the risk of accident.
- Never fire the flash too close to the eyes of the subject. Doing so creates the risk of loss of eyesight.

### ■ Display Panel

- Do not apply strong pressure to the LCD panel surface or subject it to strong impact. Doing so can cause the display panel glass to crack.
- Should the display panel ever become cracked, never touch any of the liquid inside the panel. Doing so creates the risk of skin inflammation.
- Should display panel liquid ever get into your mouth, immediately rinse your mouth out and contact your physician.
- Should display panel liquid ever get into your eyes or onto your skin, immediately rinse with clean water for at least 15 minutes and contact your physician.

### ■ Connections

- Never plug any devices that are not specified for use with this camera into connectors. Connecting a non-specified device creates the risk of fire and electric shock.

### ■ Transport

- Never operate the camera inside of an aircraft or anywhere else where operation of such devices is restricted. Improper use creates the risk of serious accident.

### ■ **Smoke, abnormal odor, overheating, and other abnormalities**

- Continued use of the camera while it is emitting smoke or strange odor, or while it is overheating creates the risk of fire and electric shock. Immediately perform the following steps whenever any of the above symptoms are present.
  1. Turn off the camera.
  2. Remove the battery from the camera, taking care to protect yourself against burn injury.
  3. Contact your dealer or nearest CASIO authorized service center.

### ■ **Water and Foreign Matter**

- Water, other liquids, or foreign matter (especially metal) getting inside the camera creates the risk of fire and electric shock. Immediately perform the following steps whenever any of the above symptoms are present. Particular care is required when using the camera where it is raining or snowing, near the ocean or other body of water, or in a bathroom.
  1. Turn off the camera.
  2. Remove the battery from the camera.
  3. Contact your dealer or nearest CASIO authorized service center.

### ■ **Dropping and Rough Treatment**

- Continued use of the camera after it is damaged by dropping or other rough treatment creates the risk of fire and electric shock. Immediately perform the following steps whenever any of the above symptoms are present.
  1. Turn off the camera.
  2. Remove the battery from the camera.
  3. Contact your dealer or nearest CASIO authorized service center.

### ■ **Keep Away From Fire**

- Never expose the camera to fire, which can cause it to explode and creates the risk of fire and electric shock.

### ■ **Disassembly and Modification**

- Never try to take the camera apart or modify it in any way. Doing so creates the risk of electric shock, burn injury, and other personal injury. Be sure to leave all internal inspection, maintenance, and repair up to your dealer or nearest CASIO authorized service center.

## ■ Locations To Be Avoided

- Never leave the camera in any of the following types of locations. Doing so creates the risk of fire and electric shock.
  - Areas subject to large amounts of humidity or dust
  - Food preparation areas or other locations where oil smoke is present
  - Near heaters, on a heated carpet, in areas exposed to direct sunlight, in a closed vehicle parked in the sun, or other areas subject to very high temperatures
- Never place the camera on an unstable surface, on a high shelf, etc. Doing so can cause the camera to fall, creating the risk of personal injury.

## ■ Backing Up Important Data

- Always keep backup copies of important data in camera memory by transferring it to a computer or other storage device. Note that data can be deleted in the case of camera malfunction, repair, etc.

## ■ Memory Protection

- Whenever replacing the battery, be sure to follow the correct procedure as described in the documentation that comes with the camera. Incorrectly replacing the battery can result in corruption or loss of data in camera memory.

## ■ Rechargeable Battery

- Use only the specified charger unit or the specified device to charge the battery. Attempting to charge the battery by an unauthorized means creates the risk of battery overheating, fire, and explosion.
- Do not expose or immerse the battery in fresh water or salt water. Doing so can damage the battery, and cause deterioration of its performance and loss of service life.
- The battery is intended for use with a CASIO Digital Camera only. Use with any other device creates the risk of the battery damage, or deterioration of battery performance and service life.
- Failure to observe any of the following precautions creates the risk of battery overheating, fire, and explosion.
  - Never use or leave the battery near open flame.
  - Do not expose the battery to heat or fire.
  - Make sure the battery is oriented correctly when it is connected to the charger unit.
  - Never carry or store the battery together with items that can conduct electricity (necklaces, pencil lead, etc.)
  - Never disassemble the battery, pierce it with a needle, or expose it to strong impact (hit it with a hammer, step on it, etc.), and never apply solder to it. Never place the battery into a microwave oven, heater, high-pressure generating device, etc.
- Should you ever notice leakage, strange odor, heat generation, discoloration, deformation, or any other abnormal condition while using, charging, or storing a battery, immediately remove it from the camera or charger unit and keep it away from open flame.

- Do not use or leave the battery under direct sunlight, in an automobile parked in the sun, or in any other area subject to high temperatures. Doing so can damage the battery, and cause deterioration of its performance and loss of service life.
- If battery charging does not end normally within the specified charging time, stop charging anyway and contact your local CASIO authorized service center. Continued charging creates the risk of battery overheating, fire, and explosion.
- Battery fluid can damage your eyes. Should battery fluid get into your eyes accidentally, immediately rinse them with clean tap water and then consult a physician.
- Be sure to read the user documentation that comes with the camera and special charger unit before using or charging the battery.
- If a battery is to be used by young children, make sure that a responsible adult makes them aware of the precautions and proper handling instructions, and make sure that they handle the battery correctly.
- Should fluid from a battery accidentally get onto clothing or your skin, immediately rinse it off with clean tap water. Prolonged contact with battery fluid can cause skin irritation.

## ■ Battery Life

- Battery continuous operation times provided in this manual represent the approximate amount of time before the camera turns off due to low battery power when being powered by the special battery under normal temperature (23°C (73°F)). They do not guarantee that you will be able to achieve the indicated level of operation. Actual battery life is greatly affected by ambient temperature, battery storage conditions, the amount of time spent in storage, etc.
- Leaving the camera on can run down the battery and cause the low battery warning to appear. Turn off the camera whenever you are not using it.
- The low battery warning indicates that the camera is about to turn off due to low battery power. Charge the battery as soon as possible. Leaving a low or dead battery in the camera can lead to battery leakage and data corruption.



## ■ Power Supply

- Use only the special rechargeable lithium ion battery (NP-100) to power this camera. Use of any other type of battery is not supported.
- The camera does not have a separate battery for the clock. The date and time settings of the camera are cleared about one day after power is cut off from the battery. If this happens, be sure to reconfigure these settings after power is restored (page 140).

## ■ Data Error Precautions

Your digital camera is manufactured using precision digital components. Any of the following creates the risk of corruption of data in camera memory.

- Removing the battery or memory card while the camera is performing some operation
- Removing the battery or memory card while the back lamp is flashing green after turning off the camera
- Disconnecting the USB cable while communication is in progress
- Using a battery that is low
- Other abnormal operations

Any of the above conditions can cause an error message to appear on the monitor screen (page 174). Perform the action indicated by the message that appears.

## ■ Operating Environment

- Operating Temperature: 0 to 40°C (32 to 104°F)
- Operating Humidity: 10 to 85% (non condensation)
- Do not place the camera in any of the following locations.
  - In an area exposed to direct sunlight, or large amounts of moisture or dust
  - Near an air conditioner or in other areas subjected to extreme temperature or humidity
  - Inside of a motor vehicle on a hot day, or in an area subjected to strong vibration

## ■ Condensation

Sudden and extreme temperature changes, such as when the camera is moved from the outdoors on a cold winter day into a warm room, can cause water droplets called “condensation” to form on the interior and the exterior of the camera, which creates the risk of malfunction. To prevent condensation from forming seal the camera in a plastic bag before changing locations. Then leave the bag sealed to allow the air inside to naturally change to the same temperature as the air in the new location. After that, remove the camera from the bag and open the battery cover for a few hours.

## ■ Lens

- Never apply too much force when cleaning the surface of the lens. Doing so can scratch the lens surface and cause malfunction.
- You may sometimes notice some distortion in certain types of images, such as a slight bend in lines that should be straight. This is due to the characteristics of lenses, and does not indicate malfunction of the camera.

## ■ Caring for your camera

- Never touch the lens or flash window with your fingers. Finger smudges, dirt, and other foreign matter on the lens or flash window can interfere with proper operation of the camera. Use a blower or other means to keep the lens and flash window free of dirt and dust, and wipe gently with a soft, dry cloth.
- To clean the camera, wipe it with a soft, dry cloth.

## ■ Old Rechargeable Battery Handling Precautions

- Insulate the positive and negative terminals with tape, etc.
- Do not peel the covering off of the battery.
- Do not try to take the battery apart.

## ■ Charger Unit Handling Precautions



- Never plug the power cord into an outlet whose voltage rating is different from that marked on the power cord. Doing so creates the risk of fire, malfunction, and electric shock.
- Take care to protect the power cord against damage and breaking. Never place heavy objects onto the power cord, or expose it to intense heat. Doing so can damage the power cord, creating the risk of fire and electric shock.
- Never try to modify the power cord, or subject it to severe bending, twisting, or pulling. Doing so creates the risk of fire, malfunction, and electric shock.
- Never plug in or unplug the power cord while your hands are wet. Doing so creates the risk of electric shock.
- Do not plug the power cord into an outlet or extension cord that is shared by other devices. Doing so creates the risk of fire, malfunction, and electric shock.
- Should the power cord ever become damaged (to the point that internal wires are exposed or cut), immediately contact your original retailer or authorized CASIO authorized service center to request repair. Continued use of a damaged power cord creates the risk of fire, malfunction, and electric shock.

- The charger unit becomes slightly warm during charging. This is normal and does not indicate malfunction.
- Unplug the power cord from the power outlet when you are not using the charger unit.
- Never use detergent to clean the power cord (especially the plug).
- Never cover the charger unit with a blanket, etc. Doing so creates the risk of fire.

## ■ Other Precautions

The camera becomes slightly warm during use. This is normal and does not indicate malfunction.

## ■ Copyrights

Except for your own personal enjoyment, unauthorized use of use of snapshots or movies of images whose rights belong to others, without the permission of the right holder, is forbidden by copyright laws. In some cases, shooting of public performances, shows, exhibitions, etc. may be restricted entirely, even if it is for your own personal enjoyment. Regardless of whether such files are purchased by you or obtained for free, posting them on a website, a file sharing site, or any other Internet site, or otherwise distributing them to third parties without the permission of the copyright holder is strictly prohibited by copyright laws and international treaties. For example, uploading or distributing on the Internet images of TV programs, live concerts, music videos, etc. that were photographed or recorded by you may infringe upon the rights of others. Note that CASIO COMPUTER CO., LTD. shall not be held liable for use of this product in any way that infringes on the copyrights of others or that violates copyright laws.

The following terms, which are used in this manual, are registered trademarks or trademarks of their respective owners.

Note that trademark <sup>™</sup> and registered trademark <sup>®</sup> are not use within the text of this manual.

- The SDHC logo is a trademark.
- Microsoft, Windows, Internet Explorer, and Windows Vista are registered trademarks or trademarks of Microsoft Corporation in the United States and other countries.
- Macintosh, Mac OS, QuickTime, the QuickTime logo, and iPhoto are trademarks of Apple Inc.
- MultiMediaCard is a trademark of Infineon Technologies AG of Germany, and licensed to the MultiMediaCard Association (MMCA).
- MMC*plus* is a trademark of the MultiMediaCard Association.
- Adobe and Reader are trademarks or registered trademarks of Adobe Systems Incorporated in the United States and other countries.
- Copyright © 2008 ArcSoft, Inc. All rights reserved.  
ArcSoft and the ArcSoft logo are trademarks or registered trademarks in the United States and other countries.
- YouTube, the YouTube logo, and “Broadcast Yourself” are trademarks or registered trademarks of YouTube, LLC.
- HDMI, the HDMI logo, and High-Definition Multimedia Interface are trademarks or registered trademarks of HDMI Licensing, LLC.
- EXILIM and YouTube Uploader for CASIO are registered trademarks or trademarks of CASIO COMPUTER CO., LTD.
- All other company or product names mentioned herein are registered trademarks or trademarks of their respective companies.

Any and all unauthorized commercial copying, distribution, and copying of the bundled software over a network are prohibited.

This product contains PrKERNELv4 Real-time OS of eSOL Co., Ltd. Copyright© 2007 eSOL Co., Ltd.  
PrKERNELv4 is a registered trademark of eSOL Co., Ltd. in Japan.



This product's YouTube upload functionality is included under license from YouTube, LLC. The presence of YouTube upload functionality in this product is not an endorsement or recommendation of the product by YouTube, LLC.

## Power Supply

### Charging

#### If the [CHARGE] lamp does not light...

Charging cannot be performed because ambient temperature or the temperature of the charger is too hot or too cold. Wait until the camera returns to normal temperature. When the camera returns to a temperature where charging can be performed, the [CHARGE] lamp will light red.

Operating Temperature: 5°C to 35°C (41°F to 95°F)

If the [CHARGE] lamp does not light red even within the specified operating temperature, the battery is faulty or the battery is loaded in the charger incorrectly. Remove the battery from the charger and check if its contacts are dirty. If contacts become dirty, wipe them clean with a dry cloth. When experiencing charging problems, also check to make sure that the power cord is not disconnected from the power outlet or charger.

If problems continue to occur after you perform the above steps, it could mean that the battery is faulty. Contact your nearest CASIO authorized service center.

## To replace the battery

### 1. Open the battery cover and remove the current battery.

Slide the stopper in the direction indicated by the arrow in the illustration. After the battery pops out, pull it the rest of the way out of the camera.

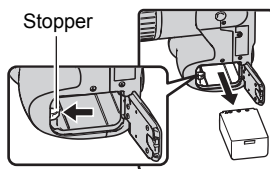

### 2. Load a new battery.

## Battery Precautions

### ■ Precautions during Use

- Operation provided by a battery under cold conditions is always less than operation under normal temperatures. This is due to the characteristics of the battery, not the camera.
- If a battery provides only very limited operation following a full charge, it probably means the battery has reached the end of its service life. Replace the battery with a new one.

### ■ Storage Precautions

- Storing the battery for a long time while it is charged can cause deterioration of battery characteristics. If you do not plan to use a battery for some time, fully use up its charge before storing it.
- Always remove the battery from the camera when you are not using it. A battery left in the camera can discharge and go dead, which will require some time to charge when you need to use the camera.
- Store batteries in a cool, dry place (20°C (68°F) or lower).

## Using the Camera in another Country

### ■ Precautions during Use

- The bundled charger is designed for operation with any power supply in the range of 100V to 240V AC, 50/60Hz. Note, however, that the shape of the power cord plug depends on each country or geographic area. Before taking the camera and charger along on a trip, check with travel agent about the power supply requirements in your destination(s).
- Do not connect the charger to a power supply through a voltage converter or similar device. Doing so can lead to malfunction.

### ■ Extra Batteries

- Taking along extra fully charged batteries (NP-100) is recommended while on a trip in order to avoid not being able to shoot images due to the battery going dead.

## Using Household Power

You need to purchase the optionally available AC adaptor (AD-C100) in order to be able to power the camera using a household power supply.

1. Connect the power cord to the AC adaptor.
2. Open the camera's terminal cover and connect the AC adaptor to the terminal marked [  ].
3. Plug the power cord into a power outlet.

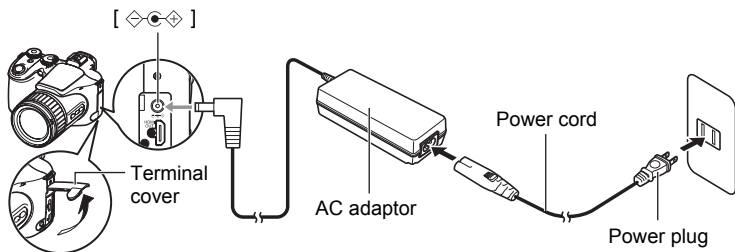

## ■ Using Power in Other Countries

- The AC adaptor is designed for operation with any power supply in the range of 100 V to 240 V AC, 50/60 Hz. Note, however, that the shape of the power cord plug depends on each country or geographic area. Before taking the camera and AC adaptor along on a trip, check with travel agent about the power supply requirements in your destination(s).
- Do not connect the AC adaptor to a power supply through a voltage converter or similar device. Doing so can lead to malfunction.

## ■ Precautions when Using the AC Adaptor

- Connecting the AC adaptor to the camera does not charge the battery.
- Make sure that the camera is turned off before connecting or disconnecting the AC adaptor.
- If you are connecting the AC adaptor to the camera while it has a battery loaded, never connect or disconnect the AC adaptor while the camera is turned on.
- The AC adaptor will become warm after long use. This is normal and does not indicate malfunction.
- Unplug the AC adaptor from the power outlet whenever you are not using it.
- When the AC adaptor is connected to the camera while the battery is loaded, the AC adaptor power is given priority.
- Use of the AC adaptor to power the camera is recommended when connected to a computer.
- Never cover the AC adaptor with a blanket, etc. Doing so creates the risk of fire.

## Using a Memory Card

See page 16 for information about supported memory cards and how to load a memory card.

### To replace the memory card

Press the memory card and then release it. This will cause it to pop out of the memory card slot slightly. Pull the card out the rest of the way and then insert another one.

- Never remove a card from the camera while the back lamp is flashing green. Doing so can cause the image save operation to fail and even damage the memory card.

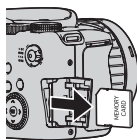



## ■ Using a Memory Card

- SD memory cards and SDHC memory cards have a write protect switch. Use the switch when you need to guard against accidentally deleting data. Note, however, if you write protect an SD memory card you must then turn write protection off whenever you want to record to it, format it, or delete any of its images.
- If a memory card starts to behave abnormally during image playback, you can restore normal operation by reformatting it (page 145). However, it is recommended that you always take along multiple memory cards whenever using the camera far away from the home or office.
- As you record data to and delete data from a memory card a number of times, it loses its ability to retain data. Because of this, periodic re-formatting of a memory card is recommended.
- Electrostatic charge, electrical noise, and other phenomena can cause data to become corrupted or even lost. Make sure that you always back up important data on other media (CD-R, CD-RW, hard disk, etc.)

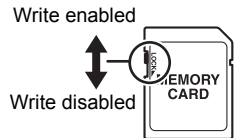

## ■ Discarding or Transferring Ownership of a Memory Card or the Camera

The format and delete functions of the camera do not actually delete files from the memory card. The original data remains on the card. Note that responsibility for the data on a memory card lies with you. The following procedures are recommended whenever you discard a memory card or the camera, or if you transfer ownership to another party.

- When discarding a memory card, either physically destroy the memory card or use commercially available data delete software to completely delete the data on the memory card.
- When transferring ownership of a memory card to another party, use commercially available data deletion software to completely delete the data on it.
- Use the format function (page 145) to completely delete the data in built-in memory before discarding or transferring ownership of the camera.

## Computer System Requirements for Bundled Software

Computer system requirements are different for each of the applications. Be sure to check the requirements for the particular application you are trying to use. Note that the values provided here are minimum requirements for running each application. Actual requirements are greater, depending on the number of images and the sizes of the images being handled.

### ● Windows

#### YouTube Uploader for CASIO

- Sufficient memory to run the operating system
- Computer configuration that enables playback of movies on the YouTube site
- Computer configuration that enables upload of movies to the YouTube site

#### Adobe Reader 8

CPU : Pentium III Class  
Memory : At least 128MB  
Hard Disk Drive Space: At least 180MB  
Other : Internet Explorer 6.0 or higher installed

#### ArcSoft TotalMedia Extreme for CASIO

Operating System: Windows Vista, XP (SP2)

#### ArcSoft TotalMedia Theatre for CASIO

Operating System : Windows Vista, XP (SP2)  
CPU : Intel Pentium EE 3.2 GHz, Intel Core Duo, AMD Athlon 64 FX series, AMD Athlon 64 X2 series  
Hard Disk Drive Space: Equivalent 120MB free hard disk drive space  
Memory : 512MB RAM (1GB recommended)  
Graphics card : NVIDIA Geforce: 7 series or above or ATI: X1000 series or above  
Graphics card memory: 256MB or above

#### ArcSoft TotalMedia Studio for CASIO

Operating System : Windows Vista, XP (SP2)  
CPU : Pentium III 800 MHz or higher (PIV 1.6 GHz or higher recommended)  
Hard Disk Drive Space: 1GB free hard disk drive space (4GB or higher recommended)  
Memory : 512MB RAM (1GB recommended)

For details about the minimum system requirements for each software application, see the "Read me" files on the CASIO Digital Camera Software CD-ROM that comes bundled with the camera.

## General Guide

The numbers in parentheses indicate the pages where each item is explained.

### ■ Camera

#### Front

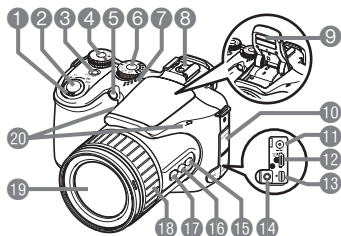

#### Back

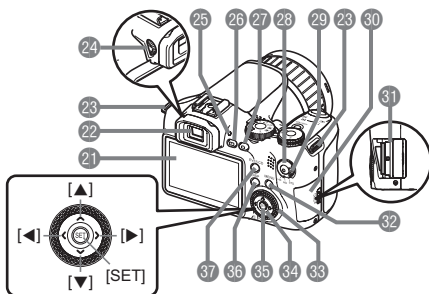

- |   |   |   |
|---|---|---|
| 1 Zoom controller<br>(pages 18, 40, 101)          | 15 [AE-L/AF-L] button<br>(page 45)                | 30 Memory card slot cover<br>(page 16)              |
| 2 Shutter button (page 18)                        | 16 [Back Lighting Correction] button<br>(page 45) | 31 Memory card slot<br>(pages 16, 160)              |
| 3 [ON/OFF] (Power)<br>(page 24)                   | 17 [FOCUS] button<br>(page 43)                    | 32 [MENU] button<br>(page 77)                       |
| 4 Mode dial (pages 18, 25)                        | 18 Function ring (page 85)                        | 33 Control dial (page 77)                           |
| 5 Front lamp<br>(pages 79, 80)                    | 19 Lens   | 34 Control button<br>([▲] [▼] [◀] [▶])<br>(page 28) |
| 6 CS dial (pages 18, 46)                          | 20 Microphones (page 63)                          | 35 [SET] button (page 28)                           |
| 7 Speaker   | 21 Monitor screen<br>(pages 146, 165)             | 36 [DISP] button<br>(page 146)                      |
| 8 External flash shoe<br>(page 93)                | 22 Viewfinder<br>(pages 18, 137)                  | 37 [EVF/LCD] button<br>(page 146)                   |
| 9 Flash (LED light/Flash)<br>(pages 31, 39)       | 23 Strap ring (page 11)                           |   |
| 10 Terminal cover<br>(page 159)                   | 24 Diopter dial (page 18)                         |   |
| 11 [DC IN 9V] AC adaptor<br>connector (page 159)  | 25 Back lamp<br>(pages 18, 24, 32)                |   |
| 12 [HDMI OUT] HDMI<br>output (Mini) (page 104)    | 26 [▶] (PLAY) button<br>(pages 21, 24)            |   |
| 13 [USB/AV] port<br>(pages 102, 117, 124,<br>130) | 27 [RECORD] (REC) button<br>(pages 18, 24)        |   |
| 14 [MIC] External<br>microphone jack<br>(page 63) | 28 [●] (movie) button<br>(page 62)                |   |
|   | 29 Movie mode switch<br>(pages 62, 64)            |   |
|   |   |   |

## Bottom

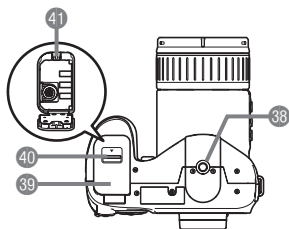

- 38 Tripod hole  
Use this hole when attaching to a tripod.
- 39 Battery cover (pages 13, 158)
- 40 Lock (page 13)
- 41 Battery compartment (pages 13, 158)

## ■ Charger Unit

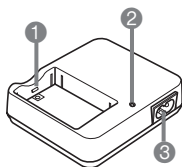

- 1 [⊕ ⊖] Contacts
- 2 [CHARGE] Lamp
- 3 AC jack

## Monitor Screen Contents

The monitor screen uses various indicators, icons, and values to keep you informed of the camera's status.

- The sample screens in this section are intended to show you the locations of all the indicators and figures that can appear on the monitor screen in various modes. They do not represent screens that actually appear on the camera.

### ■ Snapshot Recording

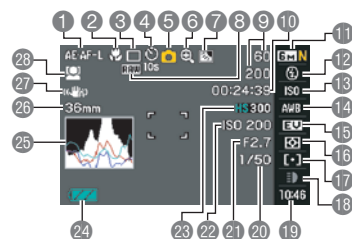

- 1 AE/AF Lock (page 45)
- 2 Focus mode (page 43)
- 3 Continuous Shutter mode (page 46)
- 4 Self-timer mode (page 79)
- 5 Recording mode (page 25)
- 6 Image deterioration indicator (page 41)
- 7 Back lighting correction (page 45)
- 8 RAW image data save indicator (page 30)
- 9 Number of recordable CS images (pages 50, 72)  
Remaining snapshot memory capacity (pages 50, 72)
- 10 Remaining movie memory capacity (page 62)
- 11 Snapshot image size/Quality (pages 29, 87)
- 12 Flash mode (page 31)
- 13 ISO sensitivity (page 34)
- 14 White balance setting (page 34)
- 15 Exposure compensation (page 36)
- 16 Metering mode (page 37)
- 17 AF area (page 37)
- 18 REC light (Single Shot mode) (page 39)  
Continuous shutter (CS) speed (High-speed CS, Prerecord (Still image), Flash CS modes) (pages 48, 50, 52)  
Bracketing mode (Bracketing mode) (page 54)  
View speed (Slow Motion View mode) (page 53)
- 19 Date/Time (page 39)  
Prerecord (Still image) Time (Prerecord (Still image) mode) (page 50)  
Flash continuous shutter (CS) images (Flash CS mode) (page 49)
- 20 Shutter speed (page 26)
- 21 Aperture value (page 25)
- 22 ISO sensitivity (page 34)
- 23 Movie image quality (pages 64, 87)
- 24 Battery level indicator (page 14)
- 25 Histogram (page 147)
- 26 Focal distance (Converted to 35mm film format.) (page 41)
- 27 Anti Shake (page 81)
- 28 Face Detection (page 82)

### NOTE

- If the current aperture, shutter speed, ISO sensitivity, or Auto Exposure is not correct, the setting will turn orange when you half-press the shutter button.

## ■ Movie Recording



- ① Recording mode (page 62)
- ② Remaining movie memory capacity (page 178)
- ③ Movie recording time (page 62)
- ④ Indicates movie recording in progress (page 62)
- ⑤ Remaining snapshot memory capacity during movie recording (page 66)

## ■ Snapshot Viewing

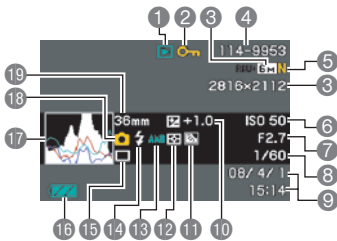

- ① File type
- ② Protect indicator (page 112)
- ③ Snapshot image size (page 29)
- ④ Folder name/file name (page 134)
- ⑤ Snapshot image quality (page 87)
- ⑥ ISO sensitivity (page 34)
- ⑦ Aperture value (page 25)
- ⑧ Shutter speed (page 26)
- ⑨ Date/time (page 141)
- ⑩ Exposure compensation (page 36)
- ⑪ Back lighting correction (page 45)  
Dynamic range correction (page 88)
- ⑫ Metering mode (page 37)
- ⑬ White balance setting (page 34)
- ⑭ Flash mode (page 31)
- ⑮ Continuous Shutter mode (page 46)
- ⑯ Battery level indicator (page 14)
- ⑰ Histogram (page 147)
- ⑱ Recording mode
- ⑲ Focal distance (Converted to 35mm film format.) (page 41)

## ■ Movie Playback

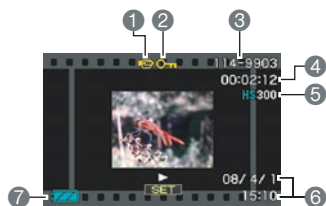

- 1 File type
- 2 Protect indicator (page 112)
- 3 Folder name/file name (page 134)
- 4 Movie recording time (page 96)
- 5 Movie Mode/Quality/Speed (pages 64, 87, 88)
- 6 Date/time (page 141)
- 7 Battery level indicator (page 14)

\* Not displayed during high-speed movie recording while  (Auto) is selected as the REC mode.

## ■ CS Image Viewing

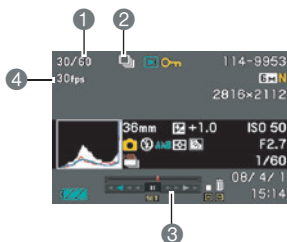

- 1 Current image number/number of images in the group (page 97)
- 2 CS group icon (page 97)
- 3 Playback guide (page 97)
- 4 CS speed (page 97)

## Reset Initial Default Settings

The tables in this section show the initial default settings that are configured for menu items (displayed when you press [MENU]) after you reset the camera (page 145).

Menu items depend on whether the camera is in the REC mode or PLAY mode.

- A dash (–) indicates an item whose setting is not reset or an item for which there is no reset setting.



### ■ REC Mode

#### “REC” Tab

Self-timer	Off
AF Assist Light	On
Anti Shake	 Camera As
Face Detection	Off
Continuous AF	Off
AE/AF Lock	AE Lock
AE Bracketing	3
WB Bracketing	3
Focus Bracketing	3
Ring Setup	Off
Save CS Images	Always Ask

Digital Zoom	Off
Quick Shutter	Off
Review	On
Grid	Off
Memory	Flash: On Self-timer: Off Flash Intensity: Off Digital Zoom: On MF Position: Off Zoom Position: Off

#### “Quality” Tab

 Quality (Snapshots)	Normal
HD  Quality (Movies)	FHD
HS  Speed	300fps
Dynamic Range	Off
Flash Intensity	0

Flash Assist	Auto
Color Filter	Off
Sharpness	0
Saturation	0
Contrast	0



## “Set Up” Tab

<b>Screen</b>	Auto 2
<b>EVF Brightness</b>	0
<b>Sounds</b>	–
<b>File No.</b>	Continue
<b>World Time</b>	Home
<b>Timestamp</b>	Off
<b>Adjust</b>	–
<b>Date Style</b>	–
<b>Language</b>	–

<b>Sleep</b>	1 min
<b>Auto Power Off</b>	5 min
<b>REC/PLAY</b>	Power On
<b>LCD Priority</b>	Off
<b>USB</b>	Mass Storage
<b>Video Out</b>	NTSC 4:3
<b>HDMI Output</b>	Auto
<b>Format</b>	–
<b>Reset</b>	–

## ■ PLAY Mode

### “PLAY” Tab

<b>Slideshow</b>	–
<b>MOTION PRINT</b>	9 frames
<b>Movie Editing</b>	–
<b>White Balance</b>	–
<b>Brightness</b>	–
<b>DPOF Printing</b>	–
<b>Protect</b>	–

<b>Rotation</b>	–
<b>Resize</b>	3M (2048×1536)
<b>Trimming</b>	–
<b>Copy</b>	–
<b>Divide Group</b>	–
<b>Display Layout</b>	Wide
<b>Select Frame</b>	–









## “Set Up” Tab

- The contents of the “Set Up” tab are the same in the REC mode and PLAY mode.

## When things don't go right...

### Troubleshooting

Problem	Possible Cause and Recommended Action
<b>Power Supply</b>	
Power does not turn on.	<ol style="list-style-type: none"><li>1)The battery may not be loaded correctly (page 13).</li><li>2)The battery may be dead. Charge the battery (page 11). If the battery goes dead soon after being charged, it means the battery has reached the end of its life and needs to be replaced. Purchase a separately available CASIO NP-100 rechargeable lithium ion battery.</li></ol>
The camera suddenly powers down.	<ol style="list-style-type: none"><li>1)Auto Power Off may have activated (page 142). Turn power back on.</li><li>2)The battery may be dead. Charge the battery (page 11).</li><li>3)The camera's protection function may have activated because camera temperature is too high. Turn off the camera and wait until it cools down before trying to use it again.</li></ol>
Power will not turn off. Nothing happens when a button is pressed.	Remove the battery from the camera and then reload it.
<b>Image Recording</b>	
Image is not recorded when the shutter button is pressed.	<ol style="list-style-type: none"><li>1)If the camera is in the PLAY mode, press <b>[RECORD]</b> (REC) to enter the REC Mode.</li><li>2)If the flash is charging, wait until the charge operation finishes.</li><li>3)If the message "Memory Full" appears, transfer images to your computer, delete images you no longer need, or use a different memory card.</li></ol>
Auto Focus does not focus properly	<ol style="list-style-type: none"><li>1)If the lens is dirty, clean it off.</li><li>2)The subject may not be in the center of the focus frame when you compose the image.</li><li>3)The subject you are shooting may not be a type that is compatible with Auto Focus (page 23). Use manual focus (page 43).</li><li>4)You may be moving the camera when shooting. Try shooting with Anti Shake or use a tripod.</li><li>5)You may be pressing the shutter button all the way without waiting for Auto Focus. Half-press the shutter button and allow enough time for Auto Focus to focus.</li></ol>
The subject is out of focus in the recorded image.	The image may not be focused properly. When composing the image, make sure the subject is located inside the focus frame.

Problem	Possible Cause and Recommended Action
The flash does not fire.	1) If  (Flash Off) is selected as the flash mode, change to another mode (page 31). 2) If the battery is dead, charge it (page 11). 3) If a BEST SHOT scene that uses  (Flash Off) is selected, change to a different flash mode (page 31) or select a different BEST SHOT scene (page 67).
Camera powers down during Self-timer countdown.	The battery may be dead. Charge the battery (page 11).
The monitor screen image is out of focus.	1) You may be using Manual Focus and have not focused the image. Focus the image (page 43). 2) You may be using  (Macro Mode) for scenery or portraits. Use Auto Focus for scenery and portrait shots (page 43). 3) You may be trying to use Auto Focus or  (Infinity Mode) when shooting a close-up shot. Use the  (Macro Mode) for close ups (page 43).
There is digital noise in images.	1) Sensitivity may have been increased automatically for a dark subject, which increases the chance of digital noise. Use a light or some other means to illuminate the subject. 2) You may be attempting to shoot in a dark location with  (Flash Off) selected, which can increase digital noise and make images appear coarse. In this case, turn on flash (page 31) or use lights for illumination. 3) Flash assist or dynamic range may be enabled for snapshots, which can cause an increase in digital noise. Use a light or some other means to illuminate the subject.
A recorded image was not saved.	1) Camera power may have been turned off before the save operation was complete, which will result in the image not being saved. If the battery indicator shows  , charge the battery as soon as possible (page 11). 2) You may have removed the memory card from the camera before the save operation was complete, which will result in the image not being saved. Do not remove the memory card before the save operation is complete.
Though available lighting is bright, the faces of people in the image are dark.	Not enough light is reaching the subjects. Change the flash mode setting to  (Flash On) for daylight synchro flash (page 31), or adjust EV shift to the + side (page 36).
Subjects are too dark when shooting images in a seashore or ski area.	Sunlight reflected by water, sand, or snow, can cause underexposure of images. Change the flash mode setting to  (Flash On) for daylight synchro flash (page 31), or adjust EV shift to the + side (page 36).

Problem	Possible Cause and Recommended Action
Digital zoom (including HD zoom) does not work. The zoom bar indicates zoom only up to a zoom factor of 12.	The digital zoom setting may be turned off. Turn on digital zoom (page 84).
The image is out of focus during movie recording.	1)Focusing may not be possible because the subject is outside the focus range. Shoot within the allowable range. 2)The lens may be dirty. Clean the lens (page 154).
<b>Playback</b>	
The color of the playback image is different from what appears on the monitor screen when shooting.	Sunlight or light from another source may be shining directly into the lens when you are shooting. Position the camera so sunlight does not shine directly into the lens.
Images are not displayed.	This camera cannot display non-DCF images recorded onto a memory card using another digital camera.
Images cannot be edited (with resizing, trimming, rotation).	Note that you cannot edit the following types of snapshots. <ul style="list-style-type: none"> <li>• Snapshots created using MOTION PRINT</li> <li>• CS group snapshots</li> <li>• Movies</li> <li>• Snapshots recorded with another camera</li> </ul>

Problem	Possible Cause and Recommended Action
<b>Other</b>	
The wrong date and time are displayed.	The date and time setting is off. Set the correct date and time (page 140).
The messages on the display are in the wrong language.	The wrong display language is selected. Change the display language setting (page 141).
Images cannot be transferred over a USB connection.	<ol style="list-style-type: none"> <li>1)The USB cable may not be connected securely. Check all connections.</li> <li>2)The wrong USB communication protocol is selected. Select the correct USB communication protocol in accordance with the type of device you are connecting (pages 124, 130).</li> <li>3)If the camera is not turned on, turn it on.</li> </ol>
Language selection screen appears when the camera is turned on.	<ol style="list-style-type: none"> <li>1)You did not configure initial settings after purchasing the camera or the battery may have been left with a dead battery. Check the camera setup (pages 15, 141).</li> <li>2)There may be a problem with the camera's memory data. If this is the case, perform the reset operation to initialize the camera's setup (page 145). After that, configure each setting. If the language selection screen does not re-appear when you turn the camera on, it means that the camera's memory management data has been restored. If the same message appears after you turn power back on, contact your retailer or a CASIO authorized service center.</li> </ol>

## Display Messages

<b>ALERT</b>	The camera's protection function may have activated because camera temperature is too high. Turn off the camera and wait until it cools down before trying to use it again.
<b>Battery is low.</b>	Battery power is low.
<b>Camera not in standby. Re-frame the image.</b>	Move Out CS or Move In CS framing could not be performed for some reason, and so the camera cannot go into auto record standby. Perform the framing operation again (page 72).
<b>Cannot find the file.</b>	The image you specified with the slideshow "Images" setting cannot be found. Change the "Images" setting (page 106) and try again.
<b>Cannot register any more files.</b>	You are attempting to save a user BEST SHOT scene in the "SCENE" folder when the folder already contains 999 user scenes.
<b>Card ERROR</b>	<p>There is something wrong with the memory card. Turn off the camera, remove the memory card and then reload it into the camera. If this message re-appears when you turn the camera back on, format the memory card (page 145).</p> <p> <b>IMPORTANT!</b></p> <ul style="list-style-type: none"><li>• Formatting a memory card deletes all its files. Before formatting, try transferring recoverable files to a computer or some other storage device.</li></ul>
<b>Check connections!</b>	You are attempting to connect the camera to a printer while the camera's USB settings are not compatible with the USB system of the printer (page 117).
<b>Files could not be saved because battery is low.</b>	Battery power is low, so an image file could not be saved.
<b>Flash cool down...</b>	The flash is disabled for a short while to protect the flash unit after consecutive operations during Flash CS. You will be able to resume using the flash after this message disappears.
<b>Folder cannot be created.</b>	You are trying to record a file while there are already 9999 files stored in the 999th folder. If you want to record more, delete files you no longer need (page 22).

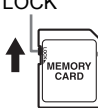
<b>LED flash cool down...</b>	The flash is disabled for a short while to protect the flash unit after consecutive operations during Flash CS. You will be able to resume using the flash after this message disappears.
<b>LENS ERROR</b>	This message appears and the camera turns off whenever lens performs some unexpected operation. If the same message appears after you turn power back on, contact a CASIO authorized service center or your original retailer.
<b>LENS ERROR 2</b>	The Anti Shake unit of the camera may be malfunctioning. If the same message appears after you turn power back on, contact your retailer or a CASIO service center.
<b>Load paper!</b>	The printer ran out of paper while printing.
<b>Memory Full</b>	Memory is full with images you recorded and/or files saved by editing operations. When shooting with Prerecord (Still image), this message indicates that there is not enough memory capacity to record all of the pre-recorded images. Delete files you no longer need (page 22).
<b>Printing Error</b>	An error occurred while printing. <ul style="list-style-type: none"> <li>• The printer is turned off.</li> <li>• The printer generated an error, etc.</li> </ul>
<b>Record Error</b>	Image compression could not be performed for some reason during image data storage. Shoot the image again.
<b>SYSTEM ERROR</b>	Your camera system is corrupted. Contact your retailer or an authorized CASIO authorized service center.
<b>The card is locked.</b>	The LOCK switch of the SD or SDHC memory card loaded in the camera is in the locked position. You cannot store images to or delete images from a memory card that is locked. <div style="float: right; text-align: center;"> <p>LOCK</p>  </div>
<b>There are no files.</b>	There are no files in built-in memory or on the memory card.
<b>There are no printing images. Set up DPOF.</b>	There are currently no files specified for printing. Configure the required DPOF settings (page 119).
<b>There is no image to register.</b>	The setup you are trying to save is for an image that cannot be saved as a user BEST SHOT scene.
<b>This card is not formatted.</b>	The memory card loaded in the camera is not formatted. Format the memory card (page 145).

<b>This file cannot be played.</b>	The file you are trying to access is corrupted or is a type that cannot be displayed by this camera.
<b>This function cannot be used.</b>	<ul style="list-style-type: none"><li>• You attempted to copy images from built-in memory to a memory card while there is no memory card loaded in the camera (page 114).</li><li>• You attempted to divide up a CS group while a file that is not a CS group is displayed (page 99).</li></ul>



## Number of Snapshots and Movie Recording Time

### Snapshot

Image Size (Pixels)	Image Quality	Approximate Image File Size	Built-in Memory (31.9MB) Capacity	SD Memory Card (1GB) Capacity
RAW+ (6M: 2816×2112)*1	Fine	13.34 MB	2 shots	72 shots
	Normal	11.75 MB	2 shots	82 shots
	Economy	11.16 MB	2 shots	86 shots
6M (2816×2112)	Fine	3.48 MB	9 shots	277 shots
	Normal	1.89 MB	17 shots	511 shots
	Economy	1.3 MB	25 shots	743 shots
3:2 (2816×1872)	Fine	3.02 MB	10 shots	320 shots
	Normal	1.66 MB	19 shots	582 shots
	Economy	1.14 MB	28 shots	848 shots
16:9 (2816×1584)	Fine	2.78 MB	11 shots	347 shots
	Normal	1.54 MB	21 shots	628 shots
	Economy	1.02 MB	31 shots	948 shots
4M (2304×1728)	Fine	2.5 MB	13 shots	386 shots
	Normal	1.4 MB	23 shots	690 shots
	Economy	900 KB	36 shots	1074 shots
3M (2048×1536)	Fine	2.0 MB	16 shots	483 shots
	Normal	1.15 MB	28 shots	841 shots
	Economy	720 KB	45 shots	1343 shots
2M (1600×1200)	Fine	1.26 MB	25 shots	767 shots
	Normal	790 KB	41 shots	1224 shots
	Economy	470 KB	69 shots	2057 shots
VGA (640×480)	Fine	330 KB	98 shots	2930 shots
	Normal	190 KB	171 shots	5090 shots
	Economy	140 KB	232 shots	6908 shots

## Movies

Movie Mode	Image Quality (Pixels) / (Audio)	Maximum File Size	Built-in Memory (31.9MB) Capacity	SD Memory Card (1GB) Capacity
HD	FHD 1920×1080 (Stereo)	Maximum Movie Size: 4GB	18 seconds	9 minutes 11 seconds
	HD 1280×720 (Stereo)		31 seconds	15 minutes 48 seconds
HS	1200 fps 336×96 (No audio)		14 seconds	7 minutes 18 seconds
	600 fps 432×192 (No audio)		14 seconds	7 minutes 19 seconds
	300 fps 512×384 (No audio)		14 seconds	7 minutes 19 seconds
	30-300 fps 512×384 (No audio)		2 minutes 27 seconds* <sup>2</sup>	1 hour 13 minutes 16 seconds* <sup>2</sup>
STD	Fixed 640×480 (Stereo)		1 minute 30 seconds	44 minutes 39 seconds

Movie Mode	Image Quality (Pixels) / (Audio)	Maximum File Size	Built-in Memory (31.9MB) Capacity	SD Memory Card (Maximum recording time per recording)
YouTube Capture Mode*3	YouTube (HS600) 432×192 (No audio)	Maximum Movie Size: 100MB (or 10 minutes)	14 seconds	30 seconds
	YouTube (HS300) 512×384 (No audio)		14 seconds	45 seconds
	YouTube (HS30-300) 512×384 (No audio)		2 minutes 27 seconds*2	7 minutes 41 seconds*2
	YouTube (STD) 640×480 (Stereo)		1 minute 30 seconds	4 minutes 41 seconds

- The number of image values are approximate and are provided for reference only. The actual number of images you may be able to record may be less than that indicated on the monitor screen.
- Image files sizes are approximate and are provided for reference only. Actual image file sizes vary depending on subject type.
- The above values are based on use of a Panasonic PRO HIGH SPEED SD memory card. The number of images you can save depends on the type of memory card you are using.
- When using a memory card with a different capacity, calculate the number of images as a percentage of 1GB.
- The time it takes to play back a high-speed movie will be different from the time it takes to record it. If you record a 300 fps high-speed movie for 10 seconds, for example, it will take 100 seconds to play it back.
- The following are the maximum file sizes when shooting with "Prerecord (Movie)" at a high speed of 600 fps or 1200 fps.  
600 fps : 2 GB  
1200 fps : 1GB

\*1 RAW+ is the total file size of the RAW file and 6M (2816×2112) JPEG file. The image quality setting applies to the JPEG file only.

\*2 Recordable time when the entire movie is recorded at 30 fps. Recording time is shorter if the 30 fps frame rate is switched to 300 fps during recording.

\*3 Shooting with "For YouTube" is not possible while "HD" is selected as the movie mode or while "1200 fps" is selected for high-speed movie.

## Specifications

<b>Product Type</b>	Digital Camera
<b>Model</b>	EX-F1
<b>File Format</b>	Snapshots: RAW (DNG), JPEG (Exif Version 2.2); DCF 1.0 standard; DPOF compliant * DNG file format is one type of RAW image file, and it is recommended by Adobe Systems for use as a standard image file format. Movies: MOV format, H.264/AVC standard, IMA-ADPCM (Stereo)
<b>Recording Media</b>	Built-in Memory (Image Storage Area: 31.9MB) SD/SDHC/MMC/MMC <i>plus</i>
<b>Recorded Image Sizes</b>	Snapshots: RAW, 6M (2816×2112), 3:2 (2816×1872), 16:9 (2816×1584), 4M (2304×1728), 3M (2048×1536), 2M (1600×1200), VGA (640×480) Movies: FHD (1920×1080 60 fields/s), HD (1280×720 30 fps), HS1200 (336×96 1200 fps), HS600 (432×192 600 fps), HS300 (512×384 300 fps), HS30-300 (512×384 30 fps/300 fps switchable), STD (640×480 30 fps)
<b>Delete</b>	1 file; all files CS group, Individual images within a CS group (with memory protection feature)
<b>Effective Pixels</b>	6.0 Megapixels
<b>Imaging Element</b>	Size: 1/1.8-inch square pixel high-speed CMOS Total Pixels: 6.6 Megapixels
<b>Lens/Focal Distance (Snapshot)</b>	F2.7 (W) to 4.6 (T) f= 7.3 to 87.6 mm (equivalent to 36 to 432 mm in 35 mm format) 12 lenses in 9 groups, including aspherical lens.
<b>Zoom</b>	12X optical zoom, 4X digital zoom (48X in combination with optical zoom) 52.1X maximum HD Zoom (in combination with optical zoom, VGA size)
<b>Focusing</b>	Contrast Detection Auto Focus • Focus Modes: Auto Focus, Macro Focus, Infinity Mode, Manual Focus • AF Area: Spot, Free, Tracking; with AF assist lamp
<b>Approximate Focus Range (Snapshot) (From Lens Surface)</b>	Auto Focus: 40 cm to $\infty$ (1.3' to $\infty$ ) (Wide Angle) Macro Focus: 5 cm to 50 cm (2.0" to 19.7") (Wide Angle) Infinity: $\infty$ Manual Focus: 5 cm to $\infty$ (2.0" to $\infty$ ) (Wide Angle) * Range is affected by optical zoom.
<b>Metering</b>	Multi-pattern, center weighted, and spot by imaging element

<b>Exposure Control</b>	Program AE, Aperture Priority AE, Shutter Speed Priority AE, Manual Exposure
<b>Exposure Compensation</b>	-2.0 EV to +2.0 EV (in 1/3EV steps)
<b>Shutter</b>	CMOS electronic shutter, mechanical shutter
<b>Shutter Speed</b>	Snapshot (Auto): 1 to 1/2000 second Snapshot (Aperture Priority AE): 1 to 1/2000 second Snapshot (Shutter Speed Priority AE): 60 to 1/40000 second Snapshot (Manual Exposure): 60 to 1/40000 second * 1/1250 to 1/40000 using CMOS electronic shutter when shooting with shutter speed priority AE or Manual exposure. * May differ due to the camera setup.
<b>Aperture Value</b>	F2.7 (W) to F15 (W); ND filter used, auto switching; aperture changed by optical zoom or recording mode Aperture Priority AE; Manual Exposure: F2.7(W) to F7.5 (W)
<b>White Balance</b>	Auto, Daylight, Overcast, Shade, Day White Fluorescent, Daylight Fluorescent, Tungsten, Manual WB
<b>Sensitivity (Standard Output Sensitivity)</b>	Snapshots: Auto, ISO 100, ISO 200, ISO 400, ISO 800, ISO 1600 equivalent Movies: Auto (Hi-Speed Movie when Manual Exposure mode: ISO 100, ISO 200, ISO 400, ISO 800, ISO 1600)
<b>Self-timer</b>	Approximate Trigger Times: 10 seconds, 2 seconds, Triple Self-timer (Trigger time setting depends on CS mode being used.)
<b>Flash Modes</b>	Auto, Off, On, Red-eye reduction, External flash
<b>Flash Range (ISO Sensitivity: Auto)</b>	Normal: 0.5 m to 6.7 m (1.6' to 22.0') (Wide Angle) 1.1 m to 3.9 m (3.6' to 12.8') (Telephoto) Flash Continuous Shutter: 0.5 m to 3.1 m (1.6' to 10.2') (Wide Angle) 1.1 m to 1.8 m (3.6' to 5.9') (Telephoto) * Range is affected by optical zoom.
<b>Flash Intensity Adjustment</b>	-2.0 EV to +2.0 EV (in 1/3EV steps)
<b>Flash Charging Time</b>	Approximately 9 seconds maximum
<b>Movie Recording Minimum Illumination</b>	18 lx (STD movie)
<b>Recording</b>	Snapshot, High Speed Continuous shutter, Prerecord (still image), Flash Continuous shutter, Slow Motion View, Auto Bracketing, BEST SHOT, Face detection, High Speed Movie (no audio), HD Movie, STD Movie, YouTube Capture Mode
<b>Monitor Screen</b>	2.8-inch wide TFT color LCD 230,160 dots (959×240)
<b>Viewfinder</b>	LCD monitor/Electronic View Finder (0.2-inch, Equal to 201,600 dots)

<b>Timekeeping Functions</b>	Built-in quartz digital clock Date and Time: Recorded with image data With time stamp function Auto Calendar: To 2049
<b>World Time</b>	162 cities in 32 time zones City name, date, time, summer time
<b>Input/Output Terminals</b>	USB/AV port, Hi-Speed USB compatible HDMI output (Mini) External microphone jack (Plug-in power supported) Hot shoe AC adaptor connector (DC-IN)
<b>Microphones</b>	Stereo
<b>Speaker</b>	Monaural
<b>Power Requirements</b>	Rechargeable lithium ion battery (NP-100) ×1 AC adaptor (AD-C100) (optional accessory)

## Approximate Battery Life

All of the values provided below represent the approximate amount of time under normal temperature (23°C (73°F)) before the camera turns off. These values are not guaranteed. Low temperatures shorten battery life.

<b>Number of Shots (CIPA) (Operating Time)*1</b>	520 shots
<b>Continuous Playback (Snapshots)*2</b>	8 hours
<b>Approximate continuous movie recording time</b>	3 hours 30 minutes

- Battery: NP-100 (Rated Capacity: 1950mAh)
- Recording Medium: 1GB SD memory card (Panasonic brand PRO HIGH SPEED)
- Measurement Conditions

\*1 Approximate number of shots (CIPA) (Operating Time)

In accordance with CIPA standards

Normal temperature (23°C (73°F)), monitor on, zoom operation between full wide and full telephoto every 30 seconds, during which two images are shot with flash; power turned off and back on every time 10 images are shot.

\*2 Approximate playback time

Standard temperature (23°C (73°F)), one-image scroll approximately every 10 seconds

- The above values are based a new battery, starting from a full charge. Repeated charging shortens battery life.
- Frequency of flash, zoom, High-speed Continuous Shutter, and Auto Focus usage, and the time the camera is on greatly affects recording time and number of shots values.

---

<b>Power Consumption</b>	7.4 V DC, Approximately 9 W
<b>Dimensions</b>	127.7 (W) × 79.6 (H) × 130.1 (D) mm (5.0" (W) × 3.1" (H) × 5.1" (D))
<b>Weight</b>	Approximately 671 g (23.7 oz) (excluding battery and bundled accessories)

---

## ■ Rechargeable lithium ion battery (NP-100)

<b>Rated Voltage</b>	7.4 V
<b>Rated Capacitance</b>	1950 mAh
<b>Operating Temperature</b>	0 to 40°C (32 to 104°F)
<b>Dimensions</b>	36.2 (W) × 53.6 (H) × 23.3 (D) mm (1.4" (W) × 2.1" (H) × 0.9" (D))
<b>Weight</b>	Approximately 85 g (3.0 oz)

## ■ Charger unit (BC-100L)

<b>Input Power</b>	100 to 240 V AC, 200 mA, 50/60 Hz
<b>Output Power</b>	8.4 V DC, 560 mA
<b>Operating Temperature</b>	5 to 35°C (41 to 95°F)
<b>Supported Battery Type</b>	Rechargeable lithium ion battery (NP-100)
<b>Charging Time</b>	4 hours 30 minutes
<b>Dimensions</b>	94 (W) × 26 (H) × 80 (D) mm (3.7" (W) × 1.0" (H) × 3.1" (D)) (excluding projections)
<b>Weight</b>	Approximately 112 g (4.0 oz)

- Power cord precautions for use in Singapore  
The power cord set is not supplied. The power cord used must comply with relevant national and/or international standards.



**CASIO®**

**CASIO COMPUTER CO.,LTD.**  
6-2, Hon-machi 1-chome  
Shibuya-ku, Tokyo 151-8543, Japan

## ERRATA

- User's Guide Page 178, table  
Incorrect : Maximum Movie Size: 4GB  
Correct : Maximum Movie Size: 4GB  
\* Note that when "HD" or "FHD" is selected for the HD movie quality setting, the maximum recording time per movie is 29 minutes.

## BERICHTIGUNG

- Bedienungsanleitung Seite 178, Tabelle  
Falsch : Max. Movie-größe: 4 GB  
Richtig : Max. Moviegröße: 4 GB  
\* Bitte beachten Sie, dass die maximale Aufnahmezeit pro Movie 29 Minuten beträgt, wenn als Einstellung für die HD-Movie-Qualität „HD“ oder „FHD“ gewählt ist.

## ERRATA

- Mode d'emploi Page 178, tableau  
Inexact : Taille maximale de la séquence vidéo : 4 Go  
Exact : Taille maximale de la séquence vidéo : 4 Go  
\* Notez que lorsque « HD » ou « FHD » est sélectionné comme qualité d'image pour une séquence vidéo HD, le temps d'enregistrement maximal de chaque séquence vidéo est de 29 minutes.

## ERRATA

- Guía del usuario Página 178, tabla  
Incorrecto : Tamaño máximo de película: 4 GB  
Correcto : Tamaño máximo de película: 4 GB  
\* Tenga en cuenta que cuando se selecciona "HD" o "FHD" para el ajuste de calidad de las películas HD, el tiempo máximo de grabación por película será de 29 minutos.

## ERRATA CORRIGE

- Tabella a pagina 178 della Guida dell'utilizzatore  
Errato : Dimensione massima filmato: 4 GB  
Corretto : Dimensione massima filmato: 4 GB  
\* Notare che quando è selezionato "HD" o "FHD" per l'impostazione di qualità dei filmati HD, il tempo massimo di registrazione per un filmato è di 29 minuti.

## ERRATA

- Gebruiksaanwijzing pagina 178, tabel  
Incorrect : Maximale Filmgrootte: 4GB  
Correct : Maximale Filmgrootte: 4GB  
\* Merk op dat wanneer "HD" of "FHD" geselecteerd wordt voor de instelling van de HD filmkwaliteit, de maximale opnametijd per film 29 minuten is.

## RÄTTELSE

- Tabell på sidan 178 i bruksanvisningen  
Fel : Maximal filmstorlek: 4 GB  
Korrekt : Maximal filmstorlek: 4 GB  
\* Notera att om "HD" eller "FHD" är valt som inställning av bildkvalitet för HD-film, så är maximal inspelningstid per film 29 minuter.

## ERRATA

- Side 178 i Brukerveiledning, tabell  
Feil : Maksimum videostørrelse: 4 GB  
Korrekt : Maksimal videostørrelse: 4 GB  
\* Vær oppmerksom på at den maksimale opptakstiden er 29 minutter når "HD" eller "FHD" er valgte videokvalitetsinnstilling.

## ERRATA

- Brugermanual side 178, tabel  
Forkert : Maksimal filmstørrelse: 4 GB  
Korrekt : Maksimal filmstørrelse: 4 GB  
\* Bemærk, at når "HD" eller "FHD" er valgt som kvalitetsindstilling for HD-film, er den maksimale optagetid pr. film 29 minutter.



## Free Manuals Download Website

<http://myh66.com>

<http://usermanuals.us>

<http://www.somanuals.com>

<http://www.4manuals.cc>

<http://www.manual-lib.com>

<http://www.404manual.com>

<http://www.luxmanual.com>

<http://aubethermostatmanual.com>

Golf course search by state

<http://golfingnear.com>

Email search by domain

<http://emailbydomain.com>

Auto manuals search

<http://auto.somanuals.com>

TV manuals search

<http://tv.somanuals.com>