

CASIO®

Digital Camera

EX-ZR200

User's Guide

E

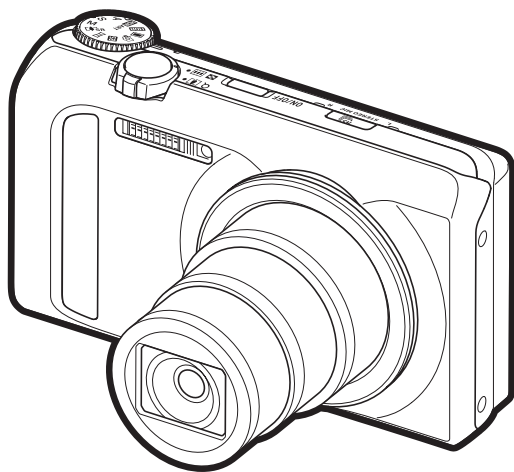

Thank you for purchasing this CASIO product.

- Before using it, be sure to read the precautions contained in this User's Guide.
- Keep the User's Guide in a safe place for future reference.
- For the most up-to-date information about this product, visit the official EXILIM Website at <http://www.exilim.com/>

EXILIM

Unpacking

As you unpack your camera, check to make sure that all items shown below are included. If anything is missing, contact your original retailer.



Digital camera



Rechargeable lithium ion battery (NP-130)

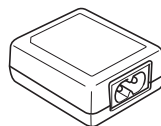

USB-AC adaptor (AD-C53U)

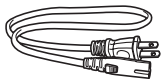

* The shape of the power cord plug varies according to country or geographic area.

Power cord



USB cable

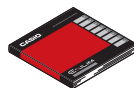

Basic Reference



Strap

To attach the strap to the camera

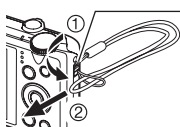

Attach strap here.

Read this first!

- The contents of this manual are subject to change without notice.
- The contents of this manual have been checked at each step of the production process. Feel free to contact us if you notice anything that is questionable, erroneous, etc.
- Any copying of the contents of this User's Guide, either in part or its entirety, is forbidden. Except for your own personal use, any other use of the contents of this manual without the permission of CASIO COMPUTER CO., LTD. is forbidden under copyright laws.
- CASIO COMPUTER CO., LTD. shall not be held liable for any damages or lost profits suffered by you or any third party due to the use or malfunction of this product.
- CASIO COMPUTER CO., LTD. shall not be held liable for any damages, lost profits, or claims by third parties arising out of the use of Photo Transport, Dynamic Photo Manager, or YouTube Uploader for CASIO.
- CASIO COMPUTER CO., LTD. shall not be held liable for any damages or lost profits caused by loss of memory contents due to malfunction, repair, or any other reason.
- Note that the example screens and product illustrations shown in this User's Guide may differ somewhat from the screens and configuration of the actual camera.

LCD Panel

The liquid crystal panel of the monitor screen uses high-precision technology that provides a pixel yield in excess of 99.99%. This means that some very small number of pixels may not light or may remain lit at all times. This is due to the characteristics of the liquid crystal panel, and does not indicate malfunction.

Take test shots

Before shooting your final image, shoot a test shot to ensure that the camera is recording correctly.

Contents

Unpacking	2
Read this first!	3
General Guide	9
Monitor Screen Contents	10
Turning Display Information On and Off	(Info) .. 12

■ Quick Start Basics 13

What is a digital camera?	13
What you can do with your CASIO camera	14
First, charge the battery prior to use	16
■ To load the battery	16
■ Charge the Battery	17
Configuring Basic Settings the First Time You Turn On the Camera	22
Preparing a Memory Card	23
■ Supported Memory Cards	23
■ To load a memory card	24
■ To format (initialize) a new memory card	25
Turning the Camera On and Off	26
■ To turn power on	26
■ To turn off the camera	26
Holding the Camera Correctly	27
To shoot a snapshot	28
■ Selecting an Auto Recording Mode	28
■ To shoot a snapshot	29
■ Recording Beautiful Portraits	(Make-up Function) .. 30
Viewing Snapshots	32
Deleting Snapshots and Movies	33
■ To delete a single file	33
■ To delete specific files	34
■ To delete all files	34
Snapshot Shooting Precautions	35
■ Auto Focus Restrictions	36

■ Snapshot Tutorial 37

Selecting the Recording Mode	37
Using the Control Panel	40
Changing the Image Size	(Size) .. 41
Specifying ISO Sensitivity	(ISO) .. 44
Adjusting White Balance	(White Balance) .. 45
Correcting Image Brightness	(EV Shift) .. 46
Using Flash	(Flash) .. 47
Changing the Control Panel Date/Time Style	49
Shooting with Zoom	49
■ Interpreting the Zoom Bar	50
■ Zooming with Super Resolution	(Zoom (SR)) .. 52

Using Continuous Shutter	53
■ Using High Speed CS and Prerecord CS	53
■ Continuous Shutter Precautions	57
Digitally Correcting for Overexposure and Underexposure	(HDR) .. 58
Shooting Snapshots Digitally Processed for Artistic Effect	(HDR Art) .. 59
■ To shoot a movie with HDR Art	(HDR Art Movie) ... 60
Expanding the Zoom Range to	
Shoot Clearer Snapshots	(Multi SR Zoom) .. 61
Shooting a Panorama Image	(Slide Panorama) .. 62

■ Recording Movies 64

To record a movie	64
■ Audio	65
Recording a High-definition Movie	67
Recording a High Speed Movie	67
Using Prerecord Movie	(Prerecord (Movie)) .. 69
Recording a Movie for YouTube	(For YouTube) .. 71
Shooting a Snapshot while Shooting a Movie	(Snapshot In Movie) .. 72

■ Using BEST SHOT 73

What is BEST SHOT?	73
■ Some Sample Scenes	73
To shoot with BEST SHOT	73
■ Creating Your Own BEST SHOT Setups	76
Shooting with a Blurred Background	(Blurred Background) .. 77
Shooting with a Super Wide Angle of View	(Wide Shot) .. 78
Shooting with High Speed Night Scene	(High Speed Night Scene/High Speed Night Scene and Portrait) .. 81
Shooting with High Speed Anti Shake	(High Speed Anti Shake) .. 82
Shooting with Priority on Subject Faces	(High Speed Best Selection) .. 83
Configuring the Camera to Help You	
Better Time Your Shots	(Lag Correction) .. 84
Using the Situation-specific CS Scenes	86
Using the Situation-specific High Speed Movie Scenes	88

■ Advanced Settings 89

Using On-screen Menus	89
REC Mode Settings	(REC) .. 91
■ Zooming with Super Resolution	(Zoom (SR)) ... 91
■ Selecting a Focus Mode	(Focus) ... 91
■ Using the Self-timer	(Self-timer) ... 94
■ Reducing the Effects of Camera and Subject Movement	(Anti Shake) ... 95
■ Specifying the Auto Focus Area	(AF Area) ... 96
■ Using the Auto Focus Assist Light	(AF Assist Light) ... 97
■ Shooting with Face Detection	(Face Detection) ... 97

■ Shooting with Continuous Auto Focus (Continuous AF)	98
■ Turning Digital Zoom On or Off (Digital Zoom)	99
■ Reducing Wind Noise during Movie Recording (Wind Noise Cut)	99
■ Assigning Functions to the [◀] and [▶] Keys (L/R Key)	99
■ Displaying the On-screen Grid (Grid)	100
■ Turning on Image Review (Review)	100
■ Using Icon Help (Icon Help)	100
■ Configuring Power On Default Settings (Memory)	101
Image Quality Settings (Quality)	102
■ Specifying Snapshot Image Quality (☐ Quality (Snapshot))	102
■ Movie Image Quality Settings (📽 Quality (Movie))	102
■ Specifying the Metering Mode (Metering)	103
■ Optimizing Image Brightness (Lighting)	103
■ Specifying Flash Intensity (Flash Intensity)	104
■ Using Built-in Color Filters (Color Filter)	104
■ Controlling Image Sharpness (Sharpness)	104
■ Controlling Color Saturation (Saturation)	104
■ Adjusting Image Contrast (Contrast)	104

■ Viewing Snapshots and Movies 105

Viewing Snapshots	105
Viewing a Movie	105
Viewing a Panorama Image	106
Viewing Continuous Shutter Images	107
■ Deleting Continuous Shutter Images	108
■ Dividing Up a CS Group	110
■ Copying a CS Group Image	111
Zooming an On-screen Image	112
Displaying the Image Menu	112
Viewing Snapshots and Movies on a TV Screen	113
■ Viewing High-quality Movies on a Hi-Vision Television	115

■ Other Playback Functions (PLAY) 117

Playing a Slideshow on the Camera (Slideshow)	117
■ Transferring Music from Your Computer to Camera Memory	119
Creating a Snapshot of Movie Frames (MOTION PRINT)	120
Editing a Movie on the Camera (Movie Editing)	120
Optimizing Image Brightness (Lighting)	122
Adjusting White Balance (White Balance)	122
Adjusting the Brightness of an Existing Snapshot (Brightness)	123
Selecting Images for Printing (DPOF Printing)	123
Protecting a File Against Deletion (Protect)	124
Editing the Date and Time of an Image (Date/Time)	126
Rotating an Image (Rotation)	127
Resizing a Snapshot (Resize)	127
Cropping a Snapshot (Trimming)	128
Copying Files (Copy)	128

Dividing Up a Continuous Shutter Group (Divide Group)	129
Combining CS Images into a Single Still Image (CS Multi Print)	129
Editing a CS Image (CS Frame Edit)	129

Dynamic Photo **130**

Inserting a Built-in Subject into a Snapshot or Movie . . . (Dynamic Photo)	130
■ To view a Dynamic Photo (Dynamic Photo File)	132
Converting a Dynamic Photo Still Image to a Movie . . . (Movie Converter)	132

Printing **133**

Printing Snapshots	133
Connecting Directly to a PictBridge Compatible Printer	133
Using DPOF to Specify Images to be Printed and the Number of Copies	136

Using the Camera with a Computer **141**

Things you can do using a computer.	141
Using the Camera with a Windows Computer	142
■ Viewing and Storing Images on a Computer	143
■ Playing Movies	147
■ Uploading Movie Files to YouTube	148
■ Transferring Images from Your Computer to Camera Memory	149
■ Play back Dynamic Photo images on your EXLIM, a computer, or on a mobile phone	151
■ User Registration	151
Using the Camera with a Macintosh	152
■ Connecting the Camera to Your Computer and Saving Files	152
■ Transferring Images Automatically and Managing Them on Your Macintosh	155
■ Playing a Movie	155
■ User Registration	155
Using an Eye-Fi Wireless SD Memory Card to Transfer Images . (Eye-Fi)	156
Files and Folders	157
Memory Card Data	158

Other Settings **(Set Up) 160**

Adjusting Monitor Screen Brightness (Screen)	160
Turning off Eye-Fi Card Communication (Eye-Fi)	160
Auto Image Orientation Detection and Rotation (Auto Rotate)	160
Configuring Camera Sound Settings (Sounds)	161
Specifying the File Name Serial Number Generation Rule (File No.)	161
Creating an Image Storage Folder (Create Folder)	162
Configuring World Time Settings (World Time)	162
Time Stamping Snapshots (Timestamp)	163
Setting the Camera's Clock (Adjust)	164
Specifying the Date Style (Date Style)	164

Specifying the Display Language	(Language) . 165
Configuring Sleep State Settings	(Sleep) . 165
Configuring Auto Power Off Settings	(Auto Power Off) . 166
Configuring [📷] and [▶] Settings	(REC/PLAY) . 166
Configuring USB Protocol Settings	(USB) . 167
Selecting the Screen Aspect Ratio and Video Output System	(Video Out) . 167
Selecting the HDMI Terminal Output Method	(HDMI Output) . 168
Configuring a Startup Image	(Startup) . 168
Formatting Built-in Memory or a Memory Card	(Format) . 169
Resetting the Camera to Factory Defaults	(Reset) . 169

Appendix

170

Precautions during Use	170
Power Supply	177
■ Charging	177
■ To replace the battery	178
■ Battery Precautions	178
■ Using the Camera in another Country	179
Using a Memory Card	180
■ To replace the memory card	180
Computer System Requirements for Software (For Windows)	182
Reset Initial Default Settings	183
Using the On-screen Histogram to Check Exposure	(+Histogram) . 185
■ How to Use the Histogram	186
When things don't go right... ..	187
■ Troubleshooting	187
■ Display Messages	192
Number of Snapshots/Movie Recording Time	194
Specifications	197

General Guide

The numbers in parentheses indicate the pages where each item is explained.

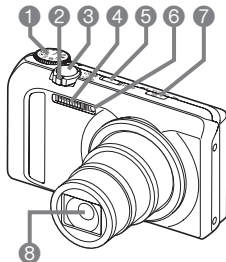

Front

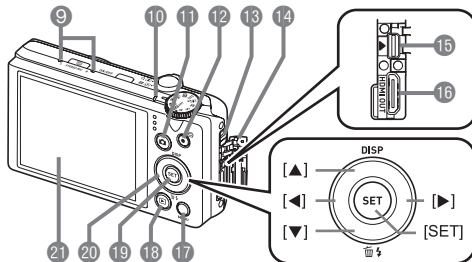

- 1 Mode dial (pages 28, 37)
- 2 Zoom controller (pages 29, 49, 112)
- 3 Shutter button (page 28)
- 4 Flash (page 47)
- 5 [ON/OFF] (Power) (page 26)
- 6 Front lamp (pages 94, 97)
- 7  (Continuous Shutter) (page 53)
- 8 Lens
- 9 Microphones (page 65)

Back

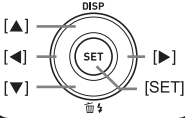

- 10 Back lamp (pages 26, 29, 47)
- 11  (REC) button (pages 26, 28)
- 12  (Movie) button (page 64)
- 13 Strap holes (page 2)
- 14 Terminal cover (pages 113, 115, 134, 144, 153)
- 15 [USB/AV] port (pages 113, 134, 144, 153)
- 16 [HDMI OUT] HDMI output (Mini) (page 115)
- 17 [MENU] button (page 89)
- 18  (PLAY) button (pages 26, 32)
- 19 [SET] button (page 40)
- 20 Control button () (pages 12, 33, 40, 47, 89)
- 21 Monitor screen (pages 10, 12)

Bottom

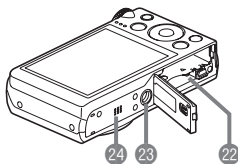

- 22 Battery/memory card slots (pages 16, 24, 178, 180)
- 23 Tripod hole
Use this hole when attaching to a tripod.
- 24 Speaker

Monitor Screen Contents

The monitor screen uses various indicators, icons, and values to keep you informed of the camera's status.

- The sample screens in this section are intended to show you the locations of all the indicators and figures that can appear on the monitor screen in various modes. They do not represent screens that actually appear on the camera.

■ Snapshot Recording

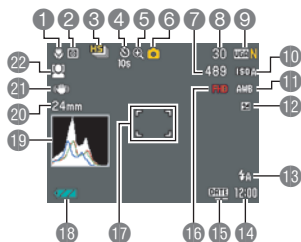

- 1 Focus mode (page 91)
- 2 Metering mode (page 103)
- 3 Continuous Shutter mode (page 53)
- 4 Self-timer mode (page 94)
- 5 Image deterioration indicator/ Zoom (SR) indicator (page 50)
- 6 Recording mode (page 28)
- 7 Remaining snapshot memory capacity (pages 55, 194)
- 8 Number of recordable CS images (page 55)
- 9 Snapshot image size/Quality (pages 41, 102)
- 10 ISO sensitivity (page 44)
- 11 White balance setting (page 45)
- 12 Exposure compensation (page 46)
- 13 Flash (page 47)
- 14 Date/Time (pages 22, 164)
- 15 Timestamp indicator (page 163)
- 16 Movie quality (FHD/STD movie) (pages 64, 67)/ Recording speed (high speed movie) (page 67)
- 17 Focus frame (pages 29, 96)
- 18 Battery level indicator (page 21)
- 19 Histogram (page 185)
- 20 Focal distance (Converted to 35 mm film format.)
- 21 Anti Shake (page 95)
- 22 Face Detection (page 97)

NOTE

- The semi-transparent gray frame on the monitor screen indicates the area that is recorded when shooting a movie. The area within the frame is recorded for a movie.
- The aperture, shutter speed, and ISO sensitivity values will turn orange when you half-press the shutter button if Auto Exposure is not correct.

■ Movie Recording

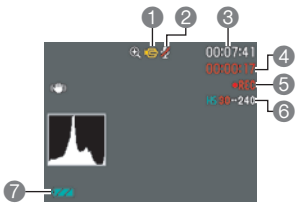

- 1 Recording mode (page 64)
- 2 Audio recording disabled (page 67)
- 3 Remaining movie memory capacity (page 64)
- 4 Movie recording time (page 64)
- 5 Movie recording in progress (page 64)
- 6 Movie quality (FHD/STD movie) (pages 64, 67)/
Recording speed (high speed movie) (page 67)
- 7 Battery level indicator (page 21)

■ Snapshot Viewing

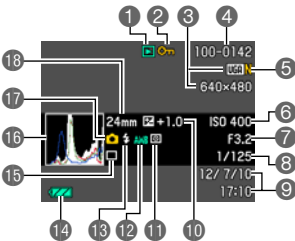

- 1 File type
- 2 Protect indicator (page 124)
- 3 Snapshot image size (page 41)
- 4 Folder name/file name (page 157)
- 5 Snapshot image quality (page 102)
- 6 ISO sensitivity (page 44)
- 7 Aperture value
- 8 Shutter speed
- 9 Date/time (page 164)
- 10 Exposure compensation (page 46)
- 11 Metering mode (page 103)
- 12 White balance setting (page 122)
- 13 Flash (page 47)
- 14 Battery level indicator (page 21)
- 15 Continuous Shutter mode (page 53)
- 16 Histogram (page 185)
- 17 Recording mode (page 28)
- 18 Focal distance
(Converted to 35 mm film format.)

■ Movie Playback



- 1 No audio data available
- 2 File type
- 3 Protect indicator (page 124)
- 4 Folder name/file name (page 157)
- 5 Movie recording time (page 105)
- 6 Movie quality/speed (pages 64, 67, 67)
- 7 YouTube (page 71)
- 8 Date/time (page 164)
- 9 Battery level indicator (page 21)

■ CS Image Viewing



- 1 Current image number/number of images in the group (page 107)
- 2 CS group icon (page 107)
- 3 Playback guide (page 107)
- 4 CS speed (page 107)

Turning Display Information On and Off (Info)

Each press of [▲] (DISP) will cycle through display settings that display or hide on-screen information and the control panel. You can configure separate settings for the REC mode and PLAY mode.

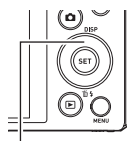

[▲] (DISP)

Information on, control panel on	Displays setting information and the control panel.
Information on, control panel on, histogram on	Displays setting information and the control panel, and a histogram (page 185) on the left side of the display. Also displays the remaining movie recording time as well as a movie image quality icon.
Information off, control panel off	Hides setting information and the control panel.



Histogram

- The control panel is not displayed and display information settings cannot be changed during movie recording.

Quick Start Basics

What is a digital camera?

A digital camera stores images on a memory card, so you can record and delete them a countless number of times.

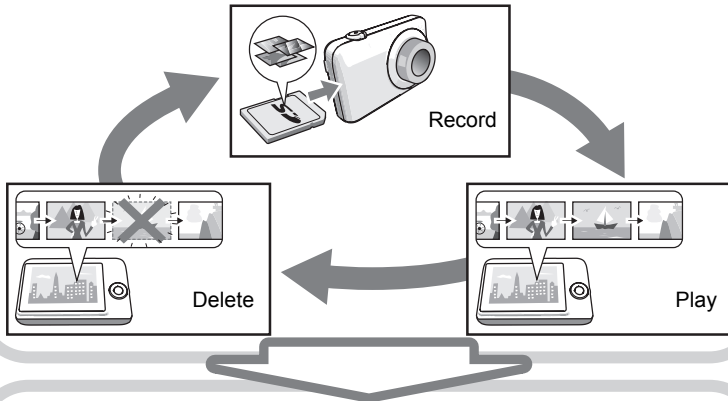

You can use the images you record in a variety of different ways.

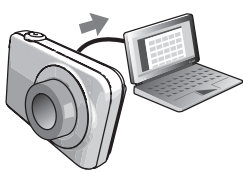

Store images on your computer.

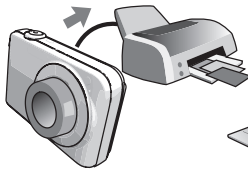

Print images.



Attach images to e-mail.

What you can do with your CASIO camera

Your CASIO camera is packed with a powerful selection of features and functions to make recording of digital images easier, including the following six main functions.



Premium Auto PRO

Select Premium Auto PRO recording and the camera automatically determines whether you are shooting a subject or scenery, and other conditions. Premium Auto PRO delivers higher image quality than standard Auto.

→ See page **28** for more information.



Blurred Background

This function analyzes a burst of consecutive images and then blurs the background behind the main subject. This creates an effect that really makes the subject stand out, just like photographs taken with a single-lens reflex camera.

→ See page **77** for more information.

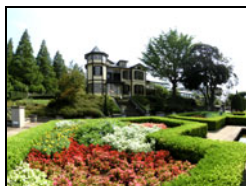

Wide Shot

With this feature, a number of images are shot and then combined to produce an image with a super-wide angle of view that exceeds the widest angle of view possible with the lens. Converted to 35 mm equivalents, the focal distances available with this feature enable shooting with approximate angles of view of 14 mm and 18 mm.

→ See page **78** for more information.



HDR Art / HDR Art Movie

An HDR Art feature combines different parts of a burst of images shot with different exposures into a final image and performs high-precision image analysis to produce final images that are true works of art. HDR Art also can be used when shooting movies.

→ See page **59** for more information.



High Speed Movie

Movies can be recorded at up to 1000 frames per second. This makes it possible to clearly view phenomena that are invisible to the human eye, in slow motion.

→ See page **67** for more information.



FHD Movie Recording

You can record movies in high-quality FHD.
(1920×1080 pixels 30 fps)

1920×1080 pixels

→ See page **67** for more information.

First, charge the battery prior to use.

Note that the battery of a newly purchased camera is not charged. Perform the steps below to load the battery into the camera and charge it.

- Your camera requires a special CASIO rechargeable lithium ion battery (NP-130) for power. Never try to use any other type of battery.

To load the battery

1. Open the battery cover.

Slide the battery cover slider towards OPEN and then open it as indicated by the arrows in the illustration.

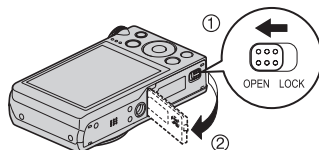

2. Load the battery.

With the EXILIM logo on the battery facing downwards (in the direction of the lens), hold the stopper next to the battery in the direction indicated by the arrow as you slide the battery into the camera. Press the battery in until the stopper secures it in place.

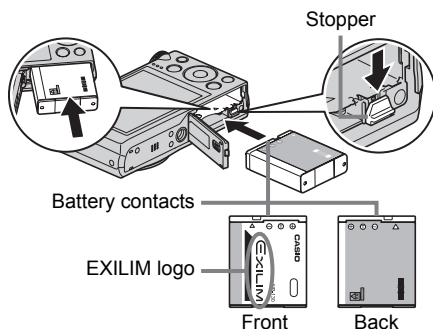

3. Close the battery cover.

Close the battery cover and then shift the slider towards LOCK.

- For information about how to replace the battery, see page 178.

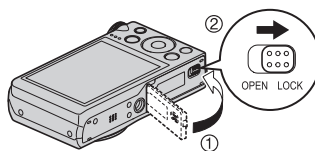

Charge the Battery

You can use either of the two following methods to charge the camera's battery.

- USB-AC adaptor
- USB connection to a computer

■ To charge with the USB-AC adaptor

1. Turn off the camera.

Check to make sure that the camera's monitor screen is blank. If it isn't, press [ON/OFF] (Power) to turn off the camera.

[ON/OFF] (Power)

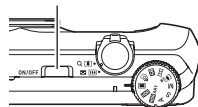

2. After connecting the supplied USB cable to the USB-AC adaptor, plug the power cord into a household power outlet.

USB cable (included with camera)

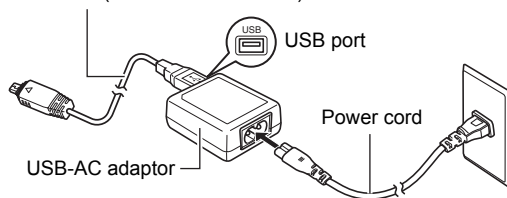

3. Connect the USB cable to the camera.

The back lamp should light red, indicating that charging has started. The back lamp will go out when charging is complete. It takes about 240 minutes to bring a fully dead battery to a full charge.

- A battery that has not been used for a long time, or ambient temperature extremes can cause charging to take longer than normal. If charging takes longer than about six hours, a timer will terminate it automatically, even if the battery is not fully charged. This is indicated by the back lamp flashing red. If the battery has not been used for a very long time, charging may be terminated automatically and the back lamp may start flashing red after only about 45 minutes. In either case, disconnect the USB cable from the camera and then reconnect it to resume charging.
- Note that even while the connector is fully inserted, you still will be able to see the metal part of the connector as shown in the illustration.

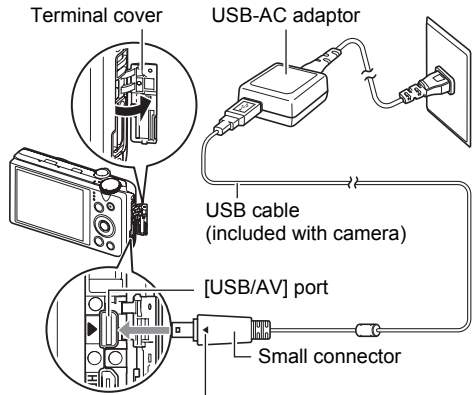

Making sure that the ► mark on the camera is aligned with the ◄ mark of the USB cable connector, connect the cable to the camera.

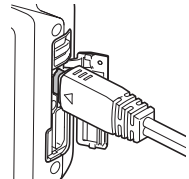

Back Lamp Operation

Lamp Status	Description
Lit Red	Charging
Flashing Red	Abnormal ambient temperature, USB-AC adaptor problem, battery problem, or charging terminated by timer (page 177)
Off	Charging complete

Back lamp

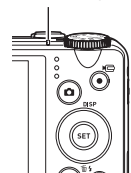

4. After charging is complete, disconnect the USB cable from the camera and then unplug the power cord from the power outlet.

■ To charge using a USB connection to a computer

The battery loaded in the camera is charged whenever the camera is connected directly to a computer with the USB cable.

- Depending on the setup of your computer, you may not be able to charge the camera's battery over a USB connection. If this happens, use of the USB-AC adaptor that comes with the camera is recommended.

★ IMPORTANT!

- The first time you connect the camera to your computer with the USB cable, an error message may appear on your computer. If this happens, disconnect and then reconnect the USB cable.

1. Press [ON/OFF] (Power) to turn off the camera.

2. With your computer turned on, connect the camera to it.

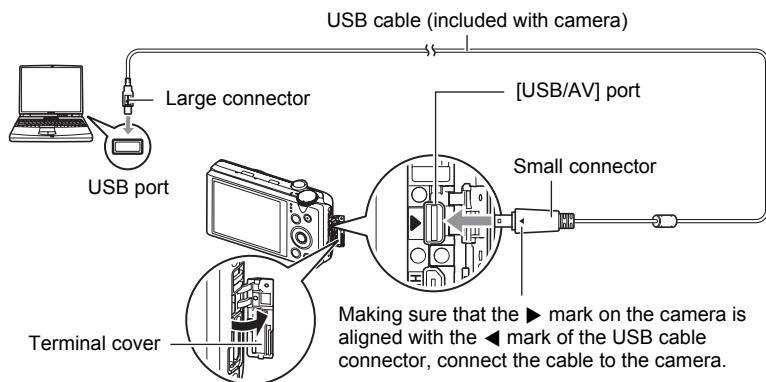

The camera's back lamp will light red. After a short while, the camera will turn on automatically and the back lamp will light amber to indicate that charging has started. The back lamp will light green when charging is complete. Note, however, that some computer models or connection conditions can produce low supply capacity. If low supply capacity exists, charging will start without the camera turning on. This is indicated by the back lamp lighting red. The back lamp will go out in this case after charging is complete.

- A battery that has not been used for a long time, certain types of computers, and connection conditions can cause charging to take more than approximately six hours, which will trigger a timer that terminates charging automatically, even if the battery is not fully charged. If this happens, disconnect and then reconnect the USB cable to restart charging. To complete charging faster, use of the included USB-AC adaptor is recommended.
- If the battery has not been used for a very long time, charging may terminate automatically and the back lamp may start flashing red or go out after only about 30 minutes to 45 minutes. In either case, use of the USB-AC adaptor that comes with the camera is recommended.
- Note that even while the connector is fully inserted, you still will be able to see the metal part of the connector as shown in the illustration.

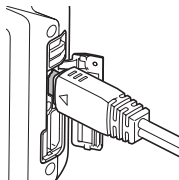

Back Lamp Operation

Lamp Status	Description
Lit Amber	Charging
Lit Red	Charging in progress (Data transfer with computer not supported.)
Flashing Red/Off	Abnormal ambient temperature, battery problem, or charging terminated by timer (page 177)
Lit Green	Charging complete, or charging stopped

Back lamp

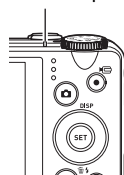

3. After charging is complete, disconnect the USB cable from the camera and then from the computer.

NOTE

- Charging continues while a camera is connected to a computer's USB port, even if the camera is turned off. Under this condition, the back lamp operates as described under "Back Lamp Operation" (page 18).



IMPORTANT!





- Charging is not performed while the connected computer is in the hibernate mode.
- A charging error can occur immediately after charging begins or some time after charging begins. A charging error is indicated by the back lamp flashing red.
- If low supply capacity exists due to your computer model or connection conditions, charging will start without the camera turning on. Turning on the camera in this case will cause charging to stop and enter USB data communication between the camera and the computer. The camera's back lamp will be lit green at this time.

Other Charging Precautions

- With the two charging methods described above, you can charge the camera's battery (NP-130) without removing it from the camera. You also can charge the battery using an optionally available charger unit (BC-130L). Never use any other type of charger device. Attempting to use a different charger can result in unexpected accident.
- A battery that is still warm immediately after normal use may not charge fully. Give the battery time to cool before charging it.
- A battery discharges slightly even when it is not loaded in the camera. Because of this, it is recommended that you charge the battery immediately before you need to use it.
- Charging the camera's battery may cause interference with TV and radio reception. If this happens, plug the USB-AC adaptor into an outlet that is further away from the TV or radio.
- Actual charging time depends on current battery capacity and charging conditions.
- Do not use the USB-AC adaptor with any other device.

Checking Remaining Battery Power

As battery power is consumed, a battery indicator on the monitor screen indicates remaining power as shown below.

Remaining Power	High ←————→ Low
Battery Indicator	 →  →  → 
Indicator Color	Cyan → Amber → Red → Red

 indicates battery power is low. Charge the battery as soon as possible.

Recording is not possible when  is indicated. Charge the battery immediately.

- The level shown by the battery indicator may change when you switch between the REC mode and PLAY mode.
- Leaving the camera for about 30 days with no power supplied while the battery is dead will cause its date and time settings to be cleared. A message telling you to configure time and date settings will appear the next time you turn on the camera after restoring power. When this happens, configure date and time settings (page 164).
- See page 199 for information about battery life and number of shots.

Battery Power Conservation Tips

- When you do not need to use the flash, select  (Flash Off) for the flash setting (page 47).
- Enable the Auto Power Off and the Sleep features to protect against wasting battery power when you forget to turn off the camera (pages 165, 166).
- Select “Off” for “Continuous AF” (page 98).
- Avoid unnecessary optical zoom operations.

Configuring Basic Settings the First Time You Turn On the Camera

The first time you load a battery into the camera, a screen appears for configuring the display language, date, and time settings. Failure to set the date and time correctly will cause the wrong date and time data to be recorded with images.

IMPORTANT!

- A screen for language selection will not appear in step 2 of the procedure below if you purchased a camera intended for the Japanese market. To change the display language from Japanese in this case, use the procedure under “Specifying the Display Language (Language)” (page 165). Note that a version of this manual in the language you select may not be included with a camera intended for the Japanese market.
- Camera models sold in certain geographic areas may not support display language selection.

1. Press [ON/OFF] (Power) to turn on the camera.

2. Use [▲], [▼], [◀], and [▶] to select the language you want and then press [SET].

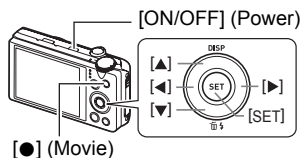

3. Use [▲] and [▼] to select a date style and then press [SET].

Example: July 10, 2012
YY/MM/DD → 12/7/10
DD/MM/YY → 10/7/12
MM/DD/YY → 7/10/12

4. Set the date and the time.

Use [◀] and [▶] to select the setting you want to change and then use [▲] and [▼] to change it. To switch between 12-hour and 24-hour format, press [●] (Movie).



5. After setting the date and time, use [◀] and [▶] to select “Apply” and then press [SET].

If you make a mistake configuring display language, date, or time settings with the above procedure, refer to the following pages for information about how to correct the settings.

- Display language: page 165
- Date and time: page 164

NOTE

- Each country controls its local time offset and the use of summer time, and so they are subject to change.
- Removing the battery from the camera too soon after configuring time and date settings for the first time can cause the settings to be reset to their factory defaults. Do not remove the battery for at least 24 hours after configuring settings.

Preparing a Memory Card

Though the camera has built-in memory that can be used to store images and movies, you probably will want to purchase a commercially available memory card for greater capacity. The camera does not come with a memory card. Images recorded while a memory card is loaded are saved to the memory card. When no memory card is loaded, images are saved to built-in memory.

- For information about memory card capacities, see page 194.

Supported Memory Cards

- SD Memory Card (Up to 2GB)
- SDHC Memory Card (2GB to 32GB)
- SDXC Memory Card (32GB to 2TB)



Use one of the above types of memory card.

- The above are supported memory card types as of September 2011.
- Noted memory card capacities are standard values.
- Use only SD cards that are compliant with the SD Card Association specification.
- This camera supports use of Eye-Fi cards.

■ Memory Card Handling Precautions

Certain types of cards can slow down processing speeds, and even can make it impossible to store High Quality movies correctly. Also, use of certain types of memory cards slows down data transfer and increases the time it takes to record movie data, which can result in movie frames being dropped. The **REC** indicator on the monitor screen turns yellow to indicate that frames are being dropped. In order to avoid problems such as these, use of an Ultra High Speed Type SD memory card is recommended. Note, however that CASIO makes no guarantees about the operation of any Ultra High Speed Type SD memory card used with this camera.

To load a memory card

1. Press [ON/OFF] (Power) to turn off the camera and then open the battery cover.

Slide the battery cover slider towards OPEN and then open it as indicated by the arrows in the illustration.

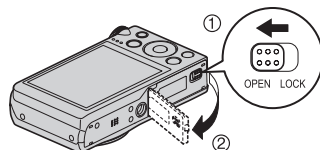

2. Load a memory card.

Positioning the memory card so its front is facing upwards (towards the monitor screen side of the camera), slide it into the card slot all the way in until you hear it click securely into place.

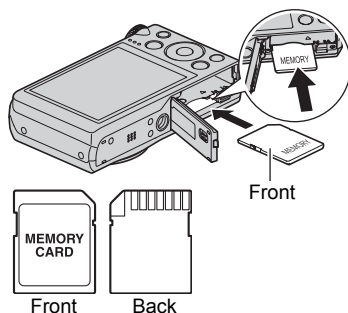

3. Close the battery cover.

Close the battery cover and then shift the slider towards LOCK.

- For information about how to replace the memory card, see page 180.

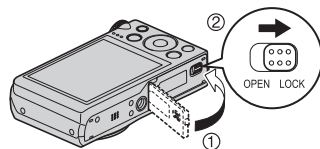

★ IMPORTANT!

- Never insert anything besides a supported memory card (page 23) into the memory card slot.
- Should water or any foreign object ever get into the card slot, immediately turn off the camera, remove the battery, and contact your retailer or nearest CASIO authorized service center.

To format (initialize) a new memory card

You need to format a new memory card before using it for the first time.



IMPORTANT!

- Formatting a memory card that already has snapshots or other files on it, will delete its contents. Normally you do not need to format a memory card again. However, if storing to a card has slowed down or if you notice any other abnormality, re-format the card.
- Be sure to use the camera to format a memory card. Formatting a memory card on a computer and then using it in the camera can slow down data processing by the camera. In the case of an SD, SDHC, or SDXC memory card, formatting on a computer can result in non-conformity with the SD format, causing problems with compatibility, operation, etc.
- Before formatting a new Eye-Fi card to use it for the first time, copy the Eye-Fi Manager install files to your computer. Do this before formatting the card.

1. Turn on the camera and press [MENU].

2. On the “Set Up” tab, select “Format” and then press [▶].

3. Use [▲] and [▼] to select “Format” and then press [SET].

Turning the Camera On and Off

To turn power on

To turn on power and enter the REC mode	Press [ON/OFF] (Power) or [RECORD] (REC). <ul style="list-style-type: none">The back lamp will light green momentarily and the lens will extend out of the camera (page 28).
To turn on power and enter the PLAY mode	Press [PLAY] (PLAY). <ul style="list-style-type: none">The back lamp will light green momentarily and an image currently stored in camera memory will appear on the monitor screen (page 32).

[ON/OFF] (Power)

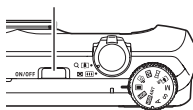

Back lamp

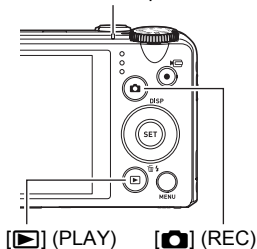

- Take care to ensure that nothing is restricting or coming into contact with the lens as it extends. Holding the lens with your hand so it cannot extend creates the risk of malfunction.
- Pressing [PLAY] (PLAY) while in the REC mode switches to the PLAY mode. The lens retracts about 10 seconds after switching modes.
- The Sleep function or Auto Power Off (pages 165, 166) will turn off power automatically if you do not perform any operation for a preset amount of time.

To turn off the camera

Press [ON/OFF] (Power).

- You can configure the camera so power does not turn on when you press [RECORD] (REC) or [PLAY] (PLAY). You also can configure the camera to turn off when you press [RECORD] (REC) or [PLAY] (PLAY) (page 166).

Holding the Camera Correctly

Your images will not come out clearly if you move the camera when you press the shutter button. When pressing the shutter button, be sure to hold the camera as shown in the illustration, and keep it still by pressing your arms firmly against your sides as you shoot. Holding the camera still, carefully press the shutter button and take care to avoid all movement as the shutter releases and for a few moments after it releases. This is especially important when available lighting is low, which slows down the shutter speed.

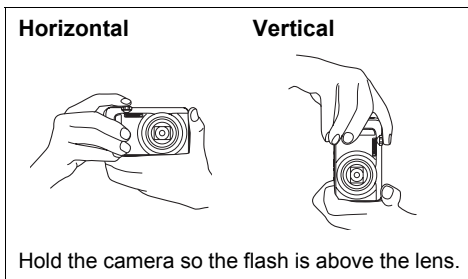

NOTE

- Take care that your fingers and the strap do not cover any of the areas indicated in the illustration.
- To protect against accidentally dropping the camera, attach the wrist strap and make sure it is around your fingers or wrist while you are operating the camera.
- Never swing the camera around by its strap.
- The supplied strap is intended for use with this camera only. Never use it for any other purpose.
- When the "Auto Rotate" setting is turned on, the camera will detect whether it is being held vertically or horizontally when a snapshot image is shot.

When you display an image shot with the camera held vertically, the image is rotated automatically 90 degrees when displayed on the monitor screen (page 160).

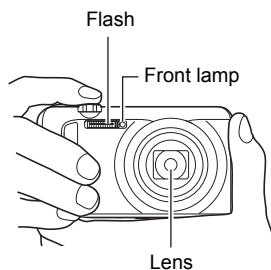

IMPORTANT!

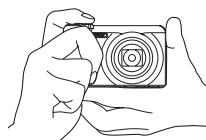

- Take care to ensure that your fingers are not blocking or are not too close to the flash. Fingers can cause unwanted shadows when using the flash.



To shoot a snapshot

Selecting an Auto Recording Mode

You can select one of two auto recording modes (Auto or Premium Auto PRO) according to your digital imaging needs.

 Auto	This is the standard Auto recording mode.
 Premium Auto PRO	With Premium Auto PRO recording, the camera automatically determines whether you are shooting a subject or scenery, and other conditions. Premium Auto PRO recording delivers higher image quality than standard Auto recording. <ul style="list-style-type: none">• Premium Auto PRO recording takes longer to process image data after it is shot than Auto recording.• It also requires more power (and runs down the battery quicker) than Auto.

1. Press **[RECEIVE]** (REC) to turn on the camera.

The camera will enter the REC mode.

2. Set the mode dial to (Auto) or (Premium Auto PRO) to select Auto recording mode.

Auto recording mode icon

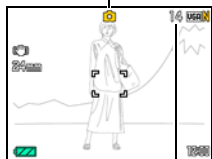

Remaining Snapshot Memory Capacity (page 194)

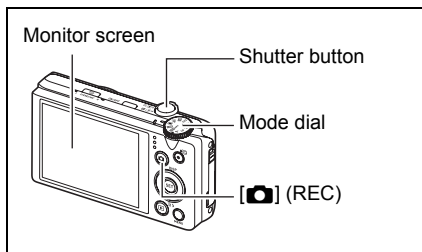

To shoot a snapshot

1. Point the camera at the subject.

If you are using Premium Auto PRO, text will appear in the lower right corner of the monitor screen describing the type of shot the camera has detected.

- You can zoom the image, if you want.

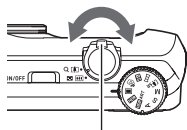

Zoom controller



Wide Angle



Telephoto



Appears when the camera detects it is stationary on a tripod.

If the camera decides that it needs to shoot a series of images with Continuous Shutter (CS), it will display "CS". Take care to avoid any camera and subject movement until shooting of all of the CS images is complete.



2. Half-press the shutter button to focus the image.

When focus is complete, the camera will beep, the back lamp will light green, and the focus frame will turn green.

Back lamp

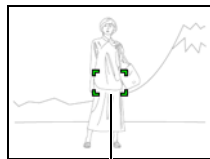
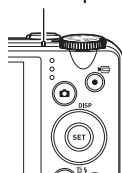

Focus frame

Half-press

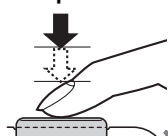

Press lightly until the button stops.

Beep, beep (Image is in focus.)

When you half-press the shutter button, the camera automatically adjusts exposure and focuses on the subject it is currently pointed at. Mastering how much pressure is required for a half-press and a full-press of the shutter button is an important technique for good-looking images.

3. Continuing to keep the camera still, press the shutter button the rest of the way down.

This records the snapshot.

Full-press

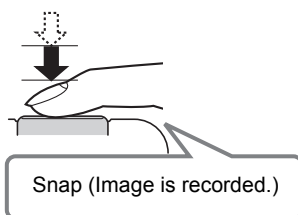

Recording a Movie

Press [●] (Movie) to start movie recording. Press [●] (Movie) again to stop movie recording. See the following pages for details.

Standard movie (STD movie): page 64

High-definition movie (FHD movie): page 67

High speed movie (HS movie): page 67

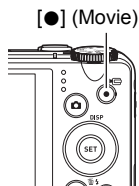

Recording Beautiful Portraits (Make-up Function)

The Premium Auto PRO Make-up Function smoothes the skin texture of the subject and softens facial shadows caused by harsh sunlight for better looking portraits. There are three different Make-up Level settings: Off, Standard, and High.

1. Enter the Premium Auto PRO mode (page 28).

2. Press [SET].

3. Use [▲] and [▼] to select the third control panel option from the bottom (Make-up Level).

4. Use [◀] and [▶] to select the Make-up Level setting you want, and then press [SET].

- There are three available settings: "Off", "Standard", and "High".

5. Shoot the image.

■ If the image does not focus...

If the focus frame stays red and the back lamp is flashing green, it means that the image is not in focus (because the subject is too close, etc.). Re-point the camera at the subject and try to focus again.

■ Shooting with Auto

If the subject is not in the center of the frame...

“Focus lock” (page 93) is the name of a technique you can use when you want to shoot an image in which the subject to be focused on is not within the focus frame in the center of the screen.

To track the movement of a moving subject

Half-press the shutter button to follow and focus automatically on a moving subject. See “ Tracking” (page 96) for more information.

■ Shooting with Premium Auto PRO

- In addition to shutter speed, aperture, and ISO sensitivity, the camera automatically executes the following operation as required when shooting with Premium Auto PRO.
 - Auto Focus is normally performed until you half-press the shutter button.
 - Intelligent AF (page 96)
 - Face Detection (page 97)
- Shooting with Premium Auto PRO can cause vibration and noise to occur due to lens operation. This does not indicate malfunction.
- When Shooting with Premium Auto PRO, the message “Processing Premium Auto. Please wait...” may appear on the monitor screen. If you feel the camera is taking too long to process data, try shooting with standard Auto instead.
- In some cases, Premium Auto PRO may not be able to interpret the shooting environment correctly. If this happens, shoot with standard Auto.
- If “HS” is displayed, the camera will shoot a series of images with Continuous Shutter (CS). Take care to avoid any camera and subject movement until shooting of all of the CS images is complete.
- Certain flash settings (page 47) can limit environmental factors detectable by Premium Auto PRO.

Viewing Snapshots

Use the following procedure to view snapshots on the camera's monitor screen.

- For information about how to play back movies, see page 105.
- For information about images recorded using continuous shutter (CS), see page 107.

1. Press **[▶]** (PLAY) to enter the PLAY mode.

- This will display one of the snapshots currently stored in memory.
- Information about the displayed snapshot also is included (page 11).
- You also can clear the information to view only the snapshot (page 12).
- You can zoom in on the image by sliding the zoom controller towards **[▲]** (page 112). If you are recording a snapshot that is very important to you, it is recommended that you zoom the image and check its details after recording it.

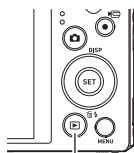

2. Use **[◀]** and **[▶]** to scroll between images.

- Holding down either button scrolls at high speed.



NOTE

- Half-pressing the shutter button while in the PLAY mode or while a menu screen is displayed will switch directly to the REC mode.

Deleting Snapshots and Movies

If memory becomes full, you can delete snapshots and movies you no longer need in order to free up storage and record more images.



IMPORTANT!

- Remember that a file (image) delete operation cannot be undone.
- For information about images recorded using continuous shutter (CS), see page 108.

To delete a single file

1. Press [▶] (PLAY) to enter the PLAY mode and then press [▼] (🗑️ ↴).



2. Use [◀] and [▶] to scroll through the files until the one you want to delete is displayed.

3. Use [▲] and [▼] to select "Delete" and then press [SET].

- To delete other files, repeat steps 2 and 3.
- To exit the delete operation, press [MENU].
- If a CS group (page 107) is displayed when you perform the above procedure, all of the images in the currently displayed CS group will be deleted.

To delete specific files

1. Press [▶] (PLAY) to enter the PLAY mode and then press [▼] (🗑️ ⚡).
2. Use [▲] and [▼] to select “Delete Files” and then press [SET].
 - This displays a file selection screen.
3. Use [▲], [▼], [◀], and [▶] to move the selection boundary to the file you want to delete, and then press [SET].
 - This will select the check box of the currently selected file.
 - You can enlarge the selected image before deleting it by sliding the zoom controller towards [⏏] (Q).
4. Repeat step 3 to select other files, if you want. After you are finished selecting files, press [MENU].
5. Use [▲] and [▼] to select “Yes” and then press [SET].
 - This deletes the files you selected.
 - To cancel the delete operation, select “No” in step 5 and then press [SET].

To delete all files

1. Press [▶] (PLAY) to enter the PLAY mode and then press [▼] (🗑️ ⚡).
2. Use [▲] and [▼] to select “Delete All Files” and then press [SET].
3. Use [▲] and [▼] to select “Yes” and then press [SET] to delete all files. This will cause the message “There are no files” to appear.

Snapshot Shooting Precautions

Operation

- Never open the battery cover while the back lamp is flashing green. Doing so can result in the image you just shot being saved incorrectly, damage to other images stored in memory, malfunction of the camera, etc.
- If unwanted light is shining directly onto the lens, shade the lens with your hand.

Monitor Screen when Shooting Snapshots

- Subject brightness conditions can cause monitor screen response to slow and can cause digital noise in the monitor screen image.
- The image that appears on the monitor screen is for image composition. The actual image will be recorded at the quality set for the image quality setting (page 102).

Shooting Indoors under Fluorescent Lighting

- Minute flickering of fluorescent lighting can affect the brightness or color of an image.

Other Precautions

- The slower the shutter speed, the greater the possibility that noticeable noise will be generated in an image. Because of this, the camera automatically performs a noise reduction at slow shutter speeds. The noise reduction process causes it to take longer to record images at lower shutter speeds. The shutter speeds for which noise reduction is performed depend on the camera setup and shooting conditions.
- A noise reduction process is performed when ISO sensitivity is set to a high value. This can cause the camera to take relatively longer to be ready to shoot again after you press the shutter button. Do not perform any key operation while the image recording operation is in progress.
- Due to the characteristics of the imaging element used by the camera, very fast moving objects in an image may appear distorted.

Auto Focus Restrictions

- Any of the following can make proper focus impossible.
 - Solid color wall or other very low contrast subject
 - Strongly back lit subject
 - Very shiny subject
 - Blinds or other subject with a repeating horizontal pattern
 - Multiple subjects at varying distances from the camera
 - Subject in a dark location
 - Subject that is too far away for light from the AF assist light to reach
 - Camera movement while shooting
 - Fast-moving subject
 - Subjects outside the focus range of the camera
- If you cannot focus properly, try using focus lock (page 93) or Manual Focus (page 91).

Selecting the Recording Mode

Your camera has a variety of different recording modes. Before recording an image, rotate the mode dial to select the recording mode that suits the type of image you are trying to record.

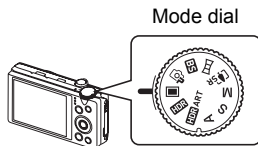

Auto

Standard Auto recording mode. This is the mode you normally should use (page 28).

Premium Auto PRO

With Premium Auto PRO recording, the camera automatically determines whether you are shooting a subject or scenery, and other conditions. Premium Auto PRO recording delivers higher image quality than standard Auto recording (page 28).

BEST SHOT

Simply select one of a collection of built-in sample scenes and the camera sets up automatically for beautiful images every time (page 73).

Slide Panorama

With Slide Panorama, you move the camera to compose and record multiple images, which are then combined to a panorama. This feature lets you shoot a panorama of up to 360 degrees, which is dramatically greater than the physical capabilities of the lens (page 62).

Multi SR Zoom

This feature uses super resolution technology and multiple Continuous Shutter (CS) images to expand the zoom range for overall images of higher quality and clarity (page 61).

M (Manual Exposure) mode

This mode gives you total control over aperture and shutter speed settings.

- 1 Press [SET] to open the control panel.
- 2 Use [▲] and [▼] to select the fourth control panel option from the top (aperture).
- 3 Use [◀] and [▶] to change the aperture setting.
- 4 Use [▲] and [▼] to select the fifth control panel option from the top (shutter speed).
- 5 Use [◀] and [▶] to change the shutter speed setting.

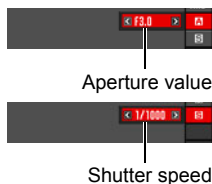

S S (Shutter Speed Priority) mode

In this mode, you select the shutter speed and other settings are adjusted accordingly.

- ① Press [SET] to open the control panel.
- ② Use [▲] and [▼] to select the fourth control panel option from the top (shutter speed).
- ③ Use [◀] and [▶] to change the shutter speed setting.
 - You also can select the EV shift setting located under the shutter speed setting and then specify an exposure value (EV shift), if you want.



Shutter speed

A A (Aperture Priority) mode

In this mode, you select the aperture and other settings are adjusted accordingly.

- ① Press [SET] to open the control panel.
- ② Use [▲] and [▼] to select the fourth control panel option from the top (aperture).
- ③ Use [◀] and [▶] to change the aperture setting.
 - You also can select the EV shift setting located under the aperture setting and then specify an exposure value (EV shift), if you want.



Aperture value

HDR ART HDR Art



This feature applies HDR (High Dynamic Range, page 58) photography to transform snapshots and movies into works of art that provide a greater degree of expression than conventional imaging. You can also adjust the intensity of the art effect that is applied (page 81).

HDR HDR

With HDR (High Dynamic Range), the camera shoots a series of CS images using different exposure settings and combines them into a final image to correct for overexposure or underexposure of subjects of different brightness levels (page 58).



IMPORTANT!

- You may not be able to achieve the brightness you want when shooting an image that is very dark or very bright. If this happens, use the M mode to adjust the aperture or shutter speed manually.
- In the S mode, ISO sensitivity (page 44) always operates according to its "AUTO" setting. The ISO sensitivity setting cannot be changed while in the S mode.
- While A, S, or M is selected for the recording mode, the flash will not fire if  (Auto Flash) or  (Red Eye Reduction) is selected as the flash mode. If you want the flash to fire, select  (Flash On) as the flash mode.
- The displayed ISO sensitivity, shutter speed or aperture value will turn orange when you half-press the shutter button if the image is overexposed or underexposed.

Using the Control Panel

The control panel can be used to configure camera settings.

[▲] [▼] [◀] [▶]

1. In the REC mode, press [SET].

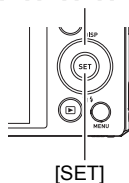

2. Use [▲] and [▼] to select the setting you want to change.

This will select one of the control panel icons and display its settings.*1

- 1 Image size/Quality*2 (pages 41, 102)
- 2 ISO sensitivity (page 44)
- 3 White balance (page 45)
- 4 EV shift (page 46)
- 5 Not displayed in this mode
- 6 Not displayed in this mode
- 7 Not displayed in this mode
- 8 Flash (page 47)
- 9 Date/Time (page 49)

Control panel

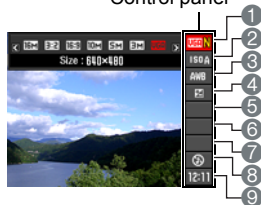

*1 Items displayed in the control panel depend on the recording mode.

*2 Image quality cannot be changed using the control panel.

3. Use [◀] and [▶] to change the setting.

4. If you want to configure another setting, repeat steps 2 and 3.

5. After all of the settings are the way you want, press [SET].

This will apply the settings and return to the REC mode.

NOTE

- No icon is displayed for any Control Panel option (page 10) that is set to its initial default (reset) setting. An icon will appear only if you change the setting of the corresponding Control Panel option. The following are the initial defaults for Control Panel options.
 - ISO Sensitivity: AUTO
 - White Balance: Auto WB
 - EV Shift: ± 0
 - Flash: Auto Flash
- You also can use on-screen menus to configure settings other than those listed above (page 89).

Changing the Image Size (Size)

■ Pixels

A digital camera image is a collection of small dots called “pixels”. The more pixels there are in an image, the more detail there will be. However, you generally can do with fewer pixels when printing an image (L size) through a print service, attaching an image to e-mail, when viewing the image on a computer, etc.

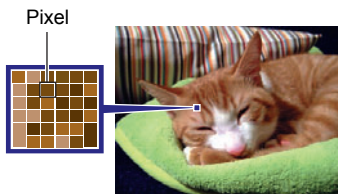

■ About image sizes

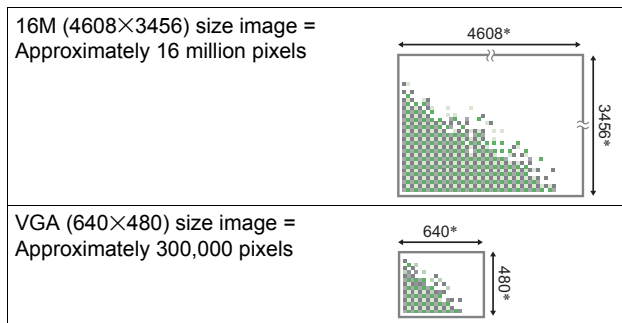

The size of an image indicates how many pixels it contains, and is expressed as horizontal pixels \times vertical pixels.



* Unit: pixels

Image Size Selection Tips

Note that larger images have more pixels, so they take up more memory space.

Large Number of Pixels	More detail, but takes up more memory. Best when you plan to print large-size prints (such as poster size).	
Small Number of Pixels	Less detail, but takes up less memory. Best when you want to send images by e-mail, etc.	

- For information about image size, image quality, and number of images that can be stored, see page 194.
- For information about movie image size, see page 102.
- For information about resizing existing snapshots, see page 127.

■ To select the snapshot image size

1. In the REC mode, press [SET].

2. Use [▲] and [▼] to select the top control panel option (Snapshot Image Size).

3. Use [◀] and [▶] to select an image size and then press [SET].

Image Size (Pixels)	Suggested Print Size and Application	Description
16M (4608×3456)	Poster Print	Good detail for better clarity even for images cropped (page 128) from the original
3:2 (4608×3072)	Poster Print	
16:9 (4608×2592)	HDTV	
10M (3648×2736)	Poster Print	Good detail
5M (2560×1920)	A4 Print	
3M (2048×1536)	3.5"×5" Print	Best when preserving memory capacity is relatively more important than image quality.
VGA (640×480)	E Mail	Image files are smaller, which is better when attaching images to e-mail. However, images are relatively coarser.

- The initial factory default image size setting is 16M (16 million pixels).
- Selecting “3:2” records images with an aspect ratio of 3:2, which matches the standard aspect ratio of print paper.
- The letters “HDTV” stand for “High Definition Television”. An HDTV screen has an aspect ratio of 16:9, which makes them wider than the usual 4:3 aspect ratio of television screens of the past. Your camera can record images that are compatible with the aspect ratio an HDTV screen.
- You should regard the print paper sizes suggested here as guidelines only (200 dpi print resolution).
- Available image sizes are limited for some functions as noted below.

3:2, 16:9	These image sizes cannot be selected when using some BEST SHOT scenes*1. Selecting “3:2” or “16:9” while one of the non-supported BEST SHOT scenes*1 is selected will cause the image size setting to change to “16M” automatically.
----------------------	--

*1 High Speed CS, Child CS, Pet CS, Sports CS

Specifying ISO Sensitivity (ISO)

ISO sensitivity is a measure of sensitivity to light.

1. In the REC mode, press [SET].

2. Use [▲] and [▼] to select the second control panel option from the top (ISO Sensitivity).

3. Use [◀] and [▶] to select the setting you want and then press [SET].

AUTO	Adjusts sensitivity automatically according to conditions		
ISO 80	Lower sensitivity ↑ ↓ Higher sensitivity	Slow shutter speed	Less noise
ISO 100			
ISO 200			
ISO 400			
ISO 800			
ISO 1600		Fast shutter speed (Set for shooting in dimly lit areas.)	Some coarseness (increased digital noise)
ISO 3200			

- While "AUTO" is selected, Anti Shake corrects for subject movement only (page 95).
- Higher ISO sensitivity values tend to result in digital noise in images.
- Since higher ISO sensitivity values tend to result in digital noise in images, the camera performs a noise filtering process. Because of this, it may take relatively longer for the camera to finish recording an image after it is shot. You will not be able to perform any key operation while image recording is in progress.

Adjusting White Balance (White Balance)

You can adjust white balance to match the source of light available where you are shooting and avoid the blue cast that results when shooting outdoors when it is cloudy, and the green cast that results when shooting under fluorescent lighting.

1. In the REC mode, press [SET].
2. Use [▲] and [▼] to select the third control panel option from the top (White Balance).
3. Use [◀] and [▶] to select the shooting condition you want and then press [SET].

AWB Auto WB	Configures the camera to adjust white balance automatically
☀ Daylight	For shooting outdoors on a clear day
☁ Overcast	For shooting outdoors on an overcast rainy day, in the shade, etc.
🌲 Shade	For shooting on a clear day in the shade of trees or buildings
☀N Day White Fluorescent	For shooting under white or day white fluorescent lighting
☀D Daylight Fluorescent	For shooting under daylight fluorescent lighting
💡 Tungsten	For shooting under light bulb lighting
MWB Manual WB	<p>For configuring the camera manually to suit a particular light source.</p> <ol style="list-style-type: none">① Select "MWB Manual WB".② Under the lighting conditions you plan to use when shooting, point the camera at a blank white piece of paper so it fills the entire monitor screen and then press the shutter button.③ Press [SET]. <p>The white balance setting is retained even if you turn off the camera.</p>

Blank white paper

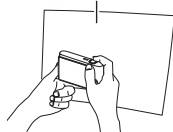

- When "AWB Auto WB" is selected for the white balance setting, the camera automatically determines the white point of the subject. Certain subject colors and light source conditions can cause problems when the camera tries to determine the white point, which makes proper white balance adjustment impossible. If this happens, select the white balance setting that matches your shooting conditions (Daylight, Overcast, etc.).

Correcting Image Brightness (EV Shift)

You can manually adjust an image's exposure value (EV value) before shooting it.

- Exposure Compensation Range: -2.0 EV to +2.0 EV
- Unit: 1/3EV

1. In the REC mode, press [SET].

2. Use [▲] and [▼] to select the fourth control panel option from the top (EV Shift).

- When A or S is selected as the recording mode, the EV Shift is the fifth control panel option from the top.

3. Use [◀] and [▶] to adjust the exposure compensation value.

[▶]: Increases the EV value. A higher EV value is best for light-colored subjects and backlit subjects.

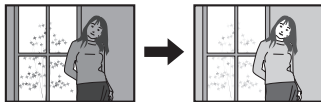

[◀]: Decreases the EV value. A lower EV value is best for dark-color subjects and for shooting outdoors on a clear day.



To cancel exposure compensation, change the EV value to 0.0.



Exposure compensation value

4. Press [SET].

This applies the exposure compensation value. The exposure compensation value you set remains in effect until you change it or turn off the camera (which causes it to revert to "0.0").

NOTE

- When shooting under very dark or very bright conditions, you may not be able to obtain satisfactory results even after performing exposure compensation.

Using Flash (Flash)

1. In the REC mode, press [▼] (🗑️⚡) once.

2. Use [◀] and [▶] to select the flash setting you want and then press [SET].

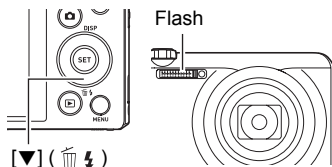

⚡A Auto Flash	Flash fires automatically in accordance with exposure (amount of light and brightness) conditions.
🚫 Flash Off	Flash does not fire.
⚡ Flash On	Flash always fires. This setting can be used to brighten a subject that normally comes out dark due to daylight or backlight (daylight synchro flash).
👁️ Red Eye Reduction	Flash fires automatically. This type of flash can be used to reduce the chance of redness in the subject's eyes.

3. Press the shutter button to shoot.

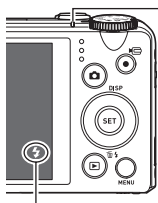

Back lamp





Flashes red while the flash is charging to indicate that image recording is disabled.

- You will not be able to take another flash snapshot until the lamp stops flashing red, which indicates that charging is complete.

⚡ indicates the flash will fire.

- For information about Flash Range, see page 198.

NOTE

- Take care so your fingers and the strap do not block the flash.
- The desired effect may not be obtained when the subject is too far away or too close.
- Flash charging time (page 198) depends on operating conditions (battery condition, ambient temperature, etc.).
- Shooting with flash turned off when lighting is dim results in a slow shutter speed, which can cause image blur due to camera movement. Under such conditions, secure the camera with a tripod, etc.
- With red eye reduction, the flash is fired automatically in accordance with exposure. It does not fire in areas where lighting is bright.
- The presence of outdoor sunlight, fluorescent lighting, or some other light source can cause abnormal image colors.
- Select  (Flash Off) for the flash setting when shooting in areas where flash photography is prohibited.
- While A, S, or M is selected for the recording mode, the flash will not fire if  (Auto Flash) or  (Red Eye Reduction) is selected as the flash mode. If you want the flash to fire, select  (Flash On) as the flash mode.

Red-eye Reduction

Using the flash to shoot at night or in a dimly lit room can cause red spots inside the eyes of people who are in the image. This is caused when the light from the flash reflects off of the retina of the eye. When red-eye reduction is selected as the flash mode, the camera fires a pre-flash to cause the irises in the eyes of any people in the image to close, which reduces the chance of red eye.

Note the following important points when using red-eye reduction.

- Red-eye reduction does not work unless the people in the image are looking directly at the camera (flash).
- Red-eye reduction may not work very well if the subjects are located far away from the camera.

Changing the Control Panel Date/Time Style

1. In the REC mode, press [SET].
2. Use [▲] and [▼] to select the bottom control panel option (Date/Time).
You can use [◀] and [▶] to select date or time display.

NOTE

- You can select either of two display styles (page 164) for the date: Month/Day or Day/Month.
- The time is displayed using 24-hour format.

Shooting with Zoom

Your camera is equipped with various types of zoom: optical zoom, HD Zoom, Single SR Zoom, Multi SR Zoom, and digital zoom. The maximum zoom factor depends on the image size setting and the digital zoom on/off settings.

Optical zoom	Changes the lens focal distance.
HD Zoom	Allows greater zoom capabilities by cutting out a portion of the original image and enlarging it.
Single SR Zoom	Applies super resolution technology to suppress image deterioration (page 51).
Multi SR Zoom	Shoots a burst of High Speed CS images, which are then combined into a final image to suppress image quality deterioration across a range that is greater than Single SR Zoom. (Multi SR Zoom is enabled only when the “Multi SR Zoom” recording mode is selected.) (page 61)
Digital zoom	Digitally processes the center of the image to enlarge it.

1. In the REC mode, slide the zoom controller to zoom.





 Wide Angle

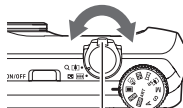

 Telephoto



Zoom controller

-  (Wide Angle): Reduces the size of the subject and broadens the range.
-  (Telephoto) : Enlarges the subject and narrows the range.

2. Press the shutter button to shoot the image.

NOTE

- Use of a tripod is recommended to protect against image blur due to camera movement when shooting with telephoto.
- Performing a zoom operation changes the lens aperture.
- Except for High Speed Movie, zoom operations are supported during movie recording. Zoom operations are disabled during high speed movie recording. To use optical zoom, perform the zoom operation before you press [●] (Movie) to start recording.
- Zoom operations are not supporting during Slide Panorama shooting. The zoom setting is fixed at full wide angle.
- Zoom operations are not supported during Wide Shot shooting. The zoom setting is fixed at full wide angle.

Interpreting the Zoom Bar

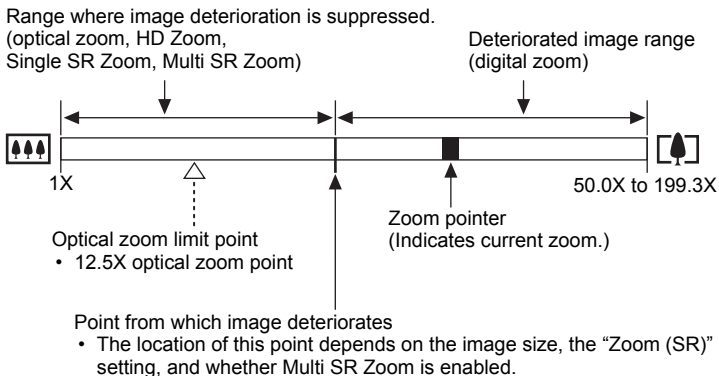

During a zoom operation, a zoom bar appears on the monitor screen to show the current zoom setting.



Zoom (SR) Setting	Point from which image deteriorates
Off	12.5X to 90.0X
Single (Single SR Zoom)	18.8X to 134.8X
Multi SR Zoom	25.0X to 179.6X

■ Zoom Icon

The appearance of the zoom icon on the monitor screen depends on the zoom factor.

Optical zoom	Not displayed
HD Zoom	Not displayed
Single SR Zoom	 (White)
Multi SR Zoom	 (Orange)
Digital zoom	

■ Zoom Factor

The digital zoom factor depends on the image size (page 41), the super resolution zoom setting, and on whether or not “Multi SR Zoom” is selected (page 61).

- Multi SR Zoom is enabled only when the “Multi SR Zoom” recording mode is selected.

Image size	Maximum zoom factor where image deterioration can be suppressed			Total maximum zoom factor		
	Zoom (SR): Off	Zoom (SR): Single	Multi SR Zoom	Zoom (SR): Off	Zoom (SR): Single	Multi SR Zoom
16M	12.5X	18.8X	25.0X	50.0X	50.0X	50.0X
3:2	12.5X	18.8X	25.0X	50.0X	50.0X	50.0X
16:9	12.5X	18.8X	25.0X	50.0X	50.0X	50.0X
10M	15.8X	23.6X	31.6X	63.1X	63.1X	63.1X
5M	22.5X	33.8X	45.0X	90.0X	90.0X	90.0X
3M	28.1X	42.1X	56.3X	112.3X	112.3X	112.3X
VGA	90.0X	134.8X	179.6X	199.3X	199.3X	199.3X

Zooming with Super Resolution (Zoom (SR))

There are two types of Super Resolution Zoom: Single SR Zoom and Multi SR Zoom. Single SR Zoom uses super resolution to expand the zoom range in which image quality deterioration is minimized. Multi SR Zoom shoots a series of High Speed CS images, which are then combined into final image to suppress image quality deterioration across a range that is greater than Single SR Zoom. For information about the effective zoom factor ranges in which Super Resolution Zoom is effective, see page 51.

The procedure below shows how to configure Single SR Zoom settings. For information about Multi SR Zoom, see page 61.

- 1. In the REC mode, press [MENU].**

- 2. Use [◀] and [▶] to select the “REC” tab.**

- 3. Use [▲] and [▼] to select “Zoom (SR)” and then press [▶].**

- 4. Use [▲] and [▼] to select “Single” and then press [SET].**

NOTE

- Single SR Zoom is effective when you want to capture delicate textures.
- Single SR Zoom does not work during movie recording.
- The following functions are disabled when shooting with Single SR Zoom. Triple Self-timer, HDR, HDR Art, Slide Panorama, Multi SR Zoom, some BEST SHOT scenes

Using Continuous Shutter

Pressing  (Continuous Shutter) toggles between the Continuous Shutter mode and the Single Shot mode (page 28).

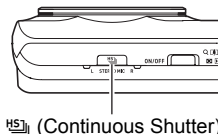

Using High Speed CS and Prerecord CS

With High Speed CS, you can configure the camera to shoot at a speed of 3, 5, 10, 15, or 30 images per second, as long as you keep the shutter button and there is memory available to store the images. With Prerecord CS, half-pressing the shutter button starts continual pre-recording of images to a temporary buffer. Then when you press the shutter button the rest of the way down, the camera stores what is currently in the buffer and starts real-time continuous shutter recording of new images. Real-time recording continues until you release the shutter button or until a total of up to 30 images (buffer images plus new images) are recorded. You can configure Prerecord CS to specify how many of the 30 images are recorded in the buffer and how many are recorded after you fully press the shutter button. Use Prerecord CS when you want to make sure you do not miss fast-moving action.

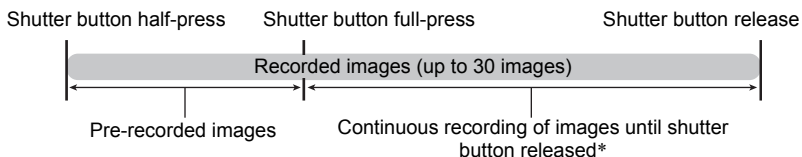

* You can record up to 30 images (pre-recorded buffer images plus real-time images) for each Prerecord CS operation.

- You can specify 5, 10, 20, or 30 as the maximum number of shots for each continuous shutter operation.
- You can specify anywhere from 1 second up to 10 seconds as the continuous shutter shooting time, which is the amount of time of the pre-record buffer plus the amount of time that continuous shutter recording is performed after the shutter button is pressed all the way. The maximum shooting time depends on the selected CS speed. You can select a CS speed in the range of 3 to 30 fps.



30 images per second (30 fps)	You can shoot up to 30 images in 1 second.
3 images per second (3 fps)	You can shoot up to 10 images over 30 seconds.

- You can configure the mode so up to 25 images are pre-recorded to the buffer until you fully press the shutter button.
- The minimum number of pre-recorded buffer images you can specify is three. Total recording time depends on the current continuous shutter frames-per-second (fps) setting.
- Specifying zero for the number of pre-recorded images disables Pre-record CS and performs High Speed CS only (without pre-recording). Note that the mechanical shutter is used when shooting with High Speed CS.

■ Getting Ready

1. Set the mode dial to  (Auto).

2. Press  (Continuous Shutter).

- This will display  (High Speed CS). If this does not happen, press  again.

3. Press [SET].

4. Use [▲] and [▼] to select the fourth control panel option from the bottom (High Speed CS fps).

5. Use [◀] and [▶] to select the continuous shutter (CS) speed you want.

High Speed CS icon



CS speed



3 to 30 fps	Enables specification of the number of CS images recorded per second.
--------------------	---

6. Use [▲] and [▼] to select the third control panel option from the bottom (Max CS shots).

7. Use [◀] and [▶] to select the maximum number of shots for each continuous shutter operation.



8. Use [▲] and [▼] to select the second control panel option from the bottom (Prerecord CS shots).

9. Use [◀] and [▶] to specify how many of the 30 images and for how long images should be pre-recorded in the buffer.

- Prerecord CS shooting is not performed when the number of buffer images and the recording time are both zero. Note that the mechanical shutter is used when shooting with High Speed CS.



10. Press [SET].

- The approximate number of recordable CS images will appear on the monitor screen.

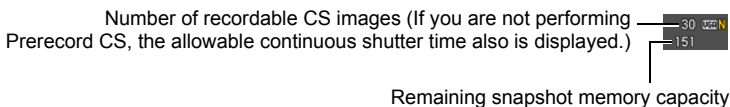

■ Shooting Images

1. Half-press the shutter button.

This will cause the camera to start pre-recording images.

- The camera will not emit a shutter sound when you half-press the shutter button while Prerecord CS is selected.
- If you release the half-pressed shutter button before pressing it the rest of the way down, all of the pre-recorded images currently in the buffer will be deleted.

2. When you are ready to shoot, press the shutter button the rest of the way down.

This will record the images in the pre-record buffer and start recording new images in real-time. Images continue to be shot as long as you keep the shutter button depressed.

3. Real-time shooting will stop when you release the shutter button or after the maximum number of shots is reached.

NOTE

- Note the following when selecting a High Speed CS speed (fps) setting.
 - Use a higher High Speed CS speed (fps) setting when shooting a fast-moving subject.
 - Use a slower High Speed CS speed (fps) setting when shooting a slower-moving subject.
- Note the following when selecting a High Speed CS maximum number of shots setting.
 - The greater the number of shots, the longer it takes to save them after shooting is complete.
- Note the following when specifying a Prerecord CS shots setting.
 - A setting that results in a Prerecord CS operation that takes at least 0.3 seconds is recommended because there is a minimal lag from about 0.1 seconds to 0.3 seconds between the point you decide to shoot and the point that the shutter button is fully depressed.

Continuous Shutter Precautions

- You can use the Manual Mode while a continuous shutter mode is selected. To do so, set the mode dial to “A”, “S”, or “M”.
- When shooting CS images, the snapshot image quality automatically changes to “Normal”.
- If there is not enough available capacity on the memory card, you may not be able to record the number of CS images indicated on the monitor screen. Make sure your memory card has sufficient remaining capacity before shooting with using continuous shutter.
- With High Speed CS, exposure and focus for the first image are applied for successive images as well.
- When using a continuous shutter mode, keep the camera still until shooting is finished.
- With High Speed CS, the flash setting automatically becomes  (Flash Off).
- Zoom is disabled during continuous shutter operations.
- The following image sizes cannot be selected while shooting with High Speed CS: “3:2”, “16:9”. Entering the High Speed CS mode while any one of these image sizes is selected will cause the image size setting to change to “16M” automatically.
- With High Speed CS, the maximum number of images that can be recorded during each session is limited, regardless of how much memory card storage capacity is available.

High Speed CS	Specified maximum number of continuous shutter shots (Max CS shots)
----------------------	---

The number of images will be restricted even further or shooting may be impossible when remaining memory card capacity is less than the allowable number of images for a particular CS mode.

- The Triple Self-time cannot be used in the High Speed CS mode.
- The Self-timer cannot be used in the Prerecord CS mode.
- You cannot enter the Continuous Shutter (CS) mode while Premium Auto PRO is being used. The camera will automatically shoot a series of images if it determines current shooting conditions require it.
- Single SR Zoom and Multi SR Zoom cannot be used in combination with High Speed CS.

Digitally Correcting for Overexposure and Underexposure (HDR)

With HDR (High Dynamic Range), the camera shoots a series of CS images using different exposure settings and combines them into a final image to correct for overexposure or underexposure of subjects of different brightness levels.

1. In the REC mode, set the mode dial to  (HDR).

2. Press the shutter button to shoot.

NOTE

- HDR works best when shooting with the camera mounted on a tripod.
- Shooting with this function causes the flash setting to change automatically to  (Flash Off).
- Anti Shake correction performed to compensate for camera movement while shooting with this function results in an image area that is narrower than normal.
- The desired HDR effect may not be attained if the camera or subject moves during shooting.
- Depending on shooting conditions and image composition, this function may not be able to produce the desired result.

Shooting Snapshots Digitally Processed for Artistic Effect (HDR Art)

This feature applies HDR (High Dynamic Range, page 58) photography to transform snapshots and movies into works of art that provide a greater degree of expression than conventional imaging. You can also adjust the intensity of the art effect that is applied (page 81).



Normal image



HDR Art image

1. In the REC mode, set the mode dial to **HDR ART (HDR Art)**.
2. Press [SET].
3. Use [▲] and [▼] to select the fifth Control Panel option from the top (Art Effect).

4. Use [◀] and [▶] to select the intensity of the art effect.

Art Effect: 1	Weak
Art Effect: 2	Normal
Art Effect: 3	Strong

5. Press [SET].

6. Press the shutter button to shoot.

- After you press the shutter button, the message "Busy... Please wait..." will appear on the monitor screen to indicate that recording is in progress. Keep the camera still while this message is displayed. The recording process takes some time to complete after the message appears. Image shooting is disabled while the message is displayed.

NOTE

- HDR Art works best when shooting with the camera mounted on a tripod.
- Shooting with this function causes the flash setting to change automatically to  (Flash Off).
- Anti Shake correction performed to compensate for camera movement while shooting with this function results in an image area that is narrower than normal.
- The desired HDR Art effect may not be attained if the camera or subject moves during shooting.
- Depending on shooting conditions and image composition, this function may not be able to produce the desired result.

To shoot a movie with HDR Art (HDR Art Movie)



- 1. In the REC mode, set the mode dial to  ART (HDR Art).**
- 2. Record the movie the same way as you would a normal movie (page 64).**

Press [] (Movie) to start and stop recording.

IMPORTANT!

- Certain shooting conditions when shooting a movie with this function can cause the image and audio to be out of sync.
- “Art Effect” settings are not reflected in movies.

NOTE

- With HDR Art Movie, the “ Quality” setting can be either “HD” or “STD” only (page 102).
- When any “ Quality” setting other than “STD” is selected in another mode, the “HD” setting is used when shooting with HDR Art Movie.

Expanding the Zoom Range to Shoot Clearer Snapshots (Multi SR Zoom)

This feature uses super resolution technology and multiple Continuous Shutter (CS) images to expand the zoom range for overall images of higher quality and clarity (page 52).

1. In the REC mode, set the mode dial to [M]SR (Multi SR Zoom).

2. Press the shutter button to shoot.

NOTE

- Multi SR Zoom is effective when you want to capture delicate textures.
- The current “Zoom (SR)” (page 52) setting is ignored when shooting with this function.
- With Multi SR Zoom, the flash setting automatically becomes [OFF] (Flash Off).
- The desired Multi SR Zoom effect may not be attained if the camera or subject moves during shooting.
- Depending on shooting conditions and image composition, Multi SR Zoom may not be able to produce the desired result.

Shooting a Panorama Image (Slide Panorama)

With Slide Panorama, you move the camera to compose and record multiple images, which are then combined to a panorama. This feature lets you shoot a panorama of up to 360 degrees, which is dramatically greater than the physical capabilities of the lens.



- The final panorama image can be one of the two sizes shown below.
Slide Direction is Right or Left: Maximum 11520×1080 pixels
Slide Direction is Up or Down: Maximum 1920×7296 pixels
- Zoom operations are not supporting during Slide Panorama shooting. The zoom setting is fixed at full wide angle.
- You can use Slide Panorama to shoot a horizontal image up to approximately 360 degrees and a vertical image up to approximately 180 degrees.
If you shoot a horizontal Slide Panorama image that is less than 360 degrees, the image size will become 60, 120, 180, 240, or 300 degrees.

1. In the REC mode, set the mode dial to  (Slide Panorama).
2. Press [SET] and then use [\blacktriangle] and [\blacktriangledown] to select the fifth Control Panel option from the bottom (Slide Direction).
3. Use [\blacktriangleleft] and [\blacktriangleright] to select the direction you are planning to move the camera while shooting, and then press [SET].
You can select one of four directions: Right, Left, Up, or Down.
4. Point the camera at the start of the panorama and half-press the shutter button to allow the camera to focus automatically.

5. Press the shutter button the rest of the way down and a slide cursor will appear on the monitor screen. Slowly move the camera in the direction indicated by the arrow on the screen until the slide cursor reaches the other end of its movement range (i.e. all the way to the right when moving the camera to the right).



Slide cursor

- The camera will start composing the panorama image internally when the slide cursor reached the other end of the movement range.
- Image composing also will start automatically if you stop moving the camera during panorama shooting. After you stop moving the camera, the message "Busy... Please wait..." appears as the camera processes the image. Wait until this message disappears before using the camera. Image shooting is disabled while the message is displayed.

NOTE

- The following conditions are not compatible with Slide Panorama shooting.
 - Subject whose brightness is very different from that of its surroundings due to artificial light, sunlight, etc.
 - Rivers, waves, waterfalls, or other subject with constantly changing patterns
 - Sky, beach, or other subject with continuous patterns
 - Camera too close to the main subject
 - Moving subject
- Slide Panorama may stop part way through in the following cases.
 - Subject or camera movement
 - Camera movement that is too fast or too slow
- Shooting a Slide Panorama image after half-pressing the shutter button to perform Auto Focus may not produce the desired results if there are considerable differences in the brightness, color, and/or focus of the individual images. If this happens, try changing the focus position by focusing on a different subject, etc.
- Since a Slide Panorama image is created by joining multiple images together, there may be some roughness at the point where two images are joined.
- Shooting under a flickering light source (such as fluorescent lighting) may result in uneven brightness and/or coloring in the final Slide Panorama image.
- Shooting in dark surroundings may result in a blurred image or may make Slide Panorama shooting impossible.
- Slowly move the camera at a constant speed in the same direction as the arrow that appears on the monitor screen.
- When moving the camera, try to keep the arrow on the monitor screen as straight as possible.
- The exposure and white balance when shooting Slide Panorama images are fixed at the levels measured when you half-press the shutter button at the beginning of the operation.
- An error message will appear if the camera is unable to successfully record a series of images.
- If you shoot a moving subject, the camera may not be able to compose the panorama image properly.
- Shooting with this function causes the flash setting to change automatically to  (Flash Off).

Recording Movies

To record a movie

The following procedure explains how to record a standard (STD) movie.

See the pages indicated below for more information about movies.

High-definition movie (FHD movie): page 67

High speed movie (HS movie): page 67

1. Set the mode dial to  (Auto).

2. In the REC mode, press [MENU].

3. Use [◀] and [▶] to select the “Quality” tab.

4. Use [▲] and [▼] to select “Quality” and then press [▶].

5. Use [▲] and [▼] to select “STD” (Standard), and then press [SET].

- Recording is performed with an aspect ratio of 4:3, an image size of 640×480 pixels, and a frame rate of 30 frames per second (STD Movie). Image size setting cannot be changed.
- The semi-transparent gray frame on the monitor screen indicates the area that is recorded when shooting a movie. The area within the frame is recorded for a movie.

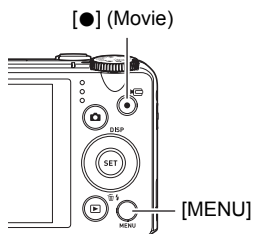

Semi-transparent gray frame

6. Press [●] (Movie).

This will start recording and display  on the monitor screen.

Movie recording includes stereo audio.

7. Press [●] (Movie) again to stop recording.

- Each movie can be up to 29 minutes long. Movie recording stops automatically after 29 minutes of recording. Movie recording also will stop automatically if memory becomes full before you stop movie recording by pressing [●] (Movie) again.

Remaining recording time
(page 195)

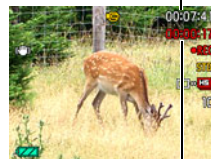

Recording time

Shooting with BEST SHOT

With BEST SHOT (page 73), you can select the sample scene that matches the type of movie you are trying to shoot and the camera will change its setup accordingly, for beautiful movies every time. Selecting the "Natural Green" BEST SHOT scene, for example, will shoot images with vivid green trees and grass. Movie Recording is disabled while certain BEST SHOT scenes are being used.

Minimizing the Effects of Camera Movement during Movie Recording

You can use Anti Shake (page 95) to configure the camera to minimize the effects of camera movement during FHD and STD movie recording. Note that Anti Shake cannot be used with HDR Art Movie and that Anti Shake does not prevent image blur due to subject movement.

Audio

Your camera has built-in microphones that can be used to record audio (stereo) during movie recording.

- Your camera has a function to reduce wind noise (Wind Noise Cut) when recording movies (page 99).

Recording Precautions

The camera also records audio. Note the following points when shooting a movie.

- Take care that the microphones are not blocked by your fingers, etc.
- Good audio recording results are not possible when the camera is too far away from what you are trying to record.
- Performing a zoom operation while shooting can cause zoom and/or auto focus noise to be in the audio recording.
- Operating camera buttons while shooting can cause button noise to be picked up in the audio.
- When shooting with the "HS" movie mode at a frame rate setting of "30-120 fps" or "30-240 fps", audio is recorded only while the camera is shooting at 30 fps. Audio is not recorded at any other frame rates.

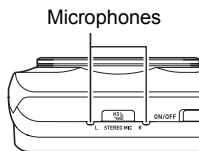





IMPORTANT!

- Spending a long time using movie recording will cause the camera to become slightly warm to the touch. This is normal and does not indicate malfunction.
- Shooting movies for long periods in areas where temperature is relatively high can cause digital noise (dots of light) to appear in the movie image. A rise in the camera's internal temperature also may force movie recording to stop automatically. If this happens, stop recording and allow the camera to cool down, which should cause normal operation to resume.
- Shooting a movie using the camera's built-in memory will cause movie frames to be dropped. Always use a high speed memory card (not built-in memory) for movie recording.

- Use of certain types of memory cards slows down data transfer and increases the time it takes to record movie data, which can result in movie frames being dropped. The  indicator on the monitor screen turns yellow to indicate that frames are being dropped. In order to avoid problems such as these, use of an Ultra High Speed Type SD memory card is recommended. Note, however that CASIO makes no guarantees about the operation of any Ultra High Speed Type SD memory card used with this camera.

NOTE

- Except for High Speed Movie, zoom operations are supported during movie recording (page 49). Zoom is disabled during high speed movie recording. To use optical zoom for high speed movie recording, perform the zoom operation before you press  (Movie) to start recording.
- Both Single SR Zoom (page 52) and Multi SR Zoom (page 61) are disabled during movie recording.
- The effects of camera movement in an image become more pronounced when you shoot close up or with a large zoom factor. Because of this, use of a tripod is recommended under these conditions.
- Except for High Speed Movie, Continuous AF (page 98) is performed during movie recording while "Auto Focus" or "Macro" is selected for the "Focus" setting.
- During High Speed Movie recording (HS120, HS240, HS480, HS1000), focus is fixed at the position where it was when recording started. To focus an image, half-press the shutter button for Auto Focus or focus manually before you press  (Movie) to start recording.
- Continuous AF is operational when recording at 30 fps with "HS30-120" or "HS30-240". However, focus becomes fixed whenever you switch to 120 fps or 240 fps.
- Face Detection is disabled during movie (FHD, STD, high speed) recording.
- The A, S, and M recording modes are not supported when shooting a movie, or when using the "Prerecord (Movie)" and "For YouTube" BEST SHOT scenes. In these cases, the recording mode is always  (Auto).
- The following BEST SHOT scenes are always shot using high speed movie. The current  "Quality" setting is ignored.
Child High Speed Movie, Pet High Speed Movie, Sports High Speed Movie
- The following functions do not support movie recording.
HDR, Slide Panorama, Multi SR Zoom

Recording a High-definition Movie

This camera supports recording of high-definition (FHD) movies. The aspect ratio of an FHD movie is 16:9, the image size is 1920×1080 pixels, and the frame rate is 30 fps. Image quality and image size settings cannot be changed.

1. Set the mode dial to  (Auto).

2. In the REC mode, press [MENU].

3. Use [◀] and [▶] to select the “Quality” tab.

4. Use [▲] and [▼] to select “ Quality” and then press [▶].

5. Use [▲] and [▼] to select “FHD”, and then press [SET].

6. Record the movie the same way as you would a normal movie (page 64).
Press [●] (Movie) to start and stop recording.

Recording a High Speed Movie

This camera supports recording of high speed movies at a maximum speed of 1000 fps. The aspect ratio of movies recorded with this mode depends on the frame rate (recording speed).

- When recording with the frame rate setting of “30-120 fps” or “30-240 fps” frame rate setting, audio recording is supported during 30 fps recording only. Audio is not recorded at any other frame rates.
1. Set the mode dial to  (Auto).

 2. In the REC mode, press [MENU].

 3. Use [◀] and [▶] to select the “Quality” tab.

 4. Use [▲] and [▼] to select “ Quality” and then press [▶].

5. Use [▲] and [▼] to select the frame rate (recording speed) you want and then press [SET].

A fast frame rate (such as 1000 fps) will result in a smaller image size.

 Quality	Frame Rate	Image Size (Pixels)
HS120	120 fps	640×480
HS240	240 fps	512×384
HS480	480 fps	224×160
HS1000	1000 fps	224×64
HS30-120	30-120 fps	640×480
HS30-240	30-240 fps	512×384

* fps (frames per second) is a unit of measurement indicating the number of images recorded or played back per second.

6. Record the movie the same way as you would a normal movie (page 64).

Press [●] (Movie) to start and stop recording.

- During High Speed Movie recording (HS120, HS240, HS480, HS1000), focus is fixed at the position where it was when recording started. To focus an image, half-press the shutter button for Auto Focus or focus manually before you press [●] (Movie) to start recording.
- Continuous AF is operational when recording at 30 fps with “HS30-120” or “HS30-240”. However, focus becomes fixed whenever you switch to 120 fps or 240 fps.
- When “HS30-120” or “HS30-240” is selected as the frame rate, recording always starts with a frame rate of 30 fps. You can switch the frame rate between 30 fps and 120 fps or between 30 fps and 240 fps only while recording is in progress. Audio is recorded only while shooting at a 30 fps. Use [◀] and [▶] or press [SET] to switch speeds.

NOTE

- The higher the frame rate (speed), the more lighting is required when shooting. When shooting a high speed movie, shoot in a well-lit environment.
- When recording certain types of movies, the image that appears on the monitor screen may be smaller than normal. When recording a high speed movie, there are black bands along the top, bottom, left, and right of the screen.
- When recording a high speed movie, light source flicker can cause horizontal bands to appear in the image. This does not indicate malfunction of the camera.
- Monitor screen content switching is disabled during high speed movie recording.

Using Prerecord Movie (Prerecord (Movie))

With this feature, the camera pre-records up to five seconds of whatever is happening in front of the lens in a buffer that is continually updated. Pressing [●] (Movie) saves the pre-recorded action (buffer contents) followed by real-time recording. Real-time recording continues until you stop it. Prerecord Movie can be used when shooting a standard (STD) movie, a high-definition (FHD) movie, or a high speed (HS) movie.

- When using Prerecord Movie in combination with high speed movie, the buffer will store two seconds of pre-recording instead of the usual five.

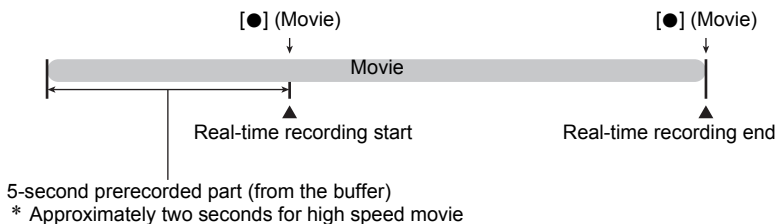

■ To set up the camera to shoot with Prerecord Movie

1. Set the mode dial to **BS** (BEST SHOT).
2. In the REC mode, press [MENU].
3. Use [◀] and [▶] to select the “Quality” tab.
4. Use [▲] and [▼] to select “**Quality**” and then press [▶].
5. Use [▲] and [▼] to select the movie mode you want to use for shooting.
6. Press [SET].
7. Press [SET].
8. Use [▲], [▼], [◀], and [▶] to select the “Prerecord (Movie)” scene and then press [SET].

This causes **Prerecord (Movie)** to appear on the monitor screen, indicating that the camera is prerecording to its buffer.

■ To shoot a Prerecord Movie

1. After using the above procedure to set up the camera for Prerecord Movie, point the camera at the subject.

2. When you are ready to record, press [●] (Movie).

This will save the approximately five seconds of action that was prerecorded in the buffer before you pressed [●] (Movie) (two seconds if you are using high speed movie) and start real-time recording.

3. Press [●] (Movie) again to stop recording.



- To turn off Prerecord Movie recording, set the mode dial to  (Auto).
- When shooting with the high speed movie “HS30-120” and “HS30-240” setting, you cannot change the speed (fps) setting while the camera is pre-recording to the buffer in step 1 of the above procedure. You can change the speed (fps) setting after you press [●] (Movie) to start real-time recording.

NOTE

- While the camera is set up for shooting with Prerecord Movie, pressing the shutter button will not shoot a snapshot unless movie recording is in progress. With high-definition (FHD) and standard (STD) movie, you can shoot still images while realtime movie recording is in progress.
- When shooting with Prerecord Movie in combination with high speed movie, pressing the [◀] or [▶] key will not change the EV shift or white balance setting, even if “EV Shift” or “White Balance” is assigned for the “L/R Key” function. To change the EV shift or white balance setting in this case, use the control panel.

Recording a Movie for YouTube (For YouTube)

The “For YouTube” scene records movies in a format that is optimal for uploading to the YouTube movie site, which is operated by YouTube, LLC. “For YouTube” can be used when shooting a standard (STD) movie, a high-definition (FHD) movie, or a high speed (HS) movie.

1. In the REC mode, press [MENU].
2. Use [◀] and [▶] to select the “Quality” tab.
3. Use [▲] and [▼] to select “ Quality” and then press [▶].
4. Use [▲] and [▼] to select the movie mode you want to use for shooting.
5. Press [SET].
6. Set the mode dial to  (BEST SHOT).
7. Press [SET].
8. Use [▲], [▼], [◀], and [▶] to select the “For YouTube” scene and then press [SET].
This causes  to appear on the monitor screen.

9. Record the movie.

The movie file will be stored in a camera folder named “100YOUTB”.

- Installing YouTube Uploader for CASIO simplifies uploading of movie files you recorded with the “For YouTube” scene to YouTube (page 148).
- To exit “For YouTube”, set the mode dial to  (Auto).





NOTE

- Movies recorded with the “For YouTube” scene are stored in a special folder to make them easy to locate for uploading (page 158). “For YouTube” movies are shot using the image size, recording speed, and quality settings configured in the Movie Mode (page 64).
- Snapshots cannot be shot (regardless of whether you are recording or not) while the “For YouTube” scene is selected.
- A single movie can have a maximum file size of 2,048MB or a playback time of 15 minutes. The actual maximum recording time depends on the movie mode used for recording (page 196).

Shooting a Snapshot while Shooting a Movie (Snapshot In Movie)

You can shoot snapshots while movie recording is in progress. When the camera is in the Single Shot mode, you can shoot snapshots one-by-one. In the CS mode, holding down the shutter button will record up to seven consecutive images at a speed of approximately 10 images per second (fps). You can shoot a maximum total of 28 images during a single movie recording operation.

1. While a movie is being recorded, press the shutter button.

- In the CS mode, images continue to be shot as long as you keep the shutter button depressed.
- Movie recording is not interrupted while snapshots are being shot.
- While movie recording is in progress, you can toggle between the Single Shot Mode and the CS mode by pressing  (Continuous Shutter), [, [, or [SET]. Note that this method for mode switching is possible only during movie recording. The CS mode is indicated when  is red (on the monitor screen), and the Single Shot mode is selected when  is red.



Number of recordable snapshots

NOTE

- You can shoot up to 28 snapshots per movie. The number of snapshots is also limited by the amount of free space available on the memory card.
- Note that the flash cannot be used when shooting a Snapshot in Movie.
- Note that shooting a snapshot while shooting a movie is supported during FHD movie and STD movie recording only. It is not supported during other types of movie recording.
- Snapshots shot with Snapshot in Movie cannot be focused individually. The focus will be the same as the movie being recorded.
- The field of view of a snapshot shot while FHD movie recording is in progress will be wider than the field of view of the FHD movie.
- The snapshot image quality automatically changes to "Normal".
- The  (Auto) recording mode is used when you shoot a snapshot during movie recording.

Using BEST SHOT

What is BEST SHOT?

BEST SHOT provides you with a collection of sample “scenes” that show a variety of different types of shooting conditions. When you need to change the setup of the camera, simply find the scene that matches what you are trying to achieve, and the camera sets up for it automatically. This helps to minimize the chance of ruined images due to poor exposure and shutter speed settings.

Some Sample Scenes

			
Portrait	Scenery	High Speed Night Scene	High Speed Night Scene and Portrait

To shoot with BEST SHOT

1. In the REC mode, set the mode dial to **BS** (BEST SHOT).

2. Press **[SET]**.

This will display a menu of BEST SHOT scenes.

3. Use **[▲]**, **[▼]**, **[◀]**, and **[▶]** to move the boundary to the scene you want to select.

- The scene menu has multiple pages. Use **[▲]** and **[▼]** to scroll between menu pages.
- To return to normal snapshot recording, set the mode dial to **[Auto]**.

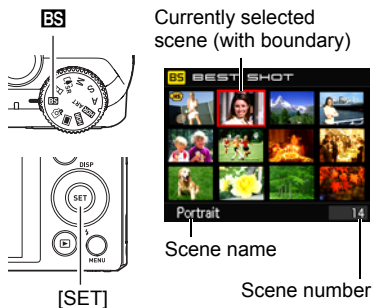

4. Press [SET] to configure the camera with the settings for the currently selected scene.

This returns to the REC mode.

- The settings of the scene you selected remain in effect until you select a different scene.
- To select a different BEST SHOT scene, repeat the above procedure from step 1.

5. Press the shutter button (if you are shooting a snapshot) or [●] (Movie) (if you are shooting a movie).

■ Using the Scene Information Screen

To find out more about a scene, select it with the boundary on the scene menu and then slide the zoom controller in either direction.

- To return to the scene menu, slide the zoom controller again.
- To scroll between scenes, use [◀] and [▶].
- To configure the camera with the settings for the currently selected scene, press [SET].

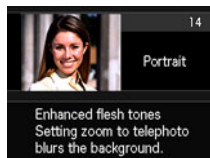

■ BEST SHOT Precautions

- Sample images shown on BEST SHOT scene screens were not shot with this camera. There are provided to illustrate the effects and merits of each scene.
- Images shot using a BEST SHOT scene may not produce the results you expected due to shooting conditions and other factors.
- You can modify the camera settings that are configured after you select a BEST SHOT scene. Note, however, that the BEST SHOT settings revert to their defaults when you select another BEST SHOT scene or turn off the camera.
- Snapshot shooting is disabled while the following BEST SHOT scenes are being used.
Prerecord (Movie), For YouTube, BEST SHOT movie scenes
- Movie recording is disabled while the following BEST SHOT scenes are being used.
High Speed Best Selection, Lag Correction, High Speed Anti Shake, Blurred Background, Wide Shot
- FHD movie and STD movie recording are disabled (and high speed movie is always enabled) while the following BEST SHOT scenes are being used.
Child High Speed Movie, Pet High Speed Movie, Sports High Speed Movie
- Shooting with a BEST SHOT scene automatically shoots with the mode setting that is configured for that scene, regardless of whether the camera's current REC mode setting is Single Shot or continuous shutter (CS) setting.
- The "3:2" and "16:9" image size settings are not supported by BEST SHOT scenes that use High Speed CS. Selecting "3:2" and "16:9" in another mode and then selecting a BEST SHOT scene that uses High Speed CS will cause the image size setting to change to "16M".
- When the movie mode is **FHD/STD**, movies are recorded using the settings of the selected BEST SHOT scene. For high speed movie recording, BEST SHOT scene settings are ignored and movie recording is performed as it normally is.
- BEST SHOT scenes that use High Speed CS ignore the "Zoom (SR)" setting.
- With the BEST SHOT scenes below, certain shooting conditions can cause the image area to become narrower than normal.
High Speed Night Scene and Portrait

Creating Your Own BEST SHOT Setup

You can save up to 999 camera setups as user BEST SHOT scenes for instant recall whenever you need them.

- 1. On the BEST SHOT scene menu, select the scene named “BEST SHOT” (Register User Scene) and then press [SET].**
- 2. Use [◀] and [▶] to select the snapshot whose setup you want to save.**
- 3. Use [▲] and [▼] to select “Save”, and then press [SET].**
Your BEST SHOT scene will be assigned the name “Recall User Scene”, along with a scene number.

NOTE

- You can create BEST SHOT setup for snapshots only. You cannot create a movie BEST SHOT setup.
- You can check the settings of the currently selected BEST SHOT scene by displaying the camera's setting menus and looking at its settings.
- User snapshot scenes are assigned numbers in the sequence: U1, U2, and so on.
- The following are the settings that are saved for each user snapshot BEST SHOT scene.
Face Detection, Focus, EV Shift, White Balance, Flash, ISO, Metering, Lighting, Flash Intensity, Color Filter, Sharpness, Saturation, Contrast
- User BEST SHOT scenes are stored in built-in memory (page 158) in the SCENE folder (snapshots).
- Formatting the camera's built-in memory (page 169) deletes all user BEST SHOT scenes.
- Use the following procedure when you want to delete a user BEST SHOT scene.
 - ① Display the information screen (page 74) of the user BEST SHOT scene you want to delete.
 - ② Press [▼] (), select “Delete”, and then press [SET].
- The following types of snapshots cannot be selected in step 2 of the above procedure when creating a user BEST SHOT scene.
HDR, HDR Art, Premium Auto PRO, Multi SR Zoom, Slide Panorama, Snapshot In Movie

Shooting with a Blurred Background (Blurred Background)

This function analyzes a burst of consecutive images and then blurs the background behind the main subject. This creates an effect that really makes the subject stand out, just like photographs taken with a single-lens reflex camera.



Shot with "Auto".



Shot with "Blurred Background".

1. In the REC mode, set the mode dial to  (BEST SHOT).

2. Press [SET].

3. Select "Blurred Background" and then press [SET].

4. Press the shutter button to shoot.

- Get as close as possible to the subject. Also, the background should be as far away as possible from the subject. The required distances depend on the zoom factor being used.

Example : When zoom is set to full wide (W), the distance between the camera and subject should be 30cm, while the distance between the subject and background should be at least 1 meter.

- This will cause the message "Busy... Please wait..." to appear. Do not move the camera while this message is displayed. The recording process takes some time to complete after the message appears.

NOTE

- The current "Zoom (SR)" (page 52) setting is ignored when shooting with this function.
- With this BEST SHOT scene, the flash setting automatically becomes  (Flash Off).
- The desired background blur effect may not be attained if the camera or subject moves during shooting.
- Depending on the shooting environment, image composition, and subject, this BEST SHOT scene may not be able to produce the desired result.
- If the camera determines that it is unable to blur the background of an image for some reason, it will display the message "Blur processing failed.". Note, however, that the image will be saved, even if background blurring is not possible.

Shooting with a Super Wide Angle of View (Wide Shot)

With this feature, a number of images are shot and then combined to produce an image with a super-wide angle of view that exceeds the widest angle of view possible with the lens. Converted to 35 mm equivalents, the focal distances available with this feature enable shooting with approximate angles of view of 14 mm and 18 mm.

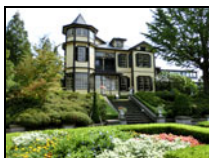

24 mm (lens widest angle)



Wide 1 (18 mm)



Wide 2 (14 mm)

1. In the REC mode, set the mode dial to **BS** (BEST SHOT).
2. Press [SET].
3. Select "Wide Shot" and then press [SET].
4. Press [▼] and then use [▲] and [▼] to select the width setting, which is the fifth Control Panel setting from the top.
5. Use [◀] and [▶] to select the width setting (angle of view) you want and then press [SET].

There are two settings available: "Wide 1 (18 mm)" and "Wide 2 (14 mm)".
"14 mm" shoots a wider area than "18 mm".

6. Hold the camera so it is upright, with the shutter button and other controls at the bottom.

- Do not point the camera straight down at the ground at this time. If you do, the camera's built-in vertical/horizontal position sensor will not operate properly and may make it impossible to start shooting.

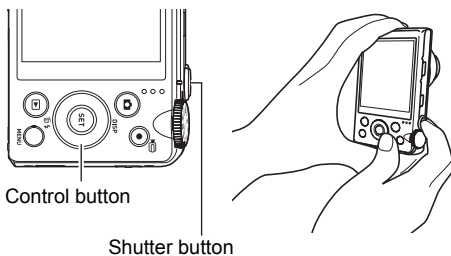

7. Point the camera at the subject you want in the center of the image and then half-press the shutter button to focus.

- The outer blue boundary on the screen indicates the recordable range of the image.



Desired image

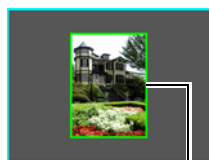

Blue boundary

Center part at the start of the shooting operation

8. Press the shutter button the rest of the way and slowly move the camera in accordance with the instructions and arrow that appear on the monitor screen.

- Holding the camera firmly with both hands, follow the instructions that appear on the monitor screen to slowly slide the camera horizontally or vertically in an arc centered on your body.
 - When sliding the camera horizontally, do not allow your body to move left or right. A vertical line running through your body should serve as the axis.
 - When sliding the camera vertically, do not allow your body to move upwards or downwards. A horizontal line between your shoulders should serve as the axis.
 - Take care not to slide the camera diagonally and be sure to maintain a firm grip on it.
- The camera will start composing the super-wide image internally when the slide cursor reached the other end of the movement range.
- Image composing also will start automatically if you stop moving the camera during super-wide shooting. After you stop moving the camera, the message “Busy... Please wait...” appears as the camera processes the image. Wait until this message disappears before using the camera. Image shooting is disabled while the message is displayed.

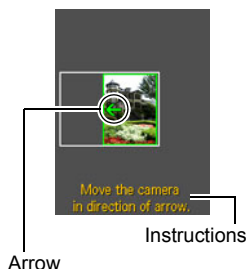

NOTE

- The “14 mm” and “18 mm” angle of view values are approximate and are provided for reference only. Actual angle of view values are not guaranteed.
- Zoom operations are not supported during Wide Shot shooting. The zoom setting is fixed at full wide angle.
- This function makes it possible to shoot images with a maximum angle of view of 14 mm or 18 mm. Note, however, that shooting conditions can result in a smaller angle of view.

- The following conditions are not compatible with Wide Shot shooting.
 - Subject whose brightness is very different from that of its surroundings due to artificial light, sunlight, etc.
 - Rivers, waves, waterfalls, or other subject with constantly changing patterns
 - Sky, beach, or other subject with continuous patterns
 - Camera too close to the main subject
 - Moving subject
 - Panning upwards on a skyscraper or some other very tall structure or object
- Any of the following can cause Wide Shot operation to stop part way through.
 - Subject or camera movement
 - Camera movement that is too fast or too slow
 - Camera movement outside of the required route
 - Camera movement in the wrong direction
- Shooting a Wide Shot image after half-pressing the shutter button to perform Auto Focus may not produce the desired results if there are considerable differences in the brightness, color, and/or focus of the individual images. If this happens, try changing the focus position by focusing on a different subject, etc.
- Since a Wide Shot image is created by joining multiple images together, there may be some roughness at the point where two images are joined.
- Shooting under a flickering light source (such as fluorescent lighting) may result in uneven brightness and/or coloring in the final Wide Shot image.
- Shooting in dark surroundings may result in a blurred image or may make Wide Shot shooting impossible.
- Slowly move the camera at a constant speed in the same direction as the arrow that appears on the monitor screen.
- The exposure and white balance when shooting Wide Shot images are fixed at the levels measured when you half-press the shutter button at the beginning of the operation.
- An error message will appear if the camera is unable to successfully record a series of images.
- If you shoot a moving subject, the camera may not be able to compose the super-wide image properly.
- Super-wide may not produce the desired results when shooting at close distances to the subject.
- With this BEST SHOT scene, the flash setting automatically becomes  (Flash Off).

Shooting with High Speed Night Scene (High Speed Night Scene/High Speed Night Scene and Portrait)

With High Speed Night Scene and High Speed Night Scene and Portrait, the camera detects automatically whether it is being hand-held or on a tripod. If the camera detects it is being hand-held, pressing the shutter button will record a series of images and combine them in a way that minimizes image blur due to low light conditions. If the camera detects it is on a tripod, it will shoot a single image using a longer exposure time (instead of shooting and combining multiple images), which results in an even clearer image. The flash is always disabled while “High Speed Night Scene” is selected. If the night scene image you are shooting includes people, use the “High Speed Night Scene and Portrait” BEST SHOT scene. The flash mode setting becomes **FA** (Auto Flash) when shooting with “High Speed Night Scene and Portrait”.

- 1. In the REC mode, set the mode dial to **BS** (BEST SHOT).**

- 2. Press [SET].**

- 3. Select “High Speed Night Scene” or “High Speed Night Scene and Portrait” and then press [SET].**

- 4. When you are ready to shoot, press the shutter button.**

NOTE

- When holding the camera by hand while shooting with these BEST SHOT scenes, make sure that the subjects remain as still as possible as the camera shoots the series of images.
- Even when holding the camera by hand while shooting with “High Speed Night Scene and Portrait”, under certain conditions the camera may shoot only a single image instead of a series of images.
- Movement while the camera is mounted on a tripod may cause the camera to erroneously judge it is being hand held.
- If surroundings are extremely dark when shooting with “High Speed Night Scene” or “High Speed Night Scene and Portrait”, the camera may not be able to shoot at proper brightness due to insufficient exposure.
- When shooting with these BEST SHOT scenes, the “ISO Sensitivity” setting is fixed at “AUTO”.

Shooting with High Speed Anti Shake (High Speed Anti Shake)

When you press the shutter button while High Speed Anti Shake is enabled, the camera records multiple images and automatically combines them in a way that produces a final image with minimal blur. You can shoot with this feature to minimize the effects of camera movement when shooting with optical Anti Shake does not produce the desired results.

1. In the REC mode, set the mode dial to  (BEST SHOT).

2. Press [SET].

3. Select “High Speed Anti Shake” and then press [SET].

4. When you are ready to shoot, press the shutter button.

NOTE

- With this BEST SHOT scene, the flash setting automatically becomes  (Flash Off).
- High Speed Anti Shake may not operate properly resulting in blurred images if the camera is moved more than the allowable range or if the subject moves during shooting.
- When shooting with this BEST SHOT scene, the “ISO Sensitivity” setting is fixed at “AUTO”.

Shooting with Priority on Subject Faces (High Speed Best Selection)

With High Speed Best Selection, the camera automatically shoots a series of images, and selects the best one based on facial image blur, and facial expression (whether the subject is smiling or blinking).

1. In the REC mode, set the mode dial to  (BEST SHOT).

2. Press [SET].

3. Select “High Speed Best Selection” and then press [SET].

4. Press the shutter button to shoot.

- This will cause the message “Busy... Please wait...” to appear. Do not move the camera while this message is displayed. The recording process takes some time to complete after the message appears.

NOTE

- Shooting with this function causes the flash setting to change automatically to  (Flash Off).
- If one or more of the faces are blurred in all of the images that are shot, they will be blurred in the final image as well.
- The following conditions may make it impossible for the camera to determine if the subject is blinking or smiling. This may result in a final image in which the subject is blinking or not smiling.
 - Faces that are partially or completely darkened by shadows, etc.
 - Hair that is hiding or near the eyes
 - Eye glasses
 - Small faces
 - Faces that are not looking directly at the camera
- Shooting a large group of people will cause processing of the image after shooting to take longer.

Configuring the Camera to Help You Better Time Your Shots (Lag Correction)

There always is some unavoidable time lag between the point you press the shutter button and the point that the image is actually recorded. The “Lag Correction” feature lets you configure the camera to lessen or even eliminate this lag to help you better time your shots and get exactly the moment you want. With “Lag Correction”, you half-press the shutter button and compose the image you want to shoot. Then when you full-press the shutter button, the camera pre-records a total of 5 images, including four images of action that happened before you fully pressed the shutter button. After that, you can view the images on the monitor screen and select the one you want to keep.

1. In the REC mode, set the mode dial to  (BEST SHOT).

2. Press [SET].

3. Select “Lag Correction” and then press [SET].

4. With the camera pointed at the subject, half-press and hold the shutter button.

The camera will start pre-recording images at this time.

- If you release the half-pressed shutter button before pressing it the rest of the way down, all of the pre-recorded images currently in the buffer will be deleted.
-

5. When you are ready to shoot, press the shutter button all the way down.

After pre-recording is complete, one of the five images will appear on the monitor screen for about three seconds.

6. If you want to view all five of the pre-recorded images, press [SET] within about three seconds after a recorded image appears on the monitor screen.

If you do not press [SET] within three seconds, the image displayed in step 4 will be saved automatically as the final image.

7. Use [◀] and [▶] to scroll through the pre-recorded images on the monitor screen.

Use [◀] and [▶] to scroll through the pre-recorded images. Each image appears, along with an indication of the timing when it was pre-recorded.

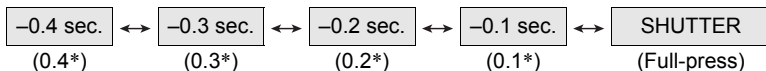

* Seconds prior to full-press of shutter button.

- The timing of the image you select here will be the timing of the image displayed first in step 4 the next time you perform the above procedure. If you select the image that was pre-recorded 0.3 seconds prior to full-press of the shutter button, for example, the -0.3-second image will be displayed in step 4 the next time you perform the above procedure.

8. To save the currently displayed image as the final images, press [SET].

NOTE

- With this BEST SHOT scene, the flash setting automatically becomes  (Flash Off).
- The Self-timer cannot be used with this BEST SHOT scene.
- With this BEST SHOT scene, half-pressing the shutter button fixes focus and exposure at their current levels.
- With this BEST SHOT scene, image recording will not be successful if you full-press the shutter button without allowing enough time (at least 0.4 seconds) after half-pressing it.
- Pay close attention to the subject when shooting. Failure to do so can cause considerable lag from the instant you want to shoot until you actually full-press the shutter button. This can cause image recording to be too late, even if you use this function.
- The current "Review" setting (page 100) is ignored when shooting with this function. Immediately after you full-press the shutter button, one of the five pre-recorded images will appear on the display as in step 4 of the above procedure.

Using the Situation-specific CS Scenes

The High Speed CS capabilities of your EXILIM provide you with a variety of options (Child CS, Pet CS, Sports CS) to suit exactly the type of image you are trying to record. Images continue to be shot as long as you keep the shutter button depressed, with the shooting speed optimized according to the BEST SHOT scene you are using. Prerecord CS (page 53) pre-records images when you half-press the shutter button. Then when you press the shutter button the rest of the way down, the camera stores what is currently in the buffer and starts real-time continuous shutter shooting of new images. Shooting continues until you release the shutter button or until a total of up to 30 images (buffer images plus new images) are shot. Some of the 30 images are of action that occurred before you full-pressed the shutter button and some are after. This helps to ensure you capture exactly the moment you want, even if your timing is slightly off.

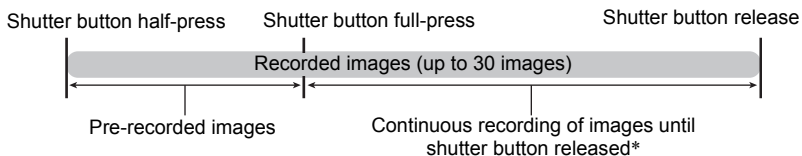

* You can record up to 30 images (pre-recorded buffer images plus real-time images) for each Prerecord CS operation.

1. In the REC mode, set the mode dial to  (BEST SHOT).

2. Press [SET].

3. Select the BEST SHOT scene you want to use and then press [SET].

The following are the settings for each BEST SHOT scene.

Scene Name	CS fps	Maximum CS Shots	Pre-recorded Shots
Child CS	10 fps	20 (2 seconds)	5 (0.5 seconds)
Pet CS	15 fps	30 (2 seconds)	5 (0.3 seconds)
Sports CS	30 fps	30 (1 second)	10 (0.3 seconds)

* You can change the above settings if you want. See page 53 for details.

4. Half-press and hold the shutter button to start pre-recording of images.

A preset number of images are pre-recorded. The pre-recorded images are continually updated until you full-press the shutter button.

- If you release the half-pressed shutter button before pressing it the rest of the way down, all of the pre-recorded images currently in the buffer will be deleted.
- The camera will not emit shutter sounds as it pre-records images.

5. Press the shutter button the rest of the way down.

This will save the pre-recorded images and start shooting new images in real-time. Images continue to be shot as long as you keep the shutter button depressed.

6. Shooting will stop when you release the shutter button or after the maximum number of shots is reached.

NOTE

- Control panel operations, recording, and precautions are the same as those that apply to High Speed CS (page 53). Note, however, that the A, S, and M recording modes cannot be used.
- Prerecord CS (pre-recording of images before the shutter button is full-pressed) is not performed if you full-press the shutter button without half-pressing first. Whenever possible, be sure to half-press the shutter button, compose the image, and then full-press the shutter button.

Using the Situation-specific High Speed Movie Scenes

High Speed Movie provides you with a variety of options (Child High Speed Movie, Pet High Speed Movie, Sports High Speed Movie) to suit exactly the type of movie you are trying to record.

1. In the REC mode, set the mode dial to  (BEST SHOT).



2. Press [SET].

3. Select the BEST SHOT scene you want to use and then press [SET].

Scene Name	Frame Rate
Child High Speed Movie	120 fps
Pet High Speed Movie	240 fps
Sports High Speed Movie	480 fps

4. Record the movie the same way as you would a normal movie (page 64).

Press  (Movie) to start and stop recording.

- During High Speed Movie recording, focus is fixed at the position where it was when recording started. To focus an image, half-press the shutter button for Auto Focus or focus manually before you press  (Movie) to start recording.
- To return to normal snapshot recording, set the mode dial to  (Auto).

NOTE

- These BEST SHOT scenes always shoot using High Speed Movie. The current " Quality" setting is ignored.
- Precautions and the shooting procedure are the same as those for High Speed Movie recording (page 67), except that the following functions are disabled.
 - A, S, M recording mode settings
 - Prerecord Movie
 - YouTube movie recording

Advanced Settings

The following are menu operations you can use to configure various camera settings.

Using On-screen Menus

■ Example Menu Screen Operation

1. In the REC mode, press [MENU].

This will display the menu screen.

- Menu contents are different in the REC mode and PLAY mode.

2. Use [◀] and [▶] to select the tab where the menu item you want to configure is located.

3. Use [▲] and [▼] to select the menu item you want, and then press [▶].

4. Use [▲] and [▼] to change the setting of the selected menu item.

5. After the setting is the way you want, press [SET] to apply the setting and return to the viewfinder screen.

- Pressing [◀] registers the selected setting and returns to the menu.
- To configure settings on another tab after pressing [◀] to return to the menu item selection, use [▲] to move the highlighting up to the tabs, and then use [◀] and [▶] to select the tab you want.
- Pressing [MENU] interrupts the menu operation and exits the menu screen.

[▲] [▼] [◀] [▶]

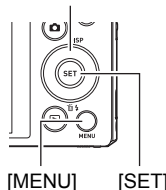

Example:
When "Self-timer" is selected on the "REC" tab



★ IMPORTANT!

- Switching from "Auto" to "Premium Auto PRO" (page 28) will make some menu items unavailable.

■ Menu Operations in This Manual

Menu operations are represented in this manual as shown below. The following operation is the same as the one described under “Example Menu Screen Operation” on page 89.

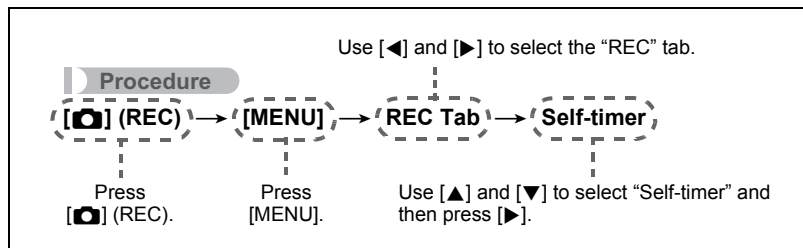

REC Mode Settings (REC)

Zooming with Super Resolution (Zoom (SR))

Procedure





[] (REC) → [MENU] → REC Tab → Zoom (SR)

See page 52 for details.

Selecting a Focus Mode (Focus)

Procedure

[] (REC) → [MENU] → REC Tab → Focus

Settings	Type of Shot	Focus Mode		Approximate Focus Range* ¹	
		Snapshot	Movies	Snapshot	Movies
 Auto Focus	General recording	Automatic	Automatic* ³	Approximately 5 cm to ∞ (infinity) (2.0" to ∞) (Wide Angle)* ²	
 Macro	Close ups	Automatic	Automatic* ³	Approximately 1 cm to 50 cm (0.4" to 19.7") (Fifth step zoom from the Widest Angle setting)* ²	
 Super Macro	Close ups	Automatic	Automatic* ³	Approximately 1 cm to 50 cm (0.4" to 19.7")	
 Infinity	Scenery and other distant subjects	Fixed		Infinity (Wide Angle)	
 Manual Focus	When you want to focus manually	Manual		Approximately 5 cm to ∞ (infinity) (2.0" to ∞) (Wide Angle)* ²	

*1 The focus range is the distance from the lens surface.

*2 The focus range depends on the current optical zoom position.

*3 During High Speed Movie recording, focus is fixed at the position where it was when recording started. To focus an image, half-press the shutter button for Auto Focus or focus manually before you press [] (Movie) to start recording.

Super Macro

Super Macro fixes optical zoom at a position that allows you to shoot from the closest distance to the subject. The result is closer and larger subject images.

NOTE

- Zoom is fixed while Super Macro is selected, so no zoom operation is performed when you slide the zoom controller.

To focus with manual focus

1. On the monitor screen, compose the image so the subject you want to focus on is within the yellow boundary.

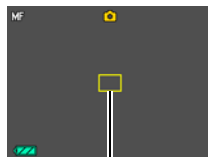

Yellow boundary

2. Watching the image on the monitor screen use [◀] and [▶] to adjust focus.

- At this time the image that is within the boundary will enlarge and fill the monitor screen, which aids in focusing. If you do not perform any operation for two seconds while the enlarged image is displayed, the screen in step 1 will re-appear.

NOTE

- An Auto Macro feature detects how far the subject is from the lens and automatically selects either Macro Focus or Auto Focus accordingly.
- Use of the flash together with Macro Focus can cause the light of the flash to become blocked, which may result in unwanted lens shadows in your image.
- In the case of movie recording, Auto Macro operates before you start recording. After recording is started, however, focus is fixed.
- Whenever you perform an optical zoom operation while shooting with Auto Focus, Macro Focus, or Manual Focus, a value will appear on the monitor screen to tell you the focus range, as shown below. Note that the focus range is displayed including the Auto Macro range only when shooting with Auto Focus.

Example: ○○ cm to ∞

* ○○ is the actual focusing range value.

- The operations assigned to the [◀] and [▶] keys with the "L/R Key" setting (page 99) are disabled while Manual Focus is selected as the focus mode.
- Turning on "Face Detection" causes the focus mode to change automatically to **AF** (Auto Focus). Changing the focus mode setting to anything other than **AF** (Auto Focus) causes "Face Detection" to turn off automatically.

Using Focus Lock

“Focus lock” is a technique you can use when you want to compose an image in which the subject you want to focus on is not within the focus frame in the center of the screen.

- To use focus lock, select “[**AF**] Spot” or “[**AF**] Tracking” for the Auto Focus area (page 96).

1. Align the monitor screen’s focus frame with the subject you want to focus on and then half-press the shutter button.

Subject to be focused on

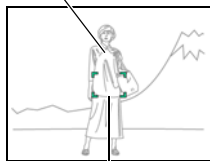

Focus frame

2. Keeping the shutter button half-pressed (which maintains the focus setting), move the camera to compose the image.

- When “[**AF**] Tracking” is selected as the Auto Focus area, the focus frame will move automatically and follow the subject.



3. When you are ready to shoot the image, press the shutter button the rest of the way down.

NOTE



- Focus lock also locks exposure (AE).

Using the Self-timer (Self-timer)

Procedure

[] (REC) → [MENU] → REC Tab → Self-timer

With the Self-timer, pressing the shutter button starts a timer. The shutter is released and the image is shot after a fixed amount of time.

 10 sec	10-second Self-timer
 2 sec	2-second Self-timer • When shooting under conditions that slow down the shutter speed, you can use this setting to prevent image blur due to camera movement.
 X3 (Triple Self-timer)	Shoots three images: one image 10 seconds after the shutter button is pressed, and the next two images as soon as the camera is ready after shooting the previous image. How long it takes for the camera to get ready to shoot depends on the image size and quality settings, whether or not a memory card is loaded in the camera, and the flash charge condition.
Off	Self-timer is disabled.

- The front lamp flashes while the Self-timer countdown is in progress.
- You can interrupt an ongoing Self-timer countdown by pressing [SET].

Front lamp

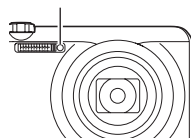

NOTE



- The Self-timer cannot be used together with the following features. High Speed CS with Prerecord CS, Prerecord (Movie), Lag Correction, Child CS, Pet CS, Sports CS, Slide Panorama, Wide Shot
- The Triple Self-timer cannot be used together with the following features. Movie, High Speed CS, Multi SR Zoom, Child High Speed Movie, Pet High Speed Movie, Sports High Speed Movie, High Speed Best Selection, For YouTube, Blurred Background

Reducing the Effects of Camera and Subject Movement (Anti Shake)

Procedure

[] (REC) → [MENU] → REC Tab → Anti Shake

You can turn on the camera's Anti Shake feature to reduce image blur due to subject movement or camera movement when shooting a moving subject using telephoto, when shooting a fast-moving subject, or when shooting under dim lighting conditions.

 On	Minimizes the effects of hand and subject movement.
Off	Turns off Anti Shake settings.
 DEMO	Half-pressing the shutter button demonstrates the effect of Anti Shake. However, the image is not recorded.

NOTE

- Only camera shake correction can be used during FHD and STD movie recording.
- Anti Shake correction is not supported during High Speed Movie or HDR Art Movie recording.
- ISO sensitivity, aperture, and shutter speed do not appear on the monitor screen when you half-press the shutter button while "On" is selected. These values will appear briefly, however, in the preview image that is displayed immediately after you shoot a snapshot.
- Shooting while "On" is selected can cause an image to appear somewhat coarser than normal and can cause slight deterioration of image resolution.
- Anti Shake may not be able to eliminate the effects of camera or subject movement when movement is severe.
- Anti Shake may not work properly when the camera is mounted on a tripod. Turn off Anti Shake.

Specifying the Auto Focus Area (AF Area)

Procedure

[] (REC) → [MENU] → REC Tab → AF Area

You can use the following procedure to change the Auto Focus metering area for shooting snapshots.

- When recording movies, the AF metering area is always “[] Spot”.

Intelligent	The camera automatically determines the focus point on the screen and focuses there (intelligent AF). <ul style="list-style-type: none">• Face detection (page 97) operates automatically.
Spot	This mode takes readings of a small area in the center of the image. This setting works well with focus lock (page 93).
Multi	When you half-press the shutter button while this setting selected, the camera will select the optimum Auto Focus area from among nine possible areas. The focus frame of the area where the camera focuses will be displayed in green.
Tracking	When you half-press the shutter button while this setting is selected, the focus frame will follow the movement of the subject.

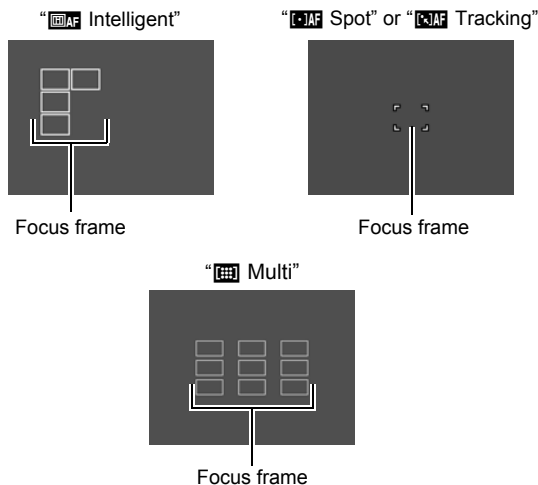

- “[] Tracking” cannot be used in combination with some BEST SHOT scenes.
- “[] Multi” cannot be selected for the AF area while Face Detection is enabled.

Using the Auto Focus Assist Light (AF Assist Light)

Procedure

[] (REC) → [MENU] → REC Tab → AF Assist Light

Half-pressing the shutter button while this setting is selected causes the front lamp to light, which provides illumination for focusing in areas where lighting is dim. Leaving this function turned off is recommended when shooting portraits from short distances, etc.

Front lamp

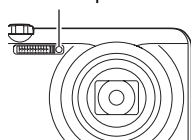

IMPORTANT!

- Never look directly into the front lamp while it is lit.
- Make sure your finger is not covering the front lamp.

Shooting with Face Detection (Face Detection)

Procedure

[] (REC) → [MENU] → REC Tab → Face Detection

When shooting people, the face detection feature detects the faces of up to ten individuals and adjusts focus and brightness accordingly.

1. Use [◀] and [▶] to select “On” and then press [SET].

2. Point the camera at the subject(s).

The camera will detect human faces and display a frame around each one.

3. Half-press the shutter button.

The camera will focus and the frames around the faces it focuses on will turn green.



4. Press the shutter button the rest of the way down.

Tips for Best Face Detection Results

- The camera performs center focus if it cannot detect a face.
- Always make sure that Auto Focus (AF) is selected as the focus mode when shooting with face detection.
- Detection of the following types of faces is not supported.
 - A face that is obstructed by hair, sunglasses, a hat, etc., or a face in dark shade
 - A profile or a face that is at an angle
 - A face that is very far away and small, or very close and large
 - A face in an area that is very dark
 - A face of a pet or some other non-human subject



IMPORTANT!

- Face detection cannot be used in combination with any of the following features.
 - Some BEST SHOT scenes
 - Movie Mode (Including some BEST SHOT scenes that support High Speed Movie recording)
 - High Speed CS with Prerecord CS (Including some BEST SHOT scenes that support High Speed CS recording)
- The “Focus” setting is always fixed at **AF** (Auto Focus) whenever “Face Detection” is being used. If you want to change the “Focus” setting, first select “Off” for “Face Detection”.

Shooting with Continuous Auto Focus (Continuous AF)

Procedure

[📷] (REC) → [MENU] → REC Tab → Continuous AF

When shooting a snapshot while “On” is selected for Continuous AF, Auto Focus is performed and focusing is continually updated until you half-press the shutter button.

- Before you half-press the shutter button, the camera focuses at the center of the screen.

Turning Digital Zoom On or Off (Digital Zoom)

Procedure

[] (REC) → [MENU] → REC Tab → Digital Zoom

Select "On" when you want to use digital zoom (page 50).

- Digital zoom is disabled while shooting with the following feature.
 - High speed movie recording

Reducing Wind Noise during Movie Recording (Wind Noise Cut)

Procedure

[] (REC) → [MENU] → REC Tab → Wind Noise Cut





Select "On" to reduce wind noise during movie recording. Note, however, that this will also cause the sound quality to change.

Assigning Functions to the [◀] and [▶] Keys (L/R Key)

Procedure

[] (REC) → [MENU] → REC Tab → L/R Key

You can assign one of the seven functions listed below to the [◀] and [▶] keys.

Setting	[◀]/[▶] key operation
 →  →  → 	Selecting a Focus Mode (page 91) <ul style="list-style-type: none">•  (Manual Focus) cannot be selected.
Metering	Changes the Metering Mode (page 103)
Self-timer	Sets the self-timer time (page 94)
Face Detection	Turns face detection on and off (page 97)
ISO	Specifying ISO Sensitivity (page 44)
White Balance	Adjusting White Balance (page 45)
EV Shift	Correcting Image Brightness (page 46)
Off	Cancels [◀] and [▶] key assignments

Displaying the On-screen Grid (Grid)

Procedure

[] (REC) → [MENU] → REC Tab → Grid

The on-screen grid can be displayed on the REC mode monitor screen for easy vertical and horizontal alignment when composing images.

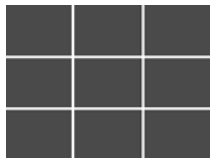

Turning on Image Review (Review)

Procedure

[] (REC) → [MENU] → REC Tab → Review

While Review is turned on, the camera will display a image for about one second immediately after you press the shutter button to record it.

- Image review is available only when shooting single images. It does not work with continuous shutter.
- When shooting with some functions while “On” is selected for “Review” will cause the message “Busy... Please wait...” to appear after you press the shutter button. Shooting another image is disabled while this message is displayed. Wait a while until the process being performed is complete.

Using Icon Help (Icon Help)

Procedure

[] (REC) → [MENU] → REC Tab → Icon Help

While Icon Help is turned on, a textual description will appear on the display for certain icons when you switch between REC functions.

Functions Supported by Icon Help

- Recording mode
- Available options for the “L/R Key” setting
- Exposure warning when shutter button is half-pressed

Configuring Power On Default Settings (Memory)

Procedure

[] (REC) → [MENU] → REC Tab → Memory

This setting lets you specify which camera settings should be remembered by the camera when it is turned off, and restored the next time the camera is turned on. To have the camera remember a setting, you should enable the setting's memory. Any setting whose memory is disabled will be reset to its initial default any time the camera is turned off.

Setting	Disabled (Initial Default Setting)	Enabled
Flash	Auto	Setting at power off
Focus	AF (Auto Focus)	
ISO	Auto	
White Balance	Auto WB	
EV Shift	0.0	
AF Area	Spot	
Metering	Multi	
Self-timer	Off	
Flash Intensity	0	
Zoom (SR)	Single	
Digital Zoom	On	
MF Position	Position before manual focus was selected.	
Zoom Position*	Full wide	

* Optical zoom setting only.

Image Quality Settings (Quality)

Specifying Snapshot Image Quality (Quality (Snapshot))

Procedure

[] (REC) → [MENU] → Quality Tab →  Quality (Snapshot)

Fine	Gives image quality priority
Normal	Normal

- The “Fine” setting helps to bring out details when shooting dense tree branches or leaves, a complex pattern, etc.
- Memory capacity (the number of images you can record) will be affected by the quality settings you configure (page 194).

Movie Image Quality Settings (Quality (Movie))

Procedure

[] (REC) → [MENU] → Quality Tab →  Quality (Movie)

This setting can be used to configure movie image quality settings and to select either normal movie recording or High Speed Movie recording.



FHD	Select this setting record high-definition (FHD) movies (page 67). The aspect ratio of movies recorded with this setting is 16:9.
HD	Select this setting record high-definition (HD) movies. The aspect ratio of movies recorded with this setting is 16:9. <ul style="list-style-type: none">• “HD” appears in place of “FHD” when you are shooting with “HDR Art” (page 60).
STD	Use this setting for standard movie recording. Recording with this setting is performed using an aspect ratio of 4:3, an image size of 640×480 pixels, and a frame rate of 30 frames per second. Image quality and image size settings cannot be changed (page 64).
HS120 HS240 HS480 HS1000 HS30-120 HS30-240	The image size of movies recorded with this mode depends on the frame rate (recording speed (page 67)).

Specifying the Metering Mode (Metering)

Procedure

[] (REC) → [MENU] → **Quality Tab** → **Metering**

The metering mode determines what part of the subject is metered for exposure.

 Multi	Multi-pattern metering divides the image into sections and measures the light in each section for a balanced exposure reading. This type of metering provides error-free exposure settings for a wide range of shooting conditions.
 Center Weighted	Center weighted metering concentrates on the center of the focus area to measure light. This type of metering is best when you want some level of control over contrast.
 Spot	Spot metering takes readings at a very small area. Use this metering method when you want exposure to be set according to the brightness of a particular subject, without being affected by surrounding conditions.

Optimizing Image Brightness (Lighting)

Procedure

[] (REC) → [MENU] → **Quality Tab** → **Lighting**

You can use this setting to optimize the balance between bright areas and dark areas when shooting images.

On	Performs brightness correction. When this option is selected, it takes longer for the image to be stored after the shutter button is pressed.
Off	Does not perform brightness correction.

Specifying Flash Intensity (Flash Intensity)

Procedure

[] (REC) → [MENU] → Quality Tab → Flash Intensity

You can specify flash intensity to one of five levels from +2 (brightest flash) to -2 (least bright flash).

- Flash intensity may not change when the subject is too far away or too close.

Using Built-in Color Filters (Color Filter)

Procedure

[] (REC) → [MENU] → Quality Tab → Color Filter

Settings: Off, B/W, Sepia, Red, Green, Blue, Yellow, Pink, and Purple

Controlling Image Sharpness (Sharpness)

Procedure

[] (REC) → [MENU] → Quality Tab → Sharpness

You can specify one of five sharpness settings from +2 (sharpest) to -2 (least sharp).

Controlling Color Saturation (Saturation)

Procedure

[] (REC) → [MENU] → Quality Tab → Saturation

You can specify one of five saturation settings from +2 (most saturated) to -2 (least saturated).

Adjusting Image Contrast (Contrast)

Procedure

[] (REC) → [MENU] → Quality Tab → Contrast

You can specify one of five contrast settings from +2 (most contrast between light and dark) to -2 (least contrast between light and dark).

Viewing Snapshots and Movies

Viewing Snapshots

See page 32 for the procedure for viewing snapshots.

Viewing a Movie

1. Press [▶] (PLAY) and then use [◀] and [▶] to display the movie you want to view.
2. Press [SET] to start playback.



Movie Playback Controls

Fast forward/fast reverse	[◀] [▶] (Playback in progress.) <ul style="list-style-type: none">• Each press of either button increases the speed of the fast forward or fast reverse operation.• To return to normal playback speed, press [▼].
Play/pause	[SET]
1 frame forward/back	[◀] [▶] (Playback paused.) <ul style="list-style-type: none">• Holding down either button scrolls continuously.
Volume adjustment	Press [▼] and then press [▲] [▼] <ul style="list-style-type: none">• Volume can be adjusted only while movie playback is in progress.
Information display on/off	[▲] (DISP)
Zoom	Slide the zoom controller in the direction of [▲] (Q). <ul style="list-style-type: none">• You can use [▲], [▼], [◀], and [▶] to scroll the zoomed image on the monitor screen. You can zoom a movie image up to 4.5 times normal size.
Stop playback	[MENU]

- Playback may not be possible for movies not recorded with this camera.

Viewing a Panorama Image

1. Press [▶] (PLAY), and then use [◀] and [▶] to display the panorama images you want to view.



2. Press [SET] to start playback of the panorama.

Panorama playback causes the image to scroll left, right, up, or down.

Playback Controls

To start or pause playback	[SET]
To advance scroll while paused	[◀] [▶] (When the slide direction is left or right.) [▲] [▼] (When the slide direction is up or down.) • Holding down any button scrolls continuously.
To hide or show display information	[▲] (DISP)
To stop playback	[MENU]

- The following functions cannot be performed on a panorama image.
Dynamic Photo, Movie Converter, MOTION PRINT, Movie Editing, Trimming, Resize, Lighting, White Balance, Brightness, Rotation

Viewing Continuous Shutter Images

Each time you perform a continuous shutter (CS) operation, the camera creates a CS group that includes all of the images for that particular CS session. You can use the following procedure to play back the images in a particular CS group.

1. Press [▶] (PLAY) and then use [◀] and [▶] to display the CS group whose images you want to view.

Number of image files in the CS group



CS group icon

First image in the CS group

2. About one second after you select a CS group, high speed playback of its images will start automatically.

- After playback of a CS Group is complete, the first image of the group will be displayed on the monitor screen.
- Pressing [SET] will pause playback. While playback is paused, you can adjust the playback speed, specify the playback direction, scroll forward or back, zoom images, and delete images.



CS speed



Current image number/number of images in the group

Playback guide

The following are operations that are supported after you press [SET] to start image playback.

[◀] [▶]	During playback, changes the playback direction and playback speed. While playback is paused, scrolls forward or back. <ul style="list-style-type: none">• Playback speed cannot be adjusted while the displayed image is zoomed.
[SET]	Toggles between pause and play.
Zoom controller	Zooms the image. <ul style="list-style-type: none">• You can use [▲], [▼], [◀], and [▶] to scroll the zoomed image on the monitor screen.• Sliding the zoom controller towards  () while an image is not zoomed will display a menu of images in the current CS group.
[MENU]	Exits CS group playback.
[▲] (DISP)	Cycles through information display formats.
[▼]	Displays the “CS Frame Edit” menu.

Deleting Continuous Shutter Images

You can use the following procedures to delete images while playback is in progress or paused.

■ Deleting a Specific CS Group File

1. While CS image playback is in progress or paused (toggle by pressing [SET]), press [▼].

This will display the “CS Frame Edit” menu.

2. Use [▲] and [▼] to select “Delete” and then press [SET].

3. Use [◀] and [▶] to display the image you want to delete.

4. Use [▲] and [▼] to select “Delete” and then press [SET].

- To delete other files, repeat steps 3 and 4.
- To exit the delete operation, press [MENU].

■ Deleting Multiple Files in a CS Group

1. While CS image playback is in progress or paused (toggle by pressing [SET]), press [▼].

This will display the “CS Frame Edit” menu.

2. Use [▲] and [▼] to select “Delete” and then press [SET].
-

3. Use [▲] and [▼] to select “Delete Frames” and then press [SET].

- This displays a file selection screen.
-

4. Use [▲], [▼], [◀], and [▶] to move the selection boundary to the file you want to delete, and then press [SET].

- This will select the check box of the currently selected file.
 - You can enlarge the selected image before deleting it by sliding the zoom controller towards [▲] (Q).
-

5. Repeat step 4 to select other files, if you want. After you are finished selecting files, press [MENU].
-

6. Use [▲] and [▼] to select “Yes” and then press [SET].

- This deletes the files you selected.
- To cancel the delete operation, select “No” in step 6 and then press [SET].

■ Deleting All Files in a CS Group

1. While CS image playback is in progress or paused (toggle by pressing [SET]), press [▼].

This will display the “CS Frame Edit” menu.

2. Use [▲] and [▼] to select “Delete” and then press [SET].
-

3. Use [▲] and [▼] to select “Del Group Images” and then press [SET].
-

4. Use [▲] and [▼] to select “Yes”, and then press [SET].

Dividing Up a CS Group

Use the following to divide up a CS Group into individual images.

■ Dividing Up a Specific CS Group

1. While a CS group is displayed or while the images of a CS group are scrolling on the monitor screen, press [MENU].

2. Use [◀] and [▶] to select the “PLAY” tab.

3. Use [▲] and [▼] to select “Divide Group” and then press [▶].

4. Use [◀] and [▶] to display the CS group you want to divide up.

5. Use [▲] and [▼] to select “Divide” and then press [SET].
 - To divide up other CS group files, repeat steps 4 and 5.

■ Dividing Up All CS Groups



IMPORTANT!

- Once a CS group is divided, it cannot be regrouped.
1. While a CS group is displayed or while the images of a CS group are scrolling on the monitor screen, press [MENU].

 2. Use [◀] and [▶] to select the “PLAY” tab.

 3. Use [▲] and [▼] to select “Divide Group” and then press [▶].

 4. Use [▲] and [▼] to select “Divide All Groups” and then press [SET].

 5. Use [▲] and [▼] to select “Yes”, and then press [SET].

Copying a CS Group Image

Use the following procedure to copy an image in a CS group to a location outside of the group.

- 1. While CS image playback is in progress or paused (toggle by pressing [SET]), press [▼].**

This will display the “CS Frame Edit” menu.

- 2. Use [▲] and [▼] to select “Copy”, and then press [SET].**

- 3. Use [◀] and [▶] to display the image you want to copy.**

- 4. Use [▲] and [▼] to select “Copy”, and then press [SET].**

NOTE

- The functions below cannot be performed on snapshots inside a CS group. Before using either of these functions, perform the above procedure to copy the image first.

White Balance, Brightness, Trimming, Rotation, Resize

Zooming an On-screen Image

1. In the PLAY mode, use [◀] and [▶] to scroll through the images until the one you want is displayed.

2. Slide the zoom controller towards [🔍] (🔍) to zoom.

You can use [▲], [▼], [◀], and [▶] to scroll the zoomed image on the monitor screen. Slide the zoom controller towards [🔍] to unzoom the image.

- When monitor screen contents are turned on, a graphic in the lower right corner of the screen shows what part of the zoomed image is currently displayed.
 - To exit the zoom screen, press [MENU].
 - Though the maximum image zoom factor is 8X, certain image sizes may not allow zooming up to the full 8X.
- Pressing [SET] will lock the current zoom factor for the on-screen image. You can then use [◀] and [▶] to scroll between images, using the same zoom factor. Pressing [SET] again will unlock the zoom factor and allow you to use [▲], [▼], [◀] and [▶] to move around the currently displayed images. This function cannot be used while viewing CS group images or movies. Also, CS group images and movies will not appear when you are scrolling images with [◀] and [▶].

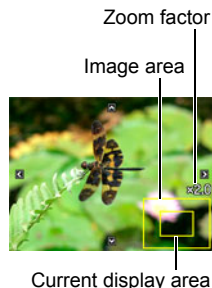

Displaying the Image Menu

1. In the PLAY mode, slide the zoom controller towards [🔍] (🔍).

Use [▲], [▼], [◀] and [▶] to move the selection boundary around the image menu.

To view a particular image, use [▲], [▼], [◀], or [▶] to move the selection boundary to the image you want and then press [SET].

- In the case of a movie or a continuous shutter (CS) file, the first frame of the file will be displayed.



Viewing Snapshots and Movies on a TV Screen

1. Use the optionally available AV cable (EMC-8A) to connect the camera to the TV.

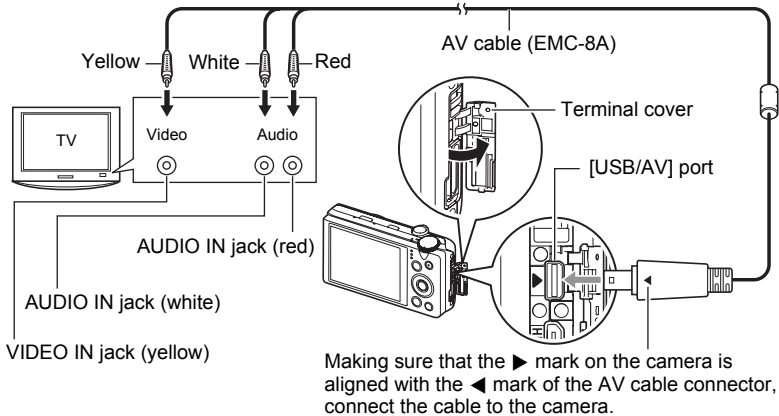

- Make sure that you insert the cable connector into the USB/AV port until you feel it click securely into place. Failure to insert the connector fully can result in poor communication or malfunction.
- Note that even while the connector is fully inserted, you still will be able to see the metal part of the connector as shown in the illustration.
- Make sure that the camera is turned off before plugging in or unplugging the cable. Check the user documentation that comes with the TV for information about requirements before plugging into or unplugging from the TV.

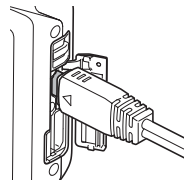

2. Turn on the TV and select its video input mode.

If the TV has more than one video input, select the one where the camera is connected.

3. Press [▶] (PLAY) to turn on the camera.

This will cause an image to appear on the TV screen, without anything appearing on the camera's monitor screen.

- Pressing [ON/OFF] (Power) or [📷] (REC) will not turn on the camera while the AV cable is connected.
- You also can change the aspect ratio of the screen and the video output system (page 167).

4. Now you can display images and play back movies as you normally do.



IMPORTANT!

- Before connecting to a TV to display images, be sure to configure the camera's [📷] (REC) and [▶] (PLAY) buttons for "Power On" or "Power On/Off" (page 166).
- Audio is initially output by the camera at maximum volume. When you first start displaying images, set the TV volume control at a relatively low level and then adjust it as required.

NOTE

- Audio is stereo.
- Some TVs may not be able to output images and/or audio correctly.
- All icons and indicators that appear on the monitor screen also appear on the TV screen. You can use [▲] (DISP) to change the display contents.
- Normally connecting the camera to a TV during recording will cause the camera's monitor screen to go blank and display the image picked up by the camera on the TV screen. If you are using Wide Shot (page 78), the image will be shown on the monitor screen but not the TV screen. Image recording can be performed in either case.

Viewing High-quality Movies on a Hi-Vision Television

Use a commercially available HDMI cable to connect the camera to the TV. For information about playback, see the procedure starting from step 2 under “Viewing Snapshots and Movies on a TV Screen” on page 113.



- Use a commercially available HDMI cable that is marked with the logo shown to the right.

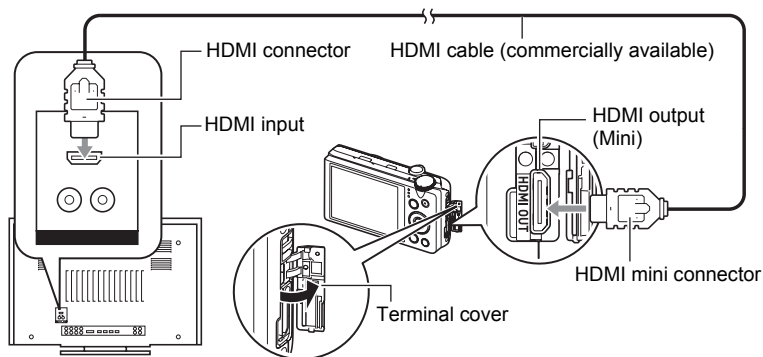

IMPORTANT!

- Output to a TV is not supported while the camera is in the REC mode.

NOTE

- Use a HDMI cable that with a plug that is compatible with the camera's HDMI mini connector on one end, and a plug that is compatible with your TV's HDMI connector on the other end.
- Proper image and/or audio output and other operations may not be possible with some devices.
- Connecting the camera to the HDMI connector of another device can damage both the camera and the other device. Never connect two HDMI output connectors to each other.
- Make sure that the camera is turned off before plugging in or unplugging the cable. Check the user documentation that comes with the TV for information about requirements before plugging into or unplugging from the TV.
- When cables are connected to both the USB/AV port and the HDMI output connector, the HDMI output connector connection is given priority.
- Disconnect the HDMI cable when you are not using HDMI output. The camera's monitor screen may not operate normally while the HDMI cable is connected.
- Audio is stereo.
- Audio is initially output by the camera at maximum volume. When you first start displaying images, set the TV volume control at a relatively low level and then adjust it as required.

■ Selecting the HDMI Terminal Output Method (HDMI Output)

Procedure

[MENU] → Set Up Tab → HDMI Output

Use this setting to select the digital signal format when connecting to a TV with an HDMI cable.

Auto	This setting will cause the format to change automatically in accordance with the connected TV. Normally, you should use this mode.
1080i	1080i format output*
480p	480p format output
576p	576p format output

* 1080i corresponds to 1080 60i, but not 1080 50i. Because of this, the required output method may be 576p when outputting to a digital TV in a PAL reception area that does not support 1080i 60i. If you are in a PAL reception area and nothing is displayed automatically, change the setting to 576p.

- If an image does not appear when "Auto" is selected as the output method, try changing this setting to something else.



IMPORTANT!

- The "HDMI Output" setting cannot be changed as long as there is an HDMI cable connection between the camera and a TV. Disconnect the HDMI cable from the camera to change the "HDMI Output" setting.

Recording Camera Images to a DVD Recorder or Video Deck

Use the following method to connect the camera to the recording device using the AV cable (option).

- DVD recorder or video deck: Connect the AV cable to the VIDEO IN and AUDIO IN terminals.
- Camera: Connect the AV cable to the USB/AV port.

You can play a slideshow of snapshots and movies on the camera and record it on a DVD or video tape. You can record movies by selecting "Movie Only" for the slideshow "Images" setting (page 117).

For information about connecting a monitor to the recording device and about how to record, see the user documentation that comes with the recording device you are using.

Other Playback Functions (PLAY)



This section explains menu items that you can use to configure settings and perform other playback operations.

For information about menu operations, see page 89.

Playing a Slideshow on the Camera (Slideshow)

Procedure

[▶] (PLAY) → [MENU] → PLAY Tab → Slideshow

Start
Starts the slideshow
Images
Specifies the type of images to be included in the slideshow All images: Snapshots, movies, continuous shutter images All images except  : All non-continuous shutter (CS) images  Only: Snapshots only  Only: Movies only
Time
Time from the start to the end of the slideshow 1 to 5 minutes, 10 minutes, 15 minutes, 30 minutes, 60 minutes
Interval
Amount of time each image remains displayed Use [◀] and [▶] to select a value from 1 to 30 seconds, or "MAX". If you specify a value from 1 to 30 seconds, movies play from beginning to end. When the slideshow reaches a movie file while "MAX" is selected, only the first frame of the movie will be displayed.

Effect

Select the effect you want.

Pattern 1 to 5: Plays background music and applies an image change effect.

- Patterns 2 through 4 have different background music, but they all use the same image change effect.
- Pattern 5 can be used for playback of snapshots only (except for those that are part of a CS group), and the "Interval" setting is ignored.
- The currently selected image change effect setting is disabled automatically in following cases.
 - When playing a slideshow for which "📷 Only" is selected for the "Images" setting
 - When the interval setting is "MAX", 1 second, or 2 seconds
 - Before and after playback of a movie
 - During CS group playback (Except the Pattern 1 effect)

Off: No image change effect or background music

- To stop the slideshow, press [SET] or [MENU]. Pressing [MENU] stops the slideshow and returns to the menu screen.
- Adjust audio volume by pressing [▼] and then press [▲] or [▼] during playback.
- All button operations are disabled while the slideshow is transitioning from one image to another.
- The time required for transition from one image to another may be longer in the case of an image that was not recorded with this camera.

Transferring Music from Your Computer to Camera Memory

You can replace the built-in slideshow background music with other music from your computer.

Supported File Types:

- PCM format (16-bit, monaural / stereo) WAV files
- Sampling Frequencies: 11.025 kHz/22.05 kHz/44.1 kHz

Number of Files: 9

File names: SSBGM001.WAV to SSBGM009.WAV

- Create the music files on your computer using the above names.
- Regardless of which effect pattern you select, the music files you store in camera memory are played back in name sequence.

1. Connect the camera to your computer (pages 143, 152).

If you plan to save the music files to the camera's memory card, make sure the card is loaded in the camera.

2. Perform one of the following operations to open the memory card or built-in memory.

This will cause the camera to be recognized by your computer as a Removable Disk (Drive).

- Windows
 - ① Windows 7, Windows Vista: Start → Computer
 - Windows XP: Start → My Computer
 - ② Double-click "Removable Disk".
- Macintosh
 - ① Double-click the camera's drive icon.

3. Create a folder named "SSBGM".

4. Double-click the "SSBGM" folder you created and copy the background music file to it.



- See the user documentation that comes with your computer for information about moving, copying, and deleting files.
- If there are background music files both in built-in memory and on the memory card loaded in the camera, the files on the memory card take priority.
- See page 158 for information about camera folders.

5. Disconnect the camera from the computer (pages 145, 154).

Creating a Snapshot of Movie Frames (MOTION PRINT)

Procedure

[] (PLAY) → Movie Screen → [MENU] → PLAY Tab → MOTION PRINT

1. Use [] and [] to scroll through the movie frames and display the one you want to use as the image of the MOTION PRINT image.

Holding down [] or [] scrolls at high speed.

2. Use [] and [] to select “Create” and then press [SET].



- Only the frames of movies recorded on this camera can be used in a MOTION PRINT image.



Editing a Movie on the Camera (Movie Editing)

Procedure



[] (PLAY) → Movie Screen of Movie to be Edited → [MENU] → PLAY Tab → Movie Editing

The Movie Editing feature lets you use one of the following procedures to edit out a specific part of a movie.

 Cut (To-Point Cut)	Cuts everything from the beginning of the movie up to the current location.
 Cut (Point-To-Point Cut)	Cuts everything between two points.
 Cut (From-Point Cut)	Cuts everything from the current location to the end of the movie.

1. Use [] and [] to select the editing method you want to use and then press [SET].

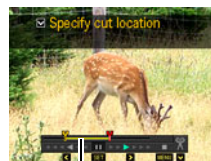

2. Use the following operations to select the frame (point) from which or to which you want to cut the movie (the cut point).

[] []	During playback, changes the playback direction and playback speed. While playback is paused, scrolls forward or back.
[SET]	Toggles between pause and play.



Cut range (yellow)

3. Press [▼] to display the editing menu and specify one or two cut points.

 Cut (To-Point Cut)	While the frame you want the cut to be up to is displayed, press [▼].
 Cut (Point-To-Point Cut)	① While the frame you want the first (From) cut to be is displayed, press [▼]. ② Select another frame. ③ While the frame you want the second (To) cut to be is displayed, press [▼].
 Cut (From-Point Cut)	While the frame you want the cut to be from is displayed, press [▼].

4. Use [▲] and [▼] to select “Yes” and then press [SET].

The selected cut operation will take considerable time to complete. Don't try to perform any camera operation until the “Busy... Please wait...” message disappears from the monitor screen. Note that a cut operation can take a long time if the movie being edited is long.

IMPORTANT!

- When you edit a movie, only the result is saved. The original movie is not retained. An editing operation cannot be undone.

NOTE

- A movie that is shorter than five seconds cannot be edited.
- Editing of movies recorded with a different type of camera is not supported.
- You will not be able to edit a movie if the amount of remaining memory capacity is less than the size of the movie file you want to edit. If there is not enough memory available, delete files you no longer need to free up more.
- Splitting of a movie into two movies and splicing of two different movies into a single movie are not supported.
- You also can start a movie editing operation while the movie you want to edit is playing back. When playback reaches a frame where you want a cut point to be, press [SET] to pause playback. Next, press [▼] to display the menu of editing options. Perform editing using the same procedures as described above.

Optimizing Image Brightness (Lighting)

Procedure

[] (PLAY) → Snapshot Screen → [MENU] → PLAY Tab → Lighting

You can use this setting to optimize the balance between bright areas and dark areas in existing images.

+2	Performs a higher level of brightness correction than the “+1” setting.
+1	Performs brightness correction.
Cancel	Does not perform brightness correction.

NOTE







- Correcting the lighting when shooting produces better results (page 103).
- Altering the lighting of an image causes the original image and the new (altered) version to be stored as separate files.
- When you display an altered image on the camera's monitor screen, the date and time indicates when the image was originally recorded, not when the image was altered.

Adjusting White Balance (White Balance)

Procedure

[] (PLAY) → Snapshot Screen → [MENU] → PLAY Tab → White Balance

You can use the white balance setting to select a light source type for a recorded image, which will affect the colors of the image.

 Daylight	Outdoors, fair weather
 Overcast	Outdoors, cloudy to rain, in tree shade, etc.
 Shade	Very high temperature light, such as building shade, etc.
 Day White Fluorescent	White or day white fluorescent lighting, without suppressing color cast
 Daylight Fluorescent	Daylight fluorescent lighting, while suppressing color cast
 Tungsten	Suppressing of the appearance of light bulb lighting
Cancel	No white balance adjustment

NOTE

- You also can adjust the white balance when recording images (page 45).
- The original snapshot is retained in memory and not deleted.
- When you display an altered image on the camera's monitor screen, the date and time indicates when the image was originally recorded, not when the image was altered.

Adjusting the Brightness of an Existing Snapshot (Brightness)

Procedure

[▶] (PLAY) → Snapshot Screen → [MENU] → PLAY Tab → Brightness

You can select one of five brightness levels, from +2 (brightest) to -2 (least bright).

NOTE

- The original snapshot is retained in memory and not deleted.
- When you display an altered image on the camera's monitor screen, the date and time indicates when the image was originally recorded, not when the image was altered.

Selecting Images for Printing (DPOF Printing)

Procedure



[▶] (PLAY) → Snapshot Screen → [MENU] → PLAY Tab → DPOF Printing

See page 136 for details.

Protecting a File Against Deletion (Protect)

Procedure

[▶] (PLAY) → [MENU] → PLAY Tab → Protect

On	<p>Protects specific files.</p> <ol style="list-style-type: none">① Use [◀] and [▶] to scroll through the files until the one you want to protect is displayed.② Use [▲] and [▼] to select “On” and then press [SET]. An image that is protected is indicated by the  icon.③ To protect other files, repeat steps 1 and 2. To exit the protect operation, press [MENU]. To unprotect a file, select “Off” instead of “On” in step 2 above.	
All Files: On	<p>Protects all files.</p> <ol style="list-style-type: none">① Use [▲] and [▼] to select “All Files: On” and then press [SET].② Press [MENU]. To unprotect all files, select “All Files: Off” instead of “All Files: On” in step 1 above.	

★ IMPORTANT!

- Note that even if a file is protected, it will be deleted if you perform the format operation (page 169).

NOTE

- Performing the above procedure while a CS group is displayed will protect all the images in the CS group. You can protect individual images in a CS group by performing the above procedure while the image is displayed.

■ To protect a specific image in a CS group

1. While CS image playback is in progress or paused (toggle by pressing [SET]), press [▼].

This will display the “CS Frame Edit” menu.

2. Use [▲] and [▼] to select “Protect” and then press [SET].

3. Use [◀] and [▶] to scroll through images until one you want to protect is displayed.

4. Use [▲] and [▼] to select “On” and then press [SET].

This will protect the image and display the  icon.

- To unprotect an image, select “Off” in step 4 and then press [SET].
-

5. After you are finished, select “Cancel” and then press [SET] to exit this operation.

NOTE

- Note that even if a file is protected, it will be deleted if you perform the format operation (page 169).

■ To protect all the images in a CS group

1. While a CS group is displayed or while the images of a CS group are scrolling on the monitor screen, press [MENU].

2. Use [◀] and [▶] to select the “PLAY” tab.

3. Use [▲] and [▼] to select “Protect” and then press [SET].

4. Use [◀] and [▶] to display the CS group you want to protect.

5. Use [▲] and [▼] to select “On” and then press [SET].

This will protect all the images in the group and display the  icon.

- To unprotect all of the images in the group, select “Off” in step 5 and then press [SET].
-

6. Press [MENU].

NOTE

- Note that even if a file is protected, it will be deleted if you perform the format operation (page 169).

Editing the Date and Time of an Image (Date/Time)

Procedure

[▶] (PLAY) → Snapshot Screen → [MENU] → PLAY Tab → Date/Time

[▲] [▼]	Changes the setting at the cursor location.
[◀] [▶]	Moves the cursor between settings.
[●] (Movie)	Toggles between 12-hour and 24-hour format.

When the date and time settings are what you want, press [SET] to apply them.

NOTE

- The date and time stamped into an image using the Time Stamp (page 163) cannot be edited.
- You cannot edit the date and time of an image that is protected.
- You can input any date from 1980 to 2049.

Rotating an Image (Rotation)

Procedure

[] (PLAY) → Snapshot or Movie Screen → [MENU] → PLAY Tab → Rotation

1. Use [] and [] to select “Rotation” and then press [SET].

Each press of [SET] will rotate the displayed image 90 degrees left.

2. When the displayed image is at the orientation you want, press [MENU].

NOTE

- Rotating a CS image causes all of the images in the CS group to be rotated. You cannot rotate individual component image in a CS group.
- Rotation of a panorama image is not supported.
- Note that this procedure does not actually change the image data. It simply alters how the image is displayed on the camera's monitor screen.
- An image that has been protected or zoomed cannot be rotated.
- The original (unrotated) version of the image will be displayed on the image menu screen.

Resizing a Snapshot (Resize)

Procedure

[] (PLAY) → Snapshot Screen → [MENU] → PLAY Tab → Resize

You can reduce the size of a snapshot and save the result as a separate snapshot. The original snapshot is also retained. You can resize an image to one of three sizes: 10M, 5M, VGA.

- Resizing a 3:2 or 16:9 size snapshot will create an image with an aspect ratio of 4:3, with both sides cut off.
- The recording date of the resized version of the snapshot will be the same as the recording date of the original snapshot.

Cropping a Snapshot (Trimming)

Procedure

[**▶**] (PLAY) → Snapshot Screen → [MENU] → PLAY Tab → Trimming

You can crop a snapshot to trim parts you do not need, and save the result in a separate file. The original snapshot is also retained.

Use the zoom controller to zoom the image to the size you want, use [**▲**], [**▼**], [**◀**], and [**▶**] to display the portion of the image you want to cut out, and then press [SET].

- The image produced by cropping a 3:2 or 16:9 image will have an aspect ratio of 4:3.
- The recording date of the cropped image will be the same as the recording date of the original snapshot.

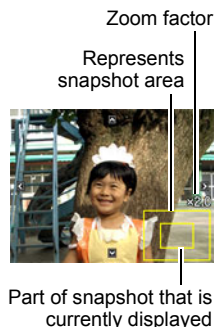

Copying Files (Copy)

Procedure

[**▶**] (PLAY) → Snapshot or Movie Screen → [MENU] → PLAY Tab → Copy

Files can be copied from the camera's built-in memory to a memory card or from a memory card to built-in memory.

Built-in → Card	Copies all files from built-in camera memory to a memory card. This option copies all the files in built-in camera memory. It cannot be used to copy a single file.
Card → Built-in	Copies a single file on the memory card to camera built-in camera memory. Files are copied to the folder in built-in memory whose name has the largest serial number. <ul style="list-style-type: none">• You cannot copy a continuous shutter (CS) group image (page 111). <ol style="list-style-type: none">① Use [◀] and [▶] to select the file you want to copy.② Use [▲] and [▼] to select "Copy" and then press [SET].

NOTE

- You can copy snapshots or movies you recorded with this camera.

Dividing Up a Continuous Shutter Group (Divide Group)

Procedure

[] (PLAY) → [MENU] → PLAY Tab → Divide Group



See page 110 for details.

Combining CS Images into a Single Still Image (CS Multi Print)

Procedure

[] (PLAY) → Display CS group. → [MENU] → PLAY Tab → CS Multi Print

1. Use [] and [] to select “Create”.

- You can use [] and [] to select a different CS group, if you want.

2. Press [SET].

This converts the CS group to a 16M (4608×3456) image with up to 30 CS frames (5 vertical × 6 horizontal).

- This camera may not be able to correctly convert a CS group image with another camera.
- The recording date of the converted image will be the same as the recording date of the original CS group.
- When converting a CS group whose images have been rotated by the “Rotation” feature to a CS Multi Print image, the arrangement of the images in the CS Multi Print will be different from that of normal (unrotated) CS images.

Editing a CS Image (CS Frame Edit)

Procedure

[] (PLAY) → [MENU] → PLAY Tab → CS Frame Edit

See the following pages for details.

DPOF Printing: page 137

Protect: page 124

Copy: page 111

Delete: page 108

Dynamic Photo

This camera comes with a number of subjects in built-in memory ("built-in subjects"), which you can insert into snapshots and movies to create Dynamic Photo images.

- The term "built-in subjects" refers to the moving figures and characters that came pre-programmed in the camera's built-in memory.



Inserting a Built-in Subject into a Snapshot or Movie (Dynamic Photo)

Use the following procedure to insert a built-in subject image into a snapshot (except for a panorama image) or movie.

Procedure

[**▶**] (PLAY) → [MENU] → PLAY Tab → Dynamic Photo

1. Use [◀**] and [**▶**] to select the background image you want and then press [SET].**

- Only an image that satisfies the following conditions can be used as a background image.
 - A snapshot or movie recorded with this camera
 - A snapshot with an aspect ratio of 4:3

2. Use [◀**] and [**▶**] to select the built-in subject that you want to insert into the image and then press [SET].**

3. If you are inserting a subject into a movie an image will appear on the monitor screen showing the approximate location of the subject in the movie. Use [◀] and [▶] to shift the location to the position you want. After you are finished, press [SET].

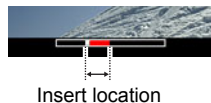

- If you insert a subject into a movie, the resulting movie will be a maximum of 20 seconds long. Everything before and after the insertion is cut off. If the movie you are inserting into (original movie) is shorter than 20 seconds, the resulting movie will be the same length as the original movie.
- If you are inserting a subject into a snapshot, skip directly to step 4.

4. Use the zoom controller to adjust the size of the subject and use [▲], [▼], [◀], and [▶] to adjust its position.

5. When everything is the way you want, press [SET].

This inserts the subject into another image and creates a Dynamic Photo.

- Inserting an animated subject into a snapshot will save a Dynamic Photo that consists of 20 still images of 2M size or smaller.
- Inserting a subject into a movie will save the Dynamic Photo as a movie file.

NOTE

- Performing a delete or format operation will not delete the built-in subjects.

To view a Dynamic Photo (Dynamic Photo File)

1. Press **[▶]** (PLAY) and then use **[◀]** and **[▶]** to display the Dynamic Photo you want to view.
2. If you want to see the subject in the Dynamic Photo movie, press **[SET]**.
The Dynamic Photo is repeated as a continuous loop.
 - Movement of the subject also will start automatically about two seconds after you display a Dynamic Photo.

Converting a Dynamic Photo Still Image to a Movie (Movie Converter)

A Dynamic Photo with a still image background and a moving subject is stored as a series of 20 still images. You can use the following procedure to convert the 20 images that make up a Dynamic Photo to a movie.

Procedure

[▶] (PLAY) → Dynamic Photo Screen → **[MENU]** → **PLAY Tab** → **Movie Converter**

- The final movie format is H.264/AVC standard.
- The final movie image size is 640×480 pixels.

Printing

Printing Snapshots

Professional Print Service

You can take a memory card that contains the images you want to print to a professional print service and have them printed.



Printing on a Home Printer

Printing Images on a Printer with Memory Card Slot

You can use a printer equipped with a memory card slot to print images directly from a memory card. For details, see the user documentation that comes with your printer.



Connecting Directly to a PictBridge Compatible Printer

You can print on a printer that supports PictBridge (page 133).

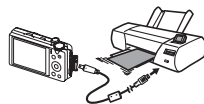

Printing with a Computer

After transferring the images to your computer, use commercially available software to print.

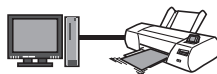

- You can specify which images you want to print, the number of copies, and date stamp settings before printing (page 136).

Connecting Directly to a PictBridge Compatible Printer

You can connect the camera directly to a printer that supports PictBridge and print images without going through a computer.

■ To set up the camera before connecting to a printer

1. Turn on the camera and press [MENU].
2. On the “Set Up” tab, select “USB” and then press [▶].
3. Use [▲] and [▼] to select “PTP (PictBridge)”, and then press [SET].

■ Connecting the Camera to a Printer

Use the USB cable that comes bundled with the camera to connect the camera to your printer's USB port.

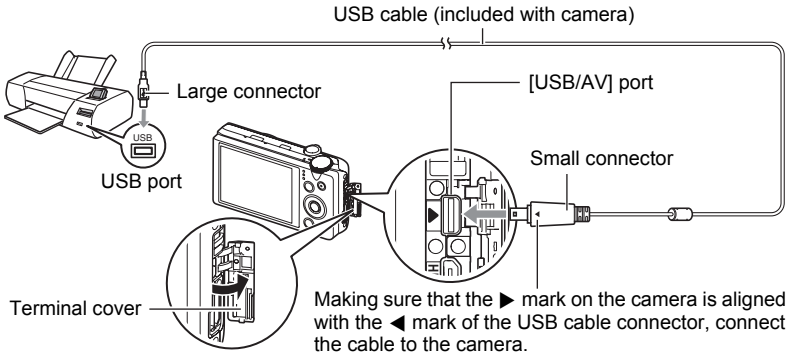

- The camera does not draw power over the USB cable. Check the battery level before connecting and make sure it is not too low.
- Make sure that you insert the cable connector into the USB/AV port until you feel it click securely into place. Failure to insert the connector fully can result in poor communication or malfunction.
- Note that even while the connector is fully inserted, you still will be able to see the metal part of the connector as shown in the illustration.
- When connecting the USB cable to a USB port, make sure you align the connector correctly with the port.
- Make sure that the camera is turned off before plugging in or unplugging the cable. Check the user documentation that comes with the printer for information about requirements before plugging into or unplugging from the printer.

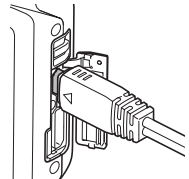

■ To print

1. Turn on the printer and load paper.

2. Turn on the camera.

This will display the print menu screen.

3. Use [▲] and [▼] to select “Paper Size”, and then press [▶].

4. Use [▲] and [▼] to select a paper size and then press [SET].

- The following are the available paper sizes.
3.5"×5", 5"×7", 4"×6", A4, 8.5"×11", By Printer
 - Selecting “By Printer” prints using a paper size selected on the printer.
 - See the documentation that comes with your printer for information about paper settings.
-

5. Use [▲] and [▼] to specify the print option you want.

1 Image : Prints one image. Select and then press [SET]. Next, use [◀] and [▶] to select the image you want to print.

DPOF Printing: Prints multiple images. Select and then press [SET]. With this option, images will be printed in accordance with DPOF settings (page 136).

- To toggle date stamping on and off, press [●] (Movie). The date stamp will be printed when “On” is indicated on the monitor screen.
-

6. Use [▲] and [▼] to select “Print” and then press [SET].

Printing will start and the message “Busy... Please wait...” will appear on the monitor screen. The message will disappear after a short while, even though printing is still being performed. Pressing any camera button will cause the printing status to re-appear. The print menu screen will re-appear when printing is complete.

- If you selected “1 Image”, you can repeat the procedure from step 5, if you want.
-

7. After printing is complete, turn off the camera and disconnect the USB cable from the printer and camera.

Using DPOF to Specify Images to be Printed and the Number of Copies

■ Digital Print Order Format (DPOF)

DPOF is a standard that allows you to include image type, number of copy, and time stamp on/off information on the memory card with the images. After configuring settings, you can use the memory card to print on a home printer that supports DPOF or take the memory card to a professional print service.



- Whether or not you will be able to use DPOF settings for printing depends on the printer you are using.
- Some professional print services may not support DPOF.

■ Configuring DPOF Settings Individually for Each Image

Procedure

[] (PLAY) → Snapshot Screen → [MENU] → PLAY Tab → DPOF Printing → Select images

1. Use [] and [] to scroll through the files until the image you want to print is displayed.

2. Use [] and [] to specify the number of copies.
You can specify a value up to 99. Specify 00 if you do not want to print the image.
 - If you want to include the date in the images, press [] (Movie) so "On" is shown for date stamping.
 - Repeat steps 1 and 2 to configure settings for other images, if you want.

3. Press [SET].

■ Configuring the Same DPOF Settings for All the Images

Procedure

[] (PLAY) → Snapshot Screen → [MENU] → PLAY Tab → DPOF Printing → All images

1. Use [] and [] to specify the number of copies.

You can specify a value up to 99. Specify 00 if you do not want to print the image.

- Note that the specified number of copies will be printed for all of the images in any CS group included with the images.
- If you want to include the date in the images, press [] (Movie) so “On” is shown for date stamping.

2. Press [SET].

NOTE

- You can specify the number of copies for a specific image (page 137) or for all of the images in a CS group (page 138) by performing the above procedure while an image in the group is displayed.

■ To specify the number of copies for a specific image in a CS group

1. While CS image playback is in progress or paused (toggle by pressing [SET]), press [].

This will display the “CS Frame Edit” menu.

2. Use [] and [] to select “DPOF Printing” and then press [SET].

3. Use [] and [] to select “Select images” and then press [SET].

4. Use [] and [] to scroll through images until one you want to print is displayed.

5. Use [] and [] to specify the number of copies.

You can specify a value up to 99. Specify 00 if you do not want to print the image.

- If you want to include the date in the images, press [] (Movie) so “On” is shown for date stamping.
- Repeat steps 4 and 5 to configure settings for other images, if you want.

6. Press [SET].

■ **To configure the same DPOF settings for all the images in a CS group**

- 1. While CS image playback is in progress or paused (toggle by pressing [SET]), press [▼].**

This will display the "CS Frame Edit" menu.

- 2. Use [▲] and [▼] to select "DPOF Printing" and then press [SET].**
-

- 3. Use [▲] and [▼] to select "Frame all" and then press [SET].**
-

- 4. Use [▲] and [▼] to specify the number of copies.**

You can specify a value up to 99. Specify 00 if you do not want to print the image.

- If you want to include the date in the images, press [●] (Movie) so "On" is shown for date stamping.
-

- 5. Press [SET].**

DPOF settings are not cleared automatically after printing is complete.

The next DPOF print operation you execute will be performed using the last DPOF settings you configured for the images. To clear DPOF settings, specify "00" for the number of copies of all images.

Tell your print service about your DPOF settings!

If you take a memory card to a professional print service, be sure to tell them that it includes DPOF settings for the images to be printed and the number of copies. If you don't, the print service may print all the images without regard to your DPOF settings, or they may ignore your date stamp setting.

■ Date Stamping

You can use one of the following three methods to include the recording date in the printout of an image.

Configuring camera settings
Configure DPOF settings (page 136). You can turn date stamping on and off each time you print. You can configure settings so some images include the date stamp and some don't.
Configure the Camera's Timestamp setting (page 163). <ul style="list-style-type: none">• The camera's Timestamp setting imprints the date into a snapshot when you shoot it, so the date is always included when you print. It cannot be deleted.• Do not turn on DPOF date stamping for an image that includes a date stamped with the camera's Timestamp function. Doing so can cause the two stamps to be overprinted.
Configuring computer settings
You can use commercially available image management software to date stamp images.
Professional print service
Request date stamping when ordering prints from a professional print service.

■ Standards Supported by the Camera

- PictBridge

This is a standard of the Camera and Imaging Products Association (CIPA). You can connect the camera directly to a printer that supports PictBridge, and perform image selection and printing using the camera monitor screen and controls.



- PRINT Image Matching III

Using image editing software and printing on a printer that supports PRINT Image Matching III makes it possible to use information about shooting conditions that is recorded with the image, and produce exactly the type of image you want. PRINT Image Matching and PRINT Image Matching III are trademarks of Seiko Epson Corporation.



- Exif Print





Printing on a printer that supports Exif Print uses information about shooting conditions recorded with the image to enhance printed image quality. Contact your printer manufacturer for information about models that support Exif Print, printer upgrades, etc.



Using the Camera with a Computer

Things you can do using a computer...

You can perform the operations described below while the camera is connected to a computer.

Save images to a computer and view them there		<ul style="list-style-type: none">• Save images and view them manually (USB connection) (pages 143, 152).• Transfer images to a computer automatically over a wireless LAN for viewing (Eye-Fi) (page 156).
Transfer images stored on your computer to camera memory		In addition to images, you also can transfer screen shot images from your computer to the camera (Photo Transport*) (page 149).
Play back and edit movies		<ul style="list-style-type: none">• You can play back movies (pages 147, 155). To play back movies, use software that is compatible with your computer's operating environment.• To edit movies, use commercially available software as required.
Play back and edit Dynamic Photo images on your EXILIM, a computer, or on a mobile phone		<ul style="list-style-type: none">• You can copy moving subjects (animated characters) from your computer to the EXILIM.• You can convert Dynamic Photo images to movies and send them to a mobile phone for playback (Requires Dynamic Photo Manager.*) (page 151).

* Windows only

The procedures you need to perform when using the camera with your computer and when using the software are different for Windows and the Macintosh.

- Windows users should refer to "Using the Camera with a Windows Computer" on page 142.
- Macintosh users should refer to "Using the Camera with a Macintosh" on page 152.

Using the Camera with a Windows Computer

Install the required software in accordance with the version of Windows you are running and what you want to do.

When you want to do this:	Operating System Version	Install this software:	See page:
Save images to a computer and view them there manually	Windows 7, Windows Vista, Windows XP (SP3)	Installation not required.	143
Play movies	Windows 7	Installation not required. • Windows Media Player 12, which is already installed on most computers, can be used for playback.	147
	Windows Vista, Windows XP (SP3)	Movies can be played back using QuickTime 7. • You need to download QuickTime 7 on the Web if you want to use it.	
Edit movies	Windows 7, Windows Vista, Windows XP (SP3)	– • Use commercial software as required.	–
Upload movie files to YouTube	Windows 7, Windows Vista, Windows XP (SP3)	YouTube Uploader for CASIO* • You need to download it from the website.	148
Transfer images to the camera	Windows 7, Windows Vista, Windows XP (SP3)	Photo Transport 1.0* • You need to download it from the website.	149
Play back, copy, and edit Dynamic Photo moving subjects (animated characters)	Windows 7, Windows Vista (SP1), Windows XP (SP3)	Dynamic Photo Manager* • You need to download it from the website.	151

* YouTube Uploader for CASIO, Photo Transport, and Dynamic Photo Manager will not run under 64-bit versions of Windows OS.

■ Computer System Requirements for Software

Computer system requirements are different for each of the applications. Information about computer system requirements can be found under “Computer System Requirements for Software (For Windows)” on page 182 of this manual.

■ Precautions for Windows Users

- The software requires Administrator privileges to run.
- Operation on a self-made computer is not supported.
- Operation may not be possible under certain computer environments.

Viewing and Storing Images on a Computer

You can connect the camera to your computer in order to view and store images (snapshot and movie files).

■ To connect the camera to your computer and save files

1. Turn on the camera and press [MENU].

2. On the “Set Up” tab, select “USB” and then press [▶].

3. Use [▲] and [▼] to select “Mass Storage”, and then press [SET].

4. Turn off the camera and then use the USB cable that comes with the camera to connect it to your computer.

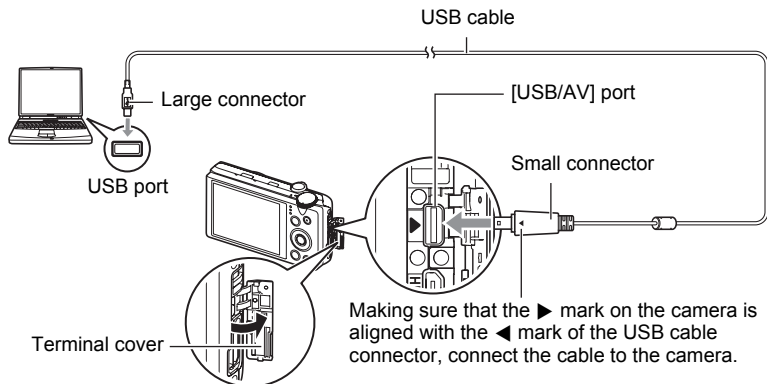

The camera will turn on automatically and battery charging will start (page 19).

- The camera may not turn on automatically in the case of certain computer models or connection conditions. If this happens, press [ON/OFF] (Power) to turn on the camera.
- Make sure that you insert the cable connector into the USB/AV port until you feel it click securely into place. Failure to insert the connector fully can result in poor communication or malfunction.
- Note that even while the connector is fully inserted, you still will be able to see the metal part of the connector as shown in the illustration.
- When connecting the USB cable to a USB port, make sure you align the connector correctly with the port.
- Your computer may not be able to recognize the camera if you connect via a USB hub. Always connect directly to the computer's USB port.
- The first time you connect the camera to your computer with the USB cable, an error message may appear on your computer. If this happens, disconnect and then reconnect the USB cable.

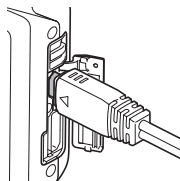

**5. Windows 7, Windows Vista users: Click “Start” and then “Computer”.
Windows XP users: Click “Start” and then “My Computer”.**

6. Double-click “Removable Disk”.

- Your computer recognizes the memory card loaded in the camera (or built-in memory if there is no card) as a removable disk.

7. Right-click the “DCIM” folder.

8. On the shortcut menu that appears, click “Copy”.

**9. Windows 7, Windows Vista users: Click “Start” and then “Documents”.
Windows XP users: Click “Start” and then “My Documents”.**

- If you already have a “DCIM” folder in “Documents” (Windows 7, Windows Vista) or “My Documents” (Windows XP), the next step will overwrite it. If you want to keep the existing “DCIM” folder, you need to change its name or move it to a different location before performing the next step.

10. Windows 7 users: On the “Documents” “Organize” menu, select “Paste”.

Windows Vista users: On the “Documents” “Edit” menu, select “Paste”.

Windows XP users: On the “My Documents” “Edit” menu, select “Paste”.

This will paste the “DCIM” folder (and all the image files it contains) into your “Documents” (Windows 7, Windows Vista) or “My Documents” (Windows XP) folder. You now have a copy of the files that are in camera memory on your computer.

11. After you finish copying images, disconnect the camera from the computer.

■ To view images you copied to your computer

1. Double-click the copied “DCIM” folder to open it.

2. Double-click the folder that contains the images you want to view.

3. Double-click the image file you want to view.

- For information about file names, see “Memory Folder Structure” on page 158.
- An image that was rotated on the camera will be displayed on your computer screen in its original (unrotated) orientation.
- Viewing a CS image on a computer will individually display the component images in the CS group. A CS group cannot be viewed as a CS image on a computer.

Never use your computer to modify, delete, move, or rename any image files that are in the camera’s built-in memory or on its memory card.

Doing so can cause problems with the camera’s image management data, which will make it impossible to play back images on the camera and can drastically alter remaining memory capacity. Whenever you want to modify, delete, move, or rename an image, do so only on images that are stored on your computer.



IMPORTANT!

- Never unplug the USB cable, or operate the camera while viewing or storing images. Doing so can cause data to become corrupted.

Playing Movies

To play back a movie, first copy it to your computer and then double-click the movie file. Some operating systems may not be able to play back movies. If this happens, you need to install separately available software.

- With Windows 7, playback is supported by Windows Media Player 12.
- If you are unable to play back movies, go to the URL below to download QuickTime 7 and install it on your computer.

<http://www.apple.com/quicktime/>

■ Minimum Computer System Requirements for Movie Playback

The minimum system requirements described below are necessary to play back movies recorded with this camera on a computer.

Operating System : Windows 7, Windows Vista, Windows XP (SP3)

CPU : Image Quality "FHD":
Core 2 Duo 3.0GHz or higher
Image Quality "STD" or "HS":
Pentium 4 3.2GHz or higher

Required Software: QuickTime 7 (Not required with Windows 7.)

- The above are recommended system environments. Configuring one of these environments does not guarantee proper operation.
- Certain settings and other installed software may interfere with proper playback of movies.

■ Movie Playback Precautions

- Be sure to move the movie data to the hard disk of your computer before trying to play it. Proper movie playback may not be possible for data accessed over a network, from a memory card, etc.
- Proper movie playback may not be possible on some computers. If you experience problems, try the following.
 - Try recording movies with a quality setting of "STD".
 - Quit any other applications you have running, and stop resident applications.

Even if proper playback is not possible on the computer, you can use the AV cable (option) to connect to the video input terminal of a TV or computer and play back movies that way.

Uploading Movie Files to YouTube

To make it easy to upload to YouTube a movie file recorded with the “For YouTube” BEST SHOT scene, install YouTube Uploader for CASIO on your computer.

■ What is YouTube?

YouTube is a movie sharing site managed by YouTube, LLC where you can upload movies and view movies uploaded by others.

■ To install YouTube Uploader for CASIO

Download the YouTube Uploader for CASIO installer from the CASIO digital camera support page (<http://www.casio-intl.com/support/>). Double-click the installer and follow the installation instructions that appear on your computer screen.

- For information about installation conditions and minimum computer system requirements, see page 182.

■ To upload a movie file to YouTube

- Before you can use YouTube Uploader for CASIO, you need to go to the YouTube website (<http://www.youtube.com/>) and register as a user there.
- Do not upload any video that is copyrighted (including neighboring copyrights) unless you yourself own the copyright or you have obtained the permission of the applicable copyright holder(s).
- The maximum file size for each upload is 2048MB or 15 minutes of playing time.

1. Record the movie you want to upload using the “For YouTube” scene (page 71).

2. If it isn't already, connect your computer to the Internet.

3. Connect the camera to your computer (page 143).

4. Turn on the camera.

YouTube Uploader for CASIO will start up automatically.

- If this is the first time you are using the application, configure the YouTube user ID and network environment settings, and then click the [OK] button.
-

5. The left side of the display will have an area for inputting a title, category, and other information required for uploading to YouTube. Enter the required information.

6. The right side of the display shows a list of movie files in camera memory. Select the check box next to the movie file you want to upload.

7. When everything is ready, click the [Upload] button.

This will upload the movie file(s) to YouTube.

- After uploading is complete, click the [Exit] button to exit the application.

Transferring Images from Your Computer to Camera Memory

If you want to transfer images from your computer to the camera, install Photo Transport on your computer.

■ To install Photo Transport

Download the Photo Transport installer from the CASIO digital camera support page (<http://www.casio-intl.com/support/>). Double-click the installer and follow the installation instructions that appear on your computer screen.

- For information about installation conditions and minimum computer system requirements, see page 182.

■ To transfer images to the camera

1. Connect the camera to your computer (page 143).

2. On your computer, click the following: Start → All Programs → CASIO → Photo Transport.

This starts up Photo Transport.

3. Drag the file(s) you want to transfer to the [Transfer] button.

4. Follow the instructions that appear on the display to complete the transfer.

- The details of the instructions that appear on the display and the transferred images will depend on your Photo Transport setup. For details, click the [Settings] button or [Help] button and check the setup.

Transfer Data

- Only image files with the following extensions can be transferred to the camera: jpg, jpeg, jpe, bmp (bmp images are converted to jpeg images automatically when transferred.)
- Certain types of images may not be able to be transferred.
- You cannot transfer movies to the camera.

■ To transfer computer screen captures to the camera

1. Connect the camera to your computer (page 143).

2. On your computer, click the following: Start → All Programs → CASIO → Photo Transport.

This starts up Photo Transport.

3. Display the screen whose screen capture you want to transfer.

4. Click the [Capture] button.

5. Draw a boundary around the area you want to capture.

Move your mouse pointer to the upper left corner of the area you want to capture and then hold down the mouse button. Keeping the mouse button depressed, drag the pointer down to the lower right corner of the area and then release the mouse button.

6. Follow the instructions that appear on the display.

This will send an image of the area you selected to the camera.

- The transfer operation converts screen captures to JPEG format.
- The instructions that appear on the display and details about the transferred images will depend on your Photo Transport setup. For details, click the [Settings] button or [Help] button and check the setup.

■ About settings and help

Click the [Settings] button when you want to change the Photo Transport setup. For help about operation procedures and troubleshooting, click the Photo Transport [Help] button.

Play back Dynamic Photo images on your EXILIM, a computer, or on a mobile phone

You can copy moving subjects (animated characters) from your computer to the EXILIM. You also can convert Dynamic Photo images to movies and send them to a mobile phone for playback. To perform such functions, you need to install Dynamic Photo Manager on your computer.

To download Dynamic Photo Manager and find out more details about it, visit the URL below.

http://www.exilim.com/dp/en_int/

User Registration

Internet registration only is supported. Visit the following CASIO website to register:

<http://world.casio.com/qv/register/>

Using the Camera with a Macintosh

Install the required software in accordance with what version of the Macintosh OS you are running and what you want to do.

When you want to do this:	Operating System Version	Install this software:	See page:
Save images to your Macintosh and view them there manually	OS X	Installation not required.	152
Save images to your Macintosh automatically/ Manage images	OS X	Use iPhoto, which comes bundled with some Macintosh products.	155
Play movies	OS X	Movie file playback is supported under OS X 10.4.11 or higher when QuickTime 7 or higher is installed.	155

Connecting the Camera to Your Computer and Saving Files



IMPORTANT!

- The camera does not support operation with Mac OS X 10.0. Operation is supported with Mac OS 10.1, 10.2, 10.3, 10.4, 10.5, and 10.6 (using the OS standard USB driver) only.

■ To connect the camera to your computer and save files

1. Turn on the camera and press [MENU].
2. On the “Set Up” tab, select “USB” and then press [▶].
3. Use [▲] and [▼] to select “Mass Storage”, and then press [SET].

4. Turn off the camera and then use the USB cable that comes with the camera to connect it to your Macintosh.

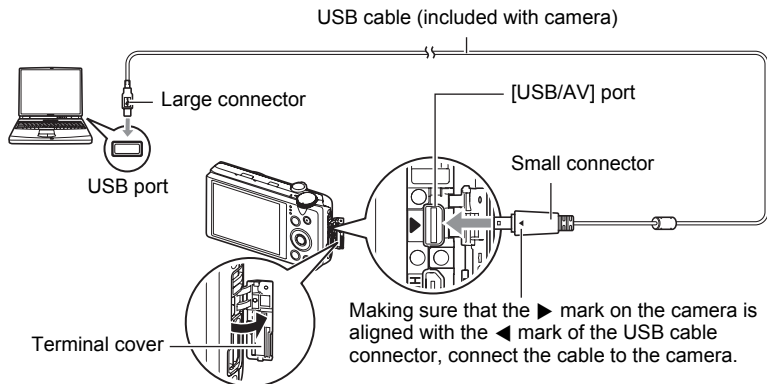

The camera will turn on automatically and battery charging will start (page 19).

- The camera may not turn on automatically in the case of certain computer models or connection conditions. If this happens, press [ON/OFF] (Power) to turn on the camera.
- Make sure that you insert the cable connector into the USB/AV port until you feel it click securely into place. Failure to insert the connector fully can result in poor communication or malfunction.
- Note that even while the connector is fully inserted, you still will be able to see the metal part of the connector as shown in the illustration.
- When connecting the USB cable to a USB port, make sure you align the connector correctly with the port.
- Your computer may not be able to recognize the camera if you connect via a USB hub. Always connect directly to the computer's USB port.
- The first time you connect the camera to your computer with the USB cable, an error message may appear on your computer. If this happens, disconnect and then reconnect the USB cable.

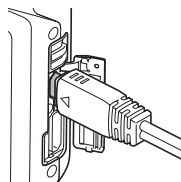

5. Double-click the camera's drive icon.

The camera's back lamp will light green at this time. In this mode, your Macintosh recognizes the memory card loaded in the camera (or the camera's built-in memory if it does not have a memory card loaded) as a drive. The appearance of the drive icon depends on the Mac OS version you are using.

6. Drag the "DCIM" folder to the folder to which you want to copy it.

7. After the copy operation is complete, drag the drive icon to Trash.

8. Disconnect the camera from the computer.

■ To view copied images

1. Double-click the camera's drive icon.

2. Double-click the "DCIM" folder to open it.

3. Double-click the folder that contains the images you want to view.

4. Double-click the image file you want to view.

- For information about file names, see "Memory Folder Structure" on page 158.
- An image that was rotated on the camera will be displayed on your Macintosh screen in its original (unrotated) orientation.
- Viewing a CS image on a computer will individually display the component images in the CS group. A CS group cannot be viewed as a CS image on a computer.

Never use your computer to modify, delete, move, or rename any image files that are in the camera's built-in memory or on its memory card.

Doing so can cause problems with the camera's image management data, which will make it impossible to play back images on the camera and can drastically alter remaining memory capacity. Whenever you want to modify, delete, move, or rename an image, do so only on images that are stored on your computer.



IMPORTANT!

- Never unplug the USB cable, or operate the camera while viewing or storing images. Doing so can cause data to become corrupted.

Transferring Images Automatically and Managing Them on Your Macintosh

If you are running Mac OS X, you can manage snapshots using iPhoto, which comes bundled with some Macintosh products.

Playing a Movie

You can use QuickTime, which comes bundled with your operating system, to play back movies on a Macintosh. To play back a movie, first copy it to your Macintosh and then double-click the movie file.

■ Minimum Computer System Requirements for Movie Playback

The minimum system requirements described below are necessary to play back movies recorded with this camera on a computer.

Operating System : Image Quality "FHD":
Mac OS X 10.4.11 or higher
Image Quality "STD" or "HS":
Mac OS X 10.3.9 or higher

Required Software: QuickTime 7 or higher

- The above are recommended system environments. Configuring one of these environments does not guarantee proper operation.
- Certain settings and other installed software may interfere with proper playback of movies.

■ Movie Playback Precautions

Proper movie playback may not be possible on some Macintosh models. If you experience problems, try the following.

- Try recording movies with a quality setting of "STD".
- Upgrade to the latest version of QuickTime.
- Shut down other applications that are running.

Even if proper playback is not possible on your Macintosh, you can use the AV cable (option) to connect to the video input terminal of a TV or Macintosh and play back movies that way.



IMPORTANT!

- Be sure to move the movie data to the hard disk of your Macintosh before trying to play it. Proper movie playback may not be possible for data accessed over a network, from a memory card, etc.

User Registration

Internet registration only is supported. Visit the following CASIO website to register:
<http://world.casio.com/qv/register/>

Using an Eye-Fi Wireless SD Memory Card to Transfer Images (Eye-Fi)

Shooting with an Eye-Fi wireless SD memory card loaded in the camera makes it possible to transfer image data automatically to a computer via wireless LAN.

- 1. Configure LAN access point, transfer destination and other settings for the Eye-Fi card in accordance with the instructions that come with the Eye-Fi card.**
- 2. After configuring settings, load the Eye-Fi card into the camera and record.**



Images you record are sent by wireless LAN to your computer, etc.

- For full details, see the user documentation that comes with the Eye-Fi card.
- Before formatting a new Eye-Fi card to use it for the first time, copy the Eye-Fi Manager install files to your computer. Do this before formatting the card.

IMPORTANT!

- Recorded images are transferred over wireless LAN. Do not use the Eye-Fi card or turn off Eye-Fi card communication (page 160) when on an aircraft or in any other location where use of wireless communication is limited or prohibited.
- Loading an Eye-Fi card will cause the Eye-Fi indicator  to appear on the monitor screen. Its transparent or not transparent appearance indicates the communication status as shown below.



Transparent		Access point cannot be found or no transferable image data exists.
Not transparent		Image transfer in progress
Flashing		Searching for access points

- A communication icon  will appear on the monitor screen while image data transfer is in progress.
- The camera's Auto Power Off (page 166) function is disabled while image data transfer is in progress.
- A confirmation message will appear on the monitor screen if you try to turn off the camera while image data transfer is in progress. Follow the instructions in the messages (page 192).
- Transfer of a large number of images can take some time to complete.
- Depending on the type of Eye-Fi card you are using and its settings, images on the Eye-Fi card may be deleted following image data transfer.
- Breaks in the image and/or audio may occur when recording a movie to or playing a movie from an Eye-Fi card.
- Proper Eye-Fi card data communication may not be possible due to camera settings, battery level, or operating conditions.
- Use of an Eye-Fi X2 card is not recommended.

Files and Folders

The camera creates a file each time you shoot a snapshot, record a movie, or perform any other operation that stores data. Files are grouped by storing them in folders. Each file and folder has its own unique name.

- For details about how folders are organized in memory, see “Memory Folder Structure” (page 158).

Name and Maximum Number Allowed	Example
File	
Each folder can contain up to 9999 files named CIMG0001 through CIMG9999. The extension on the file name depends on the file type.	26th file name: CIMG0026.JPG Serial number Extension (4 digits)
Folders	
Folders are named from 100CASIO to 999CASIO. There can be up to 900 folders in memory. <ul style="list-style-type: none">• BEST SHOT has a scene named “For YouTube” that optimizes movie settings for recording movies for upload to YouTube. Images recorded with the YouTube scene are stored in a folder named “100YOUTB”.	100th folder name: 100CASIO Serial number (3 digits)

- You can view folder and file names on your computer. For details about how file names are displayed on the camera’s monitor screen, see pages 11 and 12.
- The total number of folders and files allowed depends on the image size and quality, and capacity of the memory card being used for storage.

Memory Card Data

The camera stores images you shoot in accordance with the Design Rule for Camera File System (DCF).

■ About DCF

The following operations are supported for DCF-compliant images. Note, however, that CASIO makes no performance guarantees concerning these operations.

- Transferring this camera's DCF-compliant images to another manufacturer's camera and view them.
- Printing this camera's DCF-compliant images on another manufacturer's printer.
- Transferring another camera's DCF-compliant images to this camera and view them.

■ Memory Folder Structure

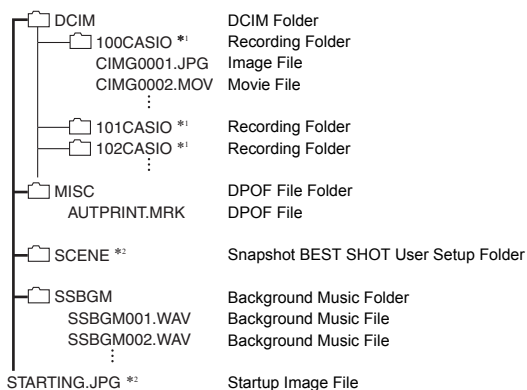

*1 The BEST SHOT "For YouTube" scene sets up the camera for recording movies that are optimized for uploading to YouTube. Images recorded with the "For YouTube" scene are stored in a folder named "100YOUTB".

*2 This folder or file can be created in built-in memory only.

■ Supported Image Files

- Image files shot with this camera
- DCF-compliant image files

This camera may not be able to display an image, even if it is DCF-compliant. When displaying an image recorded on another camera, it may take a long time for the image to appear on this camera's monitor screen.

■ Built-in Memory and Memory Card Data Handling Precautions

- Whenever copying memory contents to your computer, you should copy the DCIM folder and all of its contents. A good way to keep track of multiple DCIM folders is to change their names to dates or something similar after you copy them to your computer. If you later decided to return a DCIM folder to the camera, however, be sure to change its name back to DCIM. The camera is designed to recognize only a root file with the name DCIM. Note the camera also will not be able to recognize the folders inside the DCIM folder unless they have the names they originally had when you copied them from the camera to your computer.
- Folders and files must be stored in accordance with the "Memory Folder Structure" shown on page 158 in order for the camera to be able to recognize them correctly.
- You also can use a PC card adapter or a memory card reader/writer to access camera files directly from the camera's memory card.

Other Settings (Set Up)

This section explains menu items that you can use to configure settings and perform other operations in both the REC mode and PLAY mode.

For information about menu operations, see page 89.

Adjusting Monitor Screen Brightness (Screen)

Procedure

[MENU] → Set Up Tab → Screen

Auto	With this setting, the camera detects available light levels and automatically adjusts the brightness of the monitor screen accordingly.
+2	Brightness that is greater than +1, which makes the screen easier to view. This setting consumes more power.
+1	Bright setting for outdoor use, etc. Brightness that is greater than 0.
0	Normal monitor screen brightness for indoor use, etc.
-1	Low monitor screen brightness for nighttime use, indoor use under dark conditions, etc.

Turning off Eye-Fi Card Communication (Eye-Fi)

Procedure

[MENU] → Set Up Tab → Eye-Fi

Select "Off" to disable Eye-Fi card communication (page 156).

Auto Image Orientation Detection and Rotation (Auto Rotate)

Procedure

[MENU] → Set Up Tab → Auto Rotate



On	Automatically rotates snapshots shot with the camera held vertically 90 degrees.
Off	Images not rotated automatically.

The camera automatically detects whether a snapshot image was shot in portrait or landscape orientation and displays it accordingly. Auto rotation is not performed for movies.

Configuring Camera Sound Settings (Sounds)

Procedure

[MENU] → Set Up Tab → Sounds

Startup	
Half Shutter	Specifies the startup sound
Shutter	Sound 1 - 5: Built-in sounds (1 through 5) Off: Sound off
Operation	
 Operation	Specifies the sound volume. This setting is also used as the audio level during video output (page 113).
 Play	Specifies the volume of movie audio output. This volume setting is not used during video output (from the USB/AV port) (page 113).

- Setting a volume level of 0 mutes output.

Specifying the File Name Serial Number Generation Rule (File No.)

Procedure

[MENU] → Set Up Tab → File No.

Use the following procedure to specify the rule that governs generation of the serial number used in file names (page 157).

Continue	Tells the camera to remember the last used file number. A new file will be named using the next sequential number, even if files are deleted or if a blank memory card is loaded. If a memory card is loaded and that card already has files stored on it and the largest sequential number in the existing file names is greater than the largest sequential number remembered by the camera, numbering of new files will start from the largest sequential number in the memory card file names plus 1.
Reset	Restarts the serial number from 0001 whenever all files are deleted or when the memory card is replaced with a blank one. If a memory card is loaded and that card already has files stored on it, numbering of new files will start from the largest sequential number in the memory card file names plus 1.

Creating an Image Storage Folder (Create Folder)

Procedure

[MENU] → Set Up Tab → Create Folder

Create Folder	Creates a folder with a unique number (page 157). Files will be stored in the new folder starting from when you record your next image.
Cancel	Cancels folder creation.

- Images recorded with the BEST SHOT “For eBay” or “Auction” scene, and the “For YouTube” scene are stored in special folders. They are not stored in the folder you create here.
- Deleting all of the files in a folder cause the folder to be deleted as well.

Configuring World Time Settings (World Time)

Procedure

[MENU] → Set Up Tab → World Time

You can use the World Time screen to view the current time in a zone that is different from your Home City when you go on a trip, etc. World Time displays the current time in 162 cities in 32 time zones around the globe.

1. Use [▲] and [▼] to select “World” and then press [▶].

- To change the geographic area and city for the time where you normally use the camera, select “Home”.

2. Use [▲] and [▼] to select “City” and then press [▶].

- To change the “World” setting to summer time, use [▲] and [▼] to select “DST” and then select “On”. Summer time is used in some geographical areas to advance the current time setting by one hour during the summer months.

3. Use [▲], [▼], [◀], and [▶] to select the geographic area you want and then press [SET].

4. Use [▲] and [▼] to select the city you want and then press [SET].

5. Press [SET].



IMPORTANT!

- Before configuring World Time settings, make sure that the Home City setting is the place where you live or normally use the camera. If it isn't, select “Home” on the screen in step 1 and configure the Home City, date, and time settings as required (page 164).

Time Stamping Snapshots (Timestamp)

Procedure

[MENU] → Set Up Tab → Timestamp

You can configure the camera to stamp the recording date only, or date and time in the lower right corner of each snapshot.

- Once date and time information is stamped into a snapshot, it cannot be edited or deleted.

Example: July 10, 2012, 1:25 p.m.

Date	2012/7/10
Date&Time	2012/7/10 1:25pm
Off	No stamping of date and/or time

- Even if you do not stamp the date and/or time with Timestamp, you can do so later using the DPOF function or some printing application (page 139).
- Stamping is performed in accordance with the date and time settings (page 164) and the display style settings (page 164).

Setting the Camera's Clock (Adjust)

Procedure

[MENU] → Set Up Tab → Adjust

[▲] [▼]	Change the setting at the cursor location
[◀] [▶]	Move the cursor between settings
[●] (Movie)	Toggles between 12-hour and 24-hour format

When the date and time settings are what you want, select "Apply" and then press [SET] to apply them.

- You can specify a date from 2001 to 2049.
- Be sure to select your Home City (page 162) before setting the time and date. If you set the time and date while the wrong city is selected for your Home City, the times and dates of all of the World Time cities (page 162) will be wrong.

Specifying the Date Style (Date Style)

Procedure

[MENU] → Set Up Tab → Date Style

You can select from among three different styles for the date.

Example: July 10, 2012

YY/MM/DD	12/7/10
DD/MM/YY	10/7/12
MM/DD/YY	7/10/12

- This setting also affects the control panel date format as shown below (page 40).
YY/MM/DD or MM/DD/YY: MM/DD
DD/MM/YY: DD/MM

Specifying the Display Language (Language)

Procedure

[MENU] → Set Up Tab → Language

■ Specify the display language you want.

- ① Select the tab on the right.
 - ② Select "Language".
 - ③ Select the language you want.
- Camera models sold in certain geographic areas may not support display language selection.



Configuring Sleep State Settings (Sleep)

Procedure

[MENU] → Set Up Tab → Sleep

This feature turns off the monitor screen whenever no camera operation is performed for a preset amount of time. Press any button to turn the monitor screen back on.

Trigger Time Settings: 30 sec, 1 min, 2 min, Off (Sleep is disabled while "Off" is selected.)

- Sleep is disabled under any of the following conditions.
 - In the PLAY mode
 - While the camera is connected to a computer or other device
 - During a slideshow
 - During movie recording and playback
- When both sleep and Auto Power Off are turned on, Auto Power Off takes priority.

Configuring Auto Power Off Settings (Auto Power Off)

Procedure

[MENU] → Set Up Tab → Auto Power Off

Auto Power Off turns off the camera whenever no camera operation is performed for a preset amount of time.

Trigger Time Settings: 2 min, 5 min, 10 min (The trigger time is always 5 minutes in the PLAY mode.)

- Auto Power Off is disabled under any of the following conditions.
 - While the camera is connected to a computer or other device
 - During a slideshow
 - During CS group playback
 - During movie recording and playback

Configuring [📷] and [▶] Settings (REC/PLAY)

Procedure

[MENU] → Set Up Tab → REC/PLAY

Power On	Camera turns on whenever [📷] (REC) or [▶] (PLAY) is pressed.
Power On/Off	Camera turns on or off whenever [📷] (REC) or [▶] (PLAY) is pressed.
Disable	Camera does not turn on or off when [📷] (REC) or [▶] (PLAY) is pressed.

- With “Power On/Off”, the camera turns off when you press [📷] (REC) in the REC mode or [▶] (PLAY) in the PLAY mode.
- Change this setting to “Power On” or “Power On/Off” before connecting to a TV for image viewing.

Configuring USB Protocol Settings (USB)

Procedure

[MENU] → Set Up Tab → USB

You can use the procedure below to select the USB communication protocol, which is used when exchanging data with a computer, printer, or other external device.

Mass Storage	Select this setting when connecting to a computer (pages 143, 152). With this setting, the computer sees the camera as an external storage device. Use this setting for normal transfer of images from the camera to a computer.
PTP (PictBridge)	Select this setting when connecting to a printer that supports PictBridge (page 133).

Selecting the Screen Aspect Ratio and Video Output System (Video Out)

Procedure

[MENU] → Set Up Tab → Video Out

You can use the procedure in this section to select either NTSC or PAL as the video output system. You can also specify an aspect ratio of 4:3 or 16:9.

NTSC	Video system used in Japan, the U.S., and other countries
PAL	Video system used in Europe and other areas
4:3	Normal TV screen aspect ratio
16:9	Wide screen aspect ratio

- Select the aspect ratio (4:3 or 16:9) that matches the type of TV you plan to use. Images will not display correctly if you select the wrong aspect ratio.
- Images will not display correctly unless the camera's video signal output setting matches the video signal system of the TV or other video equipment.
- Images cannot be displayed correctly on a TV or video equipment that is not NTSC or PAL.

Selecting the HDMI Terminal Output Method (HDMI Output)

Procedure

[MENU] → **Set Up Tab** → **HDMI Output**

- See page 116 for details.

Configuring a Startup Image (Startup)

Procedure

[MENU] → **Set Up Tab** → **Startup**

Display the image you want to use as your startup image and then select “On”.

- The startup image does not appear when you turn on the camera by pressing [**▶**] (PLAY).
- You can specify a snapshot you recorded as the startup image, or you can use the special startup image provided in the camera’s built-in memory.
- Formatting built-in memory (page 169) will delete the current startup image setting.
- You can select the first snapshot of a CS group as the startup image. If you want to select another image within a CS group, you need to first divide up the CS group or use the CS Frame Edit feature to make a copy of the image outside of the CS group.

Formatting Built-in Memory or a Memory Card (Format)

Procedure

[MENU] → Set Up Tab → Format

If a memory card is loaded in the camera, this operation will format the memory card. It will format built-in memory if no memory card is loaded.

- The format operation will delete all contents on the memory card or in built-in memory. It cannot be undone. Make sure you do not need any data currently on the card or in built-in memory before you format it.
- Formatting built-in memory will delete the following data.
 - Protected images
 - BEST SHOT user setups
 - Startup screen
- Formatting a memory card will delete the following data.
 - Protected images
- Check the battery level before starting a format operation and make sure it is not too low. Formatting may not be performed correctly and the camera may stop operating normally if the camera powers down while formatting is in progress.
- Never open the battery cover while formatting is in progress. Doing so can cause the camera to stop operating normally.

Resetting the Camera to Factory Defaults (Reset)

Procedure

[MENU] → Set Up Tab → Reset

See page 183 for details about the camera's factory default settings.

The settings below are not reset.

World Time settings, clock settings, date style, screen language, video output

Precautions during Use

■ Avoid Use While In Motion

- Never use the camera to record or play back images while operating an automobile or other vehicle, or while walking. Looking at the monitor while in motion creates the risk of serious accident.

■ Directly Viewing the Sun or Bright Light

- Never look at the sun or any other bright light through the camera's viewfinder. Doing so can damage your eyesight.

■ Flash

- Never use the flash unit in areas where flammable or explosive gas may be present. Such conditions create the risk of fire and explosion.
- Never fire the flash in the direction of a person operating a motor vehicle. Doing so can interfere with the driver's vision and create the risk of accident.
- Never fire the flash too close to the eyes of the subject. Doing so creates the risk of loss of eyesight.

■ Monitor Screen

- Should the monitor screen ever become cracked, never touch any of the liquid inside the monitor screen. Doing so creates the risk of skin inflammation.
- Should monitor screen liquid ever get into your mouth, immediately rinse your mouth out and contact your physician.
- Should monitor screen liquid ever get into your eyes or onto your skin, immediately rinse with clean water for at least 15 minutes and contact your physician.

■ Connections

- Never plug any devices that are not specified for use with this camera into connectors. Connecting a non-specified device creates the risk of fire and electric shock.

■ Transport

- Never operate the camera inside of an aircraft or anywhere else where operation of such devices is restricted. Improper use creates the risk of serious accident.

■ **Smoke, abnormal odor, overheating, and other abnormalities**

- Continued use of the camera while it is emitting smoke or strange odor, or while it is overheating creates the risk of fire and electric shock. Immediately perform the following steps whenever any of the above symptoms are present.
 1. Turn off the camera.
 2. Remove the battery from the camera, taking care to protect yourself against burn injury.
 3. Contact your dealer or nearest CASIO authorized service center.

■ **Water and Foreign Matter**

- Water, other liquids, or foreign matter (especially metal) getting inside the camera creates the risk of fire and electric shock. Immediately perform the following steps whenever any of the above symptoms are present. Particular care is required when using the camera where it is raining or snowing, near the ocean or other body of water, or in a bathroom.
 1. Turn off the camera.
 2. Remove the battery from the camera.
 3. Contact your dealer or nearest CASIO authorized service center.

■ **Dropping and Rough Treatment**

- Continued use of the camera after it is damaged by dropping or other rough treatment creates the risk of fire and electric shock. Immediately perform the following steps whenever any of the above symptoms are present.
 1. Turn off the camera.
 2. Remove the battery from the camera.
 3. Contact your dealer or nearest CASIO authorized service center.

■ **Keep Away From Fire**

- Never expose the camera to fire, which can cause it to explode and creates the risk of fire and electric shock.

■ **Disassembly and Modification**

- Never try to take the camera apart or modify it in any way. Doing so creates the risk of electric shock, burn injury, and other personal injury. Be sure to leave all internal inspection, maintenance, and repair up to your dealer or nearest CASIO authorized service center.

■ Locations To Be Avoided

- Never leave the camera in any of the following types of locations. Doing so creates the risk of fire and electric shock.
 - Areas subject to large amounts of humidity or dust
 - Food preparation areas or other locations where oil smoke is present
 - Near heaters, on a heated carpet, in areas exposed to direct sunlight, in a closed vehicle parked in the sun, or other areas subject to very high temperatures
- Never place the camera on an unstable surface, on a high shelf, etc. Doing so can cause the camera to fall, creating the risk of personal injury.

■ Backing Up Important Data

- Always keep backup copies of important data in camera memory by transferring it to a computer or other storage device. Note that data can be deleted in the case of camera malfunction, repair, etc.

■ Memory Protection

- Whenever replacing the battery, be sure to follow the correct procedure as described in the documentation that comes with the camera. Incorrectly replacing the battery can result in corruption or loss of data in camera memory.

■ Rechargeable Battery

- Use only the USB-AC adaptor (AD-C53U) or the specified device to charge the battery. Attempting to charge the battery by an unauthorized means creates the risk of battery overheating, fire, and explosion.
- Do not expose or immerse the battery in fresh water or salt water. Doing so can damage the battery, and cause deterioration of its performance and loss of service life.
- The battery is intended for use with a CASIO Digital Camera only. Use with any other device creates the risk of the battery damage, or deterioration of battery performance and service life.
- Failure to observe any of the following precautions creates the risk of battery overheating, fire, and explosion.
 - Never use or leave the battery near open flame.
 - Do not expose the battery to heat or fire.
 - Never carry or store the battery together with items that can conduct electricity (necklaces, pencil lead, etc.).
 - Never disassemble the battery, pierce it with a needle, or expose it to strong impact (hit it with a hammer, step on it, etc.), and never apply solder to it. Never place the battery into a microwave oven, heater, high-pressure generating device, etc.

- Should you ever notice leakage, strange odor, heat generation, discoloration, deformation, or any other abnormal condition while using, charging, or storing a battery, immediately remove it from the camera and keep it away from open flame.
- Do not use or leave the battery under direct sunlight, in an automobile parked in the sun, or in any other area subject to high temperatures. Doing so can damage the battery, and cause deterioration of its performance and loss of service life.
- If battery charging does not end normally within the specified charging time, stop charging anyway and contact your local CASIO authorized service center. Continued charging creates the risk of battery overheating, fire, and explosion.
- Battery fluid can damage your eyes. Should battery fluid get into your eyes accidentally, immediately rinse them with clean tap water and then consult a physician.
- Be sure to read the user documentation that comes with the camera and special USB-AC adaptor before using or charging the battery.
- If a battery is to be used by young children, make sure that a responsible adult makes them aware of the precautions and proper handling instructions, and make sure that they handle the battery correctly.
- Should fluid from a battery accidentally get onto clothing or your skin, immediately rinse it off with clean tap water. Prolonged contact with battery fluid can cause skin irritation.

■ Battery Life

- Battery continuous operation times provided in this manual represent the approximate amount of time before the camera turns off due to low battery power when being powered by the special battery under normal temperature (23°C (73°F)). They do not guarantee that you will be able to achieve the indicated level of operation. Actual battery life is greatly affected by ambient temperature, battery storage conditions, the amount of time spent in storage, etc.
- Leaving the camera on can run down the battery and cause the low battery warning to appear. Turn off the camera whenever you are not using it.
- The low battery warning indicates that the camera is about to turn off due to low battery power. Charge the battery as soon as possible. Leaving a low or dead battery in the camera can lead to battery leakage and data corruption.

■ Data Error Precautions

Your digital camera is manufactured using precision digital components. Any of the following creates the risk of corruption of data in camera memory.

- Removing the battery or memory card while the camera is performing some operation
- Removing the battery or memory card while the back lamp is flashing green after turning off the camera
- Disconnecting the USB cable while communication is in progress
- Using a battery that is low
- Other abnormal operations

Any of the above conditions can cause an error message to appear on the monitor screen (page 192). Perform the action indicated by the message that appears.

■ Operating Environment

- Operating Temperature Requirements: 0 to 40°C (32 to 104°F)
- Operating Humidity: 10 to 85% (non condensation)
- Do not place the camera in any of the following locations.
 - In an area exposed to direct sunlight, or large amounts of moisture, dust, or sand
 - Near an air conditioner or in other areas subjected to extreme temperature or humidity
 - Inside of a motor vehicle on a hot day, or in an area subjected to strong vibration

■ Condensation

Sudden and extreme temperature changes, such as when the camera is moved from the outdoors on a cold winter day into a warm room, can cause water droplets called “condensation” to form on the interior and the exterior of the camera, which creates the risk of malfunction. To prevent condensation from forming seal the camera in a plastic bag before changing locations. Then leave the bag sealed to allow the air inside to naturally change to the same temperature as the air in the new location. After that, remove the camera from the bag and open the battery cover for a few hours.

■ Lens

- Never apply too much force when cleaning the surface of the lens. Doing so can scratch the lens surface and cause malfunction.
- You may sometimes notice some distortion in certain types of images, such as a slight bend in lines that should be straight. This is due to the characteristics of lenses, and does not indicate malfunction of the camera.

■ Caring for your camera

- Never touch the lens or flash window with your fingers. Finger smudges, dirt, and other foreign matter on the lens or flash window can interfere with proper operation of the camera. Use a blower or other means to keep the lens and flash window free of dirt and dust, and wipe gently with a soft, dry cloth.
- To clean the camera, wipe it with a soft, dry cloth.

■ Old Rechargeable Battery Handling Precautions

- Insulate the positive and negative terminals with tape, etc.
- Do not peel the covering off of the battery.
- Do not try to take the battery apart.

■ USB-AC adaptor Handling Precautions



- Never plug the power cord into an outlet whose voltage rating is different from that marked on the power cord. Doing so creates the risk of fire, malfunction, and electric shock.
 - Take care to protect the power cord against damage and breaking. Never place heavy objects onto the power cord, or expose it to intense heat. Doing so can damage the power cord, creating the risk of fire and electric shock.
 - Never try to modify the power cord, or subject it to severe bending, twisting, or pulling. Doing so creates the risk of fire, malfunction, and electric shock.
 - Never plug in or unplug the power cord while your hands are wet. Doing so creates the risk of electric shock.
 - Do not plug the power cord into an outlet or extension cord that is shared by other devices. Doing so creates the risk of fire, malfunction, and electric shock.
 - Should the power cord ever become damaged (to the point that internal wires are exposed or cut), immediately contact your original retailer or a CASIO authorized service center to request repair. Continued use of a damaged power cord creates the risk of fire, malfunction, and electric shock.
- The USB-AC adaptor becomes slightly warm during charging. This is normal and does not indicate malfunction.
 - Unplug the power cord from the power outlet when you are not using the USB-AC adaptor.
 - Never use detergent to clean the power cord (especially the plug).
 - Never cover the USB-AC adaptor with a blanket, etc. Doing so creates the risk of fire.

■ Other Precautions

The camera becomes slightly warm during use. This is normal and does not indicate malfunction.

■ Copyrights

Except for your own personal enjoyment, unauthorized use of use of snapshots or movies of images whose rights belong to others, without the permission of the right holder, is forbidden by copyright laws. In some cases, shooting of public performances, shows, exhibitions, etc. may be restricted entirely, even if it is for your own personal enjoyment. Regardless of whether such files are purchased by you or obtained for free, posting them on a website, a file sharing site, or any other Internet site, or otherwise distributing them to third parties without the permission of the copyright holder is strictly prohibited by copyright laws and international treaties. For example, uploading or distributing on the Internet images of TV programs, live concerts, music videos, etc. that were photographed or recorded by you may infringe upon the rights of others. Note that CASIO COMPUTER CO., LTD. shall not be held liable for use of this product in any way that infringes on the copyrights of others or that violates copyright laws.

The following terms, which are used in this manual, are registered trademarks or trademarks of their respective owners.

Note that trademark [™] and registered trademark [®] are not used within the text of this manual.

- SDXC Logo is a trademark of SD-3C, LLC.
- Microsoft, Windows, Internet Explorer, Windows Media, Windows Vista, Windows 7, and DirectX are registered trademarks or trademarks of Microsoft Corporation in the United States and other countries.
- Macintosh, Mac OS, QuickTime, and iPhoto are trademarks of Apple Inc.
- YouTube and the YouTube logo are trademarks or registered trademarks of Google Inc.
- HDMI, the HDMI logo, and High-Definition Multimedia Interface are trademarks or registered trademarks of HDMI Licensing, LLC.
- EXILIM, Photo Transport, Dynamic Photo, Dynamic Photo Manager, and YouTube Uploader for CASIO are registered trademarks or trademarks of CASIO COMPUTER CO., LTD.
- All other company or product names mentioned herein may be registered trademarks or trademarks of their respective companies.

Any and all unauthorized copying, distribution, and transfer for commercial purposes of the software provided by CASIO for this product are prohibited.

This product's YouTube upload functionality is included under license from YouTube, LLC. The presence of YouTube upload functionality in this product is not an endorsement or recommendation of the product by YouTube, LLC.

Power Supply

Charging

■ If the camera's back lamp starts flashing red...

If the back lamp starts flashing red during charging, it means that further charging is not possible for one of the reasons below. Perform the actions described below to correct the problem and then try charging again.

Ambient temperature or the temperature of the battery is abnormally high or low

Unplug the USB cable from the camera and wait for a while until the camera is within the temperature range of 5°C to 35°C (41°F to 95°F), and then try charging again.

Safety timer activated

A battery that has not been used for a long time, certain types of computers, and connection conditions can cause charging to take longer than normal. If charging takes longer than about six hours, a safety timer will terminate it automatically, even if the battery is not fully charged. If the battery has not been used for a very long time, charging may terminate automatically after only about 45 minutes.

- 1) Using a battery that has not been used for a long time.
Disconnect and then reconnect the USB cable to resume charging.
- 2) Insufficient power supply when connected to computer
Connect directly to a USB port what supplies a current of 500mA.

For details about the power supply capacity of a computer's USB port, contact the manufacturer of the computer. Though disconnecting and then reconnecting the USB cable will resume charging, you may need to do so repeatedly if the power supply capacity of the computer is low.

If problems continue to occur after you perform the above steps, it could mean that the battery is faulty. Contact your nearest CASIO authorized service center.

To replace the battery

1. Open the battery cover and remove the current battery.

With the monitor screen side of the camera facing upwards, slide the stopper in the direction indicated by the arrow in the illustration. After the battery pops out, pull it the rest of the way out of the camera.

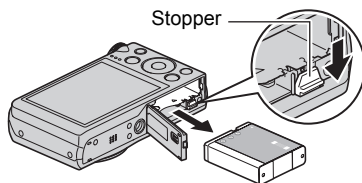

2. Load a new battery.

Battery Precautions

■ Precautions during Use

- Operation provided by a battery under cold conditions is always less than operation under normal temperatures. This is due to the characteristics of the battery, not the camera.
- Charge the battery in an area where the temperature is within the range of 5°C to 35°C (41°F to 95°F). Outside this temperature range charging can take longer than normal or even fail.
- Do not tear or remove the battery outer label.
- If a battery provides only very limited operation following a full charge, it probably means the battery has reached the end of its service life. Replace the battery with a new one.

■ Storage Precautions

- Storing the battery for a long time while it is charged can cause deterioration of battery characteristics. If you do not plan to use a battery for some time, fully use up its charge before storing it.
- Always remove the battery from the camera when you are not using it. A battery left in the camera can discharge and go dead, which will require some time to charge when you need to use the camera.
- Store batteries in a cool, dry place (20°C (68°F) or lower).
- To prevent over discharging of an unused battery, fully charge it, and then load it in the camera and fully use up the charge about once every six months.

Using the Camera in another Country

■ Precautions during Use

- The bundled USB-AC adaptor is designed for operation with any power supply in the range of 100V to 240V AC, 50/60Hz. Note, however, that the shape of the power cord plug depends on each country or geographic area. Before taking the camera and USB-AC adaptor along on a trip, check with travel agent about the power supply requirements in your destination(s).
- Do not connect the USB-AC adaptor to a power supply through a voltage converter or similar device. Doing so can lead to malfunction.

■ Extra Batteries

- Taking along extra fully charged batteries (NP-130) is recommended while on a trip in order to avoid not being able to shoot images due to the battery going dead.

Using a Memory Card

See page 23 for information about supported memory cards and how to load a memory card.

To replace the memory card

Press the memory card and then release it. This will cause it to pop out of the memory card slot slightly. Pull the card out the rest of the way and then insert another one.

- Never remove a card from the camera while the back lamp is flashing green. Doing so can cause the image save operation to fail and even damage the memory card.

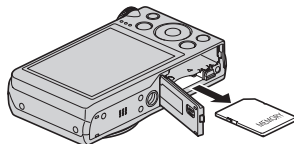

Using a Memory Card

- SD memory cards, SDHC memory cards, and SDXC memory cards have a write protect switch. Use the switch when you need to guard against accidentally deleting data. Note, however, if you write protect an SD memory card you must then turn write protection off whenever you want to record to it, format it, or delete any of its images.
- If a memory card starts to behave abnormally during image playback, you can restore normal operation by reformatting it (page 169). However, it is recommended that you always take along multiple memory cards whenever using the camera far away from the home or office.
- As you record data to and delete data from a memory card a number of times, it loses its ability to retain data. Because of this, periodic re-formatting of a memory card is recommended.
- Electrostatic charge, electrical noise, and other phenomena can cause data to become corrupted or even lost. Make sure that you always back up important data on other media (CD-R, CD-RW, hard disk, etc.).

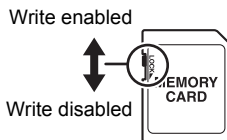

■ Discarding or Transferring Ownership of a Memory Card or the Camera

The format and delete functions of the camera do not actually delete files from the memory card. The original data remains on the card. Note that responsibility for the data on a memory card lies with you. The following procedures are recommended whenever you discard a memory card or the camera, or if you transfer ownership to another party.

- When discarding a memory card, either physically destroy the memory card or use commercially available data delete software to completely delete the data on the memory card.
- When transferring ownership of a memory card to another party, use commercially available data deletion software to completely delete the data on it.

Use the format function (page 169) to completely delete the data in built-in memory before discarding or transferring ownership of the camera.

Computer System Requirements for Software (For Windows)

Computer system requirements are different for each of the applications. Be sure to check the requirements for the particular application you are trying to use. Note that the values provided here are minimum requirements for running each application. Actual requirements are greater, depending on the number of images and the sizes of the images being handled.

● Windows

YouTube Uploader for CASIO

Operating System : Windows 7, Windows Vista, Windows XP (SP3)

Other : Sufficient memory to run the operating system
Computer configuration that enables playback of movies on the YouTube site
Computer configuration that enables upload of movies to the YouTube site

Photo Transport 1.0

Operating System : Windows 7, Windows Vista, Windows XP (SP3)

Memory : At least 64MB

Hard Disk Drive Space : At least 2MB

Dynamic Photo Manager

Operating System : Windows 7, Windows Vista (SP1), Windows XP (SP3)

Memory : At least 512MB

Hard Disk Drive Space : At least 10MB

Internet Browser : Internet Explorer 6.0 or greater or equivalent function browser

Other : QuickTime 7.6 or higher and Windows Media Player 10 or higher installed.
Computer with continuous Internet connection (1Mbps or greater)

Reset Initial Default Settings

The tables in this section show the initial default settings that are configured for menu items (displayed when you press [MENU]) after you reset the camera (page 169).

Menu items depend on whether the camera is in the REC mode or PLAY mode.

- A dash (-) indicates an item whose setting is not reset or an item for which there is no reset setting.



IMPORTANT!

- Switching the recording mode (page 28) to “Premium Auto PRO” will make some menu items unavailable.



■ REC Mode

“REC” Tab

Zoom (SR)	Single
Focus	AF (Auto Focus)
Self-timer	Off
Anti Shake	On
AF Area	AF Spot
AF Assist Light	On
Face Detection	Off
Continuous AF	Off
Digital Zoom	On
Wind Noise Cut	Off
L/R Key	Off
Grid	Off



Review	Off
Icon Help	On
Memory	Flash: On / Focus: Off / ISO: Off / White Balance: Off / EV Shift: Off / AF Area: On / Metering: Off / Self-timer: Off / Flash Intensity: Off / Zoom (SR): On / Digital Zoom: On / MF Position: Off / Zoom Position: Off

“Quality” Tab

 Quality (Snapshots)	Normal
 Quality (Movies)	FHD
Metering	 Multi
Lighting	On

Flash Intensity	0
Color Filter	Off
Sharpness	0
Saturation	0
Contrast	0

“Set Up” Tab

Screen	Auto
Eye-Fi	On
Auto Rotate	On
Sounds	Startup: Sound 1 / Half Shutter: Sound 1 / Shutter: Sound 1 / Operation: Sound 1 /  Operation: ■■■□□□□ /  Play: ■■■□□□□
File No.	Continue
Create Folder	–
World Time	–
Timestamp	Off

Adjust	–
Date Style	–
Language	–
Sleep	1 min
Auto Power Off	5 min
REC/PLAY	Power On
USB	Mass Storage
Video Out	–
HDMI Output	Auto
Startup	Off
Format	–
Reset	–

■ PLAY Mode

“PLAY” Tab

Slideshow	Images: All images / Time: 30 min / Interval: 3 sec / Effect: Pattern 1
Dynamic Photo	–
Movie Converter	–
MOTION PRINT	Create
Movie Editing	–
Lighting	–
White Balance	–
Brightness	–

DPOF Printing	–
Protect	–
Date/Time	–
Rotation	–
Resize	–
Trimming	–
Copy	–
Divide Group	–
CS Multi Print	–
CS Frame Edit	–

“Set Up” Tab

- The contents of the “Set Up” tab are the same in the REC mode and PLAY mode.

Using the On-screen Histogram to Check Exposure (+Histogram)

Displays a histogram on the monitor screen which you can use to check the exposure of an image before you shoot it. You also can display the histogram in the PLAY mode for information about the exposure levels of images.



Histogram

NOTE

- A centered histogram does not necessarily guarantee optimum exposure. The recorded image may be over-exposed or under-exposed, even though its histogram is centered.
- Due to the limitations of exposure compensation, you may not be able to achieve an optimum histogram configuration.
- Use of the flash and certain shooting conditions can cause the histogram to indicate exposure that is different from the actual exposure of the image when it is shot.
- The histogram cannot be displayed during high speed movie recording.

How to Use the Histogram

A histogram is a graph that represents the lightness of an image in terms of the number of pixels. The vertical axis indicates the number of pixels, while the horizontal axis indicates lightness. If the histogram appears too lopsided for some reason, you can use EV shift to move it left or right in order to achieve better balance. Optimum exposure can be achieved by EV shifting so the graph is as close to the center as possible. For snapshots, you can even display individual histograms for R (red), G (green), and B (blue).

Example Histograms

A histogram towards the left side results when the overall image is dark. A histogram that is too far to the left may result in “black out” of the dark areas of an image.



A histogram towards the right side results when the overall image is light. A histogram that is too far to the right may result in “white out” of the light areas of an image.











An overall well-balanced histogram results when the overall image is at optimal lightness.







When things don't go right...

Troubleshooting

Problem	Possible Cause and Recommended Action
Power Supply	
Power does not turn on.	<ol style="list-style-type: none">1)The battery may not be loaded correctly (page 16).2)The battery may be dead. Charge the battery (page 17). If the battery goes dead soon after being charged, it means the battery has reached the end of its life and needs to be replaced. Purchase a separately available CASIO NP-130 rechargeable lithium ion battery.
The camera suddenly powers down.	<ol style="list-style-type: none">1)Auto Power Off may have activated (page 166). Turn power back on.2)The battery may be dead. Charge the battery (page 17).3)The camera's protection function may have activated because camera temperature is too high. Turn off the camera and wait until it cools down before trying to use it again.
Power will not turn off. Nothing happens when a button is pressed.	Remove the battery from the camera and then reload them.
Image Recording	
Image is not recorded when the shutter button is pressed.	<ol style="list-style-type: none">1)If the camera is in the PLAY mode, press [] (REC) to enter the REC mode.2)If the flash is charging, wait until the charge operation finishes.3)If the message "Memory Full" appears, transfer images to your computer, delete images you no longer need, or use a different memory card.
Auto Focus does not focus properly.	<ol style="list-style-type: none">1)If the lens is dirty, clean it off.2)The subject may not be in the center of the focus frame when you compose the image.3)The subject you are shooting may not be a type that is compatible with Auto Focus (page 36). Use manual focus (page 91).4)You may be moving the camera when shooting. Try shooting with Anti Shake or use a tripod.

Problem	Possible Cause and Recommended Action
The subject is out of focus in the recorded image.	The image may not be focused properly. When composing the image, make sure the subject is located inside the focus frame.
The flash does not fire.	<ol style="list-style-type: none"> 1) If  (Flash Off) is selected as the flash mode, change to another mode (page 47). 2) If the battery is low, charge it (page 17). 3) If a BEST SHOT scene that uses  (Flash Off) is selected, change to a different flash mode (page 47) or select a different BEST SHOT scene (page 73).
The red  (Flash Off) icon is displayed on the monitor screen and the flash does not fire.	The flash unit may be malfunctioning. Contact a CASIO authorized service center or your original retailer. Note that though the flash will not fire, you still can use the camera for non-flash shots.
Camera powers down during Self-timer countdown.	The battery may be low. Charge the battery.
The monitor screen image is out of focus.	<ol style="list-style-type: none"> 1) You may be using Manual Focus and have not focused the image. Focus the image (page 91). 2) You may be using  (Macro) for scenery or portraits. Use Auto Focus for scenery and portrait shots (page 91). 3) You may be trying to use Auto Focus or  (Infinity) when shooting a close-up shot. Use the  (Macro) for close ups (page 91).
There is digital noise in images.	<ol style="list-style-type: none"> 1) Sensitivity may have been increased automatically for a dark subject, which increases the chance of digital noise. Use a light or some other means to illuminate the subject. 2) You may be attempting to shoot in a dark location with  (Flash Off) selected, which can increase digital noise and make images appear coarse. In this case, turn on flash (page 47) or use lights for illumination. 3) Lighting (page 103) may be enabled for snapshots, which can cause an increase in digital noise. Use a light or some other means to illuminate the subject. 4) Shooting movies for long periods in areas where temperature is relatively high can cause digital noise (dots of light) to appear in the movie image. If this happens, move to a cooler environment or turn off the camera and allow it to cool down, which should cause normal operation to resume.

Problem	Possible Cause and Recommended Action
A recorded image was not saved.	1) Camera power may have been turned off before the save operation was complete, which will result in the image not being saved. If the battery indicator shows  , charge the battery as soon as possible (page 21). 2) You may have removed the memory card from the camera before the save operation was complete, which will result in the image not being saved. Do not remove the memory card before the save operation is complete.
Though available lighting is bright, the faces of people in the image are dark.	Not enough light is reaching the subjects. Change the flash mode setting to  (Flash On) for daylight synchro flash (page 47), or adjust EV shift to the + side (page 46).
Night shots come out bad.	Use the following BEST SHOT scenes (page 73) when shooting at night. <ul style="list-style-type: none"> • High Speed Night Scene (for shooting night scenery only) • High Speed Night Scene and Portrait (for shooting people against night scenery)
Subjects are too dark when shooting images in a seashore or ski area.	Sunlight reflected by water, sand, or snow, can cause underexposure of images. Change the flash mode setting to  (Flash On) for daylight synchro flash (page 47), or adjust EV shift to the + side (page 46).
Digital zoom will not go up to the maximum value.	1) The digital zoom setting may be turned off. Turn on digital zoom (page 99). 2) Zoom will not go up to the maximum value if the “Zoom (SR)” setting is “Single”. Change the setting to “Off” (page 52). 3) Zoom will not go up to the maximum value if the snapshot size setting is “VGA”. Change to a different setting (page 42).
The image is out of focus during movie recording.	1) Focusing may not be possible because the subject is outside the focus range. Shoot within the allowable range. 2) The lens may be dirty. Clean the lens (page 174). 3) During High Speed Movie recording, focus is fixed at the position where it was when recording started. To focus an image, half-press the shutter button for Auto Focus or focus manually before you press  (Movie) to start recording.
Movie recording suddenly stops.	The camera’s protection function may have activated because camera temperature is too high. Wait until the camera temperature drops to normal levels.

Problem	Possible Cause and Recommended Action
Playback	
The color of the playback image is different from what appears on the monitor screen when shooting.	Sunlight or light from another source may be shining directly into the lens when you are shooting. Position the camera so sunlight does not shine directly into the lens.
Images are not displayed.	This camera cannot display non-DCF images recorded onto a memory card using another digital camera.
Images cannot be edited (with White Balance, Brightness, Resize, Trimming, Rotation).	Note that you cannot edit the following types of snapshots. <ul style="list-style-type: none"> • Snapshots created using MOTION PRINT • CS group snapshots • Movies • Panorama Image • Snapshots recorded with another camera
File Deletion	
A file cannot be deleted.	The file may be protected. Unprotect the file (page 124).
Other	
The wrong date and time are displayed, or the wrong date and time are being stored along with image data.	The date and time setting is off. Set the correct date and time (page 164).
The messages on the display are in the wrong language.	The wrong display language is selected. Change the display language setting (page 165).
Images cannot be transferred over a USB connection.	<ol style="list-style-type: none"> 1)The USB cable may not be connected securely. Check all connections. 2)The wrong USB communication protocol is selected. Select the correct USB communication protocol in accordance with the type of device you are connecting (pages 143, 152). 3)If the camera is not turned on, turn it on. 4)Your computer may not be able to recognize the camera if you connect via a USB hub. Always connect directly to the computer's USB port.

Problem	Possible Cause and Recommended Action
Language selection screen appears when the camera is turned on.	<p>1) You did not configure initial settings after purchasing the camera or the camera may have been left with a dead battery. Configure the correct settings (pages 22, 165).</p> <p>2) There may be a problem with the camera's memory data. If this is the case, perform the reset operation to initialize the camera's setup (page 169). After that, configure each setting. If the language selection screen does not re-appear when you turn the camera on, it means that the camera's memory management data has been restored.</p> <p>If the same message appears after you turn power back on, contact your retailer or a CASIO authorized service center.</p>
The time and date settings configured the first time after purchasing the camera are reset to their factory defaults when I remove the camera's battery.	<p>Load the camera's battery and reconfigure the time and date settings (page 22). Do not remove the battery from the camera for at least 24 hours after configuring time and date settings. After that, the settings will not be reset if you remove the battery.</p> <ul style="list-style-type: none"> • If the time and date are reset to their factory default settings when you remove the battery after it has been loaded for more than 24 hours, it could mean that the camera's setting memory is defective. Contact your retailer or a CASIO authorized service center.
Buttons are not responsive right after the power has been turned on.	<p>With large capacity memory cards there is a delay after the power has been turned on before the buttons become responsive.</p>

Display Messages

ALERT	The camera's protection function may have activated because camera temperature is too high. Turn off the camera and wait until it cools down before trying to use it again.
Battery is low.	Battery power is low.
Cannot find the file.	The image you specified with the slideshow "Images" setting cannot be found. Change the "Images" setting (page 117) and try again.
Cannot register any more files.	You are attempting to save a user BEST SHOT scene in the "SCENE" folder when the folder already contains 999 user scenes.
Card ERROR	<p>There is something wrong with the memory card. Turn off the camera, remove the memory card and then reload it into the camera. If this message re-appears when you turn the camera back on, format the memory card (page 169).</p> <p> IMPORTANT!</p> <ul style="list-style-type: none">• Formatting a memory card deletes all its files. Before formatting, try transferring recoverable files to a computer or some other storage device.
Check connections!	You are attempting to connect the camera to a printer while the camera's USB settings are not compatible with the USB system of the printer (page 133).
Files could not be saved because battery is low.	Battery power is low, so an image file could not be saved.
Folder cannot be created.	You are trying to record a file while there are already 9999 files stored in the 999th folder. If you want to record more, delete files you no longer need (page 33).
Images are being uploaded. Please wait.	You are attempting to turn off power while image data is being transferred using the Eye-Fi card (page 156).
LENS ERROR	This message appears and the camera turns off whenever the lens performs some unexpected operation. If the same message appears after you turn power back on, contact a CASIO authorized service center or your original retailer.
LENS ERROR 2	The Anti Shake unit of the camera may be malfunctioning. If the same message appears after you turn power back on, contact your retailer or a CASIO authorized service center.
Load paper!	The printer ran out of paper while printing.

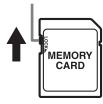
Memory Full	Memory is full with images you recorded and/or files saved by editing operations. When shooting with Prerecord CS, this message indicates that there is not enough memory capacity to record all of the pre-recorded images. Delete files you no longer need (page 33).
Printing Error	An error occurred while printing. <ul style="list-style-type: none"> • The printer is turned off. • The printer generated an error, etc.
Record Error	Image compression could not be performed for some reason during image data recording. Perform a zoom operation to change the composition of the image and shoot it again.
SYSTEM ERROR	Your camera system is corrupted. Contact your retailer or a CASIO authorized service center.
The card is locked.	The LOCK switch of the SD, SDHC, or SDXC memory card loaded in the camera is in the locked position. You cannot store images to or delete images from a memory card that is locked. <div style="float: right; text-align: center;"> <p>LOCK</p>  </div>
There are no files.	There are no files in built-in memory or on the memory card.
There are no printing images. Set up DPOF.	There are currently no files specified for printing. Configure the required DPOF settings (page 136).
There is no image to register.	The setup you are trying to save is for an image that cannot be saved as a user BEST SHOT scene.
This card is not formatted.	The memory card loaded in the camera is not formatted. Format the memory card (page 169).
This file cannot be played.	The file you are trying to access is corrupted or is a type that cannot be displayed by this camera.
This function cannot be used.	This message will appear part way through an operation when you attempt to use a function that is not allowed in combination with another function.

Number of Snapshots/Movie Recording Time

Snapshot

Image Size (Pixels)	Image Quality	Approximate Image File Size	Built-in Memory (Approx. 52.2MB ¹⁾ Snapshot Recording Capacity	Memory Card (16GB ²) Snapshot Recording Capacity
16M (4608×3456)	Fine	10.71 MB	3	1072
	Normal	5.57 MB	5	1654
3:2 (4608×3072)	Fine	9.43 MB	4	1214
	Normal	4.92 MB	6	1873
16:9 (4608×2592)	Fine	7.83 MB	5	1466
	Normal	4.1 MB	7	2221
10M (3648×2736)	Fine	6.4 MB	6	1787
	Normal	3.38 MB	9	2728
5M (2560×1920)	Fine	2.99 MB	10	2990
	Normal	1.72 MB	14	4283
3M (2048×1536)	Fine	2.0 MB	15	4669
	Normal	1.25 MB	22	6533
VGA (640×480)	Fine	430 KB	67	19683
	Normal	290 KB	91	26809

Movies

Image Quality (Pixels) / (Audio)	Maximum File Size	Approximate Data Rate (Frame Rate)	Built-in Memory (Approx. 52.2MB ^{*1}) Movie Recording Capacity	Memory Card (16GB ^{*2}) Movie Recording Capacity	File Size of 1-minute Movie
FHD (1920×1080) (Stereo)	Maximum Movie Size: 29 minutes	14.2 Megabits/second (30 frames/second)	27 seconds	35 minutes 59 seconds	106.5 MB
HD (1280×720) (Stereo) *4		10.9 Megabits/second (15 frames/second)	35 seconds	46 minutes 54 seconds	81.8 MB
STD (640×480) (Stereo)		3.9 Megabits/second (30 frames/second)	1 minute 41 seconds	2 hours 12 minutes 54 seconds	29.3 MB
HS1000 (224×64) (No audio)		40.0 Megabits/second (1000 frames/second)	10 seconds	13 minutes 10 seconds	300.0 MB
HS480 (224×160) (No audio)		40.0 Megabits/second (480 frames/second)	9 seconds	13 minutes 2 seconds	300.0 MB
HS240 (512×384) (No audio)		40.0 Megabits/second (240 frames/second)	9 seconds	12 minutes 58 seconds	300.0 MB
HS120 (640×480) (No audio)		40.0 Megabits/second (120 frames/second)	9 seconds	12 minutes 55 seconds	300.0 MB
HS30-240 (512×384) (Audio recording at 30 fps only)		5.4 Megabits/second (30 frames/second) 40.4 Megabits/second (240 frames/second)	1 minute 13 seconds*3	1 hour 36 minutes 54 seconds*3	40.5 MB*3
HS30-120 (640×480) (Audio recording at 30 fps only)		10.4 Megabits/second (30 frames/second) 40.4 Megabits/second (120 frames/second)	38 seconds*3	49 minutes 57 seconds*3	78.0 MB*3

Image Quality (Pixels) / (Audio)	Maximum File Size	Approximate Data Rate (Frame Rate)	Built-in Memory (Approx. 52.2MB ^{*1}) Movie Recording Capacity	Memory Card (Maximum recording time per recording)
YouTube (HS1000) (224×64) (No audio)	Maximum Movie Size: 2048 MB (or 15 minutes)	40.0 Megabits/second (1000 frames/second)	10 seconds	27 seconds
YouTube (HS480) (224×160) (No audio)		40.0 Megabits/second (480 frames/second)	9 seconds	56 seconds
YouTube (HS240) (512×384) (No audio)		40.0 Megabits/second (240 frames/second)	9 seconds	1 minute 52 seconds
YouTube (HS120) (640×480) (No audio)		40.0 Megabits/second (120 frames/second)	9 seconds	3 minutes 45 seconds
YouTube (HS30-240) (512×384) (Audio recording at 30 fps only)		5.4 Megabits/second (30 frames/second) 40.4 Megabits/second (240 frames/second)	1 minute 13 seconds ^{*3}	15 minutes ^{*3}
YouTube (HS30-120) (640×480) (Audio recording at 30 fps only)		10.4 Megabits/second (30 frames/second) 40.4 Megabits/second (120 frames/second)	38 seconds ^{*3}	15 minutes ^{*3}
YouTube (FHD) (1920×1080) (Stereo)		14.2 Megabits/second (30 frames/second)	27 seconds	15 minutes
YouTube (STD) (640×480) (Stereo)		3.9 Megabits/second (30 frames/second)	1 minute 41 seconds	15 minutes

*1 Built-in memory capacity after formatting

*2 Based on a 16GB SDHC memory card (SanDisk Corporation). The number of images you can save depends on the type of memory card you are using.

*3 Recordable time when the entire movie is recorded at 30 fps. Recording time is shorter if the 30 fps frame rate is switched to 120 fps or 240 fps during recording.

*4 "HD" appears in place of "FHD" when you are shooting with "HDR Art" (page 59).

- Snapshot and movie recording capacity values are approximate and intended for reference only. Actual capacity depends on image contents.
- File size and data rate values are approximate and intended for reference only. Actual values depend on the type of image being shot.
- When using a memory card with a different capacity, calculate the number of images as a percentage of 16GB.
- The time it takes to play back a high speed movie will be different from the time it takes to record it. If you record a 240 fps high speed movie for 10 seconds, for example, it will take 80 seconds to play it back.

Specifications

File Format	Snapshots: JPEG (Exif Version 2.3; DCF 2.0 standard; DPOF compliant) Movies: MOV format, H.264/AVC standard, IMA-ADPCM (stereo)
Recording Media	Built-in Memory (Image Storage Area: 52.2MB*) SD/SDHC/SDXC * Built-in memory capacity after formatting
Recorded Image Sizes	Snapshots: 16M (4608×3456), 3:2 (4608×3072), 16:9 (4608×2592), 10M (3648×2736), 5M (2560×1920), 3M (2048×1536), VGA (640×480) Movies: FHD (1920×1080 30 fps), HD (1280×720 15 fps) (When shooting movie with HDR Art only.), STD (640×480 30 fps), HS1000 (224×64 1000 fps), HS480 (224×160 480 fps), HS240 (512×384 240 fps), HS120 (640×480 120 fps), HS30-240 (512×384 30-240 fps switchable), HS30-120 (640×480 30-120 fps switchable)
Image Deletion	1 file; selected files; all files 1 CS group; 1 image in CS group; selected images in CS group (with memory protection feature)
Effective Pixels	16.1 Megapixels
Imaging Element	Size: 1/2.3-inch square pixel high-speed CMOS Total Pixels: 16.79 Megapixels
Lens/Focal Distance (Snapshot)	F3.0 (W) to 5.9 (T) f = 4.24 to 53.0 mm (equivalent to 24 to 300 mm in 35 mm format) 9 lenses in 8 groups, including aspherical lens.
Zoom	12.5X Optical zoom, 18.8X in combination with Single SR Zoom, 25.0X in combination with Multi SR Zoom 4X Digital zoom Up to 199.3X when HD Zoom and Digital zoom are used in combination (VGA size)
Focusing	Contrast Detection Auto Focus • Focus Modes: Auto Focus, Macro Focus, Super Macro Focus, Infinity, Manual Focus • AF Area: Intelligent, Spot, Multi, Tracking; with AF assist light
Approximate Focus Range (Snapshot) (From Lens Surface)	Auto Focus: 5 cm to ∞ (2.0" to ∞) (Wide Angle) Macro Focus: 1 cm to 50 cm (0.4" to 19.7") (Fifth step zoom from the Widest Angle setting) Super Macro Focus: 1 cm to 50 cm (0.4" to 19.7") Infinity: ∞ (Wide Angle) Manual Focus: 5 cm to ∞ (2.0" to ∞) (Wide Angle) * Range is affected by optical zoom.
Metering	Multi-pattern, center weighted, and spot by imaging element

Exposure Control	Program AE, Aperture Priority AE, Shutter Speed Priority AE, Manual Exposure
Exposure Compensation	-2.0 EV to +2.0 EV (in 1/3EV steps)
Shutter	CMOS electronic shutter, mechanical shutter
Shutter Speed	Snapshot (Auto): 1 to 1/2000 second Snapshot (Aperture Priority AE): 1 to 1/2000 second Snapshot (Shutter Speed Priority AE): 15 to 1/2000 second Snapshot (Manual Exposure): 15 to 1/2000 second * 1/25000-second shutter speed is possible only with High speed Continuous Shutter, shutter speed priority AE or manual exposure. * May differ due to the camera setup.
Aperture Value	F3.0 (W) to F7.9 (W) (ND filter) * Using optical zoom changes the aperture value.
White Balance	Auto, Daylight, Overcast, Shade, Day White Fluorescent, Daylight Fluorescent, Tungsten, Manual WB
Sensitivity (Standard Output Sensitivity)	Snapshots: Auto, ISO 80, ISO 100, ISO 200, ISO 400, ISO 800, ISO 1600, ISO 3200 equivalent Movies: Auto
Self-timer	Approximate Trigger Times: 10 seconds, 2 seconds, Triple Self-timer
Flash Modes	Auto, Off, On, Red-eye reduction
Flash Range (ISO Sensitivity: Auto)	0.4 m to 4.7 m (1.3' to 15.4') (Wide Angle) 0.9 m to 2.4 m (3.0' to 7.9') (Telephoto) * Range is affected by optical zoom.
Flash Intensity Adjustment	-2, -1, 0, +1, +2
Flash Charging Time	Approximately 5 seconds
Recording	Snapshot (Auto/Premium Auto PRO), High Speed Continuous Shutter, Prerecord (Continuous Shutter), Super Resolution, Macro, Super Macro, Self-timer, BEST SHOT, Face detection, Movie recording (FHD Movie, STD Movie, High Speed Movie, HDR ART Movie, Prerecord (Movie), For YouTube) (stereo audio recording (High Speed Movie audio recording supported at 30fps while shooting with HS30-120 or HS30-240)), Snapshot in Movie (single-image, CS), Wind Noise Cut
Monitor Screen	3.0-inch TFT color LCD (Super Clear LCD) 460,800 (960×480) dots
Viewfinder	Monitor Screen
Timekeeping Functions	Date and Time: Recorded with image data Auto Calendar: To 2049
World Time	162 cities in 32 time zones City name, date, time, summer time

External connection terminal	USB port (Hi-Speed USB compatible, USB charging), AV output terminal (NTSC/PAL) HDMI output (Mini)
Microphones	Stereo
Speaker	Monaural
Power Requirements	Rechargeable lithium ion battery (NP-130) ×1

Approximate Battery Life

All of the values provided below represent the approximate amount of time under normal temperature (23°C (73°F)) before the camera turns off. These values are not guaranteed. Low temperatures shorten battery life.

Number of Shots (CIPA) (Operating Time)*1	480 shots
Continuous Playback (Snapshots)*2	5 hours 40 minutes
Approximate continuous movie recording time (High speed movie (HS 240))*3	2 hours 40 minutes
Approximate continuous movie recording time (FHD Movie)*3	2 hours 25 minutes

- Battery: NP-130 (Rated Capacity: 1800 mAh)
- Recording Medium: 16GB SDHC memory card (SanDisk Corporation)
- Measurement Conditions

*1 Approximate number of shots (CIPA) (Operating Time)

In accordance with CIPA (Camera and Imaging Products Association) standards
Normal temperature (23°C (73°F)), monitor on, zoom operation between full wide and full telephoto every 30 seconds, during which two images are shot with flash; power turned off and back on every time 10 images are shot.

*2 Approximate playback time

Standard temperature (23°C (73°F)), one-image scroll approximately every 10 seconds

*3 Approximate time using a 16GB SDHC memory card for a repeated cycle of 10 minutes recording followed by deletion of the recorded file.

- The above values are based a new battery, starting from a full charge. Repeated charging shortens battery life.
- Frequency of flash, zoom, High Speed Continuous Shutter, and Auto Focus usage, and the time the camera is on greatly affects recording time and number of shots values.

Power Consumption	3.7 V DC, Approximately 5.6 W
Dimensions	104.8 (W) × 59.1 (H) × 28.6 (D) mm (4.1" (W) × 2.3" (H) × 1.1" (D)) (24.2 mm (0.95") thick excluding projections)
Weight	Approximately 205 g (7.2 oz) (including battery and memory card) Approximately 165 g (5.8 oz) (excluding battery and memory card)

■ Rechargeable lithium ion battery (NP-130)

Rated Voltage	3.7 V
Rated Capacitance	1800 mAh
Operating Temperature Requirements	0 to 40°C (32 to 104°F)
Dimensions	37.8 (W) × 44.8 (H) × 11.2 (D) mm (1.49" (W) × 1.76" (H) × 0.44" (D)) (excluding projections)
Weight	Approximately 38 g (1.3 oz)

■ USB-AC adaptor (AD-C53U)

Input Power	100 to 240 V AC, 50/60 Hz, 100 mA
Output Power	5.0 V DC, 650 mA
Operating Temperature Requirements	5 to 35°C (41 to 95°F)
Dimensions	53 (W) × 21 (H) × 45 (D) mm (2.1" (W) × 0.83" (H) × 1.8" (D)) (excluding projections)
Weight	Approximately 37 g (1.3 oz)

- Power cord precautions for use in Singapore
The power cord set is not supplied. The power cord used must comply with relevant national and/or international standards.

CASIO®

CASIO COMPUTER CO., LTD.
6-2, Hon-machi 1-chome
Shibuya-ku, Tokyo 151-8543, Japan

Free Manuals Download Website

<http://myh66.com>

<http://usermanuals.us>

<http://www.somanuals.com>

<http://www.4manuals.cc>

<http://www.manual-lib.com>

<http://www.404manual.com>

<http://www.luxmanual.com>

<http://aubethermostatmanual.com>

Golf course search by state

<http://golfingnear.com>

Email search by domain

<http://emailbydomain.com>

Auto manuals search

<http://auto.somanuals.com>

TV manuals search

<http://tv.somanuals.com>