

CASIO®

Digital Camera

EX-Z3000

User's Guide

E

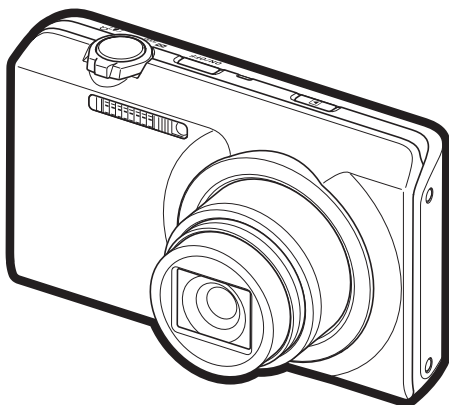

Thank you for purchasing this CASIO product.

- Before using it, be sure to read the precautions contained in this User's Guide.
- Keep the User's Guide in a safe place for future reference.
- For the most up-to-date information about this product, visit the official EXILIM Website at <http://www.exilim.com/>

To go to “Getting the Most Out of Dynamic Photo” click here!

[Dynamic Photo](#)

EXILIM

Download from www.Somanuals.com. All Manuals Search And Download.

Unpacking

As you unpack your camera, check to make sure that all items shown below are included. If anything is missing, contact your original retailer.



Digital camera



Rechargeable lithium ion battery (NP-110)

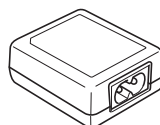

USB-AC adaptor (AD-C53U)

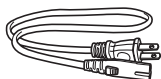

* The shape of the power cord plug varies according to country or geographic area.

Power cord

To attach the strap to the camera

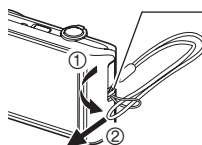

Attach strap here.

Strap



USB cable



AV cable



CD-ROM



Basic Reference

Read this first!

- The contents of this manual are subject to change without notice.
- The contents of this manual have been checked at each step of the production process. Feel free to contact us if you notice anything that is questionable, erroneous, etc.
- Any copying of the contents of this User's Guide, either in part or its entirety, is forbidden. Except for your own personal use, any other use of the contents of this manual without the permission of CASIO COMPUTER CO., LTD. is forbidden under copyright laws.
- CASIO COMPUTER CO., LTD. shall not be held liable for any damages or lost profits suffered by you or any third party due to the use or malfunction of this product.
- CASIO COMPUTER CO., LTD. shall not be held liable for any damages, lost profits, or claims by third parties arising out of the use of Photo Transport, Dynamic Photo Manager, Virtual Painter 5 LE for CASIO, or YouTube Uploader for CASIO.
- CASIO COMPUTER CO., LTD. shall not be held liable for any damages or lost profits caused by loss of memory contents due to malfunction, repair, or any other reason.
- Note that the example screens and product illustrations shown in this User's Guide may differ somewhat from the screens and configuration of the actual camera.

LCD Panel

The liquid crystal panel of the monitor screen uses high-precision technology that provides a pixel yield in excess of 99.99%. This means that some very small number of pixels may not light or may remain lit at all times. This is due to the characteristics of the liquid crystal panel, and does not indicate malfunction.

Take test shots

Before shooting your final image, shoot a test shot to ensure that the camera is recording correctly.

Contents

Unpacking	2
Read this first!	3
General Guide	8
Monitor Screen Contents	9

■ Quick Start Basics 11

What is a digital camera?	11
What you can do with your CASIO camera	12
Using the Touch Panel	13
First, charge the battery prior to use.....	15
■ To load the battery	15
■ Charge the Battery	16
Configuring Basic Settings the First Time You Turn On the Camera	21
Preparing a Memory Card	23
■ Supported Memory Cards	23
■ To load a memory card	23
■ To format (initialize) a new memory card	24
Turning Power On and Off	25
Holding the Camera Correctly	27
To Shoot a Snapshot	28
■ Selecting an Auto Recording Mode	28
■ To shoot a snapshot	29
Viewing Snapshots	32
Deleting Snapshots and Movies	33
■ To delete a single file	33
■ To delete all files	33
Snapshot Shooting Precautions	34
■ Auto Focus Restrictions	34

■ Recording Images 35

Selecting a Recording Mode	36
■ Digitally Correcting for Overexposure and Underexposure	(HDR) .. 37
■ Shooting Snapshots Digitally Processed for Artistic Effect	(HDR Art) .. 38
■ Shooting a Panorama Image	(Slide Panorama) .. 39
Using Flash	(Flash) .. 42
Shooting with Zoom	44
■ Interpreting the Zoom Bar	45
■ Zooming with Super Resolution	(Single SR Zoom) .. 46
To record a movie	47

■ Using BEST SHOT 49

Advanced Recording Settings

50

Using the REC Menu	50
■ Using Touch Shutter (Touch Shutter)	51
■ Shooting Snapshots of better Texture and Sharpness (Single SR Quality)	51
■ Zooming with Super Resolution (Single SR Zoom)	52
■ Using the Self-timer (Self-timer)	52
■ Changing the Image Size (Image Size)	53
■ Movie Image Quality Settings (Movie Quality)	54
■ Correcting Image Brightness (EV Shift)	55
■ Adjusting White Balance (White Balance)	56
■ Specifying ISO Sensitivity (ISO)	57
■ Optimizing Image Brightness (Lighting)	57
■ Selecting a Focus Mode (Focus)	58
■ Shooting with Continuous Auto Focus (Continuous AF)	60
■ Using the Auto Focus Assist Light (AF Assist Light)	60
■ Reducing the Effects of Camera and Subject Movement (Anti Shake)	61
■ Turning on Image Review (Review)	61

Viewing Snapshots and Movies

62

Viewing Snapshots	62
Viewing a Movie	62
■ Editing a Movie on the Camera (Movie Editing)	64
Viewing a Panorama Image	65
Playing a Slideshow on the Camera (Slideshow)	66
Viewing the Image Menu	66
Zooming an On-screen Image	67
Viewing Snapshots and Movies on a TV Screen	68

Other Playback Functions

(PLAY) 70

Using the PLAY Menu	70
■ Protecting a File Against Deletion (Protect)	71
■ Copying Files (Copy)	72
■ Using Red Eye Correction (Red Eye)	72
■ Cropping a Snapshot (Trimming)	73
■ Resizing a Snapshot (Resize)	74
■ Rotating an Image (Rotation)	74
■ Selecting Images for Printing (DPOF Printing)	75

Dynamic Photo

76

Inserting a Built-in Subject into a Snapshot or Movie (Dynamic Photo)	76
■ To view a Dynamic Photo (Dynamic Photo File)	78
Converting a Dynamic Photo Still Image to a Movie (Movie Converter)	78

■ Printing 79

Printing Snapshots.	79
Using DPOF to Specify Images to be Printed and the Number of Copies.	80

■ Using the Camera with a Computer 83

Things you can do using a computer...	83
Using the Camera with a Windows Computer	84
■ Viewing and Storing Images on a Computer.	85
■ Playing Movies	88
■ Uploading Movie Files to YouTube	89
■ Transferring Images from Your Computer to Camera Memory	90
■ Play back Dynamic Photo images on your EXILIM, a computer, on a mobile phone	92
■ Transforming Snapshots into Artistic Image	92
■ Viewing User Documentation (PDF Files)	94
■ User Registration	94
Using the Camera with a Macintosh	95
■ Connecting the Camera to Your Computer and Saving Files	95
■ Transferring Images Automatically and Managing Them on Your Macintosh	97
■ Playing a Movie.	98
■ Viewing User Documentation (PDF Files)	99
■ User Registration	99
Using an Eye-Fi Wireless SD Memory Card to Transfer Images . (Eye-Fi)	99
Files and Folders	101
Memory Card Data	101

■ Other Settings (Set Up) 103

Adjusting Monitor Screen Brightness (Screen)	103
Turning off Eye-Fi Card Communication (Eye-Fi)	103
Configuring Camera Sound Settings (Sounds)	104
Time Stamping Snapshots (Timestamp)	104
Configuring World Time Settings (World Time)	105
■ Setting a Travel Destination	105
■ Selecting the Time Display	106
Setting the Camera's Clock (Adjust)	106
Specifying the Date Style (Date Style)	107
Specifying the Display Language (Language)	107
Calibrating the Touch Panel (Calibrate TP)	108
Selecting the Screen Aspect Ratio and Video Output System (Video Out)	108
Formatting Built-in Memory or a Memory Card (Format)	109
Resetting the Camera to Factory Defaults (Reset)	109

■ Configuring Monitor Screen Settings 110

Selecting Display Information (DISP)	110
--	-----

Precautions during Use	111
Power Supply	119
■ Charging	119
■ To replace the battery	120
■ Battery Precautions	120
■ Using the Camera in another Country	121
Using a Memory Card	121
■ To replace the memory card	121
Computer System Requirements for Bundled Software (For Windows) ..	123
Reset Initial Default Settings	124
When things don't go right... ..	126
■ Troubleshooting	126
■ Display Messages	131
Number of Snapshots/Movie Recording Time	133
Specifications	134

General Guide

The numbers in parentheses indicate the pages where each item is explained.

Front

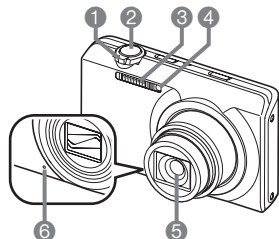

- ① Zoom controller
(pages 29, 44, 66, 67)
- ② Shutter button (page 29)
- ③ Flash (page 42)
- ④ Front lamp
(pages 27, 52, 60)
- ⑤ Lens
- ⑥ Microphone (page 48)

Back

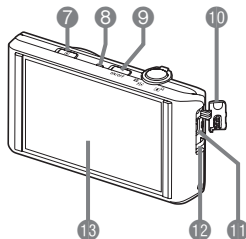

- ⑦ [▶] (PLAY) button
(pages 25, 32)
- ⑧ Back lamp
(pages 17, 19, 25, 29, 42)
- ⑨ [ON/OFF] (Power)
(pages 16, 21, 25)
- ⑩ Connector cover
- ⑪ [USB/AV] port
(pages 17, 18, 68, 85, 96)
- ⑫ Strap hole (page 2)
- ⑬ Monitor screen
(pages 9, 110)

Bottom

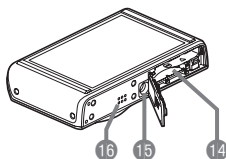

- ⑭ Battery/memory card slots (pages 15, 23, 120, 121)
- ⑮ Tripod hole
Use this hole when attaching to a tripod.
- ⑯ Speaker

Monitor Screen Contents

The monitor screen uses various indicators, icons, and values to keep you informed of the camera's status.

- The sample screens in this section are intended to show you the locations of all the indicators and figures that can appear on the monitor screen in various modes. They do not represent screens that actually appear on the camera.

■ Snapshot Recording

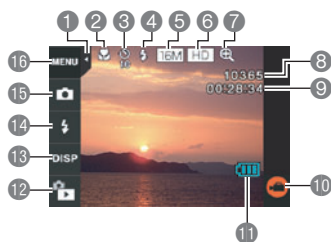

- 1 Tab (page 25)
- 2 Focus mode (page 58)
- 3 Self-timer mode (page 52)
- 4 Flash (page 42)
- 5 Snapshot image size (page 53)
- 6 Movie quality (pages 47, 54)
- 7 Digital zoom / Single SR Zoom (page 45)
- 8 Remaining snapshot memory capacity (page 133)
- 9 Remaining movie memory capacity (pages 47, 133)
- 10 "Movie" icon (pages 30, 47)
- 11 Battery level indicator (page 20)
- 12 PLAY mode icon (page 26)
- 13 Information icon (page 110)
- 14 Flash icon (page 42)
- 15 Recording mode icon (pages 28, 36)
- 16 Menu icon (page 50)

■ Movie Recording

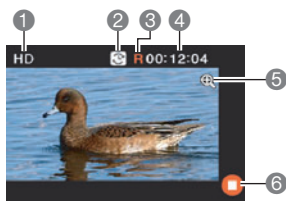

- 1 Movie quality (pages 47, 54)
- 2 Recording time switch icon (page 47)
- 3 Movie remaining time icon (page 47)
- 4 Remaining movie memory capacity / Movie recording time (pages 47, 133)
- 5 Digital zoom / Single SR Zoom (page 45)
- 6 "Movie stop" icon (pages 30, 47)

■ Snapshot Viewing



- 1 Tab (page 25)
- 2 Protect indicator (page 71)
- 3 Folder name/file name (page 101)
- 4 Snapshot image size (page 53)
- 5 Image menu icon (page 66)
- 6 Image scroll icons (pages 32, 62)
- 7 Battery level indicator (page 20)
- 8 Date/time (pages 21, 106)
- 9 REC mode icon (page 26)
- 10 Information icon (page 110)
- 11 Delete icon (page 33)
- 12 Slideshow icon (page 66)
- 13 Menu icon (page 70)

■ Movie Playback

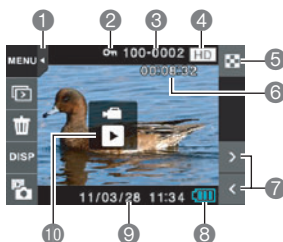

- 1 Tab (page 25)
- 2 Protect indicator (page 71)
- 3 Folder name/file name (page 101)
- 4 Movie quality (pages 47, 54)
- 5 Image menu icon (page 66)
- 6 Movie recording time (page 62)
- 7 Image scroll icons (pages 32, 62)
- 8 Battery level indicator (page 20)
- 9 Date/time (pages 21, 106)
- 10 "▶" Movie play icon (page 62)

Quick Start Basics

What is a digital camera?

A digital camera stores images on a memory card, so you can record and delete images a countless number of times.

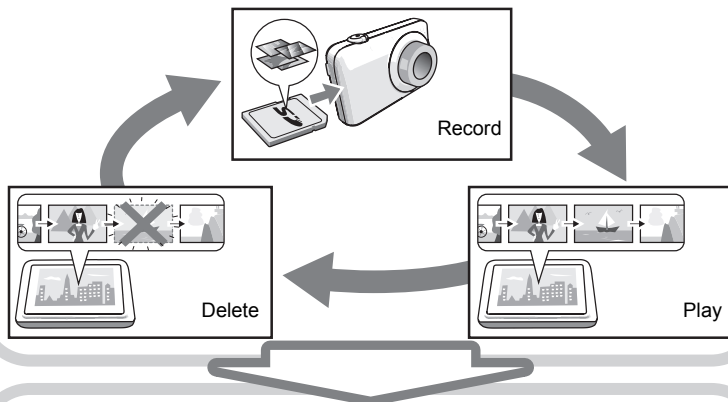

You can use the images you record in a variety of different ways.

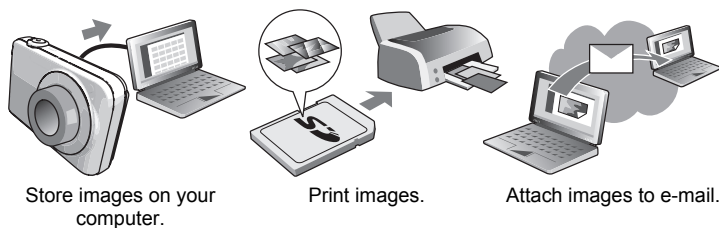

What you can do with your CASIO camera

Your CASIO camera is packed with a powerful selection of features and functions to make recording of digital images easier, including the following three main functions.

Simple touch panel operation

The monitor screen is a touch panel that can be used to perform operations.

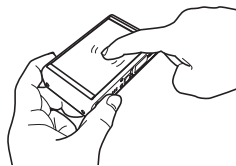

See page **13** for more information.

Premium Auto

Select Premium Auto recording and the camera automatically determines whether you are shooting a subject or scenery, and other conditions. Premium Auto delivers higher image quality than standard Auto.



See page **28** for more information.

HDR Art

An HDR Art feature combines different parts of a burst of images shot with different exposures into a final image and performs high-precision image analysis to produce final images that are true works of art.



See page **38** for more information.

Using the Touch Panel

The monitor screen of the camera is a touch panel. This means you can perform the following operations by touching the screen with your fingers.

Touch

Momentarily touching the screen with your finger. Touch the screen to select an icon or menu item, and to configure settings.

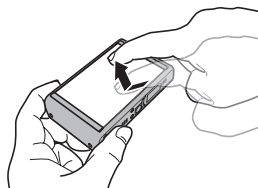

Touch-and-hold

Holding your finger against the screen. Touch and hold the screen to scroll images at high speed, or to perform continual frame-by-frame playback of a movie.



Drag

Holding your finger against the screen as you drag it up, down, left, or right. Use drag to move a screen image to a different location, and to scroll between images.

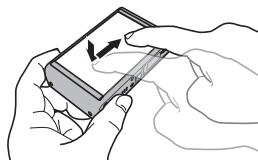

Spread

Holding your thumb and forefinger against the screen as you spread them out. Use spread to enlarge the screen image.



Squeeze

Holding your thumb and forefinger against the screen as you bring them together. Use squeeze to reduce the size of the screen image.

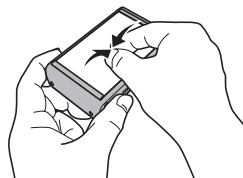

IMPORTANT!

- Never use a pointed or hard object to perform screen operations. Doing so can damage the screen.
- The touch panel is pressure-sensitive. Make sure you touch the panel with sufficient pressure when operating it.

NOTE

- Applying a commercially available LCD protective sheet will reduce the operation sensitivity of the monitor screen.
- If touch panel item selections are not performed as expected, calibrate the touch panel (page 108).

First, charge the battery prior to use.

Note that the battery of a newly purchased camera is not charged. Perform the steps below to load the battery into the camera and charge it.

- Your camera requires a special CASIO rechargeable lithium ion battery (NP-110) for power. Never try to use any other type of battery.

To load the battery

1. Open the battery cover.

Slide the battery cover slider towards OPEN and then open it as indicated by the arrows in the illustration.

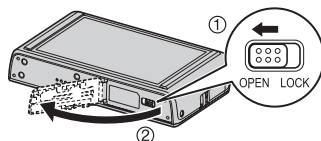

2. Load the battery.

With the EXILIM logo on the battery facing downwards (in the direction of the lens), hold the stopper next to the battery in the direction indicated by the arrow as you slide the battery into the camera. Press the battery in until the stopper secures it in place.

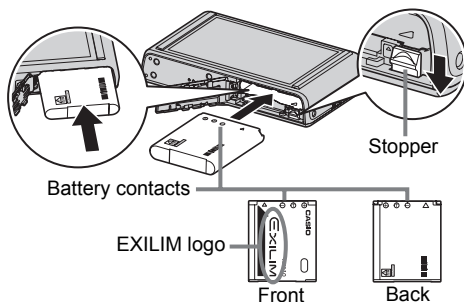

3. Close the battery cover.

Close the battery cover and then shift the slider towards LOCK.

- For information about how to replace the battery, see page 120.

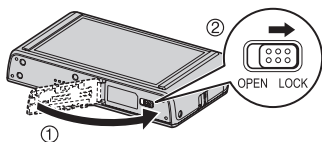

Charge the Battery

You can use either of the two following methods to charge the camera's battery.

- USB-AC adaptor
- USB connection to a computer

■ To charge with the USB-AC adaptor

1. Turn off the camera.

Check to make sure that the camera's monitor screen is blank. If it isn't, press [ON/OFF] (Power) to turn off the camera.

[ON/OFF] (Power)

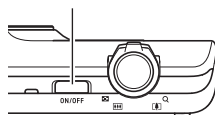

2. After connecting the supplied USB cable to the USB-AC adaptor, plug the adaptor into a household power outlet.

USB cable (included with camera)

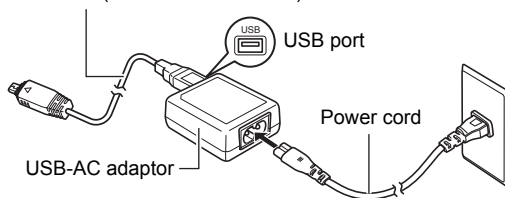

3. Connect the USB cable to the camera.

The back lamp should light red, indicating that charging has started. The back lamp will go out when charging is complete. It takes about 190 minutes to bring a fully dead battery to a full charge.

- A battery that has not been used for a long time, or ambient temperature extremes can cause charging to take longer than normal. If charging takes longer than about six hours, a timer will terminate it automatically, even if the battery is not fully charged. This is indicated by the back lamp flashing red. If the battery has not been used for a very long time, charging may be terminated automatically and the back lamp may start flashing red after only about 45 minutes. In either case, disconnect the USB cable from the camera and then reconnect it to resume charging.
- Note that even while the connector is fully inserted, you still will be able to see the metal part of the connector as shown in the illustration.

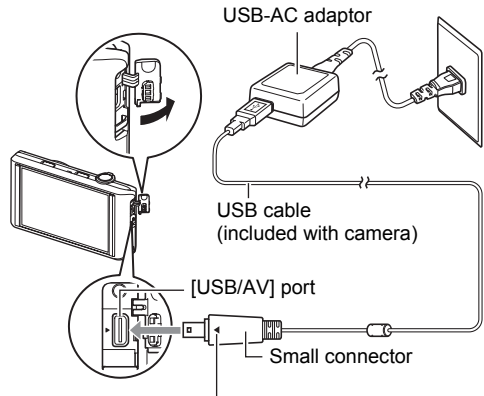

Making sure that the ► mark on the camera is aligned with the ◀ mark of the USB cable connector, connect the cable to the camera.

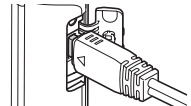

Back Lamp Operation

Lamp Status	Description
Lit Red	Charging
Flashing Red	Abnormal ambient temperature, USB-AC adaptor problem, battery problem, or charging terminated by timer (page 119)
Off	Charging complete

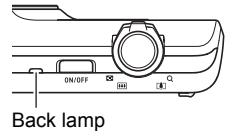

4. After charging is complete, disconnect the USB cable from the camera and then unplug the adaptor from the power outlet.

■ To charge using a USB connection to a computer

The battery loaded in the camera is charged whenever the camera is connected directly to a computer with the USB cable.

- Depending on the setup of your computer, you may not be able to charge the camera's battery over a USB connection. If this happens, use of the USB-AC adaptor that comes with the camera is recommended.

★ IMPORTANT!

- The first time you connect the camera to your computer with the USB cable, an error message may appear on your computer. If this happens, disconnect and then reconnect the USB cable.

1. Press [ON/OFF] (Power) to turn off the camera.

2. With your computer turned on, connect the camera to it.

The camera's back lamp will light red. After a short while, the camera will turn on automatically and the back lamp will light amber to indicate that charging has started. The back lamp will light green when charging is complete. Note, however, that some computer models or connection conditions can produce low supply capacity. If low supply capacity exists, charging will start without the camera turning on. This is indicated by the back lamp lighting red. The back lamp will go out in this case after charging is complete.

- It takes about 260 minutes to bring a fully dead battery to a full charge.

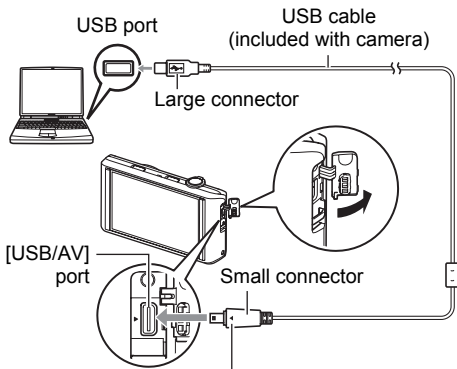

Making sure that the ► mark on the camera is aligned with the ◀ mark of the USB cable connector, connect the cable to the camera.

- A battery that has not been used for a long time, certain types of computers, and connection conditions can cause charging to take longer than normal. If charging takes longer than about six hours, a timer will terminate it automatically, even if the battery is not fully charged. If the battery has not been used for a very long time, charging may terminate automatically and the back lamp may start flashing red or go out after only about 30 minutes to 45 minutes. In either case, use of the USB-AC adaptor that comes with the camera is recommended.
- Note that even while the connector is fully inserted, you still will be able to see the metal part of the connector as shown in the illustration.

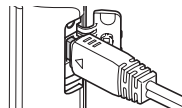

Back Lamp Operation

Lamp Status	Description
Lit Amber	Charging
Lit Red	Charging in progress (Data transfer with computer not supported.)
Flashing Red	Abnormal ambient temperature, battery problem, or charging terminated by timer (page 119)
Lit Green	Charging complete, or charging stopped

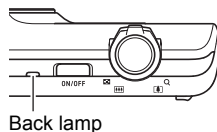

3. After charging is complete, disconnect the USB cable from the camera and then from the computer.

NOTE

- Charging continues while a camera is connected to a computer's USB port, even if the camera is turned off. Under this condition, the back lamp operates as described under "Back Lamp Operation" (page 17).

IMPORTANT!





- Charging is not performed while the connected computer is in the hibernate mode.
- A charging error can occur immediately after charging begins or some time after charging begins. A charging error is indicated by the back lamp flashing red.
- If low supply capacity exists due to your computer model or connection conditions, charging will start without the camera turning on. Turning on the camera in this case will cause charging to stop and enter USB data communication between the camera and the computer. The camera's back lamp will be lit green at this time.

Other Charging Precautions

- With the two charging methods described above, you can charge the camera's battery (NP-110) without removing it from the camera. You also can charge the battery using an optionally available charger unit (BC-110L). Never use any other type of charger device. Attempting to use a different charger can result in unexpected accident.
- A battery that is still warm immediately after normal use may not charge fully. Give the battery time to cool before charging it.
- A battery discharges slightly even when it is not loaded in the camera. Because of this, it is recommended that you charge the battery immediately before you need to use it.
- Charging the camera's battery may cause interference with TV and radio reception. If this happens, plug the USB-AC adaptor into an outlet that is further away from the TV or radio.
- Actual charging time depends on current battery capacity and charging conditions.
- Do not use the USB-AC adaptor with any other device.

Checking Remaining Battery Power

As battery power is consumed, a battery indicator on the monitor screen indicates remaining power as shown below.

Remaining Power	High ←————→ Low
Battery Indicator	 →  →  → 
Indicator Color	Cyan → Yellow → Red → Red

 indicates battery power is low. Charge the battery as soon as possible.

Recording is not possible when  is indicated. Charge the battery immediately.

- The level shown by the battery indicator may change when you switch between the REC mode and PLAY mode.
- Leaving the camera for about 30 days with no power supplied while the battery is dead will cause its date and time settings to be cleared. A message telling you to configure time and date settings will appear the next time you turn on the camera after restoring power. When this happens, configure date and time settings (page 106).
- See page 136 for information about battery life and number of shots.

Battery Power Conservation Tips

- When you do not need to use the flash, select  (Flash Off) for the flash setting (page 42).
- Select “Off” for “Continuous AF” (page 60).

Configuring Basic Settings the First Time You Turn On the Camera

The first time you turn on the camera, a screen appears for configuring the display language, date, and time settings. Failure to set the date and time correctly will cause the wrong date and time data to be recorded with images.

IMPORTANT!

- A screen for language selection will not appear in step 2 of the procedure below if you purchased a camera intended for the Japanese market. To change the display language from Japanese in this case, use the procedure under “Specifying the Display Language (Language)” (page 107). Note that a version of this manual in the language you select may not be included with a camera intended for the Japanese market.
- Camera models sold in certain geographic areas may not support display language selection.

1. Press [ON/OFF] (Power) to turn on the camera.

[ON/OFF] (Power)

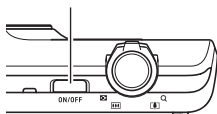

2. Drag (page 13) upwards and downwards until you find the language you want, and then touch to select it.

3. Touch the date display format you want.

Example: July 10, 2012
YY/MM/DD → 12/7/10
DD/MM/YY → 10/7/12
MM/DD/YY → 7/10/12

4. Touch the value you want to change (year, month, day, hour, minute).

5. Touch “▲” or “▼” to change the currently selected value.

- Touching and holding “▲” or “▼” will change the setting at high speed.
- To switch between 12-hour and 24-hour format, touch the 12/24 hour switch icon.

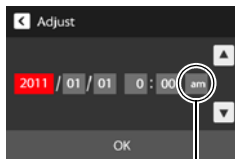

12/24 hour switch icon

6. When the date and time settings are the way you want, touch “OK”.

7. Touch “Auto” or “Premium Auto” to select the default auto recording mode you want.

8. Touch “Apply”.

- You will be able to change this setting later, if you want. See page 28 for details.

If you make a mistake configuring display language, date, or time settings with the above procedure, refer to the following pages for information about how to correct the settings.

- Display language: Page 107
- Date and time: Page 106

NOTE

- Each country controls its local time offset and the use of summer time, and so they are subject to change.
- Removing the battery from the camera too soon after configuring time and date settings for the first time can cause the settings to be reset to their factory defaults. Do not remove the battery for at least 24 hours after configuring settings.

Preparing a Memory Card

Though the camera has built-in memory that can be used to store images and movies, you probably will want to purchase a commercially available memory card for greater capacity. The camera does not come with a memory card. Images recorded while a memory card is loaded are saved to the memory card. When no memory card is loaded, images are saved to built-in memory.

- For information about memory card capacities, see page 133.

Supported Memory Cards

- SD Memory Card (Up to 2GB)
- SDHC Memory Card (2GB to 32GB)
- SDXC Memory Card (32GB to 2TB)



Use one of the above types of memory card.

- The above are supported memory card types as of March 2011.
- Noted memory card capacities are standard values.
- Use only SD cards that are compliant with the SD Card Association specification.
- This camera supports use of Eye-Fi cards.

To load a memory card

1. Press [ON/OFF] (Power) to turn off the camera and then open the battery cover.

Slide the battery cover slider towards OPEN and then open it as indicated by the arrows in the illustration.

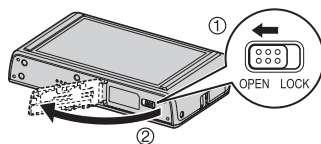

2. Load a memory card.

Positioning the memory card so its front is facing upwards (towards the monitor screen side of the camera), slide it into the card slot all the way in until you hear it click securely into place.

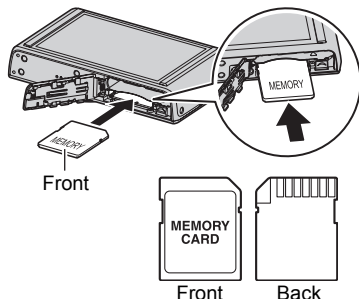

3. Close the battery cover.

Close the battery cover and then shift the slider towards LOCK.

- For information about how to replace the memory card, see page 121.

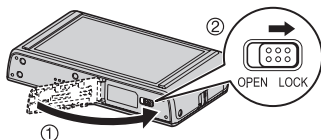

IMPORTANT!

- Never insert anything besides a supported memory card (page 23) into the memory card slot.
- Should water or any foreign object ever get into the card slot, immediately turn off the camera, remove the battery, and contact your retailer or nearest CASIO authorized service center.

To format (initialize) a new memory card

You need to format a new memory card before using it for the first time.

1. Load a memory card (page 23).

2. Turn on the camera and then touch “MENU”.

- If “MENU” is not displayed on the screen, touch the tab to display it (page 35).

3. Drag (page 13) upwards and downwards until you find “Setup”, and then touch it.

4. Drag upwards and downwards until you find “Format”, and then touch it.

5. Touch “Format” and then touch “Yes”.

This starts the memory card format operation.



IMPORTANT!

- Formatting a memory card that already has snapshots or other files on it, will delete its contents. Normally you do not need to format a memory card again. However, if storing to a card has slowed down or if you notice any other abnormality, re-format the card.
- Be sure to use the camera to format a memory card. Formatting a memory card on a computer and then using it in the camera can slow down data processing by the camera. In the case of an SD, SDHC, or SDXC memory card, formatting on a computer can result in non-conformity with the SD format, causing problems with compatibility, operation, etc.
- Before formatting a new Eye-Fi card to use it for the first time, copy the Eye-Fi Manager install files to your computer. Do this before formatting the card.
- Before formatting an Eye-Fi card, be sure to back up any data on it that you want to keep.

Turning Power On and Off

■ To turn on the camera

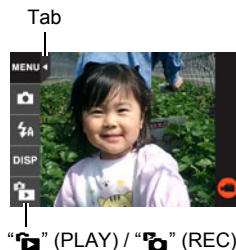
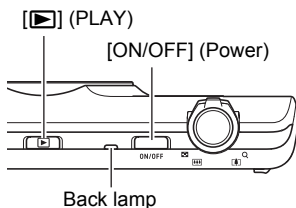

To turn on power and enter the REC mode	Press [ON/OFF] (Power). <ul style="list-style-type: none"> • The back lamp will light green momentarily and the lens will extend out of the camera (page 29).
To turn on power and enter the PLAY mode	Press [▶] (PLAY). <ul style="list-style-type: none"> • The back lamp will light green momentarily and an image currently stored in camera memory will appear on the monitor screen (page 32).

- Take care to ensure that nothing is restricting or coming into contact with the lens as it extends. Holding the lens with your hand so it cannot extend creates the risk of malfunction.

Entering the REC Mode and PLAY Mode

To enter the PLAY mode	In the REC mode, press [▶] (PLAY), or touch the tab and then touch the “▶” (PLAY) icon that appears.
To enter the REC mode	In the PLAY mode, press [▶] (PLAY), or touch the tab and then touch the “REC” (REC) icon that appears.

- About 10 seconds after you enter the PLAY mode from the REC mode, the lens will retract into the camera.

■ To turn off the camera

Press [ON/OFF] (Power).

■ Battery Power Conservation (Auto Power Off)

To conserve battery power, an Auto Power Off function turns off the camera if you do not perform any operation for about three minutes in the REC mode or for about five minutes in the PLAY mode.

- Auto Power Off is disabled under any of the following conditions.
 - While the camera is connected to a computer or other device
 - During a slideshow
 - During movie recording and playback

Holding the Camera Correctly

Your images will not come out clearly if you move the camera when you press the shutter button. When pressing the shutter button, be sure to hold the camera as shown in the illustration below, and keep it still by pressing your arms firmly against your sides as you shoot.

Holding the camera still, carefully press the shutter button and take care to avoid all movement as the shutter releases and for a few moments after it releases. This is especially important when available lighting is low, which slows down the shutter speed.

Horizontal

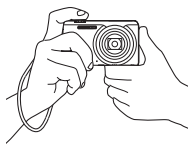

Vertical

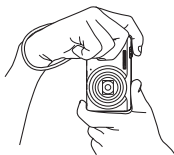

Hold the camera so the flash is above the lens.

NOTE

- Take care that your fingers and the strap do not cover any of the areas indicated in the illustration.
- To protect against accidentally dropping the camera, attach the wrist strap and make sure it is around your fingers or wrist while you are operating the camera.
- Never swing the camera around by its strap.
- The supplied strap is intended for use with this camera only. Never use it for any other purpose.

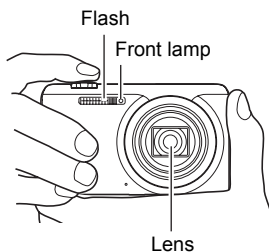

IMPORTANT!

- Take care to ensure that your fingers are not blocking or are not too close to the flash. Fingers can cause unwanted shadows when using the flash.

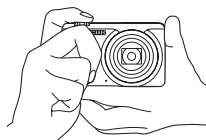



To Shoot a Snapshot

Your camera has a variety of different recording modes to suit various shooting conditions and objectives (page 36). This section explains general shooting procedures using the auto recording mode.

Selecting an Auto Recording Mode

You can select one of two auto recording modes (Auto or Premium Auto) according to your digital imaging needs.

 Auto	This is the standard Auto recording mode. <ul style="list-style-type: none">• It provides faster operation than Premium Auto recording.
 Premium Auto	With Premium Auto recording, the camera automatically determines whether you are shooting a subject or scenery, and other conditions. Premium Auto recording delivers higher image quality than standard Auto recording. <ul style="list-style-type: none">• Premium Auto recording takes longer to process image data after it is shot than Auto recording.• It also requires more power (and runs down the battery quicker) than Auto.

1. Press [ON/OFF] (Power) to turn on the camera.

2. Touch the second icon from the top (Recording mode).

If the icon is not displayed on the screen, touch the tab to display it.



Recording mode icon

3. Touch "Auto" or "Premium Auto" to select the auto recording mode you want.

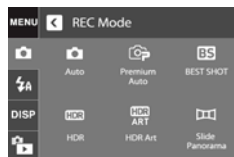

To shoot a snapshot

1. Point the camera at the subject.

If you are using Premium Auto, text will appear in the lower right corner of the monitor screen describing the type of shot the camera has detected.

- You can zoom the image, if you want.



Type of shot



Wide Angle



Telephoto

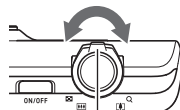

Zoom controller

2. Half-press the shutter button to focus the image.

When focus is complete, the camera will beep, the back lamp will light green, and the focus frame will turn green.

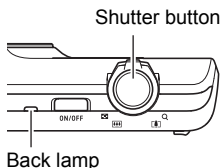

Back lamp

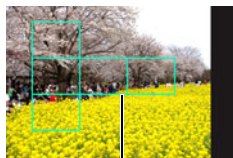

Focus frame

Half-press

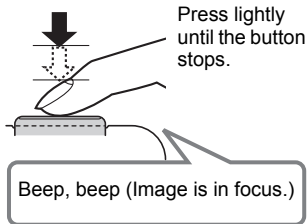

Press lightly until the button stops.

When you half-press the shutter button, the camera automatically adjusts exposure and focuses on the subject it is currently pointed at. Mastering how much pressure is required for a half-press and a full-press of the shutter button is an important technique for good-looking images.



3. Continuing to keep the camera still, press the shutter button the rest of the way down.

This records the snapshot.

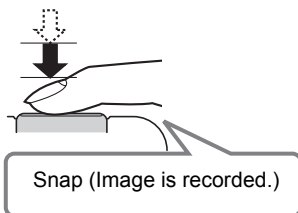
Full-press



Recording a Movie

Touch “” (Movie) to start movie recording. Touch “” (Movie Stop) to stop recording. See page 47 for details.



“” (Movie)/
“” (Movie Stop)

NOTE

- You also can shoot a snapshot by touching a point on the monitor screen (page 51).
- You can specify the image size for snapshots. See page 53 for more information.

■ If the image does not focus...

If the focus frame stays red and the back lamp is flashing green, it means that the image is not in focus (because the subject is too close, etc.). Re-point the camera at the subject and try to focus again.

■ Shooting with Auto

“Focus lock” (page 59) is the name of a technique you can use when you want to shoot an image in which the subject to be focused on is not within the focus frame in the center of the screen.

■ Shooting with Premium Auto

- In addition to shutter speed, aperture, and ISO sensitivity, the camera automatically executes the following operation as required when shooting with Premium Auto.
 - Auto Focus is normally performed until you half-press the shutter button.
 - The camera automatically determines the focus point on the screen and focuses there.
 - When shooting people, the face detection feature detects the faces of up to ten individuals and adjusts focus and brightness accordingly.
- Shooting with Premium Auto can cause vibration and noise to occur due to lens operation. This does not indicate malfunction.
- When shooting with Premium Auto, the message "Processing Premium Auto. Please wait..." may appear on the monitor screen. If you feel the camera is taking too long to process data, try shooting with standard Auto instead.
- In some cases, Premium Auto may not be able to interpret the shooting environment correctly. If this happens, shoot with standard Auto.

Viewing Snapshots

Use the following procedure to view snapshots on the camera's monitor screen.

- For information about how to play back movies, see page 62.

1. Press **[▶]** (PLAY) or touch **"▶"** (PLAY) to enter the PLAY mode.

This will display one of the snapshots currently stored in memory.

- If **"▶"** (PLAY) is not displayed on the screen, touch the tab to display it.
- Information about the displayed snapshot also is included (page 10).
- You also can clear the information to view only the snapshot (page 110).
- You can zoom the screen image by sliding the zoom controller towards **[⏏]** or by touching the monitor screen (page 67).

If you are recording a snapshot that is very important to you, it is recommended that you zoom the image and check its details after recording it.

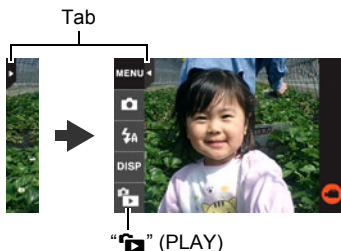
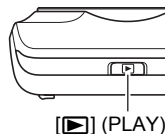

2. Touch **"<"** or **">"**, or drag left or right across the screen image to scroll through the snapshots.

- To scroll at high speed, touch and hold **"<"** or **">"**.



NOTE

- Pressing the shutter button while in the PLAY mode or while a menu screen is displayed will switch directly to the REC mode.

Deleting Snapshots and Movies

If memory becomes full, you can delete snapshots and movies you no longer need in order to free up storage and record more images.



IMPORTANT!

- Remember that a file (image) delete operation cannot be undone.

To delete a single file

1. In the **PLAY** mode, touch “<” or “>” to display the file you want to delete.

2. Touch “”.

- If “” is not displayed on the screen, touch the tab to display it.

3. Touch “1 File”.

This will delete the selected image.

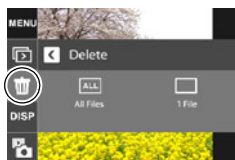

To delete all files

1. Enter the **PLAY** mode.

2. Touch “”.

- If “” is not displayed on the screen, touch the tab to display it.

3. Touch “All Files”.

4. Touch “Delete”.

This will cause the message “There are no files” to appear.

Snapshot Shooting Precautions

Operation

- Never open the battery cover while the back lamp is flashing green. Doing so can result in the image you just shot being saved incorrectly, damage to other images stored in memory, malfunction of the camera, etc.
- If unwanted light is shining directly onto the lens, shade the lens with your hand.

Monitor Screen when Shooting Snapshots

- Subject brightness conditions can cause monitor screen response to slow and can cause digital noise in the monitor screen image.
- The image that appears on the monitor screen is for image composition. The actual image will be recorded in accordance with the currently selected recording mode (page 36).

Shooting Indoors under Fluorescent Lighting

- Minute flickering of fluorescent lighting can affect the brightness or color of an image.

Auto Focus Restrictions

- Any of the following can make proper focus impossible.
 - Solid color wall or other very low contrast subject
 - Strongly back lit subject
 - Very shiny subject
 - Blinds or other subject with a repeating horizontal pattern
 - Multiple subjects at varying distances from the camera
 - Subject in a dark location
 - Subject that is too far away for light from the AF assist lamp to reach
 - Camera movement while shooting
 - Fast-moving subject
 - Subjects outside the focus range of the camera
- If you cannot focus properly, try using focus lock (page 59) or Manual Focus (page 58).

Recording Images

Touching the monitor screen in the REC mode will display a screen for configuring REC mode settings.

■ To configure REC mode settings

1. Press [ON/OFF] (Power) to turn on the camera and enter the REC mode.

- If the camera is in the PLAY mode, touch “” (REC) to enter the REC mode.

[ON/OFF] (Power)

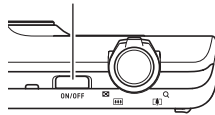

“” (REC)

2. Touch the item whose setting you want to change.

- If there are no icons along the left side of the screen, touch the tab to display them.

- 1 Tab (page 25)
- 2 Menu (page 50)*
- 3 Recording mode (page 36)
- 4 Flash (page 42)
- 5 Information (page 110)
- 6 PLAY mode (page 26)
- 7 Movie (page 47)



- * Depending on the recording mode, some of the items on the menu that appears may not be usable.

Selecting a Recording Mode

The camera has a variety of different recording modes.





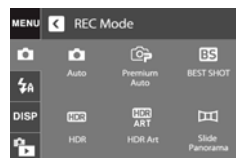

1. In the REC mode, touch the second icon from the top (Recording mode).

- If the icon is not displayed on the screen, touch the tab to display it.

2. Touch the icon of the recording mode you want to use.

This enters the selected recording mode.



 Auto	Standard Auto recording mode. This is the mode normally used for shooting (page 28).
 Premium Auto	With Premium Auto recording, the camera automatically determines whether you are shooting a subject or scenery, and other conditions. Premium Auto recording delivers higher image quality than standard Auto recording mode (page 28).
 BEST SHOT	With BEST SHOT, simply select the sample scene that resembles the type of shot you want, and the camera automatically configures ideal settings for the subject and shooting conditions (page 49).
 HDR	With HDR (High Dynamic Range), the camera shoots a series of CS images using different exposure settings and combines them into a final image to correct for overexposure or underexposure of subjects of different brightness levels (page 37).
 HDR Art	This mode digitally processes data to turn images you shoot into worlds of art (page 38).
 Slide Panorama	Simply move the camera as you record. The camera will shoot a series of images and then combine them into a sweeping panorama automatically.

Digitally Correcting for Overexposure and Underexposure (HDR)

With HDR (High Dynamic Range), the camera shoots a series of CS images using different exposure settings and combines them into a final image to correct for overexposure or underexposure of subjects of different brightness levels.

1. In the REC mode, touch the second icon from the top (Recording mode).

2. Touch “HDR” (HDR).

3. Press the shutter button to shoot.

- After you press the shutter button, the message “Busy... Please wait...” will appear on the monitor screen to indicate that recording is in progress. Keep the camera still while this message is displayed. The recording process takes some time to complete after the message appears. Image shooting is disabled while the message is displayed.
- When using this feature, image size is fixed at 3M (2048×1536 pixels).

NOTE

- Use of a tripod is recommended when shooting with this function.
- Shooting with this function causes the flash setting to change automatically to  (Flash Off).
- Shooting with this REC mode makes the shooting range narrower than normal.
- The desired HDR effect may not be attained if the camera or subject moves during shooting.
- Depending on shooting conditions and image composition, this REC mode may not be able to produce the desired result.
- Digital zoom is not supported while shooting with this function.

Shooting Snapshots Digitally Processed for Artistic Effect (HDR Art)

This feature applies HDR (High Dynamic Range, page 37) photography to transform snapshots into works of art that provide a greater degree of expression than conventional photography.



Normal image



HDR Art image

1. In the REC mode, touch the second icon from the top (Recording mode).

2. Touch “” (HDR Art).

3. Press the shutter button to shoot.

- After you press the shutter button, the message “Busy... Please wait...” will appear on the monitor screen to indicate that recording is in progress. Keep the camera still while this message is displayed. The recording process takes some time to complete after the message appears. Image shooting is disabled while the message is displayed.
- When using this feature, image size is fixed at 3M (2048×1536 pixels).

NOTE

- Use of a tripod is recommended when shooting with this function.
- Shooting with this function causes the flash setting to change automatically to  (Flash Off).
- Shooting with this REC mode makes the shooting range narrower than normal.
- The desired HDR Art effect may not be attained if the camera or subject moves during shooting.
- Depending on shooting conditions and image composition, this REC mode may not be able to produce the desired result.
- Digital zoom is not supported while shooting with this function.

■ Adjusting the Level of the Art Effect

You can specify one of three levels for application of the art effect.

1. For the recording mode, select “HDR Art”.

2. Touch “ART +2”.

3. Touch the level you want to select.

- 0 (off) - +3 (strong)

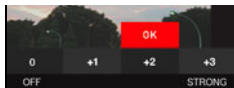

4. Touch “OK”.

|| Shooting a Panorama Image (Slide Panorama)

With Slide Panorama, you move the camera to compose and record multiple images, which are then combined to a panorama. This feature lets you shoot a panorama which is dramatically greater than the physical capabilities of the lens.

- The final panorama image can be one of the two sizes shown below.
Slide Direction is Right or Left: Maximum 5120×720 pixels
Slide Direction is Up or Down: Maximum 1280×4320 pixels
- Zoom operations are not supporting during Slide Panorama shooting. The zoom setting is fixed at full wide angle.
- You can shoot a panorama image for approximately 240 degrees horizontally, or approximately 180 degrees vertically.







1. In the REC mode, touch the second icon from the top (Recording mode).

2. Touch “” (Slide Panorama).

3. Touch the icon for the slide direction (the direction the camera will move while shooting).

You can select one of four different slide directions:

“” (right), “” (left), “” (up), “” (down).



4. Point the camera at the start of the panorama and half-press the shutter button to allow the camera to focus automatically.

5. Press the shutter button the rest of the way down and a slide cursor will appear on the monitor screen. Slowly move the camera in the direction indicated by the arrow on the screen until the slide cursor reaches the other end of its movement range (i.e. all the way to the right when moving the camera to the right).

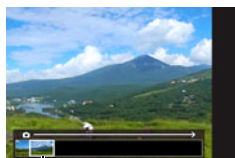

Slide cursor

- The camera will start composing the panorama image internally when the slide cursor reached the other end of the movement range.
- Image composing also will start automatically if you stop moving the camera during panorama shooting. After you stop moving the camera, the message “Busy... Please wait...” appears as the camera processes the image. Wait until this message disappears before using the camera. Image shooting is disabled while the message is displayed.

NOTE

- The following conditions are not compatible with Slide Panorama shooting.
 - Subject whose brightness is very different from that of its surroundings due to artificial light, sunlight, etc.
 - Rivers, waves, waterfalls, or other subject with constantly changing patterns
 - Sky, beach, or other subject with continuous patterns
 - Camera too close to the main subject
 - Moving subject
- Slide Panorama may stop part way through in the following cases.
 - Subject or camera movement
 - Camera movement that is too fast or too slow
- Shooting a Slide Panorama image after half-pressing the shutter button to perform Auto Focus may not produce the desired results if there are considerable differences in the brightness, color, and/or focus of the individual images. If this happens, try changing the focus position by focusing on a different subject, etc.
- Since a Slide Panorama image is created by joining multiple images together, there may be some roughness at the point where two images are joined.
- Shooting under a flickering light source (such as fluorescent lighting) may result in uneven brightness and/or coloring in the final Slide Panorama image.
- Shooting in dark surroundings may result in a blurred image or may make Slide Panorama shooting impossible.
- Slowly move the camera at a constant speed in the same direction as the arrow that appears on the monitor screen.
- When moving the camera, try to keep the arrow on the monitor screen as straight as possible.
- The exposure and white balance when shooting Slide Panorama images are fixed at the levels measured when you half-press the shutter button at the beginning of the operation.
- An error message will appear if the camera is unable to successfully record a series of images.
- If you shoot a moving subject, the camera may not be able to compose the panorama image properly.
- Shooting with this function causes the flash setting to change automatically to  (Flash Off).



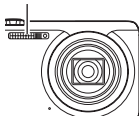

Using Flash (Flash)

1. In the REC mode, touch the third icon from the top (Flash).

Flash



2. Touch the icon of the flash mode you want to use.

 Auto	Flash fires automatically in accordance with exposure (amount of light and brightness) conditions.
 Flash Off	Flash does not fire.
 Flash On	Flash always fires. This setting can be used to brighten a subject that normally comes out dark due to daylight or backlight (daylight synchro flash).
 Red Eye	Flash fires automatically. This type of flash can be used to reduce the chance of redness in the subject's eyes.

3. Press the shutter button to shoot.

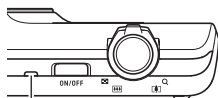

 indicates the flash will fire.



Back lamp

Flashes orange while the flash is charging to indicate that image recording is disabled.

- You will not be able to take another flash snapshot until the lamp stops flashing orange, which indicates that charging is complete.
- For information about Flash Range, see page 135.

NOTE

- Take care so your fingers and the strap do not block the flash.
- The desired effect may not be obtained when the subject is too far away or too close.
- Flash charging time (page 135) depends on operating conditions (battery condition, ambient temperature, etc.)
- Shooting with flash turned off when lighting is dim results in a slow shutter speed, which can cause image blur due to camera movement. Under such conditions, secure the camera with a tripod, etc.
- With red eye reduction, the flash is fired automatically in accordance with exposure. It does not fire in areas where lighting is bright.
- The presence of outdoor sunlight, fluorescent lighting, or some other light source can cause abnormal image colors.
- Select  (Flash Off) for the flash setting when shooting in areas where flash photograph is prohibited.

Red-eye Reduction

Using the flash to shoot at night or in a dimly lit room can cause red spots inside the eyes of people who are in the image. This is caused when the light from the flash reflects off of the retina of the eye. When red-eye reduction is selected as the flash mode, the camera fires a pre-flash to cause the irises in the eyes of any people in the image to close, which reduces the chance of red eye. This function also performs a process that corrects for red-eye after the image is recorded.

Note the following important points when using red-eye reduction.

- Red-eye reduction does not work unless the people in the image are looking directly at the camera (flash).
- Red-eye reduction may not work very well if the subjects are located far away from the camera.

Shooting with Zoom

Your camera is equipped with various types of zoom: optical zoom, HD Zoom, Single SR Zoom, and digital zoom. The maximum zoom factor depends on the image size setting.

Optical zoom	Changes the lens focal distance.
HD Zoom	Allows greater zoom capabilities by cutting out a portion of the original image and enlarging it.
Single SR Zoom	Applies super resolution technology to suppress image deterioration.
Digital zoom	Digitally processes the center of the image to enlarge it.

1. In the REC mode, slide the zoom controller to zoom.



 Wide Angle



 Telephoto

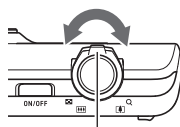

Zoom controller

 (Wide Angle): Reduces the size of the subject and broadens the range.

 (Telephoto) : Enlarges the subject and narrows the range.

2. Press the shutter button to shoot the image.

IMPORTANT!

- Digital zoom, HD zoom, and Single SR zoom are disabled while time stamping (page 104) is turned on.

NOTE

- Use of a tripod is recommended to protect against image blur due to camera movement when shooting with telephoto.
- Performing a zoom operation changes the lens aperture.

Interpreting the Zoom Bar

During a zoom operation, a zoom bar appears on the monitor screen to show the current zoom setting.

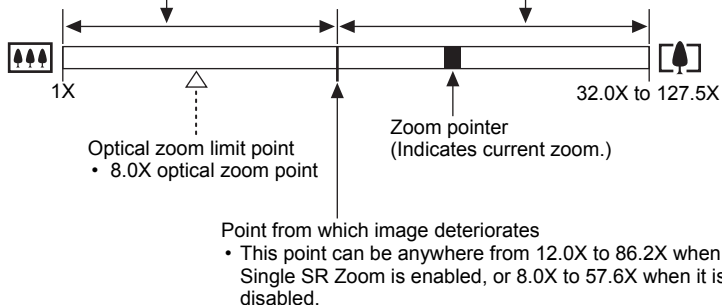

Range where image deterioration is suppressed
(optical zoom, HD Zoom, Single SR Zoom)

Deteriorated image range
(digital zoom)



Zoom Icon

The appearance of the zoom icon on the monitor screen depends on the zoom factor.

Optical zoom	Not displayed
HD Zoom	Not displayed
Single SR Zoom	
Digital zoom	

■ Zoom Factor

The digital zoom factor depends on the image size (page 53) and on whether Single SR Zoom is enabled or disabled.

Image size	Maximum zoom factor where image deterioration can be suppressed		Total maximum zoom factor
	Single SR Zoom: Off	Single SR Zoom: On	
16M	8.0X	12.0X	32.0X
3:2	8.0X	12.0X	32.0X
5M	14.4X	21.6X	57.6X
VGA	57.6X	86.2X	127.5X

Zooming with Super Resolution (Single SR Zoom)

Super resolution technology makes it possible to expand the zoom range in which image deterioration is minimized. For information about the effective zoom factor ranges in which Single SR Zoom is effective, see page 46.

1. In the REC mode, touch “MENU”.
2. Drag upwards and downwards until you find “Single SR Zoom”.
3. Touch “Single SR Zoom”.
4. Touch “On”.

NOTE

- Single SR Zoom is effective when you want to capture delicate textures.
- Single SR Zoom does not work during movie recording.
- The following functions are disabled when shooting with Single SR Zoom.
Some BEST SHOT scenes, HDR, HDR Art, Slide Panorama

To record a movie

The following procedure explains how to record a movie.

- You can record a movie while one of the following recording modes is selected.
 - Auto
 - Premium Auto
 - BEST SHOT

“MENU”

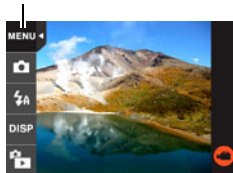

1. In the REC mode, touch “MENU”.

- If “MENU” is not displayed on the screen, touch the tab to display it.

2. Drag upwards and downwards until you find “Movie Quality”, and then touch to select it.



3. Touch the item whose setting you want to change.

Movie Quality	Frame Rate	Image Size (Pixels)	Description
HD	24fps	1280×720	Select this setting to record high-definition (HD) movies. The aspect ratio of movies recorded with this setting is 16:9.
STD	30fps	640×480	Select this setting to record standard movies.

4. To close the menu screen, touch “MENU” or press the shutter button.

5. Touch “” (Movie).

This will start recording.

- Monaural audio is also recorded during movie recording.
- Touching “” while recording is in progress will cause the remaining recording time and “R” to appear. Touch “” again to switch back to the elapsed recording time.

Recording time/
Remaining recording time

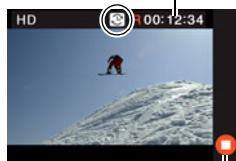

“” (Movie)/
“” (Movie Stop)

6. Touch “O” (Movie Stop) to stop recording.

- Each movie can be up to 29 minutes long. Movie recording stops automatically after 29 minutes of recording. Movie recording also will stop automatically if memory becomes full before you stop movie recording.

Minimizing the Effects of Camera Movement during Movie Recording

You can configure the camera to minimize the effects of camera movement during movie recording. Note, however, that this does not prevent image blur due to subject movement.

IMPORTANT!

- Spending a long time using movie recording will cause the camera to become slightly warm to the touch. This is normal and does not indicate malfunction.
- The camera also records audio. Note the following points when shooting a movie.
 - Take care that the microphone is not blocked by your fingers, etc.
 - Good audio recording results are not possible when the camera is too far away from what you are trying to record.
- Shooting a very bright subject can cause a vertical band or a pink cast on the monitor screen image. This does not indicate malfunction.
- Shooting a movie using the camera's built-in memory will cause movie frames to be dropped. Always use a high speed memory card (not built-in memory) for movie recording.
- Use of certain types of memory cards slows down data transfer and increases the time it takes to record movie data, which can result in movie frames being dropped. The movie icon turns yellow to indicate that frames are being dropped. In order to avoid problems such as these, use of an Ultra High Speed Type SD memory card is recommended. Note, however that CASIO makes no guarantees about the operation of any Ultra High Speed Type SD memory card used with this camera.

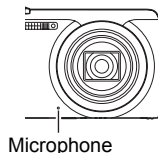

NOTE

- Single SR Zoom (page 44) is disabled during movie recording.
- The effects of camera movement in an image become more pronounced when you shoot close up or with a large zoom factor. Because of this, use of a tripod is recommended under these conditions.

Using BEST SHOT

BEST SHOT provides you with a collection of sample “scenes” that show a variety of different types of shooting conditions. When you need to change the setup of the camera, simply find the scene that matches what you are trying to achieve, and the camera sets up for it automatically. This helps to minimize the chance of ruined images due to poor exposure and shutter speed settings.

■ To shoot an image with BEST SHOT

1. In the REC mode, touch the second icon from the top (Recording mode).

- If the icon is not displayed on the screen, touch the tab to display it.

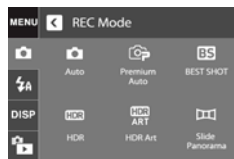

2. Touch “BS” (BEST SHOT).

This will display a menu of BEST SHOT scenes.

3. Touch the scene you want to select.

- Touching “i” in the upper right corner of the screen and then touching a BEST SHOT scene will display detailed information about the scene.

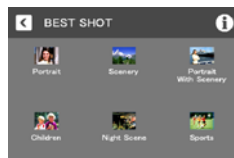

4. Press the shutter button (if you are shooting a snapshot) or touch “ⓘ” (Movie) (if you are shooting a movie).

■ BEST SHOT Precautions

- BEST SHOT scene images were not shot using this camera.
- Images shot using a BEST SHOT scene may not produce the results you expected due to shooting conditions and other factors.
- You can modify the camera settings that are configured after you select a BEST SHOT scene. Note, however, that the BEST SHOT settings revert to their defaults when you select another BEST SHOT scene or turn off the camera.
- Some scenes like Night Scene results in a slow shutter speed setting. Since a slow shutter speed increases the chance of digital noise in the image, the camera automatically performs a digital noise reduction process when either of these scenes is selected. This means that it will take a bit longer for the image to be saved which is indicated by the back lamp flashing green. Do not perform any key operation during that time. Also, it is a good idea to use a tripod to avoid image blur due to camera movement when shooting at slow shutter speeds.

Advanced Recording Settings

The following are menu operations you can use to configure various camera settings.

Using the REC Menu

■ Example Menu Screen Operation

1. In the REC mode, touch “MENU”.

This will display the menu screen.

- If “MENU” is not displayed on the screen, touch the tab to display it.
- Menu contents are different in the REC mode and PLAY mode.



2. Drag upwards and downwards until you find the item whose setting you want to change.

3. Touch the item.

4. Configure the setting of the item in accordance with the screen contents.

- To cancel and exit the menu, touch “MENU” or press the shutter button.

NOTE

- Switching from “Auto” to “Premium Auto” (page 28) will make some menu items unavailable.

■ Menu Operations in This Manual

Menu operations are represented in this manual as shown below. Touch the indicated icons and items, and perform operations as they are indicated, from left to right.

Procedure

Enter the REC Mode → MENU → Touch Shutter

Using Touch Shutter (Touch Shutter)

Procedure

Enter the REC Mode → MENU → Touch Shutter

You can use the procedure below to shoot a snapshot.

1. Touch “On”.

2. Point the camera at the subject.

3. When you want to shoot, touch the monitor screen.

The camera automatically comes into focus and then shoots.

- You can still use the shutter button to shoot even when “On” is selected for Touch Shutter.

NOTE

- When “Auto” is selected as the recording mode, the camera will automatically focus on the point you touch.
- When “Premium Auto” is selected as the recording mode, the camera will automatically determine the optimum focus point(s) and focus automatically.

Shooting Snapshots of better Texture and Sharpness (Single SR Quality)

Procedure

Enter the REC Mode → MENU → Single SR Quality

Super resolution technology is used to categorize an image into three parts: an outline part, a fine pattern part, and a flat part, and then perform the optimum process required by each part to increase texture and sharpness.

- Single SR Quality is effective when you want to capture delicate textures.
- A **SR** icon is displayed when the “Single SR Quality” setting is “On”.
- Single SR Quality is enabled for the entire zoom range, including digital zoom.
- It does not work during movie recording.
- The following functions are disabled when shooting with Single SR Quality.
Some BEST SHOT scenes, HDR, HDR Art, Slide Panorama

Zooming with Super Resolution (Single SR Zoom)

Procedure

Enter the REC Mode → MENU → Single SR Zoom

See page 46 for details.

Using the Self-timer (Self-timer)

Procedure

Enter the REC Mode → MENU → Self-timer

With the Self-timer, pressing the shutter button starts a timer. The shutter is released and the image is shot after a fixed amount of time.

10 sec	10-second Self-timer
2 sec	2-second Self-timer • When shooting under conditions that slow down the shutter speed, you can use this setting to prevent image blur due to camera movement.
Off	Self-timer is disabled.

- The front lamp flashes while the Self-timer countdown is in progress.
- You can interrupt an ongoing Self-timer countdown by pressing the shutter button.

Front lamp

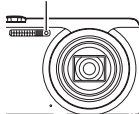

NOTE

- The Self-timer cannot be used together with Slide Panorama.

Changing the Image Size (Image Size)

Procedure

Enter the REC Mode → MENU → Image Size

This setting can be used to configure snapshot image size.

Image Size (Pixels)	Suggested Print Size and Application	Description
16M (4608×3456)	Poster Print	Good detail for better clarity even for images cropped from the original on a computer, etc.
3:2 (4608×3072)	Poster Print	
5M (2560×1920)	A4 Print	Good detail
VGA (640×480)	E Mail	Image files are smaller, which is better when attaching images to e-mail. However, images are relatively coarser.

- The initial factory default image size setting is 16M (16 million pixels).
- Selecting “3:2” records images with an aspect ratio of 3:2, which matches the standard aspect ratio of print paper.
- You should regard the print paper sizes suggested here as guidelines only (200 dpi print resolution).

■ Pixels

A digital camera image is a collection of small dots called “pixels”. The more pixels there are in an image, the more detail there will be. However, you generally can do with fewer pixels when printing an image (L size) through a print service, attaching an image to e-mail, when viewing the image on a computer, etc.

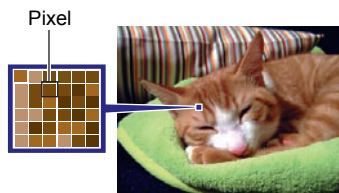

■ About image sizes

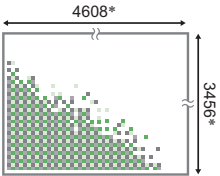
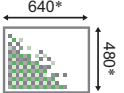

The size of an image indicates how many pixels it contains, and is expressed as horizontal pixels×vertical pixels.

16M (4608×3456) size image = Approximately 16 million pixels	
VGA (640×480) size image = Approximately 300,000 pixels	

* Unit: pixels

Image Size Selection Tips

Note that larger images have more pixels, so they take up more memory space.

Large Number of Pixels	More detail, but takes up more memory. Best when you plan to print large-size prints (such as Poster size).	
Small Number of Pixels	Less detail, but takes up less memory. Best when you want to send images by e-mail, etc.	

- For information about image size and number of images that can be stored, see page 133.
- For information about movie image size, see page 47.
- For information about resizing existing snapshots, see page 74.

Movie Image Quality Settings (Movie Quality)

Procedure

Enter the REC Mode → MENU → Movie Quality

See page 47 for details.

Correcting Image Brightness (EV Shift)

Procedure

Enter the REC Mode → MENU → EV Shift

You can manually adjust an image's exposure value (EV value) before shooting it.

- Exposure Compensation Range: -2.0 EV to +2.0 EV
- Unit: 1/3 EV

1. Touch a level you want to set.

- To cancel exposure compensation, change the EV value to 0.0.

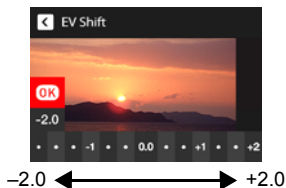

Decreases the EV value. A lower EV value is best for dark-color subjects and for shooting outdoors on a clear day.



Increases the EV value. A higher EV value is best for light-colored subjects and backlit subjects.

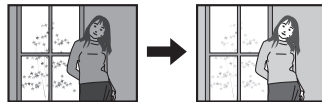

2. Touch "OK".

This applies the exposure compensation value. The exposure compensation value you set remains in effect until you change it or turn off the camera (which causes it to revert to "0.0").

NOTE

- When shooting under very dark or very bright conditions, you may not be able to obtain satisfactory results even after performing exposure compensation.

Adjusting White Balance (White Balance)









Procedure

Enter the REC Mode → MENU → White Balance

You can adjust white balance to match the source of light available where you are shooting and avoid the blue cast that results when shooting outdoors when it is cloudy, and the green cast that results when shooting under fluorescent lighting.

1. Touch the type of white balance you want to select.

You can see the affect of the white balance setting you select on the monitor screen.

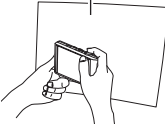
 Auto WB	Configures the camera to adjust white balance automatically
 Daylight	For shooting outdoors on a clear day
 Overcast	For shooting outdoors on an overcast rainy day, in the shade, etc.
 Shade	For shooting on a clear day in the shade of trees or buildings
 DayWhite Fluor	For shooting under white or day white fluorescent lighting
 Daylight Fluor	For shooting under daylight fluorescent lighting
 Tungsten	For shooting under light bulb lighting
 Manual WB	<p>For configuring the camera manually to suit a particular light source.</p> <ol style="list-style-type: none">① Touch " Manual WB".② In the location where you plan to shoot, point the camera at a blank white piece of paper so it fills the entire monitor screen.③ Touch an area of the screen where no icon is located. <p>The white balance setting is retained even if you turn off the camera.</p> 

- When " Auto WB" is selected for the white balance setting, the camera automatically determines the white point of the subject. Certain subject colors and light source conditions can cause problems when the camera tries to determine the white point, which makes proper white balance adjustment impossible. If this happens, select the white balance setting that matches your shooting conditions (Daylight, Overcast, etc.).

2. Touch "OK".

Specifying ISO Sensitivity (ISO)

Procedure

Enter the REC Mode → MENU → ISO

ISO sensitivity is a measure of sensitivity to light.

AUTO	Adjusts sensitivity automatically according to conditions		
ISO 80	Lower sensitivity	Slow shutter speed	Less noise
ISO 100	↑ ↓	↑ ↓	↑ ↓
ISO 200			
ISO 400			
ISO 800			
ISO 1600	Higher sensitivity	Fast shutter speed (Set for shooting in dimly lit areas.)	Some coarseness (increased digital noise)
ISO 3200			

- Higher ISO sensitivity values tend to result in digital noise in images.
- Since higher ISO sensitivity values tend to result in digital noise in images, the camera performs a noise filtering process. Because of this, it may take relatively longer for the camera to finish recording an image after it is shot. You will not be able to perform any operation while image recording is in progress.

Optimizing Image Brightness (Lighting)

Procedure

Enter the REC Mode → MENU → Lighting

You can use this setting to optimize the balance between bright areas and dark areas when shooting images.

Extra	Performs a higher level of brightness correction than the “On” setting. When this option is selected, it takes longer for the image to be stored after the shutter button is pressed.
On	Performs brightness correction.
Off	Does not perform brightness correction.

Selecting a Focus Mode (Focus)

Procedure

Enter the REC Mode → MENU → Focus

Changing to a different focus mode can help to achieve better focus.

Settings	Type of Shot	Focus Mode		Approximate Focus Range*1	
		Snapshot	Movies	Snapshot	Movies
AF (Auto Focus)	General recording	Automatic		Approximately 5 cm to ∞ (infinity) (2.0" to ∞) (Wide Angle)	
Macro	Close ups			Approximately 2 cm to 50 cm (0.8" to 19.7") (Seventh step zoom from the Widest Angle setting)	
Super Macro	Close ups			Approximately 2 cm to 50 cm (0.8" to 19.7")	
MF (Manual Focus)	When you want to focus manually	Manual		Approximately 5 cm to ∞ (infinity)*2 (2.0" to ∞) (Wide Angle)	

*1 The focus range is the distance from the lens surface.

*2 The minimum changes along with the optical zoom setting.

Super Macro

Super Macro fixes optical zoom at a position that allows you to shoot from the closest distance to the subject. The result is closer and larger subject images.

NOTE

- Zoom is fixed while Super Macro is selected, so no zoom operation is performed when you slide the zoom controller.

To focus with manual focus

1. On the monitor screen, compose the image so the subject you want to focus on is within the yellow boundary.

2. Touch “MF”.

3. Watching the image on the monitor screen, touch “+” (closer) or “-” (further) to adjust focus.

- At this time the image that is within the boundary will enlarge and fill the monitor screen, which aids in focusing. The camera will return to the screen in step 1 if you touch “□” or if you do not perform any operation for about three seconds.

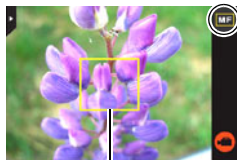

Yellow boundary

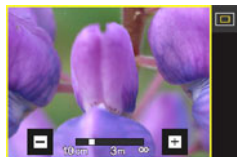

NOTE

- An Auto Macro feature detects how far the subject is from the lens and automatically selects either Macro Focus or Auto Focus accordingly.
- Use of the flash together with Macro Focus can cause the light of the flash to become blocked, which may result in unwanted lens shadows in your image.

Using Focus Lock

“Focus lock” is a technique you can use when you want to compose an image in which the subject you want to focus on is not within the focus frame in the center of the screen.

1. Align the monitor screen’s focus frame with the subject you want to focus on and then half-press the shutter button.

Subject to be focused on

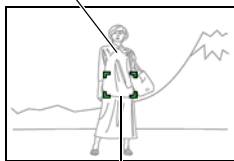

Focus frame

2. Keeping the shutter button half-pressed (which maintains the focus setting), move the camera to compose the image.



3. When you are ready to shoot the image, press the shutter button the rest of the way down.

NOTE

- Focus lock also locks exposure (AE).
- The focus frame does not appear on the display when the Touch Shutter is enabled (On).

Shooting with Continuous Auto Focus (Continuous AF)

Procedure

Enter the REC Mode → MENU → Continuous AF

When shooting a snapshot while “On” is selected for Continuous AF, Auto Focus is performed and focusing is continually updated until you half-press the shutter button.

- Before you half-press the shutter button, the camera focuses at the center of the screen.
- Shooting with Continuous AF can cause vibration and noise to occur due to lens operation. This does not indicate malfunction.

Using the Auto Focus Assist Light (AF Assist Light)

Procedure

Enter the REC Mode → MENU → AF Assist Light

Half-pressing the shutter button while this setting is selected causes the front lamp to light, which provides illumination for focusing in areas where lighting is dim. Leaving this function turned off is recommended when shooting portraits from short distances, etc.

Front lamp

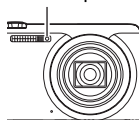

IMPORTANT!



- Never look directly into the front lamp while it is lit.

Reducing the Effects of Camera and Subject Movement (Anti Shake)

Procedure

Enter the REC Mode → MENU → Anti Shake

You can turn on the camera's Anti Shake feature to reduce image blur due to subject movement or camera movement when shooting a moving subject using telephoto, when shooting a fast-moving subject, or when shooting under dim lighting conditions. Your digital camera is equipped with a CCD shift type camera shake correction feature and a high-sensitivity anti image blur feature. These two features work in concert to minimize the effects of hand and subject movement.

 On	Minimizes the effects of hand and subject movement.
Off	Turns off Anti Shake settings
 DEMO	Half-pressing the shutter button demonstrates the effect of Anti Shake. However, the image is not recorded.

NOTE

- Only Camera Stabilizer can be used during movie recording.
- ISO sensitivity, aperture, and shutter speed do not appear on the monitor screen when you half-press the shutter button while "On" is selected. These values will appear briefly, however, in the preview image that is displayed immediately after you shoot a snapshot.
- Shooting while "On" is selected can cause an image to appear somewhat coarser than normal and can cause slight deterioration of image resolution.
- Anti Shake may not be able to eliminate the effects of camera or subject movement when movement is severe.
- Anti Shake may not work properly when the camera is mounted on a tripod. Turn off Anti Shake.

Turning on Image Review (Review)

Procedure

Enter the REC Mode → MENU → Review

While Review is turned on, the camera will display a image for about one second immediately after you press the shutter button to record it.

- Aperture, shutter speed, and ISO sensitivity values will be amber if Auto Exposure (AE) is incorrect.

Viewing Snapshots and Movies

Viewing Snapshots

See page 32 for the procedure for viewing snapshots.

Viewing a Movie

1. Press [▶] (PLAY) or touch “🎬” (PLAY) to enter the PLAY mode.

- If “🎬” (PLAY) is not displayed on the screen, touch the tab to display it.

2. Touch “<” or “>”, or drag left or right across the screen image to scroll through the movies until the one you want is displayed.

- To scroll at high speed, touch and hold “<” or “>”.

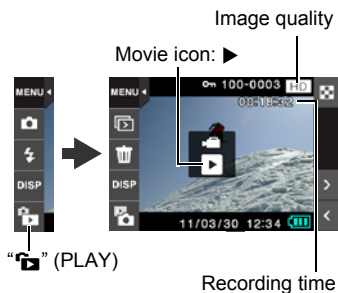

3. Touch “▶” (Movie) to start playback.

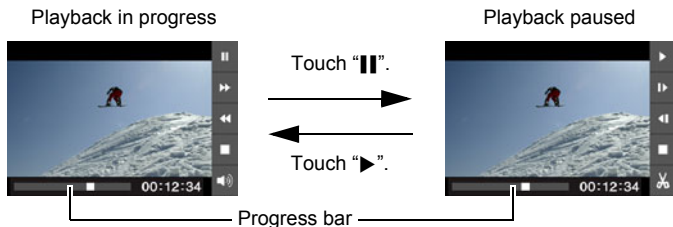

Movie Playback Controls



Pause/Play	Touch “ ” (pause) or “▶” (play).
Fast forward/ Fast reverse	During playback, touch “◀◀” (fast reverse) or “▶▶” (fast forward). <ul style="list-style-type: none">• Each touch of either button increases the speed of the fast forward or fast reverse operation.• To return to normal playback speed, touch “▶”.
Stop playback	During playback, touch “■”.
Volume adjustment	During playback, touch “🔊” and then drag the volume bar to the desired level. <ul style="list-style-type: none">• Volume can be adjusted only while movie playback is in progress.
1 frame forward/ back	While playback is paused, touch “▶ ” or “◀ ”. <ul style="list-style-type: none">• Touching and holding this icon advances frames continuously.
Information display on/off	Touch the screen.
Movie editing	Pause movie play at the location where you want to cut, and then touch “✂” (page 64).

- Playback may not be possible for movies not recorded with this camera.

Editing a Movie on the Camera (Movie Editing)

The Movie Editing feature lets you cut out a specific part of a movie.

1. Enter the **PLAY** mode and then start playback of the movie you want to edit.
2. When playback reaches the location where you want to cut, touch “||” to pause.
3. Touch “✂”.
4. Touch the option that specifies what you want to cut.

 Previous Cut	Cuts everything from the beginning of the movie up to the current location.
 Next Cut	Cuts everything from the current location to the end of the movie.

5. Touch “Cut”.

The selected cut operation will take considerable time to complete. Don't try to perform any camera operation until the “Busy... Please wait...” message disappears from the monitor screen. Note that a cut operation can take a long time if the movie being edited is long.

IMPORTANT!

- When you edit a movie, only the result is saved. The original movie is not retained. An editing operation cannot be undone.

NOTE

- A movie that is shorter than five seconds cannot be edited.
- Editing of movies recorded with a different type of camera is not supported.
- You will not be able to edit a movie if the amount of remaining memory capacity is less than the size of the movie file you want to edit. If there is not enough memory available, delete files you no longer need to free up more.
- Splitting of a movie into two movies and splicing of two different movies into a single movie are not supported.

Viewing a Panorama Image

1. Press [▶] (PLAY) or touch “▶” (PLAY) to enter the PLAY mode.

2. Touch “<” or “>” or drag upwards or downwards to display the panorama image you want to view.

- To scroll at high speed, touch and hold “<” or “>”.



3. Touch “▶” to play the panorama.

Panorama playback causes the image to scroll left, right, up, or down.

Playback Controls

Pause/Play	Touch “ ” (pause) or “▶” (play).
Stop playback	During playback, touch “■”.
Scroll the panorama image	While playback is paused, drag the screen.
Information display on/off	Touch the screen.

- The following functions cannot be performed on a panorama image.
Dynamic Photo, Movie Converter, Movie Editing, Trimming, Resize, Rotation

Playing a Slideshow on the Camera (Slideshow)

You can use the slideshow mode to automatically scroll through all of the images in camera memory.

1. In the PLAY mode, touch “ This will start the slideshow.

- If “



NOTE

- All operations are disabled while the slideshow is transitioning from one image to another.
- The time required for transition from one image to another may be longer in the case of an image that was not recorded with this camera.
- To return to normal (single image) display, touch the monitor screen.

Viewing the Image Menu

The image menu shows multiple images on a single screen.

1. In the PLAY mode, touch “ This displays the image menu.

- You also can display the image menu by sliding the zoom controller towards  (.
- Touch “.
- In the case of a movie, the first image in the movie is displayed.

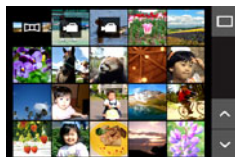

Zooming an On-screen Image

Snapshots can be zoomed on the monitor screen up to 8X.

- The actual available zoom factors depend on the size of the original image.

1. In the PLAY mode, touch “<” or “>” or drag left or right to display the image you want to view.

2. Spread your thumb and forefinger (page 13) on the displayed image to enlarge it.

- You can zoom an image by sliding the zoom controller towards [📏] (🔍).
- Dragging an enlarged screen image will change the part of the image that is displayed.
- Squeezing your thumb and forefinger (page 14) on the displayed image will reduce it in size.
 - When monitor screen contents are turned on, a graphic in the lower right corner of the screen shows what part of the zoomed image is currently displayed.
- Touching “<” or “>” while an enlarged image is displayed will scroll to the next sequential image while maintaining the current zoom factor.
- To return to normal (single image) display, touch “☐”.

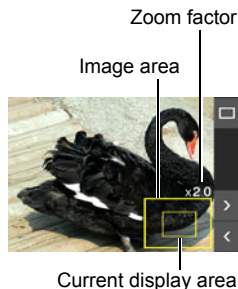

Viewing Snapshots and Movies on a TV Screen

1. Use the AV cable that comes with the camera to connect it to the TV.

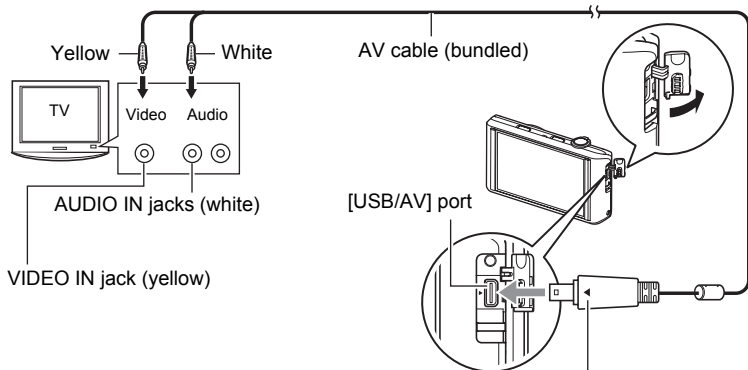

Making sure that the ► mark on the camera is aligned with the ◀ mark of the AV cable connector, connect the cable to the camera.

- Make sure that you insert the cable connector into the USB/AV port until you feel it click securely into place. Failure to insert the connector fully can result in poor communication or malfunction.
- Note that even while the connector is fully inserted, you still will be able to see the metal part of the connector as shown in the illustration.

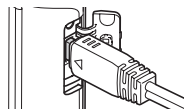

2. Turn on the TV and select its video input mode.

If the TV has more than one video input, select the one where the camera is connected.

3. Press [▶] (PLAY) to turn on the camera.

This will cause an image to appear on the TV screen.

- You also can change the aspect ratio of the screen and the video output system (page 108).
- The contents of the remote controller image will depend on the type of image that is displayed on the TV screen.

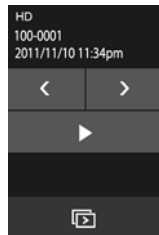

4. Touch the camera monitor screen to perform operations.

NOTE

- Audio is monaural.
- Audio is initially output by the camera at maximum volume. When you first start displaying images, set the TV volume control at a relatively low level and then adjust it as required.

Recording Camera Images to a DVD Recorder or Video Deck

Use one of the following methods to connect the camera to the recording device using the camera's bundled AV cable.

- DVD recorder or video deck: Connect to the VIDEO IN and AUDIO IN terminals.
- Camera: USB/AV port

You can play a slideshow of snapshots and movies on the camera and record it on a DVD or video tape.

For information about connecting a monitor to the recording device and about how to record, see the user documentation that comes with the recording device you are using.

Other Playback Functions (PLAY)

The following are menu operations you can use to configure various camera settings.

Using the PLAY Menu

■ Example Menu Screen Operation

1. In the PLAY mode, touch "MENU".

This will display the menu screen.

- If "MENU" is not displayed on the screen, touch the tab to display it.
- Menu contents are different in the REC mode and PLAY mode.

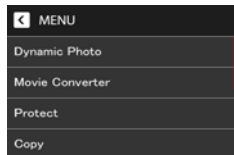

2. Touch the item whose setting you want to change.

3. Configure the setting of the item in accordance with the screen contents.

- To cancel and exit the menu, touch "MENU" or press the shutter button.

■ Menu Operations in This Manual

Menu operations are represented in this manual as shown below. Touch the indicated icons and items, and perform operations as they are indicated, from left to right.

Procedure

Enter the PLAY Mode → MENU → Protect

Protecting a File Against Deletion (Protect)

Procedure

Enter the **PLAY Mode** → **MENU** → **Protect**

You can protect images to prevent them from being deleted.

- A protected image will be indicated by "On".



All Files On	Protects all files.
All Files Off	Unprotects all files.
Select	<p>Protects and unprotects specific files.</p> <ol style="list-style-type: none">① Touch "∧" or "∨" or drag upwards or downwards to display the image you want to protect.② Touch an image to be protected, and "On" will appear on the image. You can repeat steps ① and ② as many times as necessary to select multiple images.③ Touch "OK". To unprotect an image, touch it in step ② of the above procedure to remove "On".

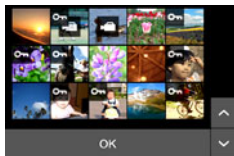

IMPORTANT!

- Note that even if a file is protected, it will be deleted if you perform the format operation (page 109).

Copying Files (Copy)

Procedure

Enter the PLAY Mode → MENU → Copy

Files can be copied from the camera's built-in memory to a memory card or from a memory card to built-in memory.

Built-in → Card	Copies all files from built-in camera memory to a memory card. This option copies all the files in built-in camera memory. It cannot be used to copy a single file.
Card → Built-in	Copies a single file on the memory card to camera built-in camera memory. Files are copied to the folder in built-in memory whose name has the largest serial number. ① Touch "<" or ">" or drag left or right to display the image you want to copy. ② Touch "Copy".

NOTE

- You can copy snapshots or movies, you recorded with this camera.

Using Red Eye Correction (Red Eye)

Procedure

Enter the PLAY Mode → MENU → Red Eye

Using the flash to shoot at night or in a dimly lit room can cause red spots inside the eyes of people who are in the image. This is caused when the light from the flash reflects off of the retina of the eye. Red eye correction corrects the eye colors of subjects to their normal colors when red eye occurs while using the flash.

Correct	Turns on red eye correction.
Cancel	Turns off red eye correction.

NOTE

- The original snapshot is retained in memory and not deleted.
- Red eye correction may not be possible in the case of small faces or profiles.
- Red eye correction may not produce the desired effect under certain conditions.

Cropping a Snapshot (Trimming)

Procedure

Enter the PLAY Mode → MENU → Trimming

You can crop a snapshot to trim parts you do not need, and save the result in a separate file. The original snapshot is also retained.

1. Touch “<” or “>” or drag left or right to display the image you want to crop.

2. Touch “OK”.

3. Drag the image until the part you want to keep is displayed.

- To enlarge the image, touch the screen with your thumb and forefinger and then spread them apart. To reduce the size of the image, touch the screen with your thumb and forefinger and then squeeze them together. You also can use the zoom controller to enlarge or reduce the image size.

4. Touch “OK”.

This will crop the image, leaving only the displayed part.

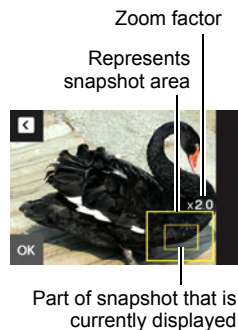

NOTE

- The image produced by cropping a 3:2 image will have an aspect ratio of 4:3.
- The recording date of the cropped image will be the same as the recording date of the original snapshot.

Resizing a Snapshot (Resize)

Procedure

Enter the **PLAY Mode** → **MENU** → **Resize**

You can reduce the size of a snapshot and save the result as a separate snapshot. The original snapshot is also retained. You can select resize an image to one of three image sizes: 5M, 3M, VGA.

1. Touch “<” or “>” or drag left or right to display the image you want to resize.

2. Touch a size.

This resizes the image to the selected size and saves the result as a new photograph.

NOTE

- Resizing a 3:2 size snapshot will create an image with an aspect ratio of 4:3, with both sides cut off.
- The recording date of the resized version of the snapshot will be the same as the recording date of the original snapshot.

Rotating an Image (Rotation)

Procedure

Enter the **PLAY Mode** → **MENU** → **Rotation**

1. Touch “<” or “>” or drag upwards or downwards to display the image you want to rotate.

2. Touch “Rotate”.

This will rotate the image 90 degrees to the left.

3. When the image is in the orientation you want, touch “.

NOTE

- Rotation of a panorama image is not supported.
- Note that this procedure does not actually change the image data. It simply alters how the image is displayed on the camera's monitor screen.
- An image that has been protected or zoomed cannot be rotated.

Selecting Images for Printing (DPOF Printing)

Procedure

Enter the **PLAY Mode** → **MENU** → **DPOF Printing**

See page 80 for details.

Dynamic Photo

This camera comes with a number of subjects in built-in memory ("built-in subjects"), which you can insert into snapshots and movies to create Dynamic Photo images.

- The term "built-in subjects" refers to the moving figures and characters that came pre-programmed in the camera's built-in memory.



Dynamic Photo™



Inserting a Built-in Subject into a Snapshot or Movie (Dynamic Photo)

Use the following procedure to insert a built-in subject image into a snapshot (except for a panorama image) or movie.

1. Enter the **PLAY** mode.

2. Touch "**MENU**".

- If "MENU" is not displayed on the screen, touch the tab to display it.

3. Touch "**Dynamic Photo**".

4. Touch "**<**" or "**>**" or drag left or right to select the background image, and then touch "**OK**".

- Only an image that satisfies the following conditions can be used as a background image.
 - A snapshot or movie recorded with this camera or a snapshot transferred to this camera's memory using Photo Transport (page 90)
 - A snapshot with an aspect ratio of 4:3

5. Touch "**<**" or "**>**" or drag left or right to select the built-in subject sample you want to insert, and then touch "**OK**".

- If you are inserting a subject into a snapshot, go directly to step 8.

6. If you are inserting a subject into a movie, use “◀” and “▶” to configure the time zone in the movie where you want the subject to appear.

- If you insert a subject into a movie, the resulting movie will be a maximum of 20 seconds long. Everything before and after the insertion is cut off. If the movie you are inserting into (original movie) is shorter than 20 seconds, the resulting movie will be the same length as the original movie.

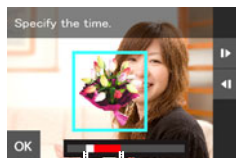

Insert location

7. Touch “OK”.

8. Use the zoom controller to adjust the size of the subject and drag the subject to change its location on the screen.



9. After the subject’s size and position are the way you want, touch “OK”.

The subject is merged with the background image to create a Dynamic Photo.

- Inserting an animated subject into a snapshot will save a Dynamic Photo that consists of 20 still images of 2M size or smaller.
- Inserting a subject into a movie will save the Dynamic Photo as a movie file.

NOTE

- Performing a delete or format operation will not delete the built-in subjects.

To view a Dynamic Photo (Dynamic Photo File)

- 1. Enter the PLAY mode.**
- 2. Drag left or right to display the Dynamic Photo you want to play back.**
- 3. Touch “▶” (PLAY).**

The Dynamic Photo is repeated as a continuous loop.

 - Movement of the subject also will start automatically about two seconds after you display a Dynamic Photo.

Converting a Dynamic Photo Still Image to a Movie (Movie Converter)

A Dynamic Photo with a still image background and a moving subject is stored as a series of 20 still images. You can use the following procedure to convert the 20 images that make up a Dynamic Photo to a movie.

- 1. Enter the PLAY mode.**
- 2. Drag left or right to display the Dynamic Photo you want to convert to a movie.**
- 3. Touch “MENU”.**
- 4. Touch “Movie Converter”.**
 - The final movie format is Motion JPEG.
 - The final movie image size is 640×480 pixels.

Printing

Printing Snapshots

Professional Print Service

You can take a memory card that contains the images you want to print to a professional print service and have them printed.



Printing on a Home Printer

Printing Images on a Printer with Memory Card Slot

You can use a printer equipped with a memory card slot to print images directly from a memory card. For details, see the user documentation that comes with your printer.



Printing with a Computer

After transferring the images to your computer, use commercially available software to print.

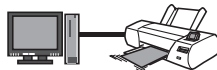

- You can specify which images you want to print, the number of copies, and date stamp settings before printing (page 80).

Using DPOF to Specify Images to be Printed and the Number of Copies

■ Digital Print Order Format (DPOF)

DPOF is a standard that allows you to include image type, number of copy, and time stamp on/off information on the memory card with the images. After configuring settings, you can use the memory card to print on a home printer that supports DPOF or take the memory card to a professional print service.



- Whether or not you will be able to use DPOF settings for printing depends on the printer you are using.
- Some professional print services may not support DPOF.

■ Configuring DPOF Settings Individually for Each Image

Procedure

MENU → Setup → DPOF Printing → Select images

1. Touch “<” or “>” or drag left or right to display the image you want to print.

2. Touch the number of copies value.

3. Touch “<” or “>” to specify the number of copies.

You can specify a value up to 99. Specify 0 if you do not want to print the image.

4. Touch “OK”.

- Touch “DATE” to toggle it between “ON” (date printed) and “OFF” (date not printed). Switching from “OFF” to “ON” automatically changes the number of copies value to 1.
- The images that will be printed are marked with a check mark (✓).
- Repeat steps from 1 to 4 to configure settings for other images, if you want.

5. Touch “OK”.

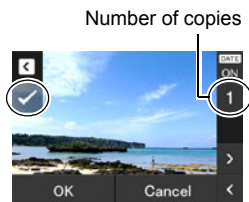

■ Configuring the Same DPOF Settings for All the Images

Procedure

MENU → Setup → DPOF Printing → All images

1. Touch “Date stamping”.

2. Touch “On” to turn date stamping on or “Off” to turn it off.

- Switching from “Off” to “On” automatically changes the number of copies value to 1.
-

3. Touch “<” or “>” to specify the number of prints.

You can specify a value up to 99. Specify 0 if you do not want to print the image.

4. Touch “OK”.

DPOF settings are not cleared automatically after printing is complete.

The next DPOF print operation you execute will be performed using the last DPOF settings you configured for the images. To clear DPOF settings, specify “0” for the number of copies of all images.

Tell your print service about your DPOF settings!

If you take a memory card to a professional print service, be sure to tell them that it includes DPOF settings for the images to be printed and the number of copies. If you don't, the print service may print all the images without regard to your DPOF settings, or they may ignore your date stamp setting.

■ Date Stamping

You can use one of the following three methods to include the recording date in the printout of an image.

Configuring camera settings
Configure DPOF settings (page 80). You can turn date stamping on and off each time you print. You can configure settings so some images include the date stamp and some don't.
Configure the Camera's Time Stamp setting (page 104). <ul style="list-style-type: none">• The camera's Time Stamp setting imprints the date into a snapshot when you shoot it, so the date is always included when you print. It cannot be deleted.• Do not turn on DPOF date stamping for an image that includes a date stamped with the camera's Time Stamp function. Doing so can cause the two stamps to be overprinted.
Configuring computer settings
You can use commercially available image management software to date stamp images.
Professional print service
Request date stamping when ordering prints from a professional print service.

■ Standards Supported by the Camera

- PRINT Image Matching III

Using image editing software and printing on a printer that supports PRINT Image Matching III makes it possible to use information about shooting conditions that is recorded with the image, and produce exactly the type of image you want. PRINT Image Matching and PRINT Image Matching III are trademarks of Seiko Epson Corporation.



- Exif Print





Printing on a printer that supports Exif Print uses information about shooting conditions recorded with the image to enhance printed image quality. Contact your printer manufacturer for information about models that support Exif Print, printer upgrades, etc.



Using the Camera with a Computer

Things you can do using a computer...

You can perform the operations described below while the camera is connected to a computer.

Save images to a computer and view them there 	<ul style="list-style-type: none">• Save images and view them manually (USB connection) (pages 85, 95).• Transfer images to a computer automatically over a wireless LAN for viewing (Eye-Fi) (page 99).
Transfer images stored on your computer to camera memory 	In addition to images, you also can transfer screen shot images from your computer to the camera (Photo Transport*) (page 90).
Play back and edit movies 	<ul style="list-style-type: none">• You can play back movies (pages 88, 98).• To edit movies, use commercially available software as required.
Transform snapshots into artistic images 	Transform your snapshots into images that look like they were painted (Virtual Painter 5 LE for CASIO*) (page 92).
Play back and edit Dynamic Photo images on your EXILIM, a computer, or on a mobile phone 	<ul style="list-style-type: none">• You can copy moving subjects (animated characters) from your computer to the EXILIM.• You can convert Dynamic Photo images to movies and send them to a mobile phone for playback (Requires Dynamic Photo Manager*) (page 92).

* Windows only

The procedures you need to perform when using the camera with your computer and when using the bundled software are different for Windows and the Macintosh.

- Windows users should refer to "Using the Camera with a Windows Computer" on page 84.
- Macintosh users should refer to "Using the Camera with a Macintosh" on page 95.

Using the Camera with a Windows Computer

Install the required software in accordance with the version of Windows you are running and what you want to do.

When you want to do this:	Operating System Version	Install this software:	See page:
Save images to a computer and view them there manually	Windows 7, Windows Vista, Windows XP (SP3)	Installation not required.	85
Play movies	Windows 7, Windows Vista, Windows XP (SP3)	Installation not required. • Windows Media Player, which is already installed on most computers, can be used for playback.	88
Edit movies	Windows 7, Windows Vista, Windows XP (SP3)	– • Use commercial software as required.	–
Upload movie files to YouTube	Windows 7, Windows Vista, Windows XP (SP3)	YouTube Uploader for CASIO*	89
Transfer images to the camera	Windows 7, Windows Vista, Windows XP (SP3)	Photo Transport 1.0*	90
Transform snapshots into artistic images	Windows 7, Windows Vista, Windows XP (SP3)	Virtual Painter 5 LE for CASIO*	92
Play back, copy, and edit Dynamic Photo moving subjects (animated characters)	Windows 7, Windows Vista (SP1), Windows XP (SP3)	Dynamic Photo Manager*	92
View the User's Guide	Windows 7, Windows Vista, Windows XP (SP2, SP3), Windows 2000 (SP4)	Adobe Reader 9 (Not required if already installed.)	94

* YouTube Uploader for CASIO, Photo Transport, Virtual Painter 5 LE for CASIO, and Dynamic Photo Manager will not run under 64-bit versions of Windows OS.

■ Computer System Requirements for Bundled Software

Computer system requirements are different for each of the applications. See the "Read me" file that comes with each application for details. Information about computer system requirements also can be found under "Computer System Requirements for Bundled Software (For Windows)" on page 123 of this manual.

■ Precautions for Windows Users

- Except for Adobe Reader, the bundled software requires Administrator privileges to run.
- Operation on a self-made computer is not supported.
- Operation may not be possible under certain computer environments.

Viewing and Storing Images on a Computer

You can connect the camera to your computer in order to view and store images (snapshot and movie files).

NOTE

- You also can use your computer's card slot (if it has one) or a commercially available card reader to access image files directly from the camera's memory card. For details, see the user documentation that comes with your computer.

■ To connect the camera to your computer and save files

1. Press [ON/OFF] (Power) to turn off the camera.

2. Use the USB cable that comes with the camera to connect it to your computer.

The camera will turn on automatically and battery charging will start (page 18).

- The camera may not turn on automatically in the case of certain computer models or connection conditions. If this happens, press [ON/OFF] (Power) to turn on the camera.
- Make sure that you insert the cable connector into the USB port until you feel it click securely into place. Failure to insert the connector fully can result in poor communication or malfunction.

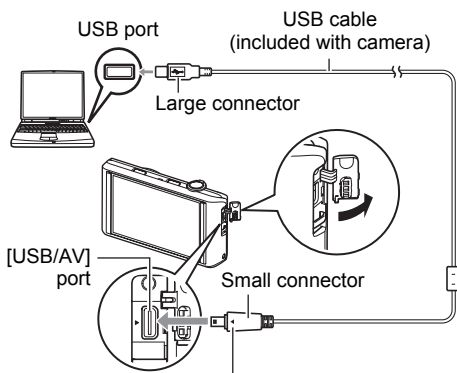

Making sure that the ► mark on the camera is aligned with the ◀ mark of the USB cable connector, connect the cable to the camera.

- Note that even while the connector is fully inserted, you still will be able to see the metal part of the connector as shown in the illustration.
- When connecting the USB cable to a USB port, make sure you align the connector correctly with the port.
- Your computer may not be able to recognize the camera if you connect via a USB hub. Always connect directly to the computer's USB port.
- The first time you connect the camera to your computer with the USB cable, an error message may appear on your computer. If this happens, disconnect and then reconnect the USB cable.

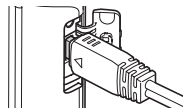

**3. Windows 7, Windows Vista users: Click “Start” and then “Computer”.
Windows XP users: Click “Start” and then “My Computer”.**

4. Double-click “Removable Disk”.

- Your computer recognizes the memory card loaded in the camera (or built-in memory if there is no card) as a removable disk.

5. Right-click the “DCIM” folder.

6. On the shortcut menu that appears, click “Copy”.

**7. Windows 7, Windows Vista users: Click “Start” and then “Documents”.
Windows XP users: Click “Start” and then “My Documents”.**

- If you already have a “DCIM” folder in “Documents” (Windows 7, Windows Vista) or “My Documents” (Windows XP), the next step will overwrite it. If you want to keep the existing “DCIM” folder, you need to change its name or move it to a different location before performing the next step.

8. Windows 7 users: On the “Documents” “Organize” menu, select “Paste”.

Windows Vista users: On the “Documents” “Edit” menu, select “Paste”.

Windows XP users: On the “My Documents” “Edit” menu, select “Paste”.

This will paste the “DCIM” folder (and all the image files it contains) into your “Documents” (Windows 7, Windows Vista) or “My Documents” (Windows XP) folder. You now have a copy of the files that are in camera memory on your computer.

9. After you finish copying images, disconnect the camera from the computer.

■ To view images you copied to your computer

1. Double-click the copied “DCIM” folder to open it.

2. Double-click the folder that contains the images you want to view.

3. Double-click the image file you want to view.

- For information about file names, see “Memory Folder Structure” on page 102.
- An image that was rotated on the camera will be displayed on your computer screen in its original (unrotated) orientation.

Never use your computer to modify, delete, move, or rename any image files that are in the camera's built-in memory or on its memory card.

Doing so can cause problems with the camera's image management data, which will make it impossible to play back images on the camera and can drastically alter remaining memory capacity. Whenever you want to modify, delete, move, or rename an image, do so only on images that are stored on your computer.



IMPORTANT!

- Never unplug the USB cable, or operate the camera while viewing or storing images. Doing so can cause data to become corrupted.

Playing Movies

Windows Media Player, which is already installed on most computers, can be used for movie playback. To play back a movie, first copy the movie to your computer and then double-click the movie file.

■ Minimum Computer System Requirements for Movie Playback

The minimum system requirements described below are necessary to play back movies recorded with this camera on a computer.

Operating System : Windows 7, Windows Vista, Windows XP (SP3)

CPU : Image Quality "HD":

Pentium 4 3.2 GHz or higher

Image Quality "STD":

Pentium M 1.0 GHz or higher

Pentium 4 2.0 GHz or higher

Required Software: Windows Media Player, DirectX 9.0c or higher

- The above are recommended system environments. Configuring one of these environments does not guarantee proper operation.
- Certain settings and other installed software may interfere with proper playback of movies.

■ Movie Playback Precautions

- Be sure to move the movie data to the hard disk of your computer before trying to play it. Proper movie playback may not be possible for data accessed over a network, from a memory card, etc.
- Proper movie playback may not be possible on some computers. If you experience problems, try the following.
 - Try recording movies with a quality setting of "STD".
 - Try upgrading Windows Media Player to the latest version.
 - Quit any other applications you have running, and stop resident applications.

Even if proper playback is not possible on the computer, you can use the AV cable that comes bundled with the camera to connect to the video input terminal of a TV or computer and play back movies that way.

Uploading Movie Files to YouTube

Installing YouTube Uploader for CASIO from the CD-ROM that comes with your camera simplifies uploading of movie files you recorded.

■ What is YouTube?

YouTube is a movie sharing site managed by YouTube, LLC where you can upload movies and view movies uploaded by others.

■ To install YouTube Uploader for CASIO

1. On the CD-ROM menu screen, select “YouTube Uploader for CASIO”.

2. After reading the information about installation conditions and system requirements for installation in the “Read me” file, install YouTube Uploader for CASIO.

■ To upload a movie file to YouTube

- Before you can use YouTube Uploader for CASIO, you need to go to the YouTube website (<http://www.youtube.com/>) and register as a user there.
- Do not upload any video that is copyrighted (including neighboring copyrights) unless you yourself own the copyright or you have obtained the permission of the applicable copyright holder(s).
- The maximum file size for each upload is 2048MB or a recording time of up to 15 minutes.

1. Record a movie (page 47).

2. If it isn't already, connect your computer to the Internet.

3. Connect the camera to your computer (page 85).

The camera will turn on automatically and battery charging will start (page 18). YouTube Uploader for CASIO will start up automatically.

- If this is the first time you are using the application, configure the YouTube user ID and network environment settings, and then click the [OK] button.
-

4. The left side of the display will have an area for inputting a title, category, and other information required for uploading to YouTube. Enter the required information.

5. The right side of the display shows a list of movie files in camera memory. Select the check box next to the movie file you want to upload.

6. When everything is ready, click the [Upload] button.

This will upload the movie file(s) to YouTube.

- After uploading is complete, click the [Exit] button to exit the application.

Transferring Images from Your Computer to Camera Memory

If you want to transfer images from your computer to the camera, install Photo Transport on your computer from the CD-ROM that comes with the camera.

■ To install Photo Transport

1. On the CD-ROM menu screen, select “Photo Transport”.

2. After reading the information about installation conditions and system requirements for installation in the “Read me” file, install Photo Transport.

■ To transfer images to the camera

1. **Connect the camera to your computer (page 85).**
The camera will turn on automatically and battery charging will start (page 18).

2. **On your computer, click the following: Start → All Programs → CASIO → Photo Transport.**
This starts up Photo Transport.

3. **Drag the file(s) you want to transfer to the [Transfer] button.**

4. **Follow the instructions that appear on the display to complete the transfer.**
 - The details of the instructions that appear on the display and the transferred images will depend on your Photo Transport setup. For details, click the [Settings] button or [Help] button and check the setup.

Transfer Data

- Only image files with the following extensions can be transferred to the camera: jpg, jpeg, jpe, bmp (bmp images are converted to jpeg images automatically when transferred.)
- Certain types of images may not be able to be transferred.
- You cannot transfer movies to the camera.

■ To transfer computer screen captures to the camera

1. Connect the camera to your computer (page 85).

The camera will turn on automatically and battery charging will start (page 18).

2. On your computer, click the following: Start → All Programs → CASIO → Photo Transport.

This starts up Photo Transport.

3. Display the screen whose screen capture you want to transfer.

4. Click the [Capture] button.

5. Draw a boundary around the area you want to capture.

Move your mouse pointer to the upper left corner of the area you want to capture and then hold down the mouse button. Keeping the mouse button depressed, drag the pointer down to the lower right corner of the area and then release the mouse button.

6. Follow the instructions that appear on the display.

This will send an image of the area you selected to the camera.

- The transfer operation converts screen captures to JPEG format.
- The instructions that appear on the display and details about the transferred images will depend on your Photo Transport setup. For details, click the [Settings] button or [Help] button and check the setup.

■ About settings and help

Click the [Settings] button when you want to change the Photo Transport setup. For help about operation procedures and troubleshooting, click the Photo Transport [Help] button.

Play back Dynamic Photo images on your EXILIM, a computer, or on a mobile phone

You can copy moving subjects (animated characters) from your computer to the EXILIM. You also can convert Dynamic Photo images to movies and send them to a mobile phone for playback. To perform such functions, you need to install Dynamic Photo Manager on your computer from the CD-ROM that comes with your EXILIM. For details, see the Dynamic Photo Manager user's guide that comes with your EXILIM.

Transforming Snapshots into Artistic Image

The CD-ROM that comes with your camera contains an application called Virtual Painter 5 LE for CASIO. By installing this application on your computer, you can transform your digital images so they appear as if they were drawn or painted by hand. You can choose from among water color, oil, color pencil or pastel effects that produce images that looked like they were done by a true virtual artist.

- Assistance: Umemura Taka Software Design, Inc.

■ To install Virtual Painter 5 LE for CASIO

1. Use the CD-ROM menu screen to select "Virtual Painter 5 LE for CASIO".

2. First click "Read me", read the information it contains about installation and computer system requirements, and then install the application.

When you are prompted to input a serial number during the installation, input the following.

11-08-900006-deeNEe

IMPORTANT!

- Note the following important points when inputting the serial number.
 - Input using single-byte characters only.
 - The serial number is case-sensitive, so be sure to input uppercase and lowercase letters correctly.

■ To transform snapshots into artistic images

- 1. On your computer, click the following in sequence: Start → All Programs → Virtual Painter 5 LE for CASIO.**

This will start up Virtual Painter 5 LE for CASIO.

- 2. On the toolbar, click [File] - [Open] and then select the image file you want to transform.**

- If necessary, you can click a folder icon and select an image inside the folder.
-

- 3. On the toolbar, click [Paint] or the canvas icon to transform the image.**

For details about this operation, click the Virtual Painter [Help] button.



IMPORTANT!

- Virtual Painter 5 LE for CASIO supports transformation of JPEG images shot with CASIO brand EXILIM Series digital cameras only. Transformation of images shot with a different brand digital camera is not supported.
- Be sure to use "Save As" or otherwise change to a different file name when saving a snapshot that you have transformed into an artistic image. Using "Save" will cause the transformed image to overwrite your original snapshot, effectively deleting the original.

Viewing User Documentation (PDF Files)

1. Start up your computer, and place the bundled CD-ROM into its CD-ROM drive.

Normally, this should cause the menu screen to appear automatically. If your computer does not display the menu screen automatically, navigate to the CD-ROM on your computer and then double-click the "AutoMenu.exe" file.

2. On the menu screen, click the "Language" down arrow button and then select the language you want.

3. Click "Manual" to select it and then click "Digital Camera".



IMPORTANT!

- You must have Adobe Reader or Adobe Acrobat Reader installed on your computer in order to view the contents of a PDF file. If you do not already have Adobe Reader or Adobe Acrobat Reader installed, install Adobe Reader from the bundled CD-ROM.

User Registration

You can perform user registration over the Internet. To do so, of course, you need to be able to connect to the Internet with your computer.

1. On the CD-ROM menu screen, click the "Register" button.

- This starts up your Web browser and accesses the user registration website. Follow the instructions that appear on your computer screen to register.

Using the Camera with a Macintosh

Install the required software in accordance with what version of the Macintosh OS you are running and what you want to do.

When you want to do this:	Operating System Version	Install this software:	See page:
Save images to your Macintosh and view them there manually	OS 9	Installation not required.	95
	OS X		
Save images to your Macintosh automatically/ Manage images	OS 9	Use commercially available software.	97
	OS X	Use iPhoto, which comes bundled with some Macintosh products.	
Play movies	OS 9, OS X	You can playback with QuickTime, which comes bundled with your operating system.	98

Connecting the Camera to Your Computer and Saving Files



IMPORTANT!

- The camera does not support operation with Mac OS 8.6 or earlier, or Mac OS X 10.0. Operation is supported with Mac OS 9, X (10.1, 10.2, 10.3, 10.4, 10.5, 10.6) only. Use the standard USB driver that comes with your supported operating system.

NOTE

- You also can use your computer's card slot (if it has one) or a commercially available card reader to access image files directly from the camera's memory card. For details, see the user documentation that comes with your computer.

■ To connect the camera to your computer and save files

1. Press [ON/OFF] (Power) to turn off the camera.

2. Use the USB cable that comes with the camera to connect it to your Macintosh.

The camera will turn on automatically and battery charging will start (page 18).

- The camera may not turn on automatically in the case of certain computer models or connection conditions. If this happens, press [ON/OFF] (Power) to turn on the camera.
- Make sure that you insert the cable connector into the USB port until you feel it click securely into place. Failure to insert the connector fully can result in poor communication or malfunction.
- Note that even while the connector is fully inserted, you still will be able to see the metal part of the connector as shown in the illustration.
- When connecting the USB cable to a USB port, make sure you align the connector correctly with the port.
- Your computer may not be able to recognize the camera if you connect via a USB hub. Always connect directly to the computer's USB port.
- The first time you connect the camera to your computer with the USB cable, an error message may appear on your computer. If this happens, disconnect and then reconnect the USB cable.

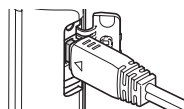
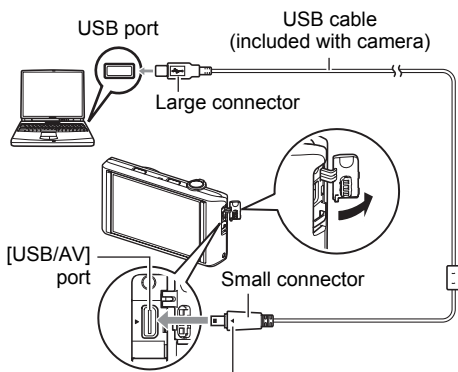

3. Double-click the camera's drive icon.

The camera's back lamp will light green at this time. In this mode, your Macintosh recognizes the memory card loaded in the camera (or the camera's built-in memory if it does not have a memory card loaded) as a drive. The appearance of the drive icon depends on the Mac OS version you are using.

4. Drag the "DCIM" folder to the folder to which you want to copy it.

5. After the copy operation is complete, drag the drive icon to Trash.

6. Disconnect the camera from the computer.

■ To view copied images

1. Double-click the camera's drive icon.

2. Double-click the "DCIM" folder to open it.

3. Double-click the folder that contains the images you want to view.

4. Double-click the image file you want to view.

- For information about file names, see "Memory Folder Structure" on page 102.
- An image that was rotated on the camera will be displayed on your Macintosh screen in its original (unrotated) orientation.

Never use your computer to modify, delete, move, or rename any image files that are in the camera's built-in memory or on its memory card.

Doing so can cause problems with the camera's image management data, which will make it impossible to play back images on the camera and can drastically alter remaining memory capacity. Whenever you want to modify, delete, move, or rename an image, do so only on images that are stored on your computer.

IMPORTANT!

- Never unplug the USB cable, or operate the camera while viewing or storing images. Doing so can cause data to become corrupted.

Transferring Images Automatically and Managing Them on Your Macintosh

If you are running Mac OS X, you can manage snapshots using iPhoto, which comes bundled with some Macintosh products. If you are running Mac OS 9, you will need to use commercially available software.

Playing a Movie

You can use QuickTime, which comes bundled with your operating system, to play back movies on a Macintosh. To play back a movie, first copy it to your Macintosh and then double-click the movie file.

■ Minimum Computer System Requirements for Movie Playback

The minimum system requirements described below are necessary to play back movies recorded with this camera on a computer.

Operating System : Mac OS X 10.3.9 or higher

Required Software: QuickTime 7 or higher

- The above are recommended system environments. Configuring one of these environments does not guarantee proper operation.
- Certain settings and other installed software may interfere with proper playback of movies.

■ Movie Playback Precautions

Proper movie playback may not be possible on some Macintosh models. If you experience problems, try the following.

- Change the movie image quality setting to “STD”.
- Upgrade to the latest version of QuickTime.
- Shut down other applications that are running.

Even if proper playback is not possible on your Macintosh, you can use the AV cable that comes bundled with the camera to connect to the video input terminal of a TV or Macintosh and play back movies that way.

IMPORTANT!

- Be sure to move the movie data to the hard disk of your Macintosh before trying to play it. Proper movie playback may not be possible for data accessed over a network, from a memory card, etc.

Viewing User Documentation (PDF Files)

You must have Adobe Reader or Adobe Acrobat Reader installed on your computer in order to view the contents of a PDF file. If you don't, go to the Adobe Systems Incorporated website and install Acrobat Reader.

- 1. On the CD-ROM, open the “Manual” folder.**
- 2. Open the “Digital Camera” folder and then open the folder for the language whose user’s guide you want to view.**
- 3. Open the file named “camera_xx.pdf”.**
 - “xx” is the language code (Example: camera_e.pdf is for English).

User Registration

Internet registration only is supported. Visit the following CASIO website to register:
<http://world.casio.com/qv/register/>

Using an Eye-Fi Wireless SD Memory Card to Transfer Images (Eye-Fi)

Shooting with an Eye-Fi wireless SD memory card loaded in the camera makes it possible to transfer image data automatically to a computer via wireless LAN.

- 1. Configure LAN access point, transfer destination and other settings for the Eye-Fi card in accordance with the instructions that come with the Eye-Fi card.**
- 2. After configuring settings, load the Eye-Fi card into the camera and record.**

Images you record are sent by wireless LAN to your computer, etc.

- For full details, see the user documentation that comes with the Eye-Fi card.
- Before formatting a new Eye-Fi card to use it for the first time, copy the Eye-Fi Manager install files to your computer. Do this before formatting the card.



IMPORTANT!

- Recorded images are transferred over wireless LAN. Do not use the Eye-Fi card or turn off Eye-Fi card communication (page 103) when on an aircraft or in any other location where use of wireless communication is limited or prohibited.
- The Eye-Fi icon will be displayed on the monitor screen while all three of the following conditions exist: Eye-Fi card loaded; Eye-Fi setting "On"; Status On (page 110).
- The camera's Auto Power Off function is disabled while image data transfer is in progress.
- A confirmation message will appear on the monitor screen if you try to turn off the camera while image data transfer is in progress. Follow the instructions in the messages (page 131).
- Transfer of a large number of images can take some time to complete.
- Depending on the type of Eye-Fi card you are using and its settings, images on the Eye-Fi card may be deleted following image data transfer.
- When recording a movie to an Eye-Fi card, it can take too much time to record data, which can result in breaks in the image and/or audio.
- Proper Eye-Fi card data communication may not be possible due to camera settings, battery level, or operating conditions.

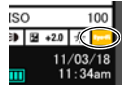

Files and Folders

The camera creates a file each time you shoot a snapshot, record a movie, or perform any other operation that stores data. Files are grouped by storing them in folders. Each file and folder has its own unique name.

- For details about how folders are organized in memory, see “Memory Folder Structure” (page 102).

Name and Maximum Number Allowed	Example
File	
Each folder can contain up to 9999 files named CIMG0001 through CIMG9999. The extension on the file name depends on the file type.	26th file name: CIMG0026.JPG Extension Serial number (4 digits)
Folders	
Folders are named from 100CASIO to 999CASIO. There can be up to 900 folders in memory.	100th folder name: 100CASIO Serial number (3 digits)

- You can view folder and file names on your computer. For details about how file names are displayed on the camera’s monitor screen, see page 10.
- The total number of folders and files allowed depends on the image size and quality, and capacity of the memory card being used for storage.

Memory Card Data

The camera stores images you shoot in accordance with the Design Rule for Camera File System (DCF).

■ About DCF

The following operations are supported for DCF-compliant images. Note, however, that CASIO makes no performance guarantees concerning these operations.

- Transferring this camera’s DCF-compliant images to another manufacturer’s camera and view them.
- Printing this camera’s DCF-compliant images on another manufacturer’s printer.
- Transferring another camera’s DCF-compliant images to this camera and view them.

■ Memory Folder Structure

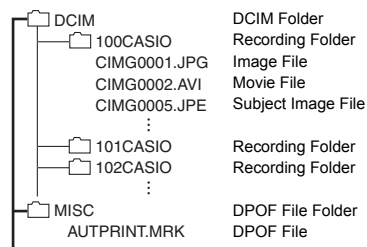

■ Supported Image Files

- Image files shot with this camera
- DCF-compliant image files

This camera may not be able to display an image, even if it is DCF-compliant. When displaying an image recorded on another camera, it may take a long time for the image to appear on this camera's monitor screen.

■ Built-in Memory and Memory Card Data Handling Precautions

- Whenever copying memory contents to your computer, you should copy the DCIM folder and all of its contents. A good way to keep track of multiple DCIM folders is to change their names to dates or something similar after you copy them to your computer. If you later decided to return a DCIM folder to the camera, however, be sure to change its name back to DCIM. The camera is designed to recognize only a root file with the name DCIM. Note the camera also will not be able to recognize the folders inside the DCIM folder unless they have the names they originally had when you copied them from the camera to your computer.
- Folders and files must be stored in accordance with the "Memory Folder Structure" shown on page 102 in order for the camera to be able to recognize them correctly.
- You also can use a PC card adapter or a memory card reader/writer to access camera files directly from the camera's memory card.
- A Subject Image File (CIMG****.JPE) contains special image data. Never edit a Subject Image File on your computer and transfer it back to the camera. Doing so can cause abnormal camera operation.

Other Settings (Set Up)

This section explains menu items that you can use to configure settings and perform other operations in both the REC mode and PLAY mode.

For information about menu operations, see page 50.

Adjusting Monitor Screen Brightness (Screen)

Procedure

MENU → **Setup** → **Screen**

You can use the following procedure to change the brightness of the monitor screen.

Auto	With this setting, the camera detects available light levels and automatically adjusts the brightness of the monitor screen accordingly.
+2	Brightness that is greater than +1, which makes the screen easier to view. This setting consumes more power.
+1	Bright setting for outdoor use, etc. Brightness that is greater than 0.
0	Normal monitor screen brightness for indoor use, etc.
-1	Screen brightness for viewing in a dark environment without disturbing others around you.

Turning off Eye-Fi Card Communication (Eye-Fi)

Procedure

MENU → **Setup** → **Eye-Fi**

Select "Off" to disable Eye-Fi card communication (page 99).

Configuring Camera Sound Settings (Sounds)

Procedure

MENU → **Setup** → **Sounds**

Startup		Toggles the operation tone between on and off.
Half Shutter		
Shutter		
Operation		
Volume	Operation	Specifies the sound volume. This volume setting is also used during video output (from the USB/AV port) (page 68).
	Playback	Specifies the volume of movie audio output. This volume setting is also used during video output (from the USB/AV port) (page 68).

- Setting a volume level of 0 mutes output.

Time Stamping Snapshots (Timestamp)

Procedure

MENU → **Setup** → **Timestamp**

You can configure the camera to stamp the recording date only, or date and time in the lower right corner of each snapshot.

- Once date and time information is stamped into a snapshot, it cannot be edited or deleted.

Example: July 10, 2012, 1:25 p.m.

Date	2012/7/10
Date&Time	2012/7/10 1:25pm
Off	No stamping of date and/or time

- Even if you do not stamp the date and/or time with Timestamp, you can do so later using some printing application.
- Stamping is performed in accordance with the date and time settings (page 106) and the display style settings (page 107).

Configuring World Time Settings (World Time)

Procedure

MENU → **Setup** → **World Time**

Setting a Travel Destination

You can use the World Time screen to view the current time in a zone that is different from your Home City when you go on a trip, etc. World Time displays the current time in 162 cities in 32 time zones around the globe.

1. Touch **“Destination”**.

- To change the geographic area and city for the time where you normally use the camera, select “Home”.

2. Touch **“City”**.

To specify summer time for the destination city, select “DST” and then select the “On” setting (Summer time is used in some geographical areas to advance the current time setting by one hour during the summer months).

3. Drag upwards and downwards until you find the area of the destination city you want, and then touch to select it.

4. Drag upwards and downwards until you find the city you want, and then touch to select it.

IMPORTANT!

- Before configuring World Time settings, make sure that the Home City setting is the place where you live or normally use the camera. If it isn't, select “Home” on the screen in step 1 and configure the Home City, date, and time settings as required (page 106).

Selecting the Time Display

Use this procedure to specify the time displayed by the camera for your home city and destination.

1. Touch “Time”.

2. Touch “Home” or “Destination”.

This will configure the time setting of the location you touched in the previous step.

Setting the Camera’s Clock (Adjust)

Procedure

MENU → Setup → Adjust

1. Touch the value you want to change (year, month, day, hour, minute).

2. Touch “▲” or “▼” to change the currently selected value.

- You can specify a date from 2001 to 2049.
- Be sure to select your Home City (page 105) before setting the time and date. If you set the time and date while the wrong city is selected for your Home City, the times and dates of all of the World Time cities (page 105) will be wrong.
- To switch between 12-hour and 24-hour format, touch the 12/24 hour switch icon.
- Touching and holding “▲” or “▼” scrolls at high speed.

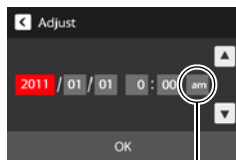

12/24 hour switch icon

3. Touch “OK”.

Specifying the Date Style (Date Style)

Procedure

MENU → Setup → Date Style

You can select from among three different styles for the date.

Example: July 10, 2012

YY/MM/DD	12/7/10
DD/MM/YY	10/7/12
MM/DD/YY	7/10/12

Specifying the Display Language (Language)

Procedure

MENU → Setup → Language

■ Specify the display language you want.

1. On the menu screen, touch “Setup”.
2. Touch “Language”.
3. Drag upwards and downwards until you find the language you want, and then touch to select it.

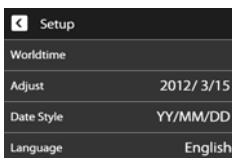

- Camera models sold in certain geographic areas may not support display language selection.

Calibrating the Touch Panel (Calibrate TP)

Procedure

MENU → Setup → Calibrate TP

Calibrate the touch panel whenever a touch operation does not produce the desired results or if touch panel response is poor.

1. Touch “Start”.

2. Touch the centers of each of the four cross marks “+” as they appear on the screen.

Take your time when performing this operation and wait until the next cross appears.

The message “Complete” indicates that touch panel calibration is complete.

- Carefully touch the center of each cross mark (+).

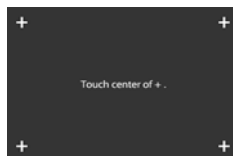

Selecting the Screen Aspect Ratio and Video Output System (Video Out)

Procedure

MENU → Setup → Video Out

You can use the procedure in this section to select either NTSC or PAL as the video output system. You can also specify an aspect ratio of 4:3 or 16:9.

NTSC	Video system used in Japan, the U.S., and other countries
PAL	Video system used in Europe and other areas
4:3	Normal TV screen aspect ratio
16:9	Wide screen aspect ratio

- Select the aspect ratio (4:3 or 16:9) that matches the type of TV you plan to use. Images will not display correctly if you select the wrong aspect ratio.
- Images will not display correctly unless the camera's video signal output setting matches the video signal system of the TV or other video equipment.
- Images cannot be displayed correctly on a TV or video equipment that is not NTSC or PAL.

Formatting Built-in Memory or a Memory Card (Format)

Procedure

MENU → **Setup** → **Format**

If a memory card is loaded in the camera, this operation will format the memory card. It will format built-in memory if no memory card is loaded.

- The format operation will delete all contents on the memory card or in built-in memory. It cannot be undone. Make sure you do not need any data currently on the card or in built-in memory before you format it.
- Formatting built-in memory or a memory card will delete all protected images stored there.
- Check the battery level before starting a format operation and make sure it is not too low. Formatting may not be performed correctly and the camera may stop operating normally if the camera powers down while formatting is in progress.

Resetting the Camera to Factory Defaults (Reset)

Procedure

MENU → **Setup** → **Reset**

See page 124 for details about the camera's factory default settings.

The settings below are not reset.

World Time settings, clock settings, date style, screen language, video output

Configuring Monitor Screen Settings

Selecting Display Information (DISP)

Each touch of "DISP" will cycle through settings that display or hide on-screen information. You can configure separate settings for the REC mode and PLAY mode.

- If "DISP" is not displayed on the screen, touch the tab to display it.
- Display information cannot be changed during movie recording.

Off	No information displayed.
Information On	Shows information about image settings, etc.
Status On	Shows more detailed information about settings. <ul style="list-style-type: none">• When Status On is selected, you will not be able to view the subject on the monitor screen.

Precautions during Use

■ Avoid Use While In Motion

- Never use the camera to record or play back images while operating an automobile or other vehicle, or while walking. Looking at the monitor while in motion creates the risk of serious accident.

■ Directly Viewing the Sun or Bright Light

- Never look at the sun or any other bright light through the camera's viewfinder. Doing so can damage your eyesight.

■ Flash

- Never use the flash unit in areas where flammable or explosive gas may be present. Such conditions create the risk of fire and explosion.
- Never fire the flash in the direction of a person operating a motor vehicle. Doing so can interfere with the driver's vision and creates the risk of accident.
- Never fire the flash too close to the eyes of the subject. Doing so creates the risk of loss of eyesight.

■ Monitor Screen

- Should the monitor screen ever become cracked, never touch any of the liquid inside the monitor screen. Doing so creates the risk of skin inflammation.
- Should monitor screen liquid ever get into your mouth, immediately rinse your mouth out and contact your physician.
- Should monitor screen liquid ever get into your eyes or onto your skin, immediately rinse with clean water for at least 15 minutes and contact your physician.

■ Connections

- Never plug any devices that are not specified for use with this camera into connectors. Connecting a non-specified device creates the risk of fire and electric shock.

■ Transport

- Never operate the camera inside of an aircraft or anywhere else where operation of such devices is restricted. Improper use creates the risk of serious accident.

■ **Smoke, abnormal odor, overheating, and other abnormalities**

- Continued use of the camera while it is emitting smoke or strange odor, or while it is overheating creates the risk of fire and electric shock. Immediately perform the following steps whenever any of the above symptoms are present.
 1. Turn off the camera.
 2. Remove the battery from the camera, taking care to protect yourself against burn injury.
 3. Contact your dealer or nearest CASIO authorized service center.

■ **Water and Foreign Matter**

- Water, other liquids, or foreign matter (especially metal) getting inside the camera creates the risk of fire and electric shock. Immediately perform the following steps whenever any of the above symptoms are present. Particular care is required when using the camera where it is raining or snowing, near the ocean or other body of water, or in a bathroom.
 1. Turn off the camera.
 2. Remove the battery from the camera.
 3. Contact your dealer or nearest CASIO authorized service center.

■ **Dropping and Rough Treatment**

- Continued use of the camera after it is damaged by dropping or other rough treatment creates the risk of fire and electric shock. Immediately perform the following steps whenever any of the above symptoms are present.
 1. Turn off the camera.
 2. Remove the battery from the camera.
 3. Contact your dealer or nearest CASIO authorized service center.

■ **Keep Away From Fire**

- Never expose the camera to fire, which can cause it to explode and creates the risk of fire and electric shock.

■ **Disassembly and Modification**

- Never try to take the camera apart or modify it in any way. Doing so creates the risk of electric shock, burn injury, and other personal injury. Be sure to leave all internal inspection, maintenance, and repair up to your dealer or nearest CASIO authorized service center.

■ Locations To Be Avoided

- Never leave the camera in any of the following types of locations. Doing so creates the risk of fire and electric shock.
 - Areas subject to large amounts of humidity or dust
 - Food preparation areas or other locations where oil smoke is present
 - Near heaters, on a heated carpet, in areas exposed to direct sunlight, in a closed vehicle parked in the sun, or other areas subject to very high temperatures
- Never place the camera on an unstable surface, on a high shelf, etc. Doing so can cause the camera to fall, creating the risk of personal injury.

■ Backing Up Important Data

- Always keep backup copies of important data in camera memory by transferring it to a computer or other storage device. Note that data can be deleted in the case of camera malfunction, repair, etc.

■ Memory Protection

- Whenever replacing the battery, be sure to follow the correct procedure as described in the documentation that comes with the camera. Incorrectly replacing the battery can result in corruption or loss of data in camera memory.

■ Rechargeable Battery

- Use only the USB-AC adaptor (AD-C53U) or the specified device to charge the battery. Attempting to charge the battery by an unauthorized means creates the risk of battery overheating, fire, and explosion.
- Do not expose or immerse the battery in fresh water or salt water. Doing so can damage the battery, and cause deterioration of its performance and loss of service life.
- The battery is intended for use with a CASIO Digital Camera only. Use with any other device creates the risk of the battery damage, or deterioration of battery performance and service life.
- Failure to observe any of the following precautions creates the risk of battery overheating, fire, and explosion.
 - Never use or leave the battery near open flame.
 - Do not expose the battery to heat or fire.
 - Never carry or store the battery together with items that can conduct electricity (necklaces, pencil lead, etc.).
 - Never disassemble the battery, pierce it with a needle, or expose it to strong impact (hit it with a hammer, step on it, etc.), and never apply solder to it. Never place the battery into a microwave oven, heater, high-pressure generating device, etc.

- Should you ever notice leakage, strange odor, heat generation, discoloration, deformation, or any other abnormal condition while using, charging, or storing a battery, immediately remove it from the camera and keep it away from open flame.
- Do not use or leave the battery under direct sunlight, in an automobile parked in the sun, or in any other area subject to high temperatures. Doing so can damage the battery, and cause deterioration of its performance and loss of service life.
- If battery charging does not end normally within the specified charging time, stop charging anyway and contact your local CASIO authorized service center. Continued charging creates the risk of battery overheating, fire, and explosion.
- Battery fluid can damage your eyes. Should battery fluid get into your eyes accidentally, immediately rinse them with clean tap water and then consult a physician.
- Be sure to read the user documentation that comes with the camera and special USB-AC adaptor before using or charging the battery.
- If a battery is to be used by young children, make sure that a responsible adult makes them aware of the precautions and proper handling instructions, and make sure that they handle the battery correctly.
- Should fluid from a battery accidentally get onto clothing or your skin, immediately rinse it off with clean tap water. Prolonged contact with battery fluid can cause skin irritation.

■ Battery Life

- Battery continuous operation times provided in this manual represent the approximate amount of time before the camera turns off due to low battery power when being powered by the special battery under normal temperature (23°C (73°F)). They do not guarantee that you will be able to achieve the indicated level of operation. Actual battery life is greatly affected by ambient temperature, battery storage conditions, the amount of time spent in storage, etc.
- Leaving the camera on can run down the battery and cause the low battery warning to appear. Turn off the camera whenever you are not using it.
- The low battery warning indicates that the camera is about to turn off due to low battery power. Charge the battery as soon as possible. Leaving a low or dead battery in the camera can lead to battery leakage and data corruption.

■ Data Error Precautions

Your digital camera is manufactured using precision digital components. Any of the following creates the risk of corruption of data in camera memory.

- Removing the battery or memory card while the camera is performing some operation
- Removing the battery or memory card while the back lamp is flashing green after turning off the camera
- Disconnecting the USB cable while communication is in progress
- Using a battery that is low
- Other abnormal operations

Any of the above conditions can cause an error message to appear on the monitor screen (page 131). Perform the action indicated by the message that appears.

■ Operating Environment

- Operating Temperature Requirements: 0 to 40°C (32 to 104°F)
- Operating Humidity: 10 to 85% (non condensation)
- Do not place the camera in any of the following locations.
 - In an area exposed to direct sunlight, or large amounts of moisture, dust, or sand
 - Near an air conditioner or in other areas subjected to extreme temperature or humidity
 - Inside of a motor vehicle on a hot day, or in an area subjected to strong vibration

■ Condensation

Sudden and extreme temperature changes, such as when the camera is moved from the outdoors on a cold winter day into a warm room, can cause water droplets called “condensation” to form on the interior and the exterior of the camera, which creates the risk of malfunction. To prevent condensation from forming seal the camera in a plastic bag before changing locations. Then leave the bag sealed to allow the air inside to naturally change to the same temperature as the air in the new location. After that, remove the camera from the bag and open the battery cover for a few hours.

■ Lens

- Never apply too much force when cleaning the surface of the lens. Doing so can scratch the lens surface and cause malfunction.
- You may sometimes notice some distortion in certain types of images, such as a slight bend in lines that should be straight. This is due to the characteristics of lenses, and does not indicate malfunction of the camera.

■ Caring for your camera

- Never touch the lens or flash window with your fingers. Finger smudges, dirt, and other foreign matter on the lens or flash window can interfere with proper operation of the camera. Use a blower or other means to keep the lens and flash window free of dirt and dust, and wipe gently with a soft, dry cloth.
- To clean the camera, wipe it with a soft, dry cloth.

■ Old Rechargeable Battery Handling Precautions

- Insulate the positive and negative terminals with tape, etc.
- Do not peel the covering off of the battery.
- Do not try to take the battery apart.

■ USB-AC adaptor Handling Precautions



- Never plug the power cord into an outlet whose voltage rating is different from that marked on the power cord. Doing so creates the risk of fire, malfunction, and electric shock.
 - Take care to protect the power cord against damage and breaking. Never place heavy objects onto the power cord, or expose it to intense heat. Doing so can damage the power cord, creating the risk of fire and electric shock.
 - Never try to modify the power cord, or subject it to severe bending, twisting, or pulling. Doing so creates the risk of fire, malfunction, and electric shock.
 - Never plug in or unplug the power cord while your hands are wet. Doing so creates the risk of electric shock.
 - Do not plug the power cord into an outlet or extension cord that is shared by other devices. Doing so creates the risk of fire, malfunction, and electric shock.
 - Should the power cord ever become damaged (to the point that internal wires are exposed or cut), immediately contact your original retailer or a CASIO authorized service center to request repair. Continued use of a damaged power cord creates the risk of fire, malfunction, and electric shock.
- The USB-AC adaptor becomes slightly warm during charging. This is normal and does not indicate malfunction.
 - Unplug the power cord from the power outlet when you are not using the USB-AC adaptor.
 - Never use detergent to clean the power cord (especially the plug).
 - Never cover the USB-AC adaptor with a blanket, etc. Doing so creates the risk of fire.

■ Other Precautions

The camera becomes slightly warm during use. This is normal and does not indicate malfunction.

■ Copyrights

Except for your own personal enjoyment, unauthorized use of snapshots or movies of images whose rights belong to others, without the permission of the right holder, is forbidden by copyright laws. In some cases, shooting of public performances, shows, exhibitions, etc. may be restricted entirely, even if it is for your own personal enjoyment. Regardless of whether such files are purchased by you or obtained for free, posting them on a website, a file sharing site, or any other Internet site, or otherwise distributing them to third parties without the permission of the copyright holder is strictly prohibited by copyright laws and international treaties. For example, uploading or distributing on the Internet images of TV programs, live concerts, music videos, etc. that were photographed or recorded by you may infringe upon the rights of others. Note that CASIO COMPUTER CO., LTD. shall not be held liable for use of this product in any way that infringes on the copyrights of others or that violates copyright laws.

The following terms, which are used in this manual, are registered trademarks or trademarks of their respective owners.

Note that trademark [™] and registered trademark [®] are not used within the text of this manual.

- SDXC Logo is a trademark of SD-3C, LLC.
- Microsoft, Windows, Internet Explorer, Windows Media, Windows Vista, Windows 7, and DirectX are registered trademarks or trademarks of Microsoft Corporation in the United States and other countries.
- Macintosh, Mac OS, QuickTime, and iPhoto are trademarks of Apple Inc.
- Adobe and Reader are trademarks or registered trademarks in the United States and other countries of Adobe Systems Incorporated.
- YouTube, the YouTube logo, and "Broadcast Yourself" are trademarks or registered trademarks of YouTube, LLC.
- Eye-Fi and the Eye-Fi logo are trademarks of Eye-Fi, Inc.
- EXILIM, Photo Transport, Dynamic Photo, Dynamic Photo Manager, Virtual Painter 5 LE for CASIO, and YouTube Uploader for CASIO are registered trademarks or trademarks of CASIO COMPUTER CO., LTD.
- All other company or product names mentioned herein are registered trademarks or trademarks of their respective companies.

Any and all unauthorized commercial copying, distribution, and copying of the bundled software over a network are prohibited.

This product contains PrKERNELv4 Real-time OS of eSOL Co., Ltd. Copyright © 2007 eSOL Co., Ltd.

PrKERNELv4 is a registered trademark of eSOL Co., Ltd. in Japan.



This product contains the software of FotoNation, Inc. FotoNation is a registered trademark of FotoNation, Inc. FaceTracker is a trademark of FotoNation, Inc.



This product's YouTube upload functionality is included under license from YouTube, LLC. The presence of YouTube upload functionality in this product is not an endorsement or recommendation of the product by YouTube, LLC.

Charging

■ If the camera's back lamp starts flashing red...

If the back lamp starts flashing red during charging, it means that further charging is not possible for one of the reasons below. Perform the actions described below to correct the problem and then try charging again.

Ambient temperature or the temperature of the battery is abnormally high or low

Unplug the USB cable from the camera and wait for a while until the camera is within the temperature range of 5°C to 35°C (41°F to 95°F), and then try charging again.

Safety timer activated

A battery that has not been used for a long time, certain types of computers, and connection conditions can cause charging to take longer than normal. If charging takes longer than about six hours, a safety timer will terminate it automatically, even if the battery is not fully charged. If the battery has not been used for a very long time, charging may terminate automatically after only about 45 minutes.

- 1) Using a battery that has not been used for a long time.
Disconnect and then reconnect the USB cable to resume charging.
- 2) Insufficient power supply when connected to computer
Connect directly to a USB port what supplies a current of 500mA.

For details about the power supply capacity of a computer's USB port, contact the manufacturer of the computer. Though disconnecting and then reconnecting the USB cable will resume charging, you may need to do so repeatedly if the power supply capacity of the computer is low.

If problems continue to occur after you perform the above steps, it could mean that the battery is faulty. Contact your nearest CASIO authorized service center.

To replace the battery

1. Open the battery cover and remove the current battery.

With the monitor screen side of the camera facing upwards, slide the stopper in the direction indicated by the arrow in the illustration. After the battery pops out, pull it the rest of the way out of the camera.

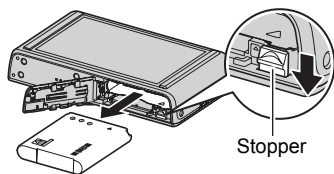

2. Load a new battery.

Battery Precautions

■ Precautions during Use

- Operation provided by a battery under cold conditions is always less than operation under normal temperatures. This is due to the characteristics of the battery, not the camera.
- Charge the battery in an area where the temperature is within the range of 5°C to 35°C (41°F to 95°F). Outside this temperature range charging can take longer than normal or even fail.
- Do not tear or remove the battery outer label.
- If a battery provides only very limited operation following a full charge, it probably means the battery has reached the end of its service life. Replace the battery with a new one.

■ Storage Precautions

- Storing the camera for a long time while it is charged can cause deterioration of battery characteristics. If you do not plan to use a camera for some time, fully use up its charge before storing it.
- Always remove the battery from the camera when you are not using it. A battery left in the camera can discharge and go dead, which will require some time to charge when you need to use the camera.
- Store batteries in a cool, dry place (20°C (68°F) or lower).
- To prevent over discharging of an unused battery, fully charge it, and then load it in the camera and fully use up the charge about once every six months.

Using the Camera in another Country

■ Precautions during Use

- The bundled USB-AC adaptor is designed for operation with any power supply in the range of 100V to 240V AC, 50/60Hz. Note, however, that the shape of the power cord plug depends on each country or geographic area. Before taking the camera and USB-AC adaptor along on a trip, check with travel agent about the power supply requirements in your destination(s).
- Do not connect the USB-AC adaptor to a power supply through a voltage converter or similar device. Doing so can lead to malfunction.

■ Extra Batteries

- Taking along extra fully charged batteries (NP-110) is recommended while on a trip in order to avoid not being able to shoot images due to the battery going dead.

Using a Memory Card

See page 23 for information about supported memory cards and how to load a memory card.

To replace the memory card

Press the memory card and then release it. This will cause it to pop out of the memory card slot slightly. Pull the card out the rest of the way and then insert another one.

- Never remove a card from the camera while the back lamp is flashing green. Doing so can cause the image save operation to fail and even damage the memory card.

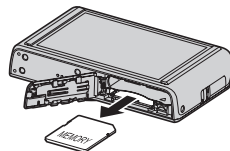

■ Using a Memory Card

- SD memory cards, SDHC memory cards, and SDXC memory cards have a write protect switch. Use the switch when you need to guard against accidentally deleting data. Note, however, if you write protect an SD memory card you must then turn write protection off whenever you want to record to it, format it, or delete any of its images.
- If a memory card starts to behave abnormally during image playback, you can restore normal operation by reformatting it (page 109). However, it is recommended that you always take along multiple memory cards whenever using the camera far away from the home or office.
- As you record data to and delete data from a memory card a number of times, it loses its ability to retain data. Because of this, periodic re-formatting of a memory card is recommended.

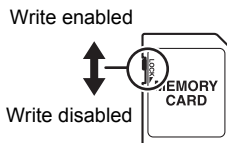

- Electrostatic charge, electrical noise, and other phenomena can cause data to become corrupted or even lost. Make sure that you always back up important data on other media (CD-R, CD-RW, hard disk, etc.).

■ Memory Card Handling Precautions

Certain types of memory cards can slow down processing speeds. In particular, you may experience problems saving high-quality (HD) movies. When using the camera's built-in memory or certain types of memory cards, it can take too much time to record data, which can result in breaks in the image and/or audio. This condition is indicated by the movie icon turning yellow on the monitor screen. Use of a memory card with a maximum transfer speed of at least 10MB per second is recommended.

■ Discarding or Transferring Ownership of a Memory Card or the Camera

- The format and delete functions of the camera do not actually delete files from the memory card. The original data remains on the card. Note that responsibility for the data on a memory card lies with you. The following procedures are recommended whenever you discard a memory card or the camera, or if you transfer ownership to another party.
 - When discarding a memory card, either physically destroy the memory card or use commercially available data delete software to completely delete the data on the memory card.
 - When transferring ownership of a memory card to another party, use commercially available data deletion software to completely delete the data on it. Use the format function (page 109) to completely delete the data in built-in memory before discarding or transferring ownership of the camera.

Computer System Requirements for Bundled Software (For Windows)

Computer system requirements are different for each of the applications. Be sure to check the requirements for the particular application you are trying to use. Note that the values provided here are minimum requirements for running each application. Actual requirements are greater, depending on the number of images and the sizes of the images being handled.

YouTube Uploader for CASIO

Operating System : Windows 7, Windows Vista, Windows XP (SP3)

- Sufficient memory to run the operating system
- Computer configuration that enables playback of movies on the YouTube site
- Computer configuration that enables upload of movies to the YouTube site

Photo Transport 1.0

Operating System : Windows 7, Windows Vista, Windows XP (SP3)

Memory : At least 64MB

Hard Disk Drive Space : At least 2MB

Dynamic Photo Manager

Operating System : Windows 7, Windows Vista (SP1), Windows XP (SP3)

Memory : At least 512MB

Hard Disk Drive Space : At least 10MB

Internet Browser : Internet Explorer 6.0 or greater or equivalent function browser

Other : QuickTime 7.6 or higher and Windows Media Player 10 or higher installed.
Computer with continuous Internet connection (1Mbps or greater)

Virtual Painter 5 LE for CASIO

Operating System : Windows 7, Windows Vista, Windows XP (SP3)

CPU : Intel Pentium III processor or later

Memory : At least 256MB

VIDEO : 24-bit full color display adapter at 1024 × 768 or larger resolution

- Installation requires in as a user with Administrator privileges.

Adobe Reader 9

Operating System : Windows 7, Windows Vista, Windows XP (SP3/SP2),
Windows 2000 (SP4)

Memory : At least 128MB (256MB recommended)

Hard Disk Drive Space : At least 335MB

For details about the minimum system requirements for each software application, see the “Read me” files on the CASIO Digital Camera Software CD-ROM that comes bundled with the camera.

Reset Initial Default Settings

The tables in this section show the initial default settings on menus that appear in the REC mode and PLAY mode when you reset the camera (page 109).

- A dash (–) indicates an item whose setting is not reset or an item for which there is no reset setting.



IMPORTANT!

- Switching from “Auto” to “Premium Auto” (page 28) will make some menu items unavailable.

■ REC Menu

Touch Shutter	On
Single SR Quality	Off
Single SR Zoom	On
Self-timer	Off
Image Size	16M
Movie Quality	HD
EV Shift	0.0
White Balance	Auto

ISO	Auto
Lighting	On
Focus	AF
Continuous AF	Off
AF Assist Light	On
Anti Shake	On
Review	On
Setup	→ Page 125

■ PLAY Menu

Dynamic Photo	–
Movie Converter	–
Protect	–
Copy	–
Red Eye	–

Trimming	–
Resize	–
Rotation	–
DPOF Printing	–
Setup	→ Page 125

■ Setup Menu





Screen	Auto
Eye-Fi	On
Sounds	Startup: On / Half Shutter: On / Shutter: On / Operation: On / Operation: 3 / Playback: 3
Timestamp	Off
World Time	—



Adjust	—
Date Style	—
Language	—
Calibrate TP	—
Video Out	—
Format	—
Reset	—
Version	—

When things don't go right...

Troubleshooting

Problem	Possible Cause and Recommended Action
Power Supply	
Power does not turn on.	<ol style="list-style-type: none">1)The battery may not be loaded correctly (page 15).2)The battery may be dead. Charge the battery (page 16). If the battery goes dead soon after being charged, it means the battery has reached the end of its life and needs to be replaced. Purchase a separately available CASIO NP-110 rechargeable lithium ion battery.
The camera suddenly powers down.	<ol style="list-style-type: none">1)The camera is designed to turn off automatically after no operation is performed for about five minutes. Turn power back on.2)The battery may be dead. Charge the battery (page 16).3)The camera's protection function may have activated because camera temperature is too high. Turn off the camera and wait until it cools down before trying to use it again.
Power will not turn off. Nothing happens when a button is pressed.	Remove the battery from the camera and then reload it.
Image Recording	
Image is not recorded when the shutter button is pressed.	<ol style="list-style-type: none">1)If the camera is in the PLAY mode, touch "⏏" (REC) to enter the REC mode.2)If the flash is charging, wait until the charge operation finishes.3)If the message "Memory Full" appears, transfer images to your computer, delete images you no longer need, or use a different memory card.
Auto Focus does not focus properly.	<ol style="list-style-type: none">1)If the lens is dirty, clean it off.2)The subject may not be in the center of the focus frame when you compose the image.3)The subject you are shooting may not be a type that is compatible with Auto Focus (page 34). Use manual focus (page 58).4)You may be moving the camera when shooting. Try shooting with Anti Shake or use a tripod.5)You may be pressing the shutter button all the way without waiting for Auto Focus. Half-press the shutter button and allow enough time for Auto Focus to focus.

Problem	Possible Cause and Recommended Action
The subject is out of focus in the recorded image.	The image may not be focused properly. When composing the image, make sure the subject is located inside the focus frame.
The flash does not fire.	<ol style="list-style-type: none"> 1) If  (Flash Off) is selected as the flash mode, change to another mode (page 42). 2) If the battery is dead, charge it (page 16). 3) If a BEST SHOT scene that uses  (Flash Off) is selected, change to a different flash mode (page 42) or select a different BEST SHOT scene (page 49). 4)  (Flash Off) is selected automatically when shooting with HDR, HDR Art, or Slide Panorama.
The  (Flash Off) icon flashes red on the monitor screen and the flash does not fire.	The flash unit may be malfunctioning. Contact a CASIO authorized service center or your original retailer. Note that though the flash will not fire, you still can use the camera for non-flash shots.
Camera powers down during Self-timer countdown.	The battery may be dead. Charge the battery (page 16).
The monitor screen image is out of focus.	<ol style="list-style-type: none"> 1) You may be using Manual Focus and have not focused the image. Focus the image (page 59). 2) You may be using "Macro" for scenery or portraits. Use Auto Focus for scenery and portrait shots (page 58).
There is a vertical line in the monitor screen image.	Shooting a very brightly lit subject can cause a vertical band to appear in the monitor screen image. This is a CCD phenomenon known as "vertical smear", and does not indicate malfunction of the camera. Note that vertical smear is not recorded with the image in the case of a snapshot, but it is recorded in the case of a movie.
There is digital noise in images.	<ol style="list-style-type: none"> 1) Sensitivity may have been increased automatically for a dark subject, which increases the chance of digital noise. Use a light or some other means to illuminate the subject. 2) You may be attempting to shoot in a dark location with  (Flash Off) selected, which can increase digital noise and make images appear coarse. In this case, turn on flash (page 42) or use lights for illumination. 3) Shooting with a high ISO sensitivity setting or with the Lighting feature can cause an increase in digital noise. Use a light or some other means to illuminate the subject.

Problem	Possible Cause and Recommended Action
A recorded image was not saved.	1) Camera power may have been turned off before the save operation was complete, which will result in the image not being saved. If the battery indicator shows  , charge the battery as soon as possible (page 20). 2) You may have removed the memory card from the camera before the save operation was complete, which will result in the image not being saved. Do not remove the memory card before the save operation is complete.
Though available lighting is bright, the faces of people in the image are dark.	Not enough light is reaching the subjects. Change the flash mode setting to  (Flash On) for daylight synchro flash (page 42), or adjust EV shift to the + side (page 55).
Night shots come out bad.	Use the "Night Scene" BEST SHOT scene (page 49) when shooting at night.
Subjects are too dark when shooting images in a seashore or ski area.	Sunlight reflected by water, sand, or snow, can cause underexposure of images. Change the flash mode setting to  (Flash On) for daylight synchro flash (page 42), or adjust EV shift to the + side (page 55).
Digital zoom (including HD zoom and Single SR Zoom) does not work. The zoom bar indicates zoom only up to a zoom factor of 8.0.	Date stamping may be turned on, which will cause digital zoom to be disabled. Turn off date stamping (page 104).
The image is out of focus during movie recording.	1) Focusing may not be possible because the subject is outside the focus range. Shoot within the allowable range. 2) The lens may be dirty. Clean the lens (page 115).

Problem	Possible Cause and Recommended Action
Playback	
The color of the playback image is different from what appears on the monitor screen when shooting.	Sunlight or light from another source may be shining directly into the lens when you are shooting. Position the camera so sunlight does not shine directly into the lens.
Images are not displayed.	This camera cannot display non-DCF images recorded onto a memory card using another digital camera.
Images cannot be edited (with resizing, trimming, rotation).	Note that you cannot edit the following types of snapshots. <ul style="list-style-type: none"> • Movies • Panorama Image • Snapshots recorded with another camera
File Deletion	
A file cannot be deleted.	The file may be protected. Unprotect the file (page 71).
Other	
The wrong date and time are displayed, or the wrong date and time are being stored along with image data.	The date and time setting is off. Set the correct date and time (page 106).
The messages on the display are in the wrong language.	The wrong display language is selected. Change the display language setting (page 107).
Images cannot be transferred over a USB connection.	1)The USB cable may not be connected securely. Check all connections. 2)If the camera is not turned on, turn it on. 3)Your computer may not be able to recognize the camera if you connect via a USB hub. Always connect directly to the computer's USB port.

Problem	Possible Cause and Recommended Action
Language selection screen appears when the camera is turned on.	<p>1) You did not configure initial settings after purchasing the camera or the camera may have been left with a dead battery. Check the camera setup (pages 20, 21).</p> <p>2) There may be a problem with the camera's memory data. If this is the case, perform the reset operation to initialize the camera's setup (page 109). After that, configure each setting. If the language selection screen does not re-appear when you turn the camera on, it means that the camera's memory management data has been restored. If the same message appears after you turn power back on, contact your retailer or a CASIO authorized service center.</p>
The time and date settings configured the first time after purchasing the camera are reset to their factory defaults when remove the camera's battery.	<p>Load the camera's battery and reconfigure the time and date settings (page 21). Do not remove the battery from the camera for at least 24 hours after configuring time and date settings. After that, the settings will not be reset if you remove the battery.</p> <ul style="list-style-type: none"> • If the time and date are reset to their factory default settings when you remove the battery after it has been loaded for more than 24 hours, it could mean that the camera's setting memory is defective. Contact your retailer or a CASIO authorized service center.
Buttons are not responsive right after the power has been turned on.	<p>With large capacity memory cards there is a delay after the power has been turned on before the buttons become responsive.</p>
The camera records images I didn't shoot or the camera shoots an image whenever I touch the monitor screen.	<p>Touch Shutter (page 51) is turned on. While Touch Shutter is turned on, take care that you do not touch the monitor screen while carrying the camera and avoid touching the monitor screen except when shooting an image or performing some other operation. If you do not want to use Touch Shutter, turn it off (page 51).</p>

Display Messages

ALERT	The camera's protection function may have activated because camera temperature is too high. Turn off the camera and wait until it cools down before trying to use it again.
Battery is low.	Battery power is low.
Card ERROR	<p>There is something wrong with the memory card. Turn off the camera, remove the memory card and then reload it into the camera. If this message re-appears when you turn the camera back on, format the memory card (page 109).</p> <p> IMPORTANT!</p> <ul style="list-style-type: none">• Formatting a memory card deletes all its files. Before formatting, try transferring recoverable files to a computer or some other storage device.
Files could not be saved because battery is low.	Battery power is low, so an image file could not be saved.
Folder cannot be created.	You are trying to record a file while there are already 9999 files stored in the 999th folder. If you want to record more, delete files you no longer need (page 33).
Images are being uploaded. Please wait.	You are attempting to turn off power while image data is being transferred using the Eye-Fi card (page 99).
LENS ERROR	This message appears and the camera turns off whenever lens performs some unexpected operation. If the same message appears after you turn power back on, contact a CASIO authorized service center or your original retailer.
LENS ERROR 2	The Camera Shake unit may be malfunctioning. If the same message appears after you turn power back on, contact your retailer or a CASIO authorized service center.

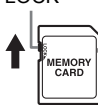
Memory Full	Memory is full with images you recorded and/or files saved by editing operations. Delete files you no longer need (page 33).
Record Error	Image compression could not be performed for some reason during image data storage. Shoot the image again.
RETRY POWER ON	The lens came into contact with an obstruction while moving. The camera will turn off automatically when this message appears. Remove the obstruction and turn power back on again.
SYSTEM ERROR	Your camera system is corrupted. Contact your retailer or a CASIO authorized service center.
The card is locked.	The LOCK switch of the SD, SDHC, or SDXC memory card loaded in the camera is in the locked position. You cannot store images to or delete images from a memory card that is locked. <div style="text-align: right;"> <p>LOCK</p>  </div>
There are no files.	There are no files in built-in memory or on the memory card.
This card is not formatted.	The memory card loaded in the camera is not formatted. Format the memory card (page 109).
This file cannot be played.	The file you are trying to access is corrupted or is a type that cannot be displayed by this camera.
This function cannot be used.	This message will appear part way through an operation when you attempt to use a function that is not allowed in combination with another function.

Number of Snapshots/Movie Recording Time

Snapshot

Image Size (Pixels)	Approximate Image File Size	Built-in Memory (Approx. 34.9MB ^{*1}) Snapshot Recording Capacity	SD Memory Card (1GB ^{*2}) Snapshot Recording Capacity
16M (4608×3456)	5.57 MB	6	173
3:2 (4608×3072)	4.92 MB	7	196
5M (2560×1920)	1.72 MB	20	562
3M (2048×1536) ^{*3}	1.25 MB	28	773
VGA (640×480)	290 KB	122	3334

Movies

Image Quality (Pixels) / (Audio)	Approximate Data Rate (Frame Rate)	Built-in Memory (Approx. 34.9MB ^{*1}) Movie Recording Capacity	SD Memory Card (1GB ^{*2}) Movie Recording Capacity	File Size of 1-minute Movie
HD (1280×720) (Monaural)	25.2 Megabits/second (24 frames/second)	11 seconds	5 minutes 14 seconds	189.0 MB
STD (640×480) (Monaural)	12.2 Megabits/second (30 frames/second)	23 seconds	10 minutes 49 seconds	91.5 MB

*1 Built-in memory capacity after formatting

*2 The above values are based on use of a PRO HIGH SPEED SD memory card (Panasonic Corporation). The number of images you can save depends on the type of memory card you are using.

*3 The Image Size is fixed at 3M when shooting with HDR and HDR Art only.

- Snapshot and movie recording capacity values are approximate and intended for reference only. Actual capacity depends on image contents.
- File size and data rate values are approximate and intended for reference only. Actual values depend on the type of image being shot.
- When using a memory card with a different capacity, calculate the number of images as a percentage of 1GB.
- Each movie can be up to 29 minutes long. Movie recording stops automatically after 29 minutes of recording.

Specifications

File Format	Snapshots: JPEG (Exif Version 2.3); DCF 2.0 standard; DPOF compliant Movies: Motion JPEG AVI, IMA-ADPCM audio (monaural)
Recording Media	Built-in Memory (Image Storage Area: 34.9MB*) SD/SDHC/SDXC * Built-in memory capacity after formatting
Recorded Image Sizes	Snapshot: 16M (4608×3456), 3:2 (4608×3072), 5M (2560×1920), VGA (640×480) Movies: HD (1280×720), STD (640×480)
Image Deletion	1 file; all files (with memory protection feature)
Effective Pixels	16.10 Megapixels
Imaging Element	Size: 1/2.3-inch square pixel CCD Total Pixels: 16.57 Megapixels
Lens/Focal Distance	F3.3 (W) to 5.9 (T) f = 4.4 to 35.2 mm (equivalent to 25 to 200 mm in 35 mm format) Ten lenses in eight groups, including aspherical lens.
Zoom	8.0X Optical zoom, 12.0X in combination with Single SR Zoom 4.0X Digital zoom Up to 127.5X when HD Zoom and Digital zoom are used in combination (VGA size)
Focusing	Contrast Detection Auto Focus • Focus Modes: Auto Focus, Macro Focus, Super Macro Focus, Manual Focus • AF Area: Spot with AF assist lamp * Intelligent AF area used when Premium Auto is selected.
Approximate Focus (Snapshot) (From Lens Surface)	Auto Focus: 5 cm to ∞ (2.0" to ∞) (Wide Angle) Macro Focus: 2 cm to 50 cm (0.8" to 19.7") (Seventh step zoom from the Widest Angle setting) Super Macro Focus: 2 cm to 50 cm (0.8" to 19.7") Manual: 5 cm to ∞ (2.0" to ∞) (Wide Angle) * Range is affected by optical zoom.
Metering	Multi-pattern by imaging element
Exposure Control	Program AE

Exposure Compensation	-2.0 EV to +2.0 EV (in 1/3EV steps)
Shutter	CCD shutter, mechanical shutter
Shutter Speed	Snapshot (Auto): 1/2 to 1/2000 second Snapshot (Premium Auto): 4 to 1/2000 second * May differ due to the camera setup.
Aperture Value	F3.3 (W) to F8.0 (W) (When used with ND filter) * Using optical zoom changes the aperture value.
White Balance	Auto, Daylight, Overcast, Shade, Day White Fluorescent, Daylight Fluorescent, Tungsten, Manual WB
Sensitivity (Standard Output Sensitivity)	Snapshots: Auto, ISO 80, ISO 100, ISO 200, ISO 400, ISO 800, ISO 1600, ISO 3200 equivalent Movies: Auto
Self-timer	Approximate Trigger Times: 10 seconds, 2 seconds
Flash Modes	Auto, Off, On, Red-eye reduction
Flash Range (ISO Sensitivity: Auto)	Normal: 0.4 m to 3.9 m (1.3' to 12.8') (Wide Angle) 0.8 m to 2.2 m (2.6' to 7.2') (Telephoto) * Range is affected by optical zoom.
Flash Charging Time	Approximately 4 seconds maximum
Recording	Snapshots (Auto, Premium Auto, BEST SHOT, HDR, HDR Art (One of three levels can be selected.), Slide Panorama), Single SR Quality; Single SR Zoom, Macro, Self-timer, Touch Shutter, Face Detection, Movies (STD, HD) (with monaural audio)
Monitor Screen	3.2-inch TFT color LCD (Super Clear LCD) 460,800 (960×480) dots Touch Screen
Viewfinder	Monitor Screen
Timekeeping Function	Built-in quartz digital clock Date and Time: Recorded with image data Auto Calendar: To 2049
World Time	162 cities in 32 time zones City name, date, time, summer time
External connection terminal	USB port (Hi-Speed USB compatible, USB charging) / AV output terminal (NTSC/PAL)
Microphone	Monaural
Speaker	Monaural
Power Requirements	Rechargeable lithium ion battery (NP-110) × 1

Approximate Battery Life

All of the values provided below represent the approximate amount of time under normal temperature (23°C (73°F)) before the camera turns off. These values are not guaranteed. Low temperatures shorten battery life.

Number of Shots (CIPA) (Operating Time)*¹	560 shots
Continuous Playback (Snapshots)*²	6 hours 00 minutes
Approximate continuous movie recording time*³	4 hours 00 minutes

- Battery: NP-110 (Rated Capacity: 1200 mAh)
- Recording Medium: 1GB SD memory card (PRO HIGH SPEED (Panasonic Corporation))
- Measurement Conditions

*1 Approximate number of shots (CIPA) (Operating Time)

In accordance with CIPA (Camera and Imaging Products Association) standards Normal temperature (23°C (73°F)), monitor on, zoom operation between full wide and full telephoto every 30 seconds, during which two images are shot with flash; power turned off and back on every time 10 images are shot.

*2 Approximate playback time

Standard temperature (23°C (73°F)), one-image scroll approximately every 10 seconds

*3 Approximate time using a 16GB SDHC memory card for a repeated cycle of 10 minutes recording followed by deletion of the recorded file.

- The above values are based a new battery, starting from a full charge. Repeated charging shortens battery life.
- Frequency of flash, zoom, and Auto Focus usage, and the time the camera is on greatly affects recording time and number of shots values.

Power Consumption	3.7 V DC, Approximately 3.2 W
Dimensions	97.0 (W) × 56.6 (H) × 22.6 (D) mm (3.8" (W) × 2.2" (H) × 0.9" (D)) (18.8 mm (0.74") thick excluding projections)
Weight	148 g (5.2 oz) (including battery and memory card) 121 g (4.3 oz) (excluding battery and memory card)

■ Rechargeable lithium ion battery (NP-110)

Rated Voltage	3.7 V
Rated Capacitance	1200 mAh
Operating Temperature Requirements	0 to 40°C (32 to 104°F)
Dimensions	37.5 (W) × 44.9 (H) × 7.0 (D) mm (1.48" (W) × 1.77" (H) × 0.28" (D)) (excluding projections)
Weight	Approximately 25 g (0.9 oz)

■ USB-AC adaptor (AD-C53U)

Input Power	100 to 240 V AC, 50/60 Hz, 100 mA
Output Power	5.0 V DC, 650 mA
Operating Temperature Requirements	5 to 35°C (41 to 95°F)
Dimensions	53 (W) × 21 (H) × 45 (D) mm (2.1" (W) × 0.83" (H) × 1.8" (D)) (excluding projections)
Weight	Approximately 37 g (1.3 oz)

- Power cord precautions for use in Singapore
The power cord set is not supplied. The power cord used must comply with relevant national and/or international standards.

CASIO®

CASIO COMPUTER CO.,LTD.
6-2, Hon-machi 1-chome
Shibuya-ku, Tokyo 151-8543, Japan

Dynamic Photo™

Getting the Most Out of Dynamic Photo

Dynamic Photo
Special Site

For a wealth of information about Dynamic Photo including explanations about how to use Dynamic Photo images, the Dynamic Studio image conversion service, sample images, and more, visit the special Dynamic Photo website at:

<http://dp.exilim.com/>

This manual provides an introduction to Dynamic Photo, which creates a whole new way to enjoy digital imaging.

- All screen shots shown in this manual are in English. However, the camera allows you to select another display language, if you want.

Contents

Dynamic Photo! A totally new way to enjoy digital photography!	2
Creating a Dynamic Photo Image	3
Step 1: Shoot the image into which you want to insert an built-in subject	3
Step 2: Create the Dynamic Photo image.	3
Step 3: Have fun with Dynamic Photo.	6
Step 4: Convert a Dynamic Photo Still Image to a Movie (Movie Converter).	6
Step 5: Use Dynamic Studio to expand use of Dynamic Photo images to other applications. ..	7

Dynamic Photo! A totally new way to enjoy digital photography!

Dynamic Photo provides an easy way to insert built-in subjects into snapshots and movies for a whole new way to enjoy digital imaging.

You can create a Dynamic Photo image by inserting a built-in moving subject into a background image (snapshot or movie). Before performing the following steps, you should record the background image (snapshot or movie) into which you want to insert the moving subject.

- The term “built-in subjects” refers to the moving figures and characters that came pre-programmed in the camera’s built-in memory.

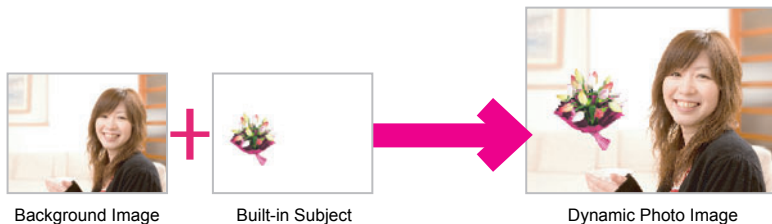

Creating a Dynamic Photo Image

Your digital camera comes with a number of subjects in its built-in memory ("built-in subjects"). You can use these built-in subjects to create Dynamic Photo images by inserting them into your original snapshots or movies.

Step 1: Shoot the image into which you want to insert a built-in subject.

1. In the REC mode, compose the image and press the shutter button to shoot a standard snapshot.

You will insert the built-in subject into the snapshot you shoot here.



Step 2: Create the Dynamic Photo image.

Now simply insert a built-in subject into the snapshot or movie you shot in step 1 to create your own original Dynamic Photo image.

1. Press [▶] (PLAY) or touch "⏮" (PLAY) to enter the PLAY mode.

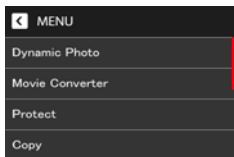

2. Touch "MENU" and then "Dynamic Photo".

- If "MENU" is not displayed on the screen, touch the tab to display it.

3. Touch "<" or ">" or drag left or right to select the background image, and then touch "OK".

Select the image you want to use as the background. Here, select the image you recorded in step 1 of this procedure.

- * Only images that are able to be used as background images will appear for selection at this time.
- Only an image that satisfies the following conditions can be used as a background image.
 - A snapshot or movie recorded with this camera or a snapshot transferred to this camera's memory using Photo Transport
 - A snapshot with an aspect ratio of 4:3



4. Touch “<” or “>” or drag left or right to select the built-in subject sample you want to insert, and then touch “OK”.

* Only built-in subjects that can be inserted into other images will appear at this time.



5. If you are inserting a subject into a movie, use “◀” and “▶” to configure the time zone in the movie where you want the subject to appear, and then touch “OK”.

- If you insert a subject into a movie, the resulting movie will be a maximum of 20 seconds long. Everything before and after the insertion is cut off. If the movie you are inserting into (original movie) is shorter than 20 seconds, the resulting movie will be the same length as the original movie.

- If you are inserting a subject into a snapshot, skip directly to step 6.



Insert location

6. Use the zoom controller to adjust the size of the subject and drag the subject to change its location on the screen, and then touch “OK”.

This inserts the subject into another image and creates a Dynamic Photo.

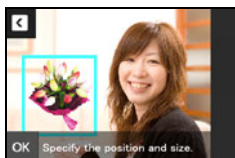

7. After creation of the Dynamic Photo image is complete, the finished image will appear on the monitor screen.



Complete!

- Inserting a built-in subject into a snapshot will save a Dynamic Photo that consists of 20 still images of 2M size or smaller.
- Inserting a built-in subject into a movie will save the Dynamic Photo as a movie file.

Important!

- Performing a delete or format operation will not delete the built-in subjects.

Step 3: Have fun with Dynamic Photo.

You can use the Dynamic Photo image you created in Step 2 in a variety of fun ways.



On the camera

Dynamic Photo images play back automatically as soon as you display them on the EXILIM monitor screen.



On a TV

Connect your EXILIM to a TV with the AV cable and you can enjoy watching Dynamic Photo images on your TV screen.



Step 4: Convert a Dynamic Photo Still Image to a Movie (Movie Converter).

A Dynamic Photo with a still image background and a moving subject is stored as a series of 20 still images. You can use the following procedure to convert the 20 images that make up a Dynamic Photo to a movie.

1. Press **[▶]** (PLAY) or touch “**▶**” (PLAY) to enter the PLAY mode.
2. Drag left or right to display the Dynamic Photo you want to convert to a movie.
3. Touch “MENU”.
4. Touch “Movie Converter”.
 - The final movie format is Motion JPEG.
 - The final movie image size is 640×480 pixels.
5. Save the converted Dynamic Photo to your computer.

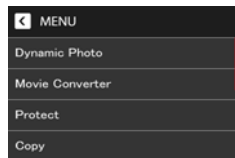

Step 5: Use Dynamic Studio to expand use of Dynamic Photo images to other applications.

<http://dynamicstudio.jp/>

Using the CASIO EXILIM Dynamic Photo feature to create a Dynamic Photo image with a moving subject produces a CS image that reproduces the movement of the character. Dynamic Studio is a free online service that lets you convert the CS image to a movie file for playback on a PC, digital photo frame, cell phone, or other device. Now you can enjoy your Dynamic Photo images on a virtually unlimited number of different devices.

* Dynamic Studio service availability and content are subject to change without notice.

Dynamic Studio

Dynamic Photo Data Conversion Service

On a PC

Enjoy watching Dynamic Photo images on your PC screen.



In a digital photo frame

Play Dynamic Photo images in a digital photo frame.



On a cell phone

View Dynamic Photo images on your cell phone screen.

Share with your friends

Send the Dynamic Studio URL to your friends and share your Dynamic Photo creations with them.



e-Greeting Cards

Send animated e-greeting cards to your special friends and family members.

For presentations

Animation GIF files can be included in presentation data for an impression that really lasts.



Free Manuals Download Website

<http://myh66.com>

<http://usermanuals.us>

<http://www.somanuals.com>

<http://www.4manuals.cc>

<http://www.manual-lib.com>

<http://www.404manual.com>

<http://www.luxmanual.com>

<http://aubethermostatmanual.com>

Golf course search by state

<http://golfingnear.com>

Email search by domain

<http://emailbydomain.com>

Auto manuals search

<http://auto.somanuals.com>

TV manuals search

<http://tv.somanuals.com>