



CASIO^E

Handheld Terminal DT-X5 Series

User's Guide

Be sure to read "Safety Precautions" inside this guide before trying to use your Handheld Terminal. After reading this guide, keep it in a safe place for future reference.



PN410388-002



- This product includes BRYCEN Co., Ltd' s B-RAPPORE Stack, which use is governed by a licence granted by BRYCEN Co., Ltd.

 **Bluetooth™**

- BLUETOOTH is a trademark owned by Bluetooth SIG, Inc. and licensed to CASIO COMPUTER CO., LTD.
- Microsoft and Windows are either registered trademarks or trademarks of Microsoft Corporation in the United States and/or other countries.
- Datalight is a registered trademark of Datalight, Inc.
- FlashFX™ is a trademark of Datalight, Inc.
Copyright 1993-2000 Datalight, Inc., All Rights Reserved.
U.S. Patent Office 5,860,082
- Other company names and product names used in this guide are trademarks or registered trademarks of their respective owners.





Safety Precautions

Congratulations upon your selection of this CASIO product. Be sure to read the following Safety Precautions before trying to use it for the first time.

Markings and Symbols

The following are the meanings of the markings and symbols used in these Safety Precautions.



Danger

This symbol indicates information that, if ignored or applied incorrectly, creates the danger of death or serious personal injury.



Warning

This symbol indicates information that, if ignored or applied incorrectly, creates the possibility of death or serious personal injury.



Caution

This symbol indicates information that, if ignored or applied incorrectly, creates the possibility of personal injury or property damage.



• A diagonal line indicates something you should not do. The symbol shown here indicates you should not try to take the unit apart.



• A black circle indicates something you should do. The symbol shown here indicates you should unplug the unit from the wall outlet.

Precautions During Use



Warning

Disassembly and Modification



• Never try to disassemble or modify the Handheld Terminal and its options in any way. High voltage inside creates the danger of electric shock.

Abnormal Conditions



• Should the Handheld Terminal and its options become hot or start to emit smoke or a strange odor, immediately turn off the power, and contact your original vendor or an authorized CASIO service provider. Continued use creates the danger of fire and electric shock.



Safety Precautions

Warning

Foreign Objects

-  Should any foreign matter get into the Handheld Terminal and its options, immediately turn off the power and contact your original vendor or an authorized CASIO service provider. Continued use creates the danger of fire and electric shock.

Dropping and Damage

-  Should you drop the Handheld Terminal and its options and damage them, immediately turn off the power and contact your original vendor or an authorized CASIO service provider. Continued use creates the danger of fire and electric shock.

Moisture

-  Though your Handheld Terminal is water splash-resistant, its Cradle and other optional peripherals are not. Keep loose metal objects and containers filled with liquids away from your Handheld Terminal and the optional peripherals.

Also, never connect or disconnect peripherals to the Handheld Terminal while they are wet. Water getting into the Handheld Terminal or its peripherals creates the danger of fire and electric shock.

Laser Light

-  This product scans bar codes using laser light. Never look directly into the laser light or shine the laser light into the eyes.



Caution

Foreign Objects

-  • Take care to ensure that metals or combustible objects are not inserted into the openings of the Handheld Terminal and its options. Such the objects inside of the Handheld Terminal and its options create the danger of fire and electric shock.

Location

-  • Do not locate the Handheld Terminal and its options on a surface that is unstable or uneven. Doing so creates the danger of the Handheld Terminal falling, which can cause personal injury.
- Do not locate the Handheld Terminal and its options in an area subject to large amounts of humidity or dust. Doing so creates the danger of fire and electric shock.
- Do not leave the Handheld Terminal and its options for a long period in a car parked in direct sunlight.

Heavy Objects

-  • Never place heavy objects on top of the Handheld Terminal and its options. Doing so creates the danger of loss of balance and the objects falling, which can cause personal injury.

LCD Screen

-  • Should the LCD panel glass break, never touch the liquid inside. Doing so can cause skin inflammation.
 - Should liquid from the LCD panel accidentally get into your mouth, immediately wash your mouth with water and then consult a physician.
 - Should liquid from the LCD panel accidentally get into your eyes or onto your skin, immediately rinse for at least 15 minutes with clean tap water and then consult a physician.

E-3



Operation of Wireless Data Communication Function

Warning

Interference with the Operation of Other Equipment (Using Wireless Data Communication Function)

-  Please follow the instructions provided by health care facilities when using your Handheld Terminal in hospitals or other locations where medical equipment is in use. In particular, either switch off the wireless data communication function of the Handheld Terminal or turn off the power in locations such as operating rooms, intensive care units, coronary artery disease monitoring units and other locations where use of the Handheld Terminal is prohibited by the health care facility. Radio waves emitted by the Handheld Terminal can affect the operation of medical equipment.
- Keep your Handheld Terminal at least 22 centimeters (8⁵/₈") away from anyone wearing a pacemaker. Radio waves emitted by the Handheld Terminal can affect the operation of a pacemaker.
- The use of wireless communication devices and electronic devices is prohibited by airlines depending on the flight status of the aircraft. Switch off the wireless data communication function of the Handheld Terminal while onboard an aircraft. Use of the Handheld Terminal can affect electronic devices used by the aircraft potentially causing a malfunction or accident.

Caution

Interference with the Operation of Other Equipment (Using Wireless Data Communication Function)

The Handheld Terminal contains a built-in wireless communication device of a low-power data communication system. The frequency band that is used is also used by microwave ovens and other industrial, scientific and medical devices, as well as other wireless stations of the same type, local wireless stations for identifying moving objects requiring licensing used on factory production lines and so forth, specified low-power wireless stations not requiring licensing, and amateur wireless stations (to be referred to as "other wireless stations").

- Confirm that other wireless stations are not in use nearby before using the Handheld Terminal.
- In the case radio wave interference has been generated between the Handheld Terminal and other wireless stations, either promptly change the location where the Handheld Terminal is used or discontinue operation of the equipment causing the interference.
- If other problems should occur as a result of the generation of radio wave interference, please contact the location indicated in the section on product consultations.

2.4 FH 2

This wireless transmitter uses the 2.4 GHz band. It employs the FH-SS modulation system and has an interfering range of 20 m.

2.4 DS 4

This wireless transmitter uses the 2.4 GHz band. It employs the DS-SS modulation system and has an interfering range of 40 m.

(DT-X5M10R/DT-X5M30R/DT-X5M30UR)

E-4















Alkaline Battery Handling Precautions

Danger

-  • Since there is the risk of blindness and other serious disorders when alkaline battery fluid enters the eyes, seek medical treatment immediately after adequately flushing the eyes with a large amount of tap water or other clean water without rubbing.

Warning





-  • Do not dispose of batteries in open flames or allow them to be heated, disassembled or modified. This results in the risk of damaging insulation and safety valves or causes the batteries to leak fluid, overheat or rupture.
-  • Do not reverse the (+) and (–) poles of the batteries. This results in the risk of abnormal reactions during charging or short-circuiting, or causes the batteries to leak fluid, overheating or rupture.
-  • Store batteries in a location out of the reach of small children. In the case a battery should happen to be swallowed, seek medical treatment immediately.
-  • In the case of having ingested alkaline battery fluid, gargle immediately and seek medical treatment.
-  • Since there is the risk of injury to the skin in the case alkaline battery fluid has come in contact with the skin or clothing, immediately rinse off with a large amount of tap water or other clean water.
-  • Do not allow the (+) and (–) poles of alkaline batteries to come in contact with wires or other metal objects, and do not carry or store them together with metal necklaces, hair pins and so on. This results in the risk of the batteries short-circuiting resulting in the flow of excess current and causing the batteries to leak fluid, overheat or rupture.
-  • Do not use a new battery with an old battery that has already been used or use different types of batteries. Differences in properties results in the risk of the batteries leaking fluid, overheating or rupturing.
-  • These batteries are not designed to be recharged. Recharging results in the risk of damage to insulation and internal structure causing the batteries to leak fluid, overheat or rupture.
-  • Do not remove or damage the battery outer label. This results in the risk of the batteries short-circuiting, leaking fluid, overheating or rupturing.
-  • Do not subject the batteries to strong impacts resulting from dropping or throwing. This results in the risk of the batteries leaking fluid, overheating or rupturing.
-  • Do not allow the batteries to be deformed or damaged. This results in the risk of damage to the insulation and safety valve causing the batteries to leak fluid, overheat or rupture.

E-5



Safety Precautions

Caution



-  • Promptly remove worn out batteries from the Handheld Terminal. Allowing worn out batteries to remain installed in the Handheld Terminal for a long period of time results in the risk of the generation of gas from the batteries causing the batteries to leak fluid, overheat or rupture.
- Remove the batteries from the Handheld Terminal when not using for a long period of time. Failure to do so results in the risk of the generation of gas from the batteries causing the batteries to leak fluid and damage the Handheld Terminal.
-  • Do not attempt to solder the batteries directly. This results in the risk of heat damaging the insulation and safety valve causing the batteries to leak fluid, overheat or rupture.
- Do not use or place the batteries in a location subject to high temperatures such as locations of intense direct sunlight or in an automobile on a hot day. This results in the risk of the batteries leaking fluid, overheating or rupturing.
-  • Insulate the ends of the batteries by covering with tape and so on when storing or disposing. Allowing the batteries to contact other batteries or metal objects results in the risk of the batteries leaking fluid, overheating or rupturing.
-  • Do not allow the batteries to become wet. This results in the risk of the batteries overheating.
-  • Avoid storing batteries in locations subject to direct sunlight, high temperature or high humidity. This results in the risk of the batteries leaking fluid. In addition, there is also the risk of reduced battery performance and shorter battery life.
- Although these batteries may be disposed of in the same manner as ordinary non-burnable garbage, please dispose of them in the proper manner in accordance with the rules and regulations of your local community when applicable.

E-6



Optional Lithium-ion Battery Pack

Danger



-  • Never allow the battery pack to become wet. Water can create the danger of battery pack heat emission, explosion, and fire.
- Never use or leave the battery pack next to open flame, near a stove, or any other area exposed to high heat. Doing so creates the danger of battery pack heat emission, explosion, and fire.
- Never use the battery pack with any device other than the Handheld Terminal. Doing so can create the danger of battery pack heat emission, explosion, and fire.
- Note that the battery pack's positive (+) and negative (-) polarities must be oriented correctly when it is loaded into battery charger or the Handheld Terminal. Connecting the battery pack with its polarities reversed creates the danger of battery pack fluid leakage, heat emission, explosion, and fire.
- Never dispose of the battery pack by incinerating it or otherwise expose it to heat. Doing so creates the danger of battery pack heat emission, explosion, and fire.
- Never allow the positive (+) and negative (-) terminals of the battery pack to become connected (shorted) by metal. Doing so creates the danger of battery pack heat emission, explosion, and fire.
- Never transport or store the battery pack together with a necklace, hair pins or other metal objects. Doing so can short battery pack terminals, creating the danger of battery pack heat emission, explosion, and fire. Be sure to place the battery pack in its case whenever transporting or storing it.
- Never throw the battery pack or otherwise subject it to strong impact. Doing so creates the danger of battery pack heat emission, explosion, and fire.
- Never pierce the battery pack with nails, hit it with a hammer, or step on it. Doing so can create the danger of battery pack heat emission, explosion, and fire.
- Never try to take apart the battery pack or modify it in any way. Doing so creates the danger of battery pack heat emission, explosion, and fire.
-  • Use only the specified battery charger to charge the battery pack. Use of other type of battery charger creates the danger of battery pack heat emission, explosion, and fire.

E-7





Safety Precautions

Warning

-  • Never place the battery pack in a microwave oven or any other high-voltage device. Doing so creates the danger of battery pack heat emission, explosion, and fire.
- Should the battery pack emit a strange odor or heat, change color or shape, or exhibit any other abnormal behavior, immediately stop using it. Continued use creates the danger of battery pack heat emission, explosion, and fire.
-  • If the battery pack does not achieve full charge after the normal charging time has passed, stop charging it. Continued charging creates the danger of battery pack heat emission, explosion, and fire.
- Should the battery pack start to leak or emit a strange odor, immediately move it away from flame. Leaking battery fluid is combustible, and exposure to flame creates the danger of explosion and fire.
- Should fluid from the battery pack accidentally get into your eyes, do not rub them. Immediately rinse your eyes with clean tap water and then consult a physician immediately.

Caution



-  • Never use or leave the battery pack in an area exposed to direct sunlight, in a car parked in direct sunlight, or any other very hot area. Doing so creates the danger of heat emission and fire, as well as deterioration of battery pack performance and shortening of its service life.
- Do not use the battery pack in areas where static electricity is being generated. Doing so creates the danger of battery pack heat emission, explosion, and fire.
-  • Danger of explosion if the battery pack is incorrectly replaced. Replace only with same or equivalent type recommended by CASIO. Dispose of used batteries according to the CASIO instruction.
- Should fluid from the battery pack accidentally get onto clothing or your skin, immediately rinse it off with clean tap water. Prolonged contact with battery pack fluid can cause skin irritation.
- Keep the battery pack out of the reach of small children. Do not let small children remove the battery pack from battery charger or the Handheld Terminal while it is powered on.

E-8





AC Power Supply

Warning

-  Do not use the Handheld Terminal at a voltage other than the specified voltage. Also, do not connect the Handheld Terminal to a multi-plug power strip. Doing so creates the danger of fire and electric shock.
- Avoid conditions that can cause damage or breaks in the power cord. Do not place heavy objects on the power cord and keep it away from sources of heat. Any of these conditions can damage the power cord, creating the danger of fire and electric shock.
- Never modify, sharply bend, twist, or pull on the power cord. Doing so creates the danger of fire and electric shock.
-  When using the battery charger, Cradle and Dual Battery Charger, be sure to use the respective AC adaptors. Use of other types of AC adaptors creates the danger of fire and electric shock.
- Should the power cord become severely damaged (to the point that wires are exposed or broken), contact your original vendor or an authorized CASIO service provider about repair or replacement. Use of a damaged electrical cord creates the danger of fire and electric shock.

Caution

-  Keep the power cord away from stoves and other sources of extreme heat. Heat can melt the covering of the power cord and create the danger of fire and electric shock.
- Never pull on the power cord when unplugging it. Doing so can damage the cord and create the danger of fire and electric shock. (Always hold the plug when unplugging it from the wall outlet.)
- Never touch the plug while your hands are wet. Doing so can create the danger of electric shock.
-  Be sure to unplug the power cord from the wall outlet before moving the battery charger, Cradle and Dual Battery Charger. Failure to do so can result in damage to the power cord caused by pulling it, which creates the danger of fire and electric shock.
- Be sure to unplug the power cord from the wall outlet before cleaning the battery charger and Cradle.
- Be sure to turn the power off and unplug the power cord after use.
- Unplug the power cord from the wall outlet whenever leaving the battery charger, Cradle and Dual Battery Charger unattended for a long period of time.

E-9



Safety Precautions

AC Adaptor

Caution



- The housing of the AC adaptor can become warm during normal use.



- Take normal precautions against electric shock.



- At least once a year, unplug the AC adaptor from the wall outlet and clean any dust that builds up between the prongs of the plug.

Dust built up between the prongs can lead to the danger of fire.

Backup Copies of All Important Data

Caution



- Note that CASIO Computer Co., Ltd. shall not be held liable to you or any third party for any damages or loss caused by deletion or corruption of data due to use of the Handheld Terminal, malfunction or repair of the Handheld Terminal or its peripherals, or due to the batteries going dead.

- The Handheld Terminal employs electronic memory to store data, which means that memory contents can be corrupted or deleted if power is interrupted due to the batteries going dead or incorrect battery replacement procedures. Data cannot be recovered once it is lost or corrupted. Be sure to make backup copies of all important data.



Operating Precautions

Your Handheld Terminal and its options are precision digital instruments. Improper operation or rough handling can cause problems with data storage and other problems. Note and observe the following precautions to ensure proper operation.

- **Do not continue operating the Handheld Terminal when battery power is low.**
Doing so can cause data to be lost or altered. If the batteries become worn down, either promptly replace them with new AA size alkaline batteries or charge the battery pack.
- **Do not leave dead batteries in the Handheld Terminal for a long period.**
Dead batteries can leak, leading to malfunction and damage to the Handheld Terminal.
- **Use the Handheld Terminal and its options only within the specified temperature range.**
Use outside of the specified temperature range creates the risk of malfunction.
- **Avoid using the Handheld Terminal and its options in areas subject to the following conditions.**
Doing so can damage the Handheld Terminal or cause it to malfunction.
 - Large amounts of static electricity
 - Extreme heat or extreme cold
 - High humidity
 - Sudden temperature extremes
 - Large amounts of dust
- **Never use thinner, benzene, cosmetic cleaning fluids, or other volatile agents to clean the Handheld Terminal.**
To clean the Handheld Terminal, wipe it with a dry cloth or cloth moistened with neutral detergent diluted with water. Wring all excess moisture from the cloth before wiping.



Important

- The contents of this guide are subject to change without notice.
- Note that CASIO COMPUTER CO., LTD. shall not be held liable to you or any third parties for any losses or damages arising from the use of this guide.
- Although the utmost care has been taken in preparing this manual, please contact the manufacturer if you should happen to notice any inconsistencies or errors.
- This guide does not include any information about programming and download procedures. See the applicable separate documentation for information about the procedures.

Warranty and After Service

- Should this product ever malfunction, contact your original retailer providing information about the product name, the date you purchased it, and details about the problem.



E-12





GUIDELINES LAID DOWN BY FCC RULES FOR USE OF THIS UNIT IN THE U.S.A. (not applicable to other areas).

NOTICE

This equipment has been tested and found to comply with the limits for a Class B digital device, pursuant to Part 15 of the FCC Rules. These limits are designed to provide reasonable protection against harmful interference in a residential installation. This equipment generates, uses and can radiate radio frequency energy and, if not installed and used in accordance with the instructions, may cause harmful interference to radio communications. However, there is no guarantee that interference will not occur in a particular installation. If this equipment does cause harmful interference to radio or television reception, which can be determined by turning the equipment off and on, the user is encouraged to try to correct the interference by one or more of the following measures:

- Reorient or relocate the receiving antenna.
- Increase the separation between the equipment and receiver.
- Connect the equipment into an outlet on a circuit different from that to which the receiver is connected.
- Consult the dealer or an experienced radio/TV technician for help.

FCC WARNING

Changes or modifications not expressly approved by the party responsible for compliance could void the user's authority to operate the equipment.

Proper connectors must be used for connection to host computer and/or peripherals in order to meet FCC emission limits.

Peripherals and Cables

AC Adaptor (AD-S42120A)

Cables (DT887AXA, DT888RSC, DT-380USB)

Declaration of Conformity

Model Numbers: DT-X5M30U, DT-X5M30UR, HA-A61IO, HA-A60IO, HA-A30CHG

Trade Name: CASIO

Responsible party: CASIO, INC.

Address: 570 Mt. Pleasant Avenue, Dover, New Jersey 07801

Telephone number: 973-361-5400

This device complies with Part 15 of the FCC Rules. Operation is subject to the following two conditions:

(1) This device may not cause harmful interference, and (2) this device must accept any interference received, including interference that may cause undesired operation.

E-13



Important

We, the undersigned.

Company	CASIO Europe GmbH
Address, City	Bornbarch 10, D-22848 Norderstedt
Country	Germany
Phone number	+49(0)40-528-65-0
Fax number	+49(0)40-528-65-424

certify and declare under our sole responsibility that the following equipments:

Product description / Intended use	
EU/EFTA member states intended for use	EU: Austria, Belgium, Denmark, Finland, France, Germany, Greece, Ireland, Italy, Luxembourg, The Netherlands, Portugal, Spain, Sweden, United Kingdom EFTA: Switzerland, Iceland, Lichtenstein, Norway
Member states with restrictive use	NONE
Manufacturer	CASIO COMPUTER CO., LTD.
Brand	CASIO
Type	DT-X5M10E, DT-X5M10R, DT-X5M30E, DT-X5M30R, DT-X5M30U, DT-X5M30UR,

are tested and found to conform with the essential requirements for protection of health and the safety of the user and any other persons and Electromagnetic Compatibility, as included in following standards:

Standard	Issue date
EN60950:2000	2002-02
EN301 489-1,	2002-08
EN301 489-17	2002-08

and are tested and found to conform with the essential radio test suites so that they effectively use the frequency spectrum allocated to terrestrial/space radio communication and orbital resources so to as to avoid harmful interference, as included in following standards:

DT-X5M10E;

Standard	Issue date
EN300 328-1	2001-12
EN300 328-2	2001-12

and therefore comply with the essential requirements and provisions of the **Directive 1999/5/EC** of the European Parliament and of the council of March 9, 1999 on Radio equipment and Telecommunications Terminal Equipment and the mutual recognition of their conformity and with the provisions of Annex III (Conformity Assessment procedure referred to in article 10).

DT-X5M10R;

Standard	Issue date
EN300 328-1	2001-12
EN300 328-2	2001-12
EN50360	2001-07
EN50361	2001-09

and therefore comply with the essential requirements and provisions of the **Directive 1999/5/EC** of the European Parliament and of the council of March 9, 1999 on Radio equipment and Telecommunications Terminal Equipment and the mutual recognition of their conformity and with the provisions of Annex IV (Conformity Assessment procedure referred to in article 10).

E-14



The following Notified Body has been consulted in the Conformity Assessment procedure.

Notified Body number	Name and Address
0560	TELEFICATION B.V., Utrechtseweg 310 - P.O. Box 60004, NL-6800 JA ARNHEM, The Netherlands

The technical documentation as required by the Conformity Assessment procedure is kept at the following address:

Company	CASIO Europe GmbH
Address, City	Bornbarch 10, D-22848 Norderstedt
Country	Germany
Phone number	+49(0)40-528-65-0
Fax number	+49(0)40-528-65-424

Products are for distribution within all member states of the EU.

DT-X5M10E/DT-X5M30E/DT-X5M30U; DT-X5M10R/DT-X5M30R/DT-X5M30UR;



The information described above dates from May 2004 and maybe subjected to future changes.



Contents

Safety Precautions	1
Operating Precautions	11
Important	12
Warranty and After Service	12
Before Getting Started	18
When unpacking, make sure that all items are included.	18
Install the main battery.	19
When Using the AA size Alkaline Batteries	19
When Using the Battery Pack	20
Turning On the Power	21
Handheld Terminal System Configuration	22
General Guide	25
Replacing the Battery	27
Replacing the Battery Pack	27
Replacing the AA size Alkaline Batteries	28
To replace the battery pack	29
Loading the large-capacity battery pack into the Handheld Terminal	31
Removing and Installing the Alkaline Battery Holder	32
Removal Procedure	32
Installation Procedure	33
Attaching the Wrist Strap	34
Configuring Handheld Terminal Settings	35
Adjusting Display Contrast	35
Turning Backlight On and Off	35
Using the Laser Scanner	36
Warning Label	37
Bar Code Scanning Position	37
Using the C-MOS Imager	38
Warning Label	39
Adjusting Laser Emission Width	40
Emission Width Adjustment Bar code	41
Performing Communication	42
IR Communication	42
Bluetooth™ Communication	43



Resetting the Handheld Terminal	44
Reset and Full Reset (Memory Initialization)	44
Reset	44
Performing a Full Reset (Initialization)	44
To perform a reset	44
If reset does not find a memory problem	44
If reset finds a memory problem	45
To perform a full reset	45
DT-X5 Specifications	46
Using the Bridge Satellite Cradle (HA-A61IO)/	
Bridge Basic Cradle (HA-A60IO)	49
General Guide	49
Connecting the AC Adaptor and Connecting to Computer	51
Removing the Fall Protector	53
Configuring DIP Switch Settings (HA-A61IO)	54
Using Wall Mount Unit	55
To remove the Bridge Satellite Cradle/Bridge Basic Cradle from the wall	56
Connecting Multiple Bridge Satellite Cradles (HA-A61IO)	57
Bridge Satellite Cradle (HA-A61IO)/Bridge Basic Cradle (HA-A60IO) Specifications	58
Using the Cradle-type Battery Charger	59
General Guide	59
Connecting the AC Adaptor for Cradle-type Battery Charger	61
Using Wall Mount Unit	62
Removing the Fall Protector	62
Cradle-type Battery Charger (HA-A30CHG) Specifications	62
Using the Dual Battery Charger	63
General Guide	63
Charging a Battery Pack	65
Charge Indicator Lamp	65
Connecting Multiple Dual Battery Chargers	66
Dual Battery Charger (DT-5022CHG) Specifications	67
Using Rechargeable Battery Pack	68
Battery Pack Specifications	68
Large-capacity Battery Pack Specifications	68

Before Getting Started

Be sure to perform the following steps before using the Handheld Terminal for the first time.



- Using the AA size alkaline batteries
- Using the battery pack (charging required)

When unpacking, make sure that all items are included.

Open the box and make sure that all the items shown here are included.

Handheld Terminal



AA size Alkaline Batteries
(DT-X5M10E/DT-X5M30E/DT-X5M30U only)

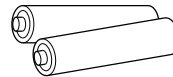

Wrist Strap

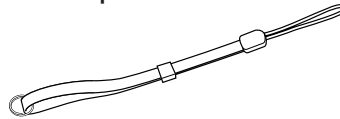

Large-capacity battery pack Cover

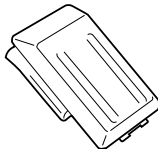

User's Guide (this manual)





Install the main battery

When Using the AA size Alkaline Batteries (DT-X5M10E/DT-X5M30E/DT-X5M30U only)

1. Install the AA size alkaline batteries.

- ① Slide the two main battery cover lock switches on both sides of the Handheld Terminal to the “FREE” position, and remove the main battery cover.

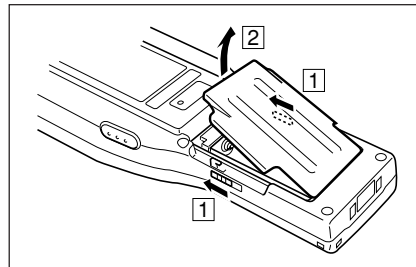

- ② Install the AA size alkaline batteries. Make sure the batteries are aligned properly.

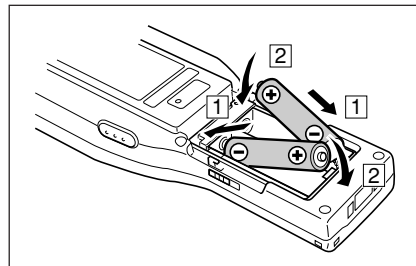

- ③ Return the main battery cover to its original position as shown in the illustration, and return the two main battery pack cover lock switches to the “LOCK” position.

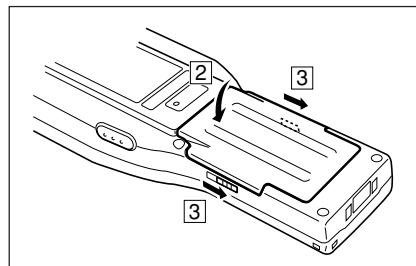
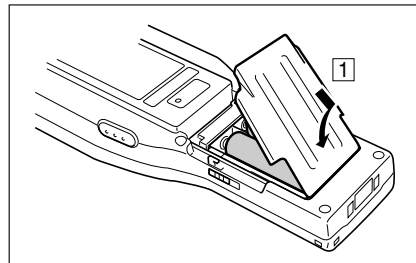

E-19



Before Getting Started

When Using the Battery Pack

Charging is required when using the battery pack (HA-A20BAT or DT-5025LBAT) sold separately.

Use the Dual Battery Charger when charging the battery pack before installing in the Handheld Terminal, or use the Cradle-type Battery Charger or Cradle to charge after installing in the Handheld Terminal.

1. Remove the alkaline battery holder if it is installed.
Refer to page 32 for information on removing the alkaline battery holder.
2. Use the Dual Battery Charger when charging the battery pack in advance.
Refer to page 65 for information on the charging procedure.
3. Load the battery pack into the Handheld Terminal.

- ① Slide the two main battery cover lock switches on both sides of the Handheld Terminal to the "FREE" position, and then remove the main battery cover.

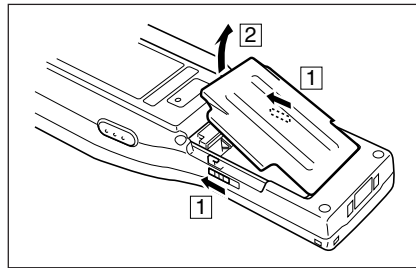

- ② Load a battery pack (HA-A20BAT) or a large-capacity battery pack (DT-5025LBAT).
 - Take care that the battery pack is oriented correctly when you load it.
 - Install the battery pack so that the battery pack removal tape is on top of the battery pack.

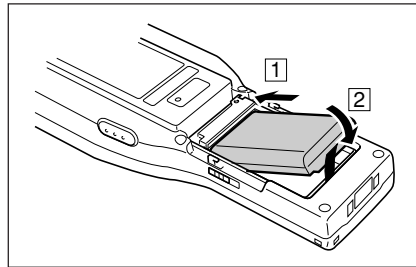



- ③ Return the main battery cover to its original position as shown in the illustration, and return the two main battery pack cover lock switches to the “LOCK” position.

When loading a large-capacity battery pack, attach the large-capacity battery pack cover.

- Make sure the battery pack removal tape is bent to the inside so as not to be pinched by the cover.

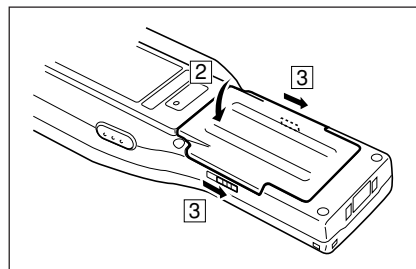
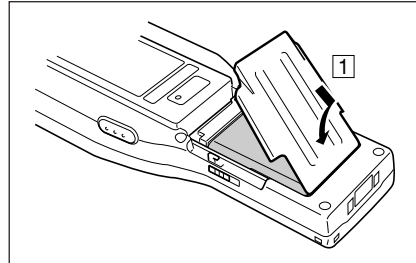

4. Use the Cradle-type Battery Charger or Cradle when charging the battery charger after installing in the Handheld Terminal. Refer to pages 50 and 60 for information on the charging procedure.

Turning On the Power

1. Turn on the Handheld Terminal by holding down the power key for about one second after waiting about 5 seconds after installing the main battery. Start up the application you want to run.

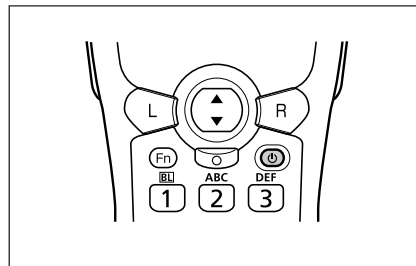



Handheld Terminal System Configuration

Options

Bridge Satellite Cradle (HA-A61IO) Bridge Basic Cradle (HA-A60IO)

HA-A60IO
HA-A61IO

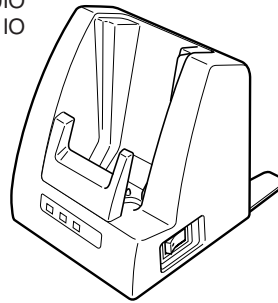

DT-X5 Series



Cradle-type Battery Charger

HA-A30CHG

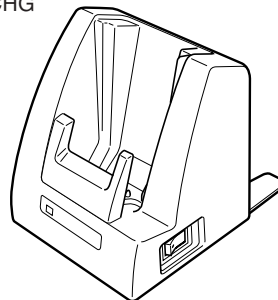

Laser Scanner models
The laser scanner models are not available in the USA and Canada.

- DT-X5M10E
- DT-X5M10R

C-MOS Imager models

- DT-X5M30E
- DT-X5M30R
- DT-X5M30U
- DT-X5M30UR

Required AC Adaptor for Bridge Satellite Cradle/ Bridge Basic Cradle/Cradle-type Battery Charger

AD-S42120A

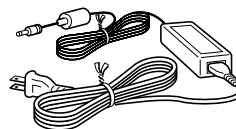

E-22





Wall Mount Unit

DT-891WH

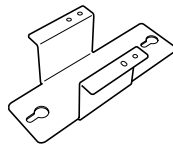

Required
Screws



Battery Pack

HA-A20BAT
(Battery Pack)

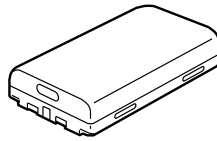

DT-5025LBAT
(Large-capacity Battery Pack)

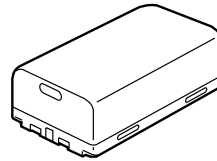

Dual Battery Charger

DT-5022CHG

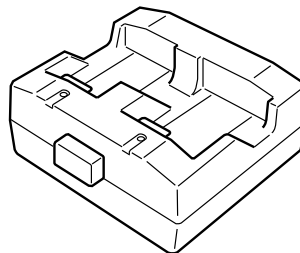

Required AC Adaptor
(MPC-577ADP)

E-23



Handheld Terminal System Configuration

Cables

DT-887AXA	Bridge Satellite Cradle Cable/RS-232C Dsub-9Pin (Female)
DT-888RSC	RS-422 Modular Cable
DT-380USB	USB Cable

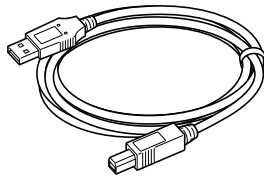

E-24



General Guide

Left

Front

Right

Back

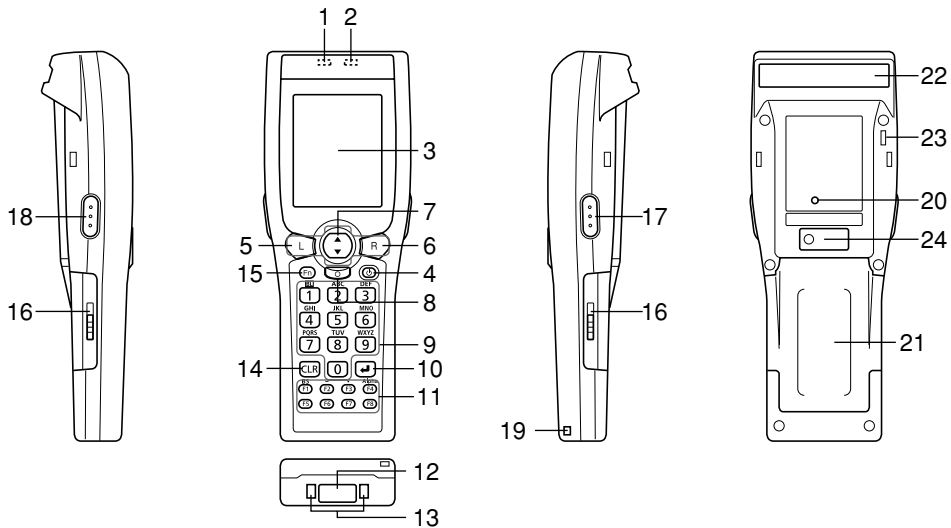

Bottom

*The illustration shows the Laser Scanner model.

1	Indicator 1	This indicator is green when charging is completed, and red during charging.
2	Indicator 2	This indicator is green when the bar code has been read successfully, and red when a reading error has occurred.
3	LCD Panel	Displays text, operating instructions and so forth.
4	Power Key	Switches the power on and off (press for about 1 second).
5	L Key	This is pressed to move the cursor to the left.
6	R Key	This is pressed to move the cursor to the right.
7	Cursor Key	This functions in mainly the same manner as the cursor keys on a PC. It is used when selecting items or scrolling the screen up and down and so on.
8	Multi Key	This can be set to perform arbitrary functions.
9	Numeric Keys	These are pressed to input numbers and letters.
10	Execute Key	This is pressed after entering a value or when advancing to the next step.

E-25



General Guide

11	Function Keys	These can be assigned arbitrary functions other than functions for reading bar codes. They are initially assigned the following default settings. F1: Deletes one character to the left. F2: Inputs a hyphen (-). F3: Inputs a period (.). F4: Switches character input (between numbers and alphabets (upper case)). F5: Inputs a space. F6: Functions similar to the Tab key on a PC. Used to move items for input or selection. F7: Functions similar to the Tab key on a PC. Used to move items for input or selection (but moves the opposite to F6). F8: Not set.
12	IR Port	This port is used for IR communication with another Handheld Terminal or with the Bridge Satellite Cradle/Bridge Basic Cradle.
13	Power Contacts	These are used to supply power from the Bridge Satellite Cradle/Bridge Basic Cradle and Cradle-type Battery Charger.
14	CLR Key	This is pressed to clear the contents of all key inputs.
15	Fn Key	This is used to make various settings or start up preliminary registered applications by sequentially pressing in combination with a function key (F1 to F8) or numeric key (0 to 9). The following examples show the combinations with the numeric keys. Fn + 1: Switches backlight on and off. Fn + 2: Darkens contrast. Fn + 3: Lightens contrast.
16	Main Battery Cover Lock Switches	Slide these switches when opening and closing the main battery cover.
17	R Trigger Key	This key is used to read bar codes. It is also pressed when performing a full reset.
18	L Trigger Key	This key is used to read bar codes. It is also pressed when canceling a full reset.
19	Wrist Strap Hook	This is used when attaching the wrist strap.
20	Reset Switch	This is pressed to reset the Handheld Terminal.
21	Main Battery Cover	Covers the compartment that holds the battery pack or AA size alkaline batteries.
22	Bar code Reader Port	Laser light is emitted from this. Reads bar codes (Laser Scanner models) Reads bar codes and stacked 2D codes (C-MOS Imager models)
23	Buzzer	Produces a buzzer tone.
24	Maintenance Connector Cover	This is used when performing maintenance and repairs. This cover should normally not be opened.

E-26





Replacing the Battery

Your Handheld Terminal uses two types of battery: main battery and a memory backup battery.

AA size alkaline batteries (DT-X5M10E/DT-X5M30E/DT-X5M30U) or the battery pack is used for the main battery. There are two types of battery packs that can be used, consisting of the battery pack (HA-A20BAT) and the large-capacity battery pack (DT-5025LBAT).

The backup battery is installed inside of the Handheld Terminal.

This guide uses the following terms to refer to the batteries.

- Main battery: Alkaline batteries or battery pack for operation.
Backup battery: Memory backup battery contained within the Handheld Terminal.
Battery pack: Generic name for the battery pack (HA-A20BAT) and large-capacity battery pack (DT-5025LBAT) used for the main battery.

If the main battery becomes worn down, either replace with new AA size alkaline batteries, promptly charge the battery pack or replace with a charged battery pack. You can use the Dual Battery Charger, the Cradle-type Battery Charger, or the Bridge Satellite Cradle/Bridge Basic Cradle to charge a battery pack. See the sections of this guide that cover the Dual Battery Charger, the Cradle-type Battery Charger, and the Bridge Satellite Cradle/Bridge Basic Cradle for information about how to use them for charging.

Replacing the Battery Pack

Important!

Always keep backup copies of all important data!

- The main battery powers normal operation and also provides power required to maintain memory contents, while the backup battery provides backup power to maintain memory contents. Because of this, you should not remove the main battery while the backup battery is dead. Removing the battery pack while the backup battery is dead causes data in the memory to be corrupted or lost. Note that once data is lost it cannot be recovered. Always keep separate backup copies of all important data.
- The charge of a battery pack when you purchase it may be depleted due to testing at the factory or natural discharge during shipment and storage. Be sure to charge the battery pack before you use it.
- The life of a battery pack is limited, and charging a battery pack causes it to gradually lose its ability to maintain the charge. If your battery pack seems to require charging very frequently, it probably means it is time to purchase a new one.
- The backup battery achieves a full charge in about four days when the battery pack is loaded.
- A fully charged backup battery can maintain memory (RAM) contents for about three days, even when the main battery is removed.
- When using batteries for the main battery, always make sure to use AA size alkaline batteries.

E-27



Replacing the Battery

Replacing the AA size Alkaline Batteries (DT-X5M10E/DT-X5M30E/ DT-X5M30U only)

1. Make sure the Handheld Terminal is turned off.
If the power is on, press the power key to turn it off.
2. Turn over the Handheld Terminal.

3. Slide the two main battery cover lock switches on both sides of the Handheld Terminal to the "FREE" position, and remove the main battery cover.

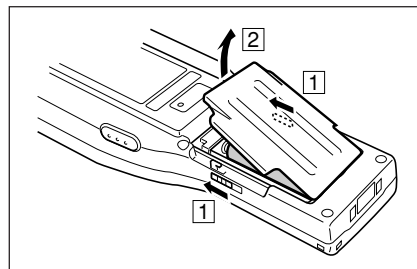

4. Remove the AA size alkaline batteries as shown in the illustration.

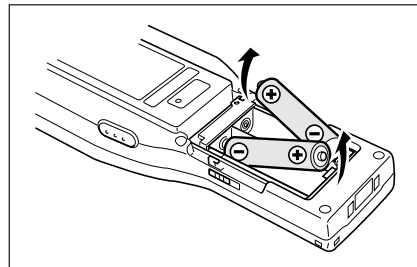

5. Install the new AA size alkaline batteries while making sure the batteries are aligned properly.

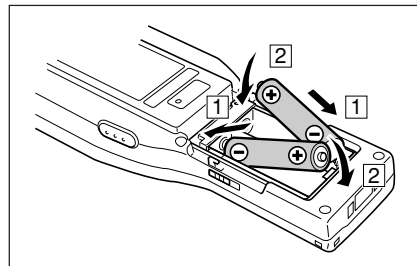

E-28



6. Return the main battery cover to its original position as shown in the illustration, and return the two main battery cover lock switches to the "LOCK" position.

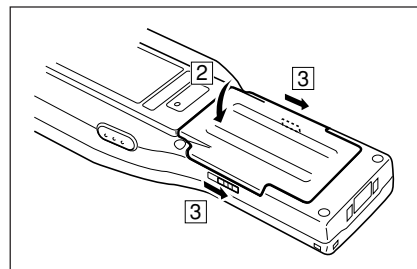
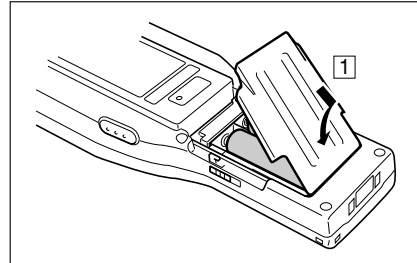

To replace the battery pack

1. Make sure that the Handheld Terminal is turned off.
If the power is on, press the power key to turn it off.
2. Turn over the Handheld Terminal.
3. Slide the two main battery cover lock switches on both sides of the Handheld Terminal to the "FREE" position, and remove the main battery cover.

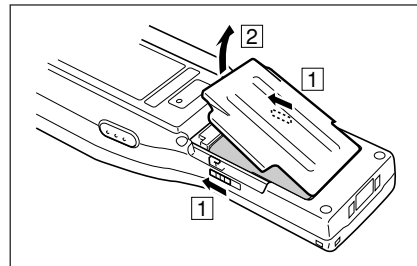

E-29



Replacing the Battery

4. Remove the battery pack by pulling up on the battery pack removal tape.

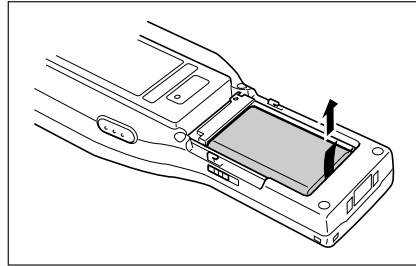

5. Install a charged battery pack in the Handheld Terminal.

- Take care to ensure it is oriented correctly.
- Install the battery pack so that the battery pack removal tape is on top of the battery pack.

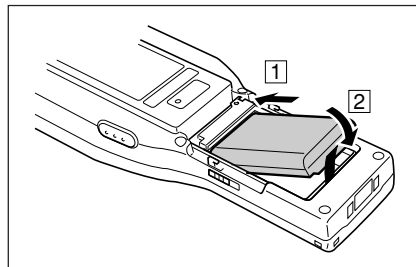

6. Return the main battery cover to its original position as shown in the illustration, and return the two main battery pack cover lock switches to the "LOCK" position.

- Make sure the battery pack removal tape is bent to the inside so as not to be pinched by the main battery cover.

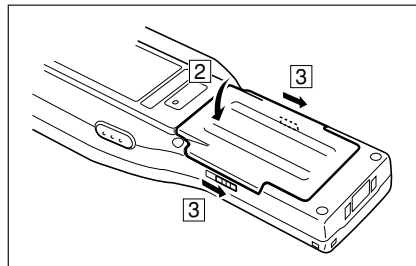
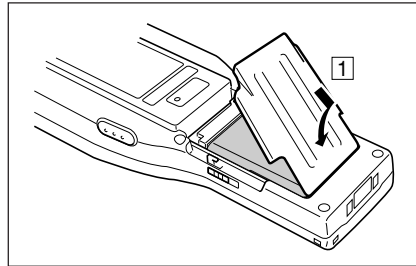

E-30



Loading the large-capacity battery pack into the Handheld Terminal

After loading the large-capacity battery pack, you need to use the special large-capacity battery pack cover in place of the standard battery cover.

Attachment and removal of the large-capacity battery pack cover are the same as those for the main battery cover.

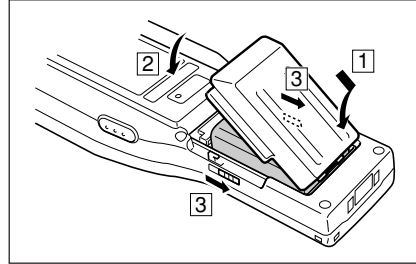

E-31





Removing and Installing the Alkaline Battery Holder (DT-X5M10E/DT-X5M30E/DT-X5M30U only)

Removal Procedure

When using a battery pack, first remove the alkaline battery holder according to the following procedure.

1. Make sure the Handheld Terminal is turned off. If the power is on, press the power key to turn it off.

2. Turn over the Handheld Terminal.

3. Slide the two main battery cover lock switches on both sides of the Handheld Terminal to the "FREE" position, and remove the main battery cover.

If the AA size alkaline batteries are installed, remove the batteries by referring to step 4 on page 28 describing "Replacing the AA size Alkaline Batteries".

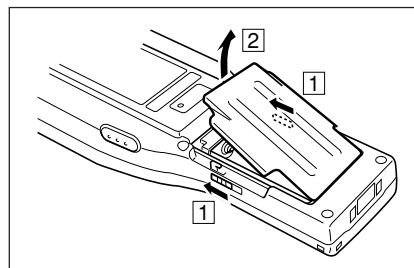

4. Remove the alkaline battery holder by holding the portion indicated by the circle (○) in the illustration while pushing the tab on the outer frame of the alkaline battery holder to the inside.

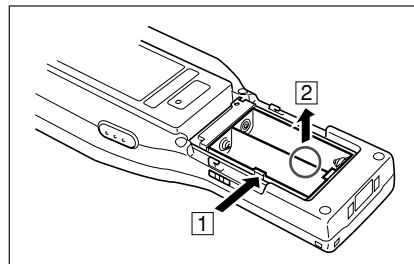



Installation Procedure

When using AA size alkaline batteries, install the alkaline battery holder according to the following procedure.

1. Make sure the Handheld Terminal is turned off. If the power is on, press the power key to turn it off.
2. Turn over the Handheld Terminal.

3. Slide the two main battery cover lock switches on both sides of the Handheld Terminal to the "FREE" position, and remove the main battery cover.

If the battery pack is installed, remove the battery pack by referring to step 4 describing "To replace the battery pack" on page 30.

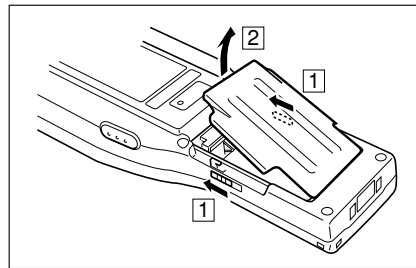

4. Install the alkaline battery holder as shown in the illustration.

Fold the battery pack removal tape so that it is beneath the alkaline battery holder.

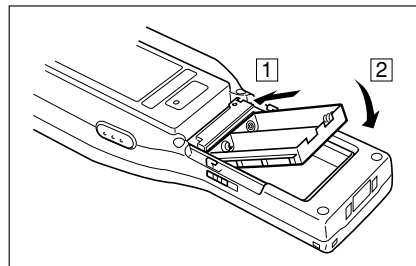

E-33



Attaching the Wrist Strap

Be sure to attach the wrist strap and use it to protect against dropping the Handheld Terminal when carrying it around.

Attach the wrist strap by following the procedure described below.

1. Pass the thin cord of the wrist strap through the wrist strap hole on the back of the Handheld Terminal.

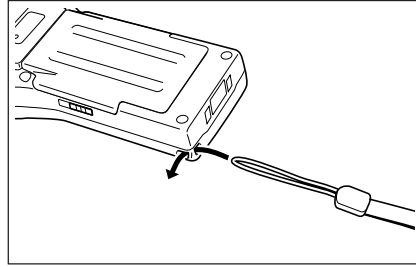

2. Pass the other end of the strap (the part where you insert your wrist) through the loop formed by the thin cord.

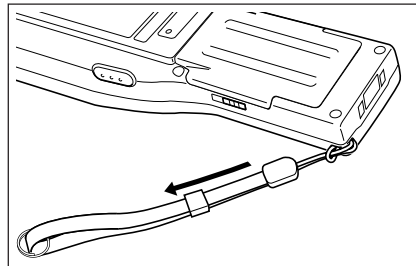
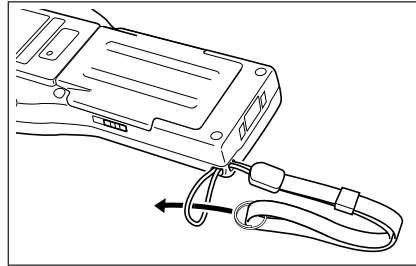

Important!

Do not swing the Handheld Terminal around holding the wrist strap.



Configuring Handheld Terminal Settings

Adjusting Display Contrast

Perform the following steps to adjust display contrast to make display more vivid and easier to see.

- Press the “Fn” key and then press the “2” key or “3” key after confirming that “F” is displayed in the lower right corner of the screen. Pressing the “2” key adjusts for more contrast, while pressing the “3” key adjusts for less contrast.
- * In order to continue to make adjustments, press the “2” key or “3” key after again first pressing the “Fn” key.
- * This can also be set by pressing the “2” key (Settings) on the system menu, and then pressing the “2” key (Contrast and Brightness).

Turning Backlight On and Off

When operating the Handheld Terminal in a dark location, you can turn on the backlight to facilitate viewing of the screen.

- You can switch the backlight on and off by pressing “1” after pressing the Fn key.





Using the Laser Scanner (DT-X5M10E/DT-X5M10R only)

1. After turning on the power, position the laser scanner close to a bar code and then press the Trigger key (R or L).
2. The laser emits light and scans the bar code. If scanning is completed normally, Indicator 2 displays a green light and a buzzer sounds. Indicator 2 displays a red light when an error has occurred during reading.

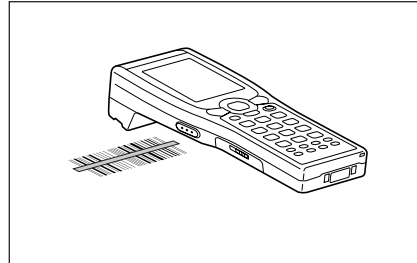

Important!

- If you are unable to scan a bar code, try changing the angle at which the scanner is held or distance from the scanner to the bar code, and then try scanning again.
- This Handheld Terminal is capable of scanning bar codes at a distance of 0~400 mm. Furthermore, the distance at which scanning is possible may vary according to the symbology.
- The laser scanner models are not available in the USA and Canada.



Warning Label

Laser light is emitted from this port.

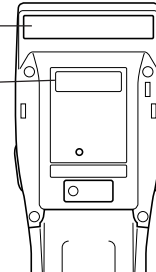
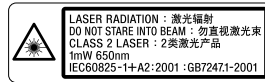

- This label is a warning label for Class 2 laser products that comply with IEC60825-1+A2:2001

CAUTION

- Use of controls or adjustments or performance of procedures other than those specified herein may result in hazardous radiation exposure.
- The laser light emitted by this laser scanner has a maximum output of less than 1 mW and a wavelength of 650 nm.

Warning!

- Never look directly into the laser light.



- This product scans using laser light. Never look directly into the laser light or shine the laser light into the eyes.

Bar Code Scanning Position

Position the Handheld Terminal close to the bar code when scanning small bar codes.
Position the Handheld Terminal at a distance from the bar code so that the bars enter the light when scanning large bar codes.



E-37





Using the C-MOS Imager (DT-X5M30E/DT-X5M30R/DT-X5M30U/DT-X5M30UR only)

1. Turn on the Handheld Terminal, position its C-MOS Imager reader port near the bar code or stacked 2D code, and then press the Trigger Key (R or L).

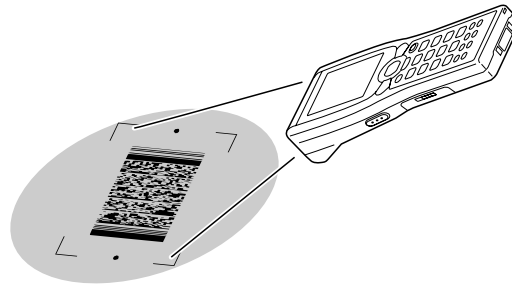

2. The Handheld Terminal reads the code by emitting laser and red light.

Indicator 2 (read operation indicator lamp) lights in green when the reading is successful.

Bar code and stacked 2D code Reading Guide

When you press the Trigger key (R or L), LEDs in the Handheld Terminal emit laser and red lights. Align the laser frame with the center of the bar code or stacked 2D code you are trying to read. Take particular care aligning the light when there are other bar codes nearby.

When reading a large code, adjust the position of the Handheld Terminal so that the entire code is enclosed within the laser frame.

Important!

- If you have problem not properly reading a code, change the angle and/or the distance between the label and the Handheld Terminal and try reading the code again.
- A bar code can be read from a distance of 40mm to 410mm ($1\frac{9}{16}$ " to $16\frac{1}{8}$ "), and a stacked 2D code can be read from a distance of 50mm to 250mm ($1\frac{5}{16}$ " to $9\frac{13}{16}$ "). The actual reading distance depends on the symbology and the resolution.
- For smaller codes, move the Handheld Terminal closer to the code.
- To read a large code, move the Handheld Terminal further away from the code.
- Note that a special reader application is required to read bar codes and stacked 2D codes.
- The DT-X5M30E/M30R/M30U/M30UR supports reading of stacked 2D codes.
- Fingerprints, dust, dirt, or other foreign matter on the C-MOS Imager reader port can cause abnormal reading. Should the code reader port become dirty, wipe it clean with a soft and dry cloth.



Warning Label

Laser light is emitted from this port.

DT-X5M30U
DT-X5M30UR

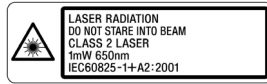

DT-X5M30E
DT-X5M30R

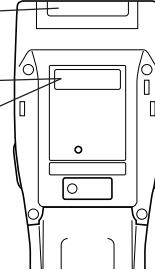
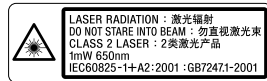

- This label is a warning label for Class 2 laser products that comply with IEC60825-1+A2:2001

CAUTION

- Use of controls or adjustments or performance of procedures other than those specified herein may result in hazardous radiation exposure.
- The laser light emitted by this laser scanner has a maximum output of less than 1 mW and a wavelength of 650 nm.

Warning!

■ Never look directly into the laser light.



- This product scans using laser light. Never look directly into the laser light or shine the laser light into the eyes.



Adjusting Laser Emission Width (DT-X5M10/DT-X5M10R only)

This Handheld Terminal is able to adjust the emission width of laser light. Adjust the Handheld Terminal by following the procedure described below when the emission width of the laser light has become off the proper emission width.

1. Press the reset switch on the back of the Handheld Terminal to initiate the Top menu.

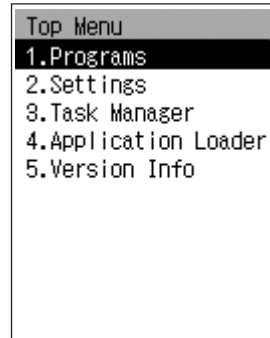

2. Press the keys in the order of the “2” key (Setting), “1” key (Scanner setting) and then “4” key (OBR calibration) to initiate the emission width adjustment function.

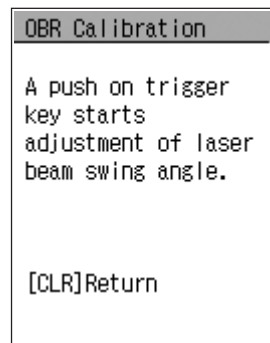

3. Press the trigger key to emit laser light, and shine the light on the emission width adjustment bar code.
 - Align the laser light with the narrow bars on both sides.





4. After checking that the laser light is at the proper position, depress the trigger key for about 1 second.
- This completes adjustment of the emission width.

```
OBR Calibration
Complete.

A push on trigger
key starts
adjustment of laser
beam swing angle
again.
[CLR]Return
```

Emission Width Adjustment Bar code



Important!

- An error message is displayed when emission width has not been adjusted properly. Repeat the adjustment procedure when this message is displayed.



Performing Communication

IR Communication

IR communication can be used to transfer data between two Handheld Terminals. When performing IR communication, orient the IR ports of both Handheld Terminals so they are pointing directly at each other. The ports can be in direct contact with each other, or they can be separated by up to 30 cm (11 $\frac{7}{8}$ ").

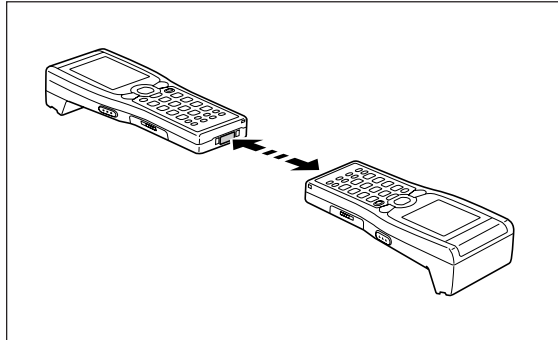

Important!

- A high-sensitivity communication element is used during IR communication.
- In order to ensure successful communication, avoid using cellular phones or other devices that emit radio wave in the area where you are performing IR communication.
- If you need to use such a device, move away from the communicating Handheld Terminals. In case of a cellular phone, keep it at least 30cm (11 $\frac{7}{8}$ ") away.

E-42



Bluetooth™ Communication

Bluetooth™ protocol can also be used to transfer data between two Handheld Terminals. With Bluetooth™, the two Handheld Terminals should be located within about five meters (19¹¹/₁₆"") from each other, as long as there is nothing blocking the path between them.

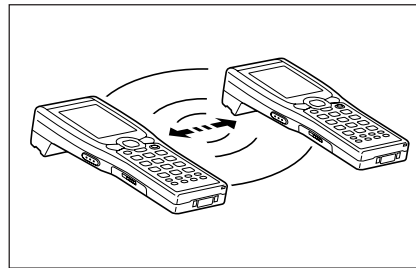

Important!

Observe the following precautions to help ensure that the communication is successful.

- Make sure the Bluetooth™ devices are located within five meters (19¹¹/₁₆"") of each other. The particular surroundings (obstacles) may require a shorter distance between the two devices.
- Make sure there is at least two meters (6' 7") between this device and other devices (electrical appliances, audio-visual equipment, OA equipment, and digital cordless telephones, facsimile machines, etc.). (Take special care with microwave ovens. Allow at least three meters (9' 10³/₈"") between communicating devices and a microwave oven.) When approaching such a device when its power is turned on, proper communication may prove impossible while this may also cause interference with TV and radio reception (images produced by certain UHF and broadcast satellite channels may become blurry).
- Normal communication may not be possible in an area near a broadcast transmitter or wireless transmitter. If this happens, move to a different location. Normal communication may not be possible in areas exposed to strong radio waves.

• Wireless LAN Interference

Because Bluetooth™ and Wireless LAN use the same frequency band (2.4GHz), radio interference can occur if there is a Wireless LAN device nearby. This can result in lower communication speeds, or even make it impossible to establish a connection. If this happens, try the following countermeasures.

- Move at least 10 meters (32'10³/₄"") away from the Wireless LAN device.
- If you cannot keep the distance at least 10 meters (32'10³/₄"") or more between the Handheld Terminal and a Wireless LAN device, turn off the power of either the Handheld terminal or the Wireless LAN device.
- Set the Wireless LAN mode of the Handheld Terminal to off (DT-X5M10R/DT-X5M10UR/DT-X5M30R/DT-X5M30UR).

E-43



Resetting the Handheld Terminal

Reset and Full Reset (Memory Initialization)

Reset

Resetting the Handheld Terminal is the same as restarting a computer. Performing a reset causes all unsaved inputs and edits to be lost, but data that is already stored in the memory as well as all settings should be unaffected.

Use reset to restore normal operation whenever the Handheld Terminal operates abnormally due to misoperation or some other reason.

Performing a Full Reset (Initialization)

Performing a full reset initializes memory. This means that all data stored in the memory (RAM) is deleted and all the settings are returned to their initial factory defaults.

Perform a full reset whenever any one of the following conditions exists.

- When you want to delete all memory contents and return the settings to their initial factory defaults.
- When you are no longer able to use the Handheld Terminal because you forgot your password.
- When the Handheld Terminal does not operate normally due to a memory problem.
- When the message “A problem with memory contents has been found” is displayed.

To perform a reset

Press the reset switch on the back of the Handheld Terminal with a pen or similar object. This starts reset processing.

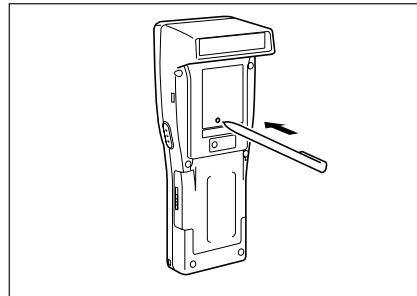

If reset does not find a memory problem

The Handheld Terminal restarts, and normal operation is restored.



If reset finds a memory problem

A message like the one shown below appears on the display when the reset operation discovers a memory problem.

```
Warning
A problem with
memory contents
has been found.
Press [R trigger
key] to continue
with the reset
procedure. All
user data in me-
mory is deleted.
```

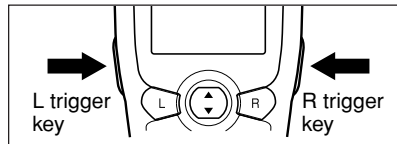

When this message appears, press the R trigger key to continue with the reset operation. Note, however, that reset may not be successful depending on the condition of the memory. In this case, perform the full reset operation described on the next page.

To perform a full reset

Important!

Performing a full reset deletes all data currently stored in the memory (RAM). If possible, backup data of the Handheld Terminal to a computer, Flash Memory, a memory card, or some other medium before performing a full reset.

1. The following message is displayed when the reset switch is pressed for about one second with a pen or similar object while pressing the power key.

```
Warning
Proceeding with
this operation
initializes
memory. Press
[R trigger key]
to proceed or
[L trigger key]
to cancel.
```

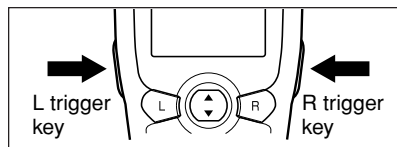

- To cancel the full reset operation, press the L trigger key instead of the R trigger key.
2. Press the R trigger key. This causes the message shown below to appear.

```
Warning
Proceeding with
this operation
deletes all
data stored in
memory. Press
[R trigger key]
to proceed or
[L trigger key]
to cancel.
```

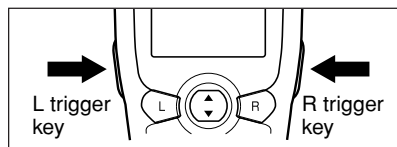

- To cancel the full reset operation, press the L trigger key instead of the R trigger key.
3. Press the R trigger key again.
- Full reset is performed, all data in the memory (RAM) are erased and the start-up screen is displayed.

E-45



DT-X5 Specifications

1. Handheld Terminal

Model: DT-X5M10E, DT-X5M10R, DT-X5M30E, DT-X5M30R, DT-X5M30U, DT-X5M30UR

CPU: 32-bit RISC type

Memory: 16MB RAM (user area: Approximately 7.5MB)
64MB Flash ROM (user area: Approximately 30MB)

OS: Microsoft® Windows® CE.NET operating system, English Version

Display: 128 × 160 dot, monochrome FSTN LCD

2. Laser Scanner (DT-X5M10E/DT-X5M10R)

Reading symbologies: EAN (JAN), UPC, Codabar (NW-7), CODE39, CODE128 (EAN128), Interleaved 2 of 5 (ITF), MSI/Pressy, IATA, CODE93, RSS (1D bar code symbology)

Reading distance: Within approximately 0~400 mm (0 to 15³/₄")

3. C-MOS Imager (DT-X5M30E/DT-X5M30R/DT-X5M30U/DT-X5M30UR)

Reading 1D Code symbologies:
EAN (JAN), UPC, Codabar (NW-7), CODE39, CODE128 (EAN128), Interleaved 2 of 5 (ITF), MSI/Pressy, IATA, CODE93, RSS (1D bar code symbology)

Reading distance: Within approximately 40 mm~410 mm (1⁹/₁₆" to 16¹/₈")

Reading stacked 2D Code symbologies:
PDF 417, Micro PDF, CODE 49, Composite, Codablock, RSS (Stacked)

Reading distance: Within approximately 50 mm to 250 mm (1¹⁵/₁₆" to 9¹³/₁₆")

4. Infrared Communication

Protocol: Compatible with IrDA Ver. 1.1 (max. 30 cm)

Synchronization: Asynchronous, frame synchronization

Transfer rate: 4 Mbps (max.)

5. Bluetooth™

Protocol: Bluetooth™ Specification Ver. 1.1

Range: Approximately 5 m (varies according to radio wave conditions and local surroundings)

Output: Max. 3 dBm (PowerClass 2)

6. Wireless LAN (DT-X5M10R/DT-X5M30R/DT-X5M30UR)

Protocol: Complies with IEEE802.11b

Radio frequency: 2.400-2.4835 GHz

Data rate: Max. 11 Mbps

Range: 50 m indoors, 150 m outdoors (varies according to local surroundings)

Channels: 11 (US, Canada), 13 (ETSI)

Other functions: Roaming among multiple Access-Points



7. Power

Main power supply:	Two AA size alkaline batteries HA-A20BAT battery pack DT-5025LBAT large-capacity battery pack								
Backup power supply:	Rechargeable lithium battery (built-in)								
Power consumption:	DC 1.1A/3~5V (DT-X5M10E) DC 1.3A/3~5V (DT-X5M30E/DT-X5M30U) DC 1.4A/3.7~5V (DT-X5M10R) DC 1.6A/3.7~5V (DT-X5M30R/DT-X5M30UR)								
Battery life:	Main battery <table> <tr> <td>DT-X5M10E</td> <td>Approx. 140 hours (AA size alkaline batteries × 2pcs)* Approx. 70 hours (HA-A20BAT)* Approx. 140 hours (DT-5025LBAT)*</td> </tr> <tr> <td>DT-X5M10R</td> <td>Approx. 70 hours (HA-A20BAT)* Approx. 140 hours (DT-5025LBAT)* Approx. 12 hours (HA-A20BAT)** Approx. 24 hours (DT-5025LBAT)**</td> </tr> <tr> <td>DT-X5M30E/ DT-X5M30U</td> <td>Approx. 30 hours (AA size alkaline batteries × 2pcs)* Approx. 30 hours (HA-A20BAT)* Approx. 60 hours (DT-5025LBAT)*</td> </tr> <tr> <td>DT-X5M30R/ DT-X5M30UR</td> <td>Approx. 30 hours (HA-A20BAT)* Approx. 60 hours (DT-5025LBAT)* Approx. 12 hours (HA-A20BAT)** Approx. 24 hours (DT-5025LBAT)**</td> </tr> </table> <p>* In the case of scanning two bar codes per 10 seconds at normal temperature ** In the case of standby (6.5): Scanning (1.5): Wireless communication(2)</p>	DT-X5M10E	Approx. 140 hours (AA size alkaline batteries × 2pcs)* Approx. 70 hours (HA-A20BAT)* Approx. 140 hours (DT-5025LBAT)*	DT-X5M10R	Approx. 70 hours (HA-A20BAT)* Approx. 140 hours (DT-5025LBAT)* Approx. 12 hours (HA-A20BAT)** Approx. 24 hours (DT-5025LBAT)**	DT-X5M30E/ DT-X5M30U	Approx. 30 hours (AA size alkaline batteries × 2pcs)* Approx. 30 hours (HA-A20BAT)* Approx. 60 hours (DT-5025LBAT)*	DT-X5M30R/ DT-X5M30UR	Approx. 30 hours (HA-A20BAT)* Approx. 60 hours (DT-5025LBAT)* Approx. 12 hours (HA-A20BAT)** Approx. 24 hours (DT-5025LBAT)**
DT-X5M10E	Approx. 140 hours (AA size alkaline batteries × 2pcs)* Approx. 70 hours (HA-A20BAT)* Approx. 140 hours (DT-5025LBAT)*								
DT-X5M10R	Approx. 70 hours (HA-A20BAT)* Approx. 140 hours (DT-5025LBAT)* Approx. 12 hours (HA-A20BAT)** Approx. 24 hours (DT-5025LBAT)**								
DT-X5M30E/ DT-X5M30U	Approx. 30 hours (AA size alkaline batteries × 2pcs)* Approx. 30 hours (HA-A20BAT)* Approx. 60 hours (DT-5025LBAT)*								
DT-X5M30R/ DT-X5M30UR	Approx. 30 hours (HA-A20BAT)* Approx. 60 hours (DT-5025LBAT)* Approx. 12 hours (HA-A20BAT)** Approx. 24 hours (DT-5025LBAT)**								
	Memory backup Data protection (RAM): 3 days (when there is no power from main battery) Clock: 4 weeks (when there is no power from main battery)								

8. Operating Environment

Temperature:	-20 to 50°C
Humidity:	10% to 80% RH (no condensation)

9. Dimensions and Weight

Dimensions:	
DT-X5M10E/ DT-X5M10R	Approx. 54 (70)* W × 179D × 21.4 (41.1)* H mm
DT-X5M30E/ DT-X5M30U/ DT-X5M30R/ DT-X5M30UR/	Approx. 54 (70)* W × 179D × 21.4 (42.8)* H mm

E-47



DT-X5 Specifications

Weight

DT-X5M10E/ Approx. 245 g (when HA-A20BAT battery pack is installed)

DT-X5M30E/

DT-X5M30U

DT-X5M10R/ Approx. 250 g (when HA-A20BAT battery pack is installed)

DT-X5M30R/

DT-X5M30UR

10. Drop durability: 1.8 m

11. Dust and water resistance: Complies with IP54

* When all connectors and covers are closed

12. Other

Clock function: Year, month, date, hour, minute, full-auto calendar, alarm

Vibrator function: Available by setting software





Using the Bridge Satellite Cradle (HA-A61IO)/ Bridge Basic Cradle (HA-A60IO)

The optionally available Bridge Satellite Cradle (HA-A61IO)/Bridge Basic Cradle (HA-A60IO) make it possible to transfer system data and file data between the Handheld Terminal and a computer over an RS-232C connection or USB connection (USB connection only for HA-A60IO). You can also use the Bridge Satellite Cradle/Bridge Basic Cradle to charge the battery pack installed on the Handheld Terminal. An optionally available wall mount unit (DT-891WH) lets you mount the Bridge Satellite Cradle on a wall.

General Guide

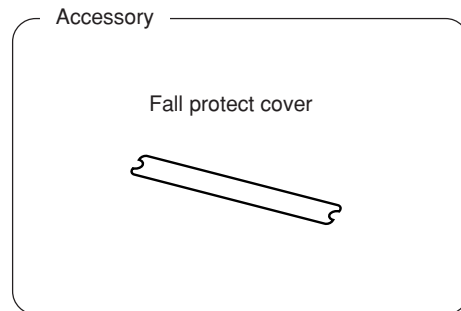
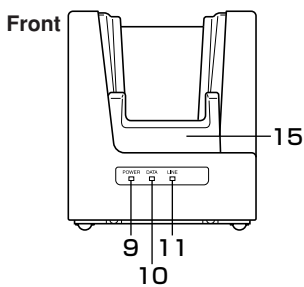
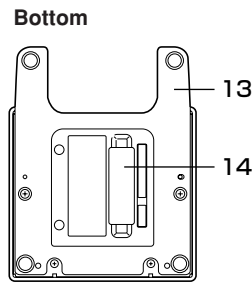
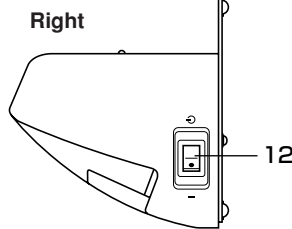
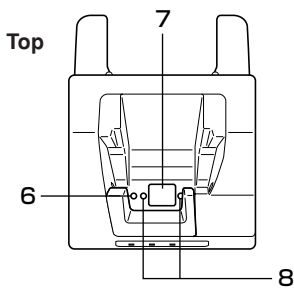
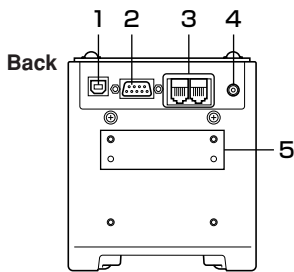

E-49





Using the Bridge Satellite Cradle (HA-A61IO)/Bridge Basic Cradle (HA-A60IO)

1	USB Port	This port accepts connection of a USB cable for connection to a computer for transfer of system data and file data. Use of the USB port requires installation of a special driver on the PC.
2	RS-232C Port (HA-A61IO only)	This port accepts connection of an RS-232C cable for connection to a computer for transfer of system data and file data. Use of the RS-232C port requires installation of a special driver on the PC.
3	RS-422C Port (HA-A61IO only)	This port is used when connecting to another Bridge Satellite Cradle.
4	AC Adaptor Jack	Connect the AC adaptor sold separately to supply power.
5	Wall Mount Unit Fastening Plate	The holes in this plate accept screws that secure the wall mount unit in place.
6	Terminal Detect Switch	This switch detects when the Handheld Terminal is not seated correctly on the Bridge Satellite Cradle.
7	IR Port	This port transfers data with the Handheld Terminal IR port non-contact data communication.
8	Power Contacts	Power is supplied to the Handheld Terminal via these contacts.
9	Power Indicator Lamp	This lamp indicates the Power Status and the mounting status of the Handheld Terminal. Off: Power off Green: Power on, Handheld Terminal mounted correctly Red: Power on, Handheld Terminal not mounted
10	Communication Indicator Lamp (HA-A61IO only)	This lamp shows when the Handheld Terminal is performing data communication. Off: No data communication being performed Green flashing: Data communication in progress Red: Problem with a connection between two Bridge Satellite Cradles
11	System Status Indicator Lamp	This lamp indicates whether the system is operating normally. Regardless of whether or not a Handheld Terminal is mounted this lamp indicates the system status and whether or not a communication operation with the system can be performed. Off: System is not operating. Green: System is operating.
12	Power Switch	Turns the power on and off.
13	Desktop Unit	This is the base when using the Bridge Satellite Cradle/Bridge Basic Cradle in a desktop configuration. Remove the desktop unit in the case of a wall-mount configuration.
14	DIP Switches (HA-A61IO only)	Use these switches to configure the Bridge Satellite Cradle as required.
15	Fall Protector	This is a removable attachment that prevents the Handheld Terminal from tipping over and falling.

E-50



Connecting the AC Adaptor and Connecting to Computer

Use the AC adaptor sold separately from the Bridge Satellite Cradle/Bridge Basic Cradle for the power supply of the Bridge Satellite Cradle/Bridge Basic Cradle. Always make sure that the power is being supplied to the Bridge Satellite Cradle by the AC adaptor before performing any type of data communication operation with the Handheld Terminal. The Handheld Terminal draws the power via the Bridge Satellite Cradle/Bridge Basic Cradle during data communication.

1. After making sure that the Bridge Satellite Cradle/Bridge Basic Cradle power switch is turned off, plug the AC adaptor into the AC adaptor jack on the back.

2. Next, plug the AC adaptor into a power outlet.

3. After making sure that the Bridge Satellite Cradle/Bridge Basic Cradle and your computer are both turned off, remove the cap from the Bridge Satellite Cradle/Bridge Basic Cradle connection ports, and then perform one of the following steps to connect to your computer.

Be sure to keep the Bridge Satellite Cradle/Bridge Basic Cradle connection ports covered whenever you are not using them.

RS-232C Connection

- Connect an RS-232C cable (DT-887AXA) to the RS-232C port (HA-A61IO only) of the Bridge Satellite Cradle. Connect the other end to your computer's RS-232C port.

USB Connection

- Connect a USB cable (DT-380USB) to the USB port of the Bridge Satellite Cradle/Bridge Basic Cradle. Connect the other end to your computer's USB port.

4. Turn on the power. This causes the Bridge Satellite Cradle/Bridge Basic Cradle power indicator lamp to light in red.

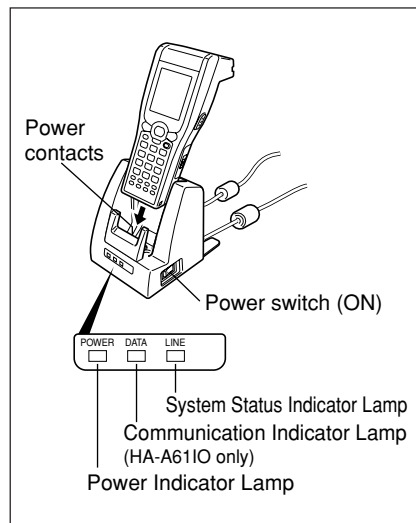
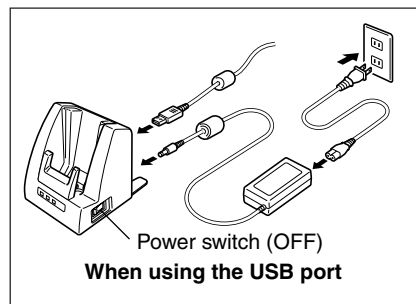

E-51



Using the Bridge Satellite Cradle (HA-A61IO)/Bridge Basic Cradle (HA-A60IO)

5. Making sure that their two IR ports come into contact with each other, place the Handheld Terminal onto the Bridge Satellite Cradle. This causes the Bridge Satellite Cradle power indicator lamp to light in green.

- If the system is operating normally and the communication is enabled, the system status indicator lamp lights in green.
- The communication indicator lamp flashes in green when the communication starts.

When charging is initiated, Indicator 1 on the Handheld Terminal lights up in red. When charging has been completed, Indicator 1 on the Handheld Terminal changes color from red to green.

Important!

- **A high-sensitivity communication element is used during IR communication. In order to ensure successful communication, avoid using cellular phones or other devices that emit radio wave in the area where you are performing IR communication.**

If you need to use such a device, move away from the communicating Handheld Terminals. In case of a cellular phone, keep it at least 30cm (11 $\frac{1}{8}$ ") away.

- **Take care to avoid allowing the Bridge Satellite Cradle/Bridge Basic Cradle power contacts to become connected to each other, which creates a short. Shorting the power contacts can damage the Bridge Satellite Cradle/Bridge Basic Cradle.**



Removing the Fall Protector

The Bridge Satellite Cradle and Cradle-type Battery Charger Fall Protector can also be removed. However, it is recommended not to remove the Fall Protector if there is the risk of the Handheld Terminal being mistakenly tipped over and falling after having been placed in the Bridge Satellite Cradle. The Fall Protector should always be left attached when the Handheld Terminal is mounted on a wall.

1. Remove the Fall Protector by applying force in the direction of the arrow while holding at the location of ○ in the illustration with the Bridge Satellite Cradle lying horizontally.

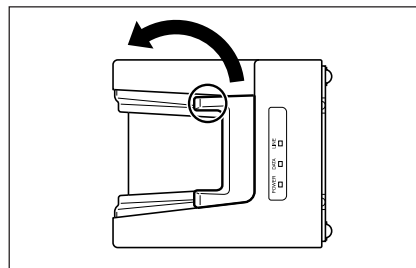

2. Affix the seal to the location where the Fall Protector was attached.

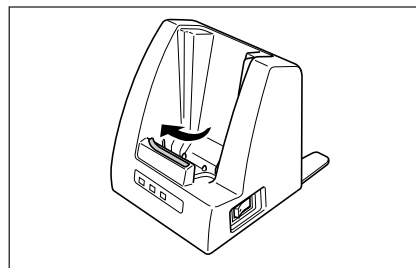

When attaching, remove the seal and insert the projections on the Fall Protector into the attachment groove, and then slide the Fall Protector to the left to fasten in position.

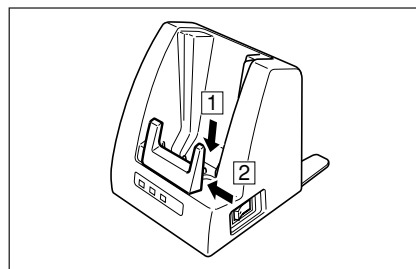

Configuring DIP Switch Settings (HA-A61IO)

Dismounting the bottom cover of the Bridge Satellite Cradle exposes the DIP switches. You can change the ON/OFF settings of the DIP switches to set the configuration. Please set after first switching OFF the power.

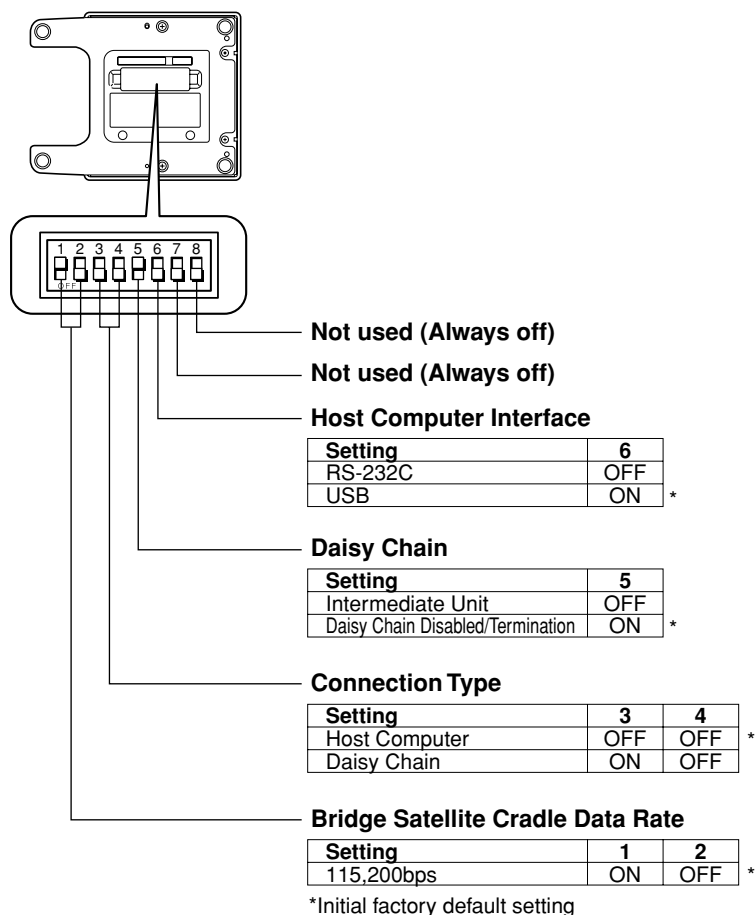

Important!

Note that other DIP settings are used for testing and inspection purposes. Because of this, you should never use any DIP settings other than those described above.



Using Wall Mount Unit

The following procedure explains how to use the optional wall mount unit (DT-891WH) to configure the Bridge Satellite Cradle/Bridge Basic Cradle for a wall-mounted configuration.

Important!

When mounting on a wall, always make sure to attach the Fall Protector.

1. Remove the screws on the bottom of the Bridge Satellite Cradle/Bridge Basic Cradle, and remove the desktop unit.

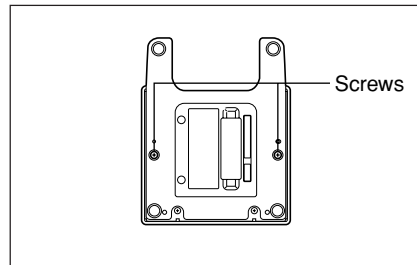

2. Affix the wall mount unit to the bottom of the Bridge Satellite Cradle/Bridge Basic Cradle, and secure it in place with the wall mount unit screws.

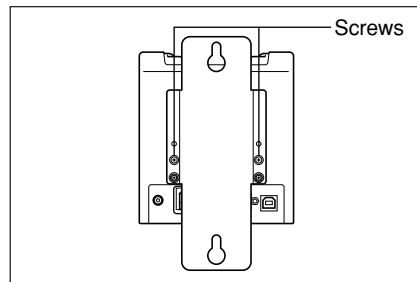

3. Drive one of the provided screws into the wall at the location where the upper hole of the wall mount unit to be when you mount the unit on the wall.
Do not drive the screw into the wall all the way. Keep a space of about 2mm ($1/8''$) between the head of the screw and the wall surface.

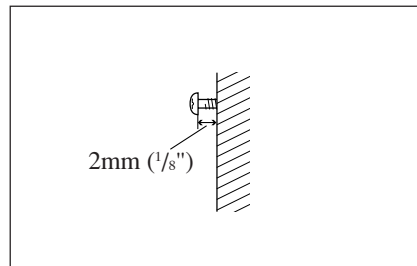

E-55



Using the Bridge Satellite Cradle (HA-A61IO)/Bridge Basic Cradle (HA-A60IO)

4. Hook the upper wall mount unit hole onto the upper screw.

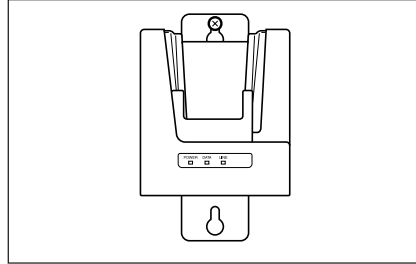

5. Drive the other screw into the wall at the location where the lower hole is located.

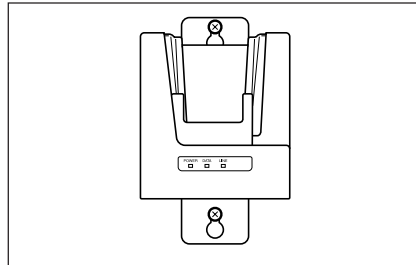

6. Drive the upper screw and lower screw into the wall the rest of the way.

To remove the Bridge Satellite Cradle/Bridge Basic Cradle from the wall

1. Loosen the upper screw and lower screw.
2. Raise the Bridge Satellite Cradle/Bridge Basic Cradle and remove it from the screws.

Important!

- While the Bridge Satellite Cradle/Bridge Basic Cradle is mounted on a wall, be sure to check the wall screws periodically for looseness. Tighten them as required.
- Note use of the RS-232C cable is not supported by the wall-mounted configuration. Connect using a USB cable or daisy chain cable.

E-56



Connecting Multiple Bridge Satellite Cradles (HA-A6110)

Use the modular cable for the connections.
You can daisy chain multiple Bridge Satellite Cradles by connecting the C-OUT port of the first unit that is the nearest to the host computer to the C-IN port of the next unit that is sitting to the first unit with DT-888RSC cable (RS-422 Modular cable) as shown in the figure below.

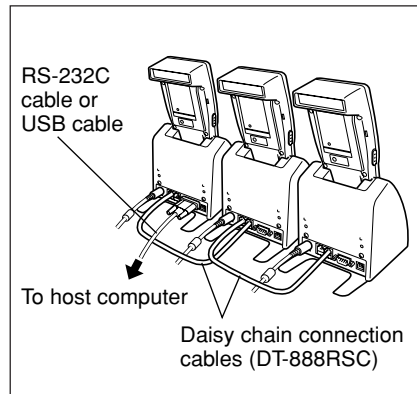

Important!

You can use optional RS-422 Modular Cables (DT-888RSC) to link up to eight Bridge Satellite Cradles.



Bridge Satellite Cradle (HA-A61IO)/Bridge Basic Cradle (HA-A60IO) Specifications

1. IR Communication

Interface:	IR interface
Protocol:	IrDA Ver. 1.1 Standard
Synchronization:	Asynchronous, frame synchronization
Transfer Rate:	9,600, 115,200, 4Mbps (4Mbps is possible during a USB connection with the host computer only.)

2. USB

Protocol:	USB Ver1.1 Standard
Transfer Rate:	12Mbps (max.)

3. RS-232C (HA-A61IO)

Protocol:	Full duplex
Synchronization:	Asynchronous
Transfer Rate:	115,200bps

4. RS-422 (HA-A61IO)

Protocol:	Full duplex
Synchronization:	Asynchronous
Transfer Rate:	115,200bps

5. Charging

Charging System:	Fixed-voltage (with current limiter)
Charge Time:	Approximately 5.0 hours (standard battery pack) Approximately 10 hours (large-capacity battery pack)

6. Power Supply

Power Requirement:	AC adaptor (AD-S42120A)
Power Consumption:	DC12V approximately 1.0A (HA-A60IO) DC12V approximately 0.9A (HA-A61IO)
Output to Handheld Terminal:	DC5V 1.5A (max.)

7. AC Adaptor

Model:	AD-S42120A
Input:	100V to 240V AC 50/60Hz
Output:	12V DC 3.5A

8. Dimensions and Weight

Dimensions:	Desktop: Approximately 110(W) × 125(D) × 128(H) mm (4 ³ / ₈ "W × 4 ¹⁵ / ₁₆ "D × 5 ¹ / ₁₆ "H) Wall Mount: Approximately 110(W) × 148(D) × 153(H) mm (4 ³ / ₈ "W × 5 ⁷ / ₈ "D × 6"H)
Weight:	Desktop: Approximately 520g (18.34oz) (HA-A60IO) Approximately 530g (18.7oz) (HA-A61IO) Wall Mount: Approximately 610g (21.52oz) (HA-A60IO) Approximately 620g (21.87oz) (HA-A61IO)

9. Operating Environment

Temperature:	0°C to 40°C (32°F to 104°F)
Humidity:	30% to 80% RH (non-condensation)



Using the Cradle-type Battery Charger

The optionally available Cradle-type Battery Charger (HA-A30CHG) lets you charge the Handheld Terminal's battery simply by placing the Handheld Terminal onto the charger. An optional wall mount unit (DT-891WH) lets you mount the Cradle-type Battery Charger on a wall.

General Guide

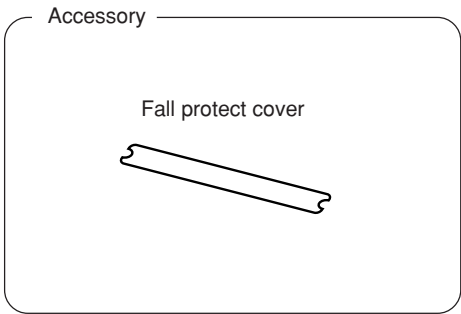
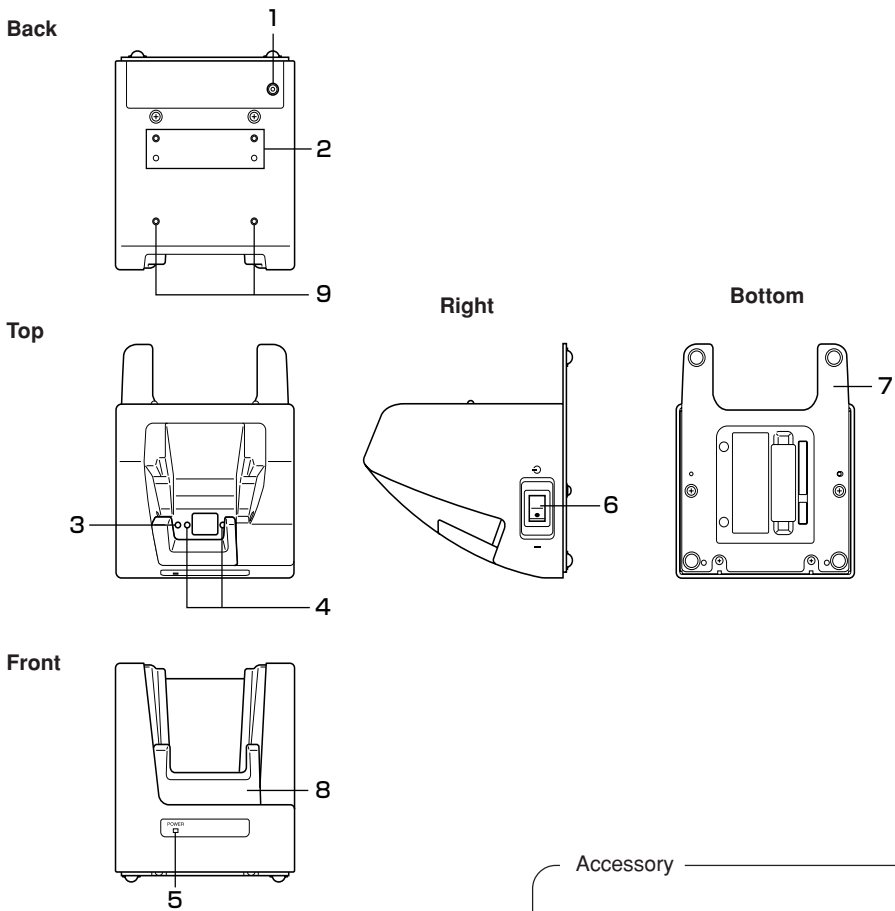

E-59





Using the Cradle-type Battery Charger

1	AC Adaptor Jack	Connect the AC adaptor (sold separately) here.
2	Wall Mount Unit Fastening Plate	The holes in this plate accept screws that secure the wall mount unit in place.
3	Terminal Detect Switch	This switch detects when the Handheld Terminal is not seated correctly on the Cradle.
4	Power Contacts	Power is supplied to the Handheld Terminal via these contacts.
5	Power Indicator Lamp	This lamp indicates the power status and the mounting status of the Handheld Terminal. Off: Power off Red: Power on, Handheld Terminal not mounted Green: Power on, Handheld Terminal mounted correctly
6	Power Switch	Turns the power on and off.
7	Desktop Unit	This is the base when using the Cradle in a desktop configuration. Remove the desktop unit in the case of a wall-mount configuration.
8	Fall Protector	This is a removable attachment that prevents the Handheld Terminal from tipping over and falling.
9	Car Mounted Battery Charger Attachment Holes	This is used when attaching the separately sold Battery Charger Car Mount Unit (HA-A34AT).

E-60



Connecting the AC Adaptor for Cradle-type Battery Charger

Use the special AC adaptor (sold separately) for the Cradle-type Battery Charger to connect to a wall outlet.

1. After making sure that the Cradle-type Battery Charger power switch is turned off, plug the AC adaptor into the AC adaptor jack on the back of the charger.
2. Next, plug the AC adaptor into a power outlet.
3. Turn on the power. This causes the Cradle-type Battery Charger power indicator lamp to light in red.
4. Making sure that their power contacts come into contact with each other, place the Handheld Terminal onto the Cradle-type Battery Charger. This causes the Cradle-type Battery Charger power indicator lamp to light in green.

When charging is initiated, Indicator 1 on the Handheld Terminal lights up in red. When charging has been completed, Indicator 1 changes color from red to green.

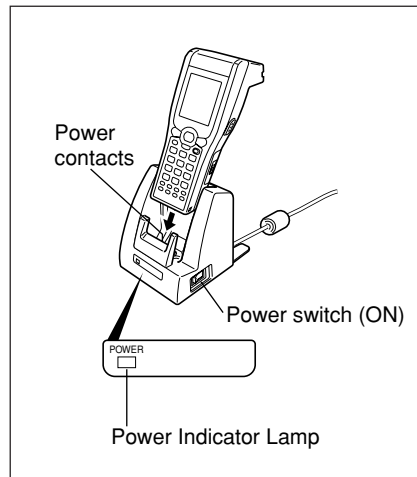
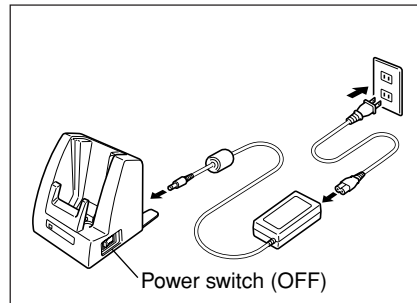

Important !

Take care to avoid allowing the Cradle-type Battery Charger power contacts to become connected to each other, which creates a short.

Shorting the power contacts can damage the Cradle-type Battery Charger.

E-61



Using the Cradle-type Battery Charger

Using Wall Mount Unit

To wall mount the Cradle-type Battery Charger, use the same procedure as that described for the Bridge Satellite Cradle (HA-A61IO)/Bridge Basic Cradle (HA-A60IO) on page 55.

Removing the Fall Protector

The procedure is the same as that for the Bridge Satellite Cradle (HA-61IO)/Bridge Basic Cradle (HA-A60IO). Refer to page 53.

Cradle-type Battery Charger (HA-A30CHG) Specifications

1. Charging

Charging System: Fixed-voltage (with current limiter)
Charge Time: Approximately 5 hours (HA-A20BAT battery pack)
Approximately 10 hours (DT-5025LBAT large-capacity battery pack)

2. Power Supply

Power Requirement: AC adaptor (AD-S42120A)
Power Consumption: 12V DC, approximately 0.9A
Output to Handheld Terminal: 5V DC 1.5A (max.)

3. AC Adaptor

Model: AD-S42120A
Input: 100V to 240V AC 50/60Hz
Output: 12V DC 3.5A

4. Dimensions and Weight

Dimensions: Desktop: Approximately 110(W) X 125(D) X 128(H) mm
(4 $\frac{3}{8}$ "W x 4 $\frac{15}{16}$ "D x 5 $\frac{1}{16}$ "H)
Wall Mount: Approximately 110(W) x 148(D) x 153(H) mm
(4 $\frac{3}{8}$ "W x 5 $\frac{7}{8}$ "D x 6"H)
Weight: Desktop: Approximately 510g (16.6oz)
Wall Mount: Approximately 600g (22.2oz)

5. Operating Environment

Temperature: 0°C to 40°C (32°F to 104°F)
Humidity: 30% to 80% RH (non-condensation)



Using the Dual Battery Charger

The optionally available Dual Battery Charger (DT-5022CHG) allows for parallel charging of two rechargeable battery packs.

General Guide

Front

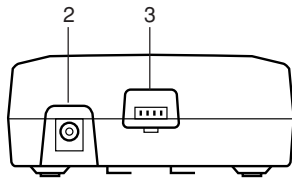

Top

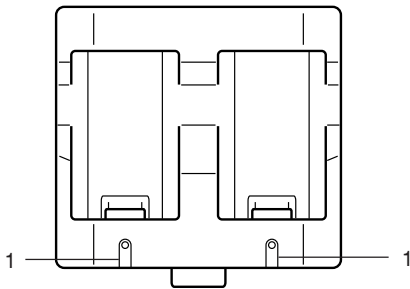

Bottom

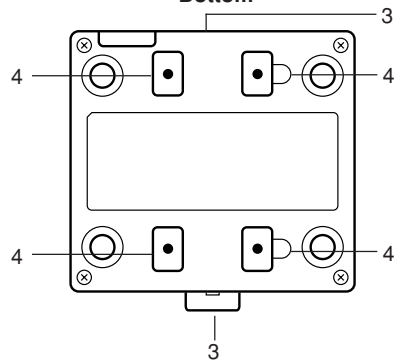

Accessories

Connection Bracket
2 screws

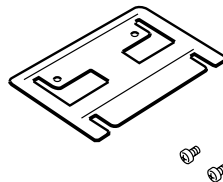

E-63



Using the Dual Battery Charger

1	Charge Indicator Lamp	This lamp indicates the charge status of the battery pack(s). Off: Not charging Red: Charging Red Flashing: Battery pack problem Green: Charging complete
2	AC Adaptor Jack	Connect the AC adaptor here.
3	Dual Battery Charger Connection Port	Use this port to connect multiple Dual Battery Chargers to each other.
4	Connection Bracket Attachment Holes	The connection bracket attaches here when you connect multiple Dual Battery Chargers to each other.

Important!

Each Dual Battery Charger comes with one connection bracket.

Since only one connection bracket is required when you connect two Dual Battery Chargers, you will always have one left over.

Simply keep the other connection bracket on hand as an extra, in case you ever need it.

E-64





Charging a Battery Pack

1. Plug the optional AC adaptor into the AC adaptor jack of the Dual Battery Charger.

2. Plug the other end of the AC adaptor into a wall outlet.

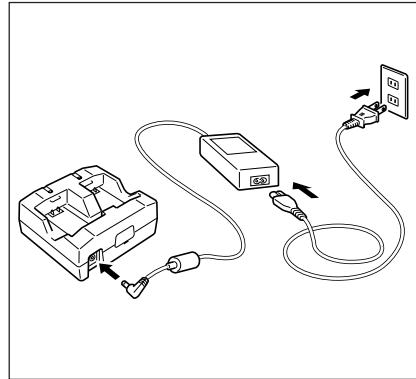

3. Taking care that the battery pack is oriented correctly, insert it into the Dual Battery Charger.

This causes the Charge Indicator Lamp to light in red, indicating that charging has started.

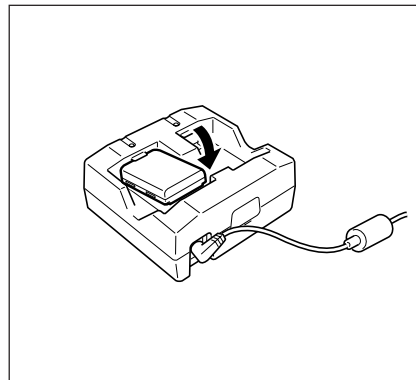

Charge Indicator Lamp

Off: Not charging

Red: Charging

Red Flashing: Battery pack problem

Green: Charging complete



Connecting Multiple Dual Battery Chargers

You can connect up to three Dual Battery Chargers. Doing so makes it possible to supply power to all the Dual Battery Chargers using the AC adaptor.

1. As shown in the illustrations below, remove the connector covers of the Dual Battery Chargers you want to connect to each other.

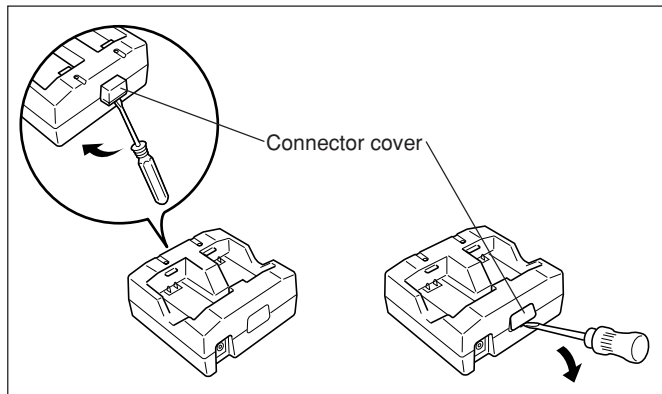

2. Connect the two Dual Battery Chargers as shown below.

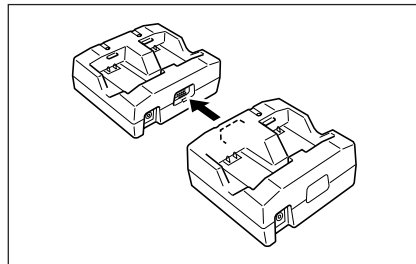

3. Turn over the connected Dual Battery Chargers and attach a connection bracket, securing it in place with screws.

You can repeat the above steps to connect up to three Dual Battery Chargers.

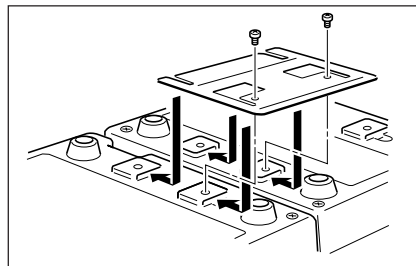



Dual Battery Charger (DT-5022CHG) Specifications

1. Model

DT-5022CHG

2. Charging

Charging System:

Fixed-voltage (with current limiter)

Charge Time:

Approximately 2.5 hours for one HA-A20BAT battery pack

Approximately 5.0 hours for one DT-5025LBAT large-capacity battery pack

Charging Two Battery Packs

Approximately 5.0 hours for two battery packs (HA-A20BAT×2)

Approximately 10 hours for two large-capacity battery packs (DT-5025LBAT×2)

3. Power Supply

Power Requirement:

AC adaptor MPC-577ADP

Consumption Current:

Approximately 650mA

4. Operating Environment

Temperature:

0°C to 40°C (32°F to 104°F)

Humidity:

30% to 80% RH (non-condensation)

5. Dimensions and Weight

Dimensions:

Approximately 110(W) × 100(D) × 49(H) mm (4³/₈"W × 4"D × 1⁷/₈"H)

Weight:

Approximately 154g (5.4oz)

E-67



Using Rechargeable Battery Pack

Your Handheld Terminal supports use of two battery pack types of different capacity. You can select the one that best suits your needs in terms of operating time, the type of options you need to use, etc.

When using the large-capacity battery pack, you need to use the special large-capacity battery pack cover that comes with the Handheld Terminal.

Important!

Store a battery pack in its special soft case whenever you are not using it.

Battery Pack Specifications

Model:	HA-A20BAT
Rated Capacitance:	1700mAh
Rated Voltage:	3.7V
Dimensions:	Approximately 37(W) × 57(D) × 13(H) mm (1½"W × 2¼"D × ½"H)
Weight:	Approximately 45g (1.6oz)
Bundled Item:	Soft case

Large-capacity Battery Pack Specifications

Model:	DT-5025LBAT
Rated Capacitance:	3400mAh
Rated Voltage:	3.7V
Dimensions:	Approximately 37(W) × 57(D) × 24(H) mm (1½"W × 2¼"D × 1"H)
Weight:	Approximately 87g (3.1oz)
Bundled Item:	Soft case



Memo



E-69





Memo



E-70





Free Manuals Download Website

<http://myh66.com>

<http://usermanuals.us>

<http://www.somanuals.com>

<http://www.4manuals.cc>

<http://www.manual-lib.com>

<http://www.404manual.com>

<http://www.luxmanual.com>

<http://aubethermostatmanual.com>

Golf course search by state

<http://golfingnear.com>

Email search by domain

<http://emailbydomain.com>

Auto manuals search

<http://auto.somanuals.com>

TV manuals search

<http://tv.somanuals.com>