

**ELECTRONIC CASH REGISTER**

# CE-2400

**OPERATOR'S INSTRUCTION MANUAL**



## Welcome to the CASIO CE-2400!

Congratulations upon your selection of a CASIO Electronic Cash Register, which is designed to provide years of reliable operation.

Operation of a CASIO cash register is simple enough to be mastered without special training. Everything you need to know is included in this manual, so keep it on hand for reference. Consult your CASIO dealer if you have any questions about points not specifically covered in this manual.

### **CASIO AUTHORIZED SERVICE CENTER**

If your Casio product needs repair, or you wish to purchase replacement parts, please call 1-800-YO-CASIO for the authorized service center nearest your home.

If for any reason this product is to be returned to the store where purchased, it must be packed in the original carton/package.

If you need programming assistance, please call 1-800-638-9228.

Thank you.

### **GUIDELINE LAID DOWN BY FCC RULES FOR USE OF THE UNIT IN THE U.S.A. (Not applicable to other areas)**

**WARNING:** This equipment generates, uses and can radiate radio frequency energy and if not installed and used in accordance with the instruction manual, may cause interference to radio communications. It has been tested and found to comply with the limits for a Class A computing device pursuant to Subpart J of Part 15 of the FCC Rules, which are designed to provide reasonable protection against such interference when operated in a commercial environment.

Operation of this equipment in a residential area is likely to cause interference in which case the user at his own expense will be required to take whatever measures may be required to correct the interference.

The mains plug on this equipment must be used to disconnect mains power.  
Please ensure that the socket outlet is installed near the equipment and shall be easily accessible.

## Important!

Before you do anything, be sure to note the following important precautions!

*Do not locate the cash register where it will be subjected to direct sunlight, very high humidity, splashing with water or other liquids, or high temperature (such as near a heater).*

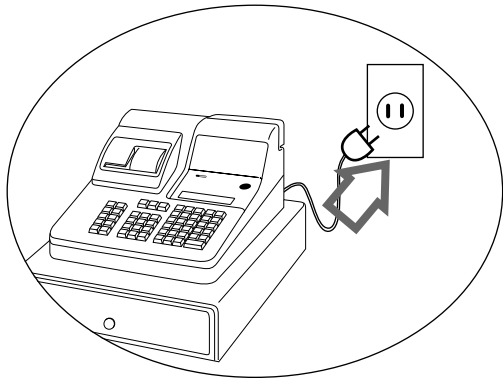
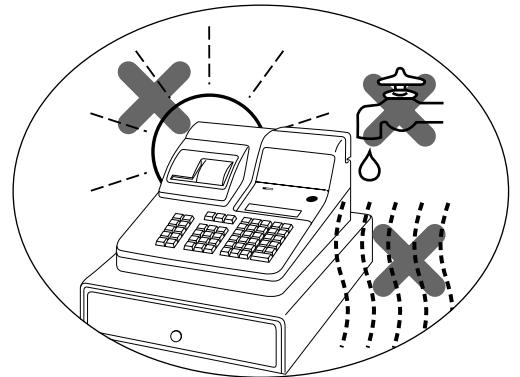

*Be sure to check the sticker on the side of the cash register to make sure that its voltage matches that of the power supply in your area.*

*Never operate the cash register while your hands are wet.*

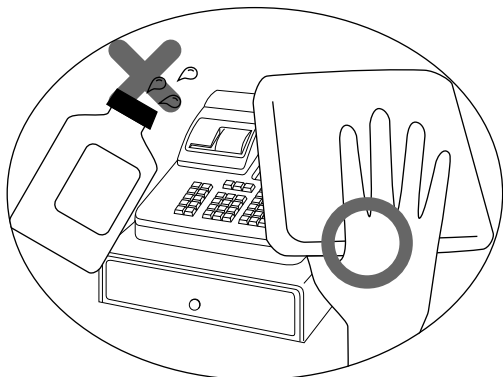
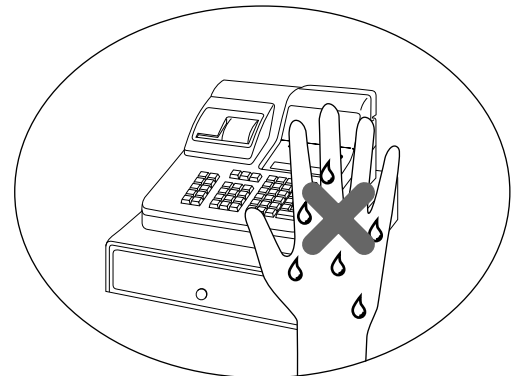

*Use a soft, dry cloth to clean the exterior of the cash register. Never use benzine, thinner, or any other volatile agent.*

*Never try to open the cash register or attempt your own repairs. Take the cash register to your authorized CASIO dealer for repairs.*

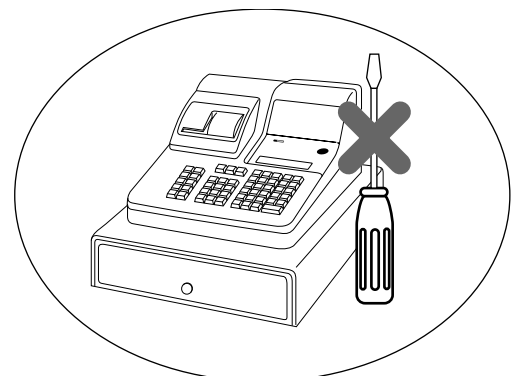

## Introduction

Welcome to the CASIO CE-2400 .....	2
------------------------------------	---

## Getting Started

Getting Started .....	6
-----------------------	---

## Introducing CE-2400

General guide .....	9
Displays .....	11
Keyboard .....	12

## Batteries and Roll Paper

Installing memory backup batteries .....	14
To load memory protection batteries .....	14
Installing roll paper .....	16
To load paper for printing of journal .....	16
To load paper for printing of receipts .....	17

## Basic Setups and Operations

Setting a machine number .....	18
Setting the time .....	19
Setting the date .....	19
Displaying the time and date .....	20
Programming automatic tax calculation .....	21
To program Tax Tables .....	21
How to use your cash register .....	26
How to read the receipts and the journal .....	27
Preparing and using department keys .....	28
Programming department keys .....	28
Registering department keys .....	30
Registering PLUs .....	33
Programming PLUs .....	33
Registering PLUs and sub-departments .....	35
Registering premiums and discounts .....	39
Programming premiums and discounts .....	39
Registering premiums and discounts .....	40
Registering reductions .....	42
Programming for reductions .....	42
Registering reductions .....	43
Calculating the merchandise subtotal .....	44
Shifting the taxable status of an item .....	45
Registering charge and check payments .....	46
Registering returned goods in the REG mode .....	48
Registering returned goods in the RF mode .....	49
Registering money received on account .....	50
Registering money paid out .....	50

Making corrections in a registration .....	51
No sale registration .....	53

## More Setups and Operations

Clerk control function .....	54
Post-finalization receipt issuance .....	54
General printing control .....	54
Programming multiple clerks, post-finalization receipt issuance, and general printing control .....	54
Single-item-sales for departments and PLUs .....	58
Programming single-item-sale status to departments and PLUs .....	58
Registering single-item-sale items .....	60
Registering manually entered tax amounts .....	61
Programming for manually input tax registration .....	61
Registering manual tax .....	61
Programming tax printing and other features .....	62
Programming currency exchange .....	63
Calculator functions .....	66
Programming calculator features .....	67

## Reports

Printing the cash register's program .....	68
Printing READ reports .....	68
Printing RESET reports .....	71
Report samples .....	74

## Troubleshooting

When an error occurs .....	78
When the register does not operate at all .....	79
In case of power failure .....	80
About the low battery power indicator .....	80

## User Maintenance and Options

To replenish stamp ink .....	81
To replace the ink roll .....	81
To replace journal paper .....	82
To replace receipt paper .....	83
Options .....	83

## Specifications

CE-2400 Specifications .....	84
------------------------------	----

## Index

Index .....	85
-------------	----

# Getting Started

This section outlines how to unpack the cash register and get it ready to operate. You should read this part of the manual even if you have used a cash register before. The following is the basic set up procedure, along with page references where you should look for more details.

1

Remove the cash register from its box, making sure that all of the parts and accessories are included.

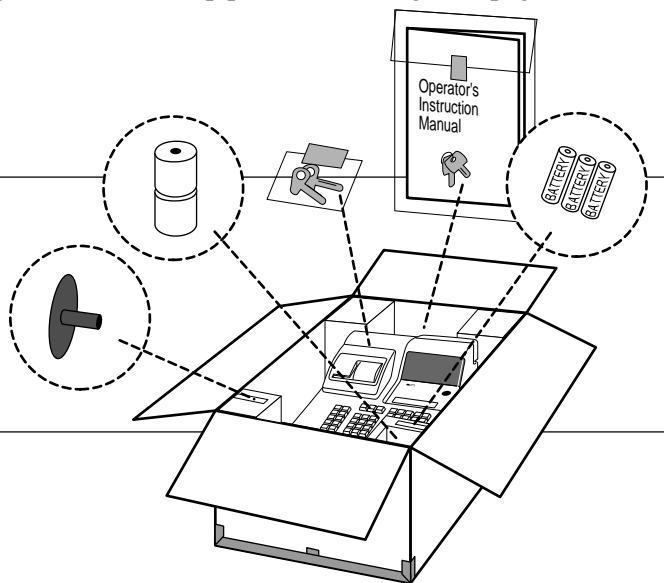

2

Remove the tape holding parts of the cash register in place. Also remove the small plastic bag taped to the printer cover. Inside you will find the mode keys.

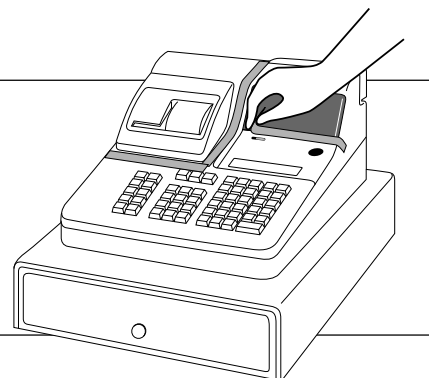

3

Install the three memory backup batteries (page 14).

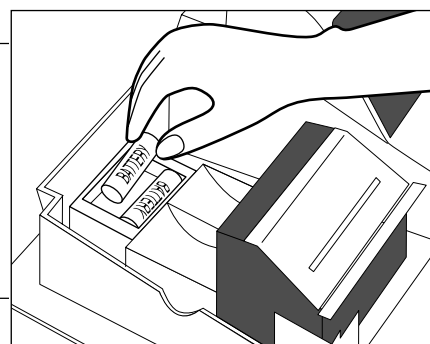

## Important!

**These batteries protect the information stored in your cash register's memory when there is a power failure or when you unplug the cash register. Be sure to install these batteries.**

4

Plug the cash register into a wall outlet. Be sure to check the sticker on the side of the cash register to make sure that its voltage matches that of the power supply in your area.

The printer will operate for a few seconds.

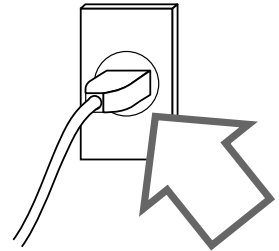

5

Insert the mode key marked "OW" into the Mode Switch.

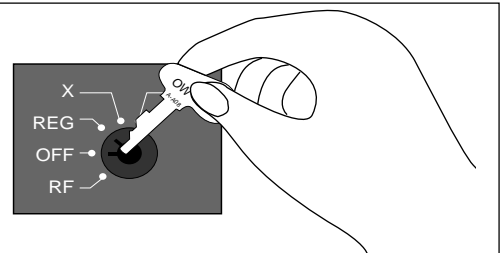

6

Turn the mode key to the "REG" position. The display should change to the following.

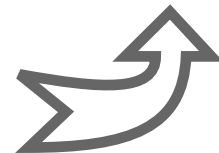
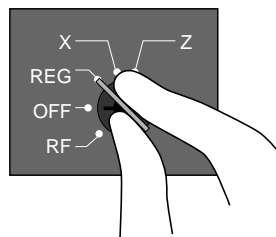

# Getting Started

7

Install receipt and journal paper (page 16, 17).



## Important!

**Never operate the cash register without paper. Doing so can damage the printer.**

8

Set today's date and the current time (page 19).

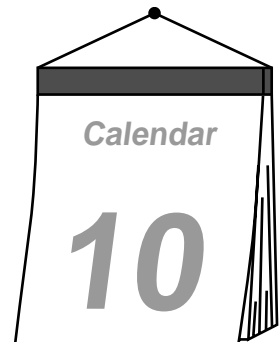

9

Set the tax calculation programs (page 21).

## Important!

**When you purchase this cash register, it is not programmed to perform any tax calculation. You must perform the procedure on page 21 to tell the cash register what kind of tax calculation it should use.**

10

Set up the cash register for any other operations you want to perform using the procedures starting from page 26.



# Introducing CE-2400

This part of the manual introduces you to the cash register and provides a general explanation of its various parts.

## General guide

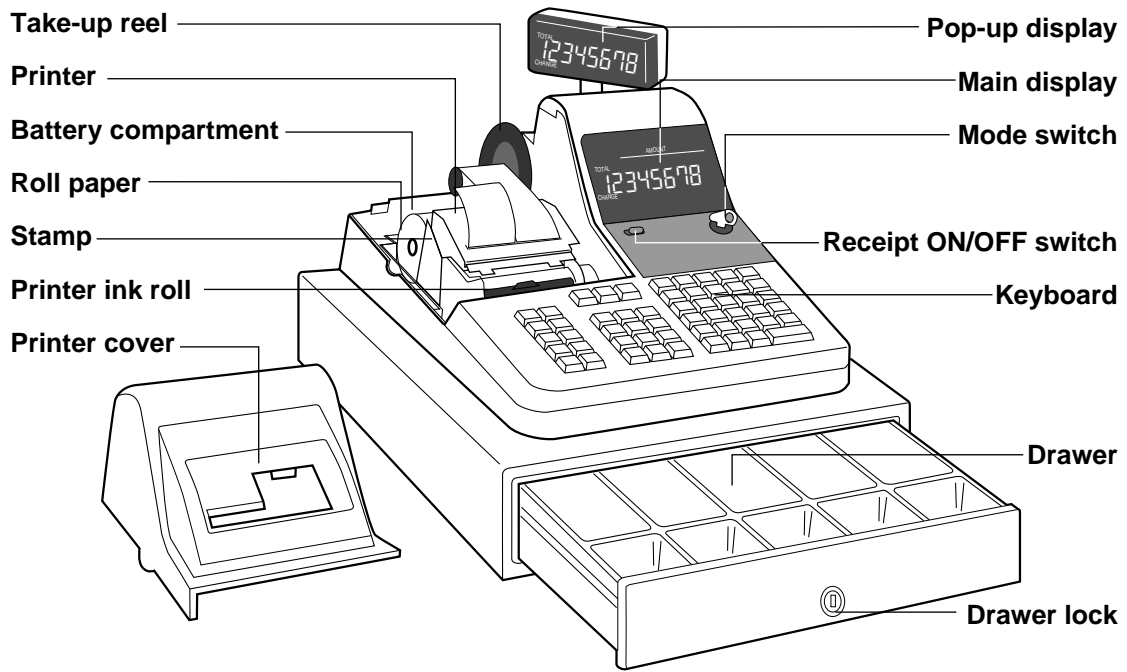

### Battery compartment

Holds memory backup batteries (page 14, 15).

### Roll paper

You can use the roll paper to print receipts and a journal (page 16, 17).

### Stamp

The stamp is printed automatically at the top of each receipt (page 27).

### Printer ink roll

Provides ink for printing of registration details on the roll paper (page 81).

### Receipt switch

When you are using the printer for receipt printer, you can use this switch (in the **REG** and **RF** modes only) to turn the printer on and off. If a customer asks for a receipt while receipt printing is turned off by this switch, you can issue a post-finalization receipt (page 57).

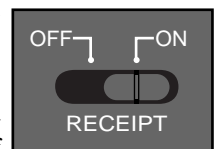

# Introducing CE-2400

## Mode key

There are two types of mode keys: the owner key (marked "OW") and the operator key (marked "OP"). Two of each type of key comes packed with the cash register. The owner key can be used to set the mode switch to any position, while the operator key can select the **REG** and **OFF** positions only.

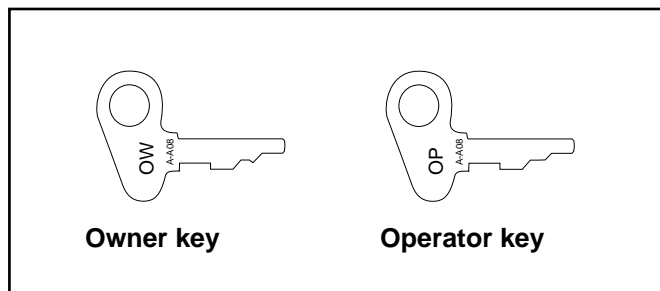

## Mode switch

Use the mode keys to change the position of the mode switch and select the mode you want to use.

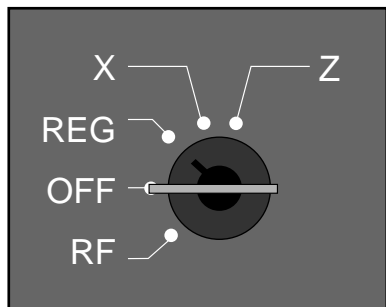

Mode Switch	Mode Name	Description
<b>Z</b>	<b>RESET/PROGRAM</b>	Reads sales data in memory and clears the data. This mode is also used for certain programming.
<b>X</b>	<b>READ/PROGRAM</b>	Reads sales data in memory without clearing the data. This mode is also used for certain programming.
<b>REG</b>	<b>REGISTER</b>	Use this mode for normal registration.
<b>OFF</b>	<b>POWER OFF</b>	Cash register power switched off.
<b>RF</b>	<b>REFUND</b>	Use this mode to register refund transactions.

## Drawer

The drawer opens automatically whenever you finalize a registration and when you issue a daily sales READ/RESET report, a financial report or a periodic sales READ/RESET report. The drawer will not open if it is locked with the drawer key.

## Drawer lock

Use the drawer key to lock and unlock the drawer.

### When the cash drawer does not open!

In case of power failure or the machine is in malfunction, the cash drawer does not open automatically. Even in these cases, you can open the cash drawer by pulling drawer release lever (see below).

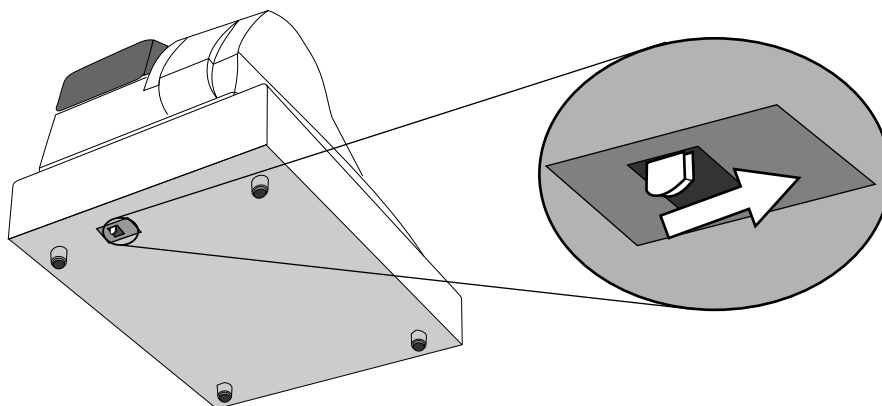

### Important!

The drawer will not open, if it is locked with a drawer lock key.

# Displays

## Main Display

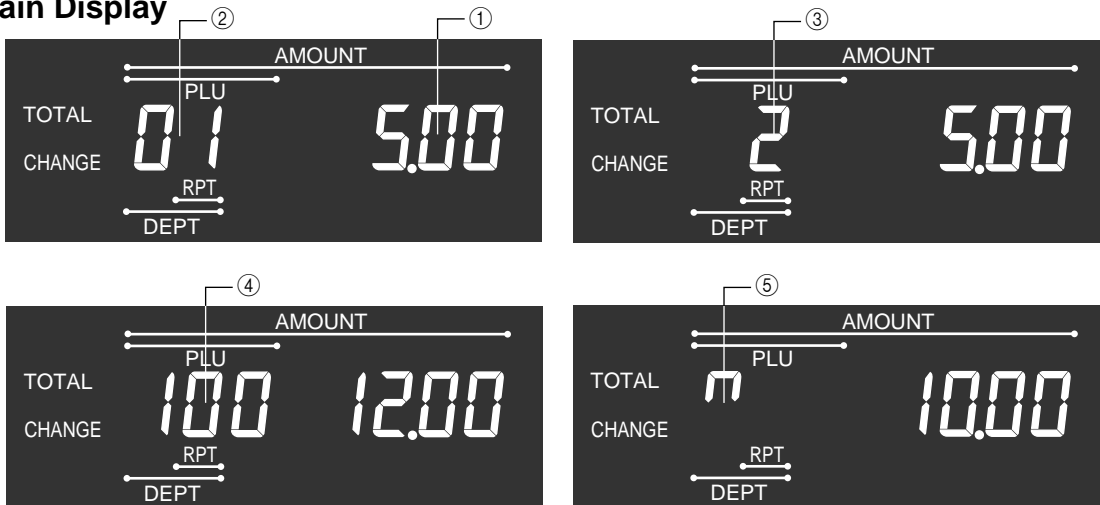

## Pop-Up Display

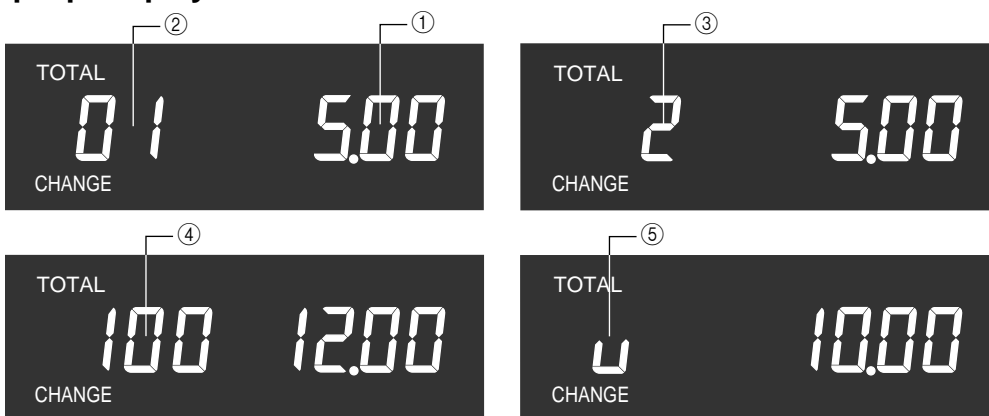

### ① Amount/Quantity

This part of the display shows monetary amounts (total and change amount due). It also can be used to show the current date and time (page 20).

### ② Department Number

When you press a department key to register a unit price, the corresponding department number (01 through 40) appears here. When you perform a repeat registration (page 31) with the department, the display automatically changes to show the number of repeats.

### ③ Number of Repeats

Anytime you perform a repeat registration (page 31, 35, 36), the number of repeats appears here. Note that only one digit is displayed for the number of repeats. This means that a "5" could mean 5, 15, or even 25 repeats.

### ④ PLU (Sub-department) Number

When you input a PLU (sub-department) number to register a unit price, the corresponding PLU (sub-department) number appears here. When you perform a repeat registration (page 35, 36) with the PLU (sub-department), the display automatically changes to show the number of repeats.

### ⑤ Total/Change Indicators

These indicators tell you whether the value on the display represents the total or the change amount due. When the TOTAL indicator (upper segment) is lit, the displayed value shown is a monetary total or subtotal amount. When the CHANGE indicator (lower segment) is lit, the displayed value is the change amount due.

## Keyboard

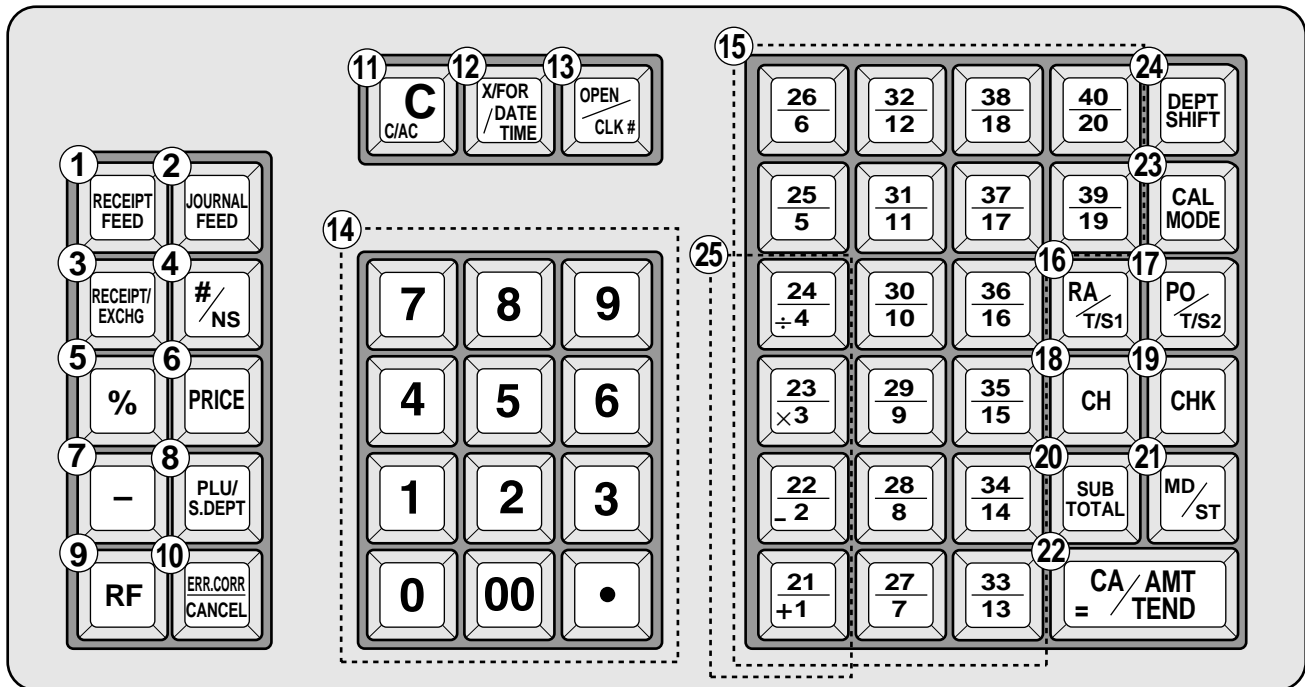

### • Register Mode

#### ① Receipt Feed key

Hold this key down to feed receipt from the printer.

#### ② Journal Feed key

Hold this key down to feed journal from the printer.

#### ③ Receipt/Currency Exchange key

Receipt key: Press this key to produce a post-finalization receipt (page 57).

Currency Exchange key: Use this key for calculating subtotal amounts or paying amount due in foreign currency (page 63).

#### ④ Non-Add/No Sale key

Non-Add key: Press this key after numeric entry, the number is treated as a reference number. The number is printed on receipt/journal to identify a personal check, credit card, etc. for certain transactions.

No Sale key: After issuing a receipt press this key to open the drawer without registering anything.

#### ⑤ Percent key/Manual Tax key

It is necessary to select one of these functions (page 61).

Percent key: Use this key to register premiums or discounts.

Manual Tax key: Use this key to register manually entered tax amounts.

#### ⑥ Price key

Use this key to input unit prices for sub-department registration.

#### ⑦ Minus key

Use this key to input values for subtraction.

#### ⑧ PLU/Sub-department key

Use this key to input PLU (sub-department) numbers.

#### ⑨ Refund key

Use this key to input refund amounts and to void certain entries.

#### ⑩ Error Correct/Cancel key

Use this key to correct registration errors and to cancel registration of an entire transaction.

#### ⑪ Clear key

Use this key to clear an entry that has not yet been registered. Pressing this key also stops the error tone.

#### ⑫ Multiplication/For/Date/Time key

Use this key to input a quantity for a multiplication operation and registration of split sales of packaged items.

Between transactions, this key displays the current time and date.

### ⑬ Open/Clerk Number key

Open key: Press this key to temporarily release a limitation on the number of digits that can be input for a unit price. This function is available only on registers that are not using the clerk control function. (page 54)

Clerk Number key: Use this key to sign clerk on and off the register. This function is available only on registers that are using the clerk control function. (page 54)

### ⑭ 10-key pad

Use these keys to input numbers.

### ⑮ Department keys

Use these keys to register items to departments.

### ⑯ Received on Account/Taxable Status Shift 1 key

Received on Account key: Press this key following a numeric entry to register money received for non-sale transactions.

Taxable Status Shift 1 key: Press this key without a numeric entry to change the Taxable 1 status of the next item.

### ⑰ Paid Out/Taxable Status Shift 2 key

Paid Out key: Press this key following a numeric entry to register money paid out from the drawer.

Taxable Status Shift 2 key: Press this key without a numeric entry to change the Taxable 2 status of the next item.

### ⑱ Charge key

Use this key to register a charge sale.

### ⑲ Check key

Use this key to register a check tender.

### ⑳ Subtotal key

Press this key to display and print the current subtotal (which also includes the add-on tax amount).

### ㉑ Merchandise Subtotal key

Press this key to display and print the current subtotal of item prices only (which does not include the add-on tax amount).

### ㉒ Cash Amount Tendered key

Press this key to register a cash sale.

### ㉓ Calculator Mode key

This key is used for changing **REG** ↔ **CAL** mode.

### ㉔ Department Shift key

Press this key to shift the department key number from 1 through 20 to 21 through 40 as follows:

$\boxed{+ 21}$	→ Dept. 1	$\boxed{\text{DEPT SHIFT } + 21}$	→ Dept. 21
$\boxed{- 22}$	→ Dept. 2	$\boxed{\text{DEPT SHIFT } - 22}$	→ Dept. 22
$\boxed{\times 23}$	→ Dept. 3	$\boxed{\text{DEPT SHIFT } \times 23}$	→ Dept. 23
⋮		⋮	
$\boxed{\div 40}$	→ Dept. 20	$\boxed{\text{DEPT SHIFT } \div 40}$	→ Dept. 40

### • Calculator Mode

### ④ Drawer open key

### ⑤ Percent key

### ⑧ Memory Recall key

### ⑪ Clear/All Clear key

### ⑭ 10-key pad

### ⑲ Equal key

### ㉓ Calculator Mode key

### ㉕ Arithmetic operation keys

# Batteries and Roll Paper

This part of the manual tells you how to load the memory backup batteries and how to install the roll paper for printing of receipts or the journal.

## Installing memory backup batteries

This cash register uses electronic memory, which means that your settings and sales data is safe as long as electrical power is supplied. Three SUM-3 (UM-3) batteries are required to protect memory contents in case of power failure and when you unplug the cash register.

### Note!

- The normal life of a set of batteries is about one year.
- If you do not have fresh batteries installed when electrical power through the plug is interrupted, settings and sales data will be lost.

## To load memory protection batteries

Battery compartment



1



Remove the printer cover.

3

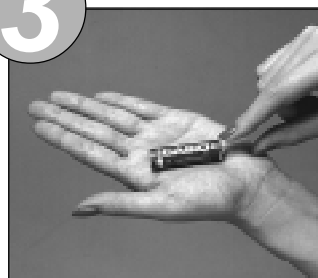

Note the (+) and (-) markings in the battery compartment. Load a set of three new SUM-3 (UM-3) batteries so that their positive (+) and negative (-) ends are facing as indicated by the markings.

2



Remove the battery compartment cover. Pressing in on the tab on the left side of the battery compartment cover, lift it straight up.



## Important!

**Incorrectly using batteries can cause them to burst or leak, possibly damaging the interior of the cash register. Note the following precautions.**

- ✓ Be sure that the positive (+) and negative (–) ends of the batteries are facing as marked in the battery compartment when you load them into the unit.
- ✓ Never mix batteries of different types.
- ✓ Never mix old batteries with new ones.
- ✓ Never leave dead batteries in the battery compartment.
- ✓ Remove the batteries if you do not plan to use the cash register for long periods.
- ✓ Replace the batteries at least once every two years, no matter how much the cash register is used during that period.

## WARNING!

- **Never try to recharge the batteries supplied with the unit.**
- **Do not expose batteries to direct heat, let them become shorted, or try to take them apart.**
- **Keep batteries out of the reach of small children. If your child should swallow a battery, consult a physician immediately.**

4

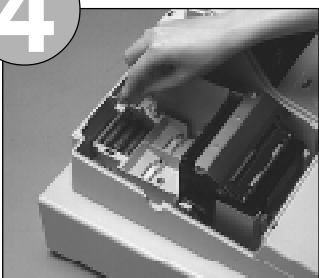

Replace the battery compartment cover.

5



Replace the printer cover.

# Batteries and Roll Paper

## Installing roll paper

You can use roll paper (45mm wide) for printing of receipts and a journal.

### Journal Printing

The journal is a record for your record keeping only. It shows details for all transactions.

### Receipt Printing

Receipts also show details for each transaction for the customers' records.

When a receipt is printed, tear it off and give it to the customer.

## Important!

**Be sure to use only roll paper recommended by CASIO. Other paper can damage the printer.**

To load paper for printing of journal

Stamp

Printer

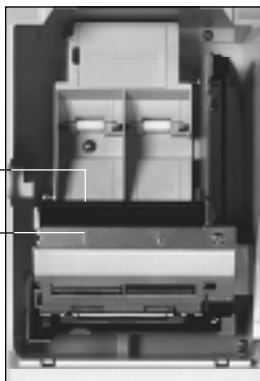

1

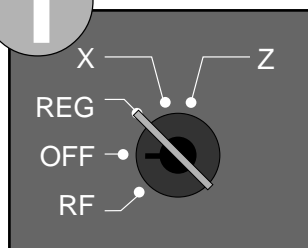

Use a mode key to set the mode switch to the REG position.

3



Cut off the leading end of the paper so it is even.

4



Ensuring the paper is being fed from the bottom of the roll, lower the roll into the space behind the printer.

2



Remove the printer cover.

5



Pass the paper over the black roller, and insert the end of it into the printer inlet.





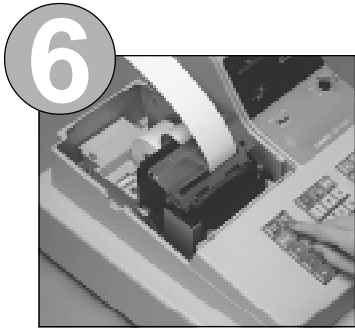

Press the **JOURNAL FEED** key until about 20 or 30 cm of paper is fed from the printer.

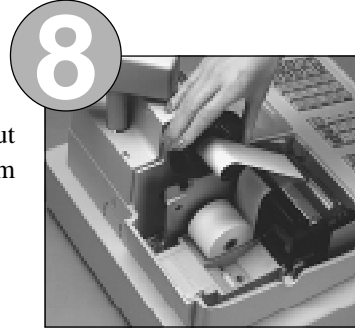

Place the take-up reel into place behind the printer, above the roll paper.

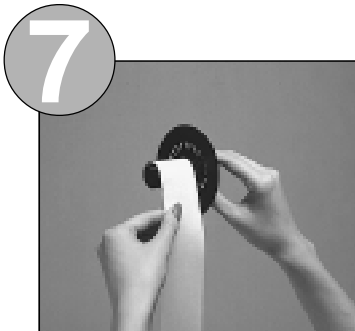

Slide the leading end of the paper into the groove on the spindle of the take-up reel and wind it onto the reel two or three turns.



Press the **JOURNAL FEED** key to take up any slack in the paper.

## To load paper for printing of receipts

1

Follow steps 1 through 4 under “To load paper for printing of journal” on the previous page.

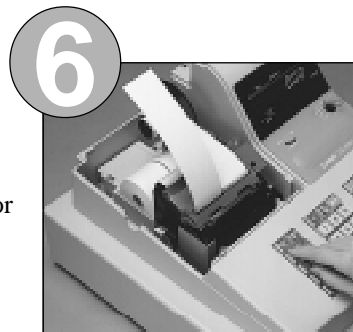

Press the **RECEIPT FEED** key until about 20 or 30cm of paper is fed from the printer.

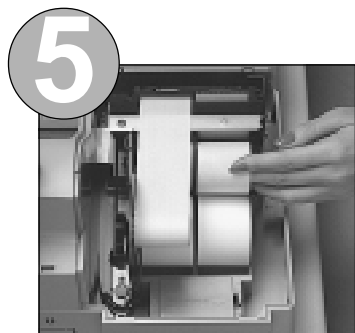

Pass the paper over the black roller, and insert the end of it into the printer inlet.

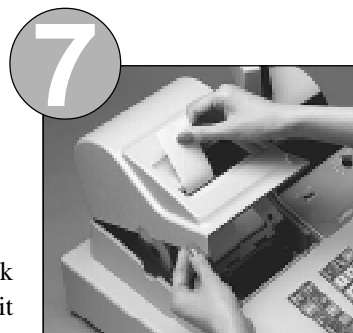

Replace the printer cover, passing the leading end of the paper through the cutter slot. Tear off the excess paper.

# Basic Setups and Operations

This section explains how to set up and use the cash register for basic operation. Your cash register should already be unpacked and plugged in, with its memory backup batteries (page 14) and roll paper (page 16, 17) loaded.

The set ups and operations described here are generally enough to meet many retail needs.

## Important!

**Be sure to make a distinction between numeric keys and department keys. The following shows how these keys are illustrated in this manual.**

### Numeric keys

**1**, **2**, **3**, **00**, etc

### Department keys

Department 1 or 21 → **21**  
+

Department 2 or 22 → **22**  
-

⋮

Department 20 or 40 → **40**  
20

**Note:** You must press the **DEPT SHIFT** key to specify the department from 21 to 40.

## Setting a machine number

You can set a 2-digit machine number (01 to 99) to identify your machine. The machine number is printed on receipts or the journal for each transaction.

### To set the machine number

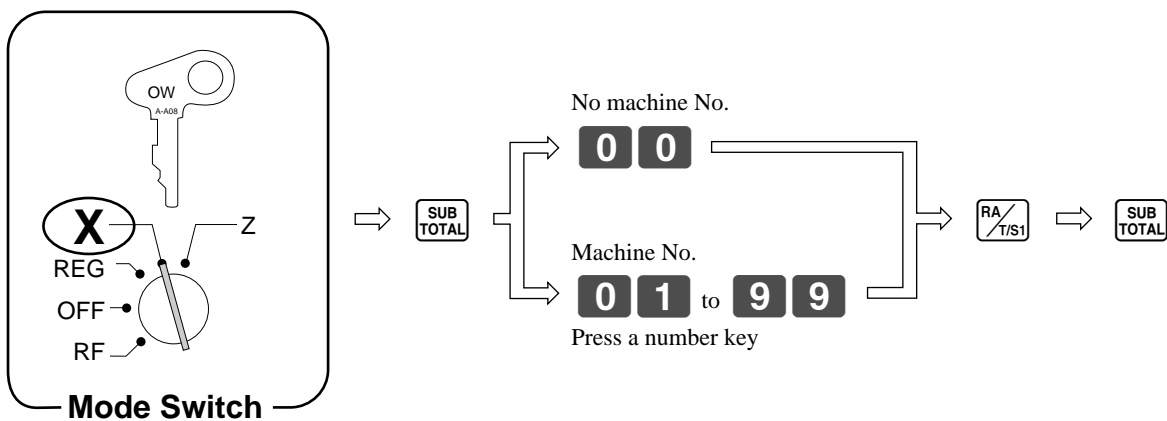

## Setting the time

The correct time is kept even when the cash register is switched off.  
A 24-hour clock is used, so a time like 7:00 PM becomes 19:00.

### To set the time

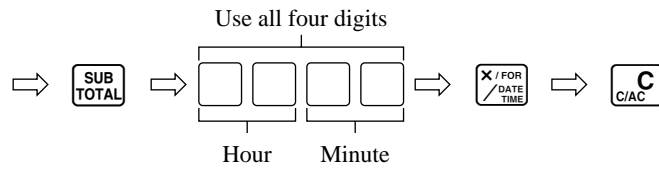
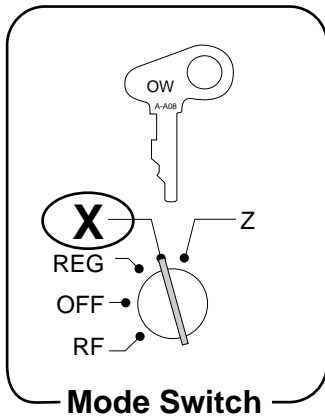

Example:

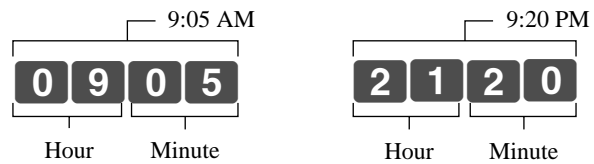

## Setting the date

The correct date is kept even when the cash register is switched off.  
The cash register automatically adjusts for leap years up to the year 2099.

### To set the date

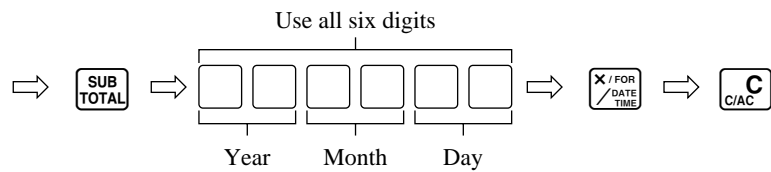
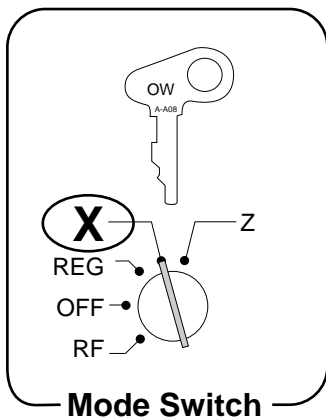

Example:

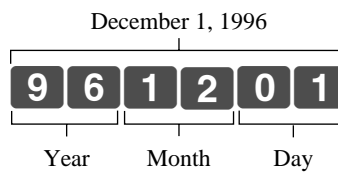

# Basic Setups and Operations

## Displaying the time and date

You can show the time or date on the display of the cash register whenever there is no registration being performed.

### To display and clear the time and date

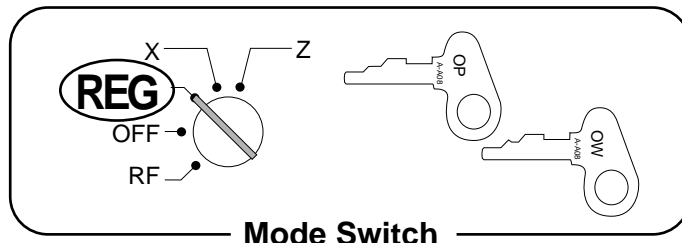

#### OPERATION

#### DISPLAY



← Time display appears.



← Switches to the date display.  
To switch back to the time display, press again.



← Clears the date or time display.

(24-hour system)

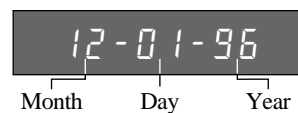
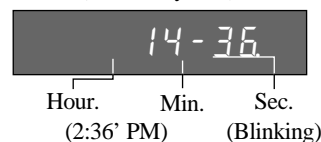

- Operation of all keys (besides ) is impossible while the time or date is displayed.

# Programming automatic tax calculation

## Important!

After you program the tax calculations, you also have to individually specify which departments (page 28) and PLUs (page 34) are to be taxed.

For this cash register to be able to automatically register state sales tax, you must program its tax tables with tax calculation data from the tax table for your state. There are two tax tables that you can program for automatic calculation of two separate sales taxes.

### State Sales Tax Calculation Data Tables

State sales tax calculation data tables for all of the states that make up the United States are included on the following pages. This data is current as of October 30, 1994\*. Simply find your state in the tables and input the data shown in its table.

\* Some data are revised after Oct. 30, 1994.

## Important!

Be sure you use the state sales tax data specifically for your state. Even if your state uses the same tax rate percentage as another state, inputting the wrong data will result in incorrect tax calculations.

## To program Tax Tables

**Example 1**  
ALABAMA 6%

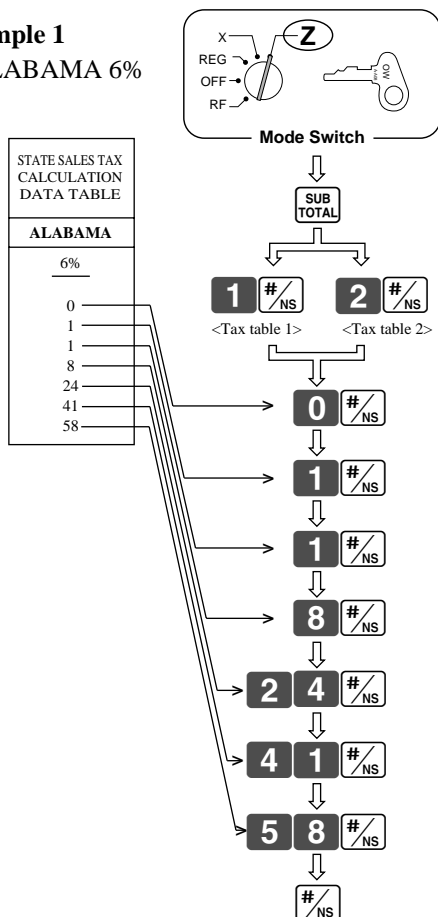

**Example 2**  
COLORADO 5.25%

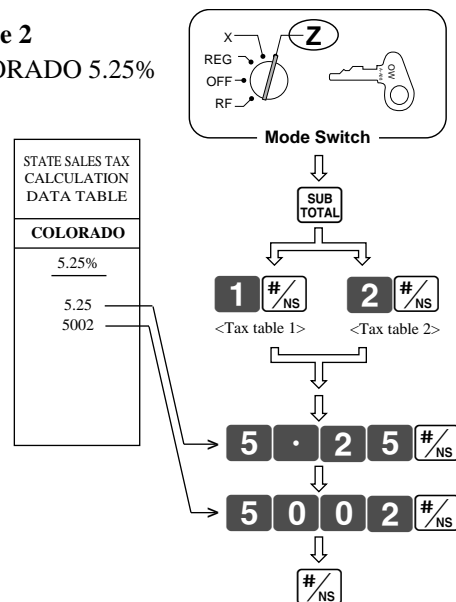

- If you enter a wrong data but have not yet pressed the #/NS key, press the **C** key to delete the wrong data.
- If you have already pressed the #/NS key, press the #/NS key once again to end the programming sequence and then start again from the beginning.

# Basic Setups and Operations

## TAX TABLES

ALABAMA						
4%	5%	6%	6%	6% (4+1+1)	7%	8%
0	0	0	0	0	0	0
1	1	1	1	1	1	1
1	1	1	1	1	1	1
10	10	8	9	10	7	6
30	29	24	20	20	21	18
54	49	41	40	36	35	31
73	69	58	55	54	49	43
110	89		70	70	64	56
	110		90	85	78	68
			109	110	92	81
					107	93
						106

ALASKA							
KENAI		HOMER/SELDOVIA		HAINES	JUNEAU	KENAI	KENAISEWARD & SOLDOTNA
2%	3%	3%	4%	4%	4%	5%	5%
0	0	0	0	0	0	0	0
1	1	1	1	1	1	1	1
1	1	1	1	1	1	1	1
1	4	4	2	1	6	6	6
25	34	25	19	12	13	13	09
75	49	34	37	37	25	25	29
	83	75	62		46	46	49
	116	127			75	75	69
	150	155			79	79	89
	183	177			118	118	109
	216	227			127	127	
					151	151	

ALASKA			
HOMER		6%	
5.5%	6%	6%	6%
0	145	345	6
1	163	363	2
1	181	381	29
8	208	408	29
27	227		49
45	245		69
63	263		89
81	281		109
99	299		109
108	308		129
127	327		159

ARIZONA						
4%	5%	6%	6.5%	6.7%	6.8%	7%
0	0	0	175	0	161	0
1	1	1	191	1	176	1
1	5	9		7	192	7
12	10	10		7	207	7
37	27	22		23	223	22
	47	39		38	238	37
	68	56		53	253	52
	89	73		69	269	67
	109	90		84	284	82
		107		99	299	97
		125		115	311	109
		141		141	330	139
		158		146		141
						139
						330

ARKANSAS						
3%	4%	5%	6%	6.8%	7%	7.5%
0	0	0	0	0	0	0
1	1	1	1	1	1	1
1	1	1	1	2	1	2
14	12	10	8	6	7	6
44	37	20	24	19	21	19
74		40	41	33	35	33
114		60	58	46	49	46
		80			64	
		110			78	
					92	
					107	

CALIFORNIA																			
6%	6.25%	6.5%	6.75%	7%	7.25%	7.25%	7.5%	7.75%	8.25%	8.5%	10% Parking	LOS ANGELES							
0	141	0	0	130	299	6.75	0	121	278	7.25	117	7.25	0	7.75	8.25	0	99	0	99
1	158	1	1	146		5002	1	135	292	5002	131	5002	1	5002	5002	1	111	1	99
7		7	7	161			0	8	149				1			1	123	11	104
10		10	10	176			10	10	164				5			5	135	99	114
22		21	20	192			20	20	178				17			17	147	99	124
39		37	35	207			34	33	192				29			29	158	99	134
56		54	51	223			48	47	207				41			41	170	99	144
73		70	67	238			64	62	221				52			52	182	99	154
90		86	83	253			80	76	235				64			64	194	99	
108		103	99	269			96	91	249				76			76	205	99	
124		119	115	284			111	107	264				88			88		99	

COLORADO																		
LOVELAND																		
1.5%	2%	2.5%	3%	3.5%	3.6%	3.85%	4%	4.5%	5%	5.25%	5.5%	5.6%	5.75%	6%	6.1%	6.35%	6.4%	
0	0	0	0	0	0	264	0	0	0	211	0	0	5.25	0	172	0	168	0
1	1	1	1	1	1	291	1	1	1	233	1	1	5002	1	190	1	186	1
1	1	1	3	2	5	319	2	2	5	255	2	1		6	209	7	204	8
33	24	19	17	17	17	347	16	17	17	277	17	18		17	227	16	222	17
99	74	59	49	42	41	375	37	37	33	299	29	18		27	245	25	240	26
166			83	71	69		63	62	55		49	51		45	263	43	43	41
233			116	99	97				77			68		63	281	61	60	58
			149	128	124				99			84		81	299	79	78	74
			183	157	152				122			118		99		97	95	
				185	180				144					118		115	113	
				214	208				166					136		132	130	
				242	236				188					154		150	147	

COLORADO											
6.45%	6.5%	6.6%	7%	7.01%	7.1%	7.2%	7.25%	7.3%	7.5%	8%	
6.45	0	146	6.6	0	135	7.01	7.1	0	131	7.25	0
5002	1	161	5002	1	149	5002	5002	1	143	1	1
0	2	176		4	0	2	159	3	157	3	1
17	17	192		17	17	173	17	6	171	17	6
	23	207		21	21	20	187	20	19	18	
	38	223		35	35	34	201	34	33	31	
	53			49	49	48	215	47	46	43	
	69			64	64	62	229	61	59	56	
	84			78		76	243	75	73	68	
	99			92		90	256	89		81	
	115			107		104		102		93	
	130			121		118		116		106	

CONNECTICUT				
5.25%	6%	7%	7.5%	8%
0	198	0	0	0
1	218	1	1	1
2		2	1	3
16		8	7	6
27		24	21	19
46		41	35	33
65		58	49	46
84		74	64	59
103		91	78	73
122		108	92	
141		124	107	
160				
179				

DISTRICT OF COLUMBIA					
D.C. 5%	D.C. 5.75%	D.C. 6%	D.C. 6%	D.C. 8%	D.C. 9%
0	5.75	0	0	0	0
1	5002	1	1	1	1
1	0	1	1	1	6
10	8	12	8	12	6
22		17	24	16	149
42		35	41	27	27
82		53	58	39	38
62		71	74	50	49
110		89	91	62	61
		112	108	75	72
				90	83
				112	94

FLORIDA						
Combined			PANAMA CITY BEACH			
4%	5%	5.25%	6%	6.2%	7%	7.5%
0	175	0	5.25	0	6.2	0
1	209	1	5002	1	5002	1
5		1		1		1
9		9		9		9
25		20		16		15
50		40		33		30
75		60		50		46
109		80		66		61
125		109		83		76
150				109		92
						85
						209
						109
						93
						106
						120
						133
						146
						160
						173
						186
						209
						80

GEORGIA			
3%	4%	5%	6%
0	0	0	0
1	1	1	1
1	1	1	1
10	10	10	10
35	25	20	20
66	50	40	35
110	75	60	50
	110	80	67
		110	85
			110

HAWAII	
4%	
0	0
1	1
1	1
1	1
12	12
37	37

IDAHO				
3%	4%	4.5%	5%	
0	0	0	227	0
1	1	1		1
1	2	2		2
15	11	15		11
42	32	27		25
72	57	49		45
71				
93				
115				
137				
160				
183				
205				

ILLINOIS													
1%	1.25%	2%	5%	6%	6.25%	6.5%	6.75%	7%	7.5%	7.75%	8%	8.75%	
0	0	0	0	0	0	0	161	6.75	0	0	7.75	0	8.75
1	1	1	1	1	1	1	176	5002	1	1	5002	1	5002
1	1	1	6	1	1	1	192		1	1	0	1	0
49	39	24	12	8	7	7	207		8	6	6	6	5
148	119	74	25	24	23	23			22	19	18		
			46	41		38			36	33	31		
			67	58		53			50	46			
			88			69			65				
			109			84			79				
			129			99			93				
						115			108				
						130							
						146							

INDIANA				
1%	4%	5%	MARION County	RESTAURANT
0	0	0	0	0
1	1	1	1	1
1	2	1	2	1
49	15	9	15	9
148	37	29	37	29
	62		49	49
			62	49
			87	69
			112	89
			137	109

IOWA		
4%	5%	6%
0	0	0
1	1	1
3	1	1
12	9	8
37	29	24
50	41	41
75	58	74
	91	91
	108	

KANSAS																							
2.5%	3%	3.1%	3.25%	3.5%	3.75%	4%	4.1%	4.5%	4.9%	5%	5.25%	5.4%	5.5%	5.65%									
0	0	3.1	0	323	0	0	279	0	4.1	0	0	214	479	744	1010	0	5.25	0	194	435	0	190	5.65
1	1	5002	1	353	1	1	306	1	5002	1	1	234	499	765	1	1	5002	1	212	453	1	209	5002
3	1	0	1	384	1	1	333	1	0	1	1	255	520	785	1	1		1	231	472	1	0	
19	16	16	15	415	14	13	359	12	12	11	10	275	540	806	9	9		9	249	490	9	8	
59	49	46	46	42	39	386	37	33	30	295	561	826	581	846	29			27	268	287	27		
99	83	76	76	71	66	413	62	55	51	316	581	846	581	846				46	287	45			
139	116		107	99	93		87	77	71	336	602	867	602	867				64	305	63			
179			138	128	119		112	99	91	357	622	887	622	887				83	324	81			
			169	157	146			122	112	377	642	908	642	908				101	342	99			
			199	173	185			144	132	397	663	928	663	928				120	361	118			
			230	199				166	153	418	683	948	683	948				138	379	136			
			261	226				188	173	438	704	969	704	969				157	398	154			
			292	253				211	193	459	724	989	724	989				175	416	172			

KANSAS				
5.9%	6%	6.15%	6.4%	6.5%
5.9	0	6.15	6.4	6.5
5002	1	5002	5002	5002
0	7	0	0	0
8	8	8	7	7
	24		15	15
	41		26	163
	58		36	173
	74		47	184
	91		57	194
	108		68	64
	124		78	74
	141		89	84
	158		99	94

KENTUCKY	
5%	6%
0	0
1	1
6	2
10	8
25	24
46	41
67	58
88	74
109	88
129	94

LOUISIANA											
2%	3%	4%	4.5%	5%	6%	6%	7%	7.5%	8%	9%	
0	0	0	0	0	0	0	161	0	0	0	
1	1	1	1	1	1	1	176	1	1	1	
2	2	2	1	6	2	17	192	1	2	7	
24	16	12	11	10	8	7	207	7	6	4	
74	49	37	33	27	24	23	223	21	19	16	
124	82	62	55	47	41	38	238	35	33	29	
174	116	87	77	67	58	53	253	49	46	42	
224	149	112	99	87	74	69	269	64	59	55	
			122	109		84	284			67	61
			144	129		99	299			80	72
			166			115	315			93	83
			188			130	330			106	94
			211			146				105	

MAINE		
5%	6%	7%
0	0	7
1	1	2
1	1	0
10	9	7
20	16	21
40	33	35
60	50	49
80	66	64
110	83	78
	109	92
		100

MARYLAND		
4%	5%	Meals Tax
0	0	0
1	1	1
2	2	7
24	19	99
25	20	99
50	40	99
		99
		99
		100
		120
		140

MASSACHUSETTS		
4.625%	5%	
0	227	0
1	248	1
13	270	1
10	291	9
32	313	29
54	335	
75	356	
97	378	
118	399	
140	421	
162	443	
183		
205		

MICHIGAN	
4%	6%
0	0
1	1
7	2
12	10
31	24
54	41
81	58
108	74
135	91
162	108
187	124

MINNESOTA				
6%	6.5%	7%	8.5%	
0	0	161	0	123
1	1	176	1	135
1	1	192	1	147
8	7	207	7	158
24	23	21	17	170
41	38	35	29	182
58	53	49	41	194
69	64	52	205	
84	78	64		
99	92	76		
115	107	88		
130		99		
146		111		

MISSISSIPPI												
5%	6%	7%	7.25%	8%	8.5%	9%	9.25%					
0	0	0	0	144	324	0	0	123	0	9.25		
1	1	1	1	158	337	1	1	135	1	5002		
6	1	1	1	172	351	1	1	147	1	0		
11	8	7	6	186	365	6	5	158	5	5		
26	24	21	20	199	379	18	17	170	16			
47	41	35	34	213	393	31	29	182	27			
68	58	49	48	227	406	43	41	194	38			
88	74	64	62	241	56	52	205	49	49			
109	91	78	75	255	68	64	61	61	61			
129	108	92	89	268	81	76	72	72	72			
				103	282	93	88	83	83			
				117	296	106	99	94	94			
				131	310		111	105	105			

MISSOURI																									
4.225%	4.6%	4.625%	4.725%	4.75%	4.8%	4.975%	5.05%	5.1%	5.225%	5.6%	5.625%	5.725%	5.975%	6.1%	6.225%	6.3%	6.425%								
0	0	0	227	0	0	0	0	211	0	0	5.225	0	187	0	5.725	0	175	392	0	0	168	0	166	0	163
1	1	1	248	1	1	1	1	1	1	205	1	1	205	1	5002	1	192	410	1	1	184	1	182	1	178
1	1	13	270	4	3	3	1	5	1	223	1	2	209	1		2	209		2	200	8	198	1	194	
11	10	10	291	10	10	10	10	9	9	8	241	8	8	225	8	8	225		8	216	7	214	7	210	
35	32	32	313	31	22	31	30	19	29	26	258	26	25	242	24	24	242		24	232	23	230	23	225	
59	54	54	335	52	43	52	50	39	49	44	276	44	41	259	40	40	248		40	248	39	246	38	241	
82	76	75	356	74	65	72	70	59	68	62	294	62	58	276	57	56	265		57	265	55	54	54	256	
	97	97	378	95	86	93	90	79	88	80	312	79	75	292	73	72			73	72	71	70	70	272	
		118	399	116	107	114	110	98	107	98	330	97	92	309	90	88			92	88	87	85	85	287	
		140	421	137	128	135	130	118		115	348	115	108	326	104	103			108	103	101	101	101		
		162	443	158	149	156	150	138		133	366	133	125	342	120	119			125	120	119	116	116		
		183		179	170	177	170	158		1															

# Basic Setups and Operations

**N**

NEW HAMPSHIRE			
Rooms & Meals		Rooms & Meals	
7%	7%	8%	8%
0	129	0	128
1	143	1	142
8	158	8	157
14	172	35	171
26	186	35	185
39	201	38	200
51	50		37
63	62		50
75	74		62
88	87		
101	100		
115	114		

NEW JERSEY			
3%	3.5%	6%	7%
0	0	0	150
1	1	1	164
1	1	1	178
17	14	10	192
41	42	22	21
71	71	38	35
117	100	56	50
	128	72	64
	157	88	78
	185	110	92
	214		107
			121
			135

NEW MEXICO									
3.75%	4.25%	4.375%	4.5%	4.875%	5.175%	5.25%	5.375%	5.575%	5.75%
0	280	0	247	0	239	0	4.875	5.175	0
1	306	1	270	1	1	1	5002	5002	1
6	333	1	294	4					11
13	359	11	317	11					9
40		35	341	34					28
67		58	364	57					47
93		82	388	79					66
120		105	411	102					85
146		129		125					104
173		152		148					123
200		176		171					142
226		199		194					161
253		223		217					180

NEW MEXICO	
6.187%	6.1875%
0	6.1875
1	5002
4	0
9	8
23	
40	
56	
72	
88	
104	
120	
136	
153	

NEW YORK													
4%	5%	5.25%	5.75%	6%	6.25%	6.5%	6.75%	7%	7.25%	7.5%	8%	8.25%	8.5%
0	0	5.25	5.75	0	141	0	0	130	6.75	0	121	7.25	0
1	1	5002	5002	1	158	1	1	146	5002	1	135	5002	1
7	7			7	7	1	1	161		8	149	8	139
10	10			10	10	7	7	176		10	164	10	10
22	22			22	22	23	23	192		20	178	18	17
38	38			38	38	38	38	207		33	192	31	29
56	56			56	54	53				47	207	45	42
72	72			72	70	69				62		58	55
88	88			88	86	84				76		71	67
108	108			108	103	99				91		85	80
124	124			124	119	115				107		99	92

NORTH CAROLINA						
3%	4%	4.5%	5%	6%	6.25%	6%
0	0	0	188	0	0	0
1	1	1	211	1	1	1
4	5	6	233	6	2	2
9	9	9	255	8	10	8
35	29	25	277	23	24	24
70	59	53	299	48	41	41
116	84	75	322	67	58	58
149	112	95		85	74	74
183	137	122		109	91	91
216	144	129			108	108
	166				124	124

NORTH DAKOTA								
3%	4%	4%	5%	5.5%	6%	6.5%	7%	8%
0	0	0	0	0	182	0	0	170
1	1	1	1	1	200	1	1	185
3	5	2	2	2	219	3	2	200
15	15	15	15	15	15	15	15	15
33	31	25	20	19	17	31	231	15
67	51	50	40	37	34	47	29	25
100	71	75		55	50	62	43	38
133	100	100		73	67	77	58	50
166	125	125		91	84	93	72	63
200				110	108	108	86	75
				128	124	100	88	88
				146	139	115	100	100
				164	154			

OHIO						
5%	5.5%	5.75%	6%	6%	6.25%	6%
0	0	146	5.75	0	0	134
1	1	164	5002	1	1	1
2	2	182		2	3	2
15	15	200		15	16	15
20	18	218		17	17	16
40	36			34	34	32
	54			50	50	
	72			67	67	
	90			83	83	
	109			100	100	
	127			117	117	

OHIO				
CUYAHOGA Co.				
6.5%	7%	7%	7.75%	7.75%
0	123	0	115	0
1	138	1	128	1
3	153	3		
15	169	15	15	
15	184	15	15	
30	200	28	28	
46	215	42	42	
61	230	57	57	
76	71	71	71	
92	85	85	85	
107	100	100	100	

OKLAHOMA																	
2%	3%	3.25%	4%	4.25%	4.5%	5%	5.25%	6%	6.25%	6.725%	7%	7.25%	7.375%	8%	8.25%	9.25%	10.25%
0	0	0	323	0	4.25	0	0	5.25	0	0	6.725	0	7.25	7.375	0	0	0
1	1	1	353	1	5002	1	1	5002	1	1	5002	1	5002	5002	1	1	1
1	1	7	384	1	2	1	1	1	1	1	6	0	1	1	1	4	1
24	16	15	415	12	11	9	8	7	8	7	8	6	6	6	5	4	4
74	49	46	446	37	33	29	24	23	22	22	22	18	18	16	14	14	14
	83	76	476		55		41		37		51	31	31	30	27	24	24
	116	107	507		77		58		51		65	42	42	37	34	34	43
		138	538		99				65		79	54	48	48	43		
		169	569		121				79		94	66	59				
		199	599		144				94		108	78	70				
		230							108		122	90	81				
		261							122			103	91				
		292															

PENNSYLVANIA		
6%	7%	7%
0	0	150
1	1	150
1	5	167
10	10	184
17	17	210
34	34	217
50	50	234
67	50	250
84	67	250
110	84	
	110	
	117	
	134	

RHODE ISLAND		
6%	7%	7%
0	0	149
1	1	164
6	5	178
9	7	192
26	21	207
42	35	221
57	49	235
73	64	249
90	78	264
106	92	
123	107	
140	121	
	135	

SOUTH CAROLINA			
CHARLESTON			
4%	5%	6%	6%
0	0	0	0
0	1	1	1
5	6	2	2
10	10	10	10
25	20	24	24
50	40	41	41
75	60	41	41
112	80	58	58
137	109	74	74
	129	91	91
		108	108
		124	124

SOUTH DAKOTA						
4%	5%	5.5%	6%	6.5%	7%	7%
0	0	0	190	0	0	161
1	1	1	210	1	1	176
1	1	1	1	1	1	192
12	10	10	9	7	7	207
37	30	28	26	23	21	
		46	43	38	35	
		64	60	53	49	
		82	76	69	64	
		100	92	84	78	
		118	109	99	92	
		136		115	107	
		154		130	121	
		172		146	135	

TENNESSEE														
COUNTY TAX														
4.5%	5.5%	6%	6.25%	6.5%	6.75%	7%	7.25%	7.5%	7.75%	8%	8%	8.25%	8.5%	8.75%
0	188	0	154	354	0	0	0	130	0	125	0	121	0	117
1	211	1	172	372	1	1	1	146	1	140	1	1	1	130
1		11	190	390	2	2	2	161	8	155	2	10	144	2
11		10	209		10	10	10	176	10	170	10	10	158	10
33		27	227		24	23	23	192	22	185	21	20	172	19
55		45	245		41	39	38	207	37	199	35	34	185	33
77		63	263		58	55	53	223	51	214	49	48	185	46
99		81	281		74	71	69		66	229	64	61	185	59
122		99	299						81	244	78	75	185	89
144		119	318						96	259	92	89	185	99
166		136	336						111	274	107	103	185	103



TEXAS																							
											HOUSTON (Harris County)												
4%	4%	4.125%	4.625%	5%	5.125%	5.25%	5.375%	5.5%	5.625%	6%	DALLAS 6%	6%	6.125%	6.25%	6.25%	6.25%	6.75%						
0	0	0	206	4,625	0	5,125	0	161	5,375	0	155	0	151	0	0	0	6,125	0	6,25	0	125	288	
1	1	1	230	5002	1	5002	1	180	5002	1	173	1	168	1	1	1	5002	1	5002	1	140	303	
1	1	1	254		1		12	199		1	191	1		1	1					3	155	318	
12	12	12	278		9		9	219		9	209	8		8	9					8	170	333	
37	37	36	303		29		28	238		27		26		24	25		24		23		22	185	348
	62	60	327		49		47			45		44		41	42		41		39		37	199	362
	87	84	351		69		66			63		62		58	59		58		55		51	215	377
		109	375				85			81		79		74			74		71		66	229	392
		133	399				104			99		97		91			91		87		81	244	407
		157	424				123			118		115		108			108		103		96	259	422
		181					142			137		133							119		111	274	437

TEXAS							
7%	7.25%	7.5%	7.75%	8%	8.25%		
0	107	7.25	0	0	96	0	8.25
1		5002	1	1	109	1	5002
1			1	5	122	1	
1			6	6	135	6	
21			19	19	148	18	
35			33	32	161	31	
49			46	45	174		
64			59	58	187		
78			73	70			
92			86	83			

UTAH														
4.75%	5%	5.25%	5.375%	5.5%	5.75%	5.875%	6%	6.125%	6.25%	7%	7.25%			
0	221	0	0	199	0	0	190	5.75	5.875	0	6.125	0	0	7.25
1	242	1	1	219	1	1	209	5002	5002	1	5002	1	1	5002
1	263	1	1	238	1	1				0	2	0	4	2
10	284	9	9	257	9	9				8	8	8	7	7
31	305	29	28	276	27	27							23	21
52	326		47	295	46	45							27	35
73	347		66	314	65	63							47	49
94	368		85	333	83	81							63	64
115	389		104	352	102	99							78	
136	410		123	371		118							92	
157			142	390		136							107	
178			161	409		154								
199			180			172								

VERMONT			
3%	4%	5%	8%
0	0	0	0
1	1	1	1
4	2	2	0
13	10	10	18
33	25	20	31
66	50	40	43
100		80	56
133		100	68
166		120	81
200		140	93
		100	

VIRGINIA																			
ARLINGTON COUNTY			FAIRFAX CITY			HAMPTON		LEESBURG		RICHMOND		ALEXANDRIA		NEWPORT NEWS		RICHMOND			
4%			4.5%			Meals tax 7%		Restaurant 7%		Meal tax 7%		Restaurant 7.5%		7.5%		7.5%			
0	214	484	0	0	188	0	124	0	114	284	0	0	7.5	0	116	0	0	114	
1	234	512	1	1	211	1	144	1	134		1	1	5002	1	122	1	1	114	
33	25	20	2	5	233	4	188	1	166	13	149	1	1	1	144	2	5	134	
66	50	40	14	284	12	15	255	11	211	11	174	14	159	7	14	149	6	14	134
100		80	34	314	37	33	277	14	233	24	188	29	184	21	14	166	19	34	159
133		100	59	334	62	55	299	33	249	33	211	34	184	35	34	183	33	44	
166		120	84	359	87	77		55	255			44	214	49	59	188	46	44	
200		140	93	414	112	99		74				59	214	64	59	211	59	59	
				134	137	122		77				74	234	78	84	77		59	
				159	144	122		99				84	249	92	84	83		84	
				184	166	144		122				114	259	107	114	99		84	

VIRGINIA											
ROANOKE CITY VA BEACH		NORFOLK CITY			CITY OF RICHMOND						
8.5%		9%			Meal tax 9%			Food tax 9.5%		9.5%	
0	99	9	0	99	211	0	89	205	0	89	209
1	112	5002	1	99	233	1	99	1	99	1	99
1	122		6	122	233	1	110	1	109		
11	137		11	122		5	121	9	122		
12	144		33	144		15	131	11	129		
33	162		44	144		26	142	29	144		
37	166		44	166		36	152	33	149		
55	187		55	166		47	163	49	166		
62	188		55	188		57	173	55	169		
77	211		77	188		68	184	69	188		
87			77	211		78	194	77	189		

WASHINGTON																
7%	7.2%	7.3%	7.5%	7.55%	4.125%	7.8%	7.9%	8%	8.1%	8.1%	Combined		8.2%	8.7%		
0	0	131	0	129	0	126	0	0	0	117	8.1	0	115	262	408	0
1	1		1	143	1	139	1	1	1	129	2	1	128	274	420	1
1	1		1	156	1	153	2	3	151	0	2	1	140	286	432	1
7	6		6	170	6	166	7	6	164	6	6	6	152	296	445	5
21	20		19	184	19	179	19	19	177	19	18	18	164	310	457	17
35	34		33	198	33	193	33	32	190	32	31	31	176	323	469	28
49	48		47	211	46	206	46	46	203	44	44	43	189	335	481	
64	62		61	225	59	217	59	59	217	57	56	55	201	347	493	
78	76		74	239	73		72	72	230	70		67	213	359	506	
92	90		88	252	86			85	243	83		80	225	371		
107	104		102		99			98	256			92	237	384		
	118		115		113			111	269			104	249	396		

WEST VIRGINIA				
2%	3%	4%	5%	6%
0	0	0	0	0
1	1	1	1	1
2	2	1	2	2
25	5	12	5	5
50	35	37	20	16
100	70		40	33
	100			50
	135			67
				84
				100
				116

WISCONSIN				
4%	5%	5.5%	5.6%	
0	0	0	190	0
1	1	1	209	1
1	1	1		1
12	10	9		8
37	21	27		26
	41	45		44
	61	63		62
	81	81		80
	110	99		98
				118
				136
				154
				172

WYOMING			
3%	4%	5%	6%
0	0	0	0
1	1	1	1
2	2	2	3
24	24	24	24
49	37	29	24
83	62	49	34
116	69	51	
149	89	68	
	109	84	

# Basic Setups and Operations

## How to use your cash register...

The following describes the general procedure you should use in order to get the most out of your cash register.

### BEFORE business hours...

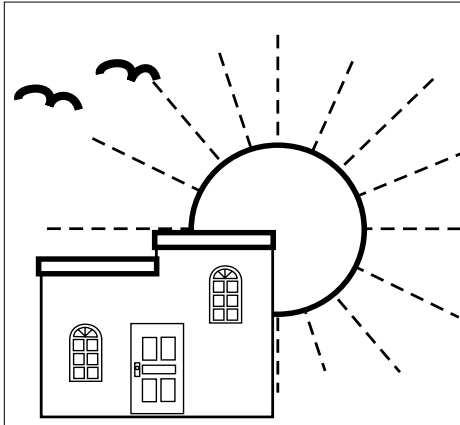

- Check to make sure that the cash register is plugged in securely. Page 3
- Check to make sure there is enough paper left on the roll. Page 16
- Read the financial totals to confirm that they are all zero. Page 70
- Check the date and time. Page 20

### DURING business hours...



- Register transactions. Page 30
- Periodically read totals. Page 68

### AFTER business hours...

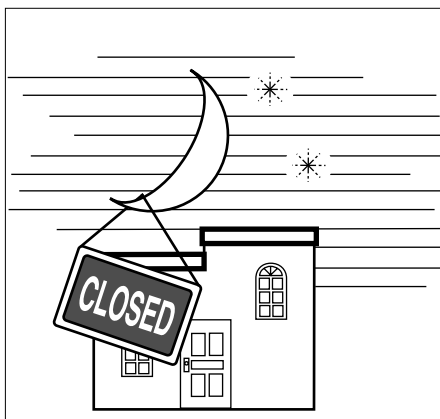

- Reset the daily totals. Page 72
- Remove the journal. Page 82
- Empty the cash drawer and leave it open. Page 10
- Take the cash and journal to the office.

## How to read the receipts and the journal...

- The journal and receipts are records of all transactions and operations.
- The contents printed on receipts and the journal are identical, except that the date is never printed on the journal except when you issue reports. A header stamp is automatically printed on each receipt.
- You can program the cash register to print the total amount of each transaction, and the details of premium, discount and reduction operation only, without printing department and PLU item registrations on the journal (page 55).
- You can program the cash register to either print or skip the following items on receipts and the journal. (See page 55, 62)
  - Time
  - Consecutive number
  - Taxable status
  - Taxable amount

### Receipt Sample

「YOUR RECEIPT THANK YOU」		Logo stamp
12•01•96		Date
01 12:35		Machine No./Time
No 0025		Consecutive No.
1 •10•00 I		
2 •5•00 II		
5 PL •1•50 I		
0•50 -		
•16•00 ST		
5%		
0•80 -		
•11•50 TA I		
•0•46 TX I		
•5•00 TA II		
•0•26 TX II		
•15•92 TL		
•20•00 CA AT		
•4•08 CG		

### Journal Sample (Item lines included)

01 12:40		
No 0026		
1 •10•00 I		
2 •5•00 II		
5 PL •1•50 I		
0•50 -		
•16•00 ST		
5%		
0•80 -		
•11•50 TA I		
•0•46 TX I		
•5•00 TA II		
•0•26 TX II		
•15•92 TL		
•20•00 CA AT		
•4•08 CG		

### Journal Sample (Item lines skip)

01 12:40		
No 0027		
0•50 -		
•16•00 ST		
5%		
0•80 -		
•11•50 TA I		
•0•46 TX I		
•5•00 TA II		
•0•26 TX II		
•15•92 TL		
•20•00 CA AT		
•4•08 CG		

*In the operation examples contained in this manual, the print samples are what would be produced if the roll paper is being used for receipts. They are not actual size. Actual receipts are 45mm wide. Also, all sample receipts and journals are printout images.*

## Preparing and using department keys

This section describes how to prepare and use department keys.

### Programming department keys

Before you use department keys, you should first tell the cash register how it should handle the registrations.

#### To program the maximum number of digits and tax calculations for each department

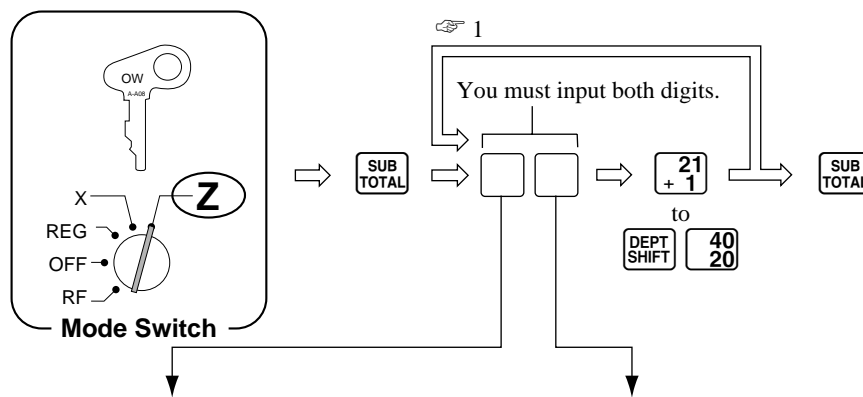

#### Maximum number of digits

This specification defines how many digits can be used for manual input of a unit price on the keyboard.

- No limit ⇒ **0**
- 1 digit ⇒ **1**
- 2 digits ⇒ **2**
- ⋮
- ⋮
- 5 digits ⇒ **5**
- 6 digits ⇒ **6**

Manual input not allowed ⇒ **9**

Selecting **9** means that you can perform department registrations using their preset unit prices only.

#### Tax table

This specification defines which tax table should be used for automatic calculation of taxes. See page 21 for information on setting up the tax tables.

- Tax table 1 ⇒ **2**
- Tax table 2 ⇒ **4**
- Tax table 1 and 2 ⇒ **6**
- No tax calculation ⇒ **0**

☞ 1 After you press a department key, you can loop back and start programming for another department.

☞ 2 Printing tax symbols I : Taxable 1  
II : Taxable 2  
III : Taxable 1 and 2

☞ 3 Tax status for the departments are initialized as follows:  
Department 1 ~ 10: Tax table 1 and 2  
Department 11 ~ 40: No tax calculation

## To program a unit price for each department

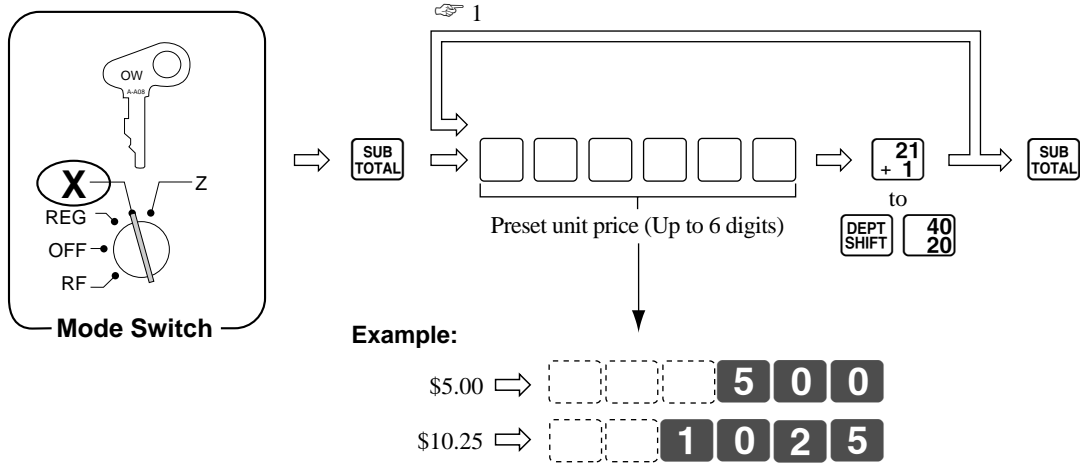

**1** After you press a department key, you can loop back and start programming for another department.

# Basic Setups and Operations

## Registering department keys

The following examples show how you can use the department keys in various types of registrations.

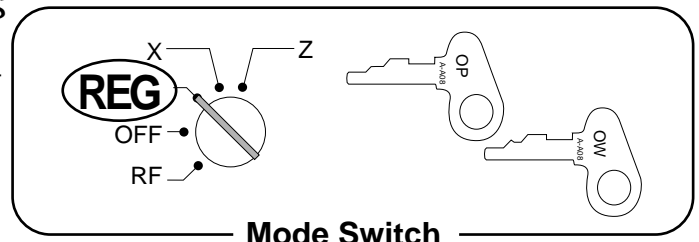

### Single-item sale

Example 1	Tag	Tax calculation	Qty	Tender
	DEPT 1	\$1.00	Tax Table 1	1
				Cash \$1.04

#### OPERATION



#### RECEIPT

Date 12·01·96  
 Machine No./Time 01 12:50  
 Consecutive No. No 0028  
 Department No./Unit price 1 ·1·00 I  
 ·1·00 TA I  
 ·0·04 TX I  
 ·1·04 CA

Example 2	Tag	Tax calculation	Qty	Tender
	DEPT 21	\$20.00	Tax Table 1	1
				Cash \$20.80

#### OPERATION

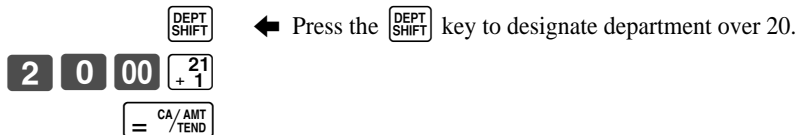

#### RECEIPT

12·01·96  
 01 12:55  
 No 0029  
 21 ·20·00 I  
 ·20·00 TA I  
 ·0·80 TX I  
 ·20·80 CA

### Exceeding maximum number of digits

Example	Tag	Maximum Number of Digits	Tax Calculation	Qty	Tender
	DEPT 3	\$10.00	3	Tax Table 1	1
					Cash \$20.00

#### OPERATION

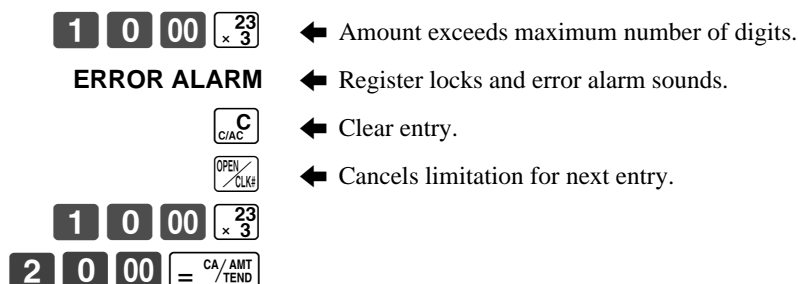

#### RECEIPT

12·01·96  
 01 13:00  
 No 0030  
 3 ·10·00 I  
 ·10·00 TA I  
 ·0·40 TX I  
 ·10·40 TL  
 ·20·00 CA AT  
 ·9·60 CG

## Repeat

Example	Tag	Tax Calculation	Qty	Tender
	DEPT 4	\$1.50	Tax Table 2	3
				Cash \$10.00

### OPERATION

**1 5 0**  $\frac{24}{\div 4}$   
 $\frac{24}{\div 4}$   
 $\frac{24}{\div 4}$   
 SUB TOTAL  
**1 0 00**  $\frac{CA}{AMT}$  /  $\frac{TEND}{TEND}$

### RECEIPT

```

12•01•96
01 13:05
No 0031

4 •1•50 II
4 •1•50 II
4 •1•50 II
•4•50 TA II
•0•24 TX II

•4•74 TL
•10•00 CA AT
•5•26 CC
    
```

## Multiplication

Example	Tag	Tax Calculation	Qty	Tender
	DEPT 1	\$1.00	Tax Table 1	12.5
				Cash \$20.00

### OPERATION

**1 2 . 5**  $\frac{X}{FOR}$  /  $\frac{DATE}{TIME}$   
**1 00**  $\frac{21}{+ 1}$   
**2 0 00**  $\frac{CA}{AMT}$  /  $\frac{TEND}{TEND}$

← Quantity (4-digit integer/2-digit decimal)

When you are performing a refund operation using the **RF** key (page 48) or in the RF Mode (page 49), you can enter 3 digits and 2 decimal places.

### RECEIPT

```

12•01•96
01 13:10
No 0032

12•5 Q
•1•00 @
1 •12•50 I
•12•50 TA I
•0•50 TX I

•13•00 TL
•20•00 CA AT
•7•00 CC
    
```

## Preset price

Example	Tag	Tax Calculation	Qty	Tender
	DEPT 2	\$5.00 Preset	Tax Table 2	1
				Cash \$5.26

### OPERATION

$\frac{22}{- 2}$   
 $\frac{CA}{AMT}$  /  $\frac{TEND}{TEND}$

### RECEIPT

```

12•01•96
01 13:15
No 0033

2 •5•00 II
•5•00 TA II
•0•26 TX II

•5•26 CA
    
```

# Basic Setups and Operations

## Split sales of packaged items

Example	Tag	Tax Calculation	Qty	Tender
	DEPT 3      4 for \$10.00	Tax Table 2	3	Cash      \$10.00

### OPERATION

- 3 X/ FOR  
DATE  
TIME ← Quantity being purchased (you can input 4 digits and 2 decimal places)\*
  
- 4 X/ FOR  
DATE  
TIME ← Quantity contained in the full package (you can input 4 digits and 2 decimal places)
  
- 1 0 00 23  
x  
3 ← Price of the package
  
- 1 0 00 = CA/ AMT  
/ TEND

### RECEIPT

```

12•01•96
01 13:20
No 0034

3      Q
4
•10•00 @
3 •7•50 II
  •7•50 TA II
  •0•39 TX II

•7•89 TL
•10•00 CA AT
•2•11 CC
    
```

\* When you are performing a refund operation using the RF key (page 48) or in the RF Mode (page 49), you can enter 3 digits and 2 decimal places.



# Registering PLUs

This section describes how to prepare and use PLUs.

## Programming PLUs

Before you use PLUs, you should first tell the cash register how it should handle the registrations.

### To program a unit price for each PLU

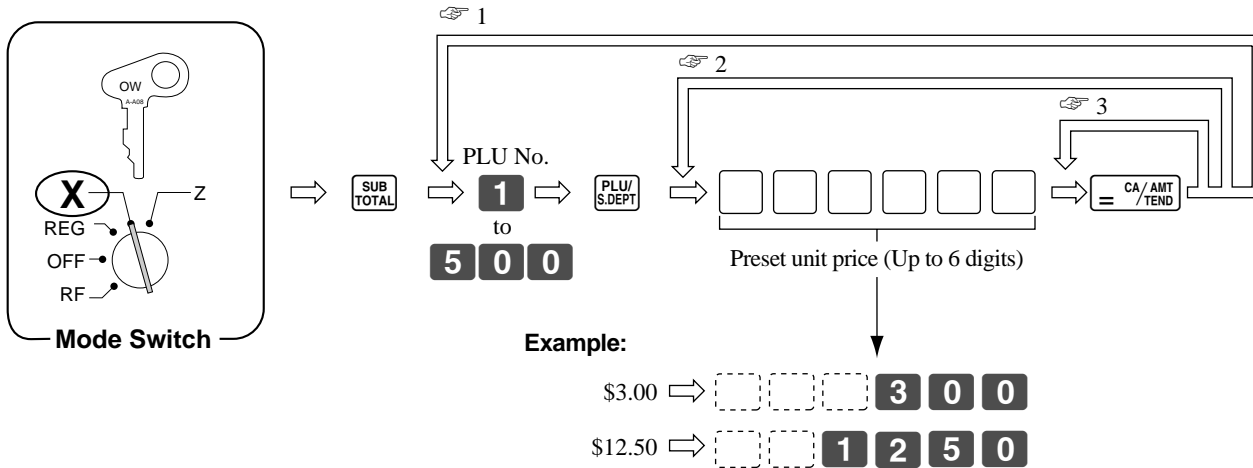

- ☞ 1 After you press the **CA/AMT/TEND** key, you can loop back and start programming for another PLU by inputting a new PLU number.
- ☞ 2 When you press the **CA/AMT/TEND** key, you can loop back and input another unit price, which will be assigned to the next PLU.
- ☞ 3 Press the **CA/AMT/TEND** key again to program the next PLU number with the same unit price.

# Basic Setups and Operations

## To program PLU links to departments, tax calculations and PLU/sub-department specifications

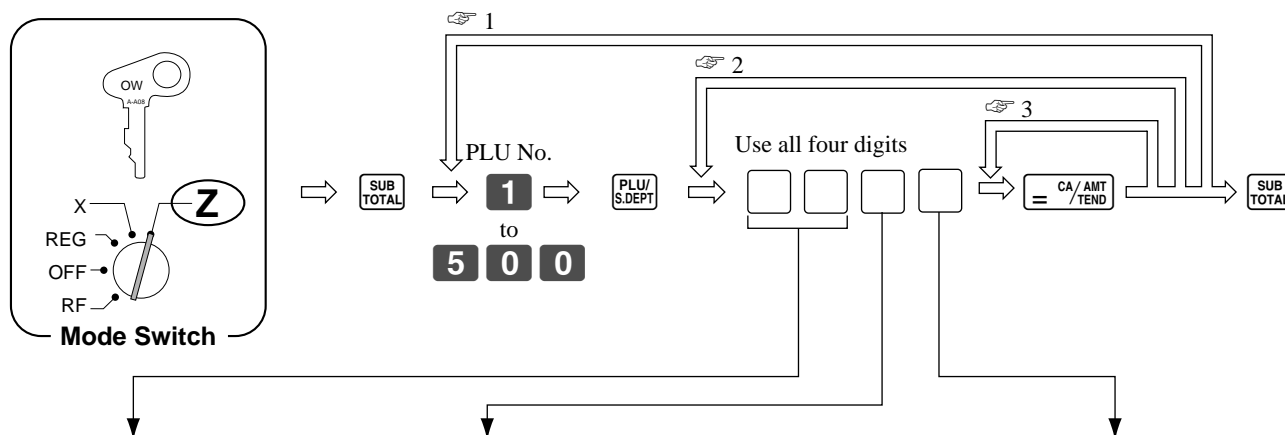

### Linked department

This specification links the PLU to a department.

Department 1	⇒	<b>0 1</b>
Department 2	⇒	<b>0 2</b>
Department 3	⇒	<b>0 3</b>
Department 4	⇒	<b>0 4</b>
Department 5	⇒	<b>0 5</b>
⋮		
Department 36	⇒	<b>3 6</b>
Department 37	⇒	<b>3 7</b>
Department 38	⇒	<b>3 8</b>
Department 39	⇒	<b>3 9</b>
Department 40	⇒	<b>4 0</b>
Non link	⇒	<b>0 0</b>

### Tax table

This specification defines which tax table should be used for automatic calculation of taxes. See page 21 for information on setting up the tax tables.

Tax table 1	⇒	<b>2</b>
Tax table 2	⇒	<b>4</b>
Tax table 1 and 2	⇒	<b>6</b>
No tax calculation	⇒	<b>0</b>

### Sub-department/PLU specification

Treat as a PLU ⇒ **0**

Treat as a sub-department ⇒ **1**

A PLU can register its preset unit price only. A sub-department can register its preset price or a manually entered price.

- 1 After you press the **CA/AMT/TEND** key, you can loop back and start programming for another PLU by inputting a new PLU number.
- 2 When you press the **CA/AMT/TEND** key, you can loop back and input another specification which will be assigned to the next PLU.
- 3 Press the **CA/AMT/TEND** key again to program the next PLU number with the same specification.
- 4 All PLUs are initialized as no tax calculation.

# Registering PLUs and sub-departments

The following examples show how you can use PLUs and sub-departments in various types of registrations.

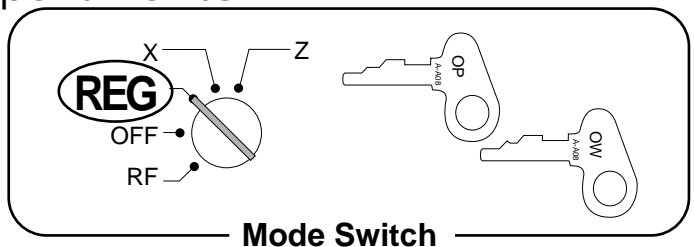

## PLUs

Example	Tag	Tax Calculation	Qty	Tender
	PLU 14      \$2.50 Preset	Tax Table 2	1	Cash      \$2.63

### OPERATION

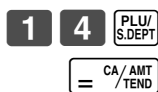

### RECEIPT

12	01	96
01	13:25	
	No	0035
14 PL	• 2.50	II
	• 2.50	TA II
	• 0.13	TX II
	• 2.63	CA

## Sub-departments

Example	Tag	Tax Calculation	Qty	Tender
	SUB-DEPT 15      \$6.00	Tax Table 1	1	Cash      \$6.24

### OPERATION

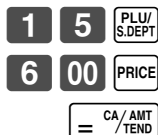

← Press the **PRICE** key to enter unit prices for sub-departments.

### RECEIPT

12	01	96
01	13:30	
	No	0036
15 PL	• 6.00	I
	• 6.00	TA I
	• 0.24	TX I
	• 6.24	CA

## PLU repeat

Example	Tag	Tax Calculation	Qty	Tender
	PLU 2      \$1.20	Tax Table 2	3	Cash      \$3.79

### OPERATION

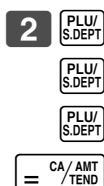

### RECEIPT

12	01	96
01	13:35	
	No	0037
2 PL	• 1.20	II
2 PL	• 1.20	II
2 PL	• 1.20	II
	• 3.60	TA II
	• 0.19	TX II
	• 3.79	CA

# Basic Setups and Operations

## Sub-department repeat

Example	Tag	Tax Calculation	Qty	Tender
	(A) SUB-DEPT 15 \$3.00 Preset	Tax Table 1	3	Cash \$20.00
	(B) SUB-DEPT 15 \$2.00	Tax Table 1	2	

### OPERATION

**1 5**   
 ← Press the  key without inputting a unit price to register the unit price preset to the sub-department.  
  
  
**1 5**   
**2 00**   
  
  
**2 0 00**

### RECEIPT

12	•	01	•	96
01		13	:	40
		No		0038
15	PL		•	3.00 I
15	PL		•	3.00 I
15	PL		•	3.00 I
15	PL		•	2.00 I
15	PL		•	2.00 I
			•	13.00 TA I
			•	0.52 TX I
			•	13.52 TL
			•	20.00 CA AT
			•	6.48 CG

## PLU multiplication

Example	Tag	Tax Calculation	Qty	Tender
	PLU 2 \$1.20 Preset	Tax Table 2	15	Cash \$20.00

### OPERATION

**1 5**   
**2**   
**2 0 00**

### RECEIPT

12	•	01	•	96
01		13	:	45
		No		0039
		15		Q
			•	1.20 @
2	PL		•	18.00 II
			•	18.00 TA II
			•	0.95 TX II
			•	18.95 TL
			•	20.00 CA AT
			•	1.05 CG

- The quantity can be any value with an integer up to 4 digits, and a decimal up to 2 digits.
- If the result of the calculation is longer than 7 digits, an error occurs.

## Sub-department multiplication

Example	Tag	Tax Calculation	Qty	Tender
	SUB-DEPT 15 \$6.00	Tax Table 1	1.25	Cash \$10.00

### OPERATION

**1** **.** **2** **5**  / FOR DATE TIME ← Quantity  
**1** **5**  PLU / S.DEPT  
**6** **0** **0**  PRICE  
**1** **0** **00**  CA / AMT / TEND =

### RECEIPT

12	01	96	
01	13	50	
	No	0040	
		1.25	Q
		.6.00	@
15	PL	.7.50	I
		.7.50	TA I
		.0.30	TX I
		.7.80	TL
		.10.00	CA AT
		.2.20	CG

- The quantity can be any value with an integer up to 4 digits, and a decimal up to 2 digits.
- If the result of the calculation is longer than 7 digits, an error occurs.

## Mixed registration (department, sub-department, PLU)

Example	Tag	Tax Calculation	Qty	Tender
	DEPT 3 \$2.50 Preset	Tax Table 1	6	Cash \$30.00
	DEPT 4 \$2.00	Tax Table 2	2	
	PLU 4 \$1.40 Preset	Tax Table 2	2	
	SUB-DEPT 15 \$3.00	Tax Table 1	2	

### OPERATION

**6**  / FOR DATE TIME ← Quantity for multiplication  
 23 x 3  
**2** **00**  24 ÷ 4  
 24 ÷ 4  
**4**  PLU / S.DEPT  
 PLU / S.DEPT  
**1** **5**  PLU / S.DEPT  
**3** **00**  PRICE  
 PRICE  
**3** **0** **00**  CA / AMT / TEND =

### RECEIPT

12	01	96	
01	13	55	
	No	0041	
		6	Q
		.2.50	@
3		.15.00	I
4		.2.00	II
4		.2.00	II
4	PL	.1.40	II
4	PL	.1.40	II
15	PL	.3.00	I
15	PL	.3.00	I
		.21.00	TA I
		.0.84	TX I
		.6.80	TA II
		.0.36	TX II
		.29.00	TL
		.30.00	CA AT
		.1.00	CG

# Basic Setups and Operations

## Split sales of packaged items

### 1) PLU

Example	Tag	Tax Calculation	Qty	Tender
	PLU No. 28 5 for \$20.00	Tax Table 2	3	Cash \$15.00

#### OPERATION

- 3**  FOR DATE TIME ← Quantity being purchased (you can input 4 digits and 2 decimal places)\*
- 5**  FOR DATE TIME ← Quantity contained in the full package (you can input 4 digits and 2 decimal places)
- 2 8**  PLU/S.DEPT ← Price of the package
- 1 5 00**  CA/AMT/TEND

\* When you are performing a refund operation using the **RF** key (page 48) or in the RF Mode (page 49), you can enter 3 digits and 2 decimal places.

#### RECEIPT

12	01	96
01	14	00
No 0042		
3		Q
5		
28 PL	•20.00	@
	•12.00	II
	•12.00	TA II
	•0.63	TX II
	•12.63	TL
	•15.00	CA AT
	•2.37	CC

### 2) Sub-department

Example	Tag	Tax Calculation	Qty	Tender
	SUB-DEPT 37 12 for \$30.00	Tax Table 1	7	Cash \$20.00

#### OPERATION

- 7**  FOR DATE TIME ← Quantity being purchased (you can input 4 digits and 2 decimal places)\*
- 1 2**  FOR DATE TIME ← Quantity contained in the full package (you can input 4 digits and 2 decimal places)
- 3 7**  PLU/S.DEPT ← Price of the package
- 3 0 00**  PRICE
- 2 0 00**  CA/AMT/TEND

\* When you are performing a refund operation using the **RF** key (page 48) or in the RF Mode (page 49), you can enter 3 digits and 2 decimal places.

#### RECEIPT

12	01	96
01	14	05
No 0043		
7		Q
12		
37 PL	•30.00	@
	•17.50	I
	•17.50	TA I
	•0.70	TX I
	•18.20	TL
	•20.00	CA AT
	•1.80	CC

# Registering premiums and discounts

This section describes how to prepare and register premiums and discounts.

## Programming premiums and discounts

You can use the [%] key to register either discounts (percentage decreases) or premiums (percentage increases). The following procedures let you select the operation you want for the [%] key. They also let you program the tax calculation method, the tax rounding method, and a preset rate.

### To program tax calculation, tax rounding and the function of the [%] key

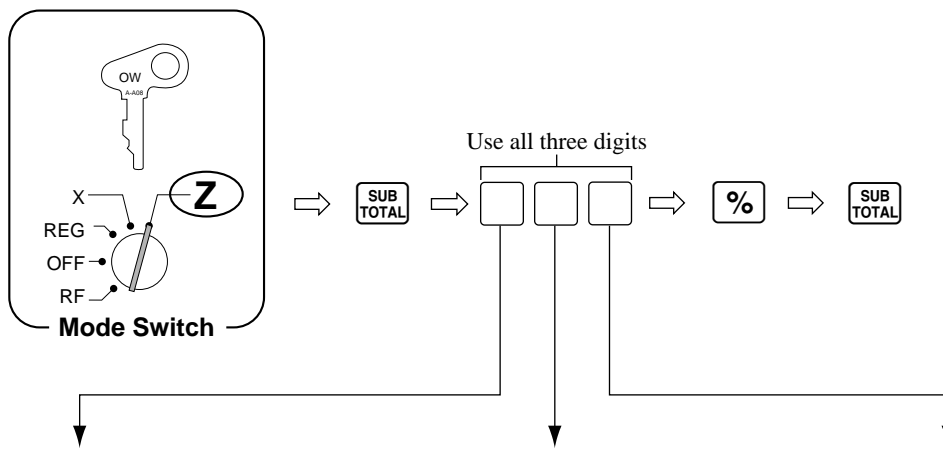

#### Tax status for subtotals

This specification defines where the result of the percent calculation on a subtotal should be reflected (added to or subtracted from) for tax purposes. Note that this specification is for calculations with subtotals only, and is not applied for calculations involving individual items.

- Tax Table 1      ⇨    **1**
- Tax Table 2      ⇨    **2**
- Tax Table 1 and 2   ⇨   **3**
- No tax calculation   ⇨   **0**

#### Rounding method

This specification defines the method used to round the result of a percentage calculation.

- Round off      ⇨    **0**
- Round up      ⇨    **1**
- Cut off        ⇨    **2**

#### Key function specification

This specification defines the function of the [%] key.

- Use [%] as discount key (%-)   ⇨    **0**
- Use [%] as premium key (%+)   ⇨    **1**

- Tax status for the [%] key is initialized as tax table 1 and 2.

# Basic Setups and Operations

## To program a rate to the [%] key

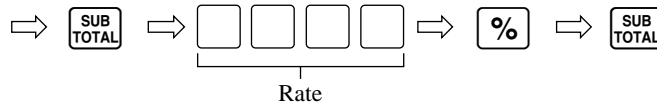
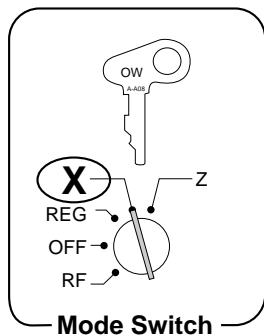

### Example:

- 10% ⇒ **1 0**
- 5.5% ⇒ **5 . 5**
- 12.34% ⇒ **1 2 . 3 4**

## Registering premiums and discounts

The following examples show how you can use the [%] key in various types of registrations.

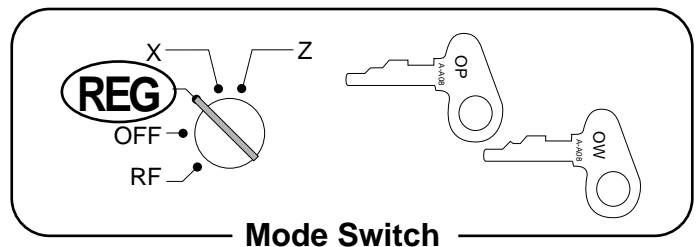

### Discount for items and subtotals

Example	Tag	Tax Calculation	Discount	Subtotal Discount	Tender
	DEPT 1 \$5.00	Tax Table 1		3.5%	Cash \$14.64
	PLU 16 \$10.00 Preset	Tax Table 2	5% Preset	Tax Table 1 & 2 Preset	

### OPERATION

- 5 00** **21** **+ 1**
- 1 6** **PLU/S.DEPT**
- [%]** ← Applies the preset discount rate (5%) to the last item registered (PLU 16).
- MD/ST** ← Note that you cannot use the **SUB TOTAL** key for this operation.
- 3 . 5** **[%]** ← Applies the input discount rate (3.5%) to the subtotal. The input value takes priority of the preset rate.
- =** **CA/AMT/TEND**

### RECEIPT

12	01	96	
01	14	10	
	No	0044	
1	• 5	00	I
16 PL	• 10	00	II
	5%		
	0	50	II
			-
	• 14	50	ST
	3	5%	
	0	51	III
			-
	• 4	82	TA I
	• 0	19	TX I
	• 9	17	TA II
	• 0	46	TX II
	• 14	64	CA

- You can manually input rates up to 4 digits long (0.01% to 99.99%).



## Premium for items and subtotals

Example	Tag	Tax Calculation	Premium	Subtotal Premium	Tender
	DEPT 4 \$10.00 Preset	Tax Table 2	7%	5% Preset Tax Table 1 & 2 Preset	Cash \$20.00
	PLU 32 \$5.00 Preset	Tax Table 2			

### OPERATION

### RECEIPT

24 ÷ 4  
7 % ← Applies the input value as a premium rate (7%).  
3 2 PLU/S.DEPT  
MD/ST ← Note that you cannot use the SUB/TOTAL key for this operation.  
% ← Applies the preset premium rate (5%) to the subtotal.  
2 0 00 = CA/AMT/TEND

- You can manually input rates up to 4 digits long (0.01% to 99.99%).

12	•	01	•	96	
01		14	:	10	
		No		0045	
4		•	10	•	00 II
				7%	
		•	0	•	70 II
32	PL	•	5	•	00 II
		•	15	•	70 ST
				5%	
		•	0	•	79 III
		•	16	•	49 TA II
		•	0	•	87 TX II
		•	17	•	36 TL
		•	20	•	00 CA AT
		•	2	•	64 CG

### Taxable status of the % key

- Whenever you perform a discount/premium operation on the last item registered, the tax calculation for the discount/premium amount is performed in accordance with the tax status programmed for that item.
- Whenever you perform a discount/premium operation on a subtotal amount, the tax calculation for the subtotal amount is performed in accordance with the tax status programmed for the % key.

## Registering reductions

### Programming for reductions

You can use the **[−]** key to reduce single items or subtotal amounts.

The following procedure lets you program the tax calculation method for the **[−]** key.

#### To program tax calculation for the **[−]** key

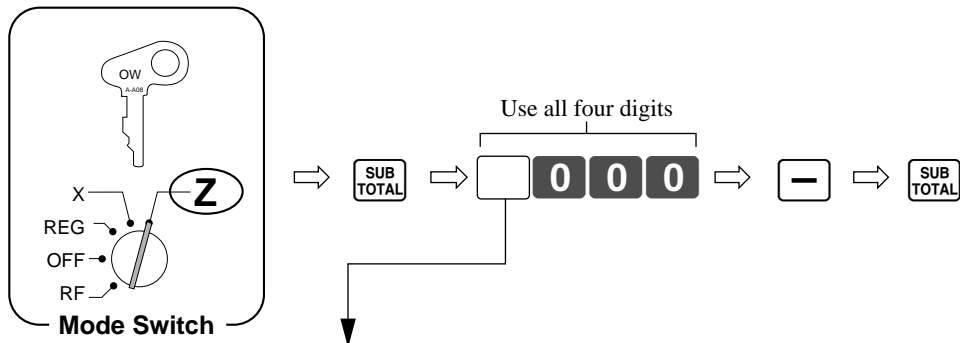

#### Tax Status

This specification defines where the result of the reduction should be reflected (subtracted from) for tax purposes.

Taxable amount 1	⇒	<b>1</b>
Taxable amount 2	⇒	<b>2</b>
Taxable amount 1 and 2	⇒	<b>3</b>
Do not reflect	⇒	<b>0</b>

- Tax status for the **[−]** key is initialized as no tax calculation.

#### • Taxable status of the **[−]** key

The tax calculation for the reduction amount is performed in accordance with the tax status programmed for the

**[−]** key, regardless of whether the reduction is performed on the last item registered or a subtotal amount.

# Registering reductions

The following examples show how you can use the  key in various types of registrations.

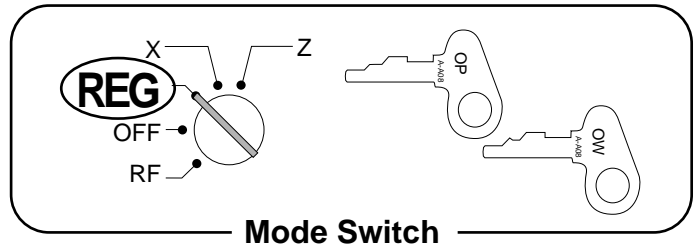

## Reduction of individual items

Example:

Tag	Tax Calculation	Reduction	Tender
DEPT 1 \$5.00	Tax Table 1	\$0.25	Cash \$10.69
PLU 45 \$6.00 Preset	Tax Table 1	\$0.50	

### OPERATION

← Reduces the last amount registered (500 to DEPT 1) by the value (25) input here.

### RECEIPT

```

12·01·96
01 14:20
No 0046

1      ·5·00 I
      0·25 -
4 5 PL ·6·00 I
      0·50 -
      ·11·00 TA I
      ·0·44 TX I

      ·10·69 CA
    
```

- You can manually input reduction values up to 7 digits long.
- The amount you input for the reduction is not subtracted from the department totalizer.

## Reduction of subtotals

Example:

Tag	Tax Calculation	Reduction of Subtotal	Tender
DEPT 1 \$3.00	Tax Table 1	\$0.75	Cash \$7.00
DEPT 2 \$4.00	Tax Table 2		

### OPERATION

← Reduces the subtotal by the value (75) input here.

### RECEIPT

```

12·01·96
01 14:25
No 0047

1      ·3·00 I
2      ·4·00 II
      0·75 -
      ·3·00 TA I
      ·0·12 TX I
      ·4·00 TA II
      ·0·21 TX II

      ·6·58 TL
      ·7·00 CA AT
      ·0·42 CG
    
```

# Basic Setups and Operations

## Calculating the merchandise subtotal

Use the operation shown below to calculate the merchandise subtotal, which includes the actual cost of the merchandise only without the add-on tax.

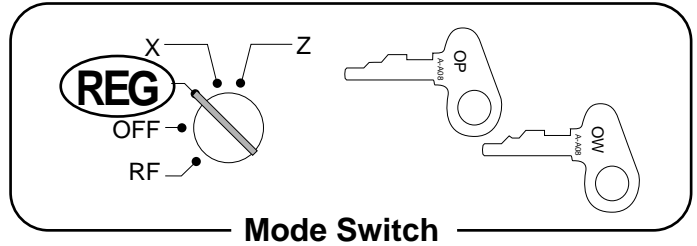

**Example**

Tag		Tax Calculation
DEPT 1	\$1.00	Tax Table 1
DEPT 2	\$2.00	Tax Table 2
DEPT 3	\$3.00	Tax Table 1

### OPERATION

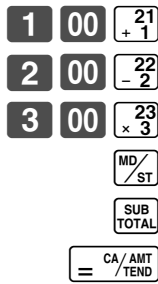

- ← Calculates the merchandise subtotal.
- ← Calculates the subtotal with add-on tax.

### RECEIPT

12•01•96		
01 14:30		
No 0048		
1	• 1•00	I
2	• 2•00	II
3	• 3•00	I
	• 6•00	ST
	• 4•00	TA I
	• 0•16	TX I
	• 2•00	TA II
	• 0•11	TX II
	• 6•27	CA

- You cannot use the  key to calculate the subtotal for a partial tender.

# Shifting the taxable status of an item

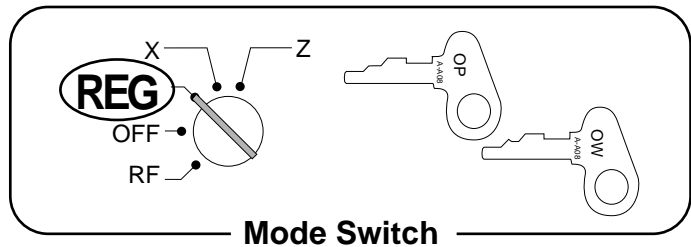

Example	Tag		Tax Calculation
	DEPT 4	\$4.00	Tax Table 2
	DEPT 20	\$5.00	No tax calculation → Tax Table 1
	DEPT 1	\$6.00	Tax Table 1 → Tax Table 1 & 2
	DEPT 4	\$7.00	Tax Table 2 → No tax calculation

## OPERATION

4 00  $\frac{24}{\div 4}$

$\frac{RA}{T/S1}$

← This operation changes the tax status of the next entry (DEPT 20) to Taxable 1 (from Non-Taxable).

5 00  $\frac{40}{20}$

$\frac{PO}{T/S2}$

← This operation changes the tax status of the next entry (DEPT 1) to Taxable 1 plus Taxable 2 (from Taxable 1 only).

6 00  $\frac{21}{+ 1}$

$\frac{PO}{T/S2}$

← This operation changes the tax status of the next entry (DEPT 4) to Non-Taxable (from Taxable 2).

7 00  $\frac{24}{\div 4}$

$\frac{CA}{AMT}$   
 $\frac{=}{TEND}$

## RECEIPT

12·01·96  
01 14:35  
No 0049

4     ·4·00 II  
20    ·5·00 I  
1     ·6·00 III  
4     ·7·00  
      ·11·00 TA I  
      ·0·44 TX I  
      ·10·00 TA II  
      ·0·53 TX II  
  
      ·22·97 CA

## Important!

- To change the taxable status of the next item to be registered, be sure to press  $\frac{RA}{T/S1}$  or  $\frac{PO}{T/S2}$  without inputting any value.
- If the last item registered is programmed as non-taxable, a premium/discount ( $\frac{\%}{\%}$  key) operation on this item is always non-taxable.

In this case, you cannot manually change the tax status to Taxable 1 ( $\frac{RA}{T/S1}$ ) or Taxable 2 ( $\frac{PO}{T/S2}$ ) key .

# Basic Setups and Operations

## Registering charge and check payments

The following examples show how to register charges and payments by check.

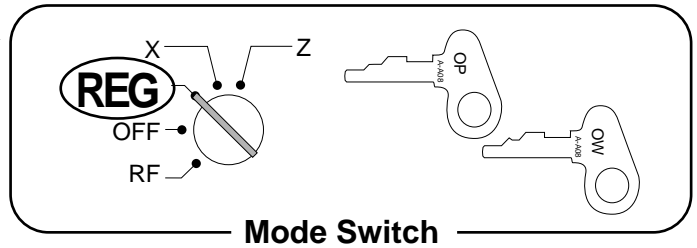

### Check

Example

Tag	Tax Calculation	Tender
DEPT 1 \$10.00	Tax Table 1	Check \$10.40

#### OPERATION

1 0 00  $\frac{21}{+1}$   
 [CHK]

#### RECEIPT

```

12•01•96
01 14:40
No 0050

1 •10•00 I
  •10•00 TA I
  •0•40 TX I

•10•40 CK
    
```

### Charge

Example

Tag	Tax Calculation	Tender
DEPT 4 \$15.00	Tax Table 2	Charge \$15.79

#### OPERATION

1 5 00  $\frac{24}{\div 4}$   
 1 2 3 4 5 #/NS  
 [CH]

← Reference number

← You cannot input the amount tendered for a charge sale. If you input a number before pressing [CH], an error occurs.

#### RECEIPT

```

12•01•96
01 14:45
No 0051

4 •15•00 II
  12345 #
  •15•00 TA II
  •0•79 TX II

•15•79 CH
    
```

### Mixed cash, check, charge

Example

Tag	Tax Calculation	Tender
DEPT 4 \$55.00	Tax Table 2	Charge \$22.89
		Check \$30.00
		Cash \$5.00

### OPERATION

5 5 00  $\frac{24}{4}$   
 3 0 00 CHK  
 5 00 =  $\frac{CA}{AMT}$  /  $\frac{TEND}$   
 CH

### RECEIPT

12•01•96  
 01 14:50  
 No 0052  
  
 4 •55•00 II  
 •55•00 TA II  
 •2•89 TX II  
  
 •57•89 TL  
 •30•00 CK  
 •5•00 CA  
 •22•89 CH

# Basic Setups and Operations

## Registering returned goods in the REG mode

The following examples show how to use the **RF** key in the REG mode to register goods returned by customers.

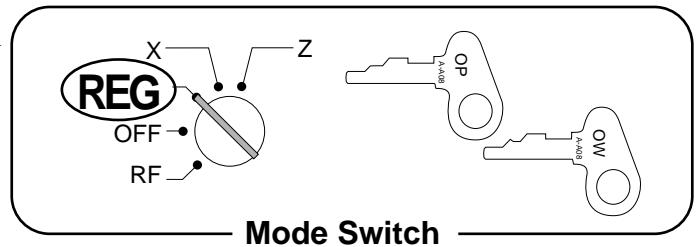

**Example**

Tag	Tax Calculation	Returned or Cancelled	Payment
DEPT 1      \$2.35	Tax Table 1	DEPT 1      \$2.35	Cash      \$2.11
DEPT 2      \$2.00	Tax Table 2		
PLU 2      \$1.20 Preset	Tax Table 2	PLU 2      \$1.20 Preset	

### OPERATION

```

2 3 5 [21 + 1]
  2 00 [22 - 2]
    2 [PLU/S.DEPT]
      [RF]

2 3 5 [21 + 1]
  [RF]
    2 [PLU/S.DEPT]
      [CA/AMT/TEND]
  
```

← Pressing **RF** specifies that the next item registered is a return. You have to press **RF** before registering each returned item.

### RECEIPT

```

12•01•96
01 14:55
No 0053

1 •2•35 I
2 •2•00 II
2 PL •1•20 II
1 •2•35 RF I
-
2 PL •1•20 RF II
-
•2•00 TA II
•0•11 TX II

•2•11 CA
  
```



# Registering returned goods in the RF mode

The following examples show how to use the RF mode to register goods returned by customers.

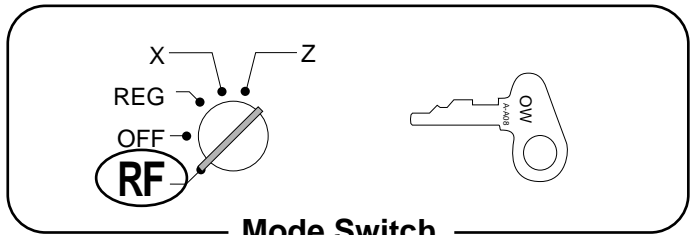

## Normal refund transaction

Example	Returned Goods	Tax Calculation	Qty	Payment
	DEPT 1 \$1.50	Tax Table 1	2	Cash \$10.70
	PLU 2 \$1.20 Preset	Tax Table 2	6	

### OPERATION

**1** **5** **0** **21**  
 + **1**  
**21**  
 + **1**  
**6** **X/FOR** ← Quantity for multiplication.  
 DATE TIME  
**2** **PLU/**  
**S.DEPT**  
**=** **CA/AMT** ← Do not enter an amount here.  
**TEND**

### RECEIPT

```

12•01•96
01 15:00
No 0054 RF
1 •1.50 I
1 •1.50 I
6 •1.20 Q
2 PL •7.20 II
•3.00 TA I
•0.12 TX I
•7.20 TA II
•0.38 TX II
•10.70 CA
    
```

## Reduction of amounts paid on refund

Example	Returned Goods	Tax Calculation		Payment
	DEPT 3 \$4.00	Tax Table 1	\$0.15	Cash \$5.21
	PLU 2 \$1.20 Preset	Tax Table 2	5% Preset	

### OPERATION

**4** **00** **23**  
 x **3**  
**1** **5** **-** ← Subtracts 15 from the price of the last item registered.  
**2** **PLU/**  
**S.DEPT**  
**%** ← Reduces the price of the last item registered by the  
 preset discount rate (5%).  
**=** **CA/AMT**  
**TEND**

### RECEIPT

```

12•01•96
01 15:05
No 0055 RF
3 •4.00 I
0.15 -
2 PL •1.20 II
5%
0.06 II
-
•4.00 TA I
•0.16 TX I
•1.14 TA II
•0.06 TX II
•5.21 CA
    
```

## Important!

- To avoid miss registrations in the RF mode, return the mode switch to the former position immediately.

# Basic Setups and Operations

## Registering money received on account

The following example shows how to register money received on account. This registration must be performed alone, and cannot be performed as part of another registration.

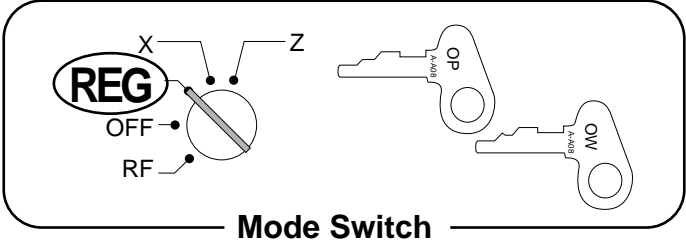

Example	<b>Amount Received</b>
	\$700.00

### OPERATION

**7 00 00**  ← Amount can be up to 8 digits.

### RECEIPT

```

12•01•96
01 15:10
No 0056

•700•00 RA
    
```

## Registering money paid out

The following example shows how to register money paid out from the drawer. This registration must be performed alone, and cannot be performed as part of another registration.

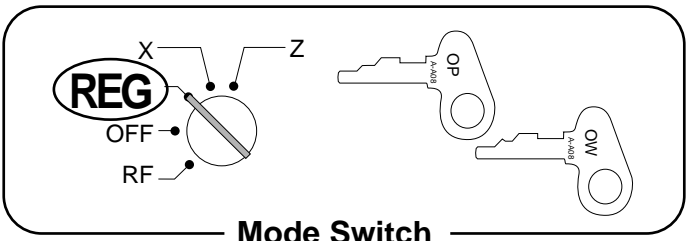

Example	<b>Amount Paid Out</b>
	\$1.50

### OPERATION

**1 5 0**  ← Amount can be up to 8 digits.

### RECEIPT

```

12•01•96
01 15:15
No 0057

•1•50 PO
    
```

# Making corrections in a registration

There are three techniques you can use to make corrections in a registration.

- Correcting an item that you have input but not yet registered.
- Correcting the last item you have input and registered.
- Cancelling all items in a transaction.

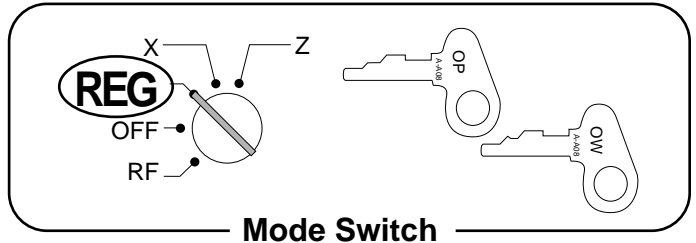

## Correcting an item you have input but not yet registered

### Correction Examples

EXAMPLE	OPERATION	RECEIPT
Amount	1 0 00 ← Wrong	<pre> 12•01•96 01 15:20 No 0058  1 •1•00 I 11 Q •2•00 @ 2 •22•00 II 3 PL •1•30 I 15 PL •10•00 I •12•30 TA I •0•49 TX I •22•00 TA II •1•16 TX II  •35•95 TL •15•00 CA •20•95 CH                     </pre>
	← Clear	
Quantity	1 00  ← Correction	
	1 2  ← Wrong	
	2 00	
	← Clear	
PLU No.	1 1  ← Correction	
	2 00	
	2 ← Wrong	
Sub-department	← Clear	
	3  ← Correction	
	1 5	
	6 00 ← Wrong	
	← Clear	
Amount tendered	1 5  ← You have to enter the sub-department No. again	
	1 0 00  ← Correction	
	1 0 00 ← Wrong	
	← Clear	
	1 5 00  ← Correction	

# Basic Setups and Operations

## Correcting an item you have input and registered

EXAMPLE	OPERATION	RECEIPT
General	<p><b>1 00</b> <math>\frac{21}{+ 1}</math></p> <p><b>2 00</b> <math>\frac{22}{- 2}</math></p> <p><math>\frac{22}{- 2}</math> ← Wrong</p> <p>ERR CORR CANCEL ← Clears the last <math>\frac{22}{- 2}</math> key operation</p>	<pre> 12•01•96 01 15:25 No 0059  1   •1•00  I 2   •2•00  II 2   •2•00  II       2•00  VD - 2 PL •1•20  II       1•20  VD - 5 PL •1•50  I 15 PL•6•00  I       6•00  VD - 15 PL•10•00 I       8      Q       •4•00  @ 4   •32•00 II       32•00 VD -       6      Q       •4•00  @ 4   •24•00 II       •38•50 ST       50%       19•25  III       -       •19•25 VD       •38•50 ST       5%       1•93  III       - 2   2•00  RF II       -       •2•00  VD 2   2•20  RF II       -       •11•87 TA I       •0•48 TX I       •22•50 TA II       •1•18 TX II       -       •36•03 TL       •30•00 CA       30•00 VD -       •6•03 CA       •30•00 CK                     </pre>
PLU No.	<p><b>2</b> <math>\frac{PLU/}{S.DEPT}</math> ← Wrong</p> <p>ERR CORR CANCEL ← Clear</p>	
Sub-department	<p><b>5</b> <math>\frac{PLU/}{S.DEPT}</math> ← Correction</p> <p><b>1 5</b> <math>\frac{PLU/}{S.DEPT}</math> } ← Wrong</p> <p><b>6 00</b> <math>\frac{PRICE}{}</math> } ← Wrong</p> <p>ERR CORR CANCEL ← Clear</p> <p><b>1 5</b> <math>\frac{PLU/}{S.DEPT}</math> } ← Correction</p> <p><b>1 0 00</b> <math>\frac{PRICE}{}</math> } ← Correction</p>	
Multiplication	<p><b>8</b> <math>\frac{X/ FOR}{/ DATE TIME}</math> ← Wrong</p> <p><b>4 00</b> <math>\frac{24}{÷ 4}</math></p> <p>ERR CORR CANCEL ← Clear</p> <p><b>6</b> <math>\frac{X/ FOR}{/ DATE TIME}</math> } ← Correction</p> <p><b>4 00</b> <math>\frac{24}{÷ 4}</math> } ← Correction</p>	
Discount	<p><math>\frac{MD/}{ST}</math></p> <p><b>5 0</b> <math>\frac{\%}{}</math> ← Wrong</p> <p>ERR CORR CANCEL ← Clear</p> <p><math>\frac{MD/}{ST}</math> } ← Correction</p> <p><b>5</b> <math>\frac{\%}{}</math> } ← Correction</p>	
Refund	<p><b>RF</b> } ← Wrong</p> <p><b>2 00</b> <math>\frac{22}{- 2}</math> } ← Wrong</p> <p>ERR CORR CANCEL ← Clear</p> <p><b>RF</b> } ← Correction</p>	
Amount tendered	<p><b>2 2 0</b> <math>\frac{22}{- 2}</math> } ← Correction</p> <p><b>3 0 00</b> <math>\frac{CA/ AMT}{TEND}</math> ← Wrong</p> <p>ERR CORR CANCEL ← Clear</p> <p><b>6 0 3</b> <math>\frac{CA/ AMT}{TEND}</math> ← Correction</p> <p>CHK</p>	

## Cancelling all items in a transaction

### OPERATION

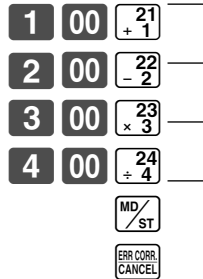

Items to be cancelled

← You must calculate the merchandise subtotal to cancel the transaction.

### RECEIPT

12·01·96		
01 15:30		
No 0060		
1	·1·00	I
2	·2·00	II
3	·3·00	I
4	·4·00	II
	·10·00	ST
.....		VD

## Important!

- Note that the number of items included in the transaction to be cancelled is limited (usually to about 9 ~ 17), depending on the complexity of the transaction. If you try to cancel a transaction that exceeds the limit, and error occurs.
- You can program the cash register so that this cancel operation is not allowed (page 62).

## No sale registration

You can use the following procedure to open the drawer without registering a sale. This operation must be performed alone, and cannot be performed as part of another registration.

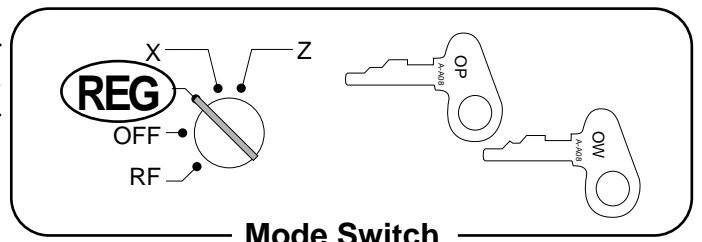

### OPERATION



### RECEIPT

12·01·96		
01 15:35		
No 0061		
.....		#

# More Setups and Operations

This section describes more sophisticated setups and operations that you can use to suit the needs of your retail environment.

## Clerk control function Post-finalization receipt issuance General printing control

The procedure described here lets you:

- Activate the clerk control function.
- Specify the contents of post-finalization receipts.
- Specify the contents of receipts, the journal, and reports.

### Programming multiple clerks, post-finalization receipt issuance, and general printing control

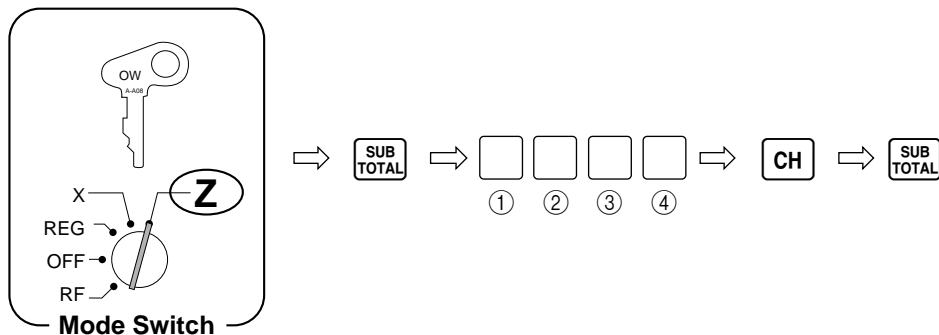

#### ① Input the total of a + b + c.

- a. Do you want the RF mode total and count, and the **[RF]** key count included in the daily sales READ/RESET Report?  
(Include = 0/Skip = 1) ----> a. \_\_\_\_\_
- b. Do you want the non-resettable grand sales total included in the daily sales RESET Report?  
(Include = 0/Skip = 2) ----> b. \_\_\_\_\_
- c. Do you want details or the transaction total only in the post-finalization receipt?  
(Details = 0/Total only = 4) ----> c. \_\_\_\_\_

#### ② Input the total of d + e.

- d. Do you want to clear key buffer after receipt is issued?  
(Do not clear = 0/Clear = 1) ----> d. \_\_\_\_\_
- e. Do you want to activate the clerk function by changing the [OPEN] to the [CLK#] key?  
(Activate = 2/Leave as [OPEN] = 0) ----> e. \_\_\_\_\_

③ **Input the total of f + g + h.**

- f. Do you want the current time included in receipt/journal printing?  
(Include = 0/Skip = 1) ----> f. \_\_\_\_\_
- g. Do you want item lines included in journal printing?  
(Journal skip) (Include = 0/Skip = 2) ----> g. \_\_\_\_\_
- h. Do you want the consecutive number included in receipt/journal printing in the REG and RF modes?  
(Include = 0/Skip = 4) ----> h. \_\_\_\_\_

④ **Input the total of i + j + k.**

- i. Do you want a taxable status symbol included in receipt/journal printing?  
(Include = 0/Skip = 1) ----> i. \_\_\_\_\_
- j. Do you want a subtotal line printed on the receipt/journal whenever the  key is pressed?  
(Print = 2/Do not print = 0) ----> j. \_\_\_\_\_
- k. Do you want to print the date on journal?  
(Print = 4/Do not print = 0) ----> k. \_\_\_\_\_

# More Setups and Operations

## Using the clerk control function

You can use the clerk control function to keep track of the registrations performed by different clerks.

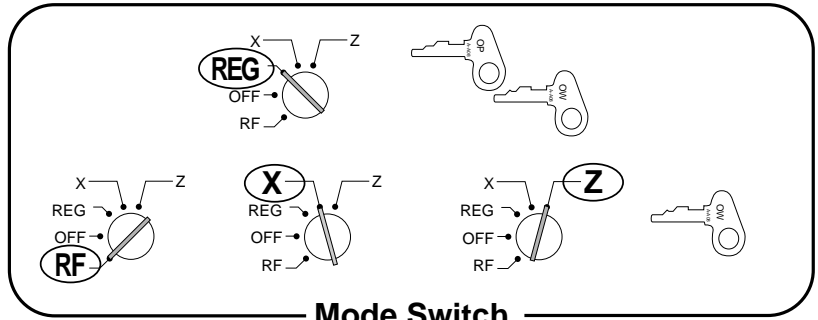

### Clerk Sign On

#### OPERATION

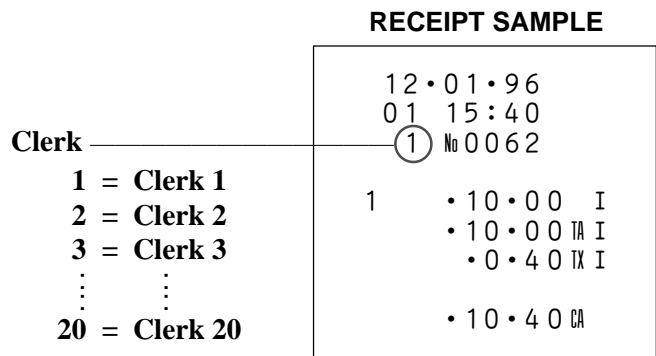
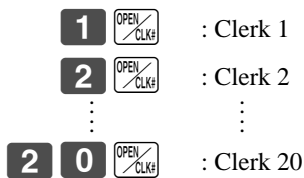

## Important!

- Once you activate the clerk control function, the error code “E08” appears on the display whenever you try to perform a registration, a READ/RESET operation, or any programming without first signing on.
- The signed on clerk is also identified on the receipt/journal.

### Clerk Sign Off

#### OPERATION



- The current clerk is also signed off whenever you set the Mode Switch to the OFF position.



## Issuing post-finalization receipts

The post-finalization receipt lets you issue a receipt after finalization of the transaction, even when the receipt switch is set to OFF. Note that all of the following conditions must exist for you to be able to issue a post-finalization receipt.

- The receipt switch must be in the OFF position.
- The transaction must be finalized in the REG or RF mode using the  $\boxed{=}$  <sup>CA/AMT</sup>/<sub>TEND</sub>,  $\boxed{CH}$ , or  $\boxed{CHK}$  key.

### About post-finalization receipt formats

You can program the cash register to print the transaction total only or full details on the post-finalization receipt. See page 54 for details of this programming. Note however, that if the transaction contains more than 36 lines (including the receipt header), the cash register automatically prints a total-only post-finalization receipt, regardless of your programming.

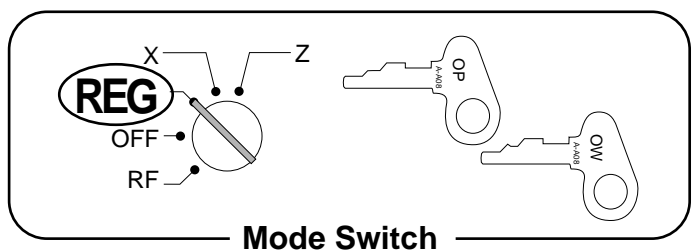
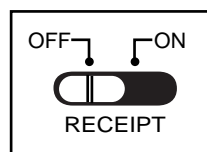

Example

Tag	Tax Calculation	Qty	Tender
(a) DEPT 1	\$10.00 Tax Table 1	1	Cash \$31.45
(b) DEPT 2	\$20.00 Tax Table 2	1	

OPERATION

RECEIPT

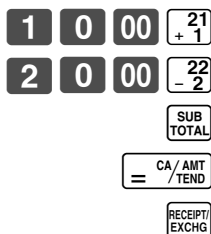

..... Receipt not issued

..... Post-finalization receipt issued

### Important!

- You can issue only one post-finalization receipt per transaction.

#### Detail Format

```

12•01•96
01 15:45
1 No 0063

1 •10•00 I
2 •20•00 II
•10•00 TA I
•0•40 TX I
•20•00 TA II
•1•05 TX II

•31•45 CA
    
```

#### Total-only Format

```

12•01•96
01 15:45
1 No 0063

•31•45 CA
    
```

## Single-item-sales for departments and PLUs

### Programming single-item-sale status to departments and PLUs

When a department or PLU number is preset with single-item-sale status, the cash register automatically finalizes the transaction as a cash sale whenever the single-item-sale department or PLU is registered as the first input of the transaction. If the single-item-sale item is registered after a normal (non-single-item-sale) item, the register does not finalize until you press one of the finalize keys.

#### Example:

When  $\boxed{+21}$  is preset as a single-item-sale department and  $\boxed{-22}$  is a normal department.

$\boxed{+21}$ : Transaction is finalized automatically.

$\boxed{-22}$ ,  $\boxed{+21}$ : Transaction is not finalized until you press  $\boxed{= CA/AMT TEND}$ ,  $\boxed{CHK}$ , or  $\boxed{CH}$ .

### To program a department with single-item-sale status

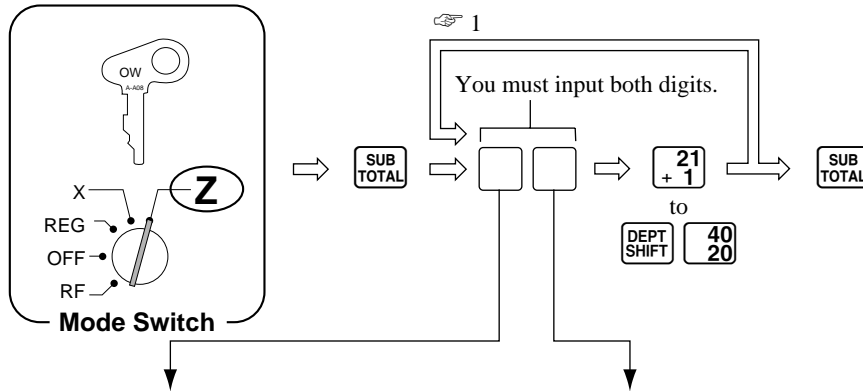

#### Maximum number of digits

This specification defines how many digits can be used for manual input of a unit price on the keyboard.

- No limit      ⇨    **0**
- 1 digit        ⇨    **1**
- 2 digits       ⇨    **2**
- 3 digits       ⇨    **3**
- 4 digits       ⇨    **4**
- 5 digits       ⇨    **5**
- 6 digits       ⇨    **6**

Manual input not allowed    ⇨    **9**

Selecting **9** means that you can perform department registrations using their preset unit prices only.

#### Input the total of a + b.

a. Do you want this department to be a single-item-sale department or a normal department?  
(Single-item-sale = 1/Normal = 0) ----> a. \_\_\_\_\_

b. Which tax table do you want to use for automatic calculation of taxes? See page 21 for information on setting up the tax tables.

- Tax Table 1      ⇨    **2**
- Tax Table 2      ⇨    **4**
- Tax Table 1 and 2 ⇨    **6**
- No tax calculation ⇨    **0**

(Tax calculation) ----> b. \_\_\_\_\_

☞ 1 After you press a department key, you can loop back and start programming for another department.

## To program a PLU with single-item-sale status

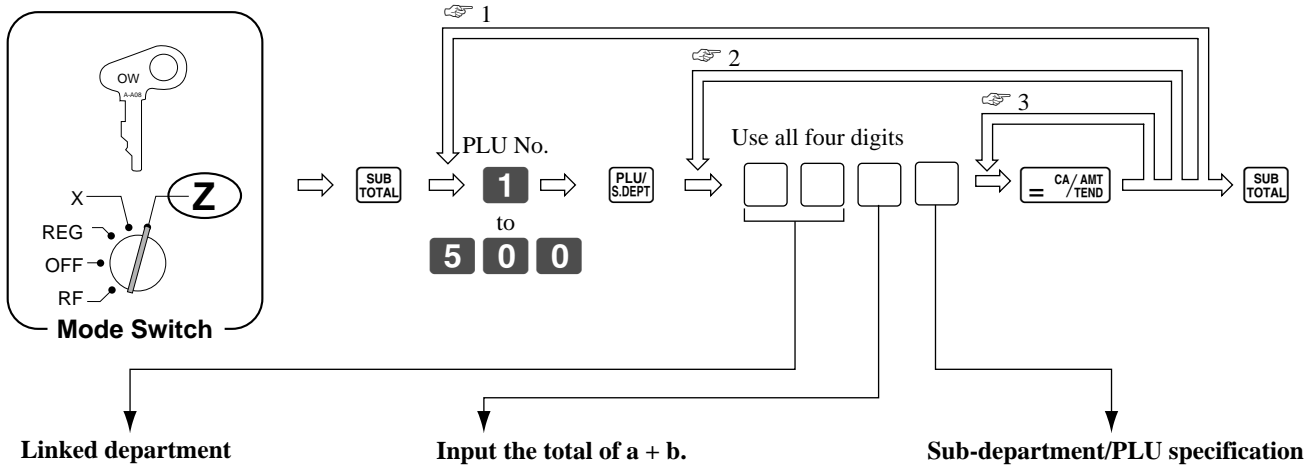

### Linked department

This specification links the PLU to a department.

- Department 1 ⇨ **0 1**
- Department 2 ⇨ **0 2**
- Department 3 ⇨ **0 3**
- Department 4 ⇨ **0 4**
- Department 5 ⇨ **0 5**
- ⋮
- Department 36 ⇨ **3 6**
- Department 37 ⇨ **3 7**
- Department 38 ⇨ **3 8**
- Department 39 ⇨ **3 9**
- Department 40 ⇨ **4 0**
- Non link ⇨ **0 0**

### Input the total of a + b.

a. Do you want this PLU to be a single item sale PLU or a normal PLU?  
(Single-item-sale = 1/  
Normal = 0) ----> a. \_\_\_\_\_

b. Which tax table do you want to use for automatic calculation of taxes?  
See page 21 for information on setting up the tax tables.  
(Tax calculation) ----> b. \_\_\_\_\_

- Tax table 1 ⇨ **2**
- Tax table 2 ⇨ **4**
- Tax table 1 and 2 ⇨ **6**
- No tax calculation ⇨ **0**

### Sub-department/PLU specification

- Treat as a PLU ⇨ **0**
- Treat as a sub-department ⇨ **1**

A PLU can register its preset unit price only. A sub-department can register its preset price or a manually entered price.

- ⇨ 1 After you press the **CA/AMT/TEND** key, you can loop back and start programming for another PLU by inputting a new PLU number.
- ⇨ 2 When you press the **CA/AMT/TEND** key, you can loop back and input another specification which will be assigned to the next PLU.
- ⇨ 3 Press the **CA/AMT/TEND** key again to program the next PLU number with the same specification.

# More Setups and Operations

## Registering single-item-sale items

The following examples show how you register single-item-sale departments. Registration of single-item-sale PLUs is identical.

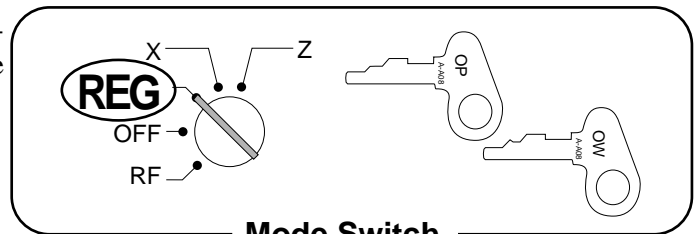

### Example 1

Tag	Tax Calculation	Sales Status	Qty	Tender
DEPT 4	\$2.00	Tax Table 2	Single-Item	1
				Cash \$2.11

#### OPERATION

**2 00**  $\frac{24}{\div 4}$  ← Transaction is finalized.

#### RECEIPT

```

12•01•96
01 15:50
1 No 0064

4 •2•00 II
•2•00 TA II
•0•11 TX II

•2•11 CA
    
```

### Example 2

Tag	Tax Calculation	Sales Status	Qty	Tender
DEPT 4	\$3.00 Preset	Tax Table 2	Single-Item	3
				Cash \$9.47

#### OPERATION

**3**  $\frac{X}{\div}$  FOR DATE TIME ← Quantity  
 $\frac{24}{\div 4}$

#### RECEIPT

```

12•01•96
01 15:55
1 No 0065

3 Q
•3•00 @
4 •9•00 II
•9•00 TA II
•0•47 TX II

•9•47 CA
    
```

### Example 3

Tag	Tax Calculation	Sales Status	Qty	Tender
(a) DEPT 3	\$2.00	Tax Table 1	Normal	1
(b) DEPT 4	\$5.00	Tax Table 2	Single-Item	1
				Cash \$7.34

#### OPERATION

**2 00**  $\frac{23}{\times 3}$   
**5 00**  $\frac{24}{\div 4}$  ← Transaction is not finalized automatically because Department 3 is a normal department.  
 $\frac{CA}{=} / \frac{AMT}{TEND}$

#### RECEIPT

```

12•01•96
01 16:00
1 No 0066

3 •2•00 I
4 •5•00 II
•2•00 TA I
•0•08 TX I
•5•00 TA II
•0•26 TX II

•7•34 CA
    
```

# Registering manually entered tax amounts

You can program the cash register to change the function of the [%] key to that of a [M-TAX] (Manual Tax) key. The [M-TAX] key is used to register manually entered tax amounts.

## Important!

If you program the cash register to perform registrations with manually entered tax amounts, the [M-TAX] key replaces the [%] key, so discount/premium registrations become impossible.

## Programming for manually input tax registration

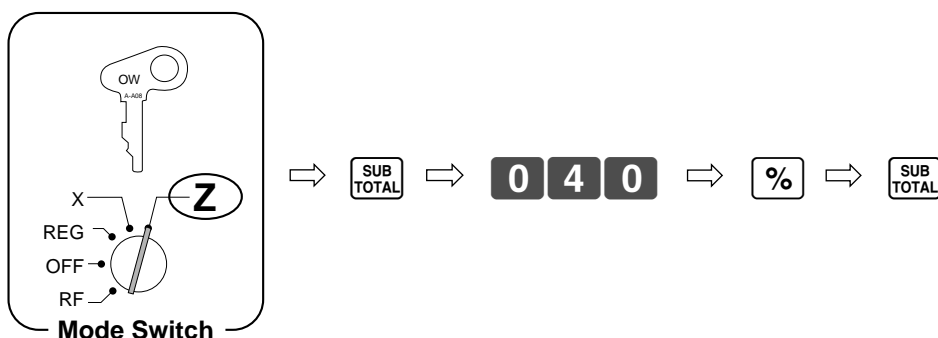

## Registering manual tax

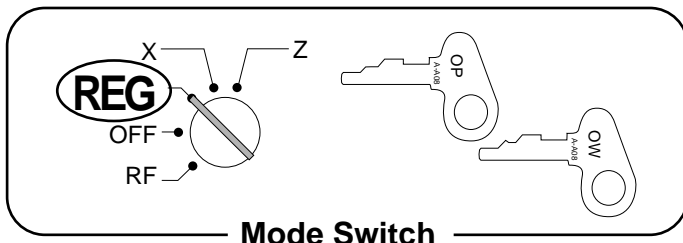

Example	Tag	Tax Calculation	Tender
	DEPT 1	\$10.00	Tax Table 1 + Manual Tax Amount \$0.50
	DEPT 2	\$20.00	Tax Table 2
			Cash \$31.95

### OPERATION

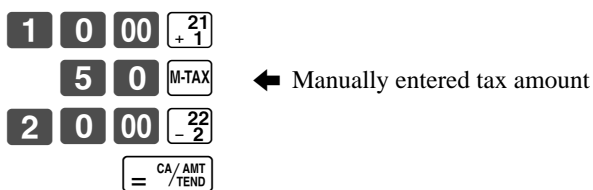

### RECEIPT

12	01	96
01	16	05
1	No	0067
1	• 10	00 I
	• 0	50 TX
2	• 20	00 II
	• 10	00 TA I
	• 0	40 TX I
	• 20	00 TA II
	• 1	05 TX II
	• 31	95 CA

## Programming tax printing and other features

The following procedure lets you program a number of general features and functions.

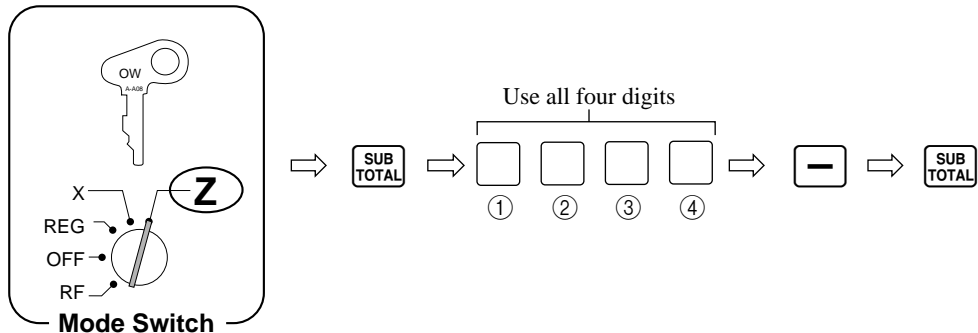

### ① Tax status for **[ - ]** key

This specification defines where the result of **[ - ]** key operations should be reflected (subtracted from) for tax purposes.

- Taxable Amount 1      ⇒    **1**
- Taxable Amount 2      ⇒    **2**
- Taxable Amount 1 and 2 ⇒    **3**
- Do not reflect          ⇒    **0**

### ② Input the total of a + b.

- a. Do you want to print the taxable amount on the receipt/journal?  
 (Print = 0/Skip = 2)---->      a. \_\_\_\_\_
- b. Do you want to allow negative results produced by **[ - ]** key operations?  
 (Allow = 4/Do not allow = 0)---->      b. \_\_\_\_\_

### ③ Input the total of c + d + e.

- c. Do you want to use the **[ 00 ]** key as a [00] key or a [000] key?  
 ([00] key = 0/[000] key = 1)---->      c. \_\_\_\_\_
- d. Do you want to display "seconds" during time display?  
 (Display "Hour, Minute" = 0/"Hour, Minute, Second" = 2)---->      d. \_\_\_\_\_
- e. Do you want to feed one line before printing finalization details on the receipt/journal?  
 (Feed = 0/No feed = 4)---->      e. \_\_\_\_\_

### ④ Input the total of f + g + h.

- f. Do you want to require input of the cash in drawer amount before allowing printing of the daily READ/RESET report? (Money declaration)  
 (Required = 1/Not required = 0)---->      f. \_\_\_\_\_
- g. Do you want the consecutive number reset to 0001 whenever a daily RESET report is issued?  
 (Reset = 0/Do not reset = 2)---->      g. \_\_\_\_\_
- h. Do you want to prohibit the cancel operation?  
 (Prohibit = 4/Allow = 0)---->      h. \_\_\_\_\_

# Programming currency exchange

When the **RECEIPT/EXCHG** key is pressed, a current subtotal including tax is converted directly into foreign currency and the result is displayed, and the subsequent finalization is handled using the foreign currency. The currency exchange function is released by finalizing the transaction, partial tender operation, receipt issuance, or by pressing the **SUB TOTAL** key.

## To program currency exchange rate for the **RECEIPT/EXCHG** key

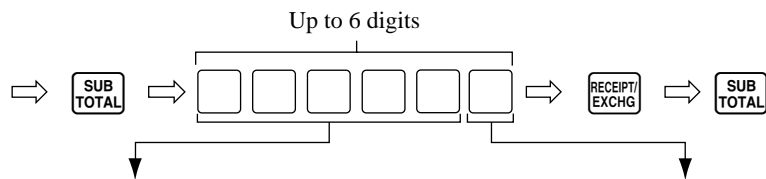
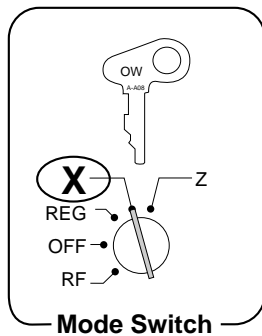

### Exchange rate

Enter the rate up to 5 digits.

### Position of the decimal point

- No decimal point (Integer only) ⇒ **0**
- 1st decimal place ⇒ **1**
- 2nd decimal place ⇒ **2**
- 3rd decimal place ⇒ **3**
- 4th decimal place ⇒ **4**
- 5th decimal place ⇒ **5**

**Example:** Conversion rate \$ 1.00 → ¥ 105.00 ⇒ **1 0 5 0 0 2**  
 Conversion rate ¥ 1. → \$0.0095238 ⇒ **9 5 2 3 8 5**

## To program rounding code for currency exchange calculation

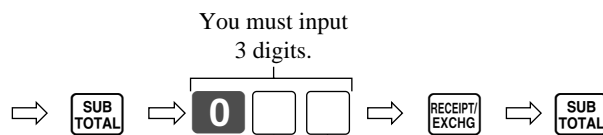
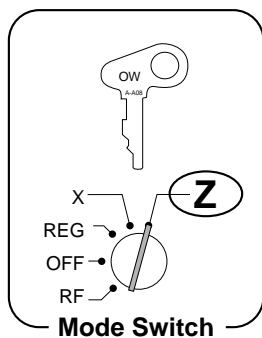

### Rounding code

- Round off: ⇒ **0**
- Round up: ⇒ **1**
- Cut off: ⇒ **2**

### Monetary mode of foreign currency

- Same as the local currency ⇒ **0**
- Monetary mode 2 (123.45) ⇒ **2**
- Monetary mode 0 (12,345) ⇒ **3**

# More Setups and Operations

## Registering foreign currency

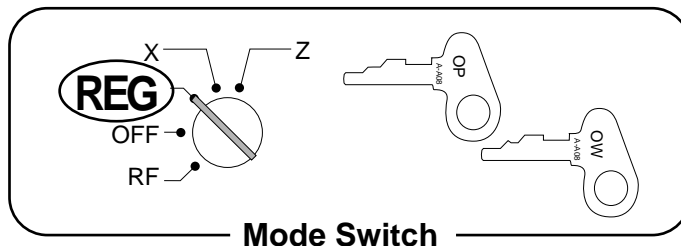

### 1) Full amount tender in foreign currency

Example:

Tag	Tax Calculation	Qty	Tender
DEPT 1 \$10.00	Tax Table 1: Add-on tax 7%/Round off	1	Cash ¥5,000
DEPT 2 \$20.00	Tax Table 2: Add-on tax 8%/Round off	1	

\* Pre-programmed exchange rate: ¥ 1 = \$0.0095

## Important!

Tenders in a foreign currency can be registered using the **CA/AMT/TEND** and **CHK** keys only. Other finalize keys cannot be used.

OPERATION	DISPLAY	RECEIPT
<p><b>1 0 00</b> <b>+ 21</b> ← Enter the unit price and press the applicable department key.</p>	<p><b>01 10.00</b> (Displays in \$)</p>	<pre> 12•01•96 01 16:10 1 No 0068  1 •10•00 I 2 •20•00 II •10•00 TA I •0•70 TX I •20•00 TA II •1•60 TX II  •32•30 TL •5000•00 CA @ •47•50 CA •15•20 CC                     </pre>
<p><b>2 0 00</b> <b>- 22</b> ← Enter the next unit price and press the applicable department key.</p>	<p><b>02 20.00</b> (Displays in \$)</p>	
<p><b>RECEIPT/EXCHG</b> ← Press the <b>RECEIPT/EXCHG</b> key without entering a numeric value. This operation converts the subtotal (including tax) dollar value into yen by applying a pre-programmed exchange rate. The result is shown on the display but not printed on the receipt or journal.</p>	<p><b>3400.00</b> (Displays in ¥: 3,400.00)</p>	
<p><b>5 0 00 00</b> <b>RECEIPT/EXCHG</b> ← Enter the amount tendered in yen and press the <b>RECEIPT/EXCHG</b> key. This operation converts the entered yen amount into dollars by applying a pre-programmed exchange rate. The result is shown on the display. (5,000.00)</p>	<p><b>47.50</b> (Displays in \$: 47.50)</p>	
<p><b>CA/AMT/TEND</b> ← Press to finalize the transaction. Note that you do not need to reenter the dollar amount. The register automatically calculates the change amount due in dollars and shows it on the display, receipts and journal.</p>	<p><b>7 1∞20</b> (Displays in \$)</p>	





## 2) Partial tender in a foreign currency

Example:

Tag	Tax Calculation	Qty	Tender
DEPT 1 \$10.00	Tax Table 1: Add-on tax 7%/Round off	1	Cash ¥3,000
DEPT 2 \$20.00	Tax Table 2: Add-on tax 8%/Round off	1	Check \$3.74

\* Pre-programmed exchange rate: ¥ 1 = \$0.0095

### Important!

Partial tender in a foreign currency can be registered using the  key and  keys only. Other finalization keys cannot be used, but the remaining tender can be finalized using any finalize key.

#### OPERATION

#### DISPLAY

#### RECEIPT



← Enter the unit price and press the applicable department key.

  
(Displays in \$)



← Enter the next unit price and press the applicable department key.

  
(Displays in \$)



← Press the  key without entering a numeric value. This operation converts the subtotal (including tax) dollar value into yen by applying a pre-programmed exchange rate. The result is shown on the display but not printed on the receipt or journal.

  
(Displays in ¥: 3,400.00)

  
(3,000.00)

← Enter the partial amount tendered in yen and press the  key. This operation converts the entered yen amount into dollars by applying a pre-programmed exchange rate. The result is shown on the display.

  
(Displays in \$: 28.50)



← Press the  key to specify cash tender for the yen partial tender. Note that you do not need to reenter the dollar amount. The register automatically deducts the dollar equivalent of the yen amount tendered from the total amount due and shows the amount on the display.

  
(Displays in \$)



← Press to finalize the transaction.

  
(Displays in \$)

```

12•01•96
01 16:20
1 No 0069

1 •10•00 I
2 •20•00 II
•10•00 TA I
•0•70 TX I
•20•00 TA II
•1•60 TX II

•32•30 TL
•3000•00 CA @
•28•50 CA
•3•80 CK
    
```







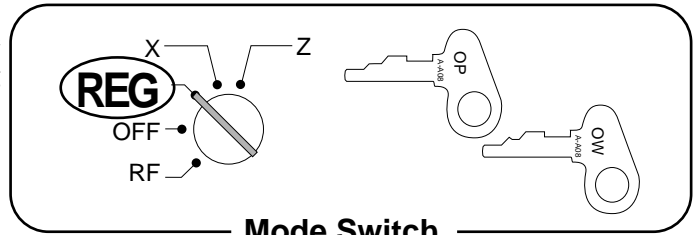























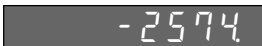













# More Setups and Operations

## Calculator functions

While registering at the REG mode, you can use the calculator functions and resume the registration by pressing the  key.















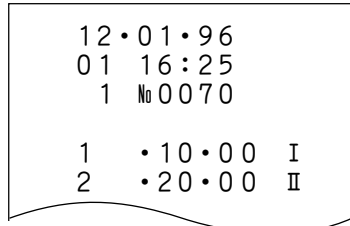









### Example 1 (Calculation examples)

OPERATION	DISPLAY
 ← Switch to CAL mode	
  ← Clear	
      ← 5+3-2=	
         ← (23-56)×78=	
            ← (4×3-6)/3.5+8	
        ← 12 % on 1500	
 ← Return to REG mode	

### Example 2 (Memory recall)

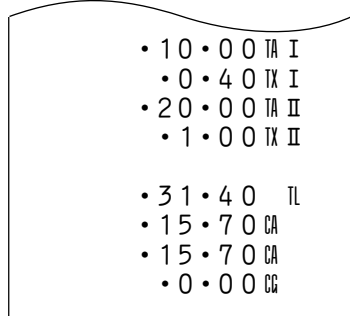
Tag	Tax Calculation	Qty	Tender
DEPT 1 \$10.00	Tax Table 1	1	By 2 persons Cash \$15.70 each
DEPT 2 \$20.00	Tax Table 2	1	

OPERATION	DISPLAY/RECEIPT
    	
    	
	
 ← Switch to CAL mode	
 ← Recall subtotal amount.	
   ← Divide the subtotal.	
 ← Return to REG mode	
 ← Recall subtotal amount.	
	
 	

# Programming calculator features

The following procedure lets you program a number of calculator features and functions.

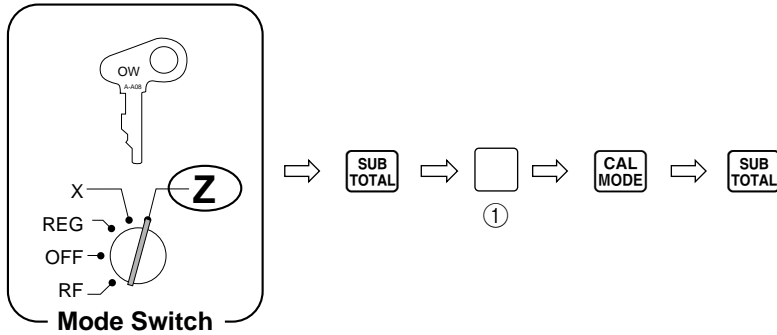

① **Input the total of a + b + c.**

- a. Do you want to open the cash drawer when the "Equal" ( $\boxed{= \begin{smallmatrix} CA/AMT \\ TEND \end{smallmatrix}}$ ) key is pressed?  
(No = 0/Yes = 1)----> a. \_\_\_\_\_
- b. Do you want to open the cash drawer when the "Drawer open" ( $\boxed{CHK}$ ) key is pressed?  
(No = 0/Yes = 2)----> b. \_\_\_\_\_
- c. Do you want to print the "Equal" ( $\boxed{= \begin{smallmatrix} CA/AMT \\ TEND \end{smallmatrix}}$ ) key total/count on the general control READ/RESET report?  
(Yes = 0/No = 4)----> c. \_\_\_\_\_

# Reports

This section describes the operations required to produce the various helpful reports that are available.

## Printing the cash register's program

### To print all PLU programming

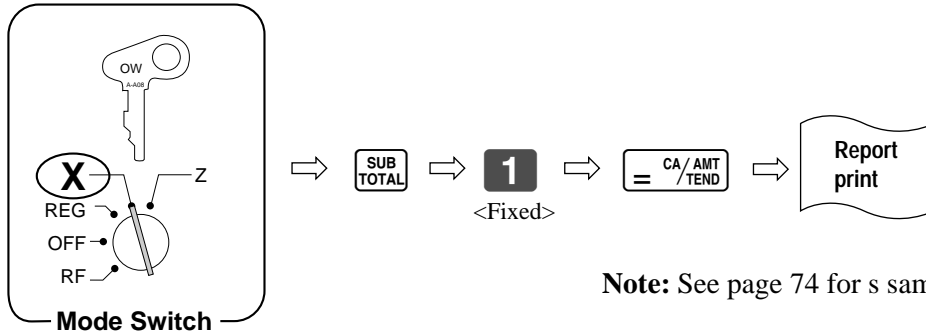

**Note:** See page 74 for a sample report.

### To print other (non-PLU) programming

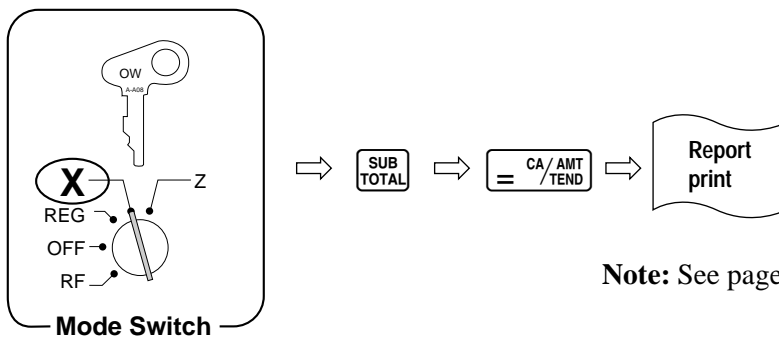

**Note:** See page 74 for a sample report.

## Printing READ reports

You can print READ reports at any time during the business day without affecting the data stored in the cash register's memory.

### To print the daily sales READ report

This report shows sales, except for PLUs.

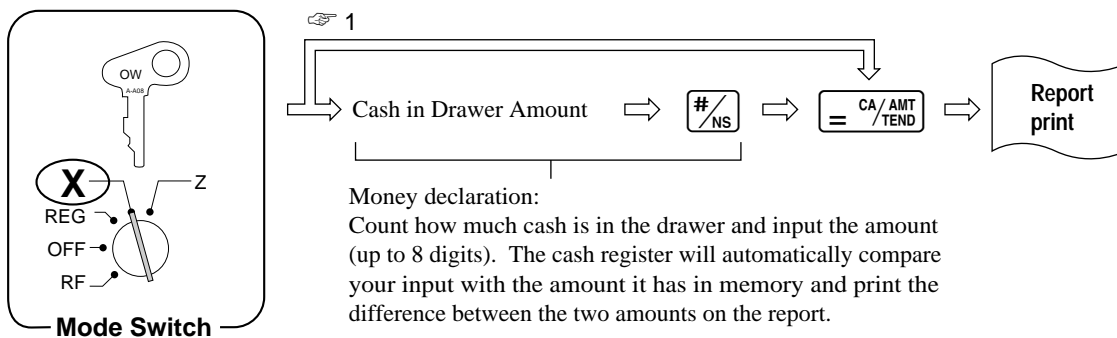

**Note:** See page 75 for a sample report.

1 You do not have to input the cash-in-drawer amount unless it is required by programming (page 62).

### To print the PLU/sub-department READ report

This report shows sales for PLUs/sub-departments.

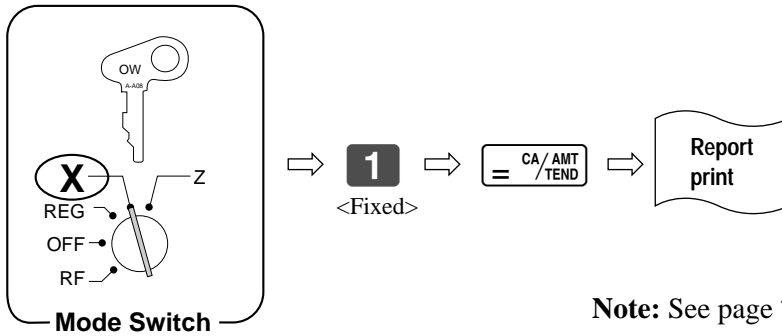

**Note:** See page 76 for a sample report.

### To print the hourly sales READ report

This report shows hourly breakdowns of sales.

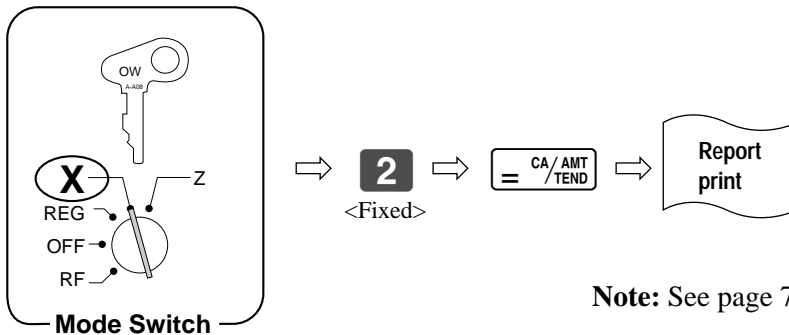

**Note:** See page 76 for a sample report.

### To print the periodic sales READ report

This report shows breakdowns of sales by any period you want.

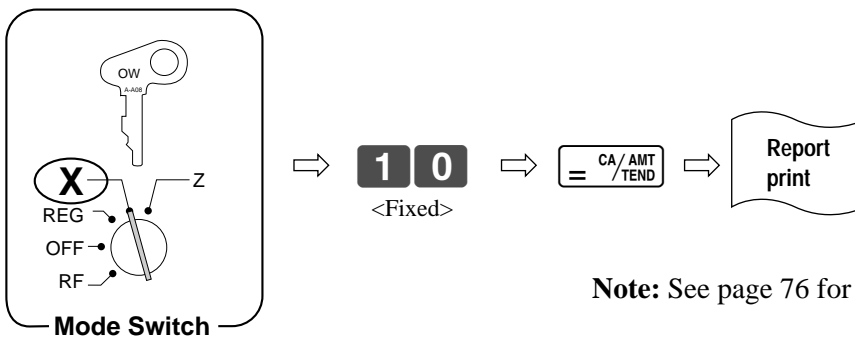

**Note:** See page 76 for a sample report.

# Reports

## To print the monthly sales READ report

This report shows daily breakdowns of sales for an entire month.

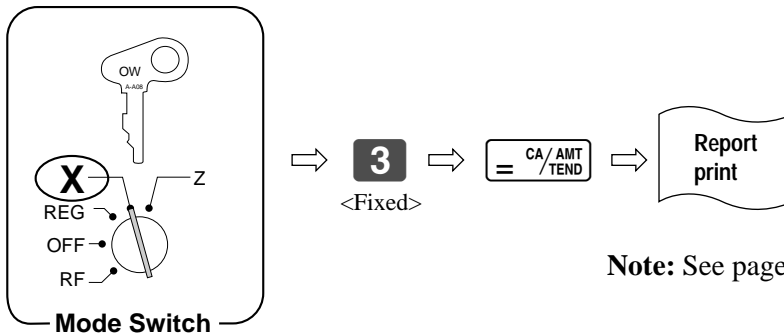

**Note:** See page 77 for a sample report.

## To print the financial READ report

This report shows gross sales, net sales, cash in drawer and check in drawer.

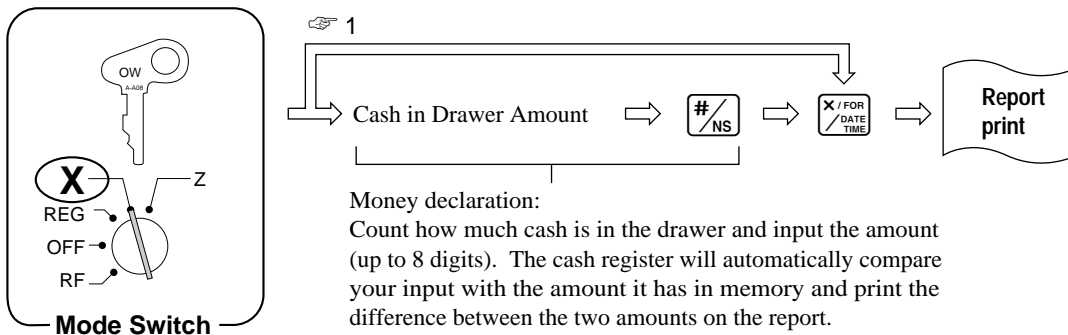

**Note:** See page 77 for a sample report.

☞ 1 Note that if input of this amount is required by programming (page 62), this report will not be printed unless you input an amount here.

## To print the individual department READ report

This report shows sales for specific departments.

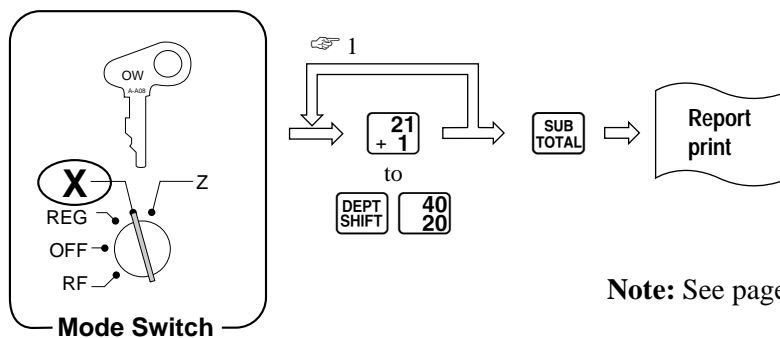

**Note:** See page 77 for a sample report.

☞ 1 After you press a department key, you can loop back and specify another department.

## To print the individual PLU/sub-department READ report

This report shows sales for specific PLUs.

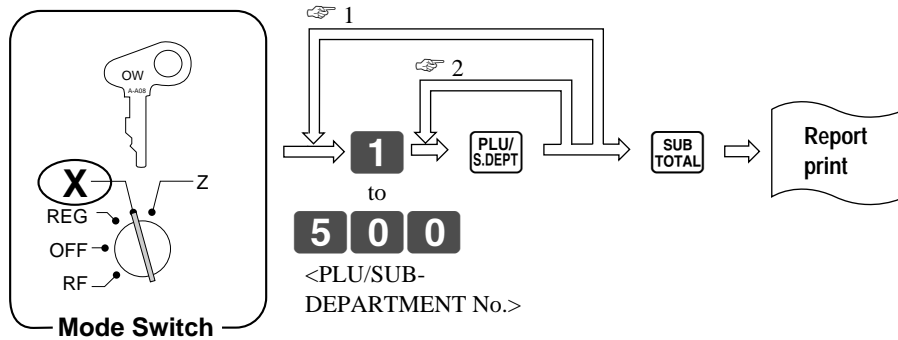

**Note:** See page 77 for a sample report.

- ➡ 1 After you press the **PLU/S.DEPT** key, you can loop back and specify another PLU/sub-department number.
- ➡ 2 After you press the **PLU/S.DEPT** key, you can loop back and press **PLU/S.DEPT** again to specify the next sequential PLU/sub-department number.

## Printing RESET reports

You should print RESET reports at the end of the business day.

### Important!

- **The RESET operation issues a report and also clears all sales data from the cash register's memory.**
- **Be sure to perform the RESET operations at the end of each business day. Otherwise, you will not be able to distinguish between the sales data for different dates.**

# Reports

## To print the daily sales RESET report

This report shows sales, except for PLUs.

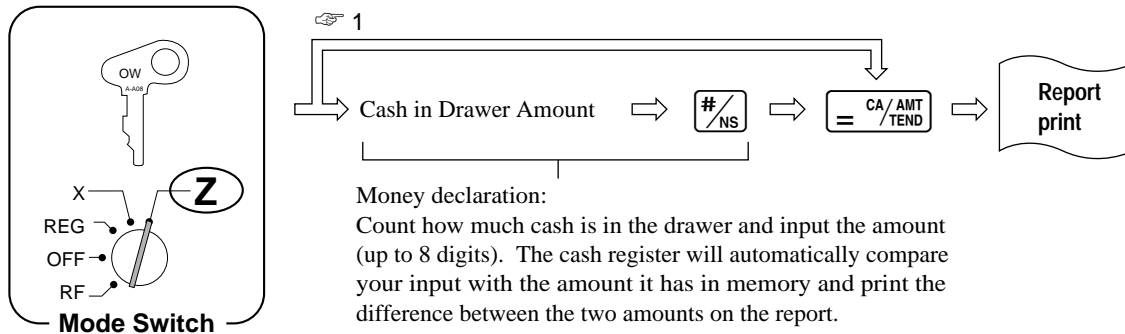

**Note:** See page 75 for a sample report.

☞ 1 You do not have to input the cash-in-drawer amount unless it is required by programming (page 62).

## To print the PLU/sub-department RESET report

This report shows sales for PLUs/sub-departments.

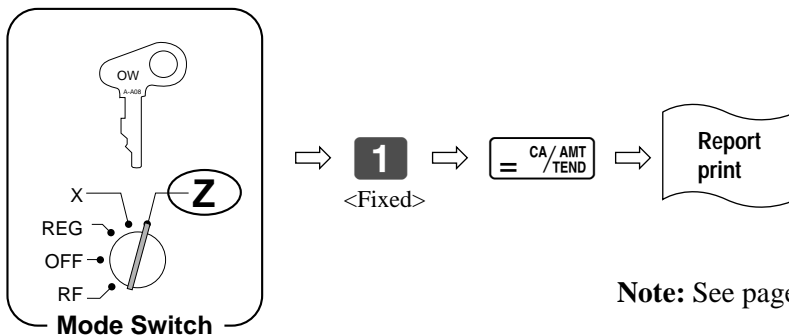

**Note:** See page 76 for a sample report.

## To print the hourly sales RESET report

This report shows hourly breakdowns of sales.

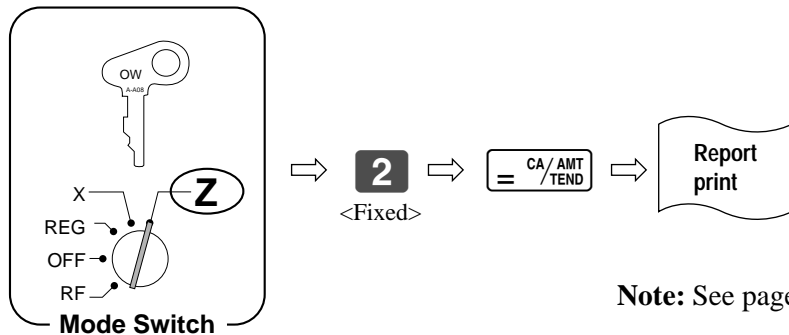

**Note:** See page 76 for a sample report.



### To print the periodic sales RESET report

This report shows breakdowns of sales by any period you want.

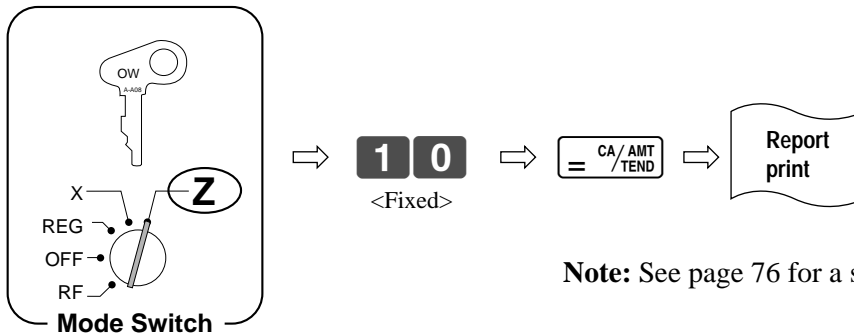

**Note:** See page 76 for a sample report.

### To print the monthly sales RESET report

This report shows daily breakdowns of sales for an entire month.

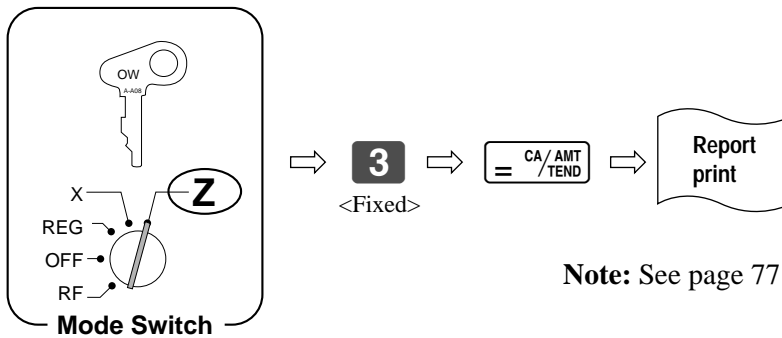

**Note:** See page 77 for a sample report.

## Report samples

The format of READ reports and similar to those of RESET reports, except that RESET reports contain the symbol "Z" and non-resettable number of resets at the top.

### All PLU programming report

12·01·96	—	Date
01 19:15	—	Machine No./Time
1 No 0085	—	Consecutive No.
X	—	READ
2 PL 0040	—	PLU/Sub-dept. No.
·1·20 @	—	Preset unit price
3 PL 0020	—	Linked Dept. No./
·1·30 @	—	Single item sales/
4 PL 0040	—	Tax calculation/
·1·40 @	—	Sub-dept./PLU
5 PL 0020	—	specification
·1·50 @		
14 PL 0040		
·2·50 @		
15 PL 0021		
·1·40 @		
16 PL 0020		
·1·50 @		
37 PL 0021		
·30·00 @		
45 PL 0020		
·6·00 @		
··2983··	—	ROM version No.
12·01·96	—	Date

### Other (Non-PLU) programming report

12·01·96	—	Date
01 19:20	—	Machine No./Time
1 No 0086	—	Consecutive No.
X	—	READ
1 02	—	Dept. No.
·1·00 @	—	Maximum No. of digits
2 04	—	Single item sales
·2·00 @	—	Tax calculation
02	—	Preset unit price
·3·00 @		
6 06	—	Tax calculation
·6·00 @	—	Rounding method
000 % -	—	Key function specification
5 % -	—	Preset rate for [%] key
0000 -	—	Tax calculation for key/Tax printing and other features
000 # @	—	CE: round code
0·095 # @	—	CE: exchange rate
01 RA	—	Machine No.
0000 CH	—	Receipt/Journal specification
0 % # I	—	Clerk control function
000 1 # I	—	Post-finalization receipt/
02 # I	—	General printing control
·0·10 # I	—	Tax table 1
·0·24 # I		
·0·41 # I		
·0·58 # I		
·0·74 # I		
5·25 % # II	—	Tax table 2
5002 # II		
0000 # II		
··2983··	—	ROM version No.
12·01·96	—	Date

Department, PLU and Tax tables for which there is nothing programmed are not printed on these reports. This print sample shown right hand above is produced when the Percent key is selected. The print sample (right) would be produced when the Manual Tax key is selected.

6 06	
·0·00 @	
40 TX	
0000 -	

# Daily sales READ/RESET report

12•01•96	—	Date	No 11	—	Currency exchange count
01 19:38	—	Machine No./Time	• 1156•26 # @	—	Foreign currency amount
1 No 0171	—	Clerk No. <sup>*1</sup> /Consecutive No.	No 2	—	Received on account count
Z 0001	—	Non resettable No. of resets <sup>*2</sup>	• 78•00 RA	—	Received on account amount
	—	X = READ/Z = RESET	No 1	—	Paid out count
1 69	—	Department No./No. of items <sup>*3</sup>	• 6•80 PO	—	Paid out amount
• 339•50	—	Department amount <sup>*3</sup>	No 10 UD	—	Error correction count
2 19			No 2 UD TL	—	Cancelled operation count
• 62•70			No 7 RF	—	Refund key count <sup>*7</sup>
3 31			No 4	—	RF mode operation count <sup>*7</sup>
• 139•23			• 44•07 RF TL	—	RF mode operation amount <sup>*7</sup>
4 23			No 5 #	—	No sale count
• 152•00			No 7 CA TL	—	CAL mode count
0 16	—	Non-link Department count <sup>*3</sup>	• 908•06 CA CD	—	Cash in drawer
• 94•90	—	Non-link Department amount <sup>*3</sup>	• 197•17 CH CD	—	Charge in drawer
			• 183•60 CK CD	—	Check in drawer
253	—	Gross No. of items	000000	—	Non-resettable grand sales total <sup>*2 *7</sup>
• 1146•90 TL	—	Gross sales	001217•63		
% -					
No 10	—	Premium/Discount count			
• 4•62	—	Premium/Discount amount			
No 8 -	—	Reduction count			
• 3•00	—	Reduction amount			
• 732•56 TA I	—	Taxable amount 1 <sup>*6</sup>			
• 56•80 TX I	—	Tax 1 <sup>*6</sup>			
• 409•72 TA II	—	Taxable amount 2 <sup>*6</sup>			
• 21•55 TX II	—	Tax 2 <sup>*6</sup>			
No 100	—	Net No. of customers			
• 1217•63 NS	—	Net amount			
1 No 38	—	Clerk No. <sup>*5</sup> /No. of customers <sup>*5</sup>			
• 404•06	—	Clerk amount <sup>*5</sup>			
2 No 17					
• 262•10					
3 No 20					
• 189•56					
4 No 25					
• 361•91					
No 81	—	Cash sales count			
• 836•86 CA	—	Cash sales amount			
No 10	—	Charge sales count			
• 197•17 CH	—	Charge sales amount			
No 9	—	Check sales count			
• 183•60 CK	—	Check sales amount			

\*1 Printed only when the clerk control function is active on the cash register.

\*2 Printed on RESET reports only.

\*3 Departments for which the amount and number of items are both zero are not printed.

\*4 The "\*" symbol is printed on the RESET report if an overflow occurred in the totalizer.

\*5 Printed only when the clerk control function is active on the cash register. Clerks for which the amount and number of items are both zero are not printed.

\*6 Taxable amount and tax are not printed unless the corresponding tax table is programmed.

\*7 This item can be programmed for printing/non-printing.

## PLU/sub-dept. READ/RESET report

12.01.96	—	Date
01 19:45	—	Machine No./Time
1 No 0175	—	Clerk No. <sup>*1</sup> /Consecutive No.
Z 0001	—	Non resettable No. of resets <sup>*2</sup> X = READ/Z = RESET
2 PL 12	—	PLU/sub-dept. No./No. of items <sup>*3</sup>
• 14.40	—	PLU/sub-dept. amount <sup>*3</sup>
3 PL 21		
• 27.30		
4 PL 5		
• 7.00		
5 PL 10		
• 15.00		
14 PL 8		
• 20.00		
15 PL 12		
• 36.00		
16 PL 5		
• 50.00		
28 PL 3		
• 60.00		
32 PL 13		
• 65.00		
37 PL 2		
• 60.00		
45 PL 4		
• 24.00		
.....		
95	—	Total No. of items
• 378.70	IL	Total amount

- \*1 Printed only when the clerk control function is active on the cash register.
- \*2 Printed on RESET reports only.
- \*3 PLUs/sub-departments for which the amount and number of items are both zero are not printed.

## Hourly sales READ/RESET report

12.01.96	—	Date
01 19:50	—	Machine No./Time
1 No 0176	—	Clerk No. <sup>*1</sup> / Consecutive No.
Z 0001	—	Non resettable No. of resets <sup>*2</sup> X = READ/Z = RESET
10.11	—	10:00 to 11:00
No 17	—	No. of customers <sup>*3</sup>
• 171.83	—	10:00 to 11:00 amount <sup>*3</sup>
11.12		
No 21		
• 196.20		
.....		
No 68	—	Total no. of customers
• 3356.29	—	Total amount

- \*1 Printed only when the clerk control function is active on the cash register.
- \*2 Printed on RESET reports only.
- \*3 Hours for which the amount and number of customers are both zero are not printed.

## Periodic sales READ/RESET report

12.01.96	—	Date
01 20:05	—	Machine No./Time
1 No 0183	—	Clerk No. <sup>*1</sup> / Consecutive No.
Z 0001	—	Non resettable No. of resets <sup>*2</sup> XX = READ/ZZ = RESET
Z		
1 69	—	Department No./Department No. of items <sup>*3</sup>
• 339.50	—	Department amount <sup>*3</sup>
2 19		
• 62.70		
3 31		
• 139.10		
4 23		
• 72.00		
0 18		
• 94.90	—	Gross No. of items
253	—	Gross amount
• 1146.90	IL	
No 100	—	No. of customers
• 1217.63	NS	Total amount

- \*1 Printed only when the clerk control function is active on the cash register.
- \*2 Printed on RESET reports only.
- \*3 Departments for which the amount and number of items are both zero are not printed.

## Monthly sales READ/RESET report

12·01·96	—	Date
01 20:15	—	Machine No./Time
1 No 0185	—	Clerk No.*1/Consecutive No.
Z 0001	—	Non resettable No. of resets *2 X = READ/Z = RESET
01 No 100	—	1st day of month/No. of customers for 1st day of month
•1217·63		
02 No 59	—	Amount for 2nd day of month
•813·28		
03 No 121		
•182·49		
No 2130	—	Total No. of customers for month
•11917·02 TL	—	Total amount for month

\*1 Printed only when the clerk control function is active on the cash register.

\*2 Printed on RESET reports only.

## Individual department report

12·01·96	—	Date
01 20:20	—	Machine No./Time
1 No 0186	—	Clerk No.*1/ Consecutive No.
X	—	Read symbol
1	69	Department No./ Department No. of items
•339·50		
3	31	Department amount
•139·10		
4	23	
•132·00		
	123	Total No. of items
•610·60 TL	—	Total amount

\*1 Printed only when the clerk control function is active on the cash register.

## Financial report

12·01·96	—	Date
01 20:25	—	Machine No./Time
1 No 0187	—	Clerk No.*1/Consecutive No.
X	—	Read symbol
	253	Gross No. of items
•1146·90 TL	—	Gross amount
No 100	—	Net No. of customers
•1217·63 NS	—	Net amount
•908·06 CA CD	—	Cash in drawer
•908·06 #	—	Declared amount *2
0·00	—	Difference between memory and declared amounts *2
•197·17 CH CD	—	Charge in drawer
•183·60 CK CD	—	Check in drawer

\*1 Printed only when the clerk control function is active on the cash register.

\*2 Printed only when you input the cash in drawer amount input before issuing the report.

## Individual PLU report

12·01·96	—	Date
01 20:30	—	Machine No./Time
1 No 0188	—	Clerk No.*1/Consecutive No.
X	—	Read symbol
3 PL	21	PLU/Sub-dept.No./ PLU/Sub-dept. No. of items
•27·30		
15 PL	12	PLU/Sub-dept. amount
•36·00		
32 PL	13	
•65·00		
	46	Total No. of items
•128·30 TL	—	Total amount

\*1 Printed only when the clerk control function is active on the cash register.

# Troubleshooting

This section describes what to do when you have problems with operation.

## When an error occurs...

Errors are indicated by an error tone. When this happens, you can usually find out what the problem is as illustrated below.

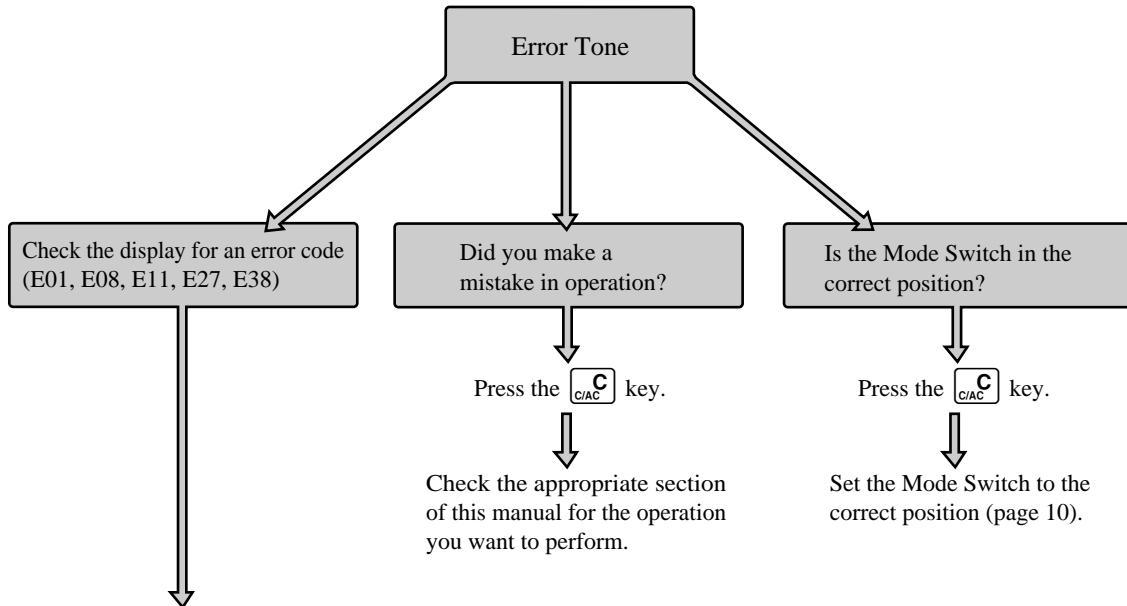

### Error codes

Error code	Meaning	Action
<b>E01</b>	Mode switch position changed before finalization.	Return the mode switch to its original setting and finalize the operation.
<b>E08</b>	Registration without entering a clerk number. This error appears only when the clerk control function is activated.	Enter a clerk number.
<b>E11</b>	Registration attempted while the drawer of the register is open.	Shut the drawer before attempting to perform a registration.
<b>E27</b>	Transaction cancel buffer is full.	Finalize the transaction.
<b>E38</b>	READ/RESET operation without declaration of cash in drawer. This error appears only when the money declaration (cash in drawer amount input) is required by programming.	Perform money declaration.

## When the register does not operate at all...

Perform the following check whenever the cash registers enter an error condition as soon as you switch it on. The results of this check are required by service personnel, so be sure to perform this check before you contact a CASIO representative for servicing.

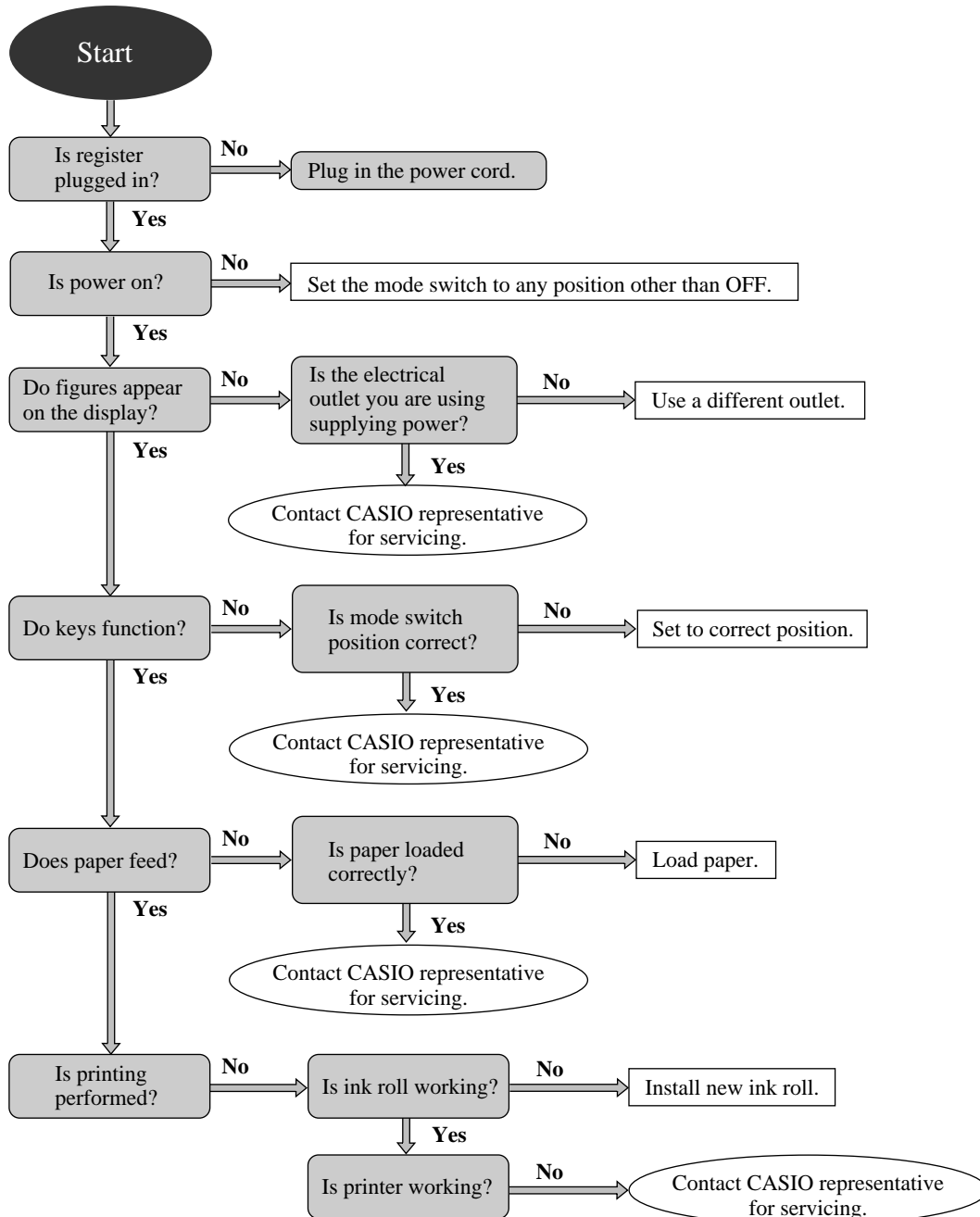

## In case of power failure...

If the power supply to the cash register is cut by a power failure or any other reason, simply wait for power to be restored. The details of any on-going transaction as well as all sales data in memory are protected by the memory backup batteries.

- Power failure during a registration  
The subtotal for items registered up to the power failure is retained in memory. You will be able to continue with the registration when power is restored.
- Power failure during printing or a READ/RESET report  
The data already printed before the power failure is retained in memory, so simply perform the READ/RESET operation after power is restored. Note that a power failure in this case increments the consecutive number.
- Power failure during printing of a receipt and journal  
Printing will resume after power is restored. A line that was being printed when the power failure occurred is reprinted in full.
- Other  
The power failure symbol is printed and any item that was being printed when the power failure occurred is reprinted in full.

### Important!

**Once receipt/journal printing or printing of a report starts, it can be stopped only by interruption of power to the cash register. Even if you set the mode switch to OFF while printing is being performed, the printing operation continues until it is completed. This means that once RESET printing starts, it will continue until printing of the report is completed and all sales data is cleared from memory.**

## About the low battery power indicator...

The following shows the low battery indicator.



If this indicator appears when you switch the cash register on, it can mean one of three things:

- No memory backup batteries are loaded in the cash register.
- The power of the batteries loaded in the unit is below a certain level.
- The batteries loaded in the cash register are dead.

To clear this sign, press the  key.

### Important!

**Whenever the low battery power indicator appears on the display, load a set of three new batteries as soon as possible. If there is a power failure or you unplug the cash register when one of the above three conditions exists, you will lose all of your settings and sales data.**

**BE SURE TO KEEP THE POWER CORD OF THE CASH REGISTER  
PLUGGED IN WHENEVER YOU REPLACE THE BATTERIES.**



## To replenish stamp ink

1. Remove the printer cover.
2. Grasp the stamp pad on both side and lift it out of its holder.
3. Fill one or two drops of ink into the hole on the back of the stamp.
4. Replace the stamp pad in its holder.
5. Replace the printer cover.

### Important!

Use only CASIO SUPER INK K. Chemical reaction between different of types of ink can damage the stamp pad.

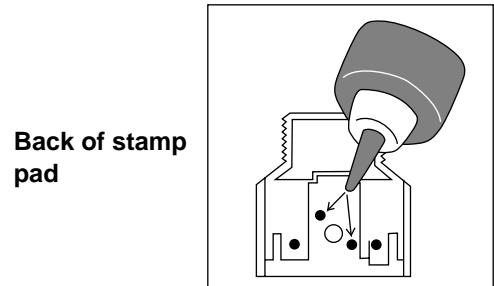
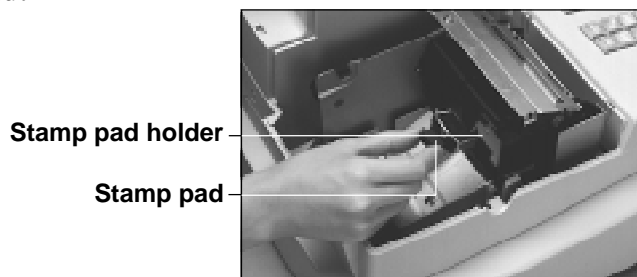

## To replace the ink roll

1. Remove the printer cover.
2. Grasp the center of the old ink roll and pull it towards you to remove it (Figure 1).
3. Install a new ink roll, inserting it straight into the register. Make sure that it fits securely in place (Figure 2).
4. Replace the printer cover.



Figure 1

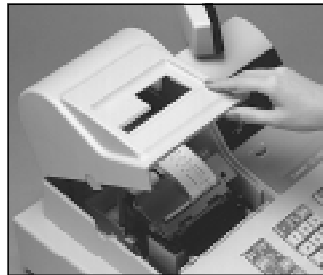
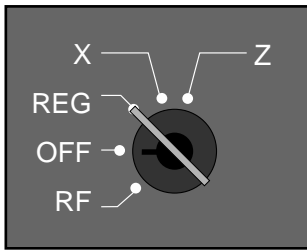

Figure 2

### Important!

Use only IR-93 ink rolls. Other types of ink rolls can damage the printer. Never try to extend the life of an ink roll replenishing the ink. Once an ink roll is in place, press the  key to test for correct operation.

## To replace journal paper



1 Set the mode switch to the REG position and remove the printer cover.



2 Press the **JOURNAL FEED** key to feed about 20 cm of paper.

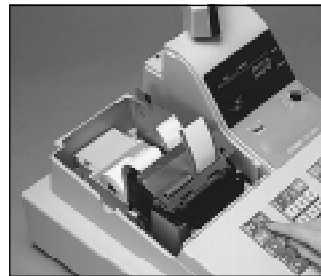

7 Press the **JOURNAL FEED** key to feed the remaining paper from the printer.



3 Cut the journal paper at a point where nothing is printed.



8 Do not pull the paper out of the printer by hand. Doing so can damage the printer.

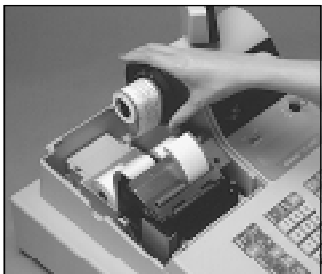

4 Remove the journal take-up reel from its holder.

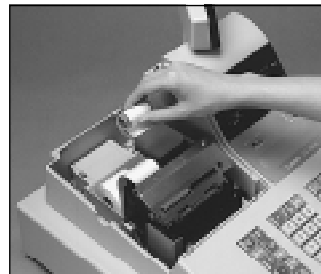

9 Remove the old paper roll from the cash register.



5 Slide the printed journal from the take-up reel.



6 Cut the journal paper as shown in the photograph.

10 Load new paper as described on page 16 of this manual.

## To replace receipt paper

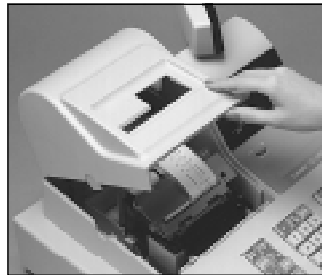
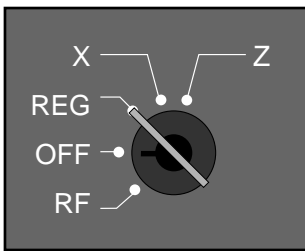

1 Set the mode switch to the REG position and remove the printer cover.

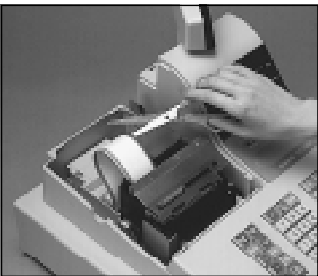

2 Cut the receipt paper as shown in the photograph.

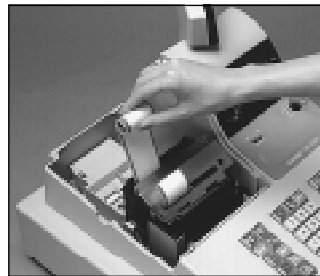

4 Do not pull the paper out of the printer by hand. Doing so can damage the printer.

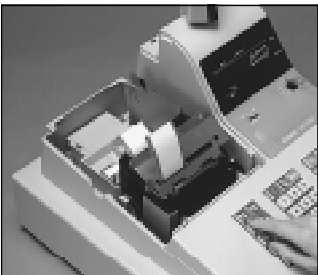

3 Press the **RECEIPT FEED** key to feed the remaining paper from the printer.



5 Remove the old paper roll from the cash register.

6 Load new paper as described on page 17 of this manual.

## Options

### WT-58 wetproof cover

The optional wetproof cover protects the keyboard from moisture damage.

### Department key conversion kit

Consult with your CASIO dealer or call 1-800-YO-CASIO for full details.

# CE-2400 Specifications

## INPUT METHOD

Entry: 10-key system; Buffer memory 14 keys (2-key roll over)  
 Department: Full key system

## DISPLAY (LED)

Amount 8 digits (Zero suppression); Department No.; PLU No;  
 No. of repeats; TOTAL; CHANGE

## PRINTER

Printer: 12 digits (Amount 10 digits/Symbol 2 digits)  
 Receipt: Receipt ON/OFF switch  
 Stamp is printed automatically  
 Stamp size: 15 (H) × 30 (W) mm  
 Journal: 12 digits (Amount 10 digits/Symbol 2 digits)  
 Automatic take up roll winding  
 Print speed: 2.5 lines/sec.  
 Feed speed: 12.5 lines/sec.  
 Paper roll: 45 mm × 83 mm ø (Max.)

## CALCULATIONS

Entry 8 digits; Registration 7 digits; Total 8 digits

## CHRONOLOGICAL DATA

Date print: Automatic date printout on receipts and journal  
 Automatic calendar  
 Time print: Automatic time printout on receipts and journal  
 Time display: 24-hour system

## ALARM

Entry confirmation signal; Error alarm

## TOTALIZERS

Category	No. of totalizers	Contents				Periodic totalizers
		Amount (8 digits)	No. of items (4 digits)	Count (4 digits)	No. of customers (4 digits)	
Department	40	○	○ (4 digits integer/ 2 digits decimal)			○
PLU	500	○	○ (4 digits integer/ 2 digits decimal)			
Hourly sales	24	○			○	
Monthly sales	31	○			○	
Clerk*	20	○			○	
Transaction	23	○ or ○	or ○	or ○	or ○	○
Non-resettable grand sales total	1	○ 14 digits				
Reset counter	5			○		○
Consecutive No.	1			○ 4 digits		

\* Available only when the clerk control function is active on the cash register.

## Memory protection batteries

The effective service life of the memory protection batteries (three new SUM-3 or UM-3 type batteries) is approximately one year from installation into the machine.

## Power supply/ Power consumption

As noted on the plate affixed to right side of register.

## Operating temperature

32°F ~ 104°F (0°C ~ 40°C)

## Humidity

10 ~ 90%

## Dimensions and weight

10<sup>5</sup>/<sub>8</sub>"(H) × 13<sup>3</sup>/<sub>4</sub>"(W) × 15<sup>15</sup>/<sub>16</sub>"(D)/17 lbs 3 oz ..... with medium size drawer

\* Specifications and design are subject to change without notice.

# Index

- A**  
Arithmetic operation key ..... 13, 66
- B**  
Battery compartment ..... 9, 14
- C**  
Calculator features ..... 66  
Calculator mode key ..... 13  
Cancel (key) ..... 12  
Cancel (registration) ..... 53  
Cash/Amount tender key ..... 13  
Charge (key) ..... 13  
Charge (registration) ..... 46  
Check (key) ..... 13  
Check (registration) ..... 46  
Clear (key) ..... 12  
Clear (operation) ..... 51, 66  
Clerk number key ..... 13  
Clerk sign on/off ..... 56  
Consecutive number ..... 27, 55, 62  
Correction ..... 51, 52  
Currency exchange (key) ..... 12  
Currency exchange (operation) ..... 64, 65
- D**  
Daily sales report ..... 68, 72  
Date & time display ..... 20  
Date & time setting ..... 19  
Department (key) ..... 13  
Department (registration) ..... 30 ~ 32  
Department report ..... 70  
Department shift key ..... 13  
Discount ..... 39 ~ 41  
Display ..... 9, 11  
Drawer ..... 9, 10  
Drawer lock ..... 9, 10  
Drawer open key ..... 13, 67  
Drawer release lever ..... 10
- E**  
Equal key ..... 13, 66  
Error code ..... 78  
Error correct key ..... 12  
Error correct registration ..... 52
- F**  
Feed key (Receipt/Journal) ..... 12  
Financial report ..... 70
- G**  
Grand total ..... 75
- H**  
High digit limitation ..... 30
- I**  
Ink roll (location) ..... 9  
Ink roll (replacement) ..... 81
- J**  
Journal ..... 27  
Journal feed key ..... 12  
Journal skip ..... 27, 55
- K**  
Key (Drawer key) ..... 9  
Key (Mode key) ..... 10  
Key (Operator key) ..... 10  
Key (Owner key) ..... 10  
Keyboard ..... 9, 12
- L**  
Load paper (Receipt/Journal) ..... 16, 17  
Low battery indicator ..... 80
- M**  
Machine number ..... 18, 27  
Main display ..... 9, 11  
Manual tax (key) ..... 12  
Manual tax (registration) ..... 61  
Memory backup battery ..... 14, 80  
Memory recall ..... 13, 66  
Merchandise subtotal ..... 13, 44  
Minus key (reduction) ..... 12, 42, 43  
Mode key ..... 10  
Mode switch ..... 9, 10  
Money declaration ..... 62, 68, 70, 72  
Multiplication (key) ..... 12  
Multiplication (registration) ..... 31, 36, 37
- N**  
No sale (key) ..... 12  
No sale (registration) ..... 53  
Non-add (key) ..... 12  
Non-add (registration) ..... 46  
Non-resettable grand total ..... 75

# Index

## O

Open key .....	13
Open key operation .....	30
Operator key .....	10
Owner key .....	10

## P

Paid out (key) .....	13
Paid out (registration) .....	50
Paper feed key (Receipt/Journal) .....	12
Paper installation .....	16, 17, 82, 83
Percent (key) .....	12
Percent (registration) .....	40, 41
Periodic report .....	69, 73
PLU/Sub-department key .....	12
PLU registration .....	35~ 38
Pop-up display .....	9, 11
Post receipt .....	57
Post receipt key .....	12
Power failure .....	80
Premium .....	41
Preset price (department) .....	29, 31
Preset price (PLU) .....	33, 35
Preset price (sub-department) .....	33, 36
Price key .....	12
Printer cover .....	9
Program read .....	68

## Q

## R

READ report .....	68 ~ 71
Receipt feed key .....	12
Receipt key (Post receipt key) .....	12
Receipt on/off switch .....	9
Received on account key .....	13
Received on account registration .....	50
Reduction (minus key) .....	43
Refund (key) .....	12
Refund key (registration) .....	48
Refund mode .....	10
Refund mode (registration) .....	49
Register mode .....	10
Repeat counter .....	11
Repeat registration .....	31, 35, 36
RESET report .....	71 ~ 73
Return operation .....	48, 49
Roll paper installation .....	16, 17, 82, 83
Roll paper specification .....	84

## S

Single-item-sale .....	58 ~ 60
Split package pricing .....	32, 38
Stamp (inking) .....	81
Stamp (location) .....	9
Sub-department .....	35 ~ 38
Subtotal (key) .....	13
Subtotal (printing) .....	55
Subtotal (registration) .....	31, 40

## T

Take-up reel .....	9
Tax calculation status (department) .....	28
Tax calculation status (PLU/sub-dept.) .....	34
Tax calculation status (discount/premium) .....	39
Tax calculation status (reduction) .....	42
Tax shift key .....	13
Tax shift operation .....	45
Tax table programming .....	21 ~ 25
Time setting .....	19

## U

## V

## W

## X

X mode (READ mode) .....	10
X report (READ report) .....	68 ~ 71

## Y

## Z

Z mode (RESET mode) .....	10
Z report (RESET report) .....	71 ~ 73

## LIMITED WARRANTY: ELECTRONIC CASH REGISTERS

This product, except the battery, is warranted by Casio to the original purchaser to be free from defects in material and workmanship under normal use for a period, from the date of purchase, of one year for parts and 90 days for labor. For one year, upon proof of purchase, the product will be repaired or replaced (with the same or a similar model) at Casio's option, at a Casio Authorized Service Center without charge for parts. Labor will be provided without charge for 90 days. The terminal resident software and programmable software, if any, included with this product or any programmable software which may be licensed by Casio or one of its authorized dealers, is warranted by Casio to the original licensee for a period of ninety (90) days from the date of license to conform substantially to published specifications and documentation provided it is used with the Casio hardware and software for which it is designed.

For a period of ninety (90) days, upon proof of license, Casio will, at its option, replace defective terminal resident software or programmable software, correct significant program errors, or refund the license fee for such software. Significant program errors will be significant deviations from written documentation or specifications. These are your sole remedies for any breach of warranty. In no event will Casio's liability exceed the license fee, if any, for such software. This warranty will not apply if the product has been misused, abused, or altered.

Without limiting the foregoing, battery leakage, bending of the unit, a broken display tube, and any cracks or breaks in the display will be presumed to have resulted from misuse or abuse. To obtain warranty service you must take or ship the product, freight prepaid, with a copy of the sales receipt or other proof of purchase and the date of purchase, to a Casio Authorized Service Center. Due to the possibility of damage or loss, it is recommended when shipping the product to a Casio Authorized Service Center that you package the product securely and ship it insured. CASIO HEREBY EXPRESSLY DISCLAIMS ALL OTHER WARRANTIES, EXPRESS OR IMPLIED, INCLUDING ANY IMPLIED WARRANTY OF MERCHANTABILITY OR OF FITNESS FOR A PARTICULAR PURPOSE. NO RESPONSIBILITY IS ASSUMED FOR ANY INCIDENTAL OR CONSEQUENTIAL DAMAGES, INCLUDING WITHOUT LIMITATION DAMAGES RESULTING FROM MATHEMATICAL INACCURACY OF THE PRODUCT OR LOSS OF STORED DATA. SOME STATES DO NOT ALLOW THE EXCLUSION OR LIMITATION OF INCIDENTAL OR CONSEQUENTIAL DAMAGES, SO THE ABOVE LIMITATIONS OR EXCLUSIONS MAY NOT APPLY TO YOU. This warranty gives you specific rights, and you may also have other rights which vary from state to state.

### CASIO, INC.

570 MOUNT PLEASANT AVENUE,  
P. O. BOX 7000, DOVER, NEW JERSEY 07801 U.S.A.

Model: ..... Serial Number: ..... Date of Purchase: .....

Your Name: .....

Address: .....

Dealer's Name: .....

Address: .....

**CASIO®**

**CASIO COMPUTER CO., LTD.**

6-1, Nishi-Shinjuku 2-chome  
Shinjuku-ku, Tokyo 163-02, Japan

SA9609-B Printed in Malaysia  
CE-2400 \* INC



## Free Manuals Download Website

<http://myh66.com>

<http://usermanuals.us>

<http://www.somanuals.com>

<http://www.4manuals.cc>

<http://www.manual-lib.com>

<http://www.404manual.com>

<http://www.luxmanual.com>

<http://aubethermostatmanual.com>

Golf course search by state

<http://golfingnear.com>

Email search by domain

<http://emailbydomain.com>

Auto manuals search

<http://auto.somanuals.com>

TV manuals search

<http://tv.somanuals.com>