

E

Introduction

Mastering
the Basics

Using the Full
Range of Features

Editing

Additional
Information

DIGITAL VIDEO CAMCORDER

Instruction Manual

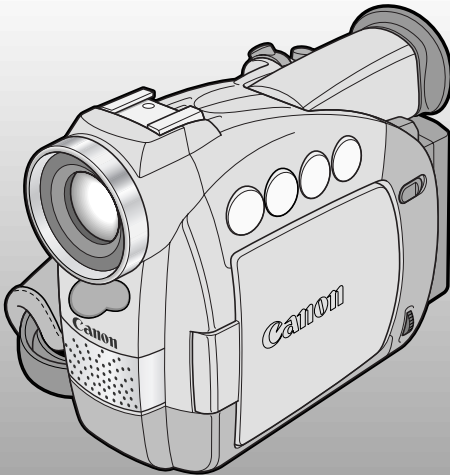

Canon

Mini DV Digital Video Cassette

MV500/MV500i

This instruction book explains the use of the MV500 and MV500i camcorders. The main difference between these models is that the MV500i includes a DV Recording and Analog Line-in Recording function. Please note that illustrations and explanations in this instruction book refer mainly to the MV500 model.

[Downloaded From VideoCamera-Manual.com Manuals](http://www.VideoCamera-Manual.com)

Download from www.Somanuals.com. All Manuals Search And Download.

Important Usage Instructions

E

Introduction

WARNING:



TO REDUCE THE RISK OF ELECTRIC SHOCK, DO NOT REMOVE COVER (OR BACK). NO USER SERVICEABLE PARTS INSIDE. REFER SERVICING TO QUALIFIED SERVICE PERSONNEL.

WARNING:



TO REDUCE THE RISK OF FIRE OR ELECTRIC SHOCK, DO NOT EXPOSE THIS PRODUCT TO RAIN OR MOISTURE.

CAUTION:

TO REDUCE THE RISK OF ELECTRIC SHOCK AND TO REDUCE ANNOYING INTERFERENCE, USE THE RECOMMENDED ACCESSORIES ONLY.

CAUTION:

DISCONNECT THE MAINS PLUG FROM THE SUPPLY SOCKET WHEN NOT IN USE.

For Users in the UK

When replacing the fuse only a correctly rated approved type should be used and be sure to re-fit the fuse cover.

CAUTION:

CUSTOMERS IN THE U.K. SHOULD READ THIS BEFORE USING THIS PRODUCT.

CHANGING THE FUSE

THE MAINS LEAD ON THIS PRODUCT IS FITTED WITH A NON-REWIREABLE (MOULDED) PLUG, INCORPORATING A 3 AMP FUSE. SHOULD THE FUSE NEED TO BE REPLACED AN ASTA OR BSI APPROVED BS1362 FUSE OF THE SAME RATING MUST BE USED.

ALWAYS REFIT THE FUSE COVER AFTER REPLACING THE FUSE. NEVER USE THE PLUG WITH THE FUSE COVER OMITTED.

CHANGING THE PLUG

IF THE FITTED PLUG IS NOT SUITABLE FOR YOUR SOCKET OUTLETS, IT SHOULD BE CUT OFF AND AN APPROPRIATE PLUG FITTED IN ITS PLACE. IF POSSIBLE FIT AN APPROPRIATE 3 AMP FUSE. IF THE NEW PLUG HAS NO FUSE, THEN FIT A 5 AMP FUSE AT THE DISTRIBUTION BOARD.

AC POWER CORD CONNECTION

The wires in the mains lead of this apparatus are coloured in accordance with the following cord.

(IMPORTANT)



As the colours of the wires in the mains lead may not correspond with the coloured markings identifying the terminals in your plug, proceed as follows: The wire which is coloured BLUE must be connected to the terminal which is marked with the letter N or coloured black. The wire which is coloured BROWN must be connected to the terminal which is marked with the letter L or coloured red. Neither Blue wire or Brown wire is to be connected to the Earth pin of a 3 pin plug.

THE SEVERED PLUG MUST BE DESTROYED IMMEDIATELY TO AVOID ANY POSSIBLE ELECTRIC SHOCK HAZARD.

CA-560 identification plate is located on the bottom.

- Use of CV-150F/CV-250F DV cable is necessary to comply with the technical requirement of EMC Directive.

Contents

Introduction

Important Usage Instructions	2
Thank you for Choosing a Canon	5
Introducing the MV500/MV500i	6

Mastering the Basics

Finding Your Way Around the MV500/MV500i.....	7
--	---

~ Preparations ~

Attaching the Ferrite Core.....	10
Powering Your Camcorder	11
Loading a Cassette	16

~ Basic Recording ~

Basic Recording	18
Zooming	23
Using the LCD Screen	25

~ Basic Playback ~

Playing Back a Cassette	28
Connections for Playback on a TV Screen.....	32
Tips for Making Better Videos	36

Using the Full Range of Features

~ General ... ~

Searching and Reviewing While Recording	38
Using the Menus	39
Using the Wireless Controller	43

~ For Recording ...~

Setting the Date and Time	46
Taking Still Pictures	49
Turning the Image Stabilizer Off	51
Using the Various Recording Programs ..	52
Using Digital Effects	56
Audio Recording	61
Setting the Self-Timer	63

~ When Making Manual Adjustments ...~

Ajusting AE Shift	65
Setting the Shutter Speed	66
Adjusting Focus Manually	68
Setting the White Balance	69

~ For Playback ...~

Displaying Date, Time and Camcorder Data (Data Code)	71
Searching the Tape (Photo Search/ Date Search).....	74
Returning to a Pre-Marked Position	75

Editing





Editing to a VCR.....	76
Dubbing with Digital Video Equipment ..	77
Recording from a VCR, TV or Analog Camcorder – Analog Line-in (MV500i only)	81
Digitally Outputting Analog Video and Audio Signals – Analog-Digital Converter (MV500i only)	83
Recording Over Existing Scenes – AV Insert Editing (MV500i only)	85
Audio Dubbing	88
Setting the Audio Mix	93
Connecting to a PC Using a DV Cable....	95

Additional Information







Preparing the Camcorder.....	96
Notes on Using the Batteries.....	98
Maintenance	101
Troubleshooting.....	105
The MV500/MV500i System Diagram..	108
Optional Accessories	109
Screen Displays	111
Specifications.....	117
Index	118
Menu at a Glance	120

For quick reference

In addition to the contents and index please refer to:

- Finding Your Way Around the MV500/MV500i ( 7)
- Screen displays ( 111)
- Troubleshooting — in case you run into any problems ( 105)
- Menu at a Glance ( 120)

Symbols used in this instruction manual:

-  : Reference page numbers
 -  : Functions that can be operated from the body of the camcorder
 -  : Functions that can be operated from the wireless controller
 -  : Supplementary notes for camcorder operation
 -  : Operation confirmation beeps ( 21)
- Capital letters are used to refer to settings displayed in the menus and buttons labelled on the camcorder itself, e.g. Press the MENU button.

Thank you for Choosing a Canon

First, we'd like to thank you for purchasing this Canon camcorder. Its advanced technology makes it very easy to use — you will soon be making high-quality videos which will give you pleasure for years to come.







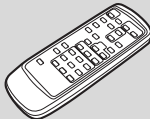
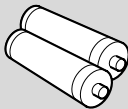
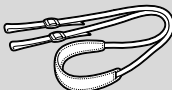

To get the most out of your new camcorder, we recommend that you read this manual thoroughly — there are many sophisticated features which will add to your recording enjoyment.

Getting started

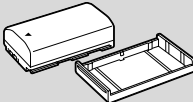
To get started we suggest that you master the basic operations of the camcorder first, before moving on to use its full range of features.

- When connecting the camcorder to your personal computer, use the optional CV-150F or CV-250F DV cable.

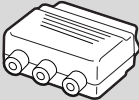
Your camcorder is supplied with the following accessories:

WL-D74 Wireless Controller 	Two AA batteries 
SS-800 Shoulder Strap 	Lens cap and lens cap cord 
BP-508 Battery Pack 	CA-560 Compact Power Adapter (including AC power cable) 
Lithium button battery 	STV-250N Stereo Video Cable 
PC-A10 SCART Adapter (Europe, Asia) 	Ferrite Core 

Introducing the MV500/MV500i

E

Introduction

Compact and Stylish

The MV500/MV500i is small and light. Many various functions are condensed into its compact body. Also, the slim and stylish design makes it easy to carry and use and shooting videos a pleasure.

18× Lens and 360× Digital Zoom



From wide-angle to 18× telephoto—with unparalleled optical quality. The digital zoom magnifies this up to 360× for even more dramatic results.

Night Mode

In dark places, automatically adjusts to the optimum shutter speed according to the brightness of the subject for shooting brightly in colour.

IEEE 1394 DV Terminal

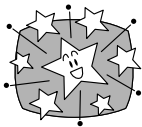

Using a DV cable, connect the camcorder to a PC equipped with a DV terminal and transfer your original images and sound to your PC.

Still Photos



Just press the photo button to capture still pictures.

2.5" LCD Screen



A 2.5" LCD screen makes it easy for you to shoot colourful, well composed video. It is also great for playback.

Image Stabilizer



Stabilizes your recordings even in long telephoto shots.

Digital Effects



Advanced digital technology allows you to add special effects during recording or playback.

Audio Dubbing

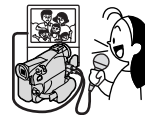

Add new sound to original sound on a prerecorded tape.

Analog Line-in Recording and AV Insert Editing (MV500i only)

Connect to a VCR or analog camcorder and record to a DV tape in the MV500i. Also, replace original images on a pre-recorded tape.

Finding Your Way Around the MV500/MV500i

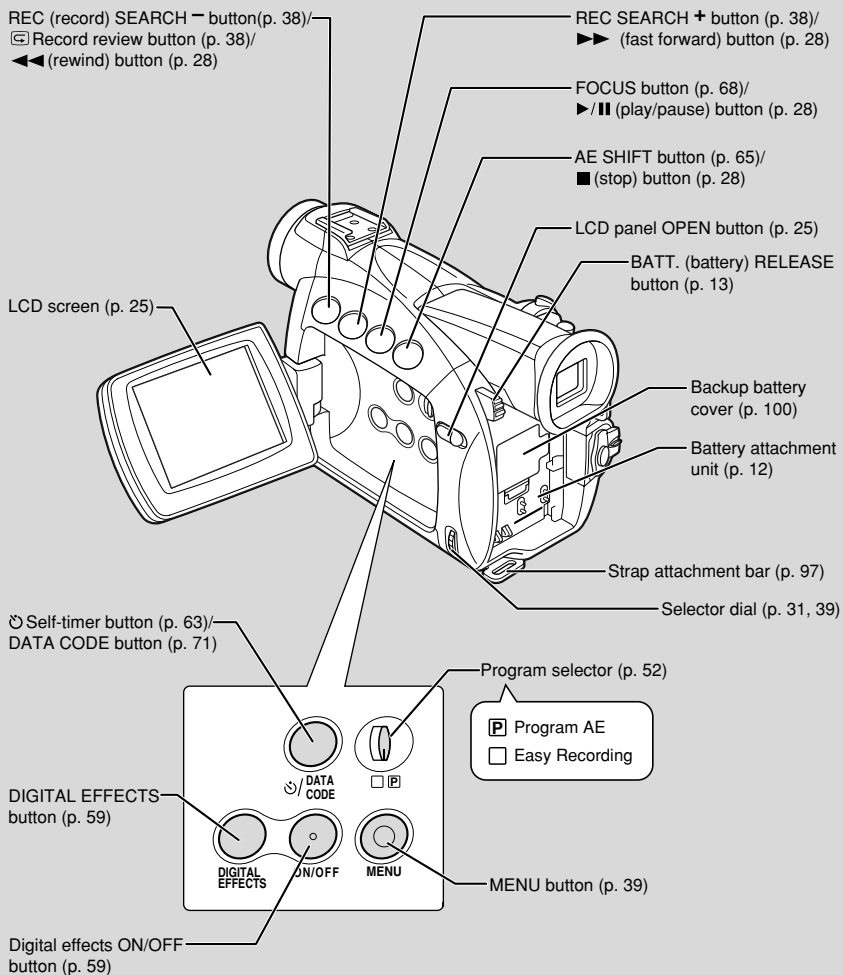

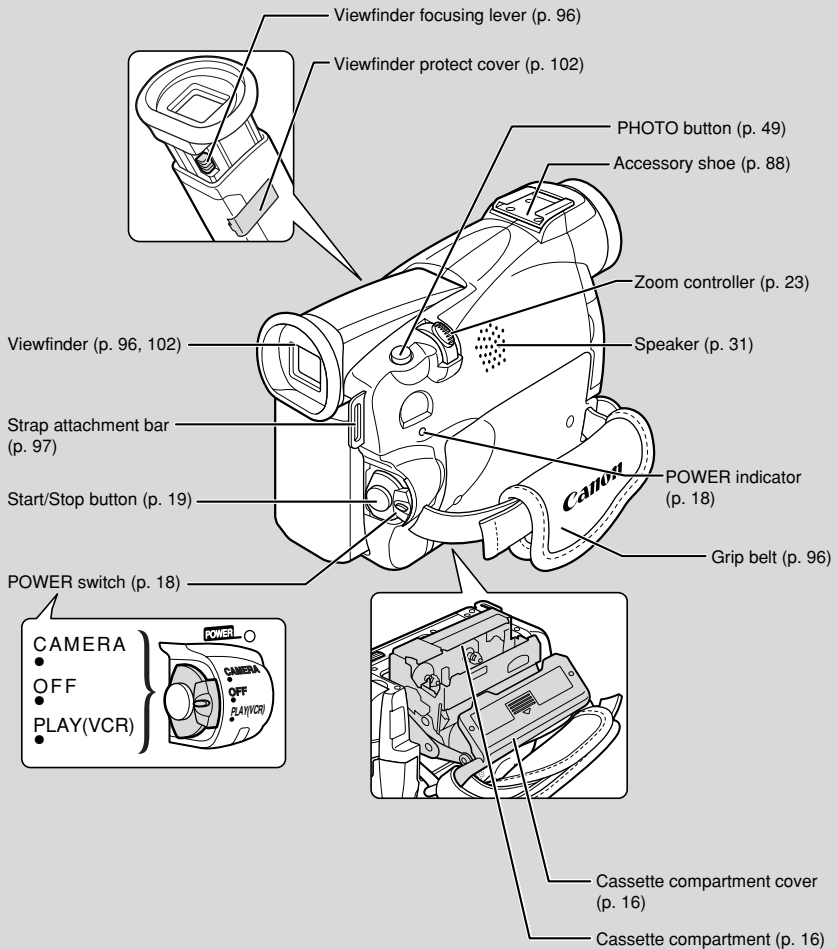

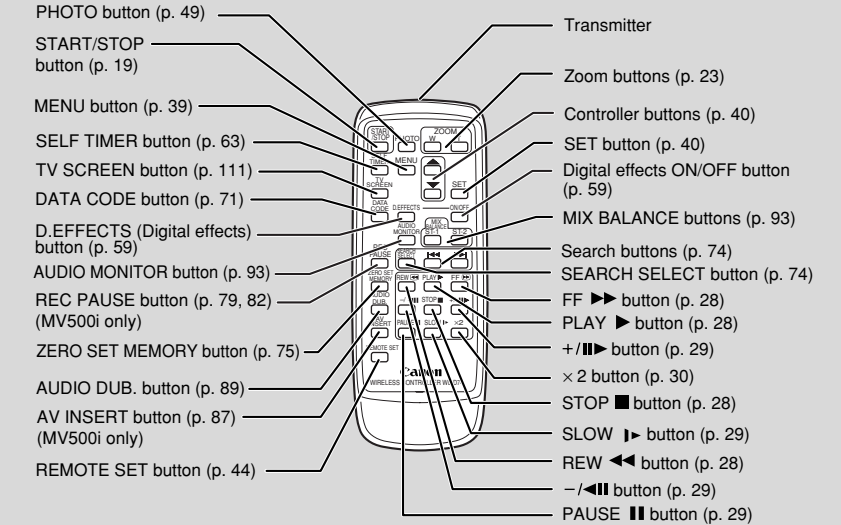
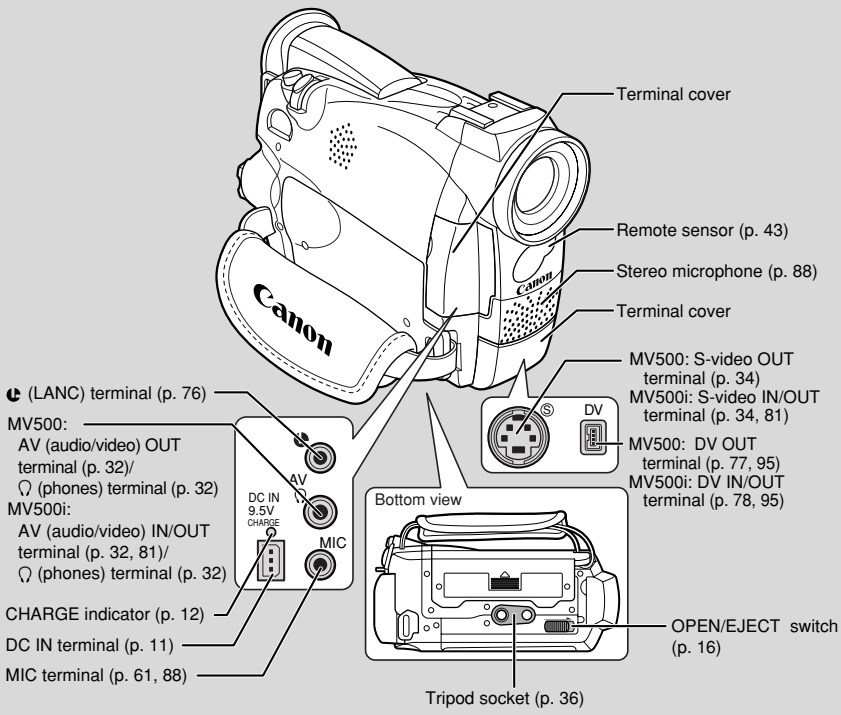

Attaching the Ferrite Core

E

Attach the enclosed ferrite core before you connect the CA-560 Compact Power Adapter to the camcorder.

Attach the ferrite core to the cable about 4 cm from the plug end (the plug to be connected to the camcorder) of the CA-560 Compact Power Adapter.

- Pass the cable through the centre of the core and wrap it around the core once, then close the unit until it clicks shut.

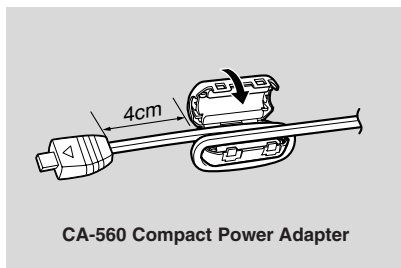

Powering Your Camcorder

Before operating your camcorder, you will need to use the power adapter to:

Provide power from a mains outlet

or

Charge a battery pack

 **Notes:**

- The power adapter converts current from a household power socket (100–240 V AC, 50/60 Hz) to the DC current used by your camcorder.
- If the adapter is used next to a TV, it may cause bars to appear on the TV — move the adapter away from the TV or the aerial cable.

Connecting the camcorder to a mains outlet

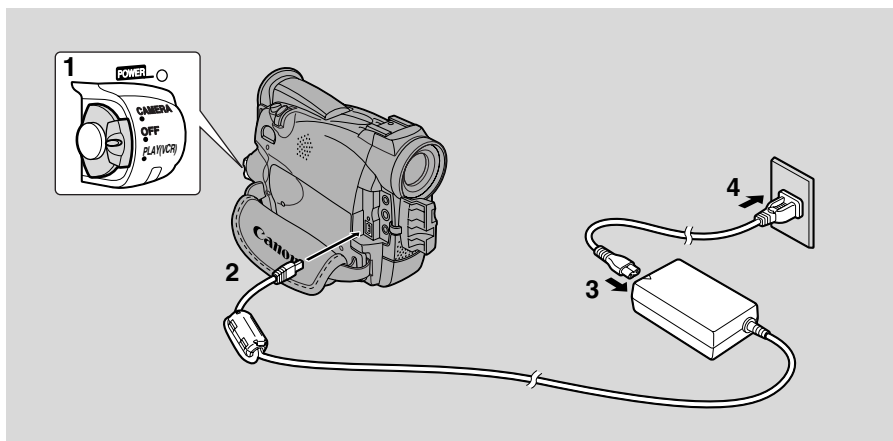

Use the power adapter to provide your camcorder with instant power from a mains outlet. Always turn the camcorder off before connecting/removing the power source.

1. Set the **POWER** switch to **OFF**.
2. Connect the power adapter to the camcorder's **DC IN** terminal.
3. Connect the power cable to the power adapter.
4. Plug the power cable into a mains outlet.
5. Disconnect the power adapter from the camcorder after use.
Unplug the power cable from the mains outlet, then disconnect it from the adapter.

Attaching and charging the battery packs

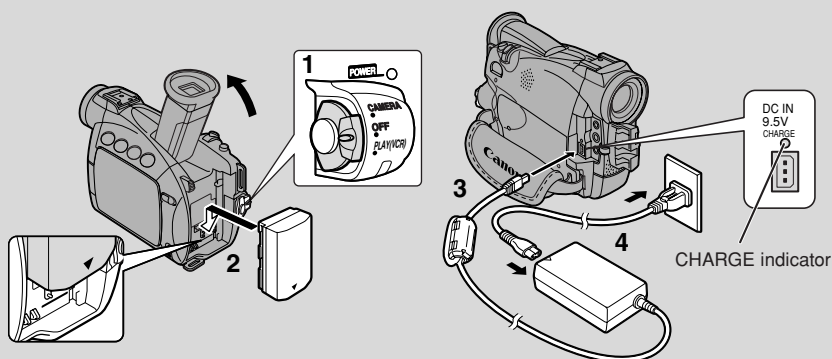

Your battery pack was partially charged before it left the factory. It should have enough power for you to check that your camcorder is working properly. However, you must charge the battery pack fully if you want it to power the camcorder for more than a few minutes.

Always turn the camcorder off before connecting/removing the battery.

1. Set the **POWER** switch to **OFF**.

2. Attach the battery to the camcorder.

- Remove the battery pack's terminal cover.
- Rotate the viewfinder upwards.
- With the triangle on the battery pack pointing downwards, align the edge of the battery pack with the line on the camcorder, press lightly and slide the battery down until it clicks into place.

3. Connect the power adapter to the camcorder.

4. Connect the power cable to the adapter and plug it into a mains outlet.

- The charge indicator flashes red to show that charging is in progress. Single flashes mean that the battery pack is less than 50% charged. Double flashes mean that it is more than 50% charged. The indicator glows steadily when the battery pack is fully charged. If the indicator blinks rapidly and continuously (twice a second), the battery pack may be defective.
- The battery pack will also charge when the POWER switch is turned to positions other than OFF. The CHARGE indicator may flash.

5. When charging is complete, disconnect the power adapter from the camcorder. Unplug the power cable from the mains outlet, then disconnect it from the adapter.

6. Remove the battery pack after use.

- Rotate the viewfinder upwards.
- Press and hold the BATT. RELEASE button while you slide the battery up.



Notes:

- Never connect an unspecified product to the camcorder's DC terminal. Likewise, do not connect the power adapter to an unspecified product.
- You can find detailed notes for using the batteries in the "Notes on Using the Batteries" (📖 98). These notes include charging and recording times and how to install the backup battery.

CA-560 Compact Power Adapter

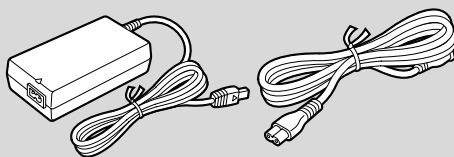

Specifications

Power supply	100–240 V AC, 50/60 Hz
Power consumption	34 W
Rated output	9.5 V, 2.7 A DC
Operating temperature range	0°C–40°C (32°F–104°F)
Dimensions	57 × 28 × 104 mm (2 1/4 × 1 1/8 × 4 1/8 in)
Weight	180 g (6 3/8 oz) (without power cable)

Weight and dimensions are approximate.
Errors and omissions excepted.
Subject to change without notice.

Using the Charge Adapter CR-560 Kit (optional)

The Compact Power Adapter CA-560 included with the camcorder can be used along with the CR-560 Kit for 3 different ways to power the camcorder or charge battery packs:

1. Charge the BP-500 Series battery packs with power from your car battery.
2. Operate the camcorder with power from your car battery.
3. Charge the BP-500 Series battery packs from a household mains outlet.

The Charge Adapter/Car Battery Cable Kit CR-560 includes the following:

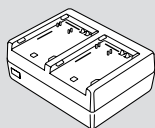

Charge Adapter

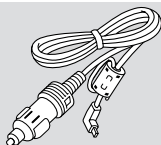

Car Battery Cable

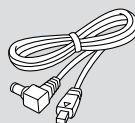

DC Cable

1. Charge the BP-500 Series battery packs with power from your car battery.

1 or 2 battery pack(s) + Charge Adapter + Car Battery Cable → car's cigarette lighter

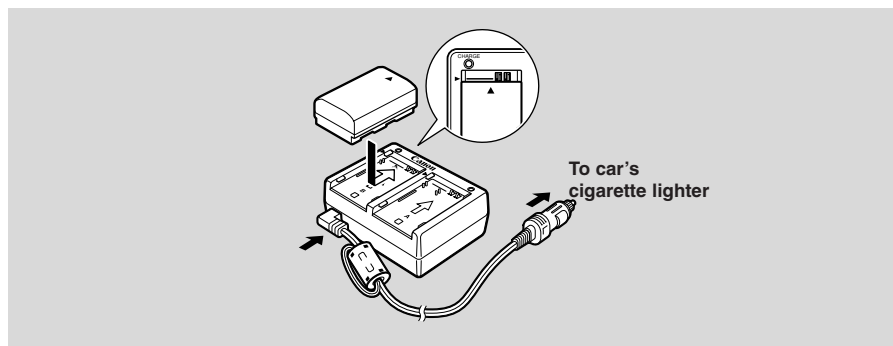

- Fast charging for the high-capacity BP-522 and BP-535 (both optional). Fifteen minutes of charging gives 70 minutes of recording (using the viewfinder).

	Time required for full charge from car battery or a mains outlet
BP-508	1 hr. 20 min.
BP-512 (optional)	1 hr. 20 min.
BP-511 (optional)	1 hr. 20 min.
BP-522 (optional)	1 hr. 40 min.
BP-535 (optional)	2 hr. 30 min.

2. Operate the camcorder with power from your car battery.

Camcorder + DC Cable + Charge Adapter + Car Battery Cable → car's cigarette lighter

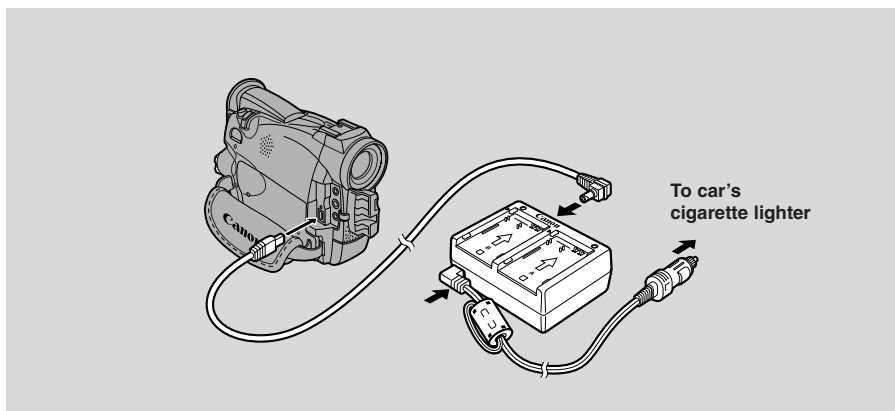

3. Charge the BP-500 Series battery packs from a mains outlet.

1 or 2 battery pack(s) + Charge Adapter + Compact Power Adapter

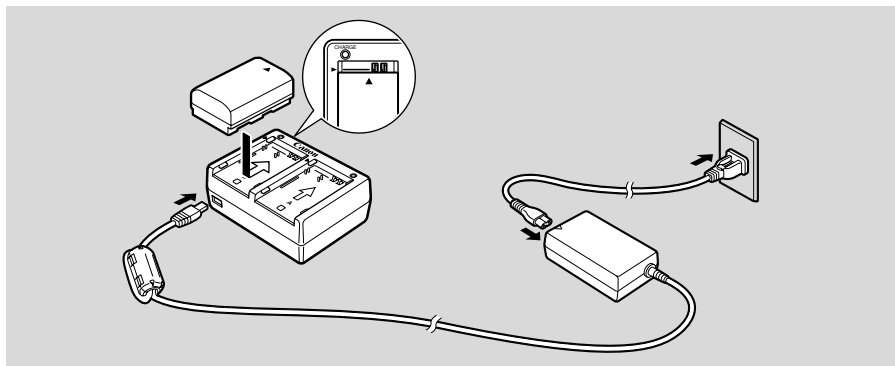

- Fast charging for the high-capacity BP-522 and BP-535 (both optional). Fifteen minutes of charging gives 70 minutes of recording (using the viewfinder).



Note:

- For full details of how to use the CR-560, refer to its instruction manual.

Loading a Cassette

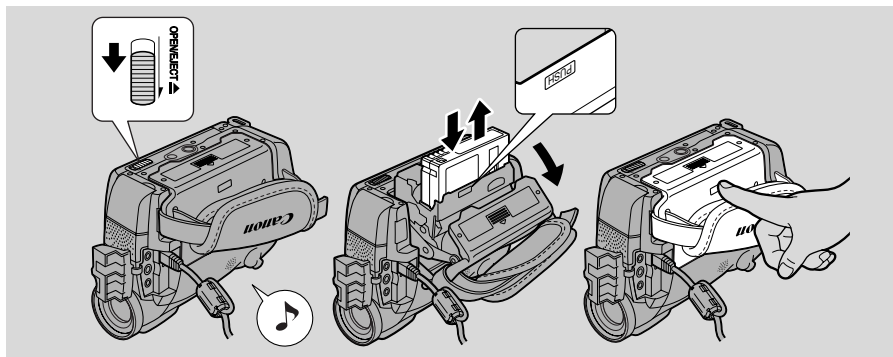

Only use videocassettes marked with the Mini DV logo.*

Loading and unloading

1. **Make sure that you have attached a power source.**
2. **Slide the OPEN / EJECT \blacktriangle switch (on the bottom of the camcorder) to release the cassette compartment cover.**
 - Pull the cover fully open (while holding the button) and wait a couple of seconds for the cassette compartment to open automatically.
 - The confirmation beep sounds when the cassette cover fully opens.
3. **Load or unload the cassette.**
 - Insert the cassette gently with the window facing the grip belt, and the REC/SAVE tab up.
 - Remove the cassette by pulling it straight out.
4. **Press the **PUSH** mark on the compartment until it clicks, and wait for it to close.**
5. **Click the cover back into place.**

* Mini DV is a trade mark.



Notes:

- Do not interfere with the cassette compartment while it is opening or closing automatically, and do not attempt to close the cover until the cassette compartment has fully retracted.
- After loading a cassette, use record search (38) to find the point where you want to start recording.
- Be careful not to get your fingers caught in the cassette compartment cover.
- Do not leave the cassette in the camcorder after use — return it to its case and store it in a cool, clean, dry place.
- When you turn the camcorder's power on, flashes in the display until you load a cassette.
- With some types of tapes, the remaining tape display may not give an accurate reading (112).

Protecting tapes from accidental erasure

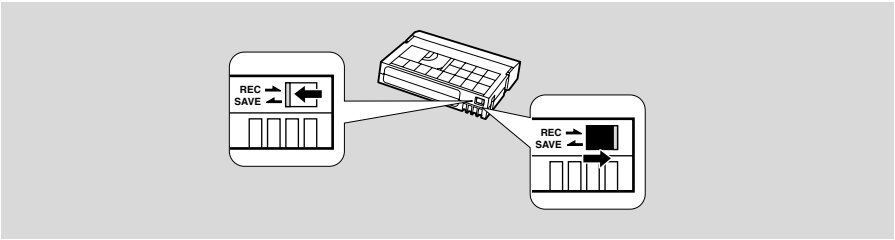

To protect your recording from accidental erasure, slide the tab on the cassette so that it exposes the hole. (This switch position is usually labelled SAVE or ERASE OFF.)

If you load this cassette and put the camcorder in record pause mode (18), “THE TAPE IS SET FOR ERASURE PREVENTION” is displayed for approx. 4 seconds and then the  mark flashes in the display.

If you want to record on the cassette again, slide the tab back so the hole is closed.

Handling cassettes

- To protect the tape heads, transfer cassettes directly from the tape case to the camcorder — do not open the tape protect cover or touch the tape itself.
- Do not use cassettes where the tape has been damaged or spliced — they may damage the camcorder.
- Do not insert anything into the small holes on the cassette or cover them with cellophane tape.
- Handle cassettes with care — dropping them or exposing them to external shocks may cause internal damage.
- Store cassettes in the provided case, first rewinding them to the start of the tape and then storing them upright.
- A cassette with metal plated terminals may become dirty with use, affecting information transfer. Therefore, after using a tape about 10 times, be sure to clean the terminals with a cotton bud.

Cassette memory

You are unable to use the cassette memory function with this camcorder.

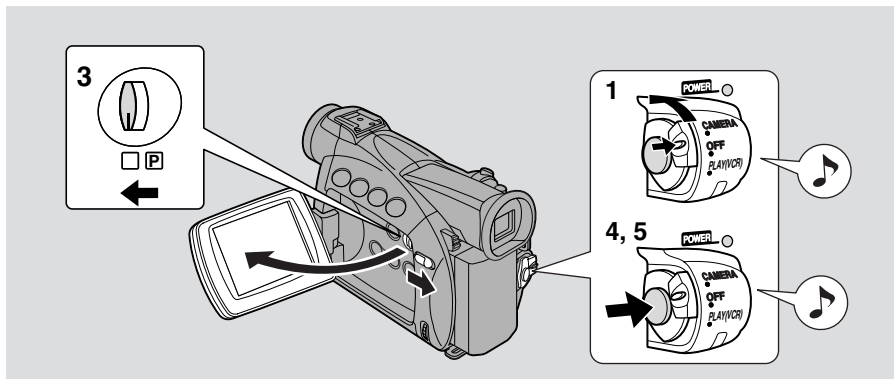

Before you start recording

Have you completed the following steps?

- Attached a power source (11).
- Removed the lens cap (96).
- Fastened the grip belt (96).
- Chosen the display: viewfinder (96) or LCD screen (25).



Notes:



- When you're using the viewfinder, fully close the LCD or rotate the LCD so that it faces the same direction as the lens (25).
- When using the viewfinder with the BP-522 or BP-535 Battery Pack (both optional) attached, extend the viewfinder and rotate it to a comfortable angle.

You may also want to install the backup battery (100) in order to set the date and time display (46).

To record

1. Press the small button on the POWER switch and hold, turn the POWER switch to CAMERA.

- The camcorder automatically sets to record pause mode. PAUSE appears in the display.
- If you haven't set the date and time display, SET THE TIME ZONE, DATE AND TIME appears in the display. For setting the time zone, see p. 46. For setting the date and time, see p. 48.
- The camcorder power indicator lights up.
- The confirmation beep sounds.
- The camcorder will turn itself off if you leave it in record pause mode for more than about 5 minutes. To return to record pause mode, turn the POWER switch to OFF and then back to CAMERA.

2. **Load a cassette** ( 16).
3. **Slide the program selector to** 
 - This selects the camcorder's Easy Recording program. It allows you to simply point and shoot without making any manual adjustments ( 52).
4. **Press and release the start/stop button once to begin recording.**
 - For still image recording to a cassette, see p. 49.
5. **Press and release the start/stop button again to pause recording.**
 - The camcorder returns to record pause mode and PAUSE reappears in the display.
 - You can stop and restart recording as often as you like by pressing the start/stop button.

**Note:**

- After loading a cassette, start recording when the tape counter has stopped.

When you have finished recording

- Replace the lens cap.
- Return the viewfinder to its retracted position.
- Return the LCD screen flush to the camcorder body.
- Unload the cassette.
- Turn the POWER switch to OFF.
- Disconnect the power source.

**Notes:**

- To check that the camcorder is recording correctly, make a test recording first.
- Before making important recordings, clean the video heads using a Canon DVM-CL Digital Video Head Cleaning Cassette or a commercially available digital video head cleaning cassette.
- To close the LCD panel, rotate it vertically until the screen faces you, then press the upper right corner until it clicks securely closed.
- You cannot monitor the sound from the speaker when recording.
- For tips on how to make better videos, see p. 36.
- For extra recording time, set REC MODE to LP ( 20).

Changing the recording mode



You can record and play back a tape in SP (standard play) and LP (long play) modes. LP extends tape usage by 1.5 times.

You can't add sound (audio dubbing) or images (AV insert) to a tape that has been recorded in a mode other than SP mode. If you plan to use either of these functions later, record in SP mode.



To change to LP mode, open the menu and select VCR SET UP. Then select REC MODE, set it to LP and close the menu.

Notes:

- When recording and playing back tapes in LP mode, the nature of the tape and usage conditions may affect recording, mosaic-like noise may appear in the image and the sound may be distorted during playback. For important recordings, therefore, set the camcorder to SP mode.
- We recommend recording in SP mode when you plan to transfer images taken with the camcorder to your PC.
- If you record in both modes on the same tape, the picture may become distorted during playback and the time code may not be written correctly.
- A tape recorded in LP mode on other digital equipment may produce the mosaic-like noise and the sound may become distorted when playing back on this camcorder.
- A tape recorded in LP mode on this camcorder may produce the mosaic-like noise and the sound may become distorted when playing back on other digital equipment.

16:9 (Wide screen TV recording)

Produces images in the 16:9 format for playback on wide screen TVs.

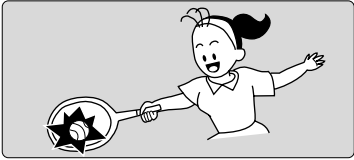

CAMERA

MENU
( 39)



To switch 16:9 to ON, open the menu and select CAM.SET UP. Then select 16:9, set it to ON and close the menu.



Notes:

- “16:9” is shown in the display when you switch the 16:9 mode on.
- You cannot use the 16:9 mode with the Easy Recording program.
- If you play back a recording made for 16:9 on a normal TV screen, the image will appear to be vertically “squashed” (compressed).

Confirmation/Warning beeps

The camcorder’s short operation confirmation beeps are indicated by  in the illustrations. Beeps sound upon certain camcorder operations such as when you turn the camcorder on, during the self-timer countdown, right before the camcorder’s automatic shut-off, and also upon any unusual condition of the camcorder. Beeps are not recorded on the tape.

CAMERA ,

PLAY (VCR)

MENU
( 39)



To turn the beep off, open the menu and select SYSTEM. Then select BEEP, set it to OFF and close the menu.

Demonstration mode



You can see a demonstration of the camcorder's main features. To see the demonstration, do either of the following:

- With no cassette inserted, turn the DEMO MODE on in the CAMERA menu and close the menu.
- Leave the camcorder with no cassette inserted for five minutes after turning it on.

CAMERA

MENU

(39)

▶ DISP. SET UP

▶▶ DEMO MODE ON

To turn the demonstration mode off, open the menu and select DISP. SET UP. Then select DEMO MODE, set it to OFF and close the menu.



Note:

- To cancel the demo mode once it has begun: push any button, turn off the power or load a cassette.

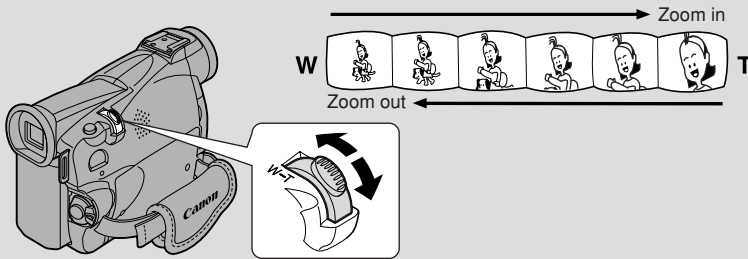

18× optical zoom

The camcorder's zoom lens allows you to choose the best picture angle for each scene:

- Move the zoom control towards W to zoom out to wide-angle.
- Move it towards T to zoom in to telephoto.

You can also control the speed of zooming:

- Move the control slightly to zoom slowly.
- Move it farther to zoom more quickly. (The farther you move the zoom control, the faster the zoom speed.)

The T and W buttons on the wireless controller adjust the picture angle, but not the zoom speed.

72×/360× digital zoom

Magnifies the camcorder's zoom range by up to 20× in CAMERA mode.

The zoom control continues to work as usual. You can freely zoom in and out between 1× and 360× magnification — the camcorder automatically switches between optical zooming (up to 18×) and digital zooming (18× to 72× or 18× to 360×).

CAMERA**MENU**

(39)

▶CAM.SET UP

▶D.ZOOM.....72×

To change the digital zoom, open the menu and select CAM.SET UP. Then select D.ZOOM, set it to OFF or 360× and close the menu.

**Notes:**

- When zooming, as a rule, keep at least 1 m (3 ft $3\frac{3}{8}$ in) between you and your subject. However when the zoom is at the wide-angle position, you can focus on a subject as close as 1 cm ($\frac{3}{8}$ in).
- Image resolution is slightly lower when the magnification is greater than 18 \times .
- You cannot use digital zoom in the Night recording program.
- The zoom indicator appears for 4 seconds. When the digital zoom is set to 72 \times , the zoom indicator extends (light blue). When the digital zoom is set to 360 \times zoom, the zoom indicator extends again (a darker blue).

Using the LCD Screen

Opening and closing the LCD screen

Slide the LCD panel OPEN button and open the panel by pulling it away from the camcorder. This automatically switches the LCD screen on and the viewfinder off. To close the LCD panel, press the upper right corner until it clicks securely closed. When you close the LCD panel, the LCD screen automatically switches off and the viewfinder switches back on.

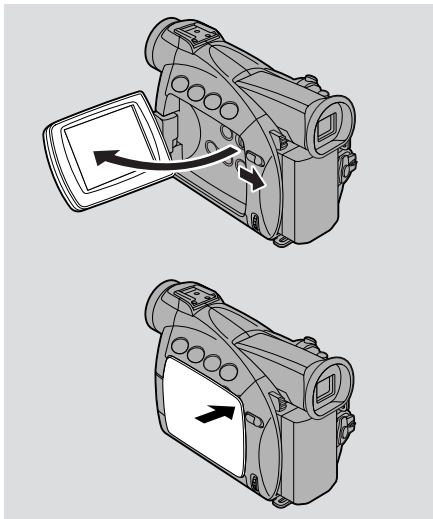

Changing the angle of the LCD screen

You can choose the angle of the screen that suits you best by opening and rotating the screen, also you can rotate the LCD screen so that faces in the direction of the lens (27).

You can also push the panel flat against the camcorder until it is flush with the side, with the screen facing outwards.

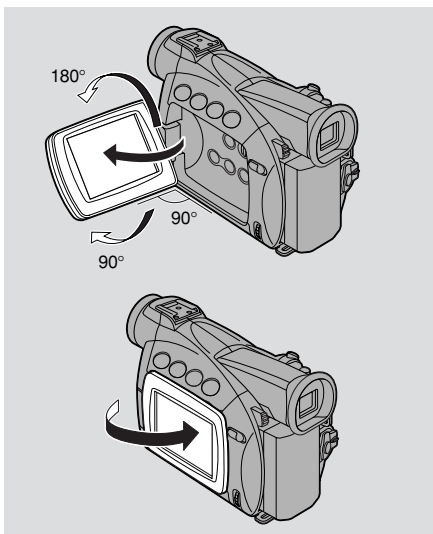

Notes:

- Avoid touching the LCD screen when moving the LCD panel.
- Do not hold the camcorder by the LCD panel or the viewfinder.
- Make sure you open the LCD panel at 90°, before attempting to rotate it.

- Always rotate the LCD panel vertically into place, before closing it or pushing it flat against the side of the camcorder.
- Always fully close the LCD panel until it clicks securely.
- Be careful not to leave the LCD, viewfinder or lens exposed to direct sunlight outdoors or in a window. Doing so could cause damage.
- Bright light falling on the LCD screen may cause glare that makes it difficult for you to view the image. In this case, switch to using the viewfinder. You are also able to adjust the brightness of the screen (see “Adjusting the LCD screen” below).

Adjusting the LCD screen



You can adjust the brightness of the LCD screen.

CAMERA

PLAY
(VCR)

MENU

(39)

▶ DISP.SET UP

▶▶ BRIGHTNESS . . . ———+

Open the menu and select DISP.SET UP from the menu. Then select BRIGHTNESS, adjust the level with the selector dial and close the menu.

A bar showing the level appears in the display.

- Turn the selector dial up to make the display brighter.
- Turn the selector dial down to make the display darker.



Notes:

- The camcorder will remember your brightness setting even after you turn it off.
- The brightness of the LCD does not affect that of the recorded images or the viewfinder.

About the LCD Screen

The LCD screen built into this camcorder is a high precision product.

However, small black dots or bright points of light (red, blue or green) may appear constantly on the LCD screen. This is not a malfunction of the LCD screen and they are not recorded on the tape. (Effective dots: more than 99.99%)

Allowing the subject to monitor recording



E

When you turn the LCD panel so that it faces the same direction as the lens, you can watch yourself during recording or let your subject monitor recording. The viewfinder is also activated when the panel is in this position. (Adjust the viewfinder, [96](#))

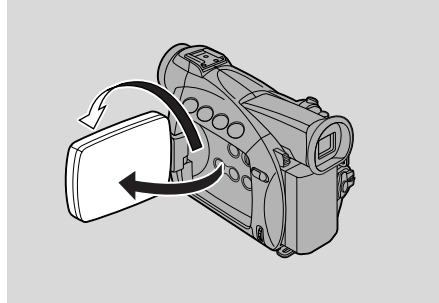

Mastering
the Basics

- You can choose the display style, reversed (mirror on) or not (mirror off). The recording itself is unaffected regardless of which one you choose.

CAMERA

MENU

([39](#))

▶ DISP.SET UP

▶ MIRROR.....ON

To turn the mirror mode off, open the menu and select **DISP.SET UP**. Then select **MIRROR**, set it to **OFF** and close the menu.

The indicators that appear in the LCD display when **MIRROR** is turned on:

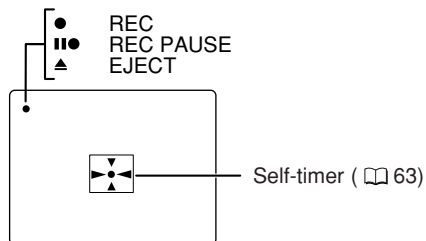

- These and all other indicators appear normally in the viewfinder.

Playing Back a Cassette

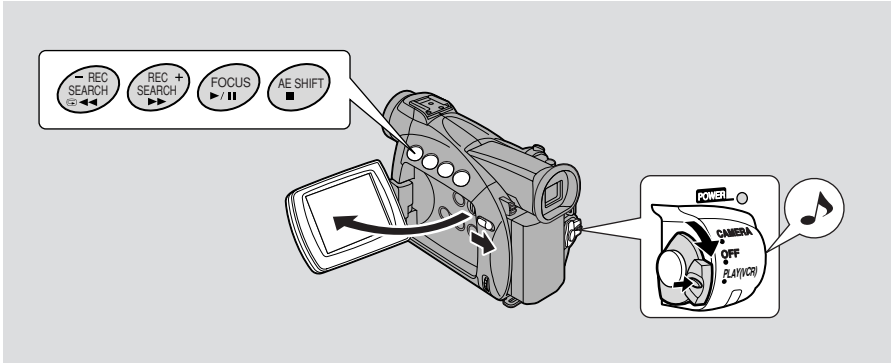

You can use the LCD screen for instant, on-the-spot playback. The camcorder also plays back the sound track via the built-in speaker (31).

- When you play back a tape, you can also close the LCD panel with its screen side facing up.
- When you're using the viewfinder to view playback, close the LCD panel.

To play back your recordings on a TV, see p. 32.

To use the wireless controller, see p. 43.

Note:

- To avoid accidental recording, make sure that you slide the tab on the cassette so that it exposes the hole (the switch position is usually labelled SAVE or ERASE OFF).

1. Attach a power source and turn the POWER switch to PLAY (VCR).

- The power indicator lights up.

2. Load the cassette.

3. Press the ► (play) button to start playback.

- To end playback, press the ■ (stop) button.
- To wind the tape forwards, stop playback and press the ►► (fast forward) button.
- To wind the tape backwards, stop playback and press the ◀◀ (rewind) button.
- If the playback picture is rough (mosaic-like noise), clean the video heads using a Canon DVM-CL Digital Video Head Cleaning Cassette or a commercially available digital video head cleaning cassette.



Other playback modes



Playback pause

Press the **||** (pause) button. To resume normal playback, press it again, or press the **▶** (play) button. The camcorder automatically goes into stop mode after about 5 minutes' playback pause.

Fast forward playback

To play back the recording at about 11.5 times normal speed, press and hold the **▶▶** (fast forward) button during normal playback or press and hold the **▶▶** (fast forward) button during normal fast forward.

Rewind playback

For reverse playback at about 11.5 times normal speed, press and hold the **◀◀** (rewind) button during normal playback or press and hold the **◀◀** (rewind) button during normal rewind.

Special playback



Frame Advance

To play back frame by frame, press the **+ / ▶▶** button repeatedly during playback pause.
Press and hold to play back continuous frame advance.

Frame Reverse

To play back in reverse frame by frame, press the **- / ◀◀** button repeatedly during playback pause.
Press and hold to play back continuous frame reverse.

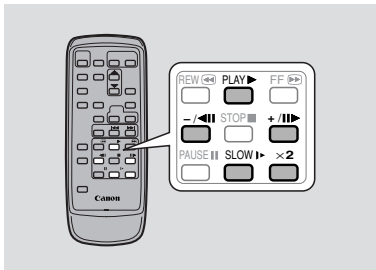

Slow Forward Playback

To play back at about 1/3 normal speed, press the **SLOW ▶** button during normal playback.
Press the **PLAY ▶** button to return to normal playback.

Slow Reverse Playback

To play back in reverse at about 1/3 normal speed, press the **- / ◀◀** button and then the **SLOW ▶** button during normal playback.
Press the **PLAY ▶** button to return to normal playback.

Reverse Playback

To play back in reverse at normal speed, press the $-/\lll$ button during normal forward playback.

Press the PLAY ► button to return to normal forward playback.

- The camcorder automatically goes into stop mode after about 2 minutes of paused reverse playback.

Forward ×2 Playback

Press the ×2 button during normal playback.

Press the PLAY ► button to return to normal playback.

Reverse ×2 Playback

Press the $-/\lll$ button and then the ×2 button during normal playback.

Press the PLAY ► button to return to normal playback.

**Notes:**

- Mosaic-like noise appears on the screen during some of the special playback modes.
- There's no audio during special playback.

Built-in speaker



The camcorder has a built-in speaker so you can review the sound track alongside the picture when you're using the LCD screen to play back a tape. The built-in speaker is monaural.

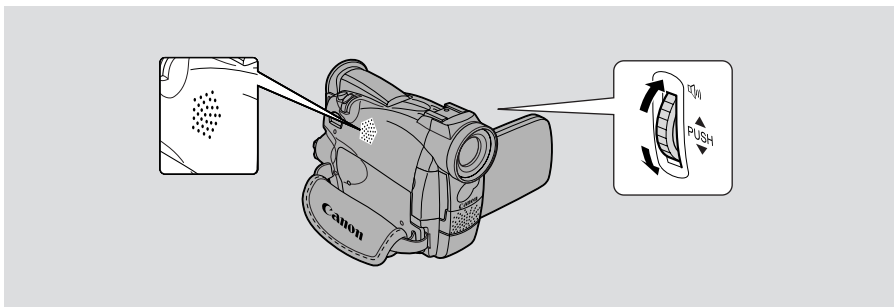

Adjust the speaker volume by turning the selector dial.

- Turn the selector dial up to increase the volume, and down to lower the volume.
- A bar appears in the display to indicate the current volume. It disappears in 4 seconds.
- You can turn off the volume completely by turning the selector dial down until OFF appears.



Notes:

- Sometimes audio may sound distorted when the volume is turned up high. If this happens, turn down the volume.
- The speaker turns off when the camcorder is set to any mode other than PLAY (VCR) mode.

Using the headphones

- You can also use the headphones to monitor the sound track. Change the setting of the AV/headphones terminal through the menu (32).
- You can adjust the headphone volume separately from the built-in speaker, either during PLAY (VCR) mode or CAMERA mode. The volume level is the same regardless of mode.
- The levels you adjust for the built-in speaker and headphones are memorized separately. The camcorder remembers your levels even if you turn the camcorder off and back on again.
- The speaker turns off when you use headphones.

Connections for Playback on a TV Screen

E

You can connect the camcorder to a TV or VCR in order to play back your recordings. You will need to attach a power source to the camcorder (11). Power off all devices before starting the connections.

See your TV or VCR instruction manual for further details.

Switching the AV/headphone terminal

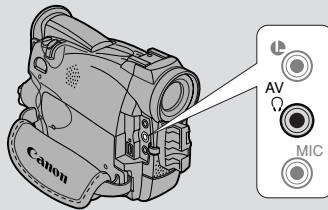

Through the menu, the camcorder's AV/headphone terminal can be switched to function as either the AV terminal or the headphone terminal.

CAMERA

**PLAY
(VCR)**

MENU
(39)

▶ VCR SET UP

▶ AV / PHONES . . . AV

Open the menu and select VCR SET UP. Then select AV/PHONES and set it to AV or PHONES and close the menu.

- When the terminal is switched to PHONES, PHONES appears in the display.

Using the headphones

- Make sure you switch the AV/headphones terminal to PHONES before using headphones. If the AV/headphones terminal is not switched to PHONES before you use the headphones, noise will come out from the headphones.

If your TV (or VCR) has a SCART terminal (without S (S1)-video)

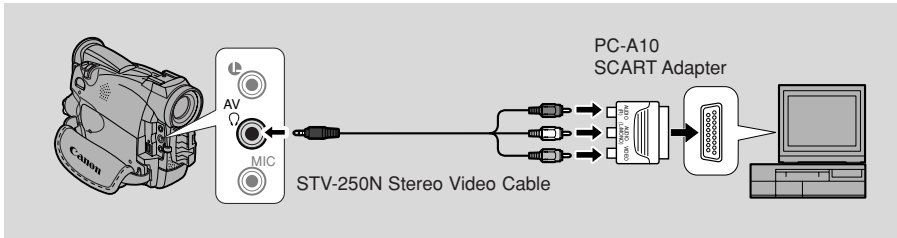

- Connect the PC-A10 SCART adapter to the TV or VCR's SCART terminal.
- Connect the camcorder to the adapter. Connect the camcorder using the STV-250N Stereo Video Cable. Connect the white plug to the white audio terminal **L** (left). Connect the red plug to the red audio terminal **R** (right). Connect the yellow plug to the yellow video terminal **VIDEO**.
- If you are connecting the camcorder to a TV, set the TV/VIDEO selector on the television to VIDEO.
- If you are connecting the camcorder to a VCR, set the input selector on the VCR to LINE.

If your TV (or VCR) has an S (S1) -video input terminal

For higher picture quality, we recommend playing back recordings on a TV with an S (S1) terminal.

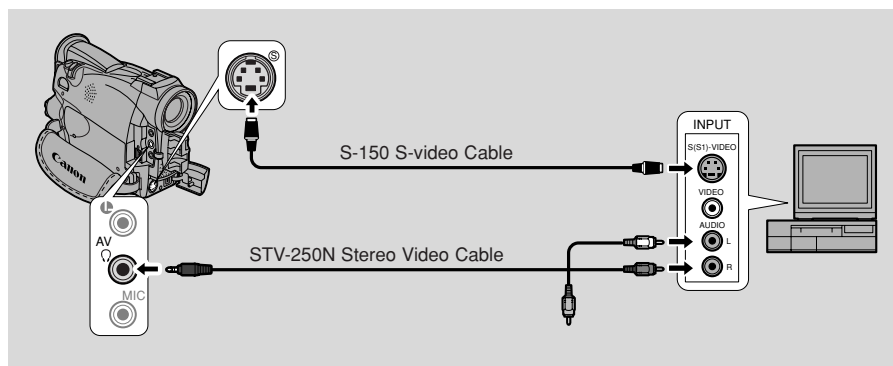

- Use the optional S-150 S-video Cable to connect the S-video terminals. Use the STV-250N Stereo Video Cable to connect the AUDIO terminals. Connect the white plug to the white AUDIO terminal **L** (left). Connect the red plug to the red AUDIO terminal **R** (right). Do not connect the yellow plug.
- If you are connecting the camcorder to a TV, set the TV/VIDEO selector on the television to VIDEO.
- If you are connecting the camcorder to a VCR, set the input selector on the VCR to LINE.

If your TV (or VCR) has audio/video input terminals

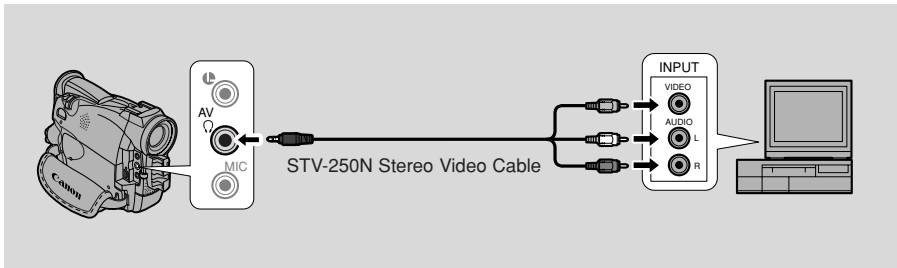

- Connect the camcorder using the STV-250N Stereo Video Cable. Connect the white plug to the white audio terminal **L** (left). Connect the red plug to the red audio terminal **R** (right). Connect the yellow plug to the yellow video terminal **VIDEO**.
- If you are connecting the camcorder to a TV, set the TV/VIDEO selector on the television to VIDEO.
- If you are connecting the camcorder to a VCR, set the input selector on the VCR to LINE.



Note:

- If you are going to use the TV as a monitor while you are shooting, remember to keep the TV volume turned down as long as the camcorder's audio terminals are connected. If the sound from the TV speakers is picked up by the microphone, an unpleasant high-pitched squeal, called feedback, may be produced.

Tips for Making Better Videos

Holding the camcorder

For maximum stability, grip the camcorder in your right hand and keep your right elbow pressed against your body. If necessary support the camcorder with your left hand. With practice, you will be able to operate the controls by touch, without taking your eye off the action.

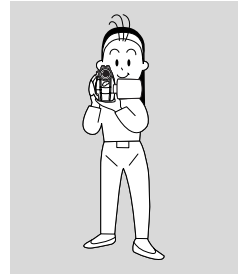

Using a tripod

To prevent any unwanted movement, you can mount the camcorder on a tripod, (or any flat surface at a suitable height) and operate it with the wireless controller.

- When you are using a tripod, be careful not to leave the viewfinder exposed to bright sunlight or it may melt. (The light is concentrated by the viewfinder lens.)
- Make sure that the fastening screw of the tripod is no longer than 5.5 mm (1/4 inch), or it will damage the camcorder.

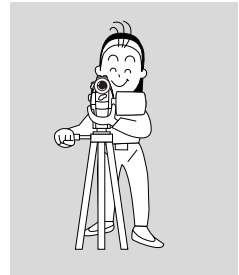

Composition

The most important element in the scene does not have to be in the centre. For a more interesting picture, try to position your subject so it is slightly to one side. Leave some space on the side of the frame that the subject is facing or moving towards.

Don't cut off the top of the subject's head, and don't cut people off at the neck, hips or knees (move a little bit above or below).

Watch out for distracting objects in the background.



Picture angle

Instead of zooming while recording, try to choose your picture angle before you begin. A good way to tell a story with video is to begin with a long shot that establishes the situation, and then move in with medium shots and close-ups to show the details. Remember to change your viewpoint for each shot.



Long shot



Medium shot



Close-up

Remember that any camcorder movement or change in picture angle should have a definite purpose. Avoid unnecessary or half-hearted movements.

Camcorder moves

Use pans to record a landscape or follow a moving subject. Decide the area you want to cover and stand facing the end of your panning angle. Without moving your feet, turn your waist to the starting position. Start recording, and after a few seconds begin to turn slowly from the waist. Hold the final image for a few seconds before you stop recording.

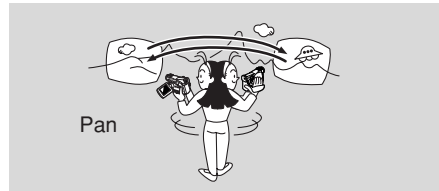

Pan

Tilt the camcorder up to exaggerate the height of the subject. Tilt down from the top of a building, for example, as an introduction to subjects at the bottom.



Tilt

Searching and Reviewing While Recording

E

Record search



When the camcorder is in record pause mode, you can use record search to play the tape forwards or backwards to find the point where you want to start or resume recording. This is useful when you want to add a new scene to a previously used cassette. By using record search, you can ensure a smooth, noise-free join between the new scene and the old one.

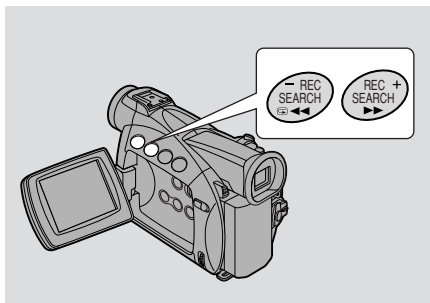

CAMERA

1. **Press and hold the REC SEARCH + or – button on the camcorder while you check the picture in the display.**
 - The + button plays the recording forwards and the – button plays it backwards.
2. **Release the button when you find the point where you want to start recording.**
 - The camcorder returns to record pause mode.

Record review



When the camcorder is in record pause mode, you can use record review to play back the last few seconds of your recording and then return automatically to record pause mode. You can quickly make sure that a scene has recorded properly and then go on to shoot the next scene, without producing any noise in the picture.

CAMERA

1. **Press and release the  (record review) button while you check the picture in the display.**
 - The camcorder rewinds the tape, plays back the last few seconds, and returns to record pause mode.



Note:

- Noise may appear on the screen when you play the tape backwards.

Using the Menus



E

Many of the camcorder's advanced functions are selected from menus which appear in the display.

There are 2 main menus:

CAM. MENU Camera menu (40)

PLAY MENU (MV500i :VCR MENU) (42)

● CAM. MENU CAMERA

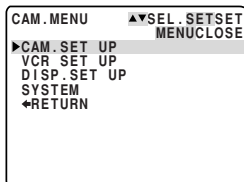

● PLAY MENU (MV500i :VCR MENU) PLAY (VCR)

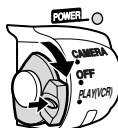
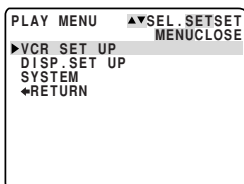

Using the Full
Range of Features

Selecting from the Menus

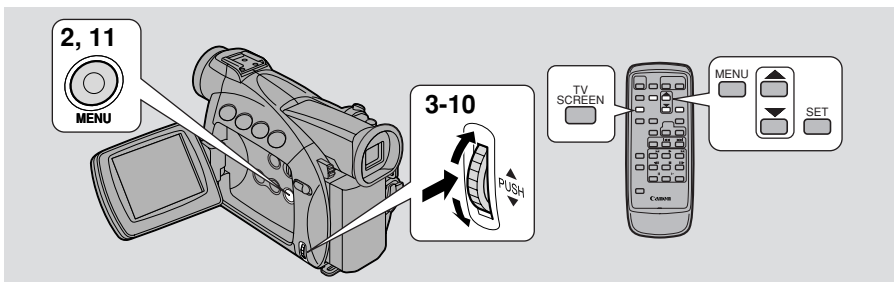

1. Turn the **POWER** switch to the desired setting.
2. Press the **MENU** button to open the menu.
3. Turn the selector dial and move the arrow to the desired submenu.
4. Press the selector dial in to select.
 - The submenu appears.
5. Turn the selector dial and move the arrow to the desired function.

6. **Press the selector dial in to select.**
 - The function and its settings only appear.
7. **Turn the selector dial and move the arrow to the desired setting.**
 - If you are setting a function other than the white balance or shutter speed, the function will be set if you skip to step 11.
8. **Press the selector dial in to select.**
 - The function is set and you return to the submenu.
9. **Turn the selector dial and move the arrow to ← RETURN.**
10. **Press the selector dial in to select.**
 - You return to the main menu.
11. **Press the MENU button.**
 - The main menu disappears.



Notes:

- Pressing the MENU button at any time closes the menu.
- Selecting ← RETURN takes you back one menu, or closes the main menu.
- Items that are unavailable, due to the settings of other menu items, appear in purple.
- You may often find it convenient to use the wireless controller to move around the menus. Press its MENU button to open/close the menu and use the arrow keys in place of turning the selector dial. Push the SET button to select.
- Pressing the start/stop button or the PHOTO button will close the menu and start recording.
- You can display the menus on a connected TV screen by turning TV SCREEN (📖 111) on through the menu or using the wireless controller's TV SCREEN button. See p. 32 for TV hookup instructions.

List of Menus



Turn to appropriate page for a detailed explanation of each function.

● CAM. MENU

Set the POWER switch to **CAMERA**. There are 4 submenus.

- ① To camera set up submenu
- ② To VCR set up submenu
- ③ To display set up submenu
- ④ To system submenu
- ⑤ Close main menu

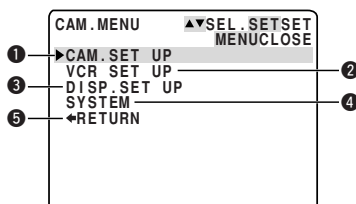

1 Camera set up submenu

- ① Shutter speed..... 66
- ② Digital zoom 23
- ③ Image stabilizer..... 51
- ④ 16:9 effect 21
- ⑤ White balance 69
- ⑥ Return

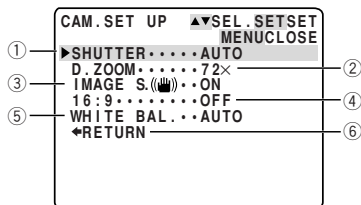

2 VCR set up submenu

- ⑦ Record mode..... 20
- ⑧ Wind screen 62
- ⑨ Audio mode 61
- ⑩ AV or headphones..... 32
- ⑪ Return

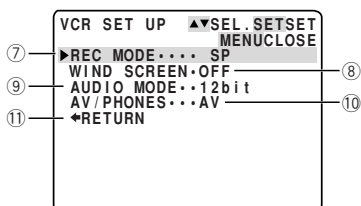

3 Display set up submenu

- ⑫ Brightness 26
- ⑬ Mirror mode..... 27
- ⑭ TV screen..... 111
- ⑮ Date/time display 48
- ⑯ Demo mode..... 22
- ⑰ Return

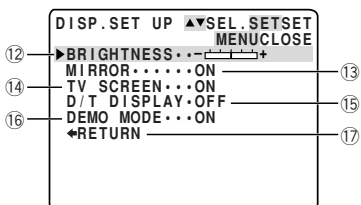

4 System submenu

- ⑱ Wireless controller..... 44
- ⑲ Beep 21
- ⑳ Time zone/
Daylight saving time..... 46
- ㉑ Date/time set..... 48
- ㉒ Return

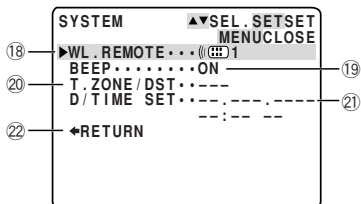

● PLAY MENU (MV500i :VCR MENU)

Set the POWER switch to **PLAY (VCR)**. There are 3 submenus.

- ① To VCR set up submenu
- ② To display set up submenu
- ③ To system submenu
- ④ Close main menu

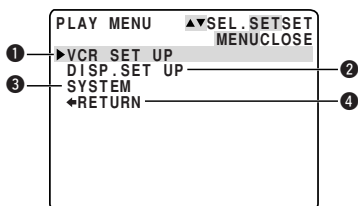

① VCR set up submenu

- ① Record mode* 20
- ② Output channel..... 94
- ③ Audio dubbing* 91
- ④ Wind screen 62
- ⑤ Audio mode 61
- ⑥ AV or headphones..... 32
- ⑦ Analog-digital converter*..... 83
- ⑧ Return

* MV500i only

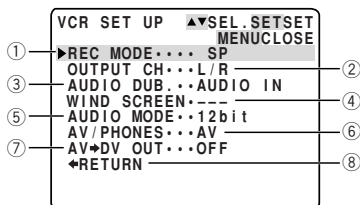

② Display set up submenu

- ⑨ Brightness 26
- ⑩ Displays..... 111
- ⑪ 6-second auto date 73
- ⑫ Data code 72
- ⑬ Date/time select 71
- ⑭ Return

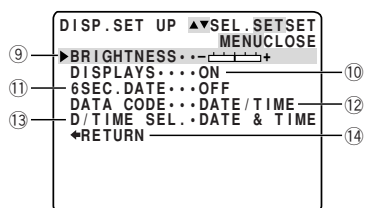

③ System submenu



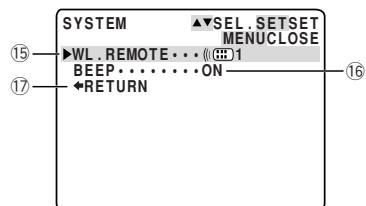





- ⑮ Wireless controller..... 44
- ⑯ Beep 21
- ⑰ Return



Using the Wireless Controller

The supplied wireless controller can operate the camcorder from a distance of up to 5 m (16 feet). Point it at the camcorder's remote sensor while you press the buttons.

There are some functions that cannot be operated without the wireless controller:

- Special playback ( 29)
 - Photo/date search ( 74)
 - Zero set memory ( 75)
 - Audio mix ( 93)
 - Dubbing from a digital video equipment* ( 78)
 - Analog line-in* ( 81)
 - AV insert* ( 85)
 - Audio dubbing ( 88)
- * MV500i only

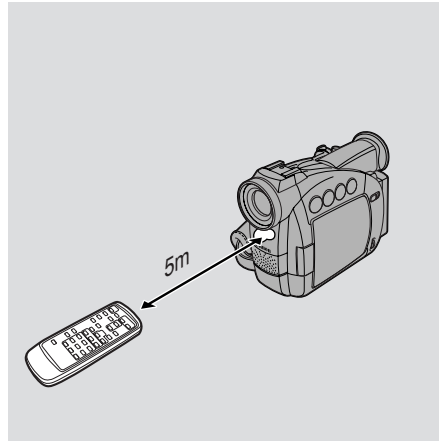

Inserting batteries

Insert two AA batteries, following the \oplus and \ominus markings. Be careful not to reverse the polarity of the batteries.

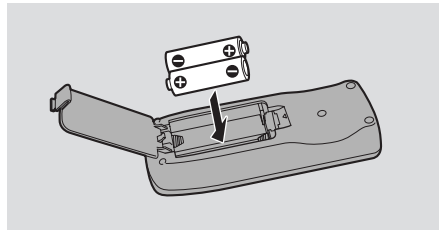

Notes:

- When using the wireless controller in brightly lit places or outdoors, the effective range will be less.
- The camcorder may have difficulty picking up the remote control signals at extremely close range.
- Do not leave the controller exposed to direct sunlight, or in hot or humid places.
- When the batteries run out, replace them both together.
- If the wireless controller doesn't work, see p. 45.

When Operating 2 Canon DV Camcorders (Remote Sensor Mode)



To prevent interference from other Canon wireless controllers being used nearby, there are 2 remote sensor modes and an off setting. The wireless controller and the camcorder have to be set to the same mode in order to be compatible.

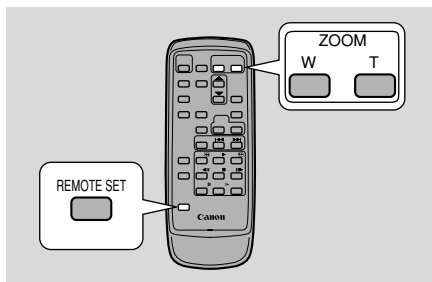

The wireless controller and the camcorder have been preset to mode 1. If you change the mode on the camcorder, be sure to change the mode on the wireless controller to the same mode.

CAMERA

PLAY (VCR)

MENU
(39)

▶ SYSTEM

▶ WL.REMOTE... 1

(()) 1 : Mode 1

(()) 2 : Mode 2

OFF (()) : Sensor off

To turn the remote sensor off:

Open the menu and select SYSTEM. Then select WL.REMOTE, set it to OFF (()) and close the menu.

- (()) appears in the display.

To change the mode...

...on the camcorder:

Open the menu and select SYSTEM. Then select WL.REMOTE, set it to (()) 1 or (()) 2 and close the menu.

- The selected mode will appear on the display for 4 seconds.

...on the wireless controller:

Press and hold the REMOTE SET button on the wireless controller.

Simultaneously press the ZOOM W button for mode 1 or the ZOOM T button for mode 2. Continue to press simultaneously for over 2 seconds.

- Be sure to set the wireless controller to the same mode as the camcorder.

If your wireless controller isn't working:

Make sure the camcorder and the wireless controller are both set to the same mode. Check the mode the camcorder is set to by pushing any button other than the REMOTE SET button on the wireless controller. The camcorder's mode appears in purple for about 4 seconds. Set the wireless controller's mode accordingly by pressing the aforementioned button combinations. If the wireless controller still doesn't work, change the batteries.



Notes:

- The mode the camcorder is set to also appears for 4 seconds when you turn the power on.
- When you replace the batteries, the wireless controller returns to mode 1. Change the mode again if necessary.

Setting the Date and Time

E

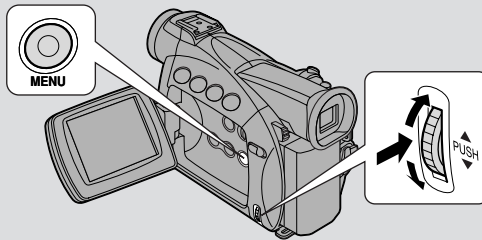

The date and/or time display forms part of the data code. You can choose to display or hide it during playback (71).

Set the date and time display when you first start using your camcorder. Install the backup battery before you begin (100).

- Before you start setting the date and time, select your home time zone from the menu.

Setting the time zone/daylight saving time



CAMERA

MENU
(39)

▶ SYSTEM

▶▶ T.ZONE / DST • PARIS

1. **Open the menu and select SYSTEM.**
2. **Select T.ZONE/DST.**
 - The time zone display appears on the screen.
 - Your camcorder's time zone is factory-preset to Paris. If you are at another time zone, select your time zone first and daylight saving time (DST) setting if necessary.
3. **Move up or down the list of time zones with the selector dial. Select the option that represents your time zone.**
 - If you are now in daylight saving time, select the time zone with the daylight saving time mark next to the area.
4. **Close the menu.**

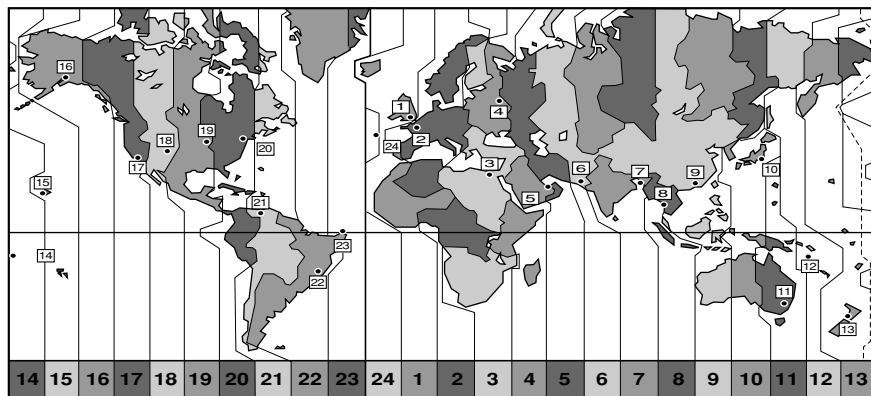

No.	Time zone	No.	Time zone
1	LONDON	13	WELLGTON (Wellington)
2	PARIS	14	SAMOA
3	CAIRO	15	HONOLU. (Honolulu)
4	MOSCOW	16	ANCHOR. (Anchorage)
5	DUBAI	17	L.A. (Los Angeles)
6	KARACHI	18	DENVER
7	DACCA	19	CHICAGO
8	BANGKOK	20	N.Y. (New York)
9	H. KONG (Hong Kong)	21	CARACAS
10	TOKYO	22	RIO (Rio de Janeiro)
11	SYDNEY	23	FERNAN. (Fernando de Noronha)
12	SOLOMON	24	AZORES

Notes:

- After you have selected your time zone and set the date and time, when you travel to another time zone, there is no need to reset the date and time. Just set the time zone to your destination and the camcorder's clock will automatically change to display the correct time for your destination.
- The camcorder automatically accounts for the number of days in a month and leap year.

Setting the clock



After you set the date and time, the date/time and home time zone will be displayed for about 4 seconds each time you turn the power on.

CAMERA

MENU

(39)

▶ SYSTEM



▶ D/TIME SET.. 1.JAN.2002
12:00 AM

1. Open the menu and select **SYSTEM**.
2. Select **D/TIME SET**.
 - The year display starts to flash.
3. Turn the selector dial up and down to change the year. Press the dial in to move to another part of the display.
 - Once you move from the year, the next part of the display starts flashing.
4. Set the month, day, hours, and minutes in the same way.
5. Press the **MENU** button when finished, and to start the clock.



Notes:

- To make a change to part of the date and time, press the selector dial in at step 3 to move to the part to be changed. Turn the dial to make the change, then close the menu.
- The date can be set to any year between 2002 and 2030.
- If you press the **MENU** button in the middle of setting the date and time, you leave the menu, and the clock starts.
- If you press the selector dial in after setting the minutes you can set the date and time again from the start.

Date and time display



You can choose to display or hide the date and time display during recording. When the date and time display is set to ON, the date and time show in the lower left-hand corner of the display but the time zone disappears in about 4 seconds. The large, 4-second display will no longer appear when you turn on the power. It is not automatically superimposed on your recordings.

CAMERA

MENU

(39)

▶ DISP.SET UP



▶ D/T DISPLAY OFF

To turn it on, open the menu and select **DISP.SET UP**. Then select **D/T DISPLAY**, set it to **ON** and close the menu.

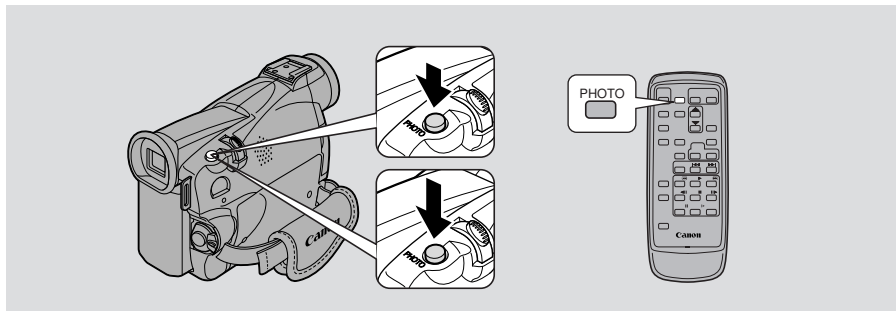

You can record still pictures like a photograph. The camcorder records the picture and sound to tape for several seconds. The exposure is automatically adjusted. Also, starting your shooting with a still photo makes it easy to find the beginning again later with the Photo Search function ([□ 74](#)).

You can take a still picture at any time during regular video recording, or you can put the camcorder into record pause mode first, then take a still picture.

CAMERA

During record mode

Press the PHOTO button fully down and the still picture will be taken immediately.

- The camcorder takes the image immediately, and then records the “photo” to the tape for approximately 6 seconds. During this time the camcorder also records the sound, and the display shows the still picture.
- A counter display appears, and counts up as the camcorder records the picture.
- The camcorder returns to record pause mode.

During record pause mode

1. Press the PHOTO button halfway down and hold it:

- “PHOTO” flashes at the bottom right of display.
- Exposure is locked.
- During autofocus ● flashes white in the display as the camcorder adjusts the focus and it is displayed continuously as a green mark when the camcorder is ready to take the still picture.
- If the subject is unsuitable for autofocus ([□ 106](#)), the camcorder may not be able to focus, and ● may continue to flash white in the display. Continue to hold the PHOTO button halfway down, then adjust the focus manually with the selector dial.
- If you are using manual focus ([□ 68](#)), the ● mark starts as a continuous green mark. Focus with the selector dial.

2. Press the PHOTO button fully down to take the still picture.

- The camcorder takes the image immediately, and then records the “photo” to the tape for approximately 6 seconds. During this time the camcorder also records the sound, and the display shows the still picture.
- A counter display appears, and counts up as the camcorder records the picture. ● disappears from the display.
- The camcorder returns to record pause mode.



Notes:

- The camcorder automatically returns to record pause mode after recording a still image for approximately 6 seconds. If you turn the POWER switch to OFF during that time, the camcorder will respond only after recording is complete.
- The wireless controller’s PHOTO button has no half-way setting. Press the button fully and the camcorder immediately takes the “photo”.
- Only take “photos” where it is bright enough to see the image in the display.

Turning the Image Stabilizer Off



E

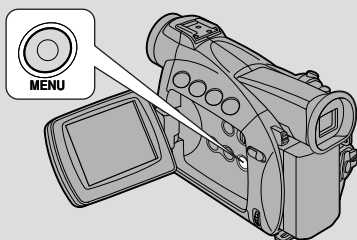

With most camcorders, even the slightest hand movements will be noticeable during telephoto recording. However, the MV500/MV500i's image stabilizer allows you to obtain steady recordings even at high magnification.

CAMERA

MENU

(39)

▶CAM.SET UP

▶IMAGE S. () · · ON

To turn the image stabilizer off, open the menu and select CAM.SET UP. Then select IMAGE S. (), set it to OFF and close the menu.

- The () mark disappears from the display when the stabilizer is off.
- The image stabilizer cannot be turned off when the program selector is set to the (Easy Recording) position.

Notes:

- Keep the image stabilizer turned off when the camcorder is mounted on a tripod.
- The image stabilizer is designed to deal with a normal degree of camcorder shake.
- The image stabilizer is not as effective as usual during the Low Light and Night mode.

Using the Various Recording Programs

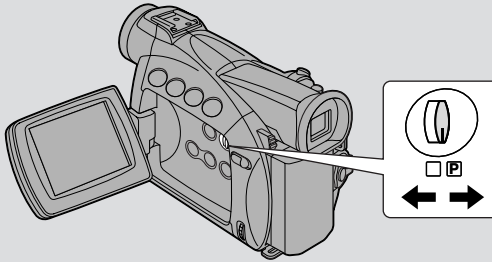

The camcorder provides you with a choice of 8 recording programs. They use different combinations of camcorder settings in order to adjust the exposure and other functions to match the recording situation.

- For simple point-and-shoot operation, select the Easy Recording program. Slide the program selector to the position.
- For normal shooting conditions, slide the program selector to P (program AE) mode. Open the program menu and select AUTO (53).
- For various other recording conditions, the camcorder has 6 more specialised AE (auto exposure) programs.

Availability of functions in each recording program

Position of program selector	<input type="checkbox"/> P	<input type="checkbox"/> P						
Recording Program	<input type="checkbox"/> (Easy Recording)	Auto	Sports	Portrait	Spotlight	Sand & Snow	Low Light	Night
Digital Zoom	○	○					×	
Shutter speed	A	○	A					
Focus		○						
White balance		○						
AE shift		○	×		○	×		
Image stabilizer (ON/OFF)	ON	○						
Digital effects	×	○						
16:9	×	○						

○ : Available × : Not available A : Automatic function only

Setting the program AE mode



CAMERA

E

1. Slide the program selector to **P** (program AE) mode.
2. Press the selector dial in to display the program menu.
3. Turn the selector dial to move the arrow up or down the display.
4. Press the selector dial in to select the desired program.
 - The program will appear in the display.



Notes:

- The name of your selected recording program appears constantly on the left of the display, with the exception of Auto, which is displayed and then disappears after 4 seconds.
- Avoid changing programs during recording as the brightness of the image may change suddenly.
- If you switch the camcorder from the **□** program to the **P** program, the camcorder returns to the Auto mode.
- When recording in dark places a bright light in the scene may cause a vertical light bar (“smear”) to appear. This is a normal feature of camcorders.



Easy Recording

The simplest way to use the camcorder is with the program selector set to the  position. The camcorder will take care of focus, exposure and other adjustments, leaving you free to point and shoot.



Auto

This is the same as the Easy Recording program, except that you now have the option of using any of the camcorder's manual functions.



Sports

This program is useful for recording high-speed sports scenes in brightly lit conditions. Normal playback will be slightly jerky, but you will get clear images which can be analysed frame by frame during slow or paused playback.



Portrait

Use this program outdoors to make subjects stand out from a softened foreground and background. It works well for still-lives and close-ups. The effect is most noticeable when the zoom position is between the middle range and the telephoto end. Focus manually for maximum accuracy, and be careful when recording action scenes, as this program may cause fast moving objects to shudder.

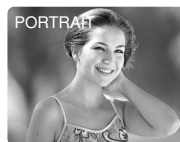

Spotlight

This program is designed for recording spotlight scenes, such as on a stage. The exposure is automatically adjusted for glare-free recordings of subjects lit by a concentrated light source.

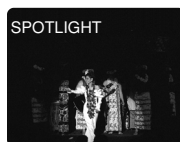

Sand & Snow

Use this program in places where the background is so bright that the subject appears underexposed in the display — a sunny beach or ski resort, for example. You may notice some shudder when recording moving subjects.



Low Light

This program allows you to record in dimly lit places. The shutter speed is fixed at a slow speed. It is generally best used for close-ups of slow or stationary subjects, as moving subjects may leave a trailing after-image. However, you can take advantage of this to create special effects, by rapid zooming or by panning along with a moving subject. Picture quality will not be as good as in normal lighting conditions, and autofocus may not work as well as usual.



Night

This program automatically adjusts the shutter speed according to the brightness of the subject even in dark places (night time, etc.) to shoot subjects brightly in colour. It is useful for shooting subjects in dark places where lighting cannot be used and for shooting night scenes. When you record in very dark places:



- Moving subjects may leave a trailing after-image.
- Though subjects can be shot brightly, picture quality may not be as good as in normal lighting.
- White points may appear in the display.
- Autofocus may not work as well as usual (in this case, adjust the focus manually).



Using Digital Effects

Use the camcorder's digital effects for more interesting productions.

E

- **Faders:** Start or end scenes on a tape with a fade to or from black ( 57). Fade Trigger, Vertical Wipe, Horizontal Wipe, Mosaic Fade*
- **Effects:** Add flavour to your recordings ( 58). Art, Black and White, Sepia, Mosaic

* Available in PLAY (VCR) mode only.

Availability of digital effects in CAMERA mode

Recording Program	<input type="checkbox"/> (Easy Recording)		<input checked="" type="checkbox"/> (Program AE)	
	MOVIE	PHOTO	MOVIE	PHOTO
Faders	×		○	×
Effects	×		○	

○ : Available × : Not available

Availability of digital effects in PLAY (VCR) playback modes

	Playback	Reverse Playback	Still picture playback	Slow forward/reverse playback	Forward/reverse ×2 playback
Faders	○ (Press PAUSE to fade out)	Set only	○ (Press PLAY or PAUSE to fade in)	Set only	
Effects	○				

○ : Available

Notes:

- When you do not want to use digital effects, press the DIGITAL EFFECTS button and select D.EFFECT  from the digital effects menu. Press the DIGITAL EFFECTS button to close the menu.
- The camcorder remembers your chosen digital effect setting until you change it.
- Digital effects can be selected but not operated on a blank blue screen (appears in PLAY (VCR) mode). The display continues to flash.
- Digital effects operated during PLAY (VCR) mode are not recorded onto the original tape.
- Digital effects can be added to another tape when dubbing using the AV out terminal (PLAY (VCR) mode), but not the DV out terminal.
- You cannot operate digital effects while photo/date searching.
- If you slide the program selector to (Easy Recording) while the digital effect display is flashing, it will disappear from the display and reappear when you return to (program AE) mode.
- The digital effect display will flash for 2 seconds after setting, even if DISPLAYS is set to OFF in the menu.

Faders

Fade Trigger (FADE-T)

When you start recording, the scene gradually fades in from a black screen.

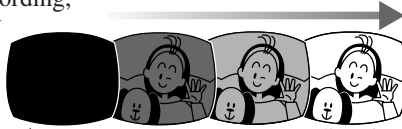

When you stop recording, it gradually fades out.

Wipe (WIPE II)

When you start recording, the picture begins as a thin vertical line in the center of the screen which gradually expands sideways until it fills the whole of the screen.

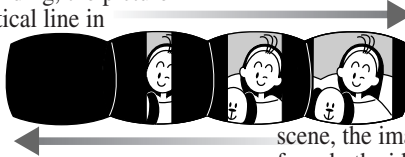

When you end a scene, the image is wiped from both sides of the screen.

Horizontal Wipe (WIPE =)

When you start recording, the picture begins as a thin horizontal line in the centre of the screen which gradually expands upwards and downwards until it fills the whole screen.

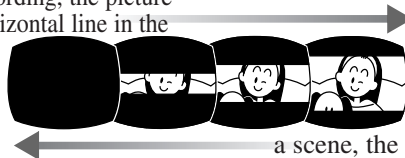

When you end a scene, the image is wiped from the top and bottom of screen.

Mosaic Fade (M. FADE)*

Blurs the image by enlarging the size of some pixels. The image appears as increasingly large squares of colour as it fades out, and smaller squares when it fades in.

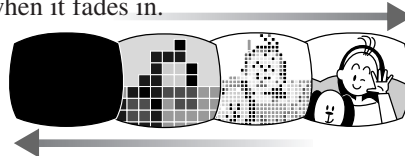

*Available during PLAY (VCR) mode only.

Effects



Sepia (SEPIA)
 Makes a monochrome image with a brownish tint.

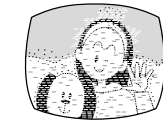

Art (ART)
 Adds a paint-like effect, called solarization, to the image.



Black and White (BLK & WHT)
 Makes the image black and white.

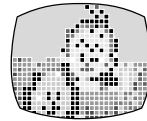

Mosaic (MOSAIC)
 Blurs the image by enlarging the size of some pixels.

Digital effects can be set with the controls on the body of the camcorder or the wireless controller. Pressing the ▲/▼ buttons on the wireless controller correspond to turning the selector dial up and down, and pressing the SET button corresponds to pressing the selector dial in.

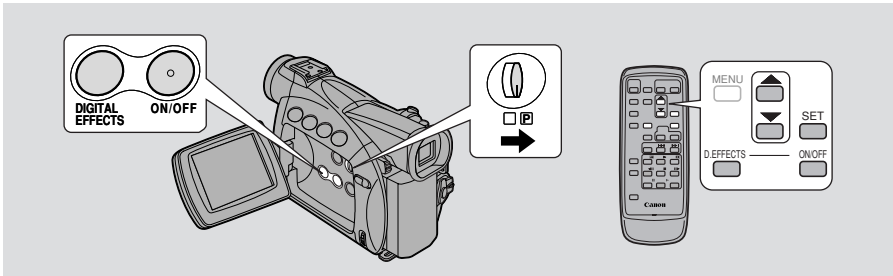

Operating faders





Sound and image fade together.

When operating faders in CAMERA mode, make sure the program selector is set to .

CAMERA , **PLAY (VCR)**

Select fader

1. Press the **DIGITAL EFFECTS** button to open the digital effects menu.
 - D.EFFECT **OFF**, FADER and EFFECT appear.
2. Select **FADER**.
 - FADE-T, WIPE , WIPE  settings appear. M.FADE also appears in PLAY (VCR) mode.
3. Select the desired setting.
 - You return to the digital effects menu.
4. Press the **DIGITAL EFFECTS** button to close the menu.
 - The name of your selected fader flashes in the display.

Fader on/off

5. Press the **ON/OFF** button.
 - The name of your selection stops flashing.
 - Each time you press the ON/OFF button, the chosen fader is activated (display lights continuously) or deactivated (display flashes).

6. If you're in CAMERA mode:

Fade in- Press the start/stop button.

Fade out- Press the start/stop button.

If you're in PLAY (VCR) mode:

Fade in- Press the ► (play) button.

Fade out- Press the || (pause) button.

Operating effects



Sound records/plays back normally.

When operating effects in CAMERA mode, make sure the program selector is set to .

CAMERA

PLAY
(VCR)

Select effect

1. Press the **DIGITAL EFFECTS** button to open the digital effects menu.

- D.EFFECT , FADER and EFFECT appear.

2. Select **EFFECT**.

- ART, BLK&WHT, SEPIA, MOSAIC settings appear.

3. Select the desired setting.

- You return to the digital effects menu.

4. Press the **DIGITAL EFFECTS** button to close the menu.

- The menu disappears and the name of your selected setting flashes in the display.

Effect on/off

5. If you're in **PLAY (VCR)** mode, press the ► (play) button.

6. Press the **ON/OFF** button.

- The name of your selection stops flashing and takes effect on the display.
- Each time you press the ON/OFF button, the chosen effect is activated or deactivated.

Notes:

- When using an external microphone, use a microphone cable not longer than 3 meters to avoid electromagnetic interference.
- Be careful when using long microphones as they may extend into the frame.

Wind screen



The camcorder has an automatic wind screen to prevent wind noise from interfering with the sound track. Make sure it's off when you want the microphone to be as sensitive as possible. Use the wind screen when recording in windy places such as the beach or near buildings.

CAMERA

PLAY
(VCR)

MENU

(39)

▶VCR SET UP

▶▶WIND SCREEN··OFF

To turn it on, open the menu and select VCR SET UP. Then select WIND SCREEN, set it to ON and close the menu.

- WS **ON** is shown in the display when you turn the wind screen on.

Notes:

- The wind screen can be used for audio dubbing with the built-in microphone in PLAY (VCR) mode as well as recording (when AUDIO DUB. is set to MIC. IN in VCR SET UP submenu).
- The wind screen does not operate when an external microphone is connected to the MIC terminal.

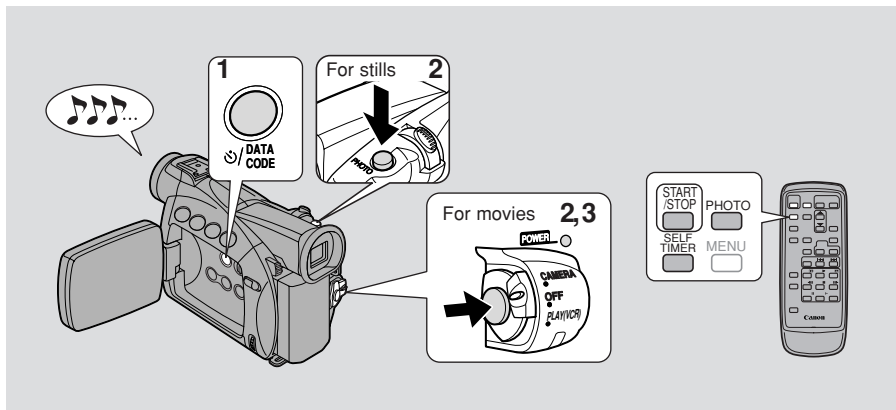

This is useful when you want to include yourself in the picture when recording movies or still photographs.

CAMERA

1. Press the self-timer button on the body of the camcorder

or

the **SELF TIMER** button on the wireless controller.

- SELF-T appears in the display.
- To have the subject monitor recording, rotate the LCD panel 180° ( 27).

For movies



2. Press the start/stop button.

- The camcorder starts to record after a 10-second countdown period (or after 2 seconds when you use the wireless controller). The time remaining counts down in the display (e.g. “5 SEC”).
- SELF-T disappears from the display when recording begins.

3. Press the start/stop button to end recording.



For stills

2. Press a **PHOTO** button on the camcorder body or the wireless controller.

- The camcorder automatically adjusts the focus 2 seconds before the countdown is complete. The  mark flashes white then turns green after the focus and exposure are set. If you are using the wireless controller, the  mark starts flashing immediately after you press the PHOTO button.

- The camcorder takes the picture for approximately 6 seconds.
- If you're in CAMERA mode, the camcorder returns to record pause mode after recording.

**Notes:**

- To cancel the self-timer before the countdown has begun, press the  SELF TIMER button.
- To cancel the self-timer once the countdown has begun, press the  SELF TIMER button.

Adjusting AE Shift



E

By controlling the level of the automatic exposure (AE) function, you can lighten or darken the image slightly. This allows you to compensate for backlit, overexposed scenes.

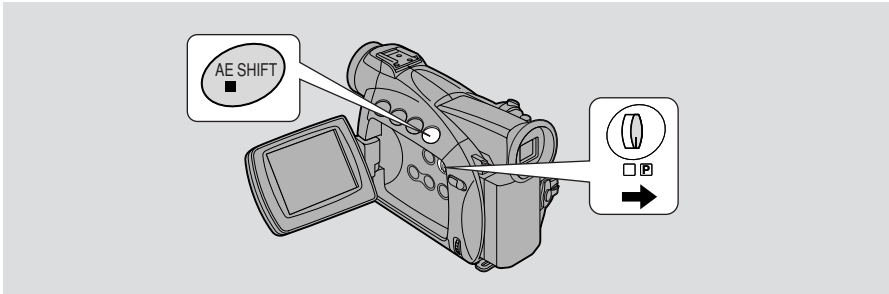

CAMERA

Make sure the program selector is set to **P**.

- 1. Press the selector dial in and select any recording program other than Spotlight, Sand & Snow or Night from the program menu.**
- 2. Press the AE SHIFT button.**
 - ▶ AE appears light blue.
- 3. Turn the selector dial to choose your desired level.**
 - Levels are from -2 to +2, in 0.25 intervals (excluding -1.75 and +1.75).
 - The higher the setting, the brighter the image.



Notes:

- You cannot adjust the exposure without the ▶ mark before AE in the display. Push the AE SHIFT button so that ▶ appears before AE. Then you can adjust the exposure manually.
- You cannot adjust the AE Shift when the camcorder is set to **□** (Easy Recording), the Spotlight, the Sand & Snow or Night recording program.

Setting the Shutter Speed



E

Set the shutter speed manually to take stable shots of quickly moving subjects.

CAMERA

MENU
(39)

▶CAM.SET UP

▶SHUTTER.....AUTO

1. Make sure the camcorder is set to the **P** (program AE) mode.
2. Press the selector dial in and choose **AUTO** from the program menu.
3. Open the menu and select **CAM.SET UP**.
4. Select **SHUTTER**.
5. Press the selector dial in to select the desired shutter speed.

Using the Full
Range of Features

TAPE

AUTO

1/50

1/120

1/250

1/500

1/1000

1/2000

1/4000

1/8000

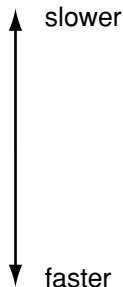

6. Close the menu.

Guidelines for shooting using high shutter speeds

- When shooting with a shutter speed of 1/1000 or higher, do not shoot the sun directly.

Recommended shutter speeds when shooting:

- People doing outdoor sports such as golf or tennis



1/2000 or 1/4000
(or 1/8000 to freeze the action even more clearly)

- Moving cars or trains or other rapidly moving vehicles such as roller coasters



1/1000, 1/500 or 1/250

- People doing indoor sports such as basketball



1/120

Notes:

- You are unable to set the shutter speed in any recording program other than AUTO.
- The image may not appear smooth when a high shutter speed is set.
- The camcorder returns to the auto shutter setting when you slide the program selector to (Easy Recording), or change the recording program.

Adjusting Focus Manually

E

The camcorder can focus automatically. All you have to do is point it, and whatever is in the centre of the display will usually be in sharp focus. If it does not seem to be focusing well, it may be because the subject is not suitable for autofocus.

You can use the manual focusing function for more control over focusing.

Focus lock



CAMERA

Press the FOCUS button to turn off autofocus. The focus remains locked at the point set by autofocus.

(▶M.FOCUS appears in the display.)

You can now adjust the focus manually with the selector dial. Press the FOCUS button again when you want to return to autofocus.

- If you zoom in on your subject after turning off autofocus, it may not stay in focus. It is generally best to adjust the zoom first, and then the focus.

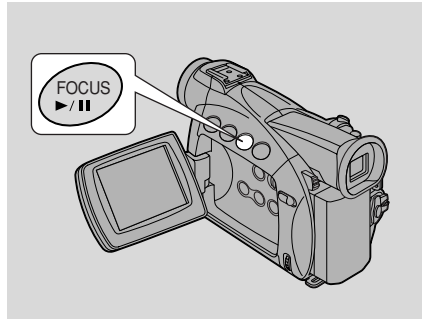

Manual focus



CAMERA

Use the selector dial to set the focus.

- Turn the selector dial downward to move the focus farther away.
- Turn the selector dial upwards to bring the focus nearer.

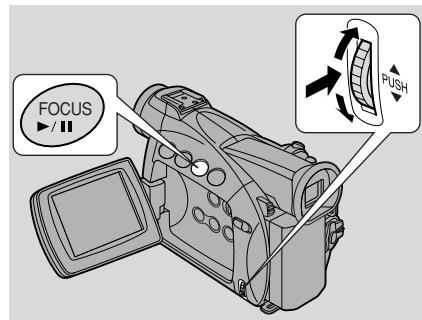

Notes:

- You cannot adjust the focus without the ▶ mark before M.FOCUS in the display. Push the FOCUS button so that ▶ appears before M.FOCUS. Then you can adjust the focus manually.
- The manual focus setting is cancelled if you select the (Easy Recording) program.
- When you are using the (Easy Recording) program, autofocus cannot be turned off.
- See “Troubleshooting” on p. 105 for a list of subjects which may not be suitable

Setting the White Balance



E

The camcorder's auto white balance system compensates for a wide range of lighting conditions. Although slight variations are unavoidable, colours will appear natural in virtually every situation.

In some cases, you will get better results by setting the white balance yourself, or using one of the two preset modes:

- Indoor Mode
 - Under halogen or studio/video lighting
 - Subject is of one dominant colour
 - Close ups
- Outdoor mode
 - In daylight, especially for close-ups and where the subject is of one dominant colour

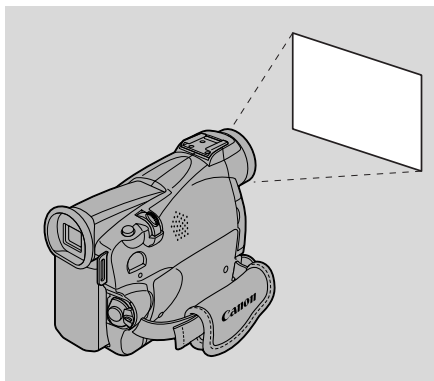

CAMERA

MENU

(39)

▶CAM.SET UP

▶WHITE BAL...AUTO

1. Make sure the camcorder is set to the (program AE) mode.
2. Open the menu and select CAM.SET UP.
3. Select WHITE BAL.
4. a) For the indoor, outdoor or auto settings, press the selector dial in to choose the setting.
 - / appears in the display when you set the white balance to indoor/outdoor mode.
- b) To set the white balance yourself, point the camcorder at a white object (such as a sheet of paper) and zoom in until it fills the display. Then press the selector dial in to select SET .
 - Make sure to continue pointing the camcorder at the white object until you have finished setting the white balance.
 - The display flashes then remains lit.
 - Depending on the light source, the flashing may at times continue. The result will remain better than with the auto setting and you can continue recording.
5. Close the menu.

Using the Full
Range of Features

Setting the white balance manually will probably work better than auto white balance when shooting:

Subjects with one dominant colour, such as sky, sea or forest



Close-ups



In rapidly changing lighting conditions



In places lit by certain types of fluorescent or mercury vapour lights



 **Notes:**

- Turn the digital zoom off (if necessary) to set a more accurate white balance.
- If you have set the white balance and lighting conditions change, reset the white balance.
- Try to record with light from a single source. Correct white balance cannot be obtained for two types of lighting at once.
- You cannot set the white balance or choose the indoor/outdoor mode when the program selector is set to the (Easy Recording) program.
- The white balance returns to the AUTO setting when you slide the program selector to (Easy Recording).
- When you turn the camcorder on, the white balance returns to AUTO. If you then switch the white balance to SET, the camcorder will remember your last setting.
- During normal outdoor shooting, setting to AUTO may provide better results.

Displaying Date, Time and Camcorder Data (Data Code)

E

A data code, containing the date and time the recording was made and other camcorder data (shutter speed and exposure settings) is automatically recorded on a special data section of the tape.

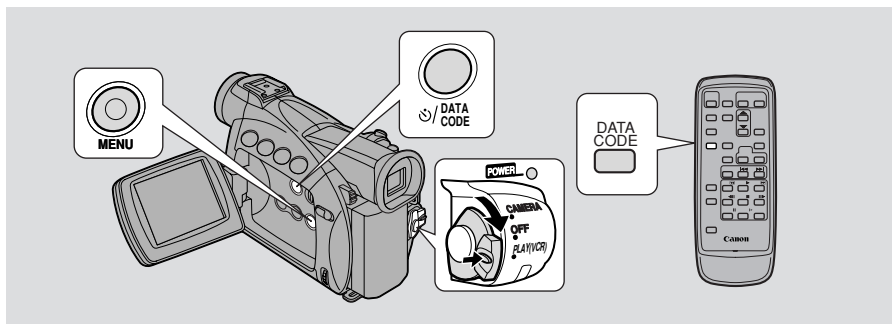

During PLAY (VCR) mode, the data code can be displayed or hidden while the camcorder is in play, slow or still mode.

Camcorder data may be displayed as “-- --” during fast forward, rewind, reverse playback, forward and reverse $\times 2$ playback.

Press the DATA CODE button. When using a cassette, press it while the camcorder is in play, slow or still mode.

- Press it once to display, once more to hide it.

Selecting date/time



Select whether you want the date, the time, or both to show up on your data code display.

**PLAY
(VCR)**

MENU
(39)

▶ DISP.SET UP

▶▶ D/TIME SEL. · DATE & TIME

To change the date and time combination, open the menu and select DISP.SET UP. Then select D/TIME SEL, set it to DATE, TIME or DATE & TIME and close the menu.

Using the Full
Range of Features

Setting the data code



You can also choose to display camcorder data (shutter speed and exposure settings) in cassette data codes.

PLAY
(VCR)

MENU

(39)

▶ DISP. SET UP

▶ DATA CODE...DATE/TIME

To change, open the menu and select **DISP.SET UP**. Then select **DATA CODE**, set it to **DATE/TIME**, **CAMERA DATA** or **CAM. & D/T** and close the menu.

Possible data code combinations:

DATA CODE D/TIME SEL.	Date/Time	Camera data	Date/Time & Camera data
Date	1. JAN. 2002	F11 1/250	F11 1/250 1. JAN. 2002
Time	12:00:00 AM	F11 1/250	F11 1/250 12:00:00 AM
Date & Time	12:00 AM 1. JAN. 2002	F11 1/250	F11 1/250 12:00 AM 1. JAN. 2002



Notes:

- The data code will read “--” in the following situations:
 - During playback of a blank section of tape.
 - If the tape was recorded before entering the date and time in the camcorder’s memory.
 - If the tape was recorded on a camcorder without a data code function.
 - If noise or tape damage prevents the data code from being read.
- If a recording made on MV500/MV500i is played back on a different DV camcorder, the data code may not be displayed correctly.
- The data code will appear in the display even if DISPLAYS (111) has been set to OFF through the menu.

Six-second auto date



The 6-second auto date appears for 6 seconds to mark the changeover of a day if the tape was being recorded at 12:00 midnight. It also appears for 6 seconds when you start playback and have the data code turned off. The 6-second auto date will adjust for any time zone changes you have indicated.



MENU

(39)



To turn the 6-second auto date on, open the menu and select DISP.SET UP. Then select 6SEC. DATE, set it to ON and close the menu.



Note:

- When 6SEC.DATE is turned on but DISPLAYS (111) is turned off, the six-second auto date will still appear for 6 seconds.

Searching the Tape (Photo Search/Date Search)



E

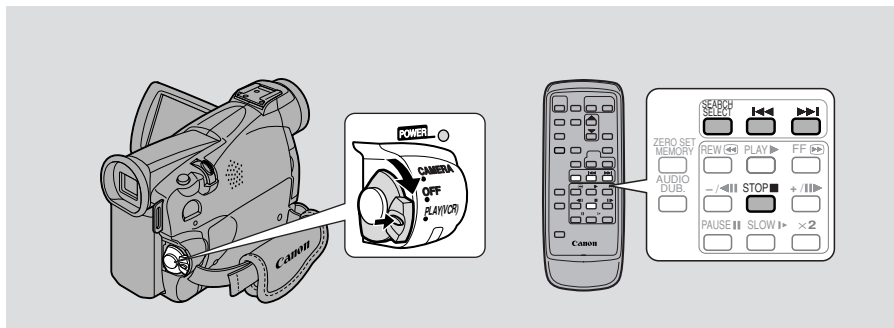

This allows you to move quickly through still pictures recorded anywhere on a tape (photo search) or between different days or areas of recording (date search) on a tape.

**PLAY
(VCR)**

Using the Full
Range of Features

1. Press the **SEARCH SELECT** button to choose between photo/date search.

- PHOTO SEARCH or DATE SEARCH is shown in the display for 4 seconds.

2. Press the **◀◀** and **▶▶** buttons to move backwards or forwards through the still pictures or between different days of recording.

- Press once to move to the start of the previous/next still picture or day on the tape.
- You can press more than once to move to the corresponding still picture or day (up to a maximum of 10 times), e.g. press the **▶▶** button 5 times to move forward 5 still pictures or days.
- PHOTO SEARCH/DATE SEARCH appears in the middle of the display alongside the **◀◀** or **▶▶** mark and number to search through. You can change direction easily by pressing the button for the opposite direction.



Notes:

- Press **■** (stop) to stop mid-search.
- If you begin a search very close to the start of a recorded still picture during photo search, the camcorder may skip straight past it.
- When you have set the area for the World Clock, date search also looks for the change in date based on the adjusted time.
- A date/area cannot be identified if the total recording time on that day/area was less than 1 minute.
- Date search playback may start just before or after the beginning of the located section.
- If the data code is not displayed correctly you will not be able to operate the date search correctly.

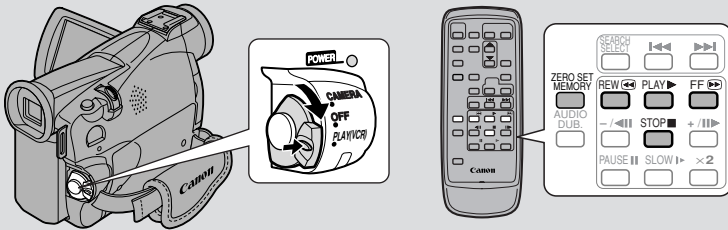

Use the wireless controller to mark a point on a tape that you want to return to following playback.



- 1. Press the ZERO SET MEMORY button on the wireless controller during playback at a point you want to return to later.**
 - The time code is replaced by a tape counter that is set to zero with the **M** indication.
 - Press the ZERO SET MEMORY button once more to cancel the zero set memory.
- 2. When you have finished playback, fast forward or rewind the tape. The tape stops automatically when it reaches the zero set position.**
 - **RTN▶▶** or **◀◀RTN** appears in the display.
 - The tape counter with **M** indication disappears from the display and the time code reappears.

Notes:

- The zero set memory may not function correctly where there is a break between recordings on the tape.
- You can also use zero set memory to mark a position on a tape in CAMERA mode. When you then play back the tape, pressing rewind will take you back to the pre-marked position.
- If you remove the tape while the zero set memory is set, the memory is cancelled and the tape counter reverts to time code.
- The camcorder remembers your setting even if you turn it off and back on again or move the program selector.

Editing to a VCR

E

By connecting the camcorder to a VCR, you can edit your recordings in order to remove unwanted scenes — or combine different shots to create your own video productions.

Preparations

- 1. Connect the camcorder to the VCR.**
 - See “Connections for Playback on a TV Screen” on p. 32.
- 2. Prepare the TV and VCR.**
 - Turn on the TV and set the TV/VIDEO selector to VIDEO.
 - Turn on the VCR, and set its input selector to LINE. Load a blank cassette, and put the VCR in record pause mode.
 - See your TV and VCR instruction manuals for details.
- 3. Turn the camcorder’s POWER switch to PLAY (VCR).**
 - Make sure the AV/headphone terminal is set to AV through the menu ( 32). If PHONES appears in the display, switch the terminal.
- 4. Load your recorded cassette.**

Editing



- 1. Find a point on your recorded cassette slightly before the section you want to copy.**
- 2. Start to play it back while you monitor the picture on the TV.**
- 3. Start recording on the VCR as soon as the section you want to copy appears on the screen.**
- 4. Pause the VCR at the end of the section you want to copy, then stop playback on the camcorder.**
- 5. Repeat steps 1 to 4 until your edited recording is complete.**



Note:



- The quality of the edited tape will be slightly lower than that of the original.

(LANC) terminal

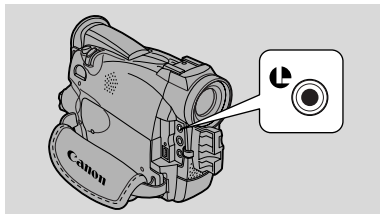
The  terminal allows you to connect the camcorder to equipment. Some buttons on editing equipment may operate differently from those on the camcorder.



Notes:

-  (LANC) is a trademark. It stands for Local Application Control Bus System.
- We cannot guarantee the results when connecting to equipment not bearing the LANC  symbol.

Dubbing with Digital Video Equipment

MV500

Digital video equipment fitted with the DV terminal lets you edit, copy and transfer data digitally, with virtually no generation loss in image and sound quality.

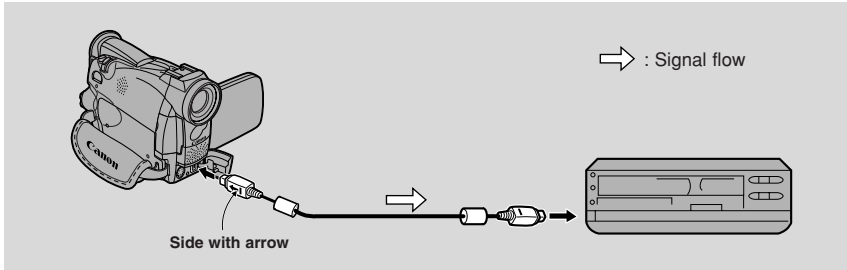

Preparations

- 1. Connect the camcorder and the other digital device.**
 - Connect the Canon CV-150F DV cable (optional) with the side of the plug marked with the arrow facing as shown above.
- 2. Prepare the other device.**
 - Load a blank cassette, and put the other device in record pause mode.
 - See its instruction manual for details.
- 3. Turn the camcorder's POWER switch to PLAY (VCR).**
- 4. Load a recorded cassette.**

Dubbing



- 1. Find a point on your recorded cassette slightly before the section you want to dub.**
- 2. Press the camcorder's play button.**
 - Playback starts.
- 3. Start recording on the other device as the section you want to copy appears on the screen.**
- 4. When you get to the point where you want to stop dubbing, press the stop button or the pause button.**
 - Playback stops.



Note:

- Blanks between recordings on the playback tape are recorded as anomalous images on the tape that is being recorded to.

MV500i

The MV500i is equipped with the DV Recording function.

Digital video equipment fitted with the DV terminal lets you edit, copy and transfer data digitally, with virtually no generation loss in image and sound quality. The DV terminal is for both line-in and line-out, since a single DV cable can handle data in both directions.

- If a digital VCR is connected and an anomalous signal is sent from the VCR, the images recorded on the tape may also be anomalous (although it may not appear so on the TV image), or not recorded at all.
- You are unable to dub tapes recorded with the copyright protective signal.

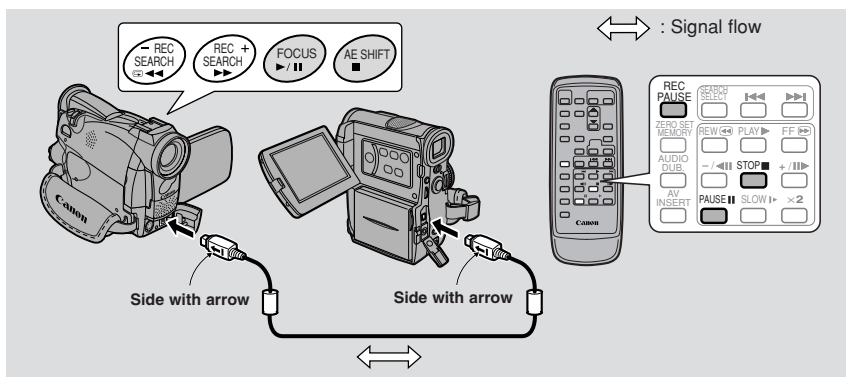

Preparations

Example dubbing to the camcorder

- 1. Connect the camcorder and the other digital device.**
 - Connect the Canon CV-150F DV cable (optional) with the sides of the plugs marked with the arrows facing as shown above.
- 2. Prepare the other device.**
 - Turn on the power and load a recorded cassette.
- 3. Turn the camcorder's POWER switch to PLAY (VCR).**
 - DV IN appears in the display.
- 4. Load a blank cassette.**

Dubbing



1. Find a point on your recorded cassette slightly before the section you want to copy and set it to playback pause mode.
2. Press the REC PAUSE button on the wireless controller.
 - The camcorder enters record pause mode.
3. Start playback on the other digital device while you monitor the picture.
4. Press the pause button.
 - Recording starts.
5. When you get to the point where you want to stop recording, press the stop button or the pause button.
 - Recording stops.
6. Stop playback on the other device.



Notes:

- Blanks between recordings on the playback tape are recorded as anomalous images on the tape that is being recorded to.
- When dubbing to a cassette with digital video equipment, be sure to set AV→DV OUT to OFF in the menu.

Concerning copyrighting

Copyright precaution

Certain pre-recorded video tapes, films and other materials, as well as some television programmes are copyrighted. Unauthorized recording of these materials may violate copyright protection laws.

Copyright signals

When playing back:

If you try to play back a tape that contains copyright control signals for the protection of software, “COPYRIGHT PROTECTED PLAYBACK IS RESTRICTED” appears in the display for a few seconds and then the camcorder displays a blank blue screen; you cannot view the contents of the tape.

When recording:

If you try to record from software that contains copyright control signals for the protection of software, “COPYRIGHT PROTECTED DUBBING RESTRICTED” appears in the display; you cannot record the contents of the software.

You cannot record copyright protection signals to a tape using this camcorder.

Recording from a VCR, TV or Analog Camcorder- Analog Line-in (MV500i only)

You can record a video played on your VCR or analog camcorder (for digital camcorders, see p. 78) or a TV program onto a tape in the MV500i, if the TV or other device has audio/video outputs.

- If an anomalous signal is sent from the TV or VCR, the images recorded on the tape may also be anomalous (although it may not appear so on the TV image), not recorded at all, or COPYRIGHT PROTECTED DUBBING RESTRICTED may appear in the display.
- You are unable to dub tapes recorded with the copyright protective signal.
- For higher picture quality, we recommend using the optional S-150 S-video cable when doing analog line-in recording.

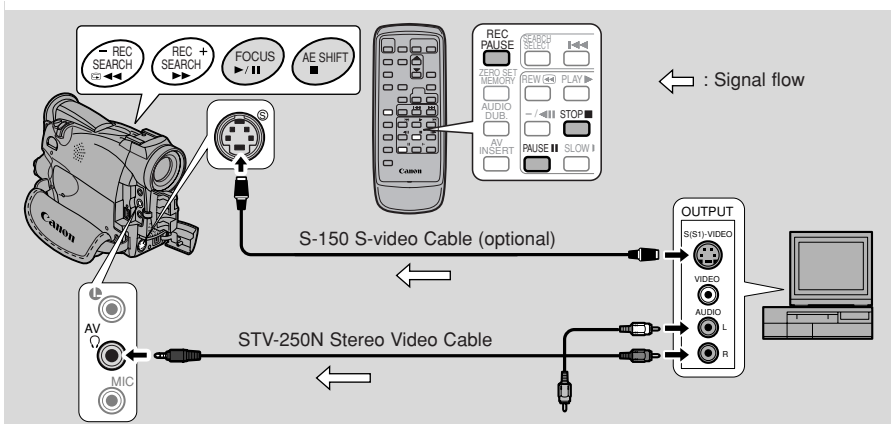

You cannot use headphones while doing analog line-in recording. If you have the AV/headphones terminal set to headphones, it will automatically switch to AV for analog line-in recording. PHONES disappears from the display.

Preparations

Example recording from a VCR

1. **Connect the camcorder to the VCR.**
2. **Prepare the device.**
 - Set the TV/Video selector on the television to Video. For further details, see “Connections for Playback on a TV Screen” on p. 32.
 - Turn on the VCR. Load your recorded cassette, and put the VCR in playback pause mode.
 - See your TV and VCR instruction manuals for details.
3. **Turn the camcorder’s POWER switch to to PLAY(VCR).**
4. **Load a blank cassette.**



1. Find a point on your recorded cassette slightly before the section you want to copy and set it to playback pause mode.
2. Press the **REC PAUSE** button on the wireless controller.
 - S-video and AV IN/OUT terminals work as input terminals.
 - The camcorder enters record pause mode.
3. Start playback on the other device or turn on the TV to see the desired program while you monitor the picture.
4. Press the pause button.
 - Recording starts.
5. When you get to the point where you want to stop recording, press the stop button or the pause button.
 - Recording stops.
6. Stop playback on the other device.

**Note:**

- You can monitor the picture in the viewfinder or LCD.

Digitally Outputting Analog Video and Audio Signals – Analog-Digital Converter (MV500i only)

Connecting the camcorder to your VCR or 8 mm video camcorder allows conversion of recorded analog video and audio signals to digital signals in an instant. The digital signals can be output to the other equipment with a DV terminal. The camcorder's DV terminal works exclusively as an output terminal.

- There may be cases where analog-digital conversion cannot be done properly, depending on the signals output from the connected equipment.
For example: Signals that include the copyright protective signal, or anomalous signals such as ones that include ghost signals, etc.
- You cannot use your headphones during digital conversion. Even if the AV/headphone terminal is set to "PHONES" through the menu, it will automatically be set to "AV", and "PHONES" will disappear from the display.
- You are recommended to use power from a household mains outlet with the power adapter.
- Do not operate with a cassette inserted to the camcorder.
- Turn off the power of all equipment before performing connections.
- Refer also to the instruction manuals of the other equipment connected.

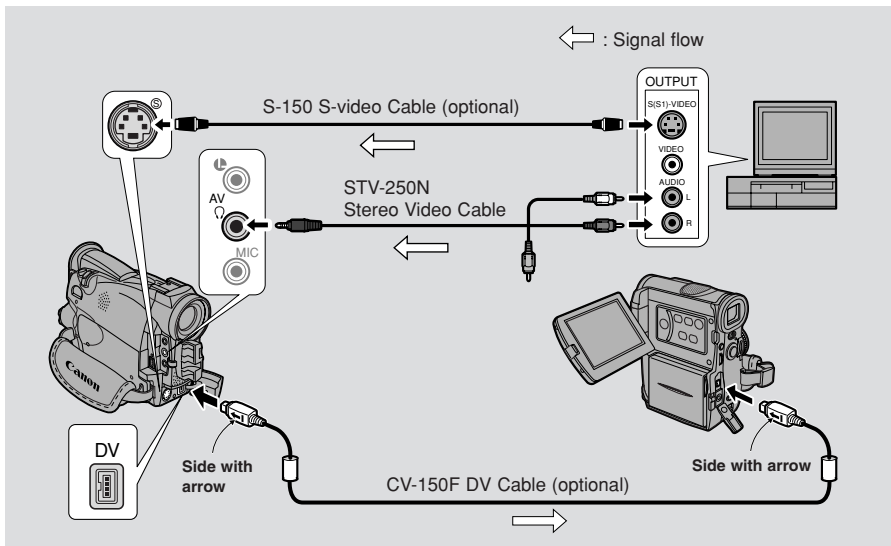

Turning the analog-digital converter on



PLAY
(VCR)

MENU

(39)

▶ VCR SET UP



▶ AV → DV OUT...OFF

To turn the analog-digital converter on, open the menu and select VCR SET UP. Then select AV → DV OUT, set it to ON and close the menu.

Caution:

- For normal use, set AV → DV OUT to OFF through the menu. If it is set to ON, you cannot input digital signals through the camcorder's DV terminal.
- If you attempt to perform analog-digital conversion with a cassette inserted to the camcorder, the converted signals may not be output to the connected digital video equipment.
- When connecting to a PC equipped with a DV terminal, you may not be able to transfer converted signals to your PC, depending on the software you are using, and the specifications of your PC and its settings.

Recording Over Existing Scenes — AV Insert Editing (MV500i only)

You can insert new scenes from your VCR or other camcorder onto your pre-recorded tape using the MV500i's analog line-in or DV in terminals. Original video and audio will be replaced with the new video and audio.

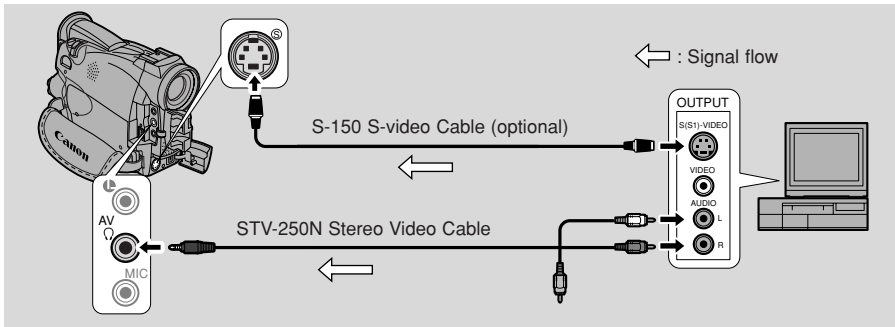
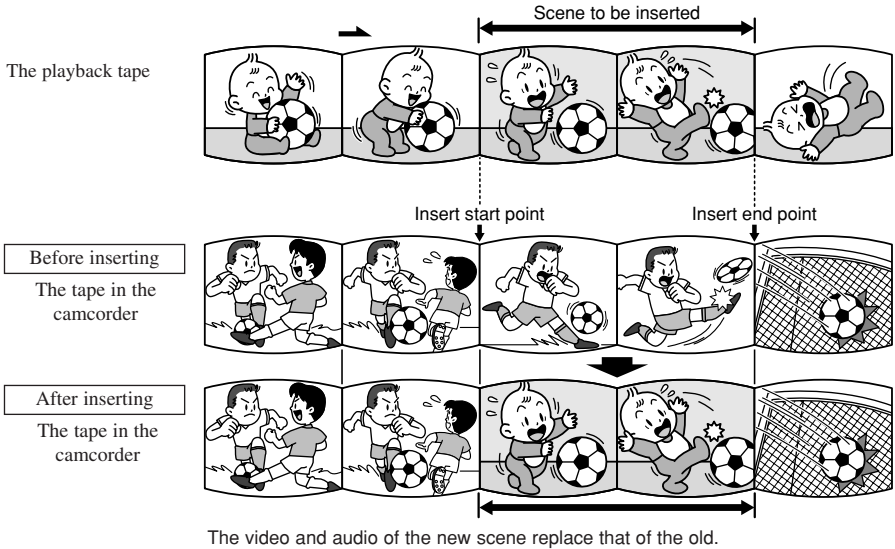

Make sure the AV/headphone terminal is set to AV through the menu (32). If PHONES appears in the display, switch the terminal.

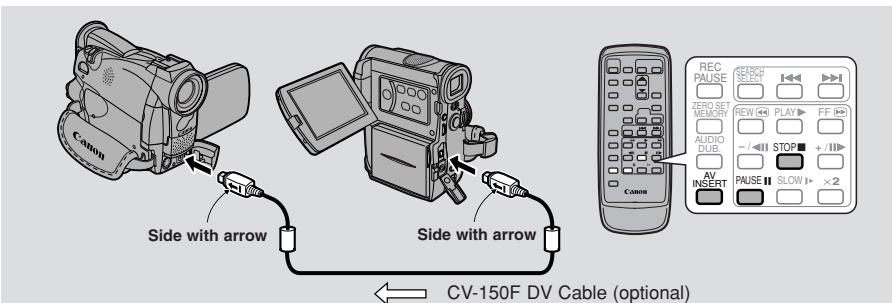

Preparations

The tape in the MV500i:

When using the MV500i's AV insert function, only record to tapes recorded in SP mode.

If there are non-recorded portions or portions recorded in LP mode on the tape, recording will stop.

The playback tape:

Use only tapes without non-recorded portions.

If there are non-recorded portions or changes in the recording mode, you may not be able to insert AV correctly.

You cannot insert AV in the following cases:

- The playback tape has been poorly recorded.
- During special playback: fast forward playback, rewind playback or slow playback etc. (analog only).

TV:

You cannot insert AV from a TV program with anomalous synchronized signals, such as when the program itself received poor signals.

Example recording from a VCR

1. Connect the camcorder to the VCR.

2. Prepare the VCR and TV.

- Set the TV/Video selector on the television to Video. For further details, see "Connections for Playback on a TV Screen" on p. 32.
- Turn on the VCR and load a recorded cassette.
- See TV and VCR instruction manuals for details.

3. Turn the camcorder's POWER switch to PLAY (VCR) and load a recorded cassette.

- Make sure the REC/SAVE tab on the cassette has been slid to REC (closed position).



1. **On the VCR, locate a point 3 seconds before the scene to be inserted. Set the VCR to playback pause mode.**
2. **On the camcorder, press PLAY and locate the recording start point. Set the camcorder to playback pause mode.**
 - You can use the playback buttons on the body of the camcorder or the special playback functions on the wireless controller in the same way as in playback mode.
3. **Press the AV INSERT button.**
 - AV INSERT and ●■■ appear in the display.
4. **Play back the cassette in the VCR.**
5. **To start inserting, press the PAUSE button on the camcorder.**
 - ●■■ changes to ●.
6. **To stop inserting, press the STOP button on the camcorder.**
 - Inserting stops and AV INSERT disappears from the display. The camcorder returns to stop mode.
 - If instead of pressing STOP you press PAUSE, the camcorder returns to the AV insert pause mode.
 - If you set the zero set memory at the position on the tape where you want to stop inserting, every time you return to that point, the camcorder will cancel its AV inserting and enter stop mode.
7. **Stop playback on the VCR.**

Audio Dubbing

E

- For MV500 (For MV500i, 90).



You can add sound to the original sound on a pre-recorded tape recorded in the SP mode with 12-bit sound. Use the internal or an external microphone. The original sound will not be erased.

For best results, add sound to tapes that have been recorded with this camcorder in SP mode with 12-bit sound. If there are non-recorded portions on the tape, or portions recorded in a mode other than SP mode, or with 16-bit or 12-bit, 4-channel sound, dubbing will stop. You cannot dub audio onto a tape recorded with 12-bit and 16-bit sound intermingled.

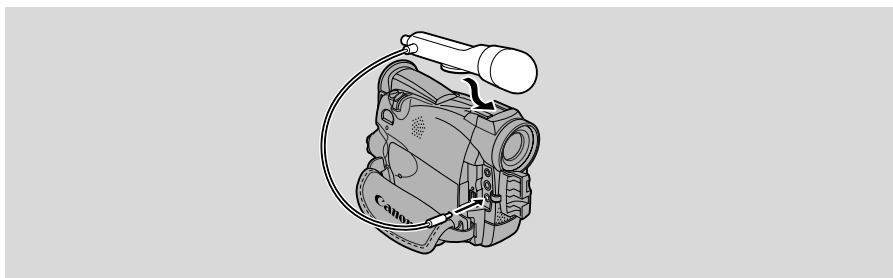
To connect an external microphone:



Notes:

- When you add sound using the built-in microphone make sure not to connect any cables to the MIC terminal.
- To use your TV to monitor video, connect the S-video terminal ( 34) or the AV terminal (use only the video plug) to your TV. You can monitor the sound with headphones only when using the S-video terminal ( 32).

Preparations



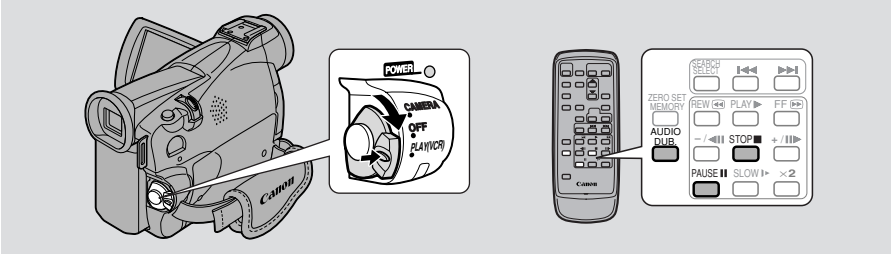

Turn the camcorder's POWER switch to PLAY (VCR) and load a recorded cassette.

- Make sure the REC/SAVE tab on the cassette has been slid to REC (closed position).



Do not connect/disconnect any cables to/from the camcorder when dubbing audio or preparing to dub audio.

PLAY (VCR)

1. **Locate the point where you want to start audio dubbing, then press the PAUSE button.**
 - You can use the playback buttons on the body of the camcorder or the special playback functions on the wireless controller in the same way as in playback mode.
 - The camcorder becomes set to playback pause mode.
2. **Press AUDIO DUB.**
 - AUDIO DUB. and  appear on the display.
3. **Press the PAUSE button.**
 - Audio dubbing starts.
 - Direct your voice into the microphone.
 -  changes to .
4. **When you get to the point where you want to stop dubbing, press the STOP button.**
 - Audio dubbing stops and AUDIO DUB. disappears from the display.
 - The camcorder returns to stop mode.
 - You can also set zero set memory ( 75) at the place you want to stop audio dubbing, then every time you return to that position, audio dubbing will cancel.
 - If instead of pressing STOP you press PAUSE, the camcorder will return to the playback pause mode.



Notes:

- You can not use the DV terminal while adding sound.
- You might want to adjust the audio mix ( 93) when playing back a tape with added sound.
- There may be a loss of sound quality if you add sound to a tape recorded on a camcorder other than the MV500.
- After adding sound 3 or more times to the same place on a tape, there may be some loss in sound quality.

E**- For MV500i (For MV500, 88).**

You can add sound to the original sound on a pre-recorded tape from audio products (AUDIO IN) or with the internal or external microphone (MIC. IN). The original sound will not be erased. For best results, add sound to tapes that have been recorded with this camcorder in SP mode with 12-bit sound. If there are non-recorded portions on the tape, or portions recorded in a mode other than SP mode, or with 16-bit or 12-bit, 4-channel sound, dubbing will stop. If your tape hasn't been recorded in SP mode with 12-bit sound, we recommend dubbing your original tape onto a blank tape using the MV500i's analog line-in function, then dubbing audio onto the new tape. Make absolutely sure to set the audio mode of the new tape to 12-bit and the recording mode to SP.

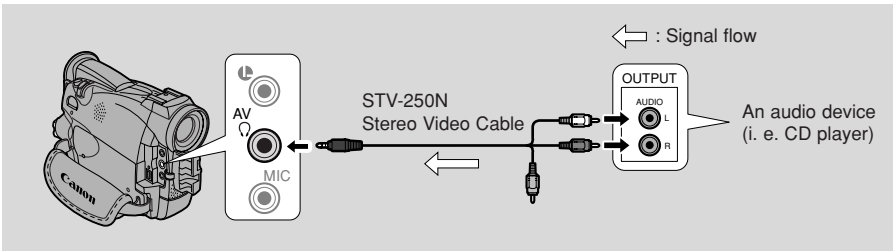
To connect other audio equipment:

Make sure the AV/headphone terminal is set to AV through the menu (32). If PHONES appears in the display, switch the terminal.

Notes:

- Do not use the yellow video terminal.
- The AV terminal doesn't put out any video, so connect the S-video terminals and check your TV, or check the LCD or the viewfinder as you add new sound. Always check the new sound with the speaker.

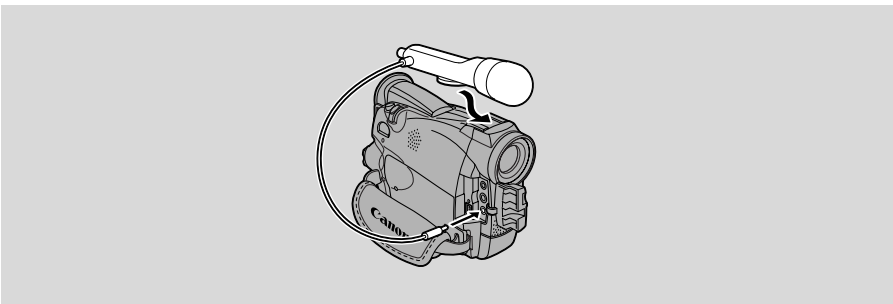
To connect an external microphone:

Notes:

- When you add sound using the built-in microphone make sure not to connect any cables to the MIC terminal.
- To use your TV to monitor video, connect the S-video terminal (34) or the AV terminal (use only the video plug) to your TV. You can monitor the sound with headphones only when using the S-video terminal (32).

Preparations

Turn the camcorder's POWER switch to PLAY (VCR) and load a recorded cassette.

- Make sure the REC/SAVE tab on the cassette has been slid to REC (closed position).

Dubbing

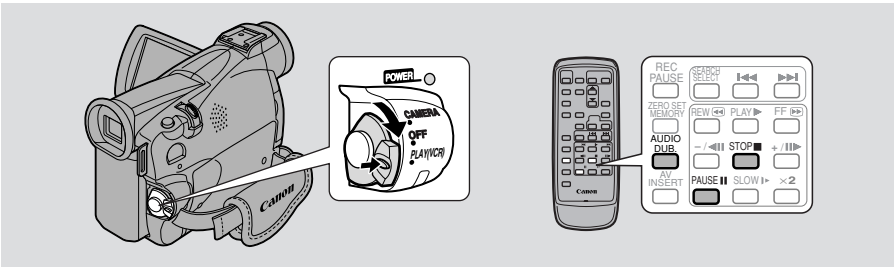

Do not connect/disconnect any cables to/from the camcorder when dubbing audio or preparing to dub audio.

PLAY (VCR)





MENU

(39)

▶VCR SET UP

▶▶AUDIO DUB...AUDIO IN

1. Open the menu and select VCR SET UP.
2. Select AUDIO DUB.
3. Select AUDIO IN or MIC. IN and close the menu.

4. **Locate the point where you want to start audio dubbing, then press the PAUSE button.**
 - You can use the playback buttons on the body of the camcorder or the special playback functions on the wireless controller in the same way as in playback mode.
 - The camcorder becomes set to playback pause mode.
5. **Press the AUDIO DUB. button.**
 - AUDIO DUB. and  appear on the display.
6. **Press the PAUSE button (and start play on the other audio device if AUDIO IN).**
 - Audio dubbing starts.
 - Direct your voice into the microphone.
 -  changes to .
7. **When you get to the point where you want to stop dubbing, press the STOP button (and then stop play on the other audio device if AUDIO IN).**
 - Audio dubbing stops and AUDIO DUB. disappears from the display.
 - The camcorder returns to stop mode.
 - You can also set zero set memory ( 75) at the place you want to stop audio dubbing, then every time you return to that position, audio dubbing will cancel.
 - If instead of pressing STOP you press PAUSE, the camcorder will return to the playback pause mode.

**Notes:**

- You cannot use the DV terminal while adding sound.
- You might want to adjust the audio mix ( 93) when playing back a tape with added sound.
- There may be a loss of sound quality if you add sound to a tape recorded on a camcorder other than the MV500i.
- After adding sound 3 or more times to the same place on a tape, there may be some loss in sound quality.

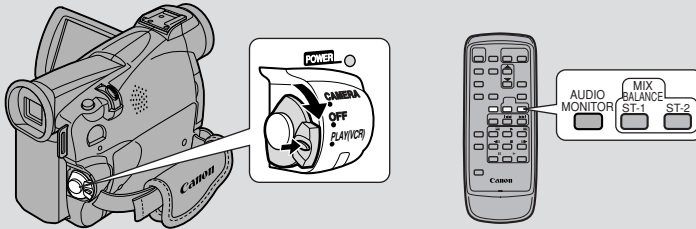

When you play back a tape that was recorded in 12-bit mode, you can set the audio output to play: stereo 1 (the original sound), stereo 2 (any new sound, dubbed to the tape after recording), or mix the balance between the two.

- Audio from the 16-bit mode only contains stereo 1 sound and so you cannot/ do not need to select the audio mix. The same is true for the 12-bit stereo 1 mode, unless new sound has been added post-recording.

PLAY (VCR)

1. Choose the output.

- Press **AUDIO MONITOR** on the wireless controller.
- Starting with the last selected setting, 4 settings appear as you push the button:
 - STEREO1 for just stereo 1.
 - STEREO2 for just stereo 2.
 - MIX/FIXED for an equal mix of stereo 1 and 2.
 - MIX/VARI. (mix variable) for when you want to mix the balance between stereo 1 and 2.
- To simply choose STEREO1, STEREO2 or MIX/FIXED, make sure your choice appears on the display.
- If you choose MIX/VARI., you can go on to mix the balance.
- Use the ST-1/ST-2 keys to mix the balance. A bar showing the mix appears on the screen for 4 seconds.



Note:

- When you have chosen the output, STEREO1, STEREO2, MIX/FIXED or MIX/VARI. is shown in the top left of the display for a few seconds. If you turn the power off the output is set to STEREO1.

Selecting audio output channels



When you play back a tape whose audio has been recorded on multiple channels, you can change the output channels of that sound.

PLAY
(VCR)

MENU
(39)

▶VCR SET UP



▶OUTPUT CH...L/R

1. Load a tape recorded with multiple-channel audio.
2. Open the menu and select **VCR SET UP**. Then select **OUTPUT CH**, set it to the desired setting and close the menu.
 - Refer to the following list.

OUTPUT CH setting	Played back sound	
	Tape recorded with stereo sound	Tape recorded on multiple channels
L/R	L+R channels	main + sub
L/L	L channel only	main only
R/R	R channel only	sub only

Connecting to a PC Using a DV Cable

E

By using a DV cable and connecting the camcorder to a PC equipped with a DV terminal conforming to IEEE 1394/DV compatible capture board, you can transfer images taken with the camcorder to your PC.

- While connected, it is recommended that you power your camcorder from a household power socket using the power adapter.
- Turn off the power of both the camcorder and the PC before connecting.
- Optional software necessary.

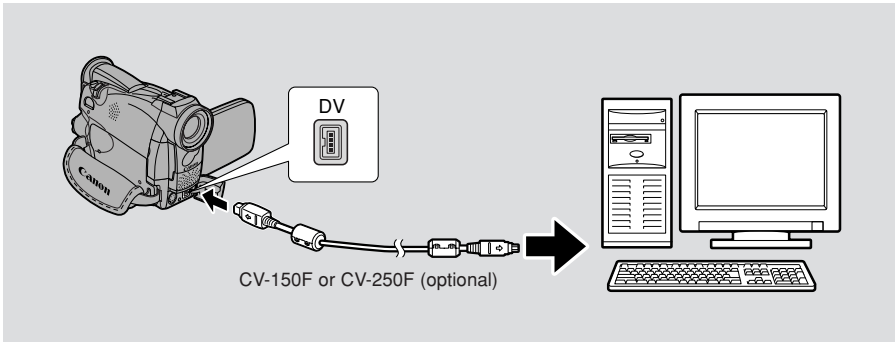

Notes:

- Operation may not work correctly, depending on the software you are using, and the specifications of your PC and its settings.
- See your PC instruction manual for details.

Editing

Preparing the Camcorder

E

Adjust the viewfinder

- Set the camcorder to CAMERA mode. Extend the viewfinder straight out, then adjust the viewfinder focusing lever to suit your eyesight.
- Rotate the viewfinder to an angle that allows you to view comfortably. Store the camcorder with the viewfinder flush with the body of the camcorder.
- To view with the viewfinder, make sure the LCD panel is either turned so that the subject can monitor viewing, or totally closed with the screen facing inwards.

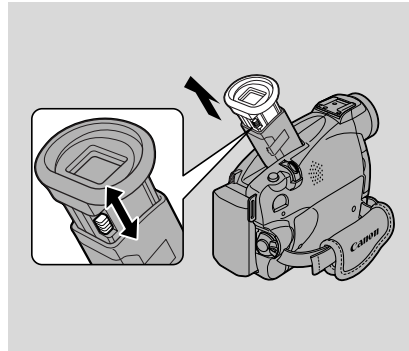

- Be careful not to leave the viewfinder exposed to bright sunlight, or it will melt. (The light is concentrated by the viewfinder lens.) Adjust the angle of the viewfinder to prevent sunlight from entering.

Prepare the lens cap

- Attach the cord to the lens cap, and pass the grip belt through the loop on the cord.
- Hook the lens cap on to the grip belt while you are recording, and place it over the lens when you have finished.

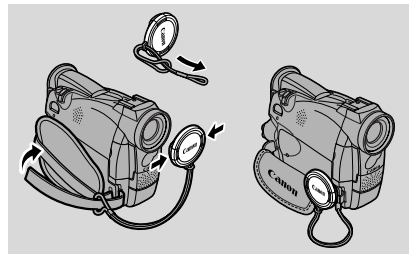

Fasten the grip belt

- Release the Velcro fastening and hold the camcorder with your right hand while you adjust the belt with your left. Your index finger should reach the zoom control and photo button, and your thumb should reach the start/stop button comfortably.

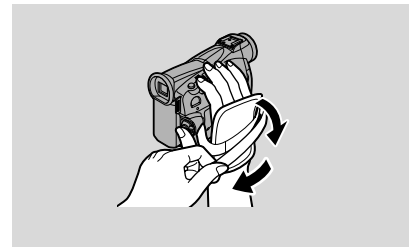

Additional
Information

Attach the shoulder strap

- For extra security and portability, attach the shoulder strap before using the camcorder.
- Pass the ends through the attachment bars and adjust the length as shown.

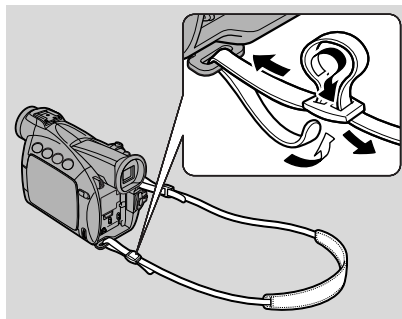

E

Additional
Information

Notes on Using the Batteries

E

Charging and recording times

- These times vary — the safest policy is always to have 2 or 3 times as many battery packs as you think you will need.
- You will get more recording time if you turn the camcorder off between shots, instead of leaving it in record pause mode.

	Time needed for full recharge	Maximum recording time	
		Using viewfinder	Using LCD screen
BP-508	1 hr.	1 hr. 35 min.	1 hr. 15 min.
BP-512 (optional)	1 hr. 20 min.	2 hr. 55 min.	2 hr. 20 min.
BP-511 (optional)	1 hr. 20 min.	2 hr. 55 min.	2 hr. 20 min.
BP-522 (optional)	2 hr. 15 min.	6 hr. 10 min.	4 hr. 55 min.
BP-535 (optional)	3 hr. 15 min.	9 hr. 50 min.	7 hr. 50 min.

- You can use the battery pack between 0° and 40°C (32° to 104°F), but it works best between 10° and 30°C (50° to 86°F). Operating time will be shorter than usual at low temperatures like a ski ground. For better operating results, the battery pack can be warmed in your pocket or someplace and then used.
- If the battery pack starts to give you much less operating time than usual (at normal temperatures), it has reached the end of its life and must be replaced.



Note:

- These figures show how long you can view playback with the LCD, after attaching a fully-charged battery pack. Playback time will be shortened at low temperatures.

	Playback time (using the LCD screen)
BP-508	1 hr. 20 min.
BP-512 (optional)	2 hr. 30 min.
BP-511 (optional)	2 hr. 30 min.
BP-522 (optional)	5 hr. 20 min.
BP-535 (optional)	8 hr. 30 min.

Additional Information

How much power is left?

The indicator in the display shows you approximately how much charge the battery pack has left:

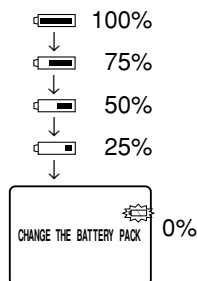

Notes:

- When the power is completely exhausted, “CHANGE THE BATTERY PACK” appears in the display for 4 seconds and the empty battery mark starts to flash. The power indicator light also flashes.
- The indicator is not constant — different levels will be shown when you subject the battery pack and camcorder to different conditions.

When to recharge

You can recharge a lithium ion battery pack whenever it is convenient. Unlike a conventional battery pack, it does not have to be fully discharged first. However, as the battery pack will naturally discharge itself over time, it is best to charge it the same day you plan to use it, or the day before.

Taking care of the battery pack

Always attach the terminal cover.

- Do not allow any metal objects to touch the terminals, as this can cause a short circuit and damage the battery pack. Attach the terminal cover whenever the battery pack is not being used.

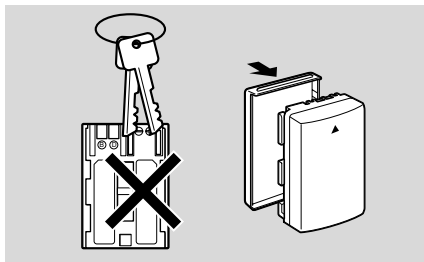

Keep the terminals clean.

- The camcorder, adapter or battery pack will not work properly if the terminals are dirty. Attach the terminal cover whenever the battery pack is not being used.

Storing the battery pack.

- If you do not use a battery pack for a period of more than a few months any remaining charge may cause damage to the battery pack, and reduce usage time. To prevent damage therefore, aim to use a battery pack’s complete charge before storage. See the optional battery pack’s instructions for further details.

Installing the backup battery

Open the backup battery cover on the battery attachment unit, and insert the CR2025 lithium battery with the + side facing outwards. Click the cover back into place.

This backup battery allows the camcorder to remember the date and time and other settings when main power source is removed. It has a life span of about a year.

When it needs replacing (or if it has not been installed), the  mark flashes in the display.

Remove the old battery by pushing up then releasing and lifting out. Make sure to attach a power source to the camcorder first, so it will remember your chosen settings when you change the battery.

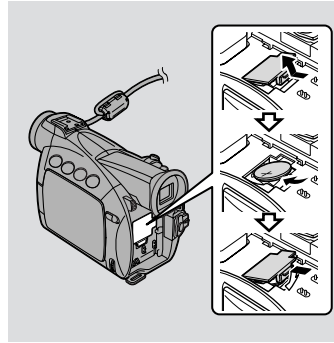

DANGER!

Treat the battery pack with care.

- Keep it away from fire (or it might explode).
- Do not expose the battery pack to temperatures greater than 60°C (140°F). Do not leave it near a heater, or inside a car in hot weather, for example.
- Do not try to disassemble or modify it.
- Do not drop or knock it.
- Do not get it wet.

WARNING!

- The battery used in this device may present a fire or chemical burn hazard if mistreated. Do not recharge, disassemble, heat above 100°C (212°F) or incinerate.
- Replace the battery with a Sony, Hitachi Maxell, Sanyo or Panasonic CR2025, or Duracell DL2025. Use of another battery may present a risk of fire or explosion.
- The used battery should be returned to the supplier for safe disposal.

Cautions:

- Do not pick up the battery using tweezers or other metal tools — this will cause a short circuit.
- Wipe the battery with a clean, dry cloth to ensure proper contact.
- Keep the battery pack out of reach of children — if it is swallowed, contact a physician immediately, as the battery case may break down and the battery fluids damage the stomach and intestines.
- Do not disassemble, heat or immerse the battery in water, to avoid the risk of explosion.

Maintenance

Cautions

E

Avoid high temperatures and high humidity.

- Do not leave the camcorder inside a car in hot weather, for example.
- Be careful of heat radiating from video lighting equipment.
- Do not take the camcorder into a humid room.

Avoid sudden changes in temperature.

- If you take the camcorder from a cold place to a warm place, condensation may form on the lens and internal parts (104).

Do not point the lens or viewfinder at strong light sources.

- Never point it at the sun, and do not leave it aimed at a bright subject.
- Be especially careful when leaving the camcorder on a tripod.

Avoid magnetic or electric fields.

- Do not use the camcorder close to TV transmitters, portable communication devices or other sources of electric or magnetic radiation. They may cause picture interference, or permanently damage the camcorder.

Do not expose the camcorder to water.

- Cover the camcorder when you are recording in rain or mist.
- There is a risk of electric shock if water gets inside the camcorder — contact qualified service personnel as soon as possible.

Protect the lens.

- Sand and dust can damage the lens — be especially careful on windy days.

Handle the camcorder gently.

- Vibration or shock can cause damage.
- Do not use the viewfinder or LCD panel as a carrying handle.

Do not disassemble the camcorder.

- This is very dangerous as there is a risk of electric shock — if the camcorder does not function properly, take it to qualified service personnel.

Additional
Information

Storage

If you do not intend to use the camcorder for some time, store it in an area which is free of dust and moisture, and where the temperature is no higher than 30°C (86°F). After storage, check each part and function of your camcorder to make sure everything is still working properly.



Note:

- These cautions also apply to accessories such as battery packs and cassettes.

Maintenance

Viewfinder

- Clean the viewfinder screen. Rotate the viewfinder upwards. Remove the viewfinder protect cover and clean by inserting a cotton bud. When finished, return it flush with the camcorder.
- The viewfinder screen scratches easily. Take care when cleaning.

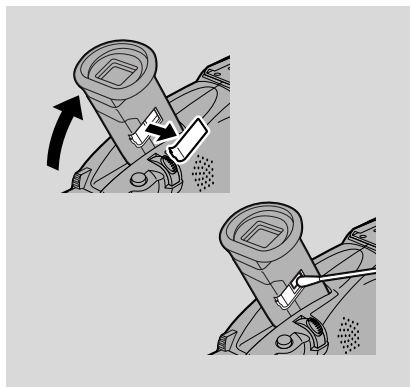

LCD

- Clean the LCD screen using a commercially available cleaning cloth for glasses.
- Where there is a big change in temperature, moisture may form on the surface of the screen. Wipe clean with a soft, dry cloth.
- At low temperatures the display may appear to be much darker than usual. This is not a fault, and as the screen warms up the display will return to normal.

Camcorder body and lens

- Use a soft, dry cloth to clean the camcorder body or lens. Never use chemically treated cloth or volatile solvents such as paint thinner.

Video heads

- When mosaic-like noise appears on the playback picture, the video heads may be dirty. When the video heads are badly contaminated, the camcorder may show a blank blue screen or a warning.
- For the best picture possible, after using the camcorder for approximately 20 hours, clean the video heads using Canon's DVM-CL Digital Video Head Cleaning Cassette. If the "noise" remains, repeat the cleaning (up to maximum of 5 times).
- Do not use a wet-type cleaning cassette, as this can cause damage.



Using the camcorder abroad

Power sources

- You can use the compact power adapter to operate your camcorder and charge battery packs in any country where the electricity supply is between 100 and 240 V AC, 50/60 Hz. Contact your Canon dealer for information about plug adapters for overseas use.

TV playback

- Although you can always play back your recordings on the LCD screen, your camcorder can only be connected to TVs which use its PAL system. This TV system is used in the following countries:
Algeria, Australia, Austria, Bangladesh, Belgium, Brunei, China, Denmark, Finland, Germany, HongKong, Iceland, India, Indonesia, Ireland, Italy, Jordan, Kenya, Kuwait, Liberia, Malaysia, Malta, Mozambique, the Netherlands, New Zealand, North Korea, Norway, Oman, Pakistan, Portugal, Qatar, Sierra Leone, Singapore, South Africa, Spain, Sri Lanka, Swaziland, Sweden, Switzerland, Tanzania, Thailand, Turkey, Uganda, United Arab Emirates, United Kingdom, Yemen, former Yugoslavia, Zambia.

Condensation

Condensation may form on the camcorder when it is moved from a cold place to a warm place. Using the camcorder while condensation is present can damage both the tape and the camcorder.

Condensation may become a problem:

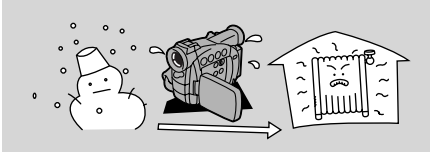

When you take the camcorder from a cold place to a warm room

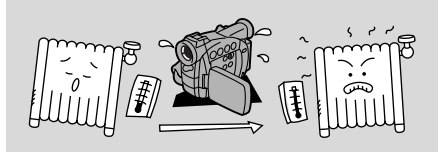

When a cold room is heated rapidly

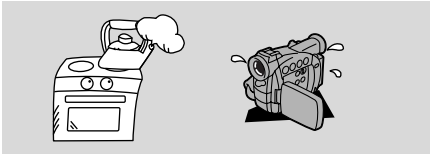

When the camcorder is left in a humid room

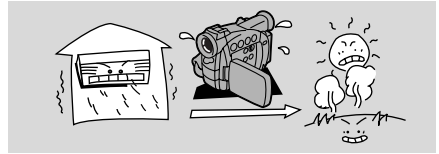



When the camcorder is taken from an air-conditioned room to a warm, humid place

Protecting the camcorder from condensation

- Before you take the camcorder to a warm or humid place where condensation is likely to be a problem, unload the cassette and put the camcorder in a plastic bag. Wait until the camcorder reaches room temperature before you take it out of the bag.

What happens when condensation is detected

- “CONDENSATION HAS BEEN DETECTED” is displayed for approximately four seconds. Then, the power indicator flashes and the  mark flashes in the display. If there is a cassette in the camcorder, it stops automatically and “REMOVE THE CASSETTE” is displayed for approximately 4 seconds and then  flashes in the display. If you have the beep turned on, it will sound.
- The camcorder may not detect the condensation immediately — the condensation warning may not start flashing for 10 to 15 minutes.
- You cannot load a cassette when condensation is detected.

What you should do

- Remove the cassette, leave the cassette compartment open, and turn the camcorder off.
- Leave it in a dry place until the condensation evaporates. After the condensation warning stops flashing, wait at least another hour before trying to use the camcorder.

Troubleshooting

E

Refer to this checklist first if you have any problems with your camcorder. Possible explanations are given for each problem on the list — turn to the page numbers in parentheses for more information.

Make sure that the camcorder is properly connected if you are using it with a TV or VCR. Consult your dealer or service outlet if problems persist.

Recording/Playback

Problem

Cause and/or what to do about it

? Nothing happens when I press the buttons.

- The camcorder is not set to the appropriate mode (18, 28).
- The cassette is not loaded or is set for erasure prevention (16-17).
- The cassette has reached the end.
- The power source is not properly connected, or the battery pack is exhausted or not properly attached (11-15, 99).
- The function cannot be used in that recording program (52).

? The camcorder turned itself off.

- The camcorder was in record pause mode for more than about 5 minutes (18, 114).
- The battery pack is exhausted (12-15, 99).

? The cassette compartment stopped mid-operation while loading/unloading a cassette.

- The battery pack's power is exhausted. Recharge or change to a new battery pack (12-15).

? The start/stop button doesn't work.

- The cassette is not loaded or is set for erasure prevention (16-17).
- The cassette has reached the end.

? There's no picture in the display.

- The camcorder is not set to the appropriate mode (18, 28).

? There's a blank blue screen in the display.

- You are attempting to play back or record copyright protected material (80).
- The video heads are badly contaminated (103).

Additional
Information

❗ The camcorder won't focus.

- The camcorder is on manual focus (📖 68).
- The viewfinder lens needs adjusting (📖 96).
- The lens is dirty (📖 102).

🏠 Note:

- Some subjects are not suitable for autofocus. In these situations, you will often get better results using manual focus (📖 68). Focus on something which is about the same distance away, lock the focus, and then point the camcorder at your original, hard-to-focus subject.



Horizontal stripes



Many subjects at different distances



Behind glass

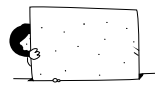

Without much contrast (e.g. a white wall)



Reflective surfaces
(e.g. shiny car surfaces)



Fast moving objects



Dark subjects



Night scenes

Recording/Playback (Cont.)

Problem

- ❗ Some/all of the digital effects don't work.
- ❗ The ▶ (play) button doesn't work.
- ❗ There's a bright stripe on the screen.



- ❗ The playback picture is rough (with mosaic-like noise).

Cause and/or what to do about it

- There are a number of restrictions on using the digital effects (📖 56-60).
- The camcorder is not set to PLAY (VCR) mode (📖 28).
- The cassette is not loaded (📖 16).
- The cassette has reached the end.
- When recording in dark places a bright light in the scene may cause a vertical light bar ("smear") to appear. This is a normal feature of camcorders.
- The video heads need cleaning (📖 103).

? There's no picture on the TV screen.

- AV/PHONES is not set to AV in the menu (32).
- AV → DV OUT (Analog-digital converter) is not set to OFF in the menu (83).

? There's no picture on the TV screen, even though the tape is moving.

- The video heads need cleaning (103).
- The TV/VIDEO selector on the TV isn't set to VIDEO (33-35).

? There's no sound coming from the speaker during playback.

- The speaker has been turned off with the selector dial (31).
- Headphones are being used.

Miscellaneous

Problem

? The wireless controller doesn't work.

Cause and/or what to do about it

- The remote sensor mode is set to OFF (44) in the menu (44).
- The remote sensor modes of the wireless controller and the camcorder itself are different (44).
- The batteries are dead or not inserted.
- Check the screen displays (111).
- External interference may cause the camcorder's microprocessor to malfunction temporarily. If random letters appear in the display or if normal operation is interrupted, remove and then replace the power source.

? The power indicator is flashing.

? The camcorder malfunctions.

- Remove the cable and then reconnect it or turn the power off and back on again.

? The DV cable is connected correctly, but there's nothing in the display.

? The camcorder becomes warm during use.

- This is not a malfunction.

The MV500/MV500i System Diagram (Availability differs from area to area)

E

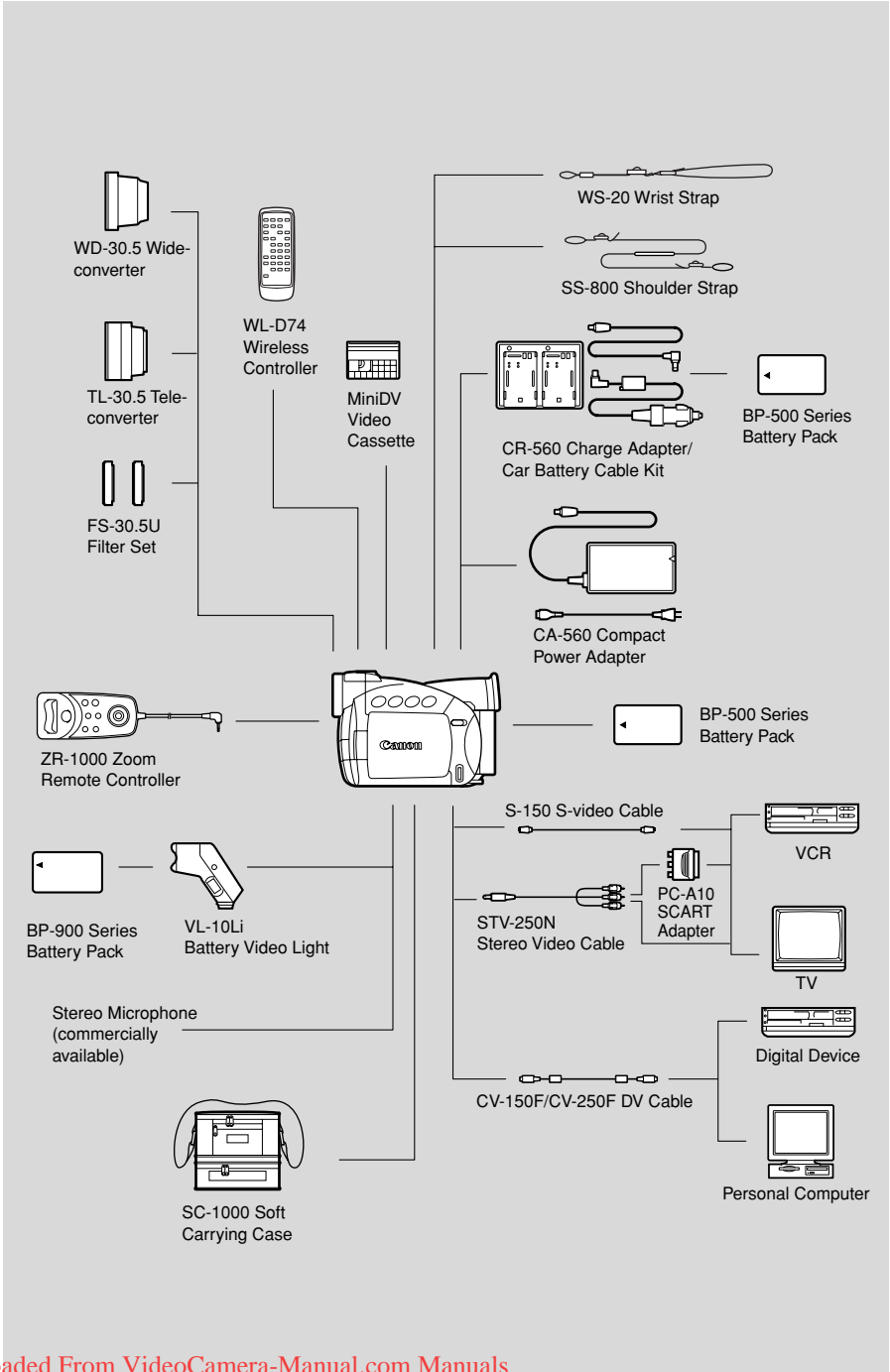

Additional Information

Optional Accessories

E

BP-500 Series Battery Packs

The battery pack BP-508 is not available as an option. When you need extra battery packs, select from the following: BP-511, BP-512, BP-522 and BP-535.

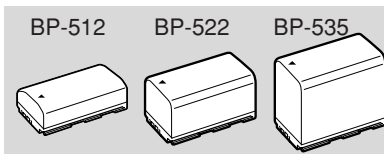

CR-560 Charge Adapter/Car Battery Cable Kit

Connect the car battery cable to power your camcorder or recharge battery packs on the move. The car battery cable plugs into your car's cigarette lighter socket and runs off a 12-24 V DC negative ground battery.

Also, when used with the CA-560 Compact Power Adapter, this charge adapter can charge the BP-500 series lithium ion battery packs from a mains outlet.

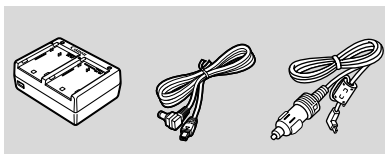

TL-30.5 Tele-converter

This tele-converter lens increases the focal length of the camcorder lens by a factor of 1.9.

- The image stabilizer is not as effective as usual when the tele-converter is attached.

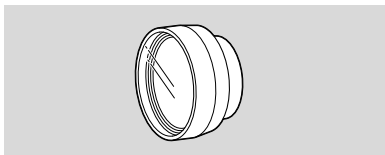

WD-30.5 Wide-converter

This lens decreases focal length by a factor of 0.7, giving you a wide perspective for indoor shots or panoramic views.

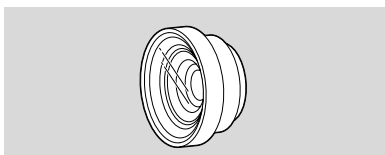

FS-30.5U Filter Set

Neutral density and MC protector filters to help you take control of difficult lighting conditions.

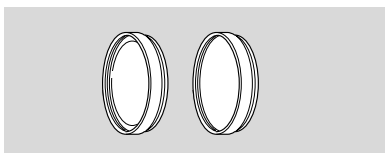

Additional
Information

VL-10Li Battery Video Light

This compact yet powerful video light can be used for both indoor and outdoor shooting.

- Use the BP-900 Series battery packs to power the light. Approximate usage times are as follows:
BP-915 60 min. BP-930 120 min.
BP-945 170 min.
- Charge the BP-900 Series battery packs with the CA-910 Compact Power Adapter (optional).

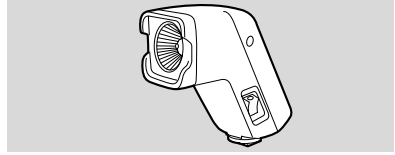

Zoom Remote Controller ZR-1000

When this product is plugged into the LANC  terminal of a Canon camcorder, it is possible to control functions such as the start and stop of recording and the zoom and focusing functions while the camcorder is mounted on a tripod, without touching the camcorder body itself.

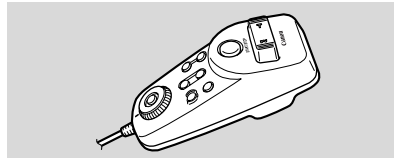

WS-20 Wrist Strap

Provides an extra measure of protection for active shooting.

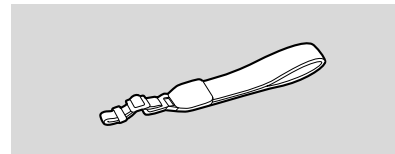

SC-1000 Soft Carrying Case

A handy camcorder bag with padded compartments and plenty of space for accessories.

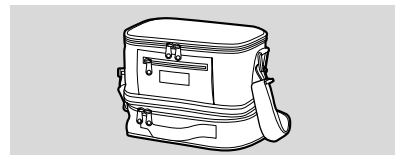

This mark identifies genuine Canon video accessories. When you use Canon video equipment, we recommend Canon-brand accessories or products bearing the same mark.

Screen Displays

To display the date and time, press the DATA CODE button. See also p. 71.

Press the wireless controller's TV SCREEN button or turn TV SCREEN on through the menu to see the other displays on the TV screen. (The displays appear white on-screen.) They will not be added to any recordings you make with the camcorder.

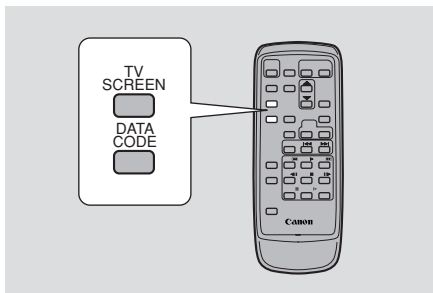

CAMERA

MENU
([] 39)



To turn TV SCREEN off, open the menu and select DISP. SET UP. Then select TV SCREEN, set it to OFF and close the menu.

For instructions on how to hook the camcorder up to your TV, see p. 32.

Turning off the LCD screen displays



You can turn off the displays to give you a clear screen for playback.

PLAY (VCR)

MENU
([] 39)



To turn the display off, open the menu and select DISP. SET UP. Then select DISPLAYS, set it to OFF <PLAYBK> and close the menu.

- If you turn the displays off, the LCD screen will be completely blank (including connected TV screen), but the camcorder will continue to show warning/caution displays when necessary, and the data code appears in the display if it is set to ON.
- When operating the camcorder, the displays appear for 2 seconds. However, the displays do not disappear when displaying an index screen.

 indicates a flashing display.

Record pause mode
([] 18)



The backup battery is not properly installed, or needs replacing
([] 100).



Recording ([] 19)



E

Shows how much battery power remains (99).



The battery pack is exhausted (99).



No cassette is loaded, or it is set for erasure prevention (16, 17).



Remaining tape (Green: more than five minutes. Yellow: less than five minutes. Red: final few seconds.)

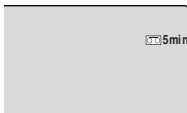

...finally, it tells you when you have completely run out of tape.



The camcorder is ejecting the tape (16).



The safety mechanism is activated. Unload the cassette and turn the camcorder off. Turn it on again and reload the cassette.



Recording mode (20)

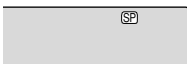

Playback is stopped (28).



Normal playback (28)



Fast forward (28)



Rewind (28)



Fast forward playback (29)



Rewind playback (29)



Frame advance playback (29)



Frame reverse playback (29)



Playback pause (forward and reverse) (29)

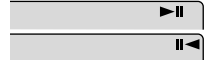

Slow playback (forward and reverse) (29)



×2 playback (forward and reverse) (30)



×1 playback (forward and reverse) (28, 30)



Photo Search (74)

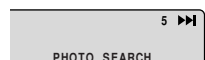

Date Search (74)

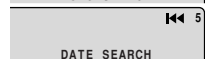

Zero set memory (forward and reverse) (75)

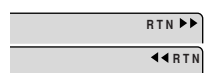

AV Insert Editing (85) (MV500i only)



Audio Dubbing (88)

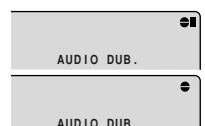

Additional Information

Zoom display (23):
Optical zoom

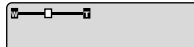

Optical plus 72×
digital zoom



Optical plus 360×
digital zoom



Zoom in



Zoom out



The image stabilizer
is turned on (51).



CAM. MENU
(40)

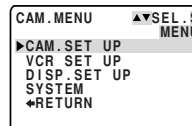

PLAY MENU
(MV500i: VCR
MENU) (42)

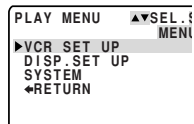

The remote sensor is
turned off (44).



Self-timer countdown
(63)

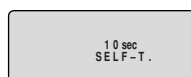

Zero set memory
(75)



Audio mode (61)



Data code (71)



Photo mode (49)



• Setting the AF/AE. mark flashes white



• AF/AE locked. mark lights up green



• Timer



Recording programs
(52).

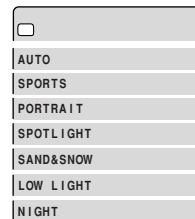

AE Shift (65)

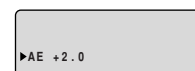

Manual focus is
selected (68).

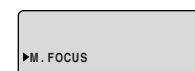

Shutter speed (66)

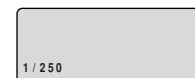

White balance is
(69)

Set
Indoor
Outdoor



The 16:9 mode: the
display flashes when
the effect is being
selected, and appears
steadily when it is
activated (21).



Digital effects. The
display flashes when
the function is being
selected and appears
steadily when it is
activated (56).

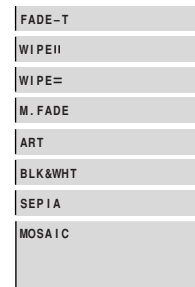

The wind screen is turned on (62).

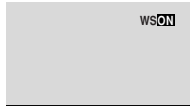

Volume level (31):
Speaker



Headphones

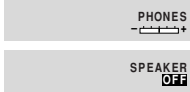

The AV/headphones terminal is switched to headphones (32).



Audio output (93)



Mix balance (93)

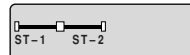

Audio input and
Microphone input (91)
(MV500i only)
Audio input



Microphone input



DV input (78)
(MV500i only)



Analog-digital
converter (83)
(MV500i only)



Condensation warning (104)



Time Code

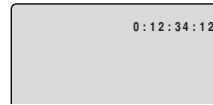

This records counter information, including hour, minute, second, and frame number on a special data code area on the tape itself. It is reset automatically when a new tape is loaded. In CAMERA mode, the frame number doesn't appear in the display.

Recording reminder

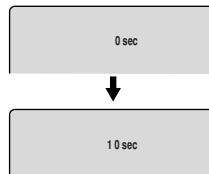

When you start recording, the camcorder counts from 0SEC to 10SEC. Shots which are shorter than ten seconds may be difficult to edit later. On the other hand, if you are not planning to edit the recording, remember that a shot which does not contain action should generally last no longer than 10 seconds.

“ⓘ AUTO POWER OFF”



- The camcorder will turn itself off if you leave it in record pause mode for more than about 5 minutes. This display appears 20 seconds (approx.) before the camcorder turns off.

Caution phrases

The camcorder displays various caution phrases — they appear for 4 seconds before disappearing.

Appears each time you turn the power on, until you set the time zone, date and time ( 46).

SET THE TIME ZONE,
DATE AND TIME

Appears as a warning to protect the tape and also when condensation is detected. Remove the tape as soon as possible after the camcorder has displayed the caution.

REMOVE THE CASSETTE

Appears when the battery pack is exhausted ( 99).

CHANGE THE BATTERY PACK

Refer to p.80

Appears when the tape has reached the end.

TAPE END

COPYRIGHT PROTECTED
PLAYBACK IS RESTRICTED

Refer to p.17

THE TAPE IS SET FOR
ERASURE PREVENTION

Refer to p.80, p.81 or p.83

COPYRIGHT PROTECTED
DUBBING RESTRICTED

Appears when, during DV dubbing, the DV cable is disconnected or the power of the digital equipment connected to the camcorder is turned off. (MV500i only)

CHECK THE DV INPUT

Appears when you try to do audio dubbing or AV insert (MV500i only) on a tape recorded in LP mode ( 85, 88).

CHECK THE CASSETTE
[REC MODE]

Appears when you try to do audio dubbing on a tape recorded in 16-bit audio or 12-bit, 4-channel mode ( 88).

CHECK THE CASSETTE
[AUDIO MODE]

Refer to p.104

CONDENSATION
HAS BEEN DETECTED

Appears when the camcorder detects a blank section of a tape during audio dubbing or AV insert (MV500i only) ( 85, 88).

CHECK THE CASSETTE
[BLANK]

E

Appears immediately after you start recording, and the video heads are badly contaminated. Make sure to clean the video heads when this caution appears. ( 103)

HEADS DIRTY,
USE CLEANING CASSETTE

Specifications

MV500/MV500i

Power Supply (rated): 7.4 V DC

Power Consumption (while recording with the AF turned on):

3.1 W (Using viewfinder),

3.9 W (Using LCD screen)

Television system: CCIR standard (625 lines, 50 fields) PAL colour signal

Video recording system:

2 rotary heads, helical scanning DV system (Consumer digital VCR SD system)

Digital component recording

Audio recording system:

PCM digital sound: 16 bit (48 kHz/2 ch), 12 bit (32 kHz/4 ch)

Image sensor: 1/6" CCD (charge coupled device), approx. 540,000 pixels (approx. 340,000 effective pixels)

Tape format:

Videocassettes bearing the ^{Mini} DV mark.

Tape speed:

SP: 3/4 ips (18.83 mm/s),

LP: 1/2 ips (12.57 mm/s)

Maximum recording time

(with an 80 min. cassette):

SP: 80 min., LP: 120 min.

Fast forward/ rewind time:

Approx. 2 min. 20 sec.

(with a 60 min. cassette)

Lens:

F/1.6–2.9, 18× power zoom, f=2.8–50.4 mm (equivalent to 48–864 mm in 35 mm format)

Focusing system: TTL autofocus, manual focusing possible

Minimum focusing distance:

1 m (3ft 3³/₈ in) (1 cm (3⁸/₈ in) on maximum wide angle)

Maximum shutter speed: 1/8,000 sec.

Minimum illumination:

0.5 lx (using the Night program)

Recommended illumination:

More than 100 lx

Filter diameter: 30.5 mm

Viewfinder:

0.44 in, TFT colour LCD, approx. 113,000 pixels

LCD screen:

2.5 in measured diagonally, TFT colour, approx. 112,000 pixels

Microphone:

Stereo electret condenser microphone

DV Terminal*:

Special 4-pin connector (conforms to IEEE1394)

AV/headphones terminal:

ø 3.5 mm minijack

Audio input**:

–10 dBV/at least 40 kohms, (L, R), unbalanced

output: –10 dBV (47 kohm

load)/ less than 3 kohms, unbalanced

Video: 1 V_{p-p}/75 ohms unbalanced

S-video terminal*:

1 V_{p-p} (Y signal), 0.3 V_{p-p} (C signal)

MIC terminal input: ø 3.5 mm stereo

minijack, –57 dBV (with 600 ohm mic)/ at least 5 kohms

LANC terminal: ø 2.5 mm mini minijack

Operating temperature range:

0°–40°C (32°–104°F)

Dimensions: 58 × 99 × 144 mm

(2 1/4 × 3 7/8 × 5 5/8 in)

Weight: 525 g (11b 2 1/2 oz)

BP-508 Battery Pack

Battery type:

Rechargeable lithium ion battery

Rated voltage: 7.4 V DC

Operating temperature:

0°–40°C (32°–104°F)

Battery capacity: 800 mAh

Dimensions: 38 × 21 × 55 mm

(1 1/2 × 7/8 × 2 1/8 in)

Weight: 65 g (2 1/4 oz)

* MV500: Output only.

MV500i: Input/output.

** MV500i only.

Weight and dimensions are approximate.

Errors and omissions excepted.

Subject to change without notice.

E

Additional
Information

Index

E

16:9, 21

A

Abroad, Using the Camcorder, 103
Accessories, 5, 109
Adapter, AC, 11-13, 15
AE Programs, 52
AE Shift, 65
Analog-digital converter, 83
Analog line-in, 81
Audio Dubbing, 88
Audio Mix, 93
Audio Mode, 61
Audio Output, 93
Audio Recording
 and Playback, 61, 93
Audio/Video Terminal, 32
Auto, 54
Autofocus, 68
AV Insert, 85

B

Backup Battery, 100
Basic Recording, 18
Battery Charger, 14-15
Battery Pack, 12, 14-15, 98
Beep, 21

C

Cables, 5, 33
Cassettes, 16
Charging the Battery Pack,
 12, 14-15, 98
Choosing a Recording Program, 52
Cleaning the Camcorder, 102
Clock, 48
Condensation, 104
Connecting to a PC, 95
Connection to TV or VCR, 32

D

Data Code, 71
Date and Time, 48
Date Search, 74
Demo mode, 22

Digital Effects, 56
Digital Zoom, 23
DV Dubbing, 77

E

Easy Recording, 54
Editing to a VCR, 76
Effects, 58
External Microphone, 61, 88

F

Faders, 57
Fast Forward, 28
Feedback, 35
Finding Your Way Around
 the MV500/MV500i, 7
Focusing, 68

H

Head Cleaning, 103
Headphones, 32

I

Image Stabilizer, 51
Introducing the
 MV500/MV500i, 6

L

LANC, 76
LCD Screen, 25
Lens Cap, 96
Loading Cassettes, 16
Low Light, 55
LP Mode, 20

M

Maintenance, 101
Making Better Videos, 36
Manual Focus, 68
Menus, 39
Microphone, 61, 88
Monitor Recording, 27

N

Night, 55

O

Optional Accessories, 109

P

Pause, Record, 18
 PC Connection, 95
 Photo Search, 74
 Playback, 28
 Playback Connection, 32
 Playback Pause, 29
 Portrait, 54
 Power Adapter, 11-13, 15
 Powering Your Camcorder, 11
 Pre-Marked Position, 75
 Preparing the Camcorder, 96
 Problems, 105

R

Recharging the Battery Pack, 99
 Recording, 18
 Recording Programs, 52
 Record Pause Mode, 18
 Record Review, 38
 Record Search, 38
 Remote Control, 43
 Remote Sensor, 43-44
 Rewind, 28

S

S1 video terminal, 34
 Sand & Snow, 55
 Screen Displays, 111
 Self-Timer, 63
 Shutter Speed, 66
 Speaker, 31
 Specifications, 13, 117
 SP Mode, 20
 Sports, 54
 Spotlight, 54
 Still Picture, 49

Storage, 102
 S-video, 34
 System Diagram, 108

T

Tape Protection, 17
 Telephoto, 23
 Temperature,
 13, 98, 100, 117
 Time Code, 114
 Time Zone, 46
 Tips for Making Better Videos, 36
 Tripod, 36
 Troubleshooting, 105
 TV, 32, 111

V

VCR, 32
 Video Heads, 103
 Video Light, 110
 Videocassettes, 16
 Viewfinder, 96, 102

W

White Balance, 69
 Wide-angle, 23
 Wide screen TV, 21
 Wind Screen, 62
 Wireless Controller, 43

Z

Zero Set Memory, 75
 Zooming, 23

Menu at a Glance

Use the list below to quickly navigate the camcorder's menu. Functions are listed alphabetically.

E

Function	First make sure the camera is set to...		Then select it from this submenu and set.
	CAMERA	PLAY (VCR)	
16:9 effect	<input type="radio"/>		CAM.SET UP
6-sec. Date		<input type="radio"/>	DISP.SET UP
Audio dub*		<input type="radio"/>	VCR SET UP
Audio mode	<input type="radio"/>	<input type="radio"/> *	VCR SET UP
AV/headphones	<input type="radio"/>	<input type="radio"/>	VCR SET UP
AV → DV out*		<input type="radio"/>	VCR SET UP
Beep	<input type="radio"/>	<input type="radio"/>	SYSTEM
Brightness	<input type="radio"/>	<input type="radio"/>	DISP.SET UP
Data code		<input type="radio"/>	DISP.SET UP
Date/time display	<input type="radio"/>		DISP.SET UP
Date/time select		<input type="radio"/>	DISP.SET UP
Date/time set	<input type="radio"/>		SYSTEM
Demo mode	<input type="radio"/>		DISP.SET UP
Digital zoom	<input type="radio"/>		CAM.SET UP
Displays		<input type="radio"/>	DISP.SET UP
Image stabilizer	<input type="radio"/>		CAM.SET UP
Mirror mode	<input type="radio"/>		DISP.SET UP
Output channel		<input type="radio"/>	VCR SET UP
Record mode	<input type="radio"/>	<input type="radio"/> *	VCR SET UP
Remote sensor mode	<input type="radio"/>	<input type="radio"/>	SYSTEM

Additional
Information

Function	First make sure the camera is set to...		Then select it from this submenu and set.
	CAMERA	PLAY (VCR)	
Shutter speed	<input type="radio"/>		CAM.SET UP
Time zone/DST	<input type="radio"/>		SYSTEM
TV screen	<input type="radio"/>		DISP.SET UP
White balance	<input type="radio"/>		CAM.SET UP
Wind screen	<input type="radio"/>	<input type="radio"/>	VCR SET UP

* MV500i only



DIGITAL VIDEO CAMCORDER

Instruction Manual

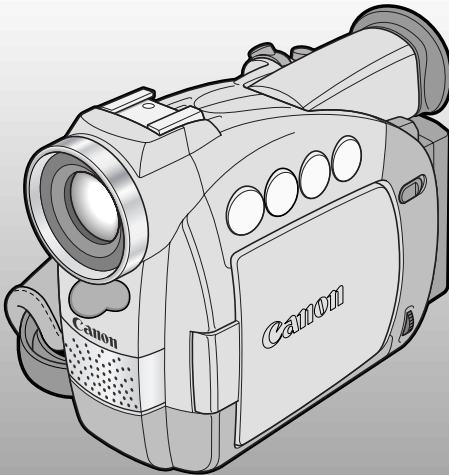

Introduction

Mastering
the Basics

Using the Full
Range of Features

Editing

Additional
Information

Canon

MiniDV Digital
Video
Cassette

MV500/MV500i

This instruction book explains the use of the MV500 and MV500i camcorders. The main difference between these models is that the MV500i includes a DV Recording and Analog Line-in Recording function. Please note that illustrations and explanations in this instruction book refer mainly to the MV500 model.

[Downloaded From VideoCamera-Manual.com](http://www.VideoCamera-Manual.com) Manuals

Download from www.Somanuals.com. All Manuals Search And Download.

Free Manuals Download Website

<http://myh66.com>

<http://usermanuals.us>

<http://www.somanuals.com>

<http://www.4manuals.cc>

<http://www.manual-lib.com>

<http://www.404manual.com>

<http://www.luxmanual.com>

<http://aubethermostatmanual.com>

Golf course search by state

<http://golfingnear.com>

Email search by domain

<http://emailbydomain.com>

Auto manuals search

<http://auto.somanuals.com>

TV manuals search

<http://tv.somanuals.com>