

Canon

Digital Video Camcorder
Instruction Manual

English

Camescope vidéo numérique
Manuel d'instruction

Français

Videocámara digital
Manual de Instrucciones

Español

optura 20 / optura 10

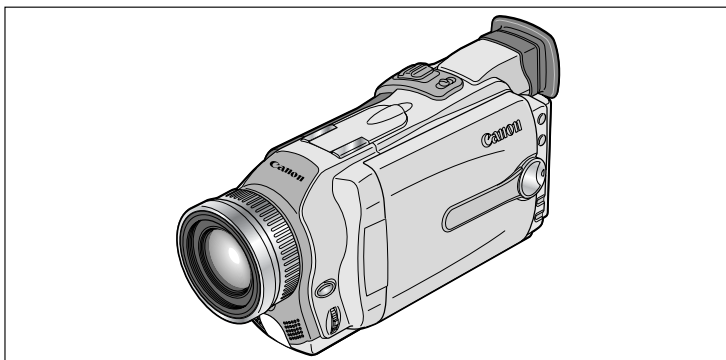

Mini **DV** Digital
Video
Cassette

BUBBLE JET
DIRECT

DIRECT PRINT

This instruction manual covers the OPTURA20 and OPTURA10. Please note that illustrations and explanation in this manual are based on the OPTURA20.

Ce manuel d'instruction traite des modèles OPTURA20 et OPTURA10. Veuillez noter que les illustrations et les explications contenues dans ce manuel sont basées sur le OPTURA20.

Este manual de instrucciones cubre la OPTURA20, y la OPTURA10. Tenga en cuenta que las ilustraciones y las explicaciones de este manual se basan en la OPTURA20.

NTSC

Important Usage Instructions

E

WARNING:



TO REDUCE THE RISK OF FIRE OR ELECTRIC SHOCK, DO NOT EXPOSE THIS PRODUCT TO RAIN OR MOISTURE.

WARNING:



TO REDUCE THE RISK OF ELECTRIC SHOCK AND TO REDUCE ANNOYING INTERFERENCE, USE THE RECOMMENDED ACCESSORIES ONLY.

COPYRIGHT WARNING:

Unauthorized recording of copyrighted materials may infringe on the rights of copyright owners and be contrary to copyright laws.

Digital Video Camcorder, OPTURA20/OPTURA10 systems

This device complies with Part 15 of the FCC Rules. Operation is subject to the following two conditions: (1) This device may not cause harmful interference, and (2) this device must accept any interference received, including interference that may cause undesired operation.

Note: This equipment has been tested and found to comply with the limits for class B digital device, pursuant to Part 15 of the FCC Rules. These limits are designed to provide reasonable protection against harmful interference in a residential installation. This equipment generates, uses and can radiate radio frequency energy and, if not installed and use in accordance with the instructions, may cause harmful interference to radio communications. However, there is no guarantee that interference will not occur in a particular installation. If this equipment does cause harmful interference to radio or television reception, which can be determined by turning the equipment off and on, the user is encouraged to try to correct the interference by one or more of the following measures:

- Reorient or relocate the receiving antenna.
- Increase the separation between the equipment and receiver.
- Connect the equipment into an outlet on a circuit different from that to which the receiver is connected.
- Consult the dealer or an experienced radio/TV technician for help.

Use of shielded cable is required to comply with class B limits in Subpart B of Part 15 of FCC Rules.

Do not make any changes or modifications to the equipment unless otherwise specified in the manual.

If such changes or modifications should be made, you could be required to stop operation of the equipment.

Canon U.S.A. Inc.

One Canon Plaza, Lake Success, NY 11042, U.S.A.

Tel No. (516)328-5600

CAUTION:

TO PREVENT ELECTRIC SHOCK, MATCH WIDE BLADE OF PLUG TO WIDE SLOT, FULLY INSERT.

Important Warning



The lightning flash with arrowhead symbol, within an equilateral triangle, is intended to alert the user to the presence of uninsulated "dangerous voltage" within the product's enclosure, that may be of sufficient magnitude to constitute a risk of electric shock to persons.

CAUTION:

TO REDUCE THE RISK OF ELECTRIC SHOCK, DO NOT REMOVE COVER (OR BACK). NO USER-SERVICEABLE PARTS INSIDE. REFER SERVICING TO QUALIFIED SERVICE PERSONNEL.



The exclamation point, within an equilateral triangle, is intended to alert the user to the presence of important operating and maintenance (servicing) instructions in the literature accompanying the product.

IMPORTANT SAFETY INSTRUCTIONS

In these safety instructions the word “product” refers to the Canon Digital Video Camcorder OPTURA20/OPTURA10 and all its accessories.

1. Read Instructions — All the safety and operating instructions should be read before the product is operated.
2. Retain Instructions — The safety and operating instructions should be retained for future reference.
3. Heed Warnings — All warnings on the product and in the operating instructions should be adhered to.
4. Follow Instructions — All operating and maintenance instructions should be followed.
5. Cleaning — Unplug this product from the wall outlet before cleaning. Do not use liquid or aerosol cleaners. The product should be cleaned only as recommended in this manual.
6. Accessories — Do not use accessories not recommended in this manual as they may be hazardous.
7. Avoid magnetic or electric fields — Do not use the camera close to TV transmitters, portable communication devices or other sources of electric or magnetic radiation. They may cause picture interference, or permanently damage the camera.
8. Water and Moisture — Hazard of electric shock — Do not use this product near water or in rainy/moist situations.
9. Placing or Moving — Do not place on an unstable cart, stand, tripod, bracket or table. The product may fall, causing serious injury to a child or adult, and serious damage to the product.

A product and cart combination should be moved with care. Quick stops, excessive force, and uneven surfaces may cause the product and cart combination to overturn.



10. Power Sources — The CA-570 Compact Power Adapter should be operated only from the type of power source indicated on the marking label. If you are not sure of the type of power supply to your home, consult your product dealer or local power company. Regarding other power sources such as battery power, refer to instructions in this manual.
11. Polarization — The CA-570 Compact Power Adapter is equipped with a polarized 2-prong plug (a plug having one blade wider than the other).
The 2-prong polarized plug will fit into the power outlet only one way. This is a safety feature. If you are unable to insert the plug fully into the outlet, try reversing the plug. If the plug still fails to fit, contact your electrician to replace your obsolete outlet. Do not defeat the safety purpose of the polarized plug.
12. Power Cord Protection — Power cords should be routed so that they are not likely to be walked on or pinched by items placed upon or against them. Pay particular attention to plugs and the point from which the cords exit the product.
13. Outdoor Antenna Grounding — If an outside antenna is connected to the product, be sure the antenna is grounded so as to provide some protection against voltage surges and built-up static charges. Section 810 of the National Electrical Code, ANSI / NFPA No. 70—1984, provides information with respect to proper grounding of the mast and supporting structure, grounding of the lead-in wire to an antenna discharge unit, size of grounding conductors, location of antenna discharge unit, connection to grounding electrodes, and requirements for the grounding electrode. See figure 1.

Fig. 1

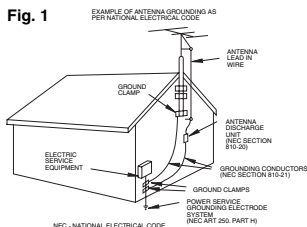

14. **Lightning** — For added protection of this product during a lightning storm, or when it is left unattended and unused for long periods of time, disconnect it from the wall outlet and disconnect the antenna. This will prevent damage to the product due to lightning and power-line surges.
15. **Overloading** — Do not overload wall outlets and extension cords as this can result in a risk of fire or electric shock.
16. **Objects and Liquid Entry** — Never push objects of any kind into this product through openings as they may touch dangerous voltage points or short out parts that could result in a fire or electric shock. Be careful not to spill liquid of any kind onto the product.
17. **Servicing** — Do not attempt to service this product yourself as opening or removing covers may expose you to dangerous voltage or other hazards. Refer all servicing to qualified service personnel.
18. **Damage Requiring Service** — Disconnect this product from the wall outlet and all power sources including battery, and refer servicing to qualified service personnel under the following conditions:
- When the power-supply cord or plug is damaged.
 - If any liquid has been spilled onto, or objects have fallen into, the product.
 - If the product has been exposed to rain or water.
 - If the product does not operate normally even if you follow the operating instructions. Adjust only those controls that are covered by the operation instructions. Improper adjustment of other controls may result in damage and will often require extensive work by a qualified technician to restore the product to its normal operation.
 - If the product has been dropped or the cabinet has been damaged.
 - When the product exhibits a distinct change in performance. This indicates a need for service.
19. **Replacement Parts** — When replacement parts are required, be sure the service technician has used replacement parts that are specified by Canon or that have the same characteristics as the original part. Unauthorized substitutions may result in fire, electric shock or other hazards.
20. **Safety Check** — Upon completion of any service or repairs to this product, ask the service technician to perform safety checks to determine that the product is in safe operating order.

When replacement of power supply is required, please return it to the responsible nearest Canon Service Center and please replace it with the same type number CA-570.

The Adapter can be used with a power supply between 100 and 240 V AC. For areas where 120 V AC power is not used, you will need a special plug adapter. Contact your nearest Canon Service Center for further information.

Reference Guide

The following manuals are supplied with the camcorder:

○ **Digital Video Camcorder OPTURA20/OPTURA10 Instruction Manual**

This manual explains the camcorder operations from basic video recording to the use of the full range of features.

○ **DIGITAL VIDEO SOLUTION DISK Software Instruction Manual**

This manual explains how to download images from the memory card to a computer using the supplied USB cable. You can add sample images for Card Mix and My Camera settings from the supplied DIGITAL VIDEO SOLUTION DISK.

○ **Windows XP Users Only**

DV NETWORK SOLUTION DISK Software Instruction Manual

This manual explains how to download/upload images from/to the memory card using a DV (IEEE1394) cable. You can also perform videoconference and file transfer over the Internet using the provided software. Available functions depend upon the camcorder model of your contact and networking environment.

Trademark Acknowledgements

- Canon and Bubble Jet are registered trademarks of Canon Inc.
- Mini **DV** is a trademark.
- **SD** logo is a trademark.
- Windows® is either a registered trademark or trademark of Microsoft Corporation in the United States and/or other countries.
- Other names and products not mentioned above may be registered trademarks or trademarks of their respective companies.

Table of Contents

Introduction

Reference Guide	5
Thank You for Choosing a Canon	9
Introducing the OPTURA20/OPTURA10	10
Components Guide	11

Mastering the Basics

Preparations

Using a Household Power Source	15
Attaching and Charging the Battery Pack	16
Installing the Backup Battery	19
Preparing the Camcorder	20
Loading a Cassette	22
Using the Wireless Controller	24
Setting the Time Zone, Date and Time	25

Basic Recording

Recording Movies on a Tape	28
Zooming	30
Using the LCD Screen	32
Searching and Reviewing when Recording	35
Tips for Making Better Videos	36

Basic Playback

Playing Back a Tape	37
Playing Back on a TV Screen	40

Using the Full Range of Features

General

Menus and Settings	43
Changing the Remote Sensor Mode	48
Customizing the Camcorder	49
Other Camcorder Settings	50

Recording

Changing the Recording Mode (SP/LP)	52
Recording Still Images on the Tape	53
Using the Recording Programs	55
Using Digital Effects	59
Using the Multi-Image Screen	65
Turning Off the Image Stabilizer	67
Recording With the Self-Timer	68
Audio Recording	69
Using the VL-3 Video Light (Optional)	71
Using the VFL-1 Video Flash Light (Optional)	72
Using the DM-50 Microphone (Optional)	75

Manual Adjustments

Adjusting the Focus Manually	76
Adjusting Exposure Manually.....	78
Setting the Shutter Speed.....	79
Setting the White Balance	81

Playback

Magnifying the Image.....	83
Displaying the Data Code	84
Photo Search/Date Search.....	86
Returning to a Pre-marked Position	87

Editing

Recording to a VCR or Digital Video Device	88
Recording from Analog Video Devices (VCR, TV or Camcorder)	90
Recording from Digital Video Devices (DV Dubbing).....	91
Converting Analog Signals into Digital Signals (Analog-Digital Converter)	93
Replacing Existing Scenes (AV Insert)	95
Audio Dubbing.....	97
Connecting to a Computer Using a DV (IEEE1394) Cable	100

Using a Memory Card





Inserting and Removing the Memory Card	101
Selecting the Image Quality/Size	102
Recording Still Images on a Memory Card	105
Recording Panoramic Images (Stitch Assist Mode)	111
Recording Motion JPEG Movies on a Memory Card.....	113
Playing Back a Memory Card	115
Protecting Images	118
Erasing Images	119
Selecting Still Images for Printing (Print Order)	120
Printing with the Direct Print Function.....	122
Combining Images (Card Mix)	128
Copying Still Images.....	132
Formatting a Memory Card	134
Connecting to a Computer Using a USB Cable	135
Creating a Start-up Image	136
Memory Card Information	137

Additional Information

Screen Displays	140
List of Messages	144
Maintenance.....	147
Troubleshooting	150
System Diagram	153
Optional Accessories	154
Specifications	157
Index	159

Conventions Used in This Manual

Operating Modes





Operating Mode	Position of the POWER Switch	Position of the TAPE/CARD Switch
CAMERA	CAMERA	 (TAPE)
PLAY (VCR)	PLAY (VCR)	 (TAPE)
CARD CAMERA	CAMERA	 (CARD)
CARD PLAY (VCR)	PLAY (VCR)	 (CARD)

Available functions depend upon the operating mode. It is indicated as follows:

 : Function can be used in this mode.

 : Function cannot be used in this mode.

Other Symbols and References

-  : Reference page number.
-  : Functions to be operated on the body of the camcorder.
-  : Functions to be operated on the wireless controller.
-  : Additional topics that complement the basic operating procedures.
-  : Precautions related to the camcorder operation.
- Capital letters are used to refer to buttons on the camcorder or the wireless controller.
- [] are used to refer to menu items displayed on the screen.
- "Screen" refers to the LCD and the viewfinder screen.

The serial number of this product can be found at the battery attachment unit of the camcorder. Write down the number and other information here and retain this book as a permanent record of your purchase to aid identification in case of theft.

Date of Purchase:

Model Name: OPTURA20/OPTURA10

Purchased From:

Serial No.:

Dealer Address:







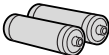

Dealer Phone No.:

Thank You for Choosing a Canon

The Canon OPTURA20/OPTURA10 provides a full range of options and functions. We recommend reading this manual thoroughly before you use the camcorder. It will help you to become more familiar with your camcorder, and learn how to operate it properly.

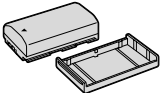
We suggest that you master the basic operations of the camcorder first, before moving on to its full range of features.

Checking Supplied Accessories

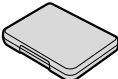
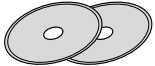
WL-D79 Wireless Controller 	Two AA Batteries 	Lens Cap and Lens Cap Cord 	SS-800 Shoulder Strap 
Lithium Button Battery CR2025 	Optura20 BP-512 Battery Pack, Optura10 BP-508 Battery Pack 	CA-570 Compact Power Adapter (incl. power cord) 	STV-250N Stereo Video Cable 
IFC-300PCU USB Cable 	SDC-8M SD Memory Card (containing sample images) 	Case for SD Memory Card 	DIGITAL VIDEO SOLUTION DISK DV NETWORK SOLUTION DISK 

Introducing the **OPTURA20/OPTURA10**

E

Megapixel CCD

The OPTURA20 and OPTURA10 incorporate a megapixel CCD, allowing recording of high-resolution still images on a memory card.

16× Optical and 320× Digital Zoom (Card: 15× Optical and 60× Digital Zoom)

Image Stabilizer

Stabilizes your recordings even in long telephoto shots.

Night Mode

Allows recording even in dark places. The Night mode adjusts automatically to the optimum shutter speed.

Super Night Mode and Low Light Plus Mode (OPTURA20)

With the OPTURA20's Super Night mode (in CAMERA mode) and Low Light Plus mode (in CARD CAMERA mode), you can keep on shooting without turning the lights on. The assist lamp (White LED) lights up to illuminate the subject.

Still Images

Just press the photo button to capture still images like photographs.

My Camera Settings

You can personalize your camcorder by customizing the start-up image and camcorder sounds.

Analog Line-in Recording/ Audio Dubbing/AV Insert Editing

Advanced Accessory Shoe

Simply slide Canon's VFL-1 Video Flash Light, DM-50 Directional Stereo Microphone or VL-3 Video Light into the accessory shoe; the camcorder provides power and connections.

Digital Effects

Show your creativity by using the special effects and faders. The multi-image screen captures moving subjects in 4, 9 or 16 sequences of still images.

Memory Card

You can record images on a SD Memory Card or MultiMediaCard. Images recorded in Stitch Assist mode can be merged into one panoramic scene with the supplied software.

Direct Print

You can print still images by connecting to a Canon printer with Direct Print function.

USB Terminal

Allows transfer of memory card data to a computer with built-in USB port. You can organize and edit images on your computer using the supplied software.

IEEE1394 DV Terminal

The DV terminal allows high-quality transfer with virtually no deterioration in quality of images. You can edit images by connecting the camcorder to a PC with IEEE1394 terminal. Windows XP users can use the supplied software to perform videoconference and file transfer over the Internet*.

* Windows Messenger 4.5 or higher required.

Components Guide

OPTURA20/OPTURA10

E

Introduction

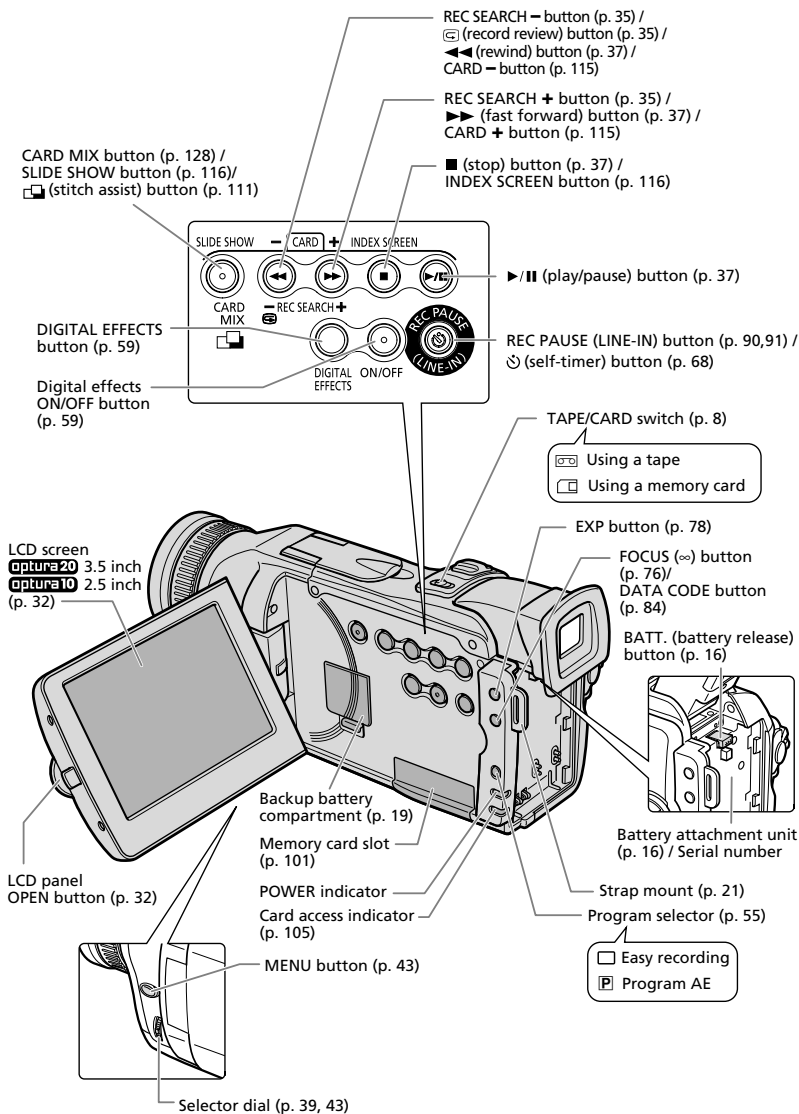

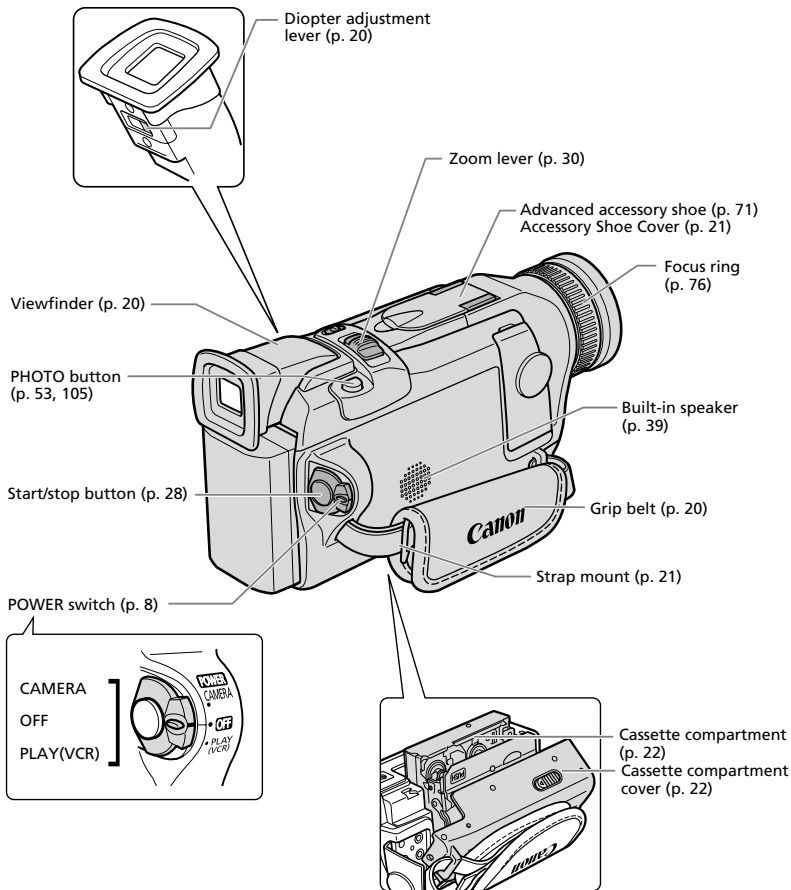

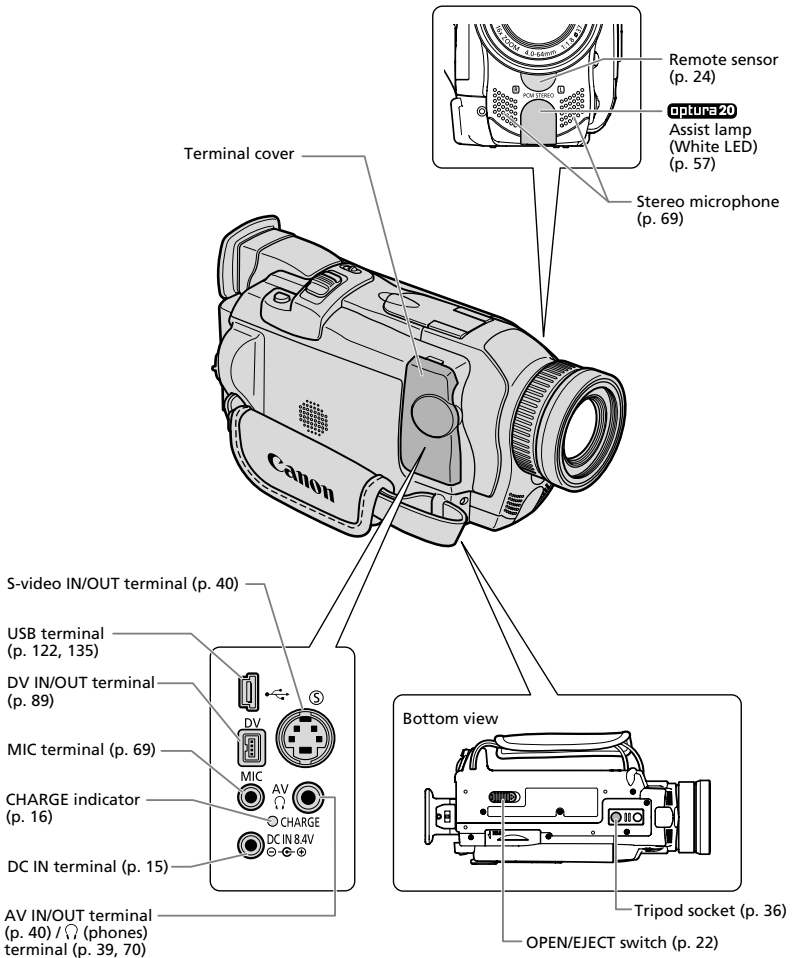

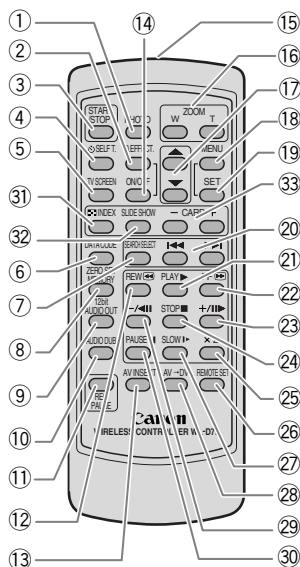

- | | |
|---|------------------------------|
| ① PHOTO button (p. 53, 105) | ⑱ MENU button (p. 43) |
| ② D. EFFECTS (Digital effects) button (p. 59) | ⑲ SET button (p. 43) |
| ③ START/STOP button (p. 28) | ⑳ Search buttons (p. 86) |
| ④ SELF T. button (p. 68) | ㉑ PLAY button (p. 37) |
| ⑤ TV SCREEN button (p. 140) | ㉒ FF button (p. 37) |
| ⑥ DATA CODE button (p. 84) | ㉓ +/ button (p. 38) |
| ⑦ SEARCH SELECT button (p. 86) | ㉔ STOP button (p. 37) |
| ⑧ ZERO SET MEMORY button (p. 87) | ㉕ x 2 button (p. 38) |
| ⑨ 12bit AUDIO OUT button (p. 99) | ㉖ REMOTE SET button (p. 48) |
| ⑩ AUDIO DUB. button (p. 98) | ㉗ SLOW button (p. 38) |
| ⑪ REC PAUSE button (p. 90) | ㉘ AV → DV button (p. 94) |
| ⑫ REW button (p. 37) | ㉙ -/ button (p. 38) |
| ⑬ AV INSERT button (p. 96) | ㉚ PAUSE button (p. 38) |
| ⑭ Digital effects ON/OFF button (p. 59) | ㉛ INDEX button (p. 116) |
| ⑮ Transmitter | ㉜ SLIDE SHOW button (p. 116) |
| ⑯ Zoom buttons (p. 30) | ㉝ CARD -/+ buttons (p. 115) |
| ⑰ Select buttons (p. 43) | |

Using a Household Power Source

You can operate the camcorder from a household power source using the supplied power adapter. The power adapter converts current from a power outlet (100-240 V AC, 50/60 Hz) to the DC current used by the camcorder.

1. Turn the **POWER** switch to **OFF**.
2. Connect the power cord to the power adapter.
3. Plug the power cord into a power outlet.
4. Connect the power adapter to the camcorder's **DC IN** terminal.

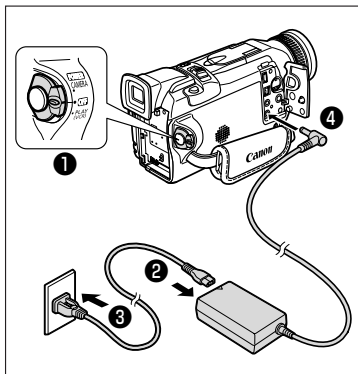

5. After use, turn off the camcorder and disconnect the power adapter from the camcorder. Unplug the power cord from the power outlet and disconnect it from the adapter.



- Turn off the camcorder before connecting or disconnecting the power adapter.
- If the adapter is used close to a TV, it may cause picture interference. Move the adapter away from the TV or the antenna cable.
- Do not connect any products that are not expressly recommended to the camcorder's DC IN terminal or to the power adapter.
- You may hear some noise from the power adapter during use. This is not a malfunction.

Attaching and Charging the Battery Pack

E

Charge the battery pack with the supplied power adapter before you use the camcorder for the first time and subsequently when the message "CHANGE THE BATTERY PACK" appears.

1. Turn the **POWER** switch to **OFF**.
2. Move the **viewfinder** upward.
3. Attach the battery pack to the camcorder.

- Remove the terminal cover of the battery pack.
- Align the end of the battery pack with the line on the camcorder, press lightly and slide it in the direction of the arrow until it clicks.

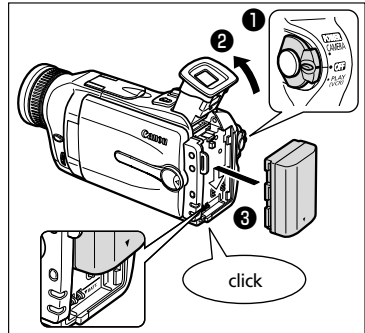

4. Connect the power cord to the adapter.
5. Plug the power cord into a power outlet.
6. Connect the power adapter to the camcorder's DC IN terminal.
7. When charging is complete, disconnect the power adapter from the camcorder. Unplug the power cord from the power outlet and disconnect it from the adapter.
8. Remove the battery pack after use.

Press the BATT. button to remove the battery.

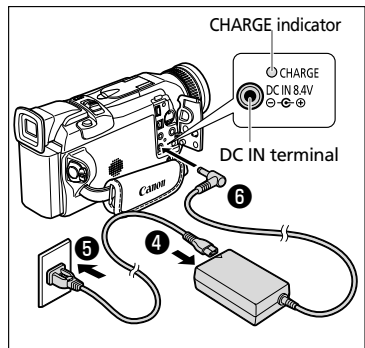

○ The battery pack may be defective when the CHARGE indicator flashes rapidly.

○ The CHARGE indicator informs you about the charge status.

0-50%: Flashes once every second

More than 50%: Flashes twice every second

100%: Glows steadily

○ Do not disconnect and reconnect the power cord while charging a battery pack. The battery pack may not be charged correctly even if the CHARGE indicator glows steady. The battery pack may also not be charged correctly when a power outage occurs during charging. Remove the battery pack and attach it back to the camcorder.

Charging, Recording and Playback Time

Below times are approximate and vary according to the charging, recording or playback conditions.

Charging Time

Battery Pack	Charging Time
BP-508 (OPTURA10)	110 min.
BP-512 (OPTURA20/optional)	120 min.
BP-511 (Optional)	120 min.
BP-522 (Optional)	210 min.
BP-535 (Optional)	310 min.

- Charge the battery pack in temperatures between 41° F and 104° F (5° C and 40° C).
- A lithium ion battery pack can be charged at any charge state. Unlike conventional battery packs, you do not need to completely use or discharge it before charging.

Recording Time

Battery Pack	Maximum Recording Time		Typical Recording Time*	
	Using the viewfinder	Using the LCD	Using the viewfinder	Using the LCD
optura20				
BP-512 (Supplied)	150 min.	110 min.	80 min.	60 min.
BP-511 (Optional)	150 min.	110 min.	80 min.	60 min.
BP-522 (Optional)	320 min.	230 min.	175 min.	125 min.
BP-535 (Optional)	520 min.	370 min.	280 min.	200 min.
optura10				
BP-508 (Supplied)	80 min.	65 min.	45 min.	35 min.
BP-512 (Optional)	150 min.	115 min.	80 min.	65 min.
BP-511 (Optional)	150 min.	115 min.	80 min.	65 min.
BP-522 (Optional)	320 min.	235 min.	175 min.	130 min.
BP-535 (Optional)	520 min.	375 min.	280 min.	205 min.

* Approximate times for recording with repeated operations such as start/stop, zooming, power on/off. Actual time may be shorter.

- We recommend that you prepare battery packs 2 to 3 times longer than you think you might need.
- To conserve battery charge, turn off the camcorder instead of leaving it in record pause mode.

Playback Time

Battery Pack	optura20	optura10
	(Using the LCD)	
BP-508 (OPTURA10)	–	70 min.
BP-512 (OPTURA20/optional)	130 min.	140 min.
BP-511 (Optional)	130 min.	140 min.
BP-522 (Optional)	260 min.	295 min.
BP-535 (Optional)	430 min.	470 min.

How much power is left?

The battery symbols indicate the charge status of the battery pack.

E

When the battery pack is empty, "CHANGE THE BATTERY PACK" appears for 4 seconds and  starts flashing.

The battery charge indicators are not constant – they vary according to the condition under which battery pack and camcorder are used.



Battery Pack Handling Precautions

DANGER!

Treat the battery pack with care.

- Keep it away from fire (or it might explode.)
- Do not expose the battery pack to temperature higher than 140° F (60° C). Do not leave it near a heater or inside a car in hot weather.
- Do not try to disassemble or modify it.
- Do not drop or knock it.
- Do not get it wet.

- Charged battery packs continue to discharge naturally. Therefore, charge them on the day of use, or the day before, to ensure a full charge.
- Attach the terminal cover whenever a battery pack is not in use. Contact to metallic objects may cause a short circuit and damage the battery pack.
- Dirty terminals may cause a poor contact between the battery pack and the camcorder. Wipe the terminals with a soft cloth.
- Since storing a charged battery pack for a long time (about 1 year) can shorten its lifecycle or affect performance, we recommend to discharge the battery pack fully and to store it in a dry place at temperatures no higher than 86° F (30° C). If you do not use the battery pack for long periods, charge and discharge it fully at least once a year. If you have more than 1 battery pack, perform these precautions at the same time for all battery packs.
- Although the battery pack's operating temperature range is from 32° F to 104° F (0° C to 40° C), the optimal range is from 50° F to 86° F (10° C to 30° C). At cold temperatures, performance will temporarily decline. Warm it in your pocket before use.
- Replace the battery pack if the usable time after full charge diminishes substantially at normal temperatures.

Installing the Backup Battery

The backup battery allows the camcorder to retain date, time and other camcorder settings while the power source is disconnected. Power the camcorder from a household power source or with a battery pack when replacing the backup battery to retain the setting.

1. Open the backup battery cover.
2. Insert the lithium battery with the + side facing outward.

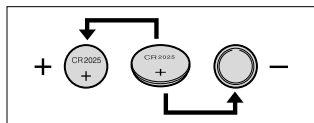

3. Close the cover.

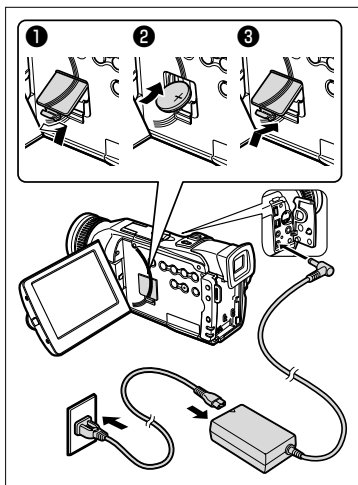

WARNING!

- The battery used in this device may present a fire or chemical burn hazard if mistreated. Do not recharge, disassemble, heat above 212° F (100° C) or incinerate the battery.
- Replace the battery with a CR2025 made by Panasonic, Hitachi Maxell, Sony, Sanyo, or with Duracell2025. Use of other batteries may present a risk of fire or explosion.



- Do not pick up the battery using tweezers or other metal tools as this will cause a short circuit.
- Wipe the battery with a clean dry cloth to ensure proper contact.
- Keep the battery out of reach of children. If it is swallowed, seek medical assistance immediately. The battery case may break and the battery fluids may damage stomach and intestines.
- Do not disassemble, heat or immerse the battery in water to avoid the risk of explosion.



The backup battery has a life span of about a year.  flashes to inform you that it needs to be replaced.

Download from Www.Somanuals.com. All Manuals Search And Download.

Preparing the Camcorder

E

Adjusting the Viewfinder (Diopter Adjustment)

1. Turn on the camcorder and keep the LCD panel closed to adjust the viewfinder.
2. Adjust the diopter adjustment lever.

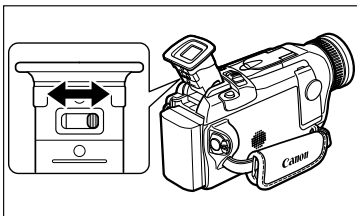

Do not leave the viewfinder exposed to direct sunlight as it may melt (due to concentration of light by the lens). Adjust the angle of the viewfinder to prevent sunlight from entering.

Attaching the Lens Cap

1. Attach the cord to the lens cap.
2. Pass the grip belt through the loop on the cord.

Press the buttons on the lens cap when attaching/removing it. Hook the lens cap on the grip belt while you are recording, and place it over the lens when you have finished.

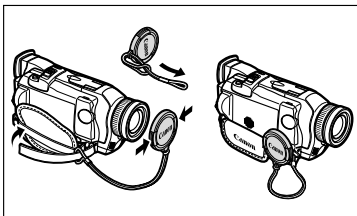

Fastening the Grip Belt

Hold the camcorder with your right hand and adjust the belt with your left.

Adjust the grip belt so that you can reach the zoom lever and photo button with your index finger, and the start/stop button with your thumb.

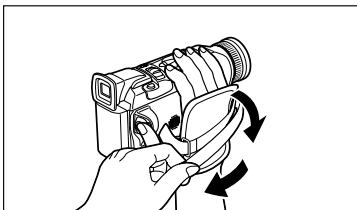

Attaching the Shoulder Strap

For extra security and portability, attach the shoulder strap before using the camcorder.

Pass the ends through the strap mount and adjust the length of the strap.

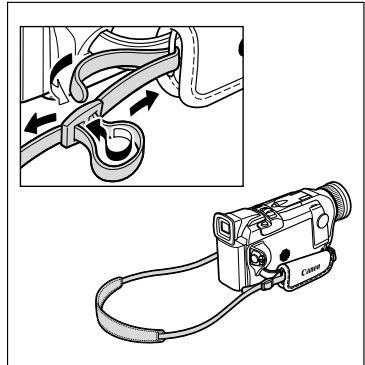

Removing and Attaching the Accessory Shoe Cover

Remove the accessory shoe cover when attaching an accessory to the advanced accessory shoe.

1. Lift the cover with your nail and remove the cover.

Hook the cover on the lens cap cord or grip belt while using the accessory shoe.

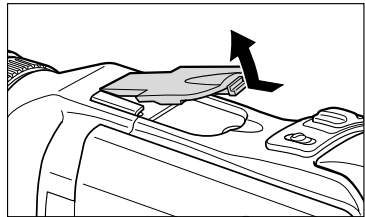

2. Insert the end into the accessory shoe and attach it onto the shoe.

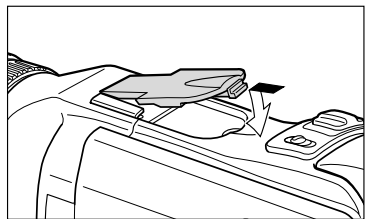

Loading a Cassette

E Use only videocassettes marked with the Mini DV logo.

Loading and Unloading

1. Slide and hold the OPEN/EJECT switch and open the cassette compartment cover.

The cassette compartment opens automatically.

2. Load/unload the cassette.

- Load the cassette with the window facing the grip belt and the REC/SAVE tab facing upward.
- Unload the cassette by pulling it straight out.

3. Press the **PUSH** mark on the cassette compartment until it clicks.

Wait for the cassette compartment to retract automatically.

4. Close the cassette compartment cover.

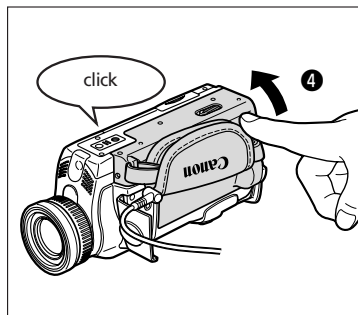
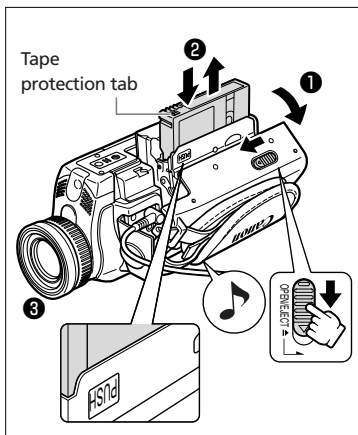

- Do not interfere with the cassette compartment while it is opening or closing automatically or attempt to close the cover until the cassette compartment has fully retracted.

○ Be careful not to get your fingers caught in the cassette compartment cover.



○ If the camcorder is connected to a power source, cassettes can be loaded/unloaded even if the POWER switch is set to OFF.

○  flashes if no cassette is inserted when turning on the power (in CAMERA and PLAY (VCR) mode).

○ With some types of tapes, the remaining tape display may not be accurate.

Protecting Tapes from Accidental Erasure

To protect your recordings from accidental erasure, slide the tab on the cassette to the left. (This switch position is usually labeled SAVE or ERASE OFF.)

If you load a protected cassette in CAMERA mode, the message "THE TAPE IS SET FOR ERASURE PREVENTION" appears for approx. 4

seconds and  starts flashing. If you wish to record on that cassette, slide the tab back to the right.

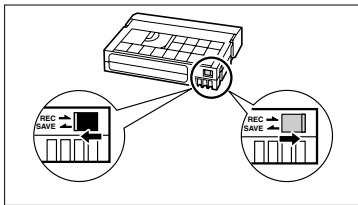

Cassette Handling Precautions

- Rewind tapes after use. If the tape becomes slack and damaged, it may cause picture and sound distortion.
- Return cassettes in the case and store them upright.
- Do not leave the cassette in the camcorder after use.
- Do not use spliced tapes or nonstandard cassettes as they may damage the camcorder.
- Do not use tapes that have been jammed as video heads may become dirty.
- Do not insert anything into the small holes of the cassette, or cover them with cellophane tape.
- Handle cassettes with care. Do not drop or subject them to severe impact as this may damage the cassettes.
- Rewind tapes from time to time if they are stored for a long time.
- With cassettes equipped with a memory function, metal plated terminals may become dirty with use and the cassette's memory function may not work properly. Clean the terminals with a cotton swab after about 10 times of loading/unloading.

Using the Wireless Controller

E

You can operate the camcorder with the supplied wireless controller from a distance of up to 16 feet (5 m). Point it at the camcorder's remote sensor when you press the buttons.

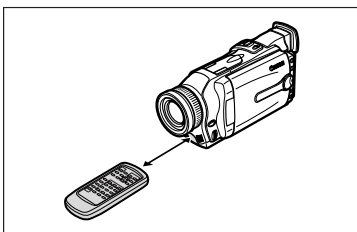

Following functions cannot be operated without the wireless controller:

- Some special playback modes (📖 38)
 - Photo/date search (📖 86)
 - Zero set memory (📖 87)
 - AV Insert (📖 95)
 - Audio dubbing (📖 97)
-  ○ Camcorder and wireless controller are equipped with 2 remote sensor modes (📖 48). If the wireless controller does not work, check if camcorder and wireless controller are set to the same mode.
- The wireless controller may not work properly in bright places, such as outdoors under direct sunlight, or when used too close to the camcorder.
 - The operable range of the wireless controller may shorten when the camcorder's remote sensor is exposed to strong light.
 - When the batteries run out, replace both at the same time.

Inserting Batteries

The wireless controller operates with two AA batteries.

1. Open the battery cover.
2. Insert the batteries following the + and - markings.
3. Close the battery cover.

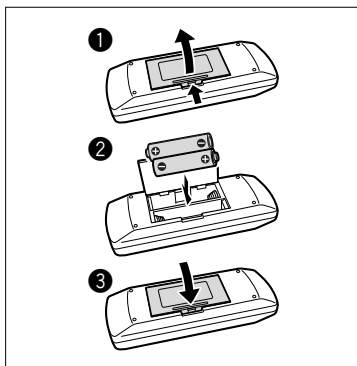

Setting the Time Zone, Date and Time

Set the time zone, date and time when you first start using your camcorder. Install the backup battery before you begin ( 19).

E

Setting the Time Zone/Daylight Saving Time

CAMERA

PLAY (VCR)

CARD CAMERA

CARD PLAY (VCR)

MENU

( 43)

SYSTEM

T. ZONE / DST . . . N. Y .

1. Press the MENU button to open the menu.

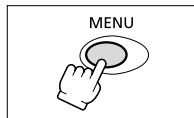

2. Turn the selector dial to select [SYSTEM] and press the selector dial.

3. Turn the selector dial to select [T.ZONE/DST] and press the selector dial.

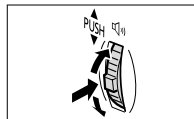

- The time zone setting appears.
- The default setting is New York. Select your time zone and daylight saving time (DST) setting if necessary.

4. Turn the selector dial to select the setting option that represents your time zone.

To adjust for daylight saving time, select the time zone with the  next to the area.

5. Press the MENU button to close the menu.

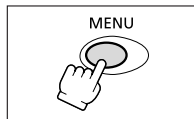

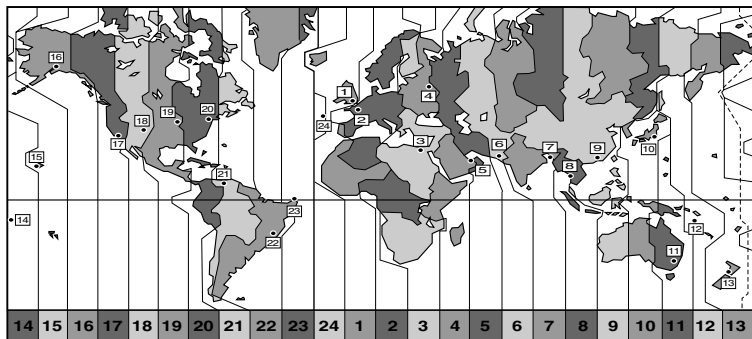

No.	Time zone	No.	Time zone
1	LONDON	13	WELLGTN (Wellington)
2	PARIS	14	SAMOA
3	CAIRO	15	HONOLU. (Honolulu)
4	MOSCOW	16	ANCHOR. (Anchorage)
5	DUBAI	17	L.A. (Los Angeles)
6	KARACHI	18	DENVER
7	DACCA	19	CHICAGO
8	BANGKOK	20	N.Y. (New York)
9	H. KONG (Hong Kong)	21	CARACAS
10	TOKYO	22	RIO (Rio de Janeiro)
11	SYDNEY	23	FERNAN. (Fernando de Noronha)
12	SOLOMON	24	AZORES



- Once you have set time zone, date and time, you do not need to reset the clock each time you travel to another time zone. Just set the time zone to the one of your destination, and the camcorder automatically adjusts the clock.
- Days per month and leap years will be automatically adjusted.

Setting the Date and Time

CAMERA

PLAY (VCR)

CARD CAMERA

CARD PLAY (VCR)

MENU

(book 43)

SYSTEM

D/TIME SET... JAN. 1, 2003
12:00 PM

1. Press the MENU button to open the menu.

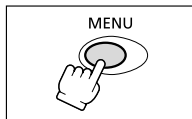

- Turn the selector dial to select [SYSTEM] and press the selector dial.
- Turn the selector dial to select [D/TIME SET] and press the selector dial.

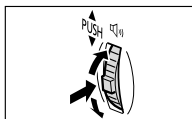

The year display starts to flash.

- Turn the selector dial to select the year, and press the selector dial.

- The next part of the display starts flashing.
- Set the month, day, hours and minutes in the same way.

- Press the MENU button to close the menu and start the clock.

Time zone, date and time appear for 4 seconds each time you turn the power on.

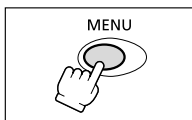

- To change a part of the date or time, press the selector dial at step 4, and move to the part you wish to change.
- The date can be set to any year between 2003 and 2030.

Displaying Date and Time during Recording

You can display time zone, date and time in the lower left corner of the screen (the time zone disappears after 4 seconds). The 4-second display will no longer appear when you turn the power on. The date and time display will not be superimposed on your recordings.

CAMERA

PLAY (VCR)

CARD CAMERA

CARD PLAY (VCR)

MENU
(43)

DISPLAY SET UP

▶ D/T DISPLAY ••OFF

- Press the MENU button to open the menu.

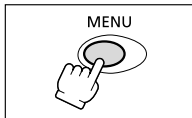

- Turn the selector dial to select [DISPLAY SET UP] and press the selector dial.
- Turn the selector dial to select [D/T DISPLAY] and press the selector dial.
- Turn the selector dial to select [ON].
- Press the MENU button to close the menu.

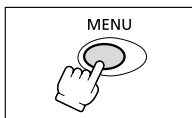
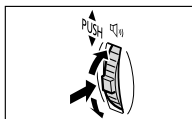

Recording Movies on a Tape



E

You can use the LCD screen or the viewfinder when recording. Adjust the angle of the LCD panel or viewfinder for comfortable recording.

Before You Begin Recording

Make a test recording first to check if the camcorder operates correctly. Before you make important recordings, clean the video heads (📖 148).

Preparations

Connect a power source. Load a cassette.

Recording

1. Remove the lens cap.
2. Set the camcorder to CAMERA mode.

If you have not set the time zone, date and time, "SET THE TIME ZONE, DATE AND TIME" appears. See *Setting the Time Zone, Date and Time* (📖 25).

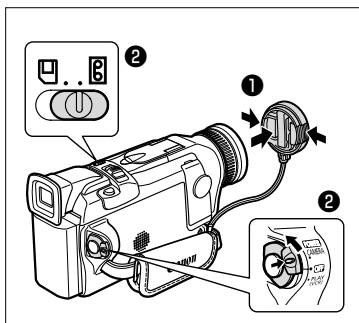

3. Open the LCD panel (📖 32).

To use the viewfinder, keep the LCD panel closed or rotate it so that the screen faces in the same direction of the lens (📖 33).

4. Press the start/stop button to begin recording.

Wait until the tape counter came to a complete stop before you begin recording.

5. Press the start/stop button again to pause recording.

Restart recording by pressing the start/stop button.

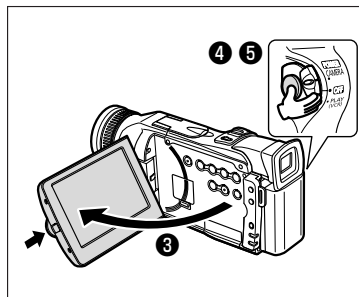

When You Have Finished Recording

1. Turn the **POWER** switch to **OFF**.
2. Close the LCD panel and return the viewfinder to its original position.
3. Replace the lens cap.
4. Unload the cassette.
5. Disconnect the power source.



When recording outdoors or through a window, do not leave LCD screen, viewfinder or lens exposed to direct sunlight as it may cause damage.



- Turn the power off if you do not intend to use the camcorder for a longer time.
- When you start recording, the camcorder counts from 1 second to 10 seconds (recording reminder). Recordings shorter than 10 seconds may be difficult to edit later. On the other hand, a recording not containing a particular action should generally last no longer than 10 seconds.
- The camcorder will shut off after 5 minutes when left in record pause mode to protect tape and video heads. “**!** AUTO POWER OFF” appears 20 seconds before shutoff. To continue recording, turn the POWER switch to OFF and then back to CAMERA.
- For when to use the (Easy Recording) or (program AE) mode, see *Using the Recording Programs* (📖 55).
- When you do not remove the cassette, you can record the next scene without producing any noise or blank sections between the recordings even if you turn the camcorder off.
- About the built-in microphone: When recording near loud sounds (such as fireworks, drums or concerts), sound may become distorted or may be recorded not in the actual sound level.
- For extra recording time, see *Changing the Recording Mode* (📖 52).

About the LCD and viewfinder screen: The screens are produced with extremely high-precision manufacturing techniques, with more than 99.99% of the pixels operating to specification. Less than 0.01% of the pixels may occasionally misfire or appear as black or green dots. This has no effect on the recorded image and does not constitute a malfunction.

Zooming



E

The camcorder's zoom lens allows you to choose the best picture angle for your recordings. The camcorder automatically switches between optical zooming and digital zooming. Image resolution is slightly lower with the digital zoom.

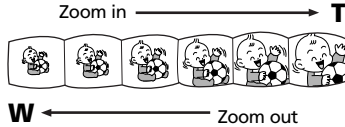

16× Optical Zoom (Card: 15×)

Move the zoom lever toward **W** to zoom out (wide-angle). Move it toward **T** to zoom in (telephoto).

- Press the zoom lever slightly for a slow zoom. Press harder for a faster zoom.
- You can also use the **T** and **W** buttons on the wireless controller. However, you cannot control the zoom speed.

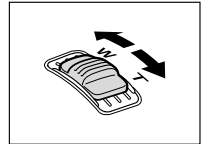

64×/320× Digital Zoom (Card: 60×)

CAMERA

PLAY (VCR)

CARD CAMERA

CARD PLAY (VCR)

MENU

(43)

CAMERA SET UP

D. ZOOM..... 64×

1. Press the MENU button to open the menu.

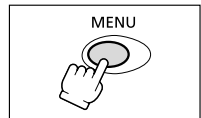

2. Turn the selector dial to select [CAMERA SET UP] and press the selector dial.

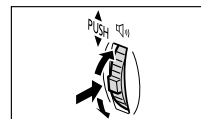

3. Select [D.ZOOM] and press the selector dial.

4. Select a setting option.

5. Press the MENU button to close the menu.

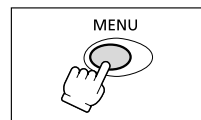



- Keep at least 3.3 ft. (1 m) to the subject. At wide-angle, you can focus on a subject as close as 0.39 in. (1 cm).
- A zoom indicator appears for 4 seconds. It extends in light blue when the digital zoom is set to 64x, and extends further in dark blue when set to 320x.
- Digital zoom cannot be used in the Night mode and Super Night (OPTURA20) mode.
- Digital zoom cannot be used when the multi-image screen is selected.
- Because the image stabilizer cannot be used in CARD CAMERA mode, we recommend mounting the camcorder on a tripod at large magnifications.

Using the LCD Screen

E

1. Push the OPEN button at the LCD panel and open the LCD panel.

The LCD screen switches on and the viewfinder switches off.

2. Rotate the LCD panel and choose the angle of the screen.

You can rotate the LCD panel so that the screen faces in the same direction as the lens

( 33), or push it flat against the camcorder with the screen facing outward.

3. Close the LCD panel after use.

- Close the LCD panel firmly until it clicks.
- The LCD screen switches off and the viewfinder switches on.

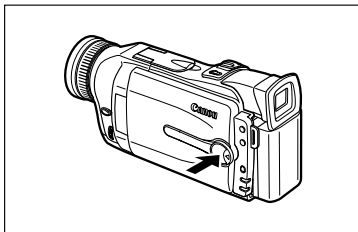
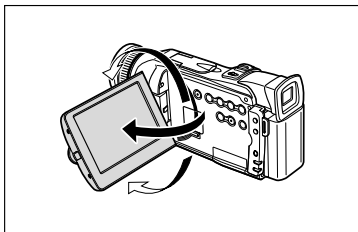

- Make sure to open the LCD panel at 90 degrees before rotating it.
- Rotate the LCD panel in the vertical position before closing the LCD panel.
- When recording outdoors or through a window, do not leave the LCD screen, viewfinder or lens exposed to direct sunlight as it may cause damage.
- Do not hold the camcorder by the LCD panel or the viewfinder.



- Bright light or reflected light may cause a vertical light bar to appear on the screen. This is not a malfunction.
- Bright light may make it difficult to use the LCD screen. In such case, use the viewfinder instead.

Adjusting the Brightness of the LCD Screen



CAMERA

PLAY (VCR)

CARD CAMERA

CARD PLAY (VCR)

MENU

(43)

DISPLAY SET UP

BRIGHTNESS...

1. Press the MENU button to open the menu.

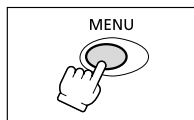

2. Turn the selector dial to select [DISPLAY SET UP] and press the selector dial.

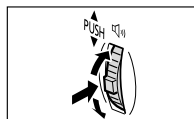

3. Turn the selector dial to select [BRIGHTNESS] and press the selector dial.

4. Turn the selector dial and adjust the level.

Turn the selector dial up to make the screen brighter and down to make it darker.

5. Press the MENU button to close the menu.

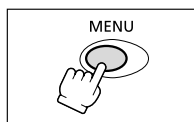

Changing the brightness of the LCD screen does not affect that of the viewfinder or the recordings.

Allowing the Subject to Monitor the LCD Screen

You can rotate the LCD panel so that the screen faces in the same direction as the lens. The viewfinder switches on allowing you to use the viewfinder while the subject can monitor the screen.

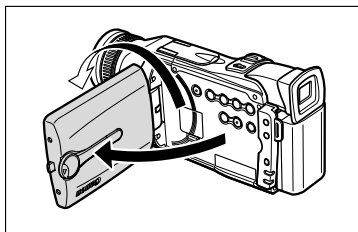

When you rotate the screen so that the screen faces in the same direction as the lens, the image appears mirror reversed (LCD MIRROR ON). However, you can choose to display the image as it is being recorded (LCD MIRROR OFF).

CAMERA

PLAY (VCR)

CARD CAMERA

CARD PLAY (VCR)

E

MENU

(43)

DISPLAY SET UP

▶▶ LCD MIRROR...ON

1. Press the MENU button to open the menu.

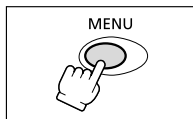

2. Turn the selector dial to select [DISPLAY SET UP] and press the selector dial.

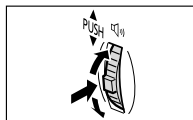

3. Turn the selector dial to select [LCD MIRROR] and press the selector dial.

4. Turn the selector dial to select [OFF].

5. Press the MENU button to close the menu.

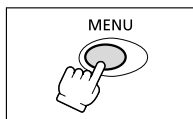

When [LCD MIRROR] is set to [ON], most screen displays appear mirror reversed.

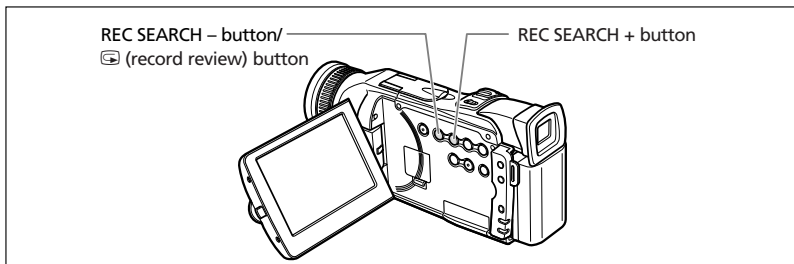

Record Review

CAMERA

PLAY (VCR)

CARD CAMERA

CARD PLAY (VCR)

In record pause mode, this function allows you to review the last few seconds of your recording to check if it has been recorded properly.

Press and release the ⏮ (record review) button.

The camcorder rewinds the tape, plays back the last few seconds, and returns to record pause mode.

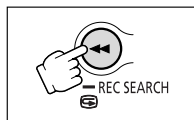

Record Search

CAMERA

PLAY (VCR)

CARD CAMERA

CARD PLAY (VCR)

In record pause mode, this function allows you to play back the tape (forward or reverse) to locate the point where you wish to begin recording.

Press and hold the REC SEARCH + button (forward) or - button (reverse).

- Release the button at the point you wish to begin recording.
- The camcorder returns to record pause mode.

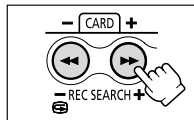

- Noise may appear on the screen when you play back the tape in reverse.
- There will be no sound during Record Review and Record Search.

Tips for Making Better Videos

E

Holding the Camcorder

For maximum stability, grip the camcorder in your right hand and keep your right elbow pressed against your body. If necessary, support the camcorder with your left hand. Be careful that your fingers do not touch the microphone or lens.



High-angle Recording



Low-angle Recording



For More Stability

Lean against a wall



Put the camcorder on a table



Lie on your elbow



Use a tripod



Lighting

When recording outdoors, we recommend recording with the sun at your back.

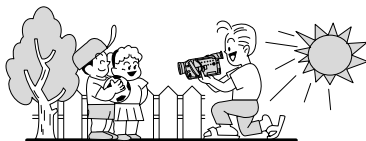

- When using a tripod, do not leave the viewfinder exposed to direct sunlight as it may melt (due to concentration of the light by the lens).
- Do not use tripods with fastening screws longer than 0.2 inch (5.5 mm) as it may damage the camcorder.

Playing Back a Tape



When you use the LCD screen for playback, the camcorder plays back the sound via built-in speaker. The built-in speaker is monaural. Use headphones for stereo sound or when using the viewfinder for playback.

E

Preparations

Connect a power source. Load a cassette.

Playback

1. Set the camcorder to **PLAY (VCR)** mode.

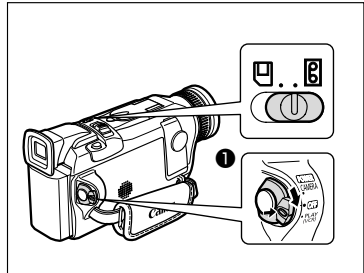

2. Open the LCD panel.

You can also close the LCD panel with the screen facing outward.

3. Press the **◀◀** button to rewind the tape.

To fast forward the tape, press the **▶▶** button. To stop playback, press the **■** button.

4. Press the **▶/||** button to begin playback.

5. Press the **■** button to stop playback.

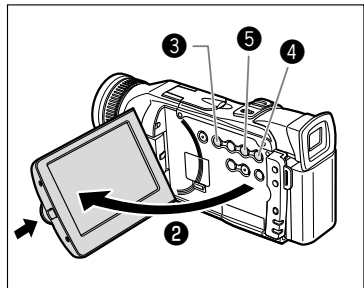

- If the playback picture is distorted, clean the video heads using a Canon Head Cleaning Cassette or a commercially available digital video head-cleaning cassette (□ 148).
- To use the viewfinder, close the LCD panel. The built-in speaker does not sound. Use headphones when using the viewfinder (□ 39).
- For displaying the date and time during playback, see *Displaying the Data Code* (□ 84).

Special Playback Modes

Special playback modes (except of playback pause and fast/rewind playback) can only be operated with the wireless controller.

E

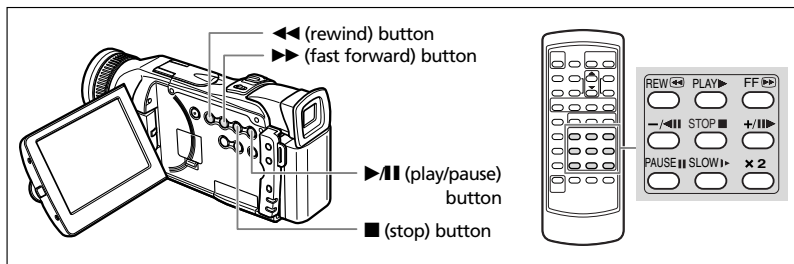

▶|| (Playback Pause)

To pause playback, press the ▶|| button. Press the ▶|| button to resume playback. The camcorder goes into stop mode after 5 minutes in playback pause mode.

▶▶ (Fast Forward Playback) / ◀◀ (Rewind Playback)

Plays back the tape at 9.5 times normal speed (forward or reverse). Press and hold the button during normal playback or fast forward.

+||▶ (Frame Advance) / -/◀|| (Frame Reverse)

Plays back frame-by-frame. Press the button repeatedly during playback pause. Press and hold it to play back continuous frame advance/frame reverse.

SLOW ▶▶ (Slow Forward)/(Slow Reverse)

Plays back at about 1/3 normal speed. For slow forward playback, press the SLOW ▶▶ button. For slow reverse playback, press the -/◀|| button followed by the SLOW ▶▶ button. Press the ▶ (play) button to return to normal playback.

-/◀|| (Reverse Playback)

Plays back in reverse at normal speed. Press the button during normal playback. Press the ▶ (play) button return to normal playback. The camcorder goes into stop mode after 5 minutes in reverse playback pause.

× 2 (Forward× 2 Playback)/(Reverse 2× Playback)

Plays back at 2 times normal speed. Press the button during normal or reverse playback. Press the ▶ (play) button return to normal playback.



- There is no sound during special playback.
- The picture may become distorted during some special playback modes.

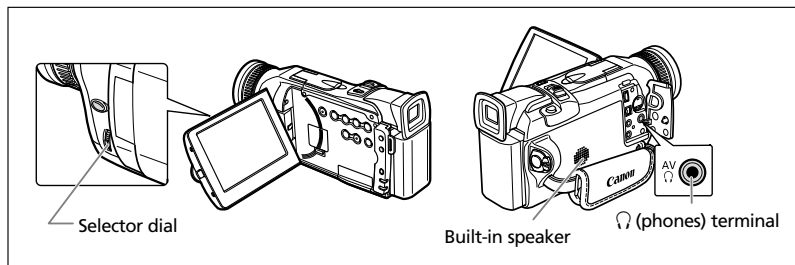

- When using the built-in speaker, make sure that "🔊" is not displayed on the screen. When using the headphones, make sure that "🎧" is displayed. Change the setting as necessary (📖 70).
- The built-in speaker does not sound when "🎧" is displayed.
- Do not connect headphones unless "🎧" is displayed as it produces noise.
- The built-in speaker is monaural. Use headphones for stereo sound.
- The setting has to be done separately for each operating mode. Make sure to change the setting when you have change the operating mode.

Adjusting the Volume

CAMERA

PLAY (VCR)

CARD CAMERA

CARD PLAY (VCR)

Turn the selector dial up to increase the volume, and down to lower the volume.

- A volume bar appears for 4 seconds.
- You can turn off the volume completely by turning the selector dial down until [OFF] appears. Turn the selector dial up to increase the volume again.

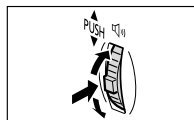

- Sound may become distorted when the volume is turned up too high.
- The headphone volume can be adjusted in all operating modes.
- The camcorder retains the setting even if you turn it off (separately for headphones and built-in speaker).
- See also *Using Headphones during Recording* (📖 70).

Playing Back on a TV Screen

E

You can connect the camcorder to a TV or VCR to play back your recordings on a TV screen.



○ Make sure that "Ⓢ" is not displayed on the screen. If "Ⓢ" is displayed, change the setting (📖 70).

○ When you use the TV as a monitor during recording, keep the TV volume turned down as long as the camcorder's audio terminals are connected. An unpleasant high-pitched squeal, called feedback, may be produced if sound from the TV speakers is picked up by the microphone.



○ For high picture quality, we recommend using a TV with an S (S1) terminal.

○ TVs with S1-terminal or Video ID-1 system: Recordings made in the 16:9 mode (📖 50) will be automatically played back in wide screen mode.

TVs with S (S1)-Video Input Terminal

Refer also to the TV or VCR instruction manual.

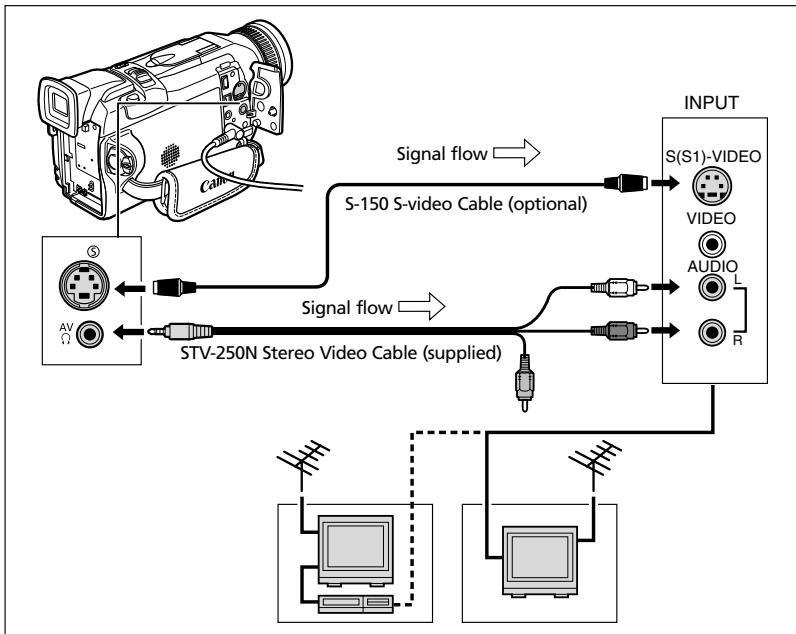

1. Turn off all devices before starting the connections.

2. Connect the S-150 S-video Cable (optional) to the S-video terminals.

3. Connect the STV-250N Stereo Video Cable to the camcorder's AV terminal and the audio terminals of the TV/VCR.

Connect the white plug to the white AUDIO terminal L (left), and the red plug to the red AUDIO terminal R (right). Do not connect the yellow plug.

4. If connecting to a TV, set the input selector to VIDEO. If connecting to a VCR, set the input selector to LINE.

TVs with Audio/Video Terminals

Refer also to the TV or VCR instruction manual.

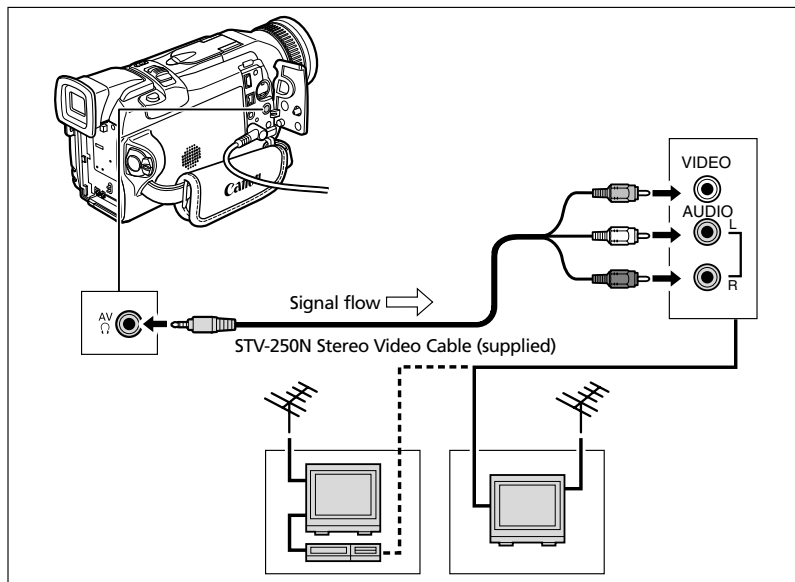

1. Turn off all devices before starting the connections.

2. Connect the STV-250N Stereo Video Cable to the camcorder's AV terminal and the audio/video terminals on the TV/VCR.

Connect the white plug to the white audio terminal L (left), the red plug to the red audio terminal R (right) and the yellow plug to the yellow video terminal VIDEO.

3. If connecting to a TV, set the input selector to VIDEO. If connecting to a VCR, set the input selector to LINE.

Selecting the Audio Output Channel



You can select the output channels when playing back a tape with audio recorded on two channels.

E

CAMERA

PLAY (VCR)

CARD CAMERA

CARD PLAY (VCR)

MENU

(43)

AUDIO SET UP

▶ OUTPUT CH...L/R

1. Press the **MENU** button to open the menu.

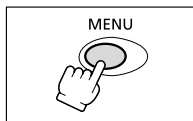

2. Turn the selector dial to select **[AUDIO SET UP]** and press the selector dial.

3. Turn the selector dial to select **[OUTPUT CH]** and press the selector dial.

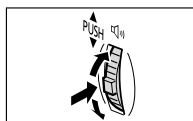

4. Turn the selector dial to select a setting option.

- L/R: Stereo: L+R channels, Bilingual: Main+Sub.
- L/L: Stereo: L channel, Bilingual: Main.
- R/R: Stereo: R channel, Bilingual: Sub.

5. Press the **MENU** button to close the menu.

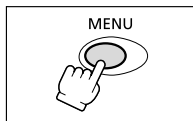

The setting resets to the L/R setting when you turn the camcorder off.



Many of the camcorder's advanced functions are selected from menus that appear on the screen.

Selecting Menus and Settings

1. Set the camcorder to the correct operating mode.

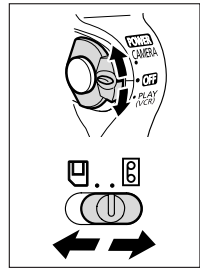

2. Press the MENU button to open the menu.

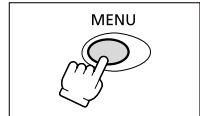

3. Turn the selector dial to select a submenu and press the selector dial.

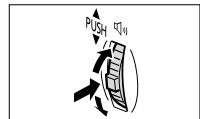

4. Turn the selector dial to select a menu item and press the selector dial.

5. Turn the selector dial to select a setting option.

6. Press the MENU button to close the menu.

When setting the white balance or shutter speed, press the selector dial first before pressing the MENU button.

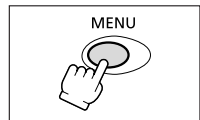

- Pressing the MENU button at any time closes the menu.
- Selecting [← RETURN] takes you back one level.
- When the submenu consists of 2 pages, select [NEXT PAGE] to move to the second page, and [PREV PAGE] to return to the first page.
- Items that are not available appear in purple.
- You may find it more convenient to use the wireless controller to operate the menu. Press the MENU button on the wireless controller to open or close the menu. Use the select buttons in place of the selector dial and press the SET button in place of pressing the selector dial.

Menu and Default Settings

Default settings are shown in boldface.

CAMERA Menu (CAM. MENU)

E

CAMERA

PLAY (VCR)

CARD CAMERA

CARD CAMERA

Submenu	Menu Item	Setting Options	
→CARD MIX	MIX TYPE	CARD CHROMA , CARD LUMI. , CAM. CHROMA , C. ANIMATION	130
	ANIMAT. TYPE	CORNER , STRAIGHT , RANDOM	130
	MIX LEVEL		130
CAMERA SET UP	SHUTTER	AUTO , 1/60, 1/100, 1/250, 1/500, 1/1000, 1/2000, 1/4000, 1/8000	79
	D. ZOOM	OFF, 64× , 320×	30
	IMAGE S. (📷)	ON , OFF	67
	WHITE BAL.	AUTO , SET 📷, INDOOR 🏠, OUTDOOR *	82
	(FLASH)	AUTO ⚡, RED-EYE 📷, FLASH ON ⚡, FLASH OFF 📷	73
	(AF AST LAMP*)	AUTO , OFF	77
	16:9	ON , OFF	50
	PHOTO REC	TAPE 📷, CARD 📷	110
VCR SET UP	REC MODE	SP , LP	52
	AV/PHONES	AV , PHONES 📞	39
AUDIO SET UP	WIND SCREEN	ON , OFF	69
	AUDIO MODE	16bit, 12bit	69
	🔊 VOLUME		70
DISPLAY SET UP	BRIGHTNESS		33
	LCD MIRROR	ON , OFF	34
	TV SCREEN	ON , OFF	140
	D/T DISPLAY	ON , OFF	27
	DEMO MODE	ON , OFF	51
SYSTEM	WL. REMOTE	📺1, 📺2, OFF 📺	48
	BEEP	ON , OFF	50
	T.ZONE/DST	See list of time zones	25
	D/TIME SET		26
MY CAMERA	SHTR SOUND	PATTERN1 , PATTERN2 , PATTERN3	49
	S-UP SOUND	PATTERN1 , PATTERN2 , PATTERN3	49
	S/STOP SOUND	PATTERN1 , PATTERN2 , PATTERN3	49
	SELF-T SOUND	PATTERN1 , PATTERN2 , PATTERN3	49

*OPTURA20 only

(📷) : Appears when you connect the optional VFL-1 Video Flash Light and set it to **ON**.

PLAY (VCR) Menu (VCR MENU)

CAMERA

PLAY (VCR)

CARD CAMERA

CARD CAMERA

Submenu	Menu Item	Setting Options	
VCR SET UP	REC MODE	SP, LP	52
	AV/PHONES	AV, PHONES ()	39
	AV → DV OUT	ON, OFF	94
AUDIO SET UP	OUTPUT CH	L/R, L/L, R/R	42
	AUDIO DUB.	AUDIO IN, MIC. IN	98
	WIND SCREEN	ON, OFF	69
	AUDIO MODE	16bit, 12bit	69
	12bit AUDIO	STEREO1, STEREO2, MIX/FIXED, MIX/VARI.	99
	MIX BALANCE		99
CARD SET UP	SI QUALITY	SUPER FINE, FINE, NORMAL	102
	MOVIE SIZE	320 × 240, 160 × 120	103
	FILE NOS.	RESET, CONTINUOUS	104
CARD OPERATIONS	COPY () → ()	CANCEL, EXECUTE	132
DISPLAY SET UP	BRIGHTNESS		33
	DISPLAYS	ON, OFF <PLAYBK>	140
	6SEC. DATE	ON, OFF	85
	DATA CODE	DATE/TIME, CAMERA DATA, CAM. & D/T	85
	D/TIME SEL.	DATE, TIME, DATE & TIME	85
SYSTEM	WL. REMOTE	() 1, () 2, OFF ()	48
	BEEP	ON, OFF	50
	T.ZONE/DST	See list of time zones	25
	D/TIME SET		26
MY CAMERA	SHTR SOUND	PATTERN1, PATTERN2, PATTERN3	49
	S-UP SOUND	PATTERN1, PATTERN2, PATTERN3	49
	S/STOP SOUND	PATTERN1, PATTERN2, PATTERN3	49
	SELF-T SOUND	PATTERN1, PATTERN2, PATTERN3	49

E

Using the Full Range of Features

CARD CAMERA Menu (C. CAM. MENU)













CAMERA

PLAY (VCR)

CARD CAMERA

CARD PLAY (VCR)

E

Submenu	Menu Item	Setting Options	
CAMERA SET UP	SHUTTER	AUTO, 1/60, 1/100, 1/250	79
	D.ZOOM	OFF, 60×	30
	WHITE BAL.	AUTO, SET  , INDOOR  , OUTDOOR 	81
	DRIVE MODE	CONT.  , AEB  , SINGLE	107
	(FLASH)	AUTO  , RED-EYE  , FLASH ON  , FLASH OFF 	73
	(AF AST LAMP*)	AUTO, OFF	77
	FOCUS PRI.	ON, OFF	107
	ND	AUTO, OFF	106
CARD SET UP	SI QUALITY	SUPER FINE, FINE, NORMAL	102
	SI SIZE	1280 × 960, 640 × 480	102
	MOVIE SIZE	320 × 240, 160 × 120	103
	FILE NOS.	RESET, CONTINUOUS	104
VCR SET UP	AV/PHONES	AV, PHONES ()	39
AUDIO SET UP	WIND SCREEN	ON, OFF	69
	() VOLUME		70
DISPLAY SET UP	BRIGHTNESS		33
	LCD MIRROR	ON, OFF	34
	TV SCREEN	ON, OFF	140
	D/T DISPLAY	ON, OFF	27
	DEMO MODE	ON, OFF	51
SYSTEM	WL. REMOTE	()1, ()2, OFF ()	48
	BEEP	ON, OFF	50
	T.ZONE/DST	See list of time zones	25
	D/TIME SET		26
MY CAMERA	SHTR SOUND	PATTERN1, PATTERN2, PATTERN3	49
	S-UP SOUND	PATTERN1, PATTERN2, PATTERN3	49
	S/STOP SOUND	PATTERN1, PATTERN2, PATTERN3	49
	SELF-T SOUND	PATTERN1, PATTERN2, PATTERN3	49

*OPTURA20 only

(): Appears when you connect the optional VFL-1 Video Flash Light and set it to  ON.















CARD PLAY (VCR) Menu (C.PLAY MENU)

CAMERA

PLAY (VCR)

CARD CAMERA

CARD PLAY (VCR)

Submenu	Menu Item	Setting Options	
CARD OPERATIONS (Single Image Display)	COPY   	CANCEL, EXECUTE	133
	 PRINT ORDERS ALL ERASE	YES, NO	121
	IMAGE ERASE	CANCEL, SINGLE, ALL	119
	FORMAT	CANCEL, EXECUTE	134
CARD OPERATIONS (Index Screen)	 PROTECT 		118
	  PRINT ORDER		120
VCR SET UP	REC MODE	SP, LP	52
	AV/PHONES	AV, PHONES 	39
DISPLAY SET UP	BRIGHTNESS		33
	DISPLAYS	ON, OFF <PLAYBK>	140
	D/TIME SEL.	DATE, TIME, DATE & TIME	85
SYSTEM	WL. REMOTE	 1,  2, OFF 	48
	BEEP	ON, OFF	50
	T.ZONE/DST	See list of time zones	25
	D/TIME SET		26
MY CAMERA	CREATE START-UP IMAGE		136
	SEL. S-UP IMG	NO IMAGE, CANON LOGO, MY IMAGE1, MY IMAGE2	49
	SHTR SOUND	PATTERN1, PATTERN2, PATTERN3	49
	S-UP SOUND	PATTERN1, PATTERN2, PATTERN3	49
	S/STOP SOUND	PATTERN1, PATTERN2, PATTERN3	49
	SELF-T SOUND	PATTERN1, PATTERN2, PATTERN3	49
  PRINT	Appears when connecting a printer with direct print function.		127

E

Using the Full Range
of Features

Changing the Remote Sensor Mode



E

Two remote sensor modes and an off setting are available to prevent interference from other Canon wireless controllers being used nearby.

Turning the Remote Sensor Off

CAMERA

PLAY (VCR)

CARD CAMERA

CARD PLAY (VCR)

MENU

(book 43)

SYSTEM

WL . REMOTE 1

Open the menu and select [SYSTEM]. Select [WL. REMOTE], set it to [OFF] and close the menu.

"OFF" appears.

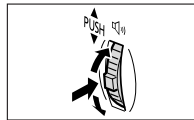

Changing the Remote Sensor Mode

CAMERA

PLAY (VCR)

CARD CAMERA

CARD PLAY (VCR)

MENU

(book 43)

SYSTEM

WL . REMOTE 1

1. On the camcorder, open the menu and select [SYSTEM]. Select [WL. REMOTE], set it to [2] and close the menu.

The selected mode appears for 4 seconds.

2. On the wireless controller, press and hold the REMOTE SET button. Press the ZOOM T button for mode 2. Keep the button pressed for over 2 seconds.

If you have set the camcorder to mode 1, press the ZOOM W button for mode 1.

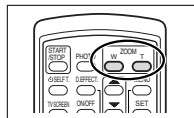
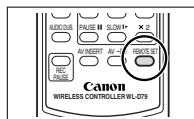
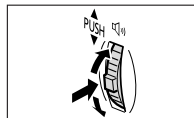

- The wireless controller returns to mode 1 when you replace the batteries. Change the mode if necessary.
- Make sure that camcorder and wireless controller are set to the same mode. Display the camcorder's mode by pressing any button on the wireless controller (except of the REMOTE SET button) and set the wireless controller's mode to the same mode. Change the batteries if the wireless controller still does not work.

Customizing the Camcorder

You can personalize your camcorder by customizing the start-up image and the sound it makes for start-up, shutter, start/stop and self-timer (collectively called the My Camera settings). You can also create your own start-up image. See *Creating a Start-up Image* (📖 136).

E

Changing the My Camera Settings

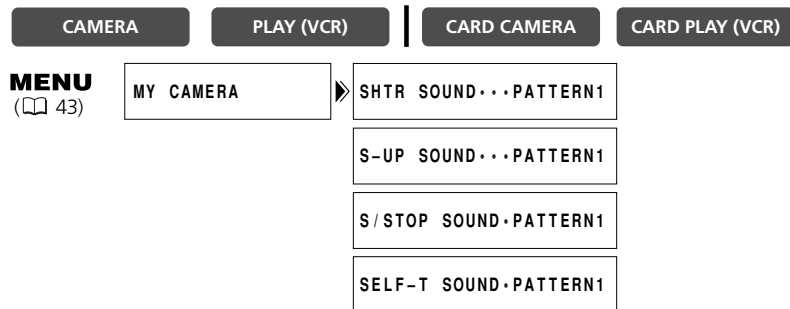

1. Open the menu and select [MY CAMERA].

2. Select the menu item you wish to change.

- When selecting a start-up image (only in CARD PLAY (VCR) mode): [NO IMAGE], [CANON LOGO], [MY IMAGE1] and [MY IMAGE2] appears.
- When selecting a sound: [PATTERN1], [PATTERN2] and [PATTERN3] appear.

3. Select a setting option and close the menu.

Using the Full Range of Features

Other Camcorder Settings



E

Beep

You will hear a beep upon camcorder operations such as power on/off, start/stop, self-timer countdown, automatic shut-off, and unusual conditions of the camcorder. The beep will not be recorded.

If you turn off the beep, all camcorder sounds including the ones of the My Camera settings will be turned off.

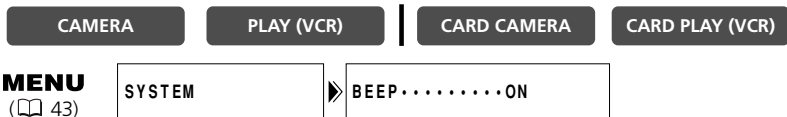

To turn the beep off, open the menu and select [SYSTEM]. Select [BEEP], set it to [OFF] and close the menu.

Recording in 16:9 (Wide Screen TV Recording)

You can record in the 16:9 format for playback on wide screen TVs.



To switch 16:9 on, open the menu and select [CAMERA SET UP]. Select [16:9], set it to [ON] and close the menu.

"16:9" appears.



- The 16:9 mode is an electronically processed effect.
- The 16:9 mode cannot be selected in the Easy Recording mode.
- The multi-image screen cannot be used when the 16:9 format is selected.
- If you play back a 16:9 recording on a normal TV, the image appears vertically "squashed" (compressed).
- If you connect the camcorder to a TV with an S1 terminal or Video ID-1 system, recordings made in the 16:9 mode will be automatically played back in wide screen mode.

Demonstration Mode

The demonstration mode displays the camcorder's main features. It starts automatically when you leave the camcorder turned on without loading a cassette and without inserting a memory card for more than 5 minutes. You can also start the demonstration mode through the menu.

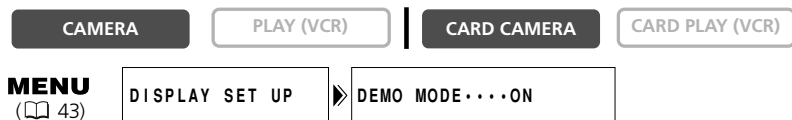

With no cassette and memory card inserted, open the menu and select [DISPLAY SET UP]. Select [DEMO MODE], set it to [OFF] and close the menu.



To cancel the demo mode, press any button, turn off the camcorder, load a cassette or insert a memory card.

Changing the Recording Mode (SP/LP)

E

You can choose from SP (standard play) and LP (long play). LP extends the tape usage by 1.5 times.



- Tapes recorded in LP mode cannot be used for audio dubbing ( 97) or AV insert ( 95).
- Depending on the nature and usage condition of the tape, picture and sound recorded in LP mode may be distorted. We recommend using the SP mode for important recordings.
- We recommend recording in SP mode if you plan to transfer the images to a computer.
- If you record in both SP and LP modes on the same tape, the playback picture may become distorted and the time code may not be written correctly.
- If you play back a tape that has been recorded in LP mode with another digital device on this camcorder, or vice versa, picture and sound may become distorted.

CAMERA

PLAY (VCR)

CARD CAMERA

CARD PLAY (VCR)

MENU

( 43)

VCR SET UP



REC MODE.....SP

To change to LP mode, open the menu and select [VCR SET UP]. Select [REC MODE], set it to [LP] and close the menu.

Recording Still Images on the Tape

You can record still images on the tape. Starting your recording with a still image allows you to easily locate the beginning of the recording with the Photo Search function ( 86).

You can also record still images on a memory card while recording movies on a tape ( 110).



Open the menu and select [CAMERA SET UP]. Select [PHOTO REC], confirm that [TAPE ] is selected and close the menu.

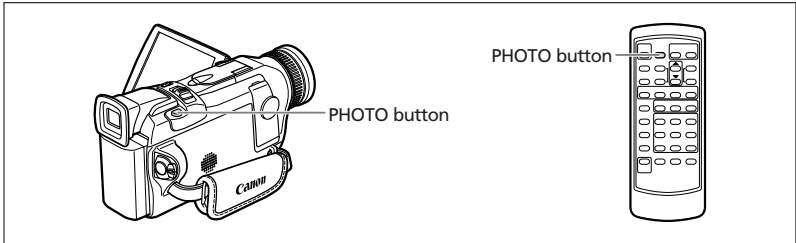

CAMERA

PLAY (VCR)

CARD CAMERA

CARD PLAY (VCR)

In Record Pause Mode

1. Press the PHOTO button halfway.

-  appears in green. If it does not appear in green, adjust the focus with the focus ring.
- Exposure is locked.
- Focus can be adjusted manually with the focus ring when the PHOTO button is pressed halfway.
- When you press the PHOTO button on the wireless controller, recording starts immediately.

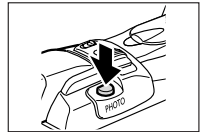

2. Press the PHOTO button fully.

-  disappears.
- The camcorder records the still image for approx. 6 seconds. During this time, the camcorder displays the still image and keeps recording the sound.
- The camcorder returns to record pause mode.

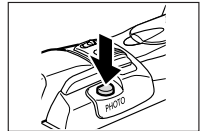

During Recording

E

1. Press the PHOTO button fully.

- The camcorder records the still image for approx. 6 seconds. During this time, the camcorder displays the still image and keeps recording the sound
- The camcorder returns to record pause mode.

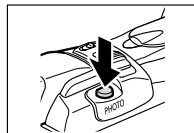

- When you turn the POWER switch to OFF while the camcorder is recording the still image, it will not turn off until recording is complete.
- Record still images under sufficient lighting condition (in which you can identify the subject on the screen).

Using the Recording Programs



The camcorder is equipped with the Easy Recording program and several program AE modes. The availability of functions differs depending on the selected mode.

E

Availability of Functions in Each Mode:

Position of the Program Selector	<input type="checkbox"/>	P								
Position of the TAPE/CARD switch		📷 / 📷				📷		📷		
Recording Program	<input type="checkbox"/>								*1	*1
Digital Zoom	<input type="radio"/>	○						×	○	
Shutter Speed	A	○	A					A	A	
Focus		○						○	○	
White Balance		○						○	○	
Exposure		○						○	○	
Image Stabilizer*2	ON	○				×	○	×		
Digital Effects	×	○*2						○	○*2	
16:9	×	○						○	×	
Card Mix	×	○						○	×	

A: Auto setting ○: Available ×: Not available

Shaded area: Can be used only when the TAPE/CARD switch is set to 📷.

*1: OPTURA20 only.

*2: Only Black and White can be used in CARD CAMERA mode.

Easy Recording Program

The camcorder adjusts focus, exposure and other settings automatically, allowing you to just point and shoot.



Program AE Modes

A Auto

The camcorder adjusts focus, exposure and other settings automatically. However, you have the option of adjusting the settings manually.



Sports

Use this mode to record sports scenes (such as tennis or golf), moving objects (such as roller coasters) or when recording from a moving car.



- This mode is set at a high shutter speed and should therefore be used in sufficient light.
- This mode is mainly intended for frame-by-frame or slow playback. The picture may not appear smooth when played back in normal speed.

Portrait

Use this mode to give accent to your subject by blurring the background or foreground.



- The blur effect increases the more you zoom to telephoto.
- This mode is set at a higher shutter speed. The picture may not appear smooth when played back.

Spotlight

Use this mode to record spotlit scenes such as shows, recitals or fireworks.



Sand & Snow

Use this mode in bright places such as a sunny beach or ski resort. It prevents the subject from being underexposed.



- The subject may become overexposed in dark surroundings. Check the image on the screen.
- This mode is set at a higher shutter speed. The picture may not appear smooth when played back.

Low Light

Use this mode to record in dimly lit places. The shutter is fixed at a slow shutter speed.



- Moving subjects may leave a trailing afterimage.
- Picture quality may not be as good as in other modes.
- The camcorder may have difficulty to focus automatically.

Night

Use this mode to record in dark places. The shutter speed is adjusted automatically. It is useful when recording in places with changing light conditions (such as in amusement parks).



E

- Night mode cannot be used in CARD CAMERA mode.
- Moving subjects may leave a trailing afterimage.
- Picture quality may not be as good as in other modes.
- White points may appear on the screen.
- Autofocus may not work as well as in other modes. In such case, adjust the focus manually.

optura20

Super Night (CAMERA mode)

In CAMERA mode, use this mode to record in very dark places. The shutter speed is adjusted automatically. The White LED lights up automatically illuminating the subject in the center of the screen, allowing you to record brightly in color.



Low Light Plus (CARD CAMERA mode)

In CARD CAMERA mode, use this mode to record in dark places. The shutter is fixed at a slow shutter speed. The White LED lights up illuminating the subject in the center of the screen, allowing you to record brightly in color.



- The range of the White LED is limited. Check the image on the screen when recording.
- Use this mode for recordings at close range (up to 6.6 ft (2m)).
- Moving subjects may leave a trailing afterimage.
- Picture quality may not be as good as in other modes.
- White points may appear on the screen.
- Autofocus may not work as well as in other modes. In such case, adjust the focus manually.

Selecting the Program AE Mode

CAMERA

PLAY (VCR)

CARD CAMERA

CARD PLAY (VCR)

E

1. Set the program selector to **P**.

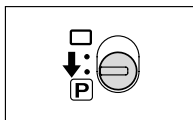

2. Press the selector dial.

A list of the program AE modes appears.

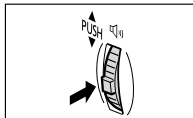

3. Select a mode and press the selector dial.

The symbol of the mode appears on the upper left corner of the screen. **A** (Auto) disappears after 4 seconds.

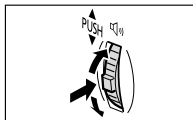

- Do not change the mode during recording as the brightness of the image may change abruptly.
- The setting resets to the Auto mode when you switch the program selector to **P**.
- Bright light in a dark scene may cause a vertical light bar to appear. This is not a malfunction.

Using Digital Effects



You can use the digital effects during recording and playback.

Faders (📖 60): Begin or end scenes with a fade to or from black.

Effects (📖 63): Add flavor to your recordings.

Multi-image screen (📖 65)

E

Availability of Digital Effects by Operating Modes:

	CAMERA		PLAY (VCR)	CARD CAMERA	CARD PLAY (VCR)
	Movies	Still Images			
Faders	○	×	○	×	×
Effects	○	○	○	○*1	×
Multi-image screen	○*2	○*2	○	×	×

○: Available ×: Not available

*1: Black and White only.

*2: Cannot be used in Night and Super Night (OPTURA20) mode.



○ Turn off the digital effect when you do not use it.

Press the DIGITAL EFFECTS button to open the menu. Select [D.EFFECTS OFF] and press the ON/OFF button.

○ The camcorder retains the setting even if you turn it off or change the program AE mode.

○ The digital effect turns off if you switch the program selector to □.

○ Digital effects can be selected but not activated on a blank blue screen (appears in PLAY (VCR) mode).

○ Digital effects activated during playback do not change the recording.

○ Digital effects cannot be used during DV dubbing and photo/date search.

○ Digital effects can also be set with the wireless controller.

Faders

Fade Trigger (FADE-T)

E

The image gradually fades in.

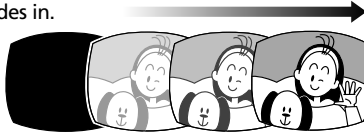

The image gradually fades out.

Wipe (WIPE)

The image begins as a vertical line in the center and expands sideways until it fills the whole screen.

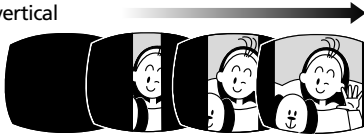

The image is wiped off from the sides of the screen.

Corner Wipe (CORNER)

The image appears from the corners until it fills the whole screen.



The image is wiped off from the corners.

Jump (JUMP)

A small image appears from the left, jumps into the center and enlarges until it fills the whole screen.



The image shrinks, jumps from the center to the left and disappears.

Flip (FLIP)

The image flips into the screen.

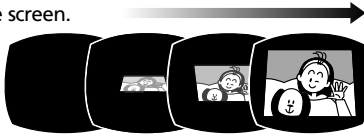

The image flips out of the screen.

Puzzle (PUZZLE)

The image appears in 16 pieces.
The pieces move around until the puzzle is solved.

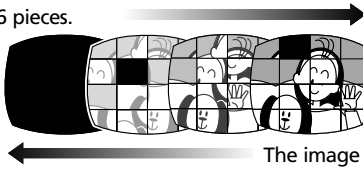

The image is divided into 16 pieces. The pieces move around and disappear.

Zigzag (ZIGZAG)

The image appears in zigzag from the top of the screen.

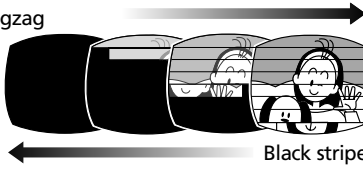

Black stripes appear in zigzag from the bottom of the screen until they cover the whole image.

Beam (BEAM)

The screen turns yellow, forms a beam that becomes thinner and the image appears.

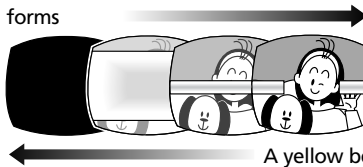

A yellow beam appears in the center of the screen and expands until it covers the whole image.

Tide (TIDE)

The image appears from both sides like tides.

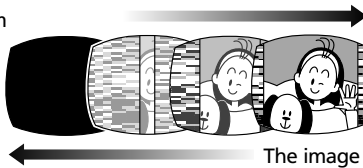

The image disappears from both sides like tides.

Selecting a Fader

E

CAMERA

PLAY (VCR)

CARD CAMERA

CARD PLAY (VCR)

1. In CAMERA mode, set the program selector to [P].

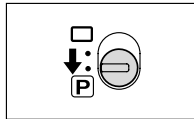

2. Press the DIGITAL EFFECTS button.

[D.EFFECTS OFF], [FADER], [EFFECT] and [MULTI-S] appear.

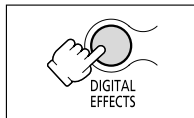

3. Select [FADER].

4. Select the fader option.

5. Press the DIGITAL EFFECTS button.

The name of the selected fader flashes.

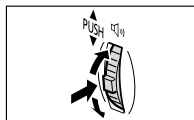

CAMERA mode:

6. Fade in: In record pause mode, press the ON/OFF button and begin recording by pressing the start/stop button.

Fade out: During recording, press the ON/OFF button and pause recording by pressing the start/stop button.

The fader can be activated/deactivated by pressing the ON/OFF button.

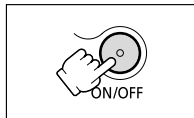

PLAY (VCR) mode:

6. Fade in: In playback pause mode, press the ON/OFF button and begin playback by pressing the ►/|| button.

Fade out: During playback, press the ON/OFF button and pause playback by pressing the ►/|| button.

The fader can be activated/deactivated by pressing the ON/OFF button.

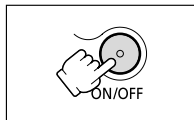

Faders cannot be selected when Card Mix is activated.

Effects

Art (ART)

The image becomes like a paint (solarization).

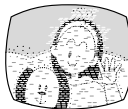

Black and White (BLK & WHT)

The image becomes black and white.



Sepia (SEPIA)

The image becomes monochrome with a brownish tint.



Mosaic (MOSAIC)

The image is blurred through enlarging the size of some pixels.

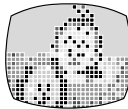

Ball (BALL)

The image becomes like a ball.



Cube (CUBE)

The image becomes a cube and rotates.



Wave (WAVE)

Both ends of the image sway in waves.



Color Masking (COLOR M.)

The image becomes a rhombus surrounded by a masking frame that changes the colors.



Mirror (MIRROR)

Creates a symmetrical image as if there would be a mirror in the center of the screen.



Only Black and White can be used in CARD CAMERA mode.

Selecting an Effect

E

CAMERA

PLAY (VCR)

CARD CAMERA

CARD PLAY (VCR)

1. In CAMERA mode, set the program selector to [P].

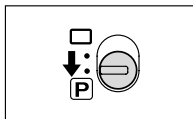

2. Press the DIGITAL EFFECTS button.

[D.EFFECTS OFF], [FADER], [EFFECT] and [MULTI-S] appear.

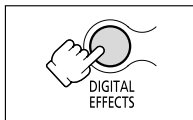

3. Select [EFFECT].

4. Select the effect.

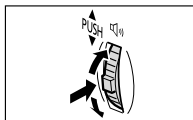

5. Press the DIGITAL EFFECTS button.

The name of the selected effect flashes.

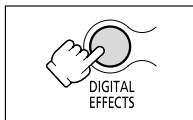

6. Press the ON/OFF button.

- The name of the selected effect stops flashing.
- The effect can be activated/deactivated by pressing the ON/OFF button.

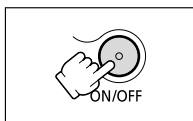

Selecting an Effect in CARD CAMERA Mode

CAMERA

PLAY (VCR)

CARD CAMERA

CARD PLAY (VCR)

1. Press the DIGITAL EFFECTS button.

"BLK&WHT" flashes.

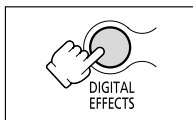

2. Press the ON/OFF button.

- "BLK&WHT" stops flashing.
- The effect can be activated/deactivated by pressing the ON/OFF button.



Using the Multi-Image Screen



E

The multi-image screen captures moving subjects in 4, 9 or 16 sequences of still images with the Image Capture feature and displays them at one time. Sound will be recorded normally. This feature can be used in CAMERA and PLAY (VCR) mode.

You can choose the transition speed at which to capture the subject from manual, fast (every 4 frames), moderate (every 6 frames*) or slow (every 8 frames*).

* In Low Light mode: moderate (every 8 frames), slow (every 12 frames).

Selecting the Multi-Image Screen

CAMERA

PLAY (VCR)

CARD CAMERA

CARD PLAY (VCR)

1. In CAMERA mode, set the program selector to **P**.

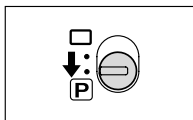

2. Press the **DIGITAL EFFECTS** button.

[D.EFFECTS **OFF**], [FADER], [EFFECT] and [MULTI-S] appear.

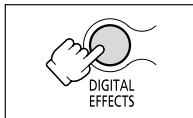

3. Select **[MULTI-S]**.

[S.SPEED] and [S.SPLIT] appears.

4. Select **[S.SPEED]**.

[MANUAL], [FAST], [MOD.] and [SLOW] appear.

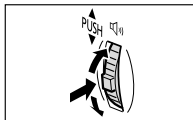

5. Select the transition speed.

6. Select **[MULTI-S]** again.

[S.SPEED] and [S.SPLIT] appears.

7. Select **[S.SPLIT]**.

[4], [9], [16] settings appear.

8. Select the number of sequences.

9. Press the **D.EFFECTS SELECT** button.

[MULTI-S] flashes.

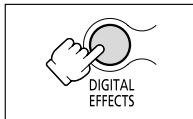

Using the Full Range of Features

Capturing

10. Press the ON/OFF button.

- **MANUAL:** Images will be captured each time you press the ON/OFF button. The blue frame indicating the next sequence disappears after the last image. To cancel the last captured image, press and hold the ON/OFF button. To cancel the multi-image screen, press and release the ON/OFF button.
- **FAST, MODERATE, SLOW:** The set number of images will be captured at the set speed. To cancel the multi-image screen, press the ON/OFF button.

11. Press the start/stop button begin recording.

The multi-image screen is recorded on the tape.



- The multi-image screen can be operated in record or record pause mode.
- You can operate the multi-image screen only in the following playback modes:
 - When [S.SPEED] is set to [MANUAL]: Playback pause, slow forward/reverse playback
 - When [S.SPEED] is set to [FAST], [MOD.] or [SLOW]: Playback pause
- The multi-image screen cannot be operated in Night and Super Night (OPTURA20) mode.
- The multi-image screen cannot be selected when Card Mix is activated.
- In PLAY (VCR) mode: Pressing any tape operation button (such as play or pause), or performing date/photo search cancels the multi-image screen.

Turning Off the Image Stabilizer



E

The image stabilizer allows you to obtain steady recordings even at telephoto. There is no need to turn off the image stabilizer during normal recording. However, the camcorder tries to compensate for horizontal movements and you may therefore decide to turn it off during panning. The image stabilizer cannot be turned off when the program selector is set to □.



Open the menu and select [CAMERA SET UP]. Select [IMAGE S. (IS)], set it to [OFF] and close the menu.

(IS) disappears.



- We recommend turning off the image stabilizer when you mount the camcorder on a tripod.
- The image stabilizer is designed to compensate a normal degree of camcorder shake.
- The image stabilizer cannot be used in CARD CAMERA mode.
- The image stabilizer cannot be used in Low Light mode.
- The image stabilizer might not be as effective when recording in dark places using the Night or Super Night (OPTURA20) mode.

Recording With the Self-Timer



E

CAMERA

PLAY (VCR)

CARD CAMERA

CARD PLAY (VCR)

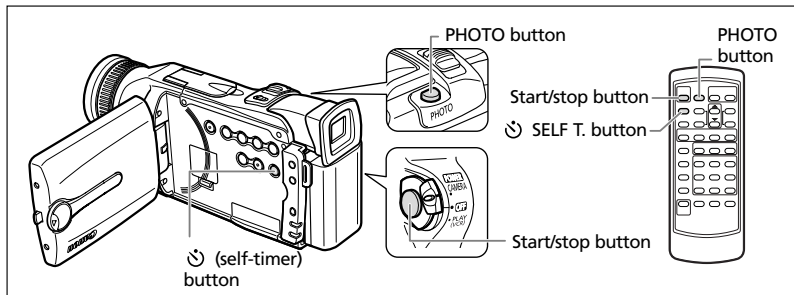

1. Press the (self-timer) button.

"" appears.



When recording movies

2. Press the start/stop button.

The camcorder starts recording after a 10-second countdown (2 seconds when using the wireless controller). The count down appears on the screen.

3. Press the start/stop button to stop recording.

The camcorder returns to record pause mode.

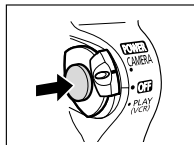

When recording still images

2. Press the PHOTO button.

- The camcorder starts recording after a 10-second countdown (2 seconds when using the wireless controller). The count down appears on the screen.
-  appears in green when recording begins.
- The camcorder records the still image for approx. 6 seconds and returns to record pause mode (in CARD CAMERA mode, it displays the still image when recording is complete).

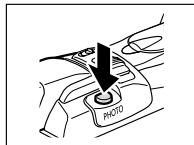

○ To cancel the self-timer, press the  (self-timer) button.

To cancel the self-timer once the countdown has begun, press the start/stop button (when recording movies) or PHOTO button (when recording still images).

○ The self-timer will be canceled when you turn off the camcorder.

Audio Recording



Changing the Audio Mode

You can record sound in two audio modes—16-bit and 12-bit. The 12-bit mode records sound on two channels (stereo 1), leaving 2 channels free (stereo 2) for adding new sound later. Select the 16-bit mode for higher sound quality.



Open the menu and select **[AUDIO SET UP]**. Select **[AUDIO MODE]**, set it to **[16bit]** and close the menu.

“16bit” appears for approximately 4 seconds.



For adding new sound, see *Audio Dubbing* (97).

Recording with an External Microphone

You can use an external microphone for recording. Almost all stereo microphones with a plug diameter of 0.14 inch (3.5 mm) can be connected to the MIC terminal. Use a microphone with a built-in power supply (condenser microphone).

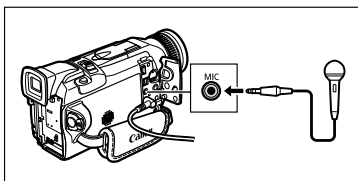

- The audio level differs from that of the built-in microphone.
- Be careful with long microphones as they may appear in the picture.
- See also *Using the DM-50 Microphone* (75).

Wind Screen

You can reduce the wind noise when recording in windy places.



Open the menu and select **[AUDIO SET UP]**. Select **[WIND SCREEN]**, set it to **[ON]** and close the menu.

“WS ON” appears when you turn the wind screen on.



- Low sound may be reduced together with the wind noise. We recommend turning off the wind screen for normal recordings.
- The wind screen function cannot be turned on/off during recording.
- The wind screen function can also be used for audio dubbing (when [AUDIO DUB.] is set to [MIC. IN] in the [AUDIO SET UP] submenu).
- The wind screen function cannot be used when an external microphone is connected to the MIC terminal or when the DM-50 Microphone is attached to the advanced accessory shoe.

Using Headphones during Recording

You can use headphones to monitor the sound during recording.



When using headphones, make sure that “🔊” is displayed. If “🔇” is not displayed change the setting following the procedure below.

Switching the AV/Headphones Terminal

CAMERA

PLAY (VCR)

CARD CAMERA

CARD PLAY (VCR)

MENU

(📖 43)

VCR SET UP

▶ AV / PHONES AV

Open the menu and select [VCR SET UP]. Select [AV/PHONES], set it to [AV] or [PHONES 🎧] and close the menu.

Adjusting the Headphone Volume

CAMERA

PLAY (VCR)

CARD CAMERA

CARD PLAY (VCR)

MENU

(📖 43)

AUDIO SET UP

▶ 🎧 VOLUME 📊

Open the menu and select [AUDIO SET UP]. Select [🎧 VOLUME], adjust the volume with the selector dial and close the menu.

You can turn off the volume completely by turning the selector dial down until [OFF] appears. Turn the selector dial up to increase the volume again.

Using the VL-3 Video Light (Optional)

This video light enables you to record brightly in color even in dark places. This VL-3 Video Light attaches to the camcorder's "S" advanced accessory shoe for cable-free operation and is powered by the camcorder's power supply.

Refer also to the VL-3 Video Light instruction manual.



- Always turn off the camcorder before attaching/removing the video light.
- Do not touch or place flammable material or plastic close to the lamp or the surrounding parts during or immediately after use; they become very hot.
- Do not look directly at the lamp while the video light is on.
- Do not carry the camcorder by the video light.

1. Remove the accessory shoe cover.

2. Slide the video light into the accessory shoe until it clicks.

3. Tighten the shoe lock.

Be careful that the video light does not come off when tightening the shoe lock.

4. Set the camcorder to CAMERA or CARD CAMERA mode.

5. Set the video light's power switch to AUTO or ON.

-  (Connection) appears.
- ON: The video light stays on.
- AUTO: The video light turns on and off automatically.

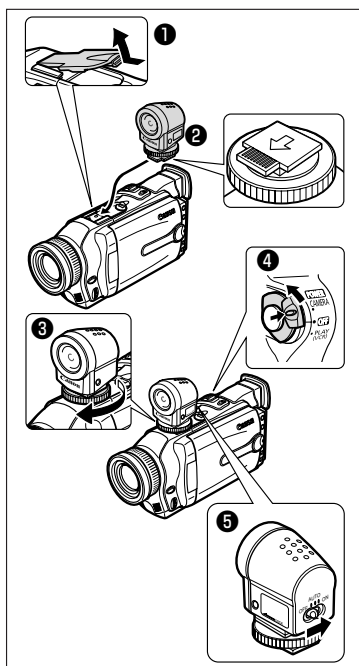

Using the VFL-1 Video Flash Light (Optional)

E

The VFL-1 Video Flash Light allows you to record still images and movies even at night or in dark places. This video flash light attaches to the camcorder's advanced accessory shoe for cable-free operation and is powered by the camcorder's power supply.

Using it as video light, you can set it to turn on and off automatically according to the surrounding brightness. Using it as flash, you can set it to fire automatically according to the brightness of the subject and the settings of the camcorder, or to fire a pre-flash to reduce the red-eye effect.

Refer also to the VFL-1 Video Flash Light instruction manual.



- Always turn off the camcorder before attaching/removing the video flash light.
- Do not carry the camcorder by the video flash light.

Attaching the Video Flash Light

1. Remove the accessory shoe cover.
2. Slide the video flash light into the accessory shoe until it clicks.
3. Tighten the shoe lock.

Be careful that the video flash light does not come off when tightening the shoe lock.

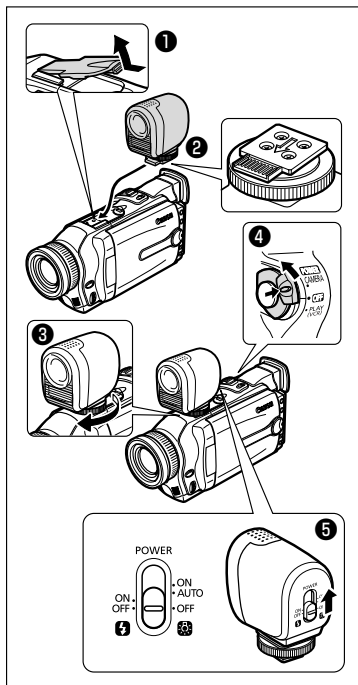

Using the Video Flash Light as Flash

Selecting the Flash Mode



1. Set the camcorder to **CAMERA** or **CARD CAMERA** mode.
2. Set the video flash light's **POWER** switch to **ON**.
3. Open the menu and select **[CAMERA SET UP]**. Select **[FLASH]**, select a setting option and close the menu.
 - **AUTO** ⚡^A: The flash fires automatically according to the brightness of the subject.
 - **RED-EYE** 👁: The flash fires automatically according to the brightness of the subject, and fires a pre-flash for red-eye reduction.
 - **FLASH ON** ⚡: The flash always fires.
 - **FLASH OFF** ⓧ: The flash does not fire. Use this setting in places where flash photography is prohibited.
 - The symbol of the selected flash mode appears on the screen. "⚡^A" disappears after 4 seconds.

Recording a Still Image with Flash

1. Press the **PHOTO** button halfway.

● appears in green.

2. Press the **PHOTO** button fully.

The flash fires and the still image shown on the screen will be recorded.



- Do not fire the flash close to people's eyes.
- Do not fire the flash at persons while they are driving.
- Do not fire the flash with the flash bulb covered with your hand.



- The practical range of the flash is approx. 3.3 to 18 ft. (1 to 5.5 m). The range depends upon the recording condition.
- The camcorder fires a pre-flash to obtain the subject's exposure data and adjusts the main flash to the optimal intensity (flash exposure compensation). When **[RED-EYE]** is set, the pre-flash fires between the flash for red-eye reduction and the main firing (the main firing takes place about 1 second after the flash for red-eye reduction).
- The effect of flash photography may not be obtained in bright places.
- For the red-eye reduction mode to be effective, the subject needs to look at the flash. The degree of reduction depends upon the distance and on each individual.

- The red-eye reduction mode cannot be used in stitch assist mode.
- The flash cannot be used in Night and Super Night (OPTURA20) mode.
- The flash will not fire in the following cases:
 - When you press the EXP button in [AUTO ⚡^] or [RED-EYE Ⓞ] mode.
 - When a shutter speed of 1/2000 or faster is set in CAMERA mode (the flash mark appears in purple). However, if [FLASH ON ⚡] is selected, the display of the selected shutter speed flashes in purple for 4 seconds and the shutter speed becomes set to 1/1000; the flash fires.
 - When an abnormality occurs during charging (the flash mark flashes in red).
 - When the multi-image screen is selected or when you are recording movies onto a tape (no flash mark appears).
 - When the flash mark does not appear in green when you press the PHOTO button. Set it to [FLASH ON ⚡] if necessary.
- When the flash is fired with an accessory such as an optional tele-converter attached to the camcorder, its shadow may be recorded.
- An image recorded with flash may flicker when played back on a different device.

Using the Video Flash Light as Video Light

CAMERA

PLAY (VCR)

CARD CAMERA

CARD PLAY (VCR)

1. Set the camcorder to **CAMERA** or **CARD CAMERA** mode.

2. Set the video flash light's **POWER** switch to **ⓄAUTO** or **ⓄON**.

- **Ⓞ** (Connection) appears.
- **ON**: The video light stays on.
- **AUTO**: The video light turns on and off automatically.



- Do not touch or place flammable material or plastic close to the lamp or the surrounding parts during or immediately after use; they become very hot.
- Do not look directly at the lamp while the video light is on.

Using the DM-50 Microphone (Optional)

The high sensitive Directional Stereo Microphone DM-50 attaches to the „S“ advanced accessory shoe for cable-free operation and is powered by the camcorder's power supply. Use it for recording or dubbing audio.

Refer also to the DM-50 Microphone instruction manual.



- Always turn the camcorder off before attaching/removing the microphone.
- Do not connect any microphone to the MIC terminal when the DM-50 Microphone is connected.
- Do not carry the camcorder by the microphone.

1. Remove the accessory shoe cover.

2. Slide the microphone into the accessory shoe until it clicks.

3. Tighten the shoe lock.

Be careful that the microphone does not come off when tightening the shoe lock.

4. Set the camcorder to CAMERA or CARD CAMERA mode.

 (Connection) appears.

5. Set the microphone's directivity switch.

- SHOTGUN: For recording clear sound from the front (monaural).
- STEREO 1: For recording sound from the front and surrounding area.
- STEREO 2: For recording surrounding sound in a wider range than in STEREO 1.

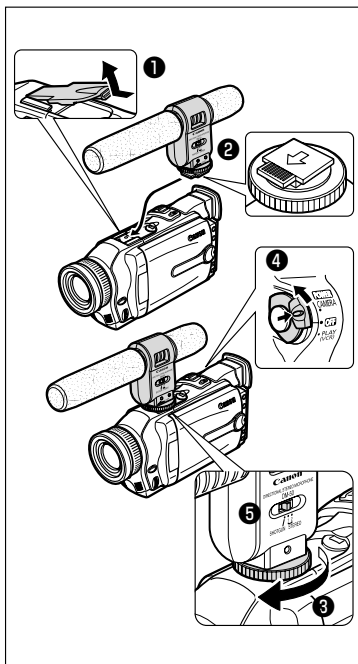

Adjusting the Focus Manually



E

Autofocus may not work well on the following subjects:

Reflective surfaces



Subjects with low contrast (e.g. White Wall)

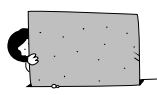

Fast Moving Subjects



Horizontal Stripes



Through dirty or wet windows



Different Distances



Dark Subjects



Night Scenes



CAMERA

PLAY (VCR)

CARD CAMERA

CARD PLAY (VCR)

1. Set the program selector to **P**.

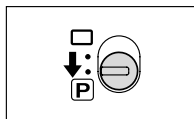

2. Adjust the zoom.

When you operate the zoom after adjusting the focus, the subject may not stay in focus. Adjust the zoom before the focus.

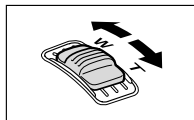

3. Press the FOCUS button.

"MF" appears.

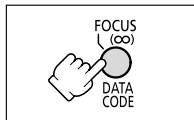

4. Turn the focus ring to adjust the focus.

- Turn the focus ring up or down until the image appears focused.



5. Press the FOCUS button to return to autofocus.

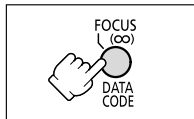

The setting resets to autofocus when you switch the program selector to .

Infinity Focus

Use this function when you wish to focus on faraway subjects such as mountains or fireworks.

Press the focus button more than 3 seconds in step 3.

"MF ∞" appears. When you operate the zoom or turn the focus ring, "∞" disappears and the camcorder changes to manual focus.

Optura 20 AF-Assist Lamp (Optional VFL-1 Attached)

When you attach the VFL-1 Video Flash Light to the camcorder and set it to fire a flash (📖 73), the AF-assist lamp (White LED) illuminates the subject in the center of the screen to enable the camcorder to focus in dark places.



When you press the PHOTO button halfway, the AF-assist lamp turns on automatically responding to the surrounding brightness.



When you press the PHOTO button halfway and turn the focus ring, the AF-assist lamp turns on responding to the surrounding brightness.



- The camcorder may not be able to focus even though the AF-assist lamp is lighting. In such case, adjust the focus manually.
- The AF-assist lamp lights up brightly. Consider turning off the AF-assist lamp in public places such as in restaurants or theaters.
- Turn off the AF-assist lamp in places where flash photography is prohibited.

Turning Off the AF-Assist Lamp



To turn off the AF-assist lamp, open the menu and select [CAMERA SET UP]. Select [AF AST LAMP], set it to [OFF] and close the menu.

Adjusting Exposure Manually

E

Exposure Lock

You can lock the exposure when recording in situations where the lighting may change suddenly to control the brightness of the image.

CAMERA

PLAY (VCR)

CARD CAMERA

CARD PLAY (VCR)

1. Set the program selector to **P**.

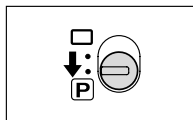

2. Press the **EXP** button.

- "E.LOCK ±0" appears on the screen.
- When you operate the zoom, the brightness of the image may change.

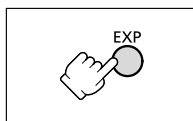

Exposure Adjustment

When the exposure is locked, you can adjust it manually to handle difficult lighting conditions. The camcorder's iris can be set to any position from fully closed to fully open.

CAMERA

PLAY (VCR)

CARD CAMERA

CARD PLAY (VCR)

Turn the selector dial to adjust the brightness of the image.

- To make the image brighter, turn the selector dial up (to a maximum of +11).
- To make the image darker, turn the selector dial down (to a minimum of -11).

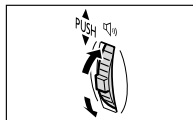

Press the **EXP** button to return to auto exposure.

Setting the Shutter Speed



In the **[A]** (Auto) mode, you can adjust the shutter speed manually to make stable shots of fast moving subjects.

CAMERA

PLAY (VCR)

CARD CAMERA

CARD PLAY (VCR)

MENU

(43)

CAMERA SET UP

▶ SHUTTER.....AUTO

1. Set the program selector to **[P]**.
2. Set the program AE mode to the **[A] AUTO** mode.
3. Open the menu and select **[CAMERA SET UP]**.
4. Select **[SHUTTER]**.
5. Select the shutter speed and press the selector dial.

CAMERA Mode	CARD CAMERA Mode
AUTO	AUTO
1/60	1/60
1/100	1/100
1/250	1/250
1/500	
1/1000	
1/2000	
1/4000	
1/8000	

6. Close the menu.



- Do not point the camcorder directly at the sun when the shutter speed is set to 1/1000 or higher.
- The image may flicker when recording with high shutter speeds.
- The setting resets to the auto setting when you switch the program selector to , or change the program AE mode.
- If the shutter speed is set to 1/500 or higher in CAMERA mode and you switch to CARD CAMERA mode, it automatically changes to 1/250.
- Recording under fluorescent lights: When the camcorder is set to (Easy Recording) or when the program AE mode is set to Auto, Night or Super Night (OPTURA20) mode, it automatically detects the flicker of fluorescent lighting and adjusts the shutter speed accordingly. However, if the brightness of the screen starts to flicker, select Auto mode and set the shutter speed to 1/100.

○ Guidelines for Recording with High Shutter Speeds:

- Outdoor sports such as golf or tennis: 1/8000, 1/4000, 1/2000
- Moving objects such as cars or roller coasters: 1/1000, 1/500 or 1/250
- Indoor sports such as basketball: 1/100









Setting the White Balance

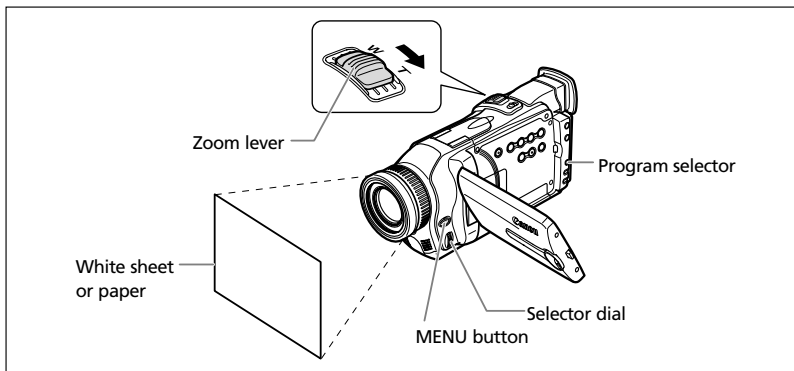

E

The camcorder's auto white balance system adjusts the colors to appear natural for different lighting conditions. However, you can use the preset modes to reproduce colors more accurately, or set a custom white balance to obtain the optimal setting.



- When the program selector is set to , white balance is preset to [AUTO]. Indoor, outdoor and custom white balance cannot be selected.
- The camcorder retains the setting even if you turn it off.
- When you have set the custom white balance:
 - Reset the white balance when the lighting condition changes.
 - Turn off the digital zoom.
- Setting the white balance manually may provide better results in the following cases:
 - Changing lighting conditions
 - Close-ups
 - Subjects in a single color (sky, sea or forest)
 - Under mercury lamps or certain types of fluorescent lights
- Use the  Indoor or  Outdoor mode in the following cases:
 -  Indoor:
 - Changing lighting condition
 - Under video light
 - Under sodium lamps
 -  Outdoor:
 - For night scenes or fireworks
 - Sunrise or sunset
 - * Use the auto setting for normal outdoor scenes.





MENU

(43)





CAMERA SET UP

▶ WHITE BAL...AUTO

For  (Indoor) or  (Outdoor) Setting:

1. Set the program selector to .
2. Open the menu and select [CAMERA SET UP].
3. Select [WHITE BAL.].
4. Select [INDOOR ] or [OUTDOOR ].
“” or “” appears.
5. Close the menu.

For Custom White Balance:

1. Set the program selector to .
2. Open the menu and select [CAMERA SET UP].
3. Select [WHITE BAL.].
4. Point the camcorder at a white object (such as a sheet of paper), zoom in until it fills the whole screen and select [SET ].
 -  flashes and stops flashing when settings is complete.
 - Depending on the light source,  may keep flashing. The result will still be better than with the auto setting.
5. Close the menu.

Magnifying the Image



The playback image can be magnified up to 5 times.

CAMERA

PLAY (VCR)

CARD CAMERA

CARD PLAY (VCR)

E

1. Move the zoom lever toward **T**.

- The image is magnified by 2 times.
- To further enlarge the image, move the zoom lever toward **T**. To shrink the image below 2 times magnification, move the zoom lever toward **W**.
- A frame appears indicating the position of the enlarged part.

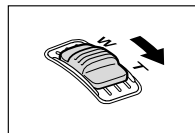

2. Move the image.

- Turn the selector dial to move the image to the right and left, or up and down. Pressing the selector dial switches between the directions.
- To cancel the magnification, move the zoom lever toward **W** until the frame disappears.

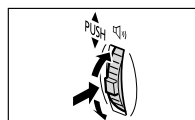

Movies played back from a memory card cannot be magnified.

Displaying the Data Code



E

Once date and time are set, the camcorder maintains a data code containing recording date and time and other camera data such as shutter speed and exposure (f-stop). Only date and time appear when playing back a memory card.

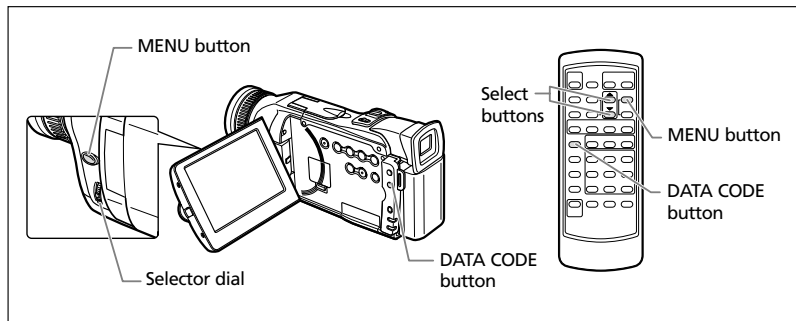

- The data code display turns off when you turn the camcorder off.
- The data code may not be displayed if a recording made with this camcorder is played back on a different digital camcorder.
- The data code cannot be displayed in frame advance/reverse playback. Camera data may not appear in some special playback modes.
- When the TV screen displays are hidden (140), the displays still appear on the LCD screen. If you turn on the data code, displays other than the data code will disappear from the LCD screen.

Available Data Code Combinations (in PLAY (VCR) mode):

D/TIME SEL. \ DATA CODE (tape only)	Date/Time	Camera data	Date/Time & Camera data
Date	JAN. 1, 2003	F1.8 1/250	F1.8 1/250 JAN. 1, 2003
Time	12:00:00 PM	F1.8 1/250	F1.8 1/250 12:00:00 PM
Date & Time	12:00 PM JAN. 1, 2003	F1.8 1/250	F1.8 1/250 12:00 PM JAN. 1, 2003

Selecting the Date/Time Display Combination



MENU

(43)

DISPLAY SET UP

D/TIME SEL. . . DATE & TIME

Open the menu and select [DISPLAY SET UP]. Select [D/TIME SEL.], set it to [DATE] or [TIME] and close the menu.

Selecting the Data Code Display Combination



MENU

(43)

DISPLAY SET UP

DATA CODE DATE / TIME

Open the menu and select [DISPLAY SET UP]. Select [DATA CODE], set it to [CAMERA DATA] or [CAM. & D/T] and close the menu.

Displaying the Data Code



Press the **DATA CODE** button.

Only date and time appear in CARD PLAY (VCR) mode.

Six-Second Auto Date

Date and time appear for 6 seconds when you begin playback, or to indicate that date or time zone has changed.



MENU

(43)

DISPLAY SET UP

6SEC. DATE OFF

Open the menu and select [DISPLAY SET UP]. Select [6SEC.DATE], set it to [ON] and close the menu.



Photo Search/Date Search

E

You can search for a still image recorded anywhere on the tape with the photo search function, or locate the change of the date/time zone with the date search function.

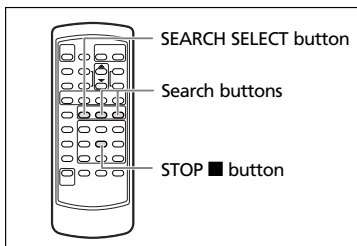

CAMERA

PLAY (VCR)

CARD CAMERA

CARD PLAY (VCR)

1. Press the SEARCH SELECT button to choose between photo search and date search.

“PHOTO SEARCH” or “DATE SEARCH” appears.

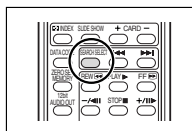

2. Press the ►► or ◀◀ button to begin searching.

- Press the ►► button to search forward and the ◀◀ button to search backward.
- Press more than once to search for further still images or date changes (up to 10 times).
- Press the ►► or ◀◀ button to change the search direction.
- Press the ■ (stop) button stop searching.

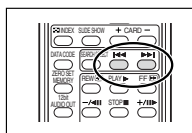

- Photo search: A still image recorded very close to the point you start the search may not be detected.
- Date search: A recording of longer than a minute per date/area is required.
- Date search: Playback may start slightly before or after the date change.
- Date search may not function if the data code is not correctly displayed.

Recording to a VCR or Digital Video Device

E

You can copy your recordings by connecting the camcorder to a VCR or a digital video device. If you connect a digital video device, you can copy recordings with virtually no generation loss in image and sound quality.



When connecting a VCR:

○ Make sure that “V” is not displayed on the screen. If “V” is displayed, change the setting (📖 70).

○ The quality of the edited tape will be slightly lower than that of the original.

When connecting a digital video device:

○ You can connect only one device to the camcorder with the DV cable.

○ Blank sections may be recorded as anomalous picture.

○ If the picture does not appear, reconnect the DV cable or turn the camcorder off and back on again.

Example: Recording to a VCR

CAMERA

PLAY (VCR)

CARD CAMERA

CARD CAMERA

1. Connect the camcorder to the VCR.

See *Playing Back on a TV Screen* (📖 40).

2. Set the camcorder to **PLAY (VCR)** mode and load a recorded cassette.

3. Connected device: Load a blank cassette and set the device to record pause mode.

4. Locate the scene you wish to copy and pause playback shortly before the scene.

5. Play back the tape.

6. Connected device: Begin recording when the scene you wish to copy appears. Stop recording when copying is complete.

7. Stop playback.

Editing

Connecting a Digital Video Device

Refer also to the instruction manual of the digital video device.

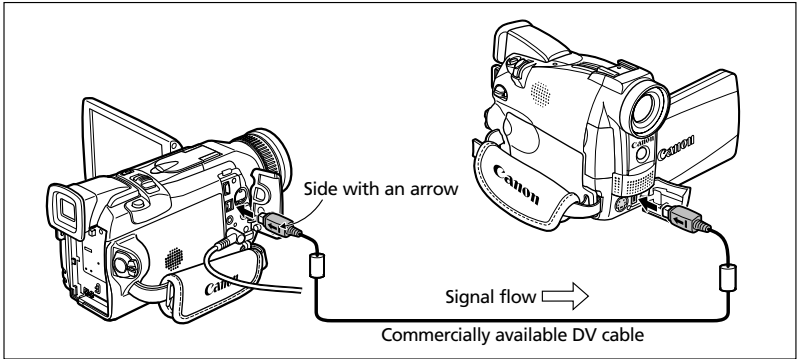

E

Recording from Analog Video Devices (VCR, TV or Camcorder)



E

You can record videos or TV programs from a VCR or analog camcorder on the tape in the camcorder.



- Anomalous signals sent from the connected device may be recorded as anomalous picture (although it may not appear so on the screen), or it may not be recorded at all.
- You cannot record from tapes with copyright protective signals.
- Headphones cannot be used during analog line-in recording. If the AV/headphones terminal set to [PHONES \square], it will automatically switch to [AV].

CAMERA

PLAY (VCR)

CARD CAMERA

CARD CAMERA

1. Connect the camcorder to the analog video device.

See *Playing Back on a TV Screen* (📖 40).

2. Set the camcorder to **PLAY (VCR)** mode and load a blank cassette.

3. Connected device: Load the recorded cassette.

4. Press the **REC PAUSE** button.

In record pause mode and during recording, you can check the picture on the screen.

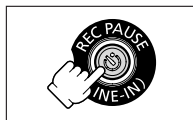

5. Connected device: Play back the tape.

6. Press the **▶/||** button when the scene you wish to record appears.

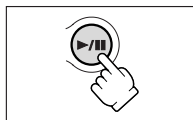

7. Press the **■** button to stop recording.

- Press the **▶/||** button to pause recording.
- Press the **▶/||** button again to restart recording.

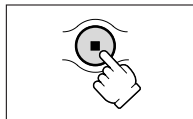

8. Connected device: Stop playback.

Editing

Recording from Digital Video Devices (DV Dubbing)



E

You can record from other digital video devices equipped with a DV terminal with virtually no loss in picture and sound quality.



- When recording from digital video devices, make sure that "AV → DV" is not displayed on the screen. If "AV → DV" is displayed, change the setting (📖 94).
- Anomalous signals sent from the connected device may be recorded as anomalous picture (although it may not appear so on the screen), or it may not be recorded at all.
- Copyright protected signals cannot be recorded.
- Blank sections may be recorded as anomalous picture.
- If the picture does not appear, reconnect the DV cable or turn the camcorder off and back on again.



- You can connect only one device with the DV cable.
- You can use the camcorder for playback and recording without reconnecting the DV cable.

CAMERA

PLAY (VCR)

CARD CAMERA

CARD CAMERA

1. Connect the camcorder to the digital video device.

See *Connecting a Digital Video Device* (📖 89).

2. Set the camcorder to **PLAY (VCR)** mode and load a blank cassette.

"DV IN" appears.

3. Connected device: Load the recorded cassette.

4. Press the REC PAUSE button.

In record pause mode and during recording, you can check the picture on the screen.

5. Connected Device: Play back the tape.

6. Press the ►/|| button when the scene you wish to record appears.

7. Press the ■ button to stop recording.

- Press the ►/|| button to pause recording.
- Press the ►/|| button again to restart recording.

8. Connected Device: Stop playback.

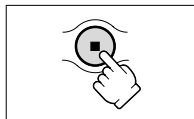

Editing

Copyright Signal

E

Certain software tapes are copyright protected. If you attempt to play back such tape, "COPYRIGHT PROTECTED PLAYBACK IS RESTRICTED" appears and you will not be able to view the contents of the tape. If you attempt to record from such tape via the DV terminal, "COPYRIGHT PROTECTED DUBBING RESTRICTED" appears and you will not be able to record the contents of the tape.

Converting Analog Signals into Digital Signals (Analog-Digital Converter)



E

By connecting the camcorder to a VCR or 8mm video camcorder, you can convert analog video/audio signals to digital signals and output the digital signals via the DV terminal. The DV terminal serves as output terminal only.



- Headphones cannot be used during analog-digital conversion.
- Unload the tape from the camcorder.
- Turn off all devices before starting the connections.
- Depending on the signal sent from the connected device, the conversion from analog to digital signals might not work properly (e.g., signals that include copyright protective signals or anomalous signals such as ghost signals).



We recommend powering the camcorder from a household power source.

Connecting the Devices

This illustration shows how to connect using a S-video cable. You can also connect the yellow plug of the stereo video cable to the VIDEO terminal. Refer also to the instruction manual of the connected device.

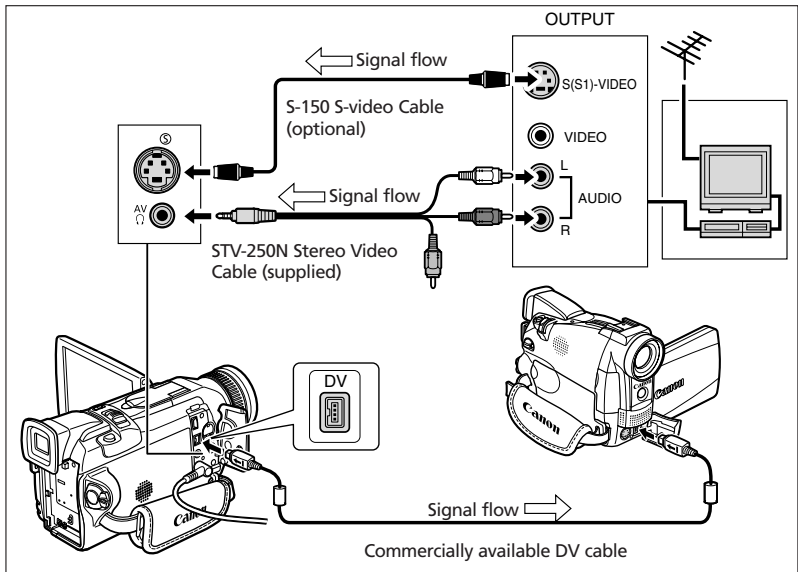

Editing

Turning On the Analog-Digital Converter

CAMERA

PLAY (VCR)

CARD CAMERA

CARD CAMERA

E

Press the **AV → DV** button on the wireless controller.

OR

MENU

(book 43)

VCR SET UP

▶▶ AV→DV OUT...OFF

Open the menu and select [VCR SET UP]. Select [AV→DV OUT], set it to [ON] and close the menu.



- For normal use, set [AV→DV OUT] to [OFF] (so that "AV→DV" does not appear on the screen). If it is set to [ON], digital signals cannot be input via the camcorder's DV terminal.
- Depending on the software and the specifications of your computer, you may not be able to transfer converted signals via the DV terminal.

Replacing Existing Scenes (AV Insert)



You can insert and replace images/audio on the tape of the camcorder with images/audio from other video devices connected via AV terminal or DV terminal.

E

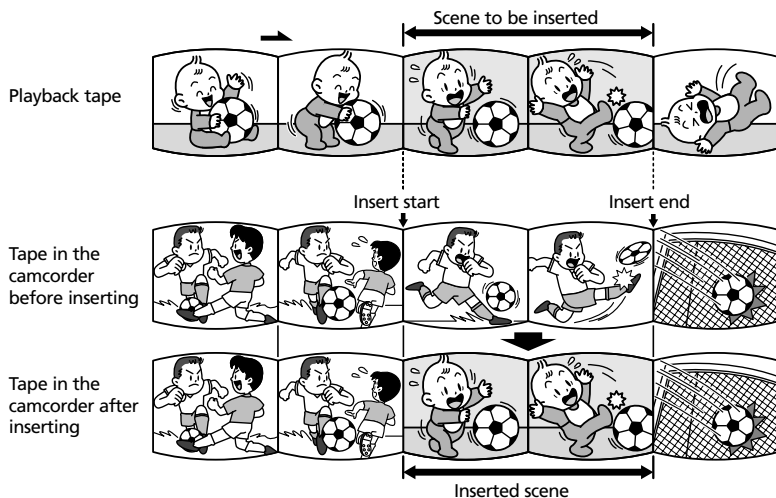

○ You cannot insert from a TV program when the synchronized signals are distorted.

Camcorder:

○ Use only tapes recorded in SP mode.

○ AV insert will stop if the camcorder detects a blank section or a section not recorded in SP mode on the tape.

Connected device:

○ Use only tapes without blank sections.

○ AV insert may not work correctly if the tape has a blank section or changes in the recording mode.

○ AV insert cannot be performed when the quality of the recording is poor, or during special playback such as fast forward, rewind, playback pause, slow playback etc.

Example: AV Insert from a VCR

CAMERA

PLAY (VCR)

CARD CAMERA

CARD CAMERA

E

1. Connect the camcorder to the VCR.

See *Playing Back on a TV Screen* (□ 40).

2. VCR: Load a recorded cassette. Locate the scene you wish to insert and pause playback shortly before the scene.

3. Set the camcorder to PLAY (VCR) mode and load a recorded cassette.

Make sure the tape-protect switch is set to allow recording.

4. Locate the scene you wish to replace and pause playback shortly before the scene.

You can use the playback buttons on the camcorder or the special playback buttons on the wireless controller.

5. Press the AV INSERT button on the wireless controller.

"AV INSERT" and "●|||" appear.

6. VCR: Play back the tape.

7. Press the PAUSE ||| button on the wireless controller when the scene you wish to insert appears.

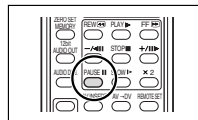
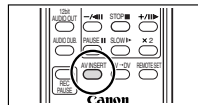

8. Press the STOP ■ button on the wireless controller to stop inserting.

Press the PAUSE ||| button on the wireless controller to pause inserting.

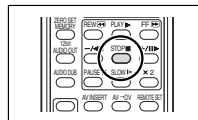

9. VCR: Stop playback.



Set the zero set memory at the end of the scene you wish to replace. The camcorder will automatically stop AV insert at that point.

Audio Dubbing



You can add sound from audio devices (AUDIO IN) or with the built-in or an external microphone (MIC. IN).

E



- Use only tapes recorded in SP mode 12-bit audio sound with this camcorder. Audio dubbing will stop if the tape has a blank section or a section recorded in LP mode, 16-bit or 12-bit 4-channel sound. In above case, create a copy in SP mode 12-bit audio sound using the analog line-in function.
- Do not connect/disconnect any cable to/from the camcorder while dubbing.
- You cannot use the DV terminal for audio dubbing.
- If you add sound to a tape not recorded with this camcorder, sound quality may decrease.
- Sound quality may decrease when you add sound to the same scene for more than 3 times.

Connecting an Audio Device

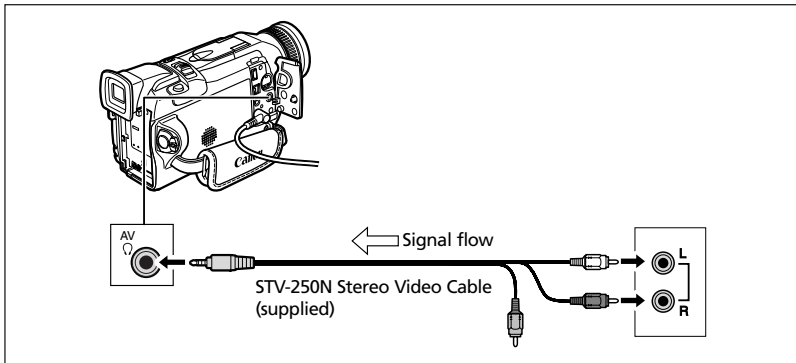

Editing



You can monitor the picture on the LCD screen or a TV connected via the S-video terminal, and check the sound with the built-in speaker.

Using a Microphone

E

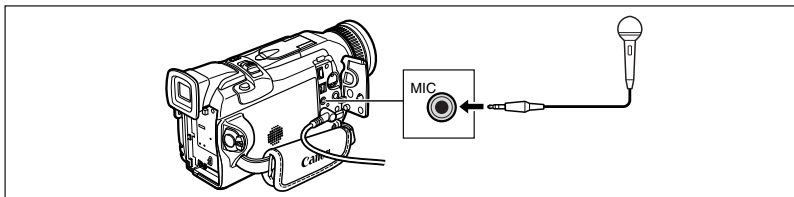

- When using the built-in microphone: Do not connect any cables to the microphone terminal or the accessory shoe.
- When using an external microphone: Connect it to the microphone terminal.
- When using the DM-50 Microphone: Do not connect any cables to the microphone terminal.
- When you connect a TV via the S-video terminal, you can check the picture on the TV screen and the sound with headphones connected to the camcorder. When you connect a TV via the AV terminal, you can check the picture on the TV screen but you cannot check the sound with headphones.

Dubbing

CAMERA

PLAY (VCR)

CARD CAMERA

CARD CAMERA

MENU

(43)

AUDIO SET UP

AUDIO DUB...AUDIO IN

Editing

1. Set the camcorder to **PLAY (VCR)** mode and load a recorded cassette.
2. Open the menu and select **[AUDIO SET UP]**. Select **[AUDIO DUB.]**, set it to **[AUDIO IN]** or **[MIC. IN]** and close the menu.
3. Locate the scene you wish audio dubbing to start.
4. Press the **PAUSE** **||** button on the wireless controller.
5. Press the **AUDIO DUB.** button on the wireless controller.
 - “AUDIO DUB.” and “ **||** ” appear.
 - If the optional DM-50 microphone is attached, **☑** (Connection) appears.
6. Press the **PAUSE** **||** button on the wireless controller to begin dubbing.
 - Audio device: Begin playback.
 - Microphone: Direct your voice to the microphone.

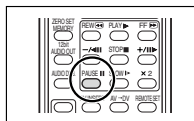
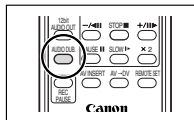

7. Press the STOP ■ button on the wireless controller to stop dubbing.

Audio device: Stop playback.

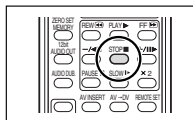

E



Set the zero set memory at the end of the scene you wish to dub audio. The camcorder will automatically stop audio dubbing at that point.

Playing Back the Added Sound



You can select to play back Stereo 1 (original sound), Stereo 2 (added sound), or adjust the balance of both sounds.

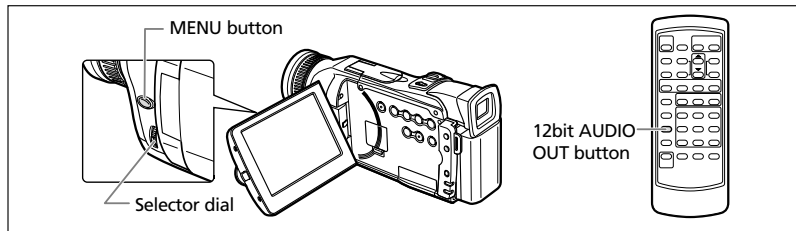

CAMERA

PLAY (VCR)

CARD CAMERA

CARD CAMERA

MENU

(43)

AUDIO SET UP

▶ 12bit AUDIO...STEREO1

1. Open the menu and select [AUDIO SET UP]. Select [12bit AUDIO OUT], select a setting and close the menu.

- STEREO1: Plays back the original sound.
- STEREO2: Plays back the added sound.
- MIX/FIXED: Plays back stereo 1 and stereo 2 in the same level.
- MIX/VARI.: Plays back stereo 1 and stereo 2. The mix balance can be adjusted.

2. If you have selected [MIX/VARI.], adjust the mix level: Open the menu and select [AUDIO SET UP]. Select [MIX BALANCE], adjust the balance with the selector dial and close the menu.

Turn the selector dial down to increase the volume of Stereo 1 and up to increase the volume of Stereo 2.



- The camcorder resets to [STEREO1] when you turn the camcorder off. However, the mix balance is memorized by the camcorder.
- You can also press the 12bit AUDIO OUT button on the wireless controller to select the audio output. However, the mix balance can only be adjusted in the menu.

Connecting to a Computer Using a DV (IEEE1394) Cable

E

You can transfer recordings to a computer equipped with a DV (IEEE1394) terminal or IEEE1394 capture board (optional software required).

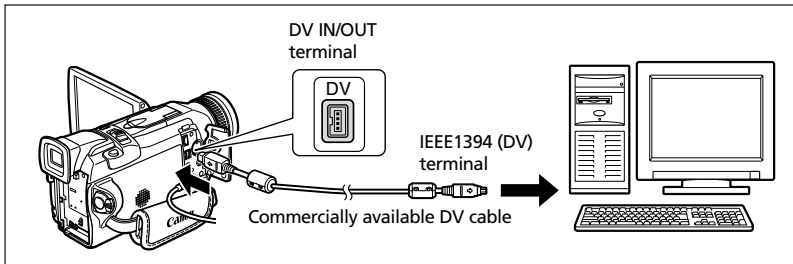

- Do not disconnect the DV cable, or turn off the camcorder or computer while data is being transferred to the computer.
- Operation may not work correctly depending on the software and the specifications/settings of your computer.



- We recommend powering the camcorder from a household power source while it is connected to the computer.
- Refer also to the instruction manual of the computer.
- Optional software required. Refer also to the instruction manual of the software.
- For transferring recordings from a memory card to the computer using a USB cable, see p. 135.

Editing

DV NETWORK SOLUTION DISK (Windows XP Users)

Windows XP users can use the software on the supplied DV NETWORK SOLUTION DISK to perform videoconference and file transfer over the Internet, or upload files from the computer to the memory card and use the camcorder as card reader/writer. The available functions depend upon the camcorder model and the networking environment. For details, refer to the DV NETWORK SOLUTION DISK Software Instruction Manual.





- Do not disconnect the DV cable, remove the memory card or turn off the camcorder or computer while data is being transferred to the computer (while the camcorder's card access indicator is flashing). Doing so may damage the memory card's data.
- The image files on your memory card and the image files saved on the hard disk drive of your computer are your valuable, original data files. If you wish to use image files on your computer, be sure to make copies of them first, retaining the original.

Inserting and Removing the Memory Card

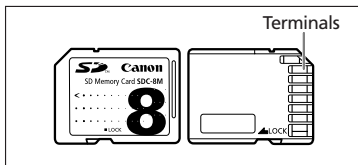
You can use  SD Memory Cards or a commercially available MultiMediaCards with this camcorder. The SD Memory Card has a protect switch for prevent accidental erasure.



- This camcorder is compatible with SD Memory Cards or MultiMediaCards only. Do not use any other types of memory cards.
- Turn off the camcorder before inserting or removing the memory card. Otherwise, it may result in data damage.
- Do not touch the memory card terminals.
- If you use memory cards other than the supplied one, make sure to format them with the camcorder ( 134).
- For instructions on how to connect the camcorder to the computer, see *Connecting to a Computer Using a USB Cable* ( 135).

Inserting the Card

1. Turn off the camcorder.
2. Open the cover.
3. Insert the memory card all the way into the memory card slot.
4. Close the cover.

Do not close the cover forcefully without having the card correctly inserted.

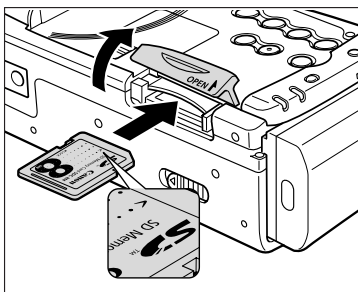

Removing the Card

Do not forcefully remove the memory card without first pushing it in.

1. Turn off the camcorder.
Make sure that the card access indicator is not flashing before you turn off the camcorder.
2. Open the cover.
3. Push the memory card to release it.
Remove the memory card.
4. Close the cover.

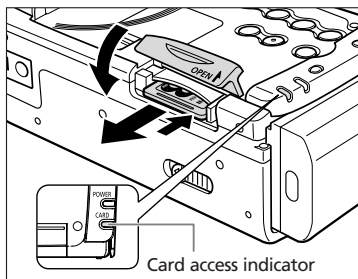

Selecting the Image Quality/Size



E Changing the Still Image Quality

You can choose between Superfine, Fine and Normal.



Open the menu and select [CARD SET UP]. Select [SI QUALITY], set it to [SUPER FINE] or [NORMAL] and close the menu.

Changing the Still Image Size

You can choose between 1280 × 960 pixels and 640 × 480 pixels.



Open the menu and select [CARD SET UP]. Select [SI SIZE], set it to [640x480] and close the menu.



- Still images recorded in 1280 × 960 pixels may not be displayed correctly in a camcorder not supporting this size.
- Still images are compressed and recorded in the JPEG (Joint Photographic Experts Group) format.
- Depending on subject and recording condition, changing the image quality may not show a significant difference.
- Estimated Capacity of a 8 MB Memory Card and File Size per Image:

Image Size	1280 × 960		640 × 480	
	No. of Images	File Size per Image	No. of Images	File Size per Image
Superfine	6 images	850 KB	34 images	175 KB
Fine	10 images	550 KB	50 images	120 KB
Normal	18 images	300 KB	84 images	65 KB

These figures are approximate. They vary according to the recording condition and the subject. Sample images already recorded on the supplied SD Memory Card are to be included in the total number.

- Remaining Image Capacity:
 - flashing in red: No card
 - in green: 6 or more images
 - in yellow: 1 to 5 images
 - in red: No more images

- The indication may not decrease even though a recording has been made, or may decrease by 2 images at once.
- All indicators are displayed in green when a memory card is played back.
- The remaining image capacity indicates the number of still images, even when movies are recorded.

Changing the Movie Size

You can choose between 320 × 240 pixels and 160 × 120 pixels.



Open the menu and select [CARD SET UP]. Select [MOVIE SIZE], set it to [160×120] and close the menu.



- Movies are recorded in the Motion JPEG format.
- Maximum continuous recording time:

Image Size	Max. Continuous Recording Time	Total File Size	File Size per Second
320 × 240	10 sec.	2.7 MB	270 KB/sec.
160 × 120	30 sec.	2.7 MB	90 KB/sec.

File Numbers

Images are automatically assigned file numbers from 0101 to 9900 and stored in folders containing up to 100 images. Folders are assigned numbers from 101 to 998. (The sample images on the supplied memory card are saved in the [100canon] folder.)

You can choose to use consecutive file numbers (CONTINUOUS) or to reset the file number each time a different memory card is inserted (RESET). We recommend setting the file numbers to CONTINUOUS.

CONTINUOUS

The camcorder memorizes the file number of the last image and assigns the consecutive file number to the next image, even when a new memory card is inserted. (If a higher file number already exists on the memory card, the consecutive number will be assigned.) There will be no duplication of file numbers. This is useful for organizing images on a computer.

RESET

The file number will be reset each time a new memory card is inserted, starting with 101-0101. If the memory card already contains image files, the consecutive file number will be assigned.

When you record 3 images on the supplied memory card.

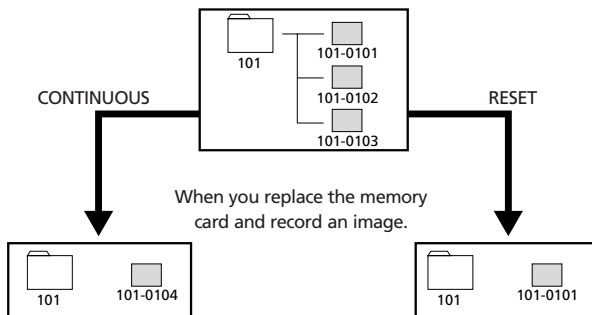

CAMERA

PLAY (VCR)

CARD CAMERA

CARD PLAY (VCR)

MENU

(43)

CARD SET UP

FILE NOS. . . . CONTINUOUS

To change the setting, open the menu and select [CARD SET UP]. Select [FILE NOS.], set it to [RESET] and close the menu.

Recording Still Images on a Memory Card



You can record still images with the camcorder, from a tape in the camcorder (📖 108) or from devices connected via the DV terminal or AV terminal (📖 109).

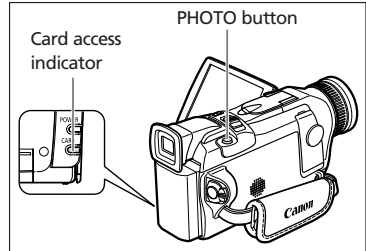

E



- Do not turn off the camcorder, disconnect the power source or remove the memory card while the card access display (<<< or >>>) in the upper right corner of the screen or the card access indicator is flashing. Doing so could result in data damage.
- When you are using a SD Memory Card, make sure that the protect switch is set to allow recording.



Make sure to insert a memory card with enough remaining capacity.

Recording with the Camcorder

In autofocus mode, the camcorder keeps focusing automatically. Furthermore, this camcorder is equipped with the Focus-Priority mode for even more accurate focus. In Focus-Priority mode, you can choose between three focusing points (📖 106). However, you can turn off the Focus-Priority mode if you wish to put timing ahead of focusing (📖 107).

When the program selector is set to , the Focus-Priority mode is set to ON (only the center focusing point available).

CAMERA

PLAY (VCR)

CARD CAMERA

CARD PLAY (VCR)

1. Set the camcorder to CARD CAMERA mode.

A white focusing frame appears in the center of the screen. The camcorder will focus on the subject in the center of the screen. To change the focusing point, see *Selecting a Focusing Point* (📖 106).

2. Press the PHOTO button halfway.

-  and focusing frame turn green when focus is adjusted. The beep sounds twice. The picture may appear out of focus for a moment while the camcorder is focusing.
- Exposure is locked.
- Focus can be adjusted manually with the focus ring when the PHOTO button is pressed halfway.
- When you press the PHOTO button on the wireless controller, recording starts immediately.

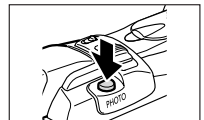

3. Press the PHOTO button fully.

- disappears and you hear a shutter sound.
- The card access indicator flashes and the card access display appears.
- The still image shown on the screen will be recorded on the memory card.

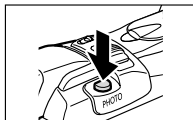

- To use the self-timer (68), press the (self-timer) button before step 2 and press the PHOTO button fully.
- If the subject is not suitable for autofocus, the focusing frame turns yellow and locks the focus. The confirmation sound beeps once. Adjust the focus manually with the focus ring.
- The focusing frame gives an indication of the focusing point. Depending on the size of the subject or the distance, the camcorder may focus outside the frame.
- When the subject is too bright (overexposed), "OVEREXP" starts flashing. If you have turned off the built-in ND filter, we recommend changing the setting back to AUTO. Open the menu and select [CAMERA SET UP]. Select [ND FILTER], set it to [AUTO] and close the menu.
- "OVEREXP" does not appear when you press the EXP button.

Selecting the Focusing Point

CAMERA

PLAY (VCR)

CARD CAMERA

CARD PLAY (VCR)

1. Set the camcorder to CARD CAMERA mode.

A white focusing frame appears in the center of the screen.

2. Set the program selector to [P].

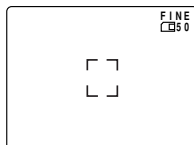

3. Turn the selector dial to display all focusing frames.

Three focusing frames appear on the screen, one of it in green.

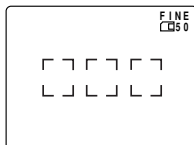

4. Turn the selector dial to select the focusing point.

Turn the selector dial up to select the frame to the right, down to select the frame to the left.

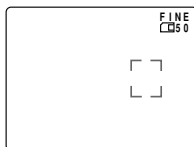

5. Record the still image.



- If you operate the zoom lever, press the EXP button or do not press the PHOTO button within 4 seconds, the frames other than the selected one disappear.

- The focusing point can be selected only when Focus-Priority is set to [ON] in CARD CAMERA mode. The focusing point returns to the center if you turn off the camcorder, change from CARD CAMERA mode or move the program selector to □.
- The focusing point cannot be selected in Stitch Assist mode.
- The focusing point cannot be selected when using the digital zoom. When you zoom into the digital zoom range, the focusing frame flashes for 4 seconds and disappears. When you return to the optical zoom range, the focusing frame reappears.
- The focusing point cannot be selected when focusing manually.
- The focusing point cannot be selected when recording movies on a memory card.

Turning Off the Focus-Priority Mode



Open the menu and select [CAMERA SET UP]. Select [FOCUS PRI.], set it to [OFF] and close the menu.

Continuous Shooting

You can capture a quick series of still images with the continuous shooting function.



1. Set the camcorder to CARD CAMERA mode.
2. Open the menu and select [CAMERA SET UP]. Select [DRIVE MODE], set it to [CONT. - 3. Press and hold the PHOTO button to record the still images.
A series of still images will be recorded.
- 4. Release the PHOTO button to end recording.



- The setting resets to [SINGLE] when you turn the camcorder off.
- Maximum number of continuous shots at one time (at 16 MB or more available capacity):

Still Image Size	Optional VFL-1 Attached	Frames per Second	Maximum Number of Continuous Shots
1280 × 960	Flash ON/OFF	2 frames	10 images
640 × 480	Flash OFF	3 frames	30 images
	Flash ON	2 frames	10 images

*These figures are approximate and vary with the recording conditions and subjects.

- If you attach the optional VFL-1 Video Flash Light, the practical range of the flash in the Continuous Shooting mode is approx. 3.3 ft. (1 m) to 6.6 ft. (2 m).

Auto Exposure Bracketing

With Auto Exposure Bracketing (AEB), the camcorder records a still image in three different exposures (dark, normal, light), allowing you to choose the perfect exposed shot.

CAMERA

PLAY (VCR)

CARD CAMERA

CARD PLAY (VCR)

MENU

(43)

CAMERA SET UP

▶ DRIVE MODE... SINGLE

1. Set the camcorder to **CARD CAMERA** mode.
2. Open the menu and select [CAMERA SET UP]. Select [DRIVE MODE], set it to [AEB] and close the menu.
3. Press the **PHOTO** button.

Three still images in different exposures are recorded to the memory card.



The setting resets to [SINGLE] when you turn the camcorder off.

Recording from a Tape in the Camcorder

You can record images from a tape in the camcorder as still images on a memory card.

CAMERA

PLAY (VCR)

CARD CAMERA

CARD PLAY (VCR)

1. Set the camcorder to **PLAY (VCR)** mode.
2. Play back the tape.
3. Press the **PHOTO** button halfway when the scene you wish to record appears.

- The camcorder pauses playback. The remaining image capacity and other information appear.
- When you press the PHOTO button on the wireless controller, recording starts immediately.

4. Press the PHOTO button fully.

- The card access indicator flashes.
- The still image shown on the screen will be recorded on the memory card.
- You can also record a still image by pressing the PHOTO button fully when the tape is in playback pause mode.



- A still image recorded from an image in 16:9 format will be vertically compressed.
- The data code of the still image will reflect the date and time it has been recorded on the memory card.
- There will be no shutter sound in PLAY (VCR) mode.
- The size of the still image will be 640 × 480.

Recording from Other Video Devices

You can record images from devices connected via the S-video terminal or AV terminal (analog line-in function), or via the DV terminal as still images on a memory card.



When recording via the AV terminal, make sure that "AV→DV" is displayed on the screen. When recording via the DV terminal, make sure that "AV→DV" is not displayed. Change the setting as necessary (📖 94).

CAMERA

PLAY (VCR)

CARD CAMERA

CARD PLAY (VCR)

1. Connect the camcorder to the video device.

- S-video/AV terminal: See *Playing Back on a TV Screen* (📖 40).
- DV terminal: See *Connecting a Digital Video Device* (📖 89).

2. Set the camcorder to PLAY (VCR) mode.

If a cassette is loaded, make sure the tape is stopped.

3. Connected device: Load a recorded cassette and play back the tape.

4. Press the PHOTO button halfway when the scene you wish to record appears.

- The still image, remaining image capacity and other information appear.
- When you press the PHOTO button on the wireless controller, recording starts immediately.

5. Press the PHOTO button fully.

- The card access indicator flashes.
- The still image shown on the screen will be recorded on the memory card.



- A still image recorded from an image in 16:9 format will be vertically compressed.
- The data code of the still image will reflect the date and time it has been recorded on the memory card.
- There will be no shutter sound in PLAY (VCR) mode.
- The size of the still image will be 640 × 480.

Download from Www.Somanuals.com. All Manuals Search And Download.

Recording Still Images on a Memory Card While Recording Movies on a Tape

E

You can record still images on a memory card by pressing the PHOTO button while you are recording a movie on the tape.



- The size of the still image will be 640 × 480.
- You can use the full zoom range (16× optical zoom and 64×/320× digital zoom).
- The quality of the still image is slightly lower than a still image recorded in CARD CAMERA mode.
- Card mix cannot be used when [PHOTO REC] is set to [CARD □].
- The still image cannot be recorded on a memory card when a fader, effect or the multi-image screen is activated.
- The beep does not sound when you press the PHOTO button while recording a movie on the tape.

CAMERA

PLAY (VCR)

CARD CAMERA

CARD PLAY (VCR)

MENU

(□ 43)

CAMERA SET UP

▶ PHOTO REC...TAPES

1. Set the camcorder to **CAMERA** mode.
2. Open the menu and select [CAMERA SET UP]. Select [PHOTO REC], set it to [CARD □] and close the menu.
3. While you are recording a movie, press the PHOTO button.

The image shown on the screen will be recorded on the memory card.

Recording Panoramic Images (Stitch Assist Mode)

You can shoot a series of overlapping images and merge them into one large panoramic scene using the supplied software (PhotoStitch) on a computer.

When Recording in Stitch Assist Mode:

PhotoStitch detects the overlapping portion of adjoining images and merges them. Try to include a distinctive item (landmark, etc.) in the overlapping portion.

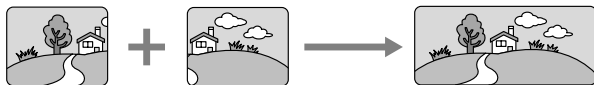

1. Set the camcorder to **CARD CAMERA** mode.

2. Press the  button.

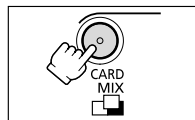

3. Select the direction with the **CARD +/-** button.

CARD + button: clockwise. CARD - button: counterclockwise.



4. Select the program **AE** mode and zoom on the subject.

Adjust focus and exposure manually as necessary. Once the sequence has started, you cannot change the program AE mode, exposure, zoom or focus.

5. Press the **PHOTO** button to record the first image.

Direction and number of recorded images appear.

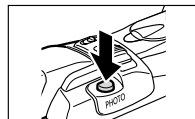

6. Record the second image so that it overlaps a portion of the first image.

- Minor discrepancies in the overlapped area can be corrected with the software.
- You can retake an image by pressing the CARD +/- button to return to the previous image.
- A maximum of 26 images can be recorded.

7. Press the  button after the last image.

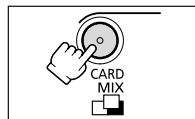

For details on how to merge these images, refer to the DIGITAL VIDEO SOLUTION DISK Software Instruction Manual.



**E**

- Compose each image so that it overlaps 30 to 50% of the adjoining image. Try to keep the vertical misalignment within 10%.
- Do not include moving subject in the overlapping portion.
- Do not try to stitch images that include both distant and close subjects. They may appear warped or doubled up.
- The continuous shooting mode cannot be used in Stitch Assist mode.

Recording Motion JPEG Movies on a Memory Card

You can record Motion JPEG movies with the camcorder, from a tape in the camcorder ( 114), or from devices connected via the AV terminal (analog line-in) or the DV terminal ( 114).

E



- Do not turn off the camcorder, disconnect the power source or remove the memory card while the card access display (<<< or >>>) in the upper right corner of the screen or the card access indicator is flashing. Doing so could result in data damage.
- When you are using a SD Memory Card, make sure that the protect switch is set to allow recording.
- Do not load/unload a cassette during recording.



- Make sure to insert a memory card with enough remaining capacity.
- The sound of a movie recorded on a memory card will be monaural.

Recording with the Camcorder

CAMERA

PLAY (VCR)

CARD CAMERA

CARD PLAY (VCR)

1. Set the camcorder to **CARD CAMERA** mode.
2. Press the **start/stop button** to begin recording.

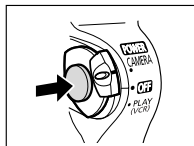

You can record up to 10 seconds in 320 × 240 and up to 30 seconds in 160 × 120.



3. Press the **start/stop button** to stop recording.

The camcorder starts writing the movie on the memory card.



To use the self-timer ( 68), press the  (self-timer) button before step 2 and press the start/stop button.

Recording from a Tape in the Camcorder

You can record movies from a tape in the camcorder on a memory card.

E

CAMERA

PLAY (VCR)

CARD CAMERA

CARD PLAY (VCR)

1. Set the camcorder to **PLAY (VCR)** mode.
2. Play back the tape.
3. Press the start/stop button when the scene you wish to record appears.
You can record up to 10 seconds in 320 × 240 and up to 30 seconds in 160 × 120.
4. Press the start/stop to stop recording.



- A movie recorded from an image in 16:9 format will be vertically compressed.
- The data code of the movie will reflect the date and time it has been recorded on the memory card.

Recording from Other Video Devices

You can record movies from devices connected via the S-video terminal or AV terminal (analog line-in function), or via the DV terminal on a memory card.

CAMERA

PLAY (VCR)

CARD CAMERA

CARD PLAY (VCR)

1. Connect the camcorder to the video device.
 - S-video/AV terminal: See *Playing Back on a TV Screen* (□□ 40).
 - DV terminal: See *Connecting a Digital Video Device* (□□ 89).
2. Set the camcorder to **PLAY (VCR)** mode.
If a cassette is loaded, make sure the tape is stopped.
3. Connected device: Load a recorded cassette and play back the tape.
4. Press the start/stop button when the scene you wish to record appears.
You can record up to 10 seconds in 320 × 240 and up to 30 seconds in 160 × 120.
5. Press the start/stop button to stop recording.



- A movie recorded from an image in 16:9 format will be vertically compressed.
- The data code of the movie will reflect the date and time it has been recorded on the memory card.

Playing Back a Memory Card



You can play back memory card images on the LCD screen, viewfinder screen, or on a connected TV screen (see *Playing Back on a TV Screen* 40).

E

You can display a single image (single image display), 6 at one time (index screen 116), or one after another (slide show 116). Use the Card Jump function to quickly locate an image without displaying them one by one (117).



- Images not recorded with this camcorder, uploaded from a computer (except the sample images 138), edited on a computer and images whose file names have been changed may not be played back correctly.
- Do not turn off the camcorder, disconnect the power source or remove the memory card while the card access display (<<<) in the upper right of corner of the screen or the card access indicator is flashing. Doing so could result in data damage.



- Make sure to insert a memory card that contains images.
- Only date and time will be displayed when pressing the DATA CODE button.
- You can enlarge still images up to 5 times during playback (83).

Single Image Display

CAMERA

PLAY (VCR)

CARD CAMERA

CARD PLAY (VCR)

1. Set the camcorder to CARD PLAY (VCR) mode.

- The last recorded image appears.
- Movies are displayed with the first scene as a still image indicated by “▶/||”.

2. Press the CARD +/- button to move between images.

Press the CARD + button to display the next image and the CARD – button to display the previous image.

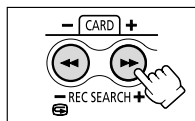

3. To play back a movie, press the ▶/|| button.

The last scene appears as a still image when playback is complete.

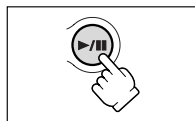

Index Screen

CAMERA

PLAY (VCR)

CARD CAMERA

CARD PLAY (VCR)

E

1. In single image display, press the INDEX SCREEN button.

- Up to 6 images appear.
- Movies are displayed with the first scene as a still image indicated by "▶▶".

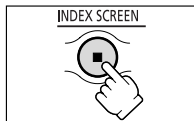

2. Press the CARD +/- button to change the image selection.

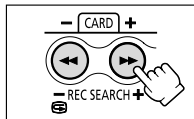

3. Move the mark to the image you wish to view.

- Turn the selector dial up to move to the next image and down to move to the previous image.
- Turning the selector dial up on the last image displays the next index screen. Turning the selector dial down on the first image displays the previous index screen.

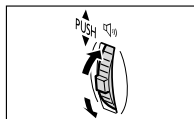

4. Press the INDEX SCREEN button.

The index screen is canceled and the selected image appears in single image display.

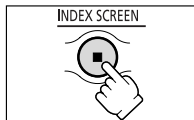

Slide Show

CAMERA

PLAY (VCR)

CARD CAMERA

CARD PLAY (VCR)

1. In single image display, press the SLIDE SHOW button.

Images are played back one after another.

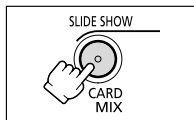

2. Press the SLIDE SHOW button to stop the slide show.

Card Jump Function

You can locate still images/movies without displaying them one by one. The number in the upper right of the screen indicates the image number of the current image by the total number of images.

CAMERA

PLAY (VCR)

CARD CAMERA

CARD PLAY (VCR)

In single image display, press and hold the CARD + or CARD – button.

- Press the CARD + button to jump forward and the CARD – button to jump backward.
- When you release the button, the still image/movie of the displayed image number appears.

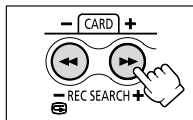

Protecting Images



E

You can protect important images from accidental erasure during single image display or index screen display.



If a memory card is formatted, all images, even protected ones, will be erased permanently.



- The sample images recorded on the supplied SD Memory Card are already protected.
- Movies can only be protected when the first or last scene is displayed as a still image. They cannot be protected during playback pause.
- Make sure to insert a memory card that contains images.

Protecting during Single Image Display

CAMERA

PLAY (VCR)

CARD CAMERA

CARD PLAY (VCR)

1. Select the image you wish to protect.
2. Press the selector dial to open the FILE OPERATION menu.
3. Select [PROTECT \odot].
 - “ \odot ” appears and now the image cannot be erased.
 - To cancel the protection, press the selector dial.
4. Select [\leftarrow RETURN] to close the menu.

Protecting during Index Screen Display

CAMERA

PLAY (VCR)

CARD CAMERA

CARD PLAY (VCR)

MENU

(\square 43)

CARD OPERATIONS

\rightarrow PROTECT \odot

1. In single image display, press the INDEX SCREEN button.
Up to 6 images appear.
2. Open the menu and select [CARD OPERATIONS].
3. Select [\rightarrow PROTECT \odot].
4. Select the image you wish to protect and press the selector dial.
 - “ \odot ” appears on the image.
 - Repeat this step to protect more images.
 - To cancel the protection, press the selector dial.
5. Press the MENU button.



To cancel the protection, press the selector dial in step 4. “ \odot ” disappears and the image can now be erased.

Erasing Images



You can erase images singly or all at once.



Be careful when erasing images. Erased images cannot be recovered.



- Protected images cannot be erased.
- Movies can only be erased when the first or last scene is displayed as a still image. They cannot be erased in playback pause mode.
- Make sure to insert a memory card that contains images.

Erasing a Single Image

CAMERA

PLAY (VCR)

CARD CAMERA

CARD PLAY (VCR)

1. Select the image you wish to erase.
2. Press the selector dial to open the **FILE OPERATION** menu.
3. Select **[IMAGE ERASE]**.
 - “ERASE THIS IMAGE?”, [NO] and [YES] appears.
 - If an image is protected, [YES] appears in purple.
4. Select **[YES]**.

The image is erased and the previous image appears.

5. Select **[← RETURN]** to close the menu.

Erasing a Single Image/All Images

CAMERA

PLAY (VCR)

CARD CAMERA

CARD PLAY (VCR)

MENU
(43)

CARD OPERATIONS

▶ **IMAGE ERASE**

1. Open the menu and select **[CARD OPERATIONS]**.
2. Select **[IMAGE ERASE]**.
3. Select **[SINGLE]** or **[ALL]**.
 - When erasing a single image: “ERASE THIS IMAGE?” [NO] and [YES] appears. If an image is protected, [YES] appears in purple.
 - When erasing all images: “ERASE ALL IMAGES? [EXCEPT FOR IMAGES]”, [NO] and [YES] appears.
4. Select **[YES]** and close the menu.
 - When erasing a single image: The image is erased and the previous image appears. To erase another image, select the image with the **CARD +/-** button and select [YES].
 - When erasing all images: All images with exception of the protected images are erased.

Selecting Still Images for Printing (Print Order)



E

You can select still images for printing and set the number of copies. These print order settings are compatible with the Digital Print Order Format (DPOF) standards.



- Make sure to insert a memory card that contains images.
- A maximum of 200 still images can be selected.
- Movies cannot be printed.

Selecting in Single Image Display



1. Select the still image you wish to print.
2. Press the selector dial to open the FILE OPERATION menu.
3. Select [**▶** PRINT ORDER].
4. Select the number of copies.
 - “▶” appears on the image.
 - To cancel the print order, set the number of copies to 0.
5. Select [**◀** RETURN] to close the menu.

Selecting in Index Screen Display



MENU

(43)

CARD OPERATIONS

▶▶ PRINT ORDER

1. In single image display, press the INDEX SCREEN button.
Up to 6 images appear.
2. Open the menu and select [CARD OPERATIONS].
3. Select [▶▶ PRINT ORDER].
4. Select the still image you wish to print and press the selector dial.
5. Set the number of copies with the selector dial and close the menu.
 - “▶▶” appears on the image.
 - To cancel the print order, set the number of copies to 0.
 - Repeat steps 4 and 5 to continue the print order setting.

Erasing All Print Orders



E

1. In single image display, open the menu and select [CARD OPERATIONS].
2. Select [PRINT ORDERS ALL ERASE].
"ERASE ALL PRINT ORDERS?", [NO] and [YES] appears.
3. Select [YES].
All "" disappear.
4. Select [RETURN] to close the menu.

Printing with the Direct Print Function



E

You can print still images by connecting the camcorder to a printer with Direct Print function. The Direct Print function can also be used with the print order settings ( 120).



- Observe the following precautions during printing, otherwise printing may not be performed correctly.
 - Do not turn off the camcorder or the printer.
 - Do not change the position of the TAPE/CARD switch.
 - Do not detach the cable.
 - Do not remove the memory card.
- Still images not recorded with this camcorder may not be printed correctly on a printer with direct print function.



- The direct print function is supported by Canon Card Photo Printers with the  logo and Canon Bubble Jet Printers with the  logo.
- Refer to the instruction manual of each printer for information on which interface cable to use with the camcorder.
The Card Photo Printers CP-10 and CP-100 are supplied with two direct interface cables. Use the cable with the USB logo on the connector (DIF-100).
- We recommend powering the camcorder from a household power source.
- Refer also to the instruction manual of the respective printer.
- The screenshots in this section are examples taken from a printer with direct print function. Options for the [Style] category will differ slightly depending on the printer.

Connecting the Printer to the Camcorder

Using a Memory Card

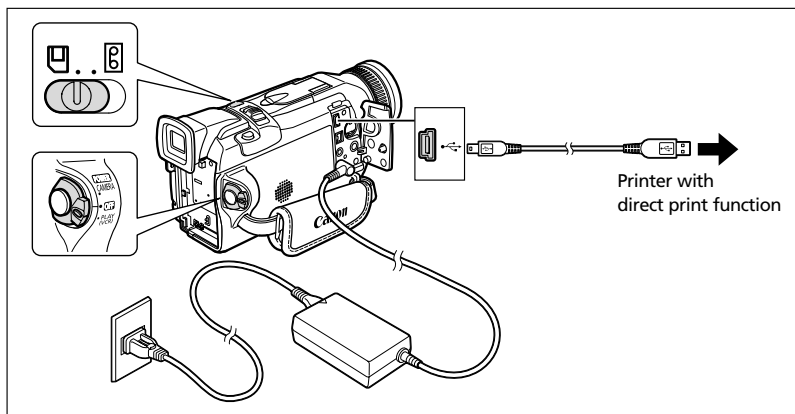

1. Turn off the camcorder and insert a memory card that contains still images.
2. Connect a power source to the printer and turn on the printer.

3. Set the camcorder to CARD PLAY (VCR) mode.

Wait until the card access indicator stops flashing.

4. Connect the camcorder to the printer using the cable.

"Print»SET" appears when the printer is properly connected to the camcorder. (Does not appear with movies, or still images that cannot be played back with the camcorder.)

Printing

CAMERA

PLAY (VCR)

CARD CAMERA

CARD PLAY (VCR)

1. In single image display, select the still image you wish to print and press the selector dial.

The print setting menu appears.

2. Set the number of copies, the print style and the trimming settings.

- *Selecting the Number of Copies.*
- *Setting the Print Style* (📖 124).
- *Trimming Settings* (📖 126).

3. Select [Print] and press the selector dial.

Printing starts. The print setting menu disappears when printing is complete.



If an error message appears, see *Printing Errors* (📖 127) and *Direct Print Related Messages* (📖 146).

Selecting the Number of Copies

A maximum of 9 copies can be selected for one still image.

1. In the print setting menu, turn the selector dial so that SET appears next to [Copies] and press the selector dial.



2. Turn the selector dial to select the number of copies and press the selector dial.

Setting the Print Style

Card Photo Printer:

Image	Standard	Prints 1 still image per page.
	Multiple	Prints 8 copies of the same still image on one page.
Borders	Borderless	Prints right to the edges of the page.
	Bordered	Prints with a border.

- [Multiple] can only be selected when printing on card size paper.
- [Borders] can only be selected when [Image] is set to [Standard].

Bubble Jet Printer:

Paper Size	Card #1*, Card #2*, Card #3*, LTR, A4	
	For details on paper type, refer to the Bubble Jet Printer User Guide.	
Borders	Borderless	Prints right to the edges of the page.
	Bordered	Prints with a border.

* Recommended paper size

Card Photo Printer: Selecting the Image Style

1. In the print setting menu, turn the selector dial to select [Style] and press the selector dial.



2. Make sure that  is selected and press the selector dial.



3. Turn the selector dial to select the image style and press the selector dial.

4. Press the MENU button.

You return to the print setting menu.

Bubble Jet Printer: Selecting the Paper Size

1. In the print setting menu, turn the selector dial to select [Style] and press the selector dial.



2. Make sure that  is selected and press the selector dial.



3. Turn the selector dial to select the paper size and press the selector dial.

4. Press the MENU button.

You return to the print setting menu.

Selecting the Borders

1. In the print setting menu, turn the selector dial to select [Style] and press the selector dial.



2. Turn the selector dial to select  and press the selector dial.



3. Turn the selector dial to select a borders option and press the selector dial.

4. Press the MENU button.

You return to the print setting menu.



- Bordered: The image area remains relatively unchanged from the recorded image when it is printed.
- Borderless/Multiple: The center portion of the recorded image is printed at an enlarged size. The image's top, bottom and sides may be cropped slightly.
- Card Photo Printer: A still image set to [Multiple] will be printed without borders.

Trimming Settings

Set the print style before you start with the trimming settings.

E

1. In the print setting menu, select [Trimming] and press the selector dial.

The trimming frame appears.



2. Change the size of the trimming frame.

- Move the zoom lever toward **T** to shrink the frame, and toward **W** to enlarge the frame.
- To cancel the trimming settings, move the zoom lever toward **W** until the trimming frame disappears.

3. Move the trimming frame.

- Turn the selector dial to move the image to the right and left, or up and down. Pressing the selector dial switches between the directions.

4. Press the MENU button.

You return to the print setting menu.



- About the color of the trimming frame:
 - White: No trimming settings.
 - Green: Recommended trimming size.
 - Red: The image is magnified beyond recommended size. The image may print out coarsely.
- The trimming frame may not appear depending on the image size, paper size or borders settings.
- The trimming setting applies only to one image.
- The trimming setting is canceled with the following operations:
 - When you turn off the camcorder.
 - When you disconnect the interface cable.
 - When you expand the trimming frame beyond its maximum size.

Printing with Print Order Settings

You can print still images you have selected with the Print Order function. If you wish to print more than 1 copy, set the number of copies in the print order (📖 120). When printing with print order settings, you can select the print style such as bordered or borderless, but not the trimming settings.

CAMERA

PLAY (VCR)

CARD CAMERA

CARD PLAY (VCR)

MENU

(📖 43)

➡️ PRINT

1. Connect the printer to the camcorder (📖 122).

2. Press the MENU button.

3. Select [➡️ PRINT].

- The print setting menu appears.
- “Set print order” appears, when you connect a printer with direct print function and select [➡️ PRINT] without having set the print order.
- The total number of prints set in the print order is displayed on the upper left of the screen.

4. Set the print style.

Setting the Print Style (📖 124).

5. In the print setting menu, select [OK] and press the selector dial.

Printing starts. The print setting menu disappears when printing is complete.



- Cancel Printing
Press the selector dial while “Now Printing” is displayed. A confirmation dialog appears. Select [OK] and press the selector dial. Printing stops even if it is incomplete and the paper is fed through.
- Restarting Printing (with ➡️ print order only)
Open the CARD PLAY (VCR) menu and select [➡️ PRINT]. Select [Restart] in the print setting menu and press the selector dial. The remaining images will be printed.
Printing cannot be restarted in the following cases:
 - When you change the print order settings.
 - When you delete a still image with print order settings.
- Printing Errors
 - If an error occurs during the printing process, an error message appears (📖 146).
 - Bubble Jet Printer: With most errors, printing resumes automatically after you correct the error. If the error persists, press the selector dial to cancel printing. Refer also to the Bubble Jet Printer Quick Start Guide for details.
 - Card Photo Printer: Turn the selector dial to select [Stop] or [Restart] and press the selector dial. (The [Restart] setting may not appear with some error messages. In that case, select [Stop].)
- Follow below procedure when disconnecting the interface cable:
 1. Disconnect the cable from the camcorder and printer.
 2. Turn off the camcorder.

Combining Images (Card Mix)



E

You can produce effects not possible with just a tape with the Card Mix function. Choose one of the sample images provided on the supplied SD Memory Card (such as picture frames, backgrounds and animations) and combine it with the live video recording.



- Card mix cannot be used when [PHOTO REC] is set to [CARD].
- Movies recorded on a memory card cannot be combined with camcorder recordings.



- Make sure to load a cassette and to insert a memory card that contains card mix images.
- Additional sample images are provided on the supplied DIGITAL VIDEO SOLUTION DISK. For instructions on how to upload them to the memory card, refer to *Adding Still Images from Your Computer to the Memory Card* in the DIGITAL VIDEO SOLUTION DISK Software Instruction Manual.
- Reselect the card mix image when you have turned off the camcorder, changed the position of the program selector or removed the memory card.

Card Mix Effects

You can select from the following 4 types of Card Mix effects:

Card Chroma Key (CARD CHROMA)

Combines frames with your recordings. The live video recording will appear in place of the blue area of the card mix image. If you create your own frame, make sure that the area the live recording should appear is blue.

Mix level adjustment: blue area of the still image.



Card Luminance Key (CARD LUMI.)

Combines illustrations or title with your recordings. The live video recording will appear in place of the light area of the card mix image. You can create your own title or illustration by drawing on a white paper and recording it to the memory card.

Mix level adjustment: light area of the still image.



Camera Chroma Key (CAM. CHROMA)

Combines backgrounds with your recordings. Record your subject in front of a blue curtain, and the subject not blue will be superimposed on the card mix image.

Mix level adjustment: blue area of the live video recording.

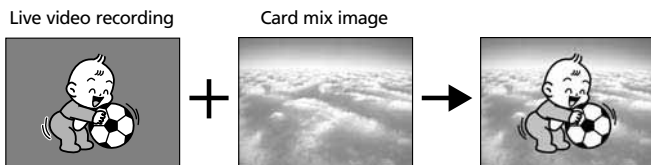

Card Animation (C. ANIMATION)

Combines animations with your recordings. You can choose from 3 types of card animation effects.

Corner: Animation appears on the upper left and the lower right corner of the screen.

Straight: Animation appears on the top and bottom of the screen and moves to the right and left.

Random: Animation moves randomly in the display.

Mix level adjustment: blue area of the card animation image.

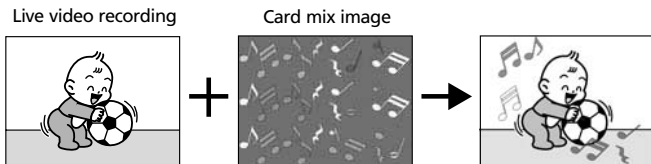

Selecting the Card Mix Effect

E

CAMERA

PLAY (VCR)

CARD CAMERA

CARD PLAY (VCR)

MENU

(43)

→ **CARD MIX** ▶

MIX TYPE.....**CARD CHROMA**▶▶

MIX LEVEL.....

1. Set the program selector to **P**.

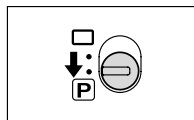

2. Open the menu and select **[→CARD MIX]**.

The card mix menu appears.

3. Select the image you wish to combine with the **CARD +/-** button.

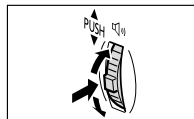

4. Select **[MIX TYPE]**.

[CARD CHROMA], [CARD LUMI.], [CAM. CHROMA] and [C. ANIMATION] appears.

5. Select the mix type matching the image you have selected (138).

- The screen shows the combined image.
- When you have selected [C. ANIMATION], select [ANIMAT. TYPE] and select between [CORNER], [STRAIGHT] and [RANDOM].

6. To adjust the mix level, select **[MIX LEVEL]** and adjust it with the selector dial.

7. Close the menu.

"CARD MIX" flashes.

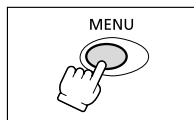

Activating the Card Mix Effect

1. Press the **CARD MIX** button.

- "CARD MIX" stops flashing.
- The combined image appears.
- You can activate and deactivate the card mix effect by pressing the **CARD MIX** button.

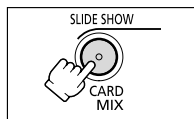

Recording with the Card Mix Effect

Movie:

1. Press the start/stop button to begin recording.

The combined image is recorded on the tape.

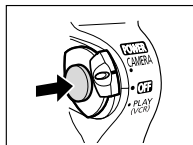

E

2. Press the start/stop button to end recording.

Still Image:

1. Press the PHOTO button halfway.

- flashes in white and turns green when focus is adjusted.



2. Press the PHOTO button fully.

- The camcorder records the still image on the tape for approx. 6 seconds. During this time, the camcorder displays the still image and keeps recording the sound.
- The camcorder returns to record pause mode.

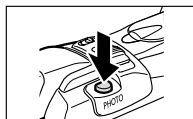

Copying Still Images



E

You can copy still images from tape to memory card, or from memory card to tape.



- All still images from the selected still image onward will be copied.
- The size of a still image copied from tape to memory card will be 640 × 480.
- The data code of the still image reflects the date and time it has been copied.

Copying Still Images from Tape to Memory Card

Insert a memory card with enough remaining capacity, and load a recorded cassette.

CAMERA

PLAY (VCR)

CARD CAMERA

CARD PLAY (VCR)

MENU

(43)

CARD OPERATIONS

▶ COPY [→]

1. Locate the still image you wish to copy on the tape and stop the tape shortly before the still image.

- You can also use the photo search function to easily locate the still image.
- To copy all still images from the tape, rewind the tape to the beginning.

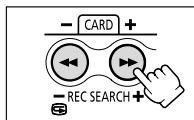

2. Open the menu and select [CARD OPERATIONS].

3. Select [COPY [→]].

[CANCEL] and [EXECUTE] appears.

4. Select [EXECUTE].

- "NOW COPYING" appears.
- The still image being copied is shown on the screen.
- Copying stops when the tape reaches the end or the memory card is full ("CARD FULL" appears).

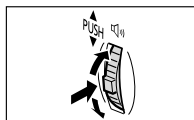

5. Press the (stop) button to end copying.

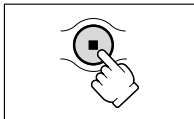

Copying Still Images from Memory Card to Tape

Load a cassette with enough free space, and insert a recorded memory card. Make sure that the protect tab on the cassette is set to allow recording.

CAMERA

PLAY (VCR)

CARD CAMERA

CARD PLAY (VCR)

MENU

(43)

CARD OPERATIONS

COPY [ → ]

1. Select the first still image you wish to copy with the **CARD +/-** buttons.

To copy all still images from the memory card, select the first still image.

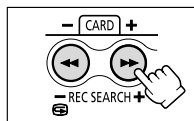

2. Open the menu and select [CARD OPERATIONS].

3. Select [COPY [→]].

[CANCEL] and [EXECUTE] appears.

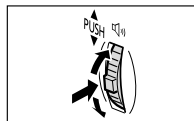

4. Select [EXECUTE].

- "NOW COPYING" appears.
- It takes about 6 seconds per still image to be copied to the tape.
- Copying stops when all still images are copied or the tape is full.

5. Press the **■** (stop) button to end copying.

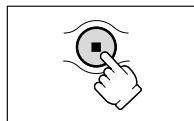

Formatting a Memory Card



E

Format new memory cards, or when you get the message "CARD ERROR". You can also format a memory card to erase all images recorded on it.

The camcorder formats memory cards in the Design rule for Camera File system (DCF) standard.



- Formatting a memory card erases all data, including protected images.
- Images erased by formatting cannot be recovered.
- If you use a memory card other than the supplied one, format it with the camcorder.
- Makes sure to insert the memory card you wish to format into the camcorder.

CAMERA

PLAY (VCR)

CARD CAMERA

CARD PLAY (VCR)

MENU

(43)

CARD OPERATIONS

▶ **FORMAT**

1. Open the menu and select [CARD OPERATIONS].

2. Select [FORMAT].

[CANCEL] and [EXECUTE] appears.

3. Select [EXECUTE].

[FORMAT THIS CARD?], [NO] and [YES] appears.

4. Select [YES] and close the menu.

- Formatting starts.
- Selecting [NO] brings you back to step 3.

Connecting to a Computer Using a USB Cable

E

You can download images from the memory card to a computer using the supplied USB cable. With the supplied software, you can easily download, browse and archive images, and arrange still images for printout.

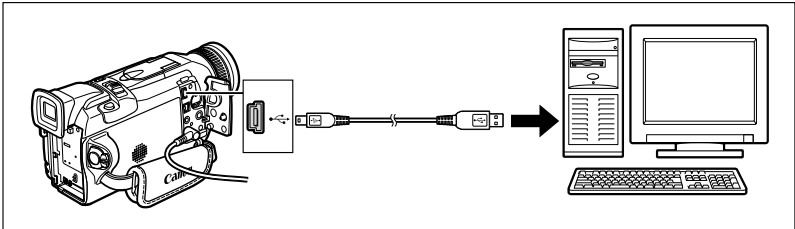

For instructions on how to connect the camcorder to the computer, and install and operate the software, refer to the DIGITAL VIDEO SOLUTION DISK Software Instruction Manual.

- Refer also to the computer instruction manual.
- “PC CONNECT  ” appears to indicate that the camcorder is connected to the computer via USB cable.

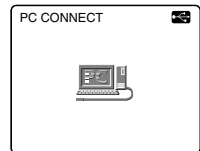

- Do not disconnect the USB cable, remove the memory card, change the position of the POWER switch or turn off the camcorder and computer while data is being transferred to the computer (while the camcorder's card access indicator is flashing). Doing so may damage the memory card's data.
- Operation may not work correctly depending on the software and the specifications/settings of your computer.
- The image file on your memory card and the image files saved on the hard disk drive of your computer are valuable, original data files. If you wish to use image files on your computer, make copies of them first, and use the copied file, retaining the original.



- We recommend powering the camcorder from a household power source while it is connected to the computer.
- For transferring recordings from to a computer using a DV cable, see p. 100.
- Still images/movies recorded on a tape cannot be transferred to a computer via USB interface.

Creating a Start-up Image

E

You can create a start-up image using a still image on the memory card or a sample start-up image provided on the DIGITAL VIDEO SOLUTION DISK and save it as [MY IMAGE1] or [MY IMAGE2].



- Make sure to insert a memory card with enough remaining capacity.
- Before you create a start-up image, you need to record a still image on the memory card.
- Retain the original data of the still image you have set as the start-up image on your computer or removable disk.

Preparations

Record a still image on the memory card.

OR

Upload a still image from your computer to the memory card using the software in the DIGITAL VIDEO SOLUTION DISK.

For instruction on how to upload a still image to the memory card, refer to *Adding Still Images from Your Computer to the Memory Card* in the DIGITAL VIDEO SOLUTION DISK Software Instruction Manual.

Setting the Still Image as Start-up Image

CAMERA

PLAY (VCR)

CARD CAMERA

CARD PLAY (VCR)

MENU

(43)

MY CAMERA

▶ CREATE START-UP IMAGE

1. Open the menu.

2. Select [MY CAMERA].

3. Select [CREATE START-UP IMAGE].

[SET THIS AS START-UP IMAGE1?], [YES] and [NO] appears.

4. Select a still image with the CARD +/- buttons and select [YES].

[SAVE AS MY IMAGE1], [MY IMAGE2] and [CANCEL] appears.

5. Select [MY IMAGE1].

[OVERWRITE MY IMAGE1?], [YES] and [NO] appears.

6. Select [YES].

- The still image will be saved, and the image that was saved to [MY IMAGE1] is erased.
- Select this image as start-up image following the procedure in *Customizing the Camcorder* (49).

Memory Card Information

Images recorded on a memory card with this camcorder can be transferred to a computer using the following products for SD Memory Cards or MultiMediaCards:

PC Card Adapter: An adapter to insert a memory card into the card slot on the computer.

USB Reader/Writer: Connects to the USB port of a computer for direct access to the memory card.

FD Adapter: An adapter to insert a memory card into the floppy disk drive on the computer.

Memory Cards that are confirmed to operate with this camcorder (as of February 2003):

SD Memory Card: Panasonic: 16 MB, 32 MB, 64 MB, 128 MB, 256 MB, 512 MB

SanDisk: 16 MB, 32 MB, 64 MB

MultiMediaCard: SanDisk: 16 MB, 32 MB, 64 MB

However, we cannot guarantee that all of these memory cards work properly.

Memory Card Handling Precautions

- Format new memory cards with the camcorder. Memory cards formatted with other devices such as a computer may not operate correctly.
- We recommend saving backups of memory card images on your computer's hard drive or other external memory device. Image data may be corrupted or lost due to memory card defects or exposure to static electricity. Canon Inc. makes no warranties for corrupted or lost data.
- Do not turn off the camcorder, disconnect the power source or remove the memory card while the card access indicator is flashing.
- Do not use memory cards in places subject to strong magnetic fields.
- Do not leave memory cards in places subject to high humidity and high temperature.
- Do not disassemble memory cards.
- Do not bend, drop, or subject memory cards to shocks and do not expose them to water.
- Moving a memory card rapidly between hot and cold temperatures may cause condensation to form on its external and internal surfaces. If condensation forms on the card, put it aside until the droplets have evaporated completely.
- Do not touch or expose the terminals to dust or dirt.
- Store and carry memory cards in the supplied case to protect the terminals.
- Check the direction before inserting the memory card. Forcing a memory card backwards into the slot may damage the memory card or the camcorder.
- Do not remove the label from the memory card, or affix other labels on the memory card. If you wish to add labels, affix them to the case.

Sample Images

27 sample images are pre-recorded on the supplied SD Memory Card: 8 card chroma key images, 5 card luminance key images, 2 camera chroma key images and 12 card animation images.

E

Card Chroma Key

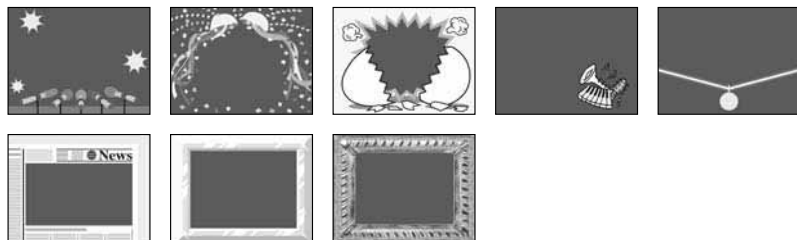

Card Luminance Key



Camera Chroma Key

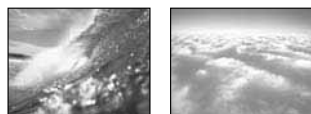

Card Animation

Using a Memory Card

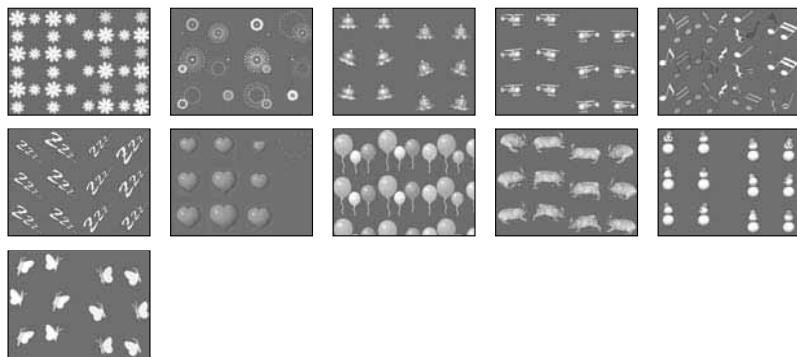



The sample images recorded on the supplied SD Memory Card are intended only for the personal use with this camcorder. Do not use these sample images for other purposes.



If you have mistakenly erased the sample images on the supplied SD Memory Card, they can be downloaded from the homepage <http://www.canondv.com>. For details on how to add the downloaded images to the memory card, refer to Adding Still Images from Your Computer to the Memory Card in the DIGITAL VIDEO SOLUTION DISK Software Instruction Manual.

If you cannot use the USB cable to connect the camcorder to a computer, you will need a PC Card Adapter to upload the images to a memory card.

PhotoEssentials – Royalty Free Stock Photography

The PhotoEssentials suite of royalty-free images on CD-ROM features premium quality assignment photography and is ideally suited for use in advertising, brochures, reports, multimedia, websites, books, packaging and more.

For more information, please visit their website www.photoessentials.com



LCD Screen Displays

You can hide the displays on the LCD screen to have a clear screen for playback.

CAMERA

PLAY (VCR)

CARD CAMERA

CARD PLAY (VCR)

MENU

(43)

DISPLAY SET UP

▶ DISPLAYS.....ON

Open the menu and select [DISPLAY SET UP]. Select [DISPLAYS], set it to [OFF <PLAYBK>] and close the menu.

- The LCD screen will become completely blank (also the TV screen if connected).
- Warning messages still appear, and the data code appears if turned on.
- Tape operation displays appear for 2 seconds.
- Displays cannot be hidden on the index screen.

TV Screen Displays

When you connect a TV for recording/playback, you can hide the displays on the TV screen. For connecting instructions, see *Playing Back on a TV Screen* (40).

CAMERA

PLAY (VCR)

CARD CAMERA

CARD PLAY (VCR)

Press the TV SCREEN button on the wireless controller.

- When the POWER switch is set to CAMERA: The displays disappear from the TV screen and appear when you press the button again.
 - When the POWER switch is set to PLAY (VCR): The displays appear on the connected TV screen and disappear when you press the button again. The setting resets to the OFF setting when you turn the camcorder off.
- When the TV screen displays are hidden, the displays still appear on the LCD screen. If you turn on the data code, displays other than the data code will disappear from the LCD screen.

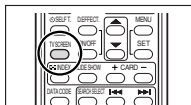

You can also change the setting in the menu during recording:

CAMERA

PLAY (VCR)

CARD CAMERA

CARD PLAY (VCR)

MENU

(43)

DISPLAY SET UP

▶ TV SCREEN.....ON

Open the menu and select [DISPLAY SET UP]. Select [TV SCREEN], set it to [OFF] and close the menu.

Screen Displays during Basic Recording/Playback

 indicates flashing.

CAMERA mode (battery pack attached):

- Remote sensor mode and audio mode disappear after 4 seconds.

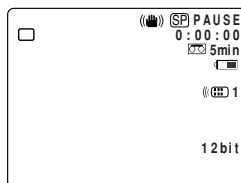

PLAY (VCR) mode:

- Remote sensor mode and volume bar disappear after 4 seconds.

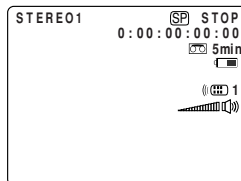

REC
PAUSE
STOP
EJECT
PLAY
FF▶▶
◀◀REW

-  : Fast forward playback/
rewind playback (□38)
 ×2▶/◀×2 : ×2 playback
 (forward and reverse) (□38)
 ×1▶/◀×1 : ×1 playback
 (forward and reverse) (□38)
 ▶/◀ : Slow playback
 (forward and reverse) (□38)
 ||▶/◀|| : Frame advance playback/
 frame reverse playback (□38)
 ▶||/||◀ : Playback pause
 (forward and reverse) (□38)
 ▶▶/◀◀ : Date search/photo search (□86)

- RTN▶▶/◀◀RTN : Zero set memory (forward
 and reverse) (□87)
 ●/●|| : AV insert editing (□95)
 ●/●|| : Audio dubbing (□97)

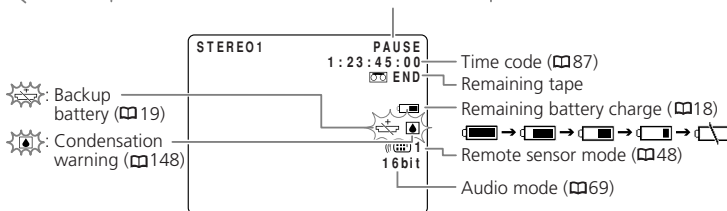

Screen Displays during Advanced Recording/Playback

CAMERA Mode

E

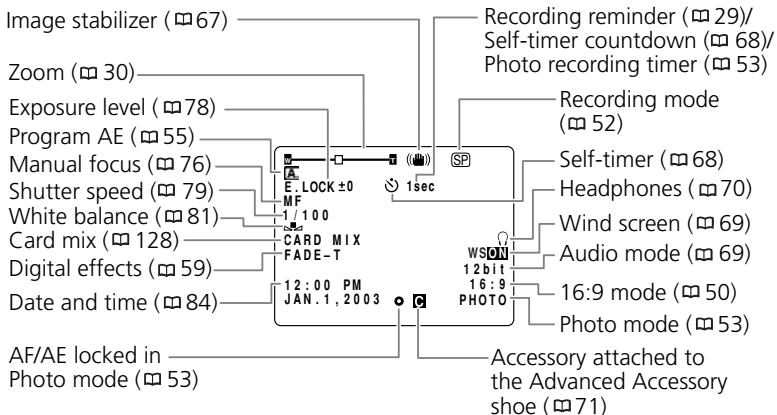

PLAY (VCR) Mode

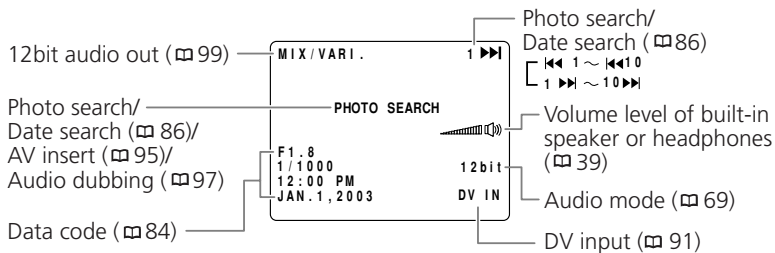

CARD CAMERA Mode

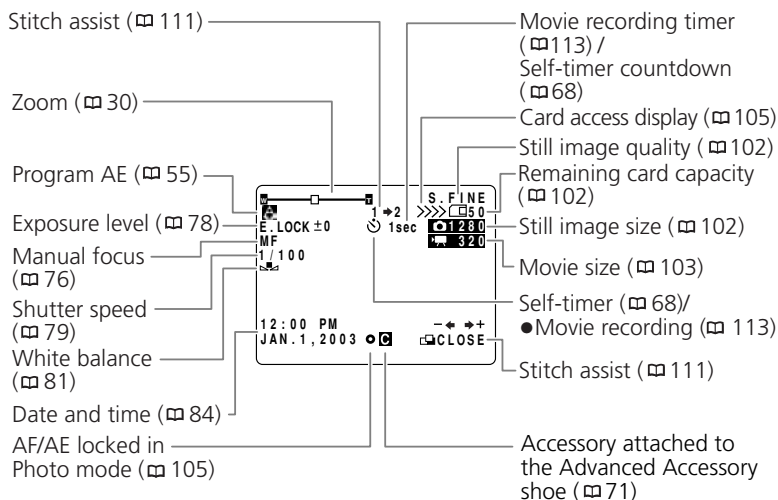

CARD PLAY (VCR) Mode

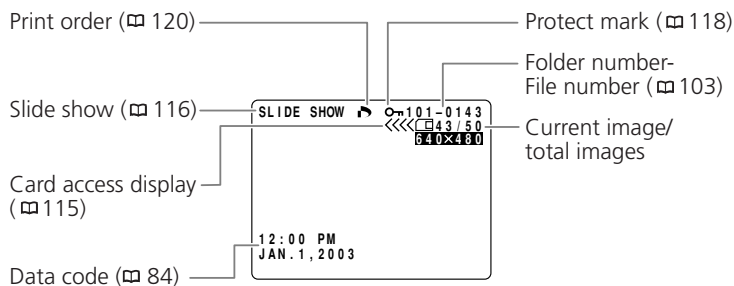

E





Additional
Information

List of Messages

E

Message	Explanation	□
SET THE TIME ZONE, DATE AND TIME	You have not set the time zone, date and time. This message appears each time you turn the power on until you set the time zone, date and time.	25
CHANGE THE BATTERY PACK	Battery pack is exhausted. Replace or charge the battery pack.	16
THE TAPE IS SET FOR ERASURE PREVENTION	Cassette is protected. Replace the cassette or change the position of the protect switch.	23
REMOVE THE CASSETTE	Camcorder stopped operating to protect the tape. Unload and reload the cassette.	22
CHECK THE DV INPUT	DV cable is not connected, or the connected digital device is turned off.	89
CONDENSATION HAS BEEN DETECTED	Condensation has been detected in the camcorder.	148
TAPE END	Tape reached the end. Rewind the tape or replace the cassette.	22
CHECK THE CASSETTE [REC MODE]	You attempted to perform audio dubbing or AV insert on a tape recorded in a mode other than the SP mode.	52
CHECK THE CASSETTE [AUDIO MODE]	You attempted to perform audio dubbing on a tape recorded in 16-bit or 12-bit 4-channel sound.	97
CHECK THE CASSETTE [BLANK]	You attempted to perform audio dubbing or AV insert on a tape with a blank section.	95
HEADS DIRTY, USE CLEANING CASSETTE	Video heads are dirty. Clean the video heads.	148
COPYRIGHT PROTECTED PLAYBACK IS RESTRICTED	You attempted to play back a copyright protected tape.	92
COPYRIGHT PROTECTED DUBBING RESTRICTED	You attempted to dub a copyright protected tape. May also appear when an anomalous signal is received during analog line-in recording, or during analog-digital conversion of a copyright protected tape.	92

Memory Card Related Messages

Message	Explanation	
NO CARD	Memory card not inserted into the camcorder.	101
THE TAPE IS SET FOR ERASURE PREVENTION	SD Memory Card is set for erasure prevention. Replace the card or change the position of the protect switch.	101
NO IMAGES	No images are recorded on the memory card.	115
CARD ERROR	A memory card error occurred. The camcorder cannot record or play back the image. The error may be temporary. If the message disappears after 4 seconds and  flashes red, turn the camcorder off, remove the card and reinsert the card. If  changes to green, you can continue recording/playback.	101
CARD FULL	No remaining capacity on the memory card. Replace with another card or erase images.	119
NAMING ERROR	File or folder number has reached the maximum value.	103
UNIDENTIFIABLE IMAGE	Image is recorded in a not compatible JPEG format or another format not compatible with the camcorder, or the image file is corrupted.	115
 PRINT ORDER ERROR	You attempted to set more than 200 still images in the print order.	120
THIS IMAGE CANNOT BE RECORDED	Some analog images cannot be recorded on the memory card depending on the signal.	109

Direct Print Related Messages

E

Message	Explanation
No Paper	Paper cassette is not correctly inserted or is out of paper.
Paper Jam	The paper jammed during printing.
No Ink	The ink cartridge is not inserted or is out of ink.
Ink Cassette Error	There is a problem with the ink cassette.
Recharge the printer battery	The printer battery is depleted.
Communication Error	The printer is experiencing a data transmission error.
Could not print X images	You attempted to use the print order settings to print X images that were made with another camcorder, have a different format or were edited on a computer.
Cannot Print!	You attempted to print an image that was made with another camcorder, has a different format, or was edited on a computer.
Set print order	You attempted to print an image from the CARD PLAY (VCR) menu [→] [PRINT] without having set the print order.
Cannot trim	You attempted to trim an image with an image size of 160 ×120.
Readjust trimming	You changed the print style after you set the trimming settings.
Paper has been changed	Paper size has been changed between print setting and start of printing.
Incompatible paper size	You attempted to print on paper that cannot be used with the camcorder.
Paper and ink do not match	The ink cannot be used with the selected paper type.
Printer in use	The printer is printing from a computer or a memory card inserted into the printer. It automatically starts printing from the camcorder when current prints are complete.
Printer warming up	Printer is warming up. The printer automatically starts printing when it is ready.
No printhead	No print head is installed in the printer.
Printer cover open	Printer cover is open. Close the printer cover securely.
Media type error	Wrong paper. Cancel printing and set the paper you chose in the print settings menu.
Paper lever error	Paper lever error occurred. Adjust the paper selection lever to the proper position.
Low ink level	The ink tank needs to be replaced soon. Prepare a new ink tank. If you select [Continue] in the error screen, you can restart printing.
Waste tank full	Waste tank is full. You can restart printing by pressing the RESUME/CANCEL button on the Bubble Jet Printer. Request replacement of the waste tank at the shop where you purchased the printer or the nearest Canon customer support center listed in the Bubble Jet Quick Start Guide.
Printer error	Turn off the printer and turn it back on. If the error persists, consult the nearest Canon customer support center listed in the Bubble Jet Quick Start Guide.

Maintenance

Camcorder Handling Precautions

- Do not carry the camcorder by the LCD panel or viewfinder.
- Do not leave the camcorder in places subject to high temperatures, such as a sun-heated car, and high humidity.
- Do not use the camcorder in places subject to magnetic or electric fields such as near the TV transmitters or portable communication devices.
- Do not point the lens or viewfinder at strong light sources. Do not leave the camcorder pointed at a bright subject.
- Do not use the camcorder in dusty or sandy places. Dust or sand getting inside the cassette or camcorder may cause damage. Dust and sand can also damage the lens. Attach the lens cap after use.
- The camcorder is not waterproof. Water, mud or salt getting inside the cassette or camcorder may cause damage.
- Be careful of heat generated by lighting equipment.
- Do not disassemble the camcorder. If the camcorder does not function properly, consult qualified service personnel.
- Handle the camcorder with care. Do not subject the camcorder to shocks or vibration as this may cause damage.
- Avoid sudden changes in temperature. Moving the camcorder rapidly between hot and cold temperatures may cause condensation to form on its internal surfaces (📖 148).

Storage

- If you do not intend to use the camcorder for a long time, store it in a place free of dust, in low humidity, and at temperatures not higher than 86°F (30°C).
- After storage, check the functions of your camcorder to make sure that the camcorder is still working properly.

Cleaning

Camcorder Body and Lens

- Use a soft, dry cloth to clean the camcorder body and lens. Never use chemically treated cloth or volatile solvents such as paint thinner.

LCD Screen

- Clean the LCD screen using a commercially available cleaning cloth for glasses.
- Condensation may form on the surface of the screen when the temperature changes suddenly. Wipe it with a soft dry cloth.

Video Heads

- When the message "HEADS DIRTY, USE CLEANING CASSETTE" appears, or when the playback picture becomes distorted, the video heads need to be cleaned.
- To maintain the best picture quality, we recommend cleaning the video heads frequently with the Canon DVM-CL Digital Video Head Cleaning Cassette or a commercially available dry cleaning cassette.
- Do not use wet type cleaning cassettes as this may damage the camcorder.



Condensation

Moving the camcorder rapidly between hot and cold temperature may cause condensation (water droplets) to form on its internal surfaces. Stop using the camcorder if condensation is detected. Continued use may damage the camcorder.

Condensation may form in the following cases:

When the camcorder is moved from an air-conditioned room to a warm, humid place

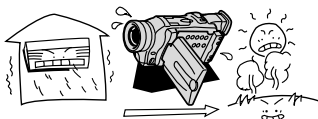

When the camcorder is moved from a cold place to a warm room

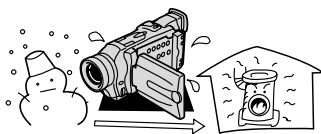

When the camcorder is left in a humid room

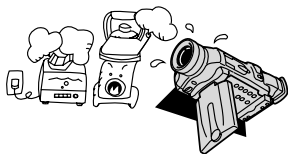



When a cold room is heated rapidly



How to avoid condensation:

- Unload the cassette, place the camcorder in an airtight plastic bag and let it adjust to temperature changes slowly before removing it from the bag.

When condensation is detected:

- The camcorder stops operating and the warning message "CONDENSATION HAS BEEN DETECTED" appears for approx. 4 seconds and  starts flashing.
- If a cassette is loaded, the warning message "REMOVE THE CASSETTE" appears and  starts flashing. Remove the cassette immediately and leave the cassette compartment open. Leaving the cassette in the camcorder may damage the tape.
- A cassette cannot be loaded when condensation is detected.

Resuming use:

- It takes about 1 hour until the water droplets evaporate. After the condensation warning stops flashing, wait for 1 more hour before resuming use.

Using the Camcorder Abroad

Power Sources

You can use the compact power adapter to operate the camcorder and to charge battery packs in any country with power supply between 100 and 240 V AC, 50/60 Hz. Consult the Canon Service Center for information on plug adapters for overseas use.

Playback on a TV Screen

You can only play back your recordings on TVs with NTSC system. The NTSC system is used in the following countries/areas:

American Samoa, Antigua, Aruba, Bahamas, Barbados, Bermuda, Bolivia, Canada, Chile, Columbia, Costa Rica, Cuba, Ecuador, El Salvador, Guam, Guatemala, Greenland, Haiti, Honduras, Jamaica, Japan, Korea, Mexico, Micronesia, Myanmar, Nicaragua, Panama, Peru, Philippines, Puerto Rico, Saint Kitts and Nevis, Saint Lucia, Saint Vincent and the Grenadines, Surinam, Taiwan, Trinidad and Tobago, USA, Venezuela, Virgin Islands.

Troubleshooting

E

If you have a problem with your camcorder, refer to this checklist. Consult your dealer or a Canon Service Center if the problem persists.

Power Source

Problem	Cause	Solution	□□
Camcorder will not turn on.	Battery pack is exhausted.	Replace or charge the battery pack.	16
	Battery pack is not correctly attached.	Attach the battery pack correctly.	16
The camcorder switches off by itself.	Battery pack is exhausted.	Replace or charge the battery pack.	16
	Power save function has been activated.	Turn on the camcorder.	28
Cassette compartment will not open.	Battery pack is exhausted.	Replace or charge the battery pack.	16
	Cassette compartment cover is not fully open.	Open the cassette compartment cover fully.	22
Cassette compartment stopped during loading/unloading.	Battery pack is exhausted.	Replace or charge the battery pack.	16
	The camcorder malfunctions.	Consult a Canon Service Center.	-
LCD/viewfinder switches on and off.	Battery pack is exhausted.	Replace or charge the battery pack.	16

Recording/Playback

Buttons will not work.	Camcorder is not turned on.	Turn on the camcorder.	28
	Cassette is not loaded.	Load a cassette.	22
⏏ flashes on the screen.	Battery pack is exhausted.	Replace or charge the battery pack.	16
🌫 flashes on the screen.	Condensation is detected.	See reference page.	148
"Remove the cassette" appears on the screen.	Camcorder stopped operating to protect the tape.	Unload and reload the cassette.	22
The wireless controller will not work.	Camcorder and wireless controller are not set to the same remote sensor mode.	Change the remote sensor modes.	48
	Batteries of the wireless controller are exhausted.	Replace the batteries.	24

Recording



Problem	Cause	Solution	□□
Image will not appear on the screen.	Camcorder is not set to CAMERA mode.	Set the camcorder to CAMERA mode.	28
"Set the time zone, date and time" appears on the screen.	Time zone, date and time are not set, or the backup battery is exhausted.	Set the time zone, date and time, or replace the backup battery and reset the date and time.	25
Pressing the start/stop button will not start recording.	Camcorder is turned off.	Turn on the power.	28
	Cassette is not loaded.	Load a cassette.	22
	Tape reached the end (END flashes on the screen).	Rewind the tape or replace the cassette.	22
	Cassette is protected (protect flashes on the screen).	Replace the tape or change the position of the protect switch.	23
	Camcorder is set to a mode other than the CAMERA mode.	Set the camcorder to CAMERA mode.	28
Camcorder will not focus.	Autofocus does not work on that subject.	Focus manually.	76
	Viewfinder is not adjusted.	Adjust the viewfinder with the diopter adjustment lever.	20
	Lens is dirty.	Clean the lens.	147
A vertical light bar appears on the screen.	Bright light in a dark scene may cause a vertical light bar (smear) to appear. This is not a malfunction.	---	-
Sound is distorted or recorded in a lower volume than the actual volume.	When recording near loud sound (such as fireworks, drums or concerts), sound may become distorted or may not be recorded in the actual sound level. This is not a malfunction.	---	-
Viewfinder picture is blurred.	Viewfinder is not adjusted.	Adjust the viewfinder with the diopter adjustment lever.	20

Playback

Pressing the playback button does not start playback.	Camcorder is turned off, or is not set to PLAY (VCR) mode.	Set the camcorder to PLAY (VCR) mode.	37
	Cassette is not loaded.	Load a cassette.	22
	Tape reached the end (END flashes on the screen).	Rewind the tape.	37
Image will not appear on the TV screen.	[AV/PHONES] is set to [PHONES] in the menu.	Set [AV/PHONES] to [AV] in the menu.	70
	[AV → DV OUT] is set to [ON].	Set [AV → DV OUT] to [OFF].	94
Tape is running, but image will not appear on the TV screen.	TV/VIDEO selector on the TV is not set to VIDEO.	Set the selector to VIDEO.	40
	Video heads are dirty.	Clean the video heads.	148
	You attempted to play back or dub copyright protected tape.	Stop playback/dubbing.	92
No sound from the built-in speaker.	Speaker volume is turned off.	Adjust the volume with the selector dial.	39

Memory Card Operation

E

Problem	Cause	Solution	
Memory card cannot be inserted.	Memory card was not facing the correct direction.	Turn the memory card over and reinsert it.	101
Memory card cannot be recorded.	Memory card is full.	Replace the memory card or erase images.	119
	Memory card is not formatted.	Format the memory card.	134
	Memory card is not inserted.	Insert a memory card.	101
	File number reached maximum value.	Set [FILE NUMBERS] to [RESET] and insert a new memory card.	103
	SD Memory Card is protected.	Change the position of the protect switch.	101
Memory card cannot be played back.	Camcorder is not set to CARD PLAY (VCR) mode.	Set the camcorder to CARD PLAY (VCR) mode.	115
	Memory card is not inserted.	Insert a memory card.	101
Image cannot be erased.	Image is protected.	Cancel the protection.	118
	SD memory card is protected.	Change the position of the protect switch.	101
 flashes red.	Card error occurred.	Turn off the camcorder. Remove and reinsert the memory card. Format the memory card if flashing persists.	134

System Diagram (Availability differs from area to area)

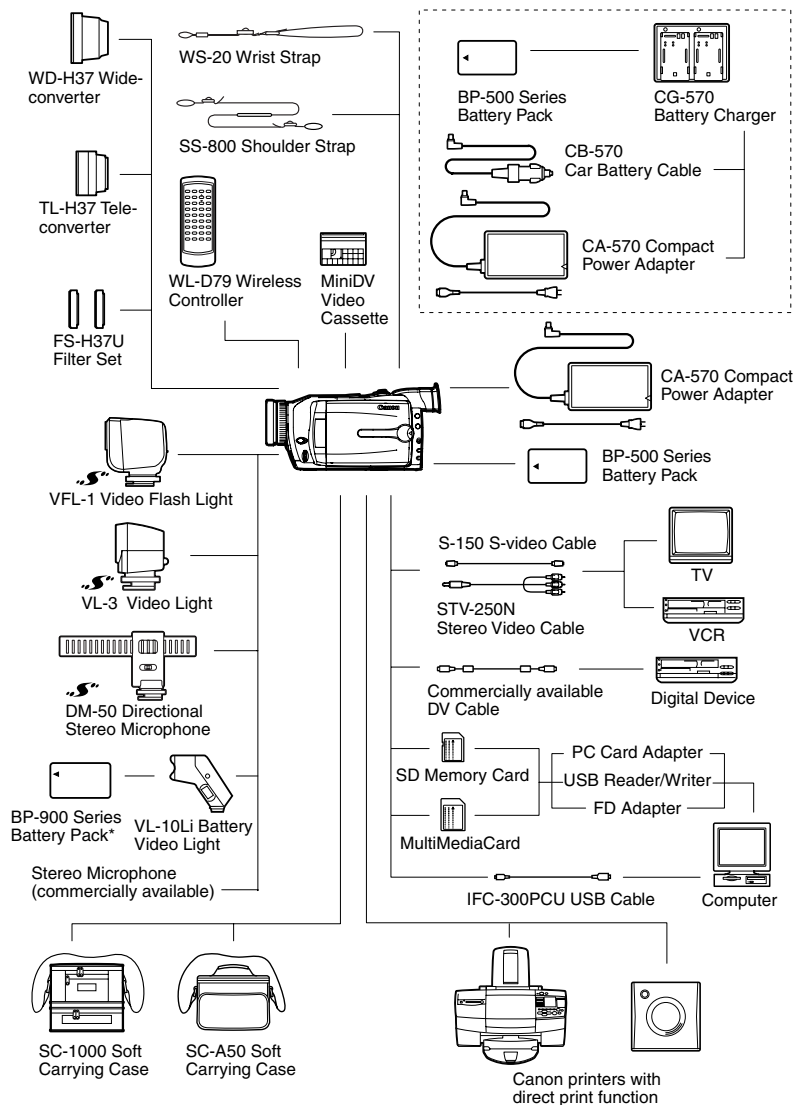

E

Additional Information

* Charging with the CA-920 Compact Power Adapter or CH-910 Dual Battery Charger/Holder (both optional)

Optional Accessories

E

Call or visit your local retailer/dealer for genuine Canon video accessories. You can also obtain genuine accessories for your Canon camcorder by calling: 1-800-828-4040, Canon U.S.A. Information Center.

BP-500 Series Battery Packs

When you need extra battery packs, select from the following: BP-511, BP-512, BP-522 or BP-535.

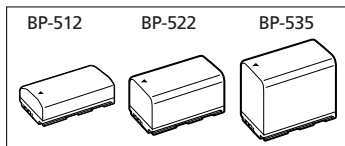

CG-570 Battery Charger

The battery charger can be used with the supplied CA-570 Compact Power Adapter or the optional CB-570 Car Battery Cable to charge BP-500 series battery packs.

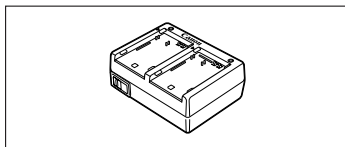

Battery Pack	Charging Time
BP-508 (OPTURA10)	55 min.
BP-512 (OPTURA20/optional)	95 min.
BP-511 (Optional)	95 min.
BP-522 (Optional)	140 min.
BP-535 (Optional)	205 min.

CB-570 Car Battery Cable

Use the car battery cable with the CG-570 Battery Charger to charge battery packs on the move. The car battery cable plugs into your car's cigarette lighter and runs off a 12-24 V DC negative ground battery.

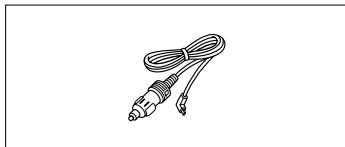

TL-H37 Tele-converter

This tele-converter lens increases the focal length of the camcorder lens by a factor of 1.5.

- The image stabilizer is not as effective when the tele-converter is attached.
- The image quality may be degraded at the telephoto side.
- The minimum focusing distance with the Tele-converter is 8.2 ft (2.5 m); 0.98 in. (2.5 cm) at maximum wide angle.

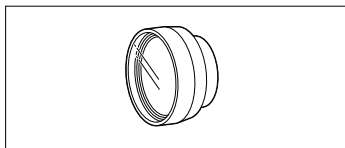

WD-H37 Wide-converter

This lens decreases focal length by a factor of 0.7, giving you a wide perspective for indoor shots or panoramic views.

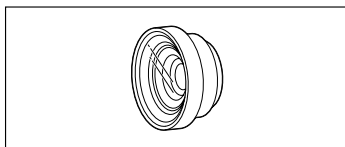

FS-H37U Filter Set

Neutral density and MC protector filters help you to control difficult lighting conditions.

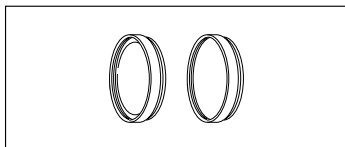

VL-10Li Battery Video Light

This compact yet powerful video light can be used for both indoor and outdoor shooting. It attaches to the camcorder's accessory shoe and is powered by BP-900 series battery packs.

- Approximate usage time: BP-915: 60 min., BP-930: 120 min., BP-945: 170 min.
- BP-900 series battery packs are charged with the CA-920 Compact Power Adapter.

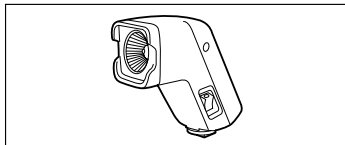

VFL-1 Video Flash Light

This video flash light allows you to record still images and movies even at night or in dark places. It attaches to the camcorder's advanced accessory shoe for cable-free operation.

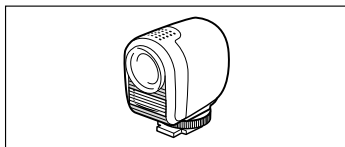

VL-3 Video Light

This video light enables you to record brightly in color even in dark places. It attaches to the camcorder's advanced accessory shoe for cable-free operation.

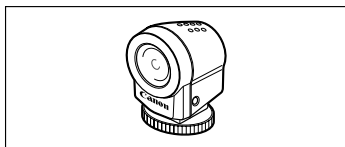

DM-50 Directional Stereo Microphone

This highly sensitive, super-directional microphone attaches to the camcorder's advanced accessory shoe. It can be used as directional microphone (monaural) or stereo microphone.

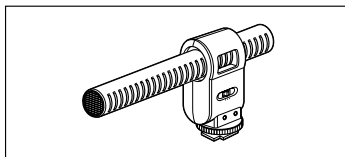

WS-20 Wrist Strap

Use this for extra additional protection for active shooting.

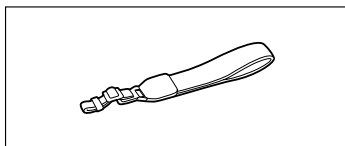

SC-1000 Soft Carrying Case

A handy camcorder bag with padded compartments and plenty of space for accessories.

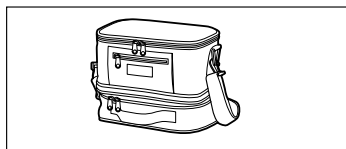
**SC-A50 Soft Carrying Case**

This lightweight bag keeps the camcorder within easy reach without weighing you down or getting in the way.



This mark identifies genuine Canon video accessories. When you use Canon video equipment, we recommend Canon-brand accessories or products bearing the same mark.

**Provided Accessories:**

WL-D79 Wireless Controller	D83-0622-000
SS-800 Shoulder Strap	D81-1430-000
Lens Cap	D52-0220-000
CA-570 Compact Power Adapter	9468A002AA
BP-512 Battery Pack (OPTURA20)	6760A002AA
BP-508 Battery Pack (OPTURA10)	D85-1360-000
STV-250N Stereo Video Cable	3067A002AA (D82-0590-201)
IFC-300PCU USB Cable	6906A001AA

Optional Accessories:

BP-511 Battery Pack	3055A002AA (D85-1112-201)
BP-522 Battery Pack	3174A002AA (D85-1122-201)
BP-535 Battery Pack	6741A002AA
SC-1000 Soft Carrying Case	3083A002AA (D81-1200-201)
SC-A50 Soft Carrying Case	D81-1302-201
WD-H37 Wide-converter	8836A001AA
TL-H37 Tele-converter	8835A001AA
FS-H37U Filter Set	8837A001AA
DM-50 Directional Stereo Microphone	3176A002AA (D84-0120-201)
VFL-1 Video Flash Light	8834A001AA
VL-3 Video Light	3175A002AA (D86-0121-201)
VL-10Li Battery Video Light	3140A002AA (D86-0081-201)
JR 7.2V 10WF Halogen Bulb	3141A002AA (D86-0090-201)
WS-20 Wrist Strap	3118A002AA (D81-0190-202)
DVM-CL DV Cleaning Cassette	3134A002AA (D36-0032-201)

Specifications

E

OPTURA20/OPTURA10

Power supply (rated):	7.4 V DC
Power consumption (AF turned on):	OPTURA20: 3.4 W (using viewfinder), 4.6 W (using LCD screen) OPTURA10: 3.4 W (using viewfinder), 4.4 W (using LCD screen)
Television system:	EIA standard (525 lines, 60 fields) NTSC color signal
Video recording system:	2 rotary heads, helical scanning DV system (Consumer digital VCR SD system); Digital component recording
Audio recording system:	Tape: PCM digital sound: 16 bit (48 kHz/2 ch); 12 bit (32 kHz/4 ch) Card: ADPCM digital sound: 16 bit (16 kHz/1 ch), 4 bit
Image sensor:	1/4" CCD (charge coupled device), approx. 1,330,000 pixels (Effective pixels: tape: approx. 690,000 pixels, card: approx. 1,230,000 pixels)
Tape format:	Videocassettes bearing the "MiniDV" mark.
Tape speed:	SP: 0.74 ips (18.81 mm/s), LP: 0.49 ips (12.56 mm/s)
Maximum recording time (80 min. cassette):	SP: 80 min., LP: 120 min.
Fast forward/rewind time:	Approx. 2 min. 20 sec. (with a 60 min. cassette)
Lens:	F1.8-3.0, 16x power zoom, f=4.0-64.0 mm; (card: F1.8-3.0, 15x power zoom, f=4.3-64.0 mm)
Focusing system:	TTL autofocus, manual focusing possible
Minimum focusing distance:	3.3 ft. (1 m), 0.39 in. (1 cm) on maximum wide angle
Maximum shutter speed:	1/8,000 sec. (1/250 sec. when using a memory card)
Minimum illumination:	0.5 lx (using the Night mode in CAMERA mode)
Recommended illumination:	More than 100 lx
Filter diameter:	37 mm
Viewfinder:	0.33 in., TFT color LCD, approx. 113,000 pixels
LCD screen:	OPTURA20: 3.5 in., TFT Color, approx. 123,000 pixels OPTURA10: 2.5 in., TFT Color, approx. 112,000 pixels
Microphone:	Stereo electret condenser microphone
Recording media:	SD Memory Card, MultiMediaCard
Number of recording pixels:	Still image: 1280 × 960, 640 × 480 pixels Movie: 320 × 240 pixels (approx. 10 sec.), 160 × 120 pixels (approx. 30 sec.), 15 frames/sec. The figures in brackets represent the maximum length of one movie clip.
Estimated SD Memory Card SDC-8M capacities:	1280 × 960: Superfine: 6 images/Fine: 10 images/Normal 18 images; 640 × 480: Superfine: 34 images/Fine 50 images/Normal 84 images
	The actual number varies according to the images. Sample images recorded on the supplied SD Memory Card are to be included in the total number.
File format:	Design rule for Camera File system (DCF), Exif 2.2 compliant, Digital Print Order Format (DPOF) compliant (still images only)
	This camcorder supports Exif 2.2 (also called "Exif Print"). Exif Print is a standard for enhancing the communication between camcorders and printers. By connecting to an Exif Print-compliant printer, the camcorder's image data at the time of shooting is used and optimized, yielding extremely high quality prints.
Image format:	Still image: JPEG (Compression mode: Superfine, Fine, Normal), Movie: Motion JPEG

USB terminal:	mini-B
DV terminal input/output:	Special 4-pin connector (IEEE 1394 compliant)
AV terminal input/output:	ø3.5 mm minijack Audio input: -10 dBV/40 kohms or more Audio output: -10 dBV (47 kohm load)/3 kohms or less Video: 1 Vp-p/75 ohms unbalanced
S-video terminal input/output:	1 Vp-p/75 ohms (Y signal), 0.286 Vp-p/75 ohms (C signal)
MIC terminal input:	ø3.5 mm stereo mini-jack -57 dBV (with 600 ohm mic)/5 kohms or more
Headphone terminal:	ø3.5 mm stereo minijack
Operating temperatures:	32 – 104°F (0 – 40°C)
Dimensions:	3 × 7.3 × 3.6 in. (75 × 186 × 92 mm)
Weight:	OPTURA20: 1.4 lb. (625 g), OPTURA10: 1.4 lb. (620 g)

CA-570 Compact Power Adapter

Power supply:	100 – 240 V AC, 50/60 Hz
Power consumption:	17W
Rated output:	8.4 V DC, 1.5 A
Operating temperature:	32 – 104°F (0 – 40°C)
Dimensions:	2.1 × 3.5 × 1.1 in. (52 × 90 × 29 mm)
Weight:	4.8 oz. (135 g)

BP-512/BP-508 Battery Pack

Battery type:	Rechargeable Lithium Ion Battery
Rated voltage:	7.4 V DC
Operating temperature:	32 – 104°F (0 – 40°C)
Battery capacity:	BP-512: 1100 mAh, BP-508: 800 mAh
Dimensions:	1.5 × 0.83 × 2.2 in. (38 × 21 × 55 mm)
Weight:	BP-512: 2.5 oz. (70g), BP-508: 2.3 oz. (65g)

SDC-8M SD Memory Card

Capacity:	8 MB
Interface:	SD Memory Card standard
Operating temperature:	32 – 104°F (0 – 40°C)
Dimensions:	1.3 × 0.94 × 0.08 in. (32 × 24 × 2.1 mm)
Weight:	0.07 oz. (2 g)

Weight and dimensions are approximate. Errors and omissions excepted. Subject to change without notice.

Index

12bit audio	99
16:9 wide screen	50
6-second auto date	85

A

Abroad, using the camcorder . . .	149
Accessories	9, 154
Advanced accessory shoe	71-75
AF assist lamp*	77
Analog line-in	90
Analog-digital converter	93
Assist lamp*	57, 77
Audio dubbing	97
Audio mode	69
Auto	55
Auto Exposure Bracketing	108
Autofocus	76
AV insert	95
AV→DV	93
AV/headphones terminal	39, 70

B

Backup battery	19
Battery charger	154
Battery pack	16
Beep	50
Brightness	33

C

Card animation	129
Card mix	128
Computer	100, 135
Condensation	148
Connections - TV	40
Connections - VCR	40
Continuous Shooting	107
Copyright signals	92
Copying still images	132

D

Data code	84
Date and time	25
Date search	86
Demo mode	51

Digital effects	59
Digital zoom	30
Direct print function	122
DV dubbing	91
DV terminal	89, 100

E

Easy recording	55
Effects	63
Erasing still images	119
Exposure	78

F

Faders	60
Fast forward	37
File numbers	103
Focusing	76
Focusing point	106
Focus-priority	107
Formatting	134

G

Grip belt	20
---------------------	----

H

Headphones	39, 70
----------------------	--------

I

Image quality	102
Image stabilizer	67
Index screen	116

L

LCD mirror mode	33
LCD screen	32
Lens cap	20
Low light mode	56
Low light plus mode *	57
LP mode	52

M

Magnifying the image	83
Maintenance	147
Manual focus	76

Memory card	101
Menus	43-47
Microphone	69
MIC terminal	69
Movie size	103
MultiMediaCard	101
Multi-image screen	65
My Camera settings	49

N

Night mode	57
------------	----

O

Output channel	42
----------------	----

P

Photo search	86
Playback - Memory card	115
Playback - Tape	37
Playback pause	38
Portrait mode	56
Power adapter	15
Print order	120
Protect	118

R

Record pause mode	28
Record review	35
Record search	35
Recording Movies (memory card)	113
Recording Movies (tape)	28
Recording programs	55
Recording Still Images (memory card)	105
Recording Still Images (tape)	53
Recording to a VCR	88
Remote sensor	48
Rewind	37

S

S1 video terminal	40
Sample images	138
Sand & Snow mode	56
Screen displays	140
SD Memory Card	101

Search select	86
Self-timer	68
Shutter sound	49
Shutter speed	79
Slide show	116
SP mode	52
Speaker	39
Sports mode	56
Spotlight mode	56
Still image quality	102
Still image size	102
Stitch Assist mode	111
Super Night mode *	57

T

Tape protection	23
Telephoto	30
Time code	141
Time zone	25
Tripod	36
Troubleshooting	150
TV Screen	40, 140

U

USB terminal	135
--------------	-----

V

Video	40
Video heads	148
Video ID-1 system	40
Video light	71, 72, 155
Videocassettes	22
Viewfinder	20

W

White balance	81
Wide screen	50
Wireless controller	24

Z

Zero set memory	87
Zooming	30

CANON® OPTURA20/OPTURA10 DIGITAL VIDEO CAMCORDER LIMITED WARRANTY

The limited warranty set forth below is given by Canon U.S.A., Inc. ("CUSA") with respect to each Canon OPTURA20/OPTURA10 Digital Video Camcorder ("DV Camcorder") purchased and used in the United States.

Each Canon DV Camcorder, when delivered to you in new condition in its original container, is warranted against defective material or workmanship as follows: for a period of one (1) year from the date of original purchase (three (3) months in the case of the video head part), defective parts or DV Camcorders returned to a CUSA factory service center ("CUSA Center") or an authorized DV Camcorder service facility ("Service Facility"), and proven to be defective upon inspection, will be repaired or exchanged for new or comparable rebuilt parts or DV Camcorders. The warranty period for repaired or replacement parts or DV Camcorders shall begin upon shipment of the same, but shall in no event exceed the original warranty period of the defective part or DV Camcorder.

Non-Canon brand peripheral equipment and software which may be distributed with Canon DV Camcorders are sold "AS IS", without warranty of any kind by CUSA, including any implied warranty regarding merchantability or fitness for a particular purpose. The sole warranty with respect to such non-Canon brand items is given by the manufacturer or producer thereof.

CUSA shall have no responsibility under this limited warranty for use of Canon DV Camcorders in conjunction with incompatible peripheral equipment and incompatible software.

In order to obtain warranty service, contact the authorized Canon retail dealer from whom you purchased the DV Camcorder or call the CANON INFORMATION CENTER AT 1-800-828-4040 (which is open from 9:00 a.m. to 5:00 p.m. (E.S.T.), Monday through Friday, excluding holidays). Have your unit serial number and your date of purchase available when you make the call to expedite service. In either case you will be directed to ship the DV Camcorder, postage prepaid, to the CUSA Center or Service Facility nearest to you. You must include a copy of the proof of purchase (bill of sale) and a complete explanation of the problem. DV Camcorders covered by this limited warranty will be repaired and returned to you without charge by the CUSA Center or the Service Facility. Repairs not under warranty will be at such cost as the CUSA Center or Service Facility may from time to time generally establish.

This limited warranty covers all defects encountered in normal use of the DV Camcorder, and does not apply in the following cases:

- Loss of or damage to the DV Camcorder due to abuse, mishandling, improper packaging by you, alteration, accident, leaking batteries, exterior nicks, scratches or dents, electrical current fluctuations, failure to follow operating instructions, maintenance and environmental instructions prescribed in CUSA's instruction manual, or service performed by other than a CUSA Center or Service Facility.
- Use of parts or supplies (other than those sold by CUSA) which cause damage to the DV Camcorder or cause abnormally frequent service calls or service problems.
- If any DV Camcorder has had its serial number or dating altered or removed.

This limited warranty does not apply to accessories or consumables for the DV Camcorder, which are sold "AS IS", without warranty of any kind by CUSA.

NO IMPLIED WARRANTY, INCLUDING ANY IMPLIED WARRANTY OF MERCHANTABILITY OR FITNESS FOR A PARTICULAR PURPOSE, APPLIES TO THE DV CAMCORDER AFTER THE APPLICABLE PERIOD OF EXPRESS WARRANTY STATED ABOVE, AND NO OTHER EXPRESS WARRANTY OR GUARANTY, EXCEPT AS MENTIONED ABOVE, GIVEN BY ANY PERSON, FIRM OR CORPORATION WITH RESPECT TO THE DV CAMCORDER SHALL BIND CUSA. (SOME STATES DO NOT ALLOW LIMITATIONS ON HOW LONG AN IMPLIED WARRANTY LASTS, SO THE ABOVE LIMITATION MAY NOT APPLY TO YOU) CUSA SHALL NOT BE LIABLE FOR LOSS OF REVENUES OR PROFITS, EXPENSE FOR SUBSTITUTE EQUIPMENT OR SERVICE, STORAGE CHARGES, LOSS OF DATA, OR ANY OTHER SPECIAL, INCIDENTAL OR CONSEQUENTIAL DAMAGES CAUSED BY THE USE, MISUSE OR INABILITY TO USE THE DV CAMCORDER, REGARDLESS OF THE LEGAL THEORY ON WHICH THE CLAIM IS BASED, AND EVEN IF CUSA HAS BEEN ADVISED OF THE POSSIBILITY OF SUCH DAMAGES. NOR SHALL RECOVERY OF ANY KIND AGAINST CUSA BE GREATER IN AMOUNT THAN THE PURCHASE PRICE OF THE DV CAMCORDER SOLD BY CUSA AND CAUSING THE ALLEGED DAMAGE. WITHOUT LIMITING THE FOREGOING, YOU ASSUME ALL RISK AND LIABILITY FOR LOSS, DAMAGE OR INJURY TO YOU AND YOUR PROPERTY AND TO OTHERS AND THEIR PROPERTY ARISING OUT OF USE, MISUSE OR INABILITY TO USE THE DV CAMCORDER NOT CAUSED DIRECTLY BY THE NEGLIGENCE OF CUSA. (SOME STATES DO NOT ALLOW THE EXCLUSION OR LIMITATION OF INCIDENTAL OR CONSEQUENTIAL DAMAGES, SO THE ABOVE LIMITATION MAY NOT APPLY TO YOU.) THIS LIMITED WARRANTY SHALL NOT EXTEND TO ANYONE OTHER THAN THE ORIGINAL PURCHASER OF ANY DV CAMCORDER, OR THE PERSON FOR WHOM IT WAS PURCHASED AS A GIFT, AND STATES YOUR EXCLUSIVE REMEDY.

This limited warranty gives you specific legal rights, and you may also have other rights which vary from state to state.

Canon U.S.A., Inc.
One Canon Plaza
Lake Success, New York 11042

CANON CONSUMER DIGITAL VIDEO EQUIPMENT LIMITED WARRANTY

The limited warranty set forth below is given by Canon Canada Inc. ("Canon Canada") with respect to Canon digital video equipment purchased in Canada. This limited warranty is only effective upon presentation of a bill of sale or other proof of purchase for this Canon digital video equipment to a Canon Service Facility when repairs are required.

Canon consumer video digital equipment is warranted under normal, non-commercial, personal use, against defective materials or workmanship as follows:

Parts: Defective parts will be exchanged for new parts or, at Canon Canada's option, comparable rebuilt parts for a period of one year from the date of original purchase, except Video Heads which will be exchanged for a period of 3 months from the date of purchase.

Labour: For a period of one year from the date of original purchase, labour will be provided free of charge by our Canon Service Facilities in Canada.

This limited warranty covers all defects except where:

(a) The loss or damage to the product results from:

- i) accident, natural disaster, mishandling, abuse, neglect, unauthorized product modification or failure to follow instructions contained in the instruction manual;
- ii) the use of accessories, attachments, products, supplies, parts or devices with this Canon product that do not conform to Canon specifications or that cause abnormally frequent service problems;
- iii) repairs or services performed by any party other than a Canon Service Facility;
- iv) defective batteries or any exposure to water, sand or dirt;
- v) shipping (claim must be presented to the shipper);

(b) Any serial number on the video equipment is altered or removed.

(c) The digital video equipment is used for commercial, professional or industrial purposes.

This limited warranty does not cover the cabinet (exterior finish) of the digital video equipment, video cassette tapes, head cleanings, nor does it apply to digital video equipment purchased outside Canada.

TO OBTAIN WARRANTY SERVICE

Ship your Canon digital video equipment in its original carton, box or equivalent, properly packed, fully insured with shipping charges prepaid, together with a copy of your bill of sale or other proof of purchase and a description of the problem to any of the Canon Service Facilities in Canada.

LIMITATIONS

Except as otherwise required by applicable legislation, this warranty is in lieu of all other warranties, conditions, guarantees or representations, express or implied, statutory or otherwise, relative to this Canon product, including implied warranties or conditions of merchantability or fitness for a particular purpose.

Canon Canada assumes no liability for special, consequential or incidental damages or loss that may arise, whether on account of negligence or otherwise, from the use, misuse or inability to use this Canon product (including loss of profit, revenue, video tapes or enjoyment) or from failure to conform to any express or implied warranties, conditions, guarantees or representations. Any recovery under this limited warranty shall not exceed the purchase price of the product. Canon Canada does not assume or authorize any other person to assume for Canon Canada any other liability with respect to this Canon product.

This warranty does not extend to any person other than the original purchaser of this Canon product or the person for whom it was purchased as a gift and states your exclusive remedy.

NOTICE TO CONSUMER

If you plan to take important videos or if the product has not been used for some time, please check all functions with the instruction book before using it.

Canon

CANON INC.

U.S.A. ————— **CANON U.S.A., INC. NEW JERSEY OFFICE**
100 Jamesburg Road, Jamesburg, NJ 08831 USA

CANON U.S.A., INC. CHICAGO OFFICE
100 Park Blvd., Itasca, IL 60143 USA

CANON U.S.A., INC. LOS ANGELES OFFICE
15955 Alton Parkway, Irvine, CA 92618 USA

CANON U.S.A., INC. HONOLULU OFFICE
210 Ward Avenue, Suite 200, Honolulu, HI 96814 USA

- **If you have any questions, call the Canon U.S.A. Information Center toll-free at 1-800-828-4040 (U.S.A. only).**

CANADA ————— **CANON CANADA INC. NATIONAL HEADQUARTERS**
6390 Dixie Road, Mississauga, Ontario L5T 1P7

CANON CANADA INC. CALGARY
2828, 16th Street, N.E. Calgary, Alberta T2E 7K7

CANON CANADA INC. MONTREAL
5990 Côte de Liesse, Quebec H4T 1V7

- **If you have any questions, call the Canon Canada Information Center toll-free at 1-800-828-4040. (Canada only)**
- **Si vous avez des questions, veuillez téléphoner sans frais au Canada 1-800-828-4040. (Canada seulement)**

MEXICO ————— **CANON MEXICANA, S. DE R.L. DE C.V.**
Periferico Sur No. 4124 Col. Ex-Rancho de Anzaldo C.P. 01900
México, D.F., México

CENTRO Y SURAMÉRICA ————— **CANON LATIN AMERICA, INC.**
703 Waterford Way Suite 400 Miami, FL 33126 USA

ASIA ————— **CANON HONGKONG COMPANY LTD.**
9/F, The Hong Kong Club Building, 3A Chater Road, Central, Hong Kong



Printed on 100% reused paper.
Document réalisé avec du papier recyclé à 100%.
El papel aqui utilizado es 100% reciclado.

Free Manuals Download Website

<http://myh66.com>

<http://usermanuals.us>

<http://www.somanuals.com>

<http://www.4manuals.cc>

<http://www.manual-lib.com>

<http://www.404manual.com>

<http://www.luxmanual.com>

<http://aubethermostatmanual.com>

Golf course search by state

<http://golfingnear.com>

Email search by domain

<http://emailbydomain.com>

Auto manuals search

<http://auto.somanuals.com>

TV manuals search

<http://tv.somanuals.com>