

## Contents

Using the DVD setup menu system.....	3
Setting up the player: Basic.....	3
Determine your display type.....	4
Use the best available audio connection.....	5
Connections for most CD or DVD playback.....	5
Connections for non-Dolby Digital/DTS Receivers, DVD-Audio and SACD.....	6
Setting up the player: Advanced.....	7
Setup menu options.....	7
Entering the setup menu system.....	7
General setup page.....	7
Speaker setup page.....	8
Audio setup page.....	10
Video setup page.....	11
Preference page.....	12

## Using the DVD setup menu system

In many places of this guide, the DVD player's Setup Menu needs to be adjusted to match your specific audio/video configuration. To access the DVD player's Setup Menu simply press the **SETUP** button on the remote control when the disc is stopped. When asking you to make menu adjustments, we will use the following terminology to indicate the location of the desired function:

**Setup Menu Name > Menu Item > Submenu Item (or Selection)**

**Setup Menu Name** is the actual name of the uppermost setup menu level. With the DVD89 Player there are exactly five (5) Setup Menu pages or sections, each represented by an icon on the top of the Setup Menu screen. They are: **General Setup Page**, **Speaker Setup Page**, **Audio Setup Page**, **Video Setup Page**, and **Preference Page**.

**Menu Item** is the parameter to be adjusted which appears below the **Top Menu Name**. It is the list of items on the left of the current Setup screen.

**Submenu Item (or the selection)** is the actual numeric or descriptive element that represents the change being made to the selected parameter. It is the item located to the immediate right of its corresponding **Menu Item**.

This diagram should give a good description of the various elements and their context. In this screen we could, for example, instruct you to set the **Rear Speaker** parameter to **Small** in the **Speaker Setup Page**. To indicate where we were, you would see the following: **Speaker Setup Page > Rear Speaker > Small**.

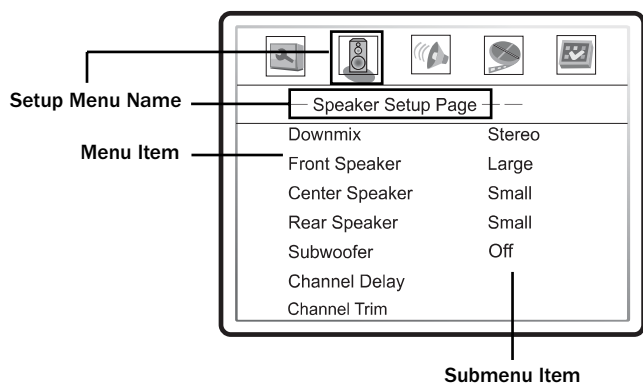

## Setting up the player: Basic

Follow these simple steps to successfully set up your player for use in your system:

### Use the best available video connection

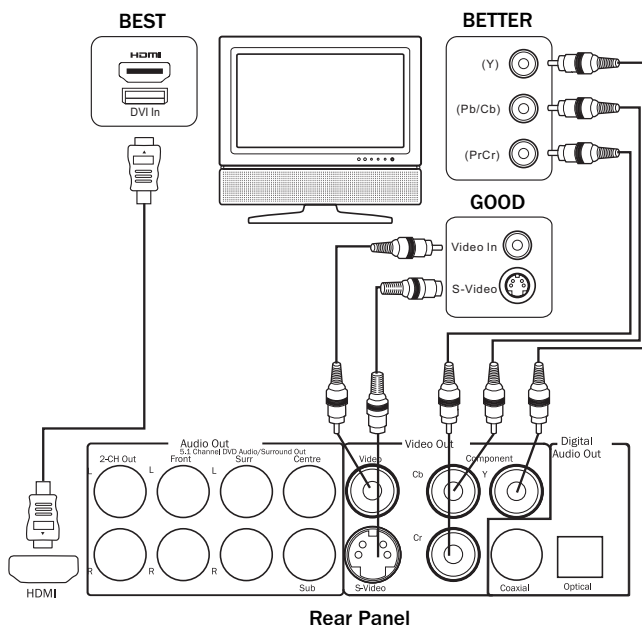

If an HDMI or DVI connection is present on your television or display, use it. The DVD89 player has an HDMI (digital) video output which presents the highest possible resolutions and video quality. If the television you are using has only component video inputs, then select a component video cable (it has three RCA-style connections on each end typically colored red, green, and blue). If your television is older and has neither of these inputs you may use s-video (a special 4-pin cable) or composite (typically a single yellow RCA-style cable).

## Determine your display type

For best performance, your DVD89 player must be correctly configured for playback even before the first disc is inserted. This is done under **General Setup Page > TV Display** in the Setup Menu.

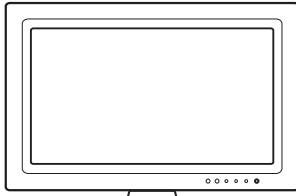

Widescreen or 16:9 TV

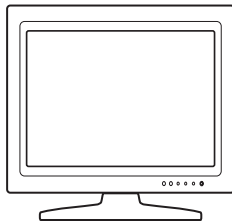

Standard Definition or 4:3 TV

If you have a widescreen (16:9) display as pictured above, select one of these options:

- **16:9 Wide** – 16:9 (widescreen) sources will be displayed in their native aspect ratio, and 4:3 sources will be stretched.
- **16:9 Wide/SQZ** – 16:9 (widescreen) as well as 4:3 sources will be displayed in their native aspect ratio. Please note that in this mode 4:3 sources will be displayed with black borders on both sides to maintain the correct 4:3 aspect ratio.

**Important:** If you are using a plasma or widescreen CRT display you will want to avoid leaving black bars on the screen for any length of time as you may encounter temporary burn-in where the display retains memory of the “used” part of screen and the unused (black bar) portions are clearly defined on the screen during subsequent viewing sessions. The “16:9 Wide” mode is the best choice for these types of displays.

If you have a 4:3 or standard definition screen as pictured above, select one of these options:

- **4:3 Pan/Scan** – 4:3 TV Pan and Scan. Choose when the display is 4:3. Both sides of a widescreen image are clipped (you lose about 30% of the picture).
- **4:3 Letterbox** – 4:3 TV Letterbox. Choose when the display is 4:3. Widescreen image is displayed in “letterbox” format with black borders on top and bottom (preferred).

### Notes when using HDMI

- If your AV receiver or display has an HDMI input, you can use the included HDMI cable to connect the DVD player to the TV. This is the most preferred connection method as it provides a pure digital connection for video signal and, depending upon your system, can also deliver high resolution digital audio over the same cable.
- When playback is completely stopped, use the “HDMI” button on the remote control to switch the video output resolution. Select the resolution that produces the best picture quality on your TV. For most flat panels and DLP™, LCD or LCoS (SXR™, D-ILA™) rear projection televisions this will be 720p. For CRT rear projection televisions this will likely be 1080i. For non HD displays (very rare if they have HDMI or DVI) this will be 480p.
- If the HDMI input of your TV is only capable of decoding 2-channel digital audio, it is recommended that you set **Speaker Setup Page > Down-mix** to “Stereo”. This sets the audio down-mix mode of the DVD player to “Stereo”.

## Use the best available audio connection

### Connections for most CD or DVD playback

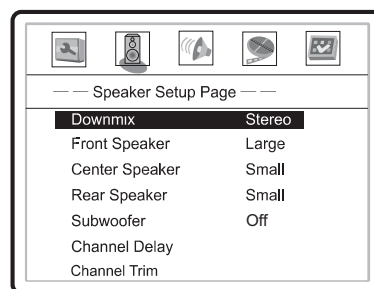
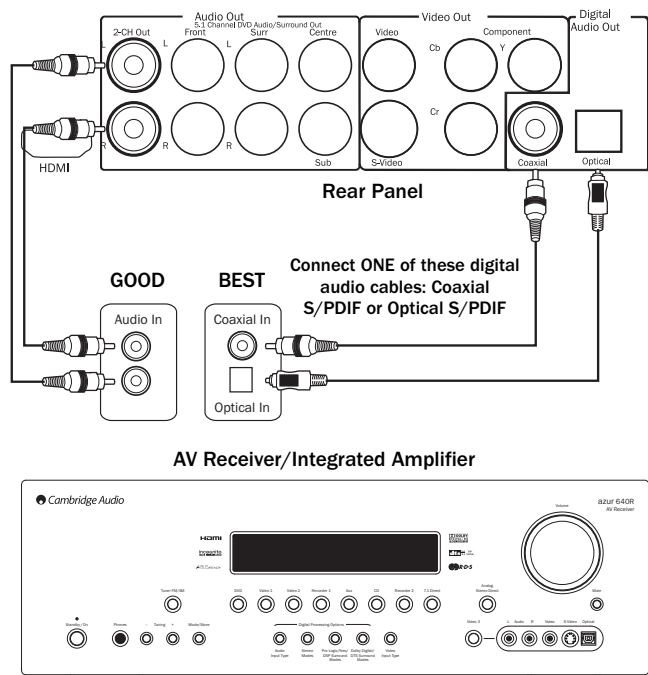

Speaker Setup Page > Downmix\* settings: Left/Right, Stereo, V.Surr, 5.1CH \*does not affect digital player outputs.

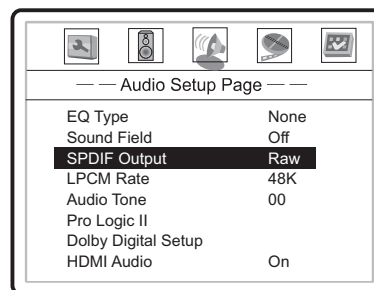

Audio Setup Page > SPDIF Output\* settings: Raw, PCM \*does not affect analogue player outputs

If at all possible you will want to connect audio using digital cables (either coaxial S/PDIF or optical S/PDIF). If your receiver or integrated amplifier does not have Dolby Digital or DTS capability (for instance, an older Pro Logic model) then you should connect the "Mixed" stereo output of the DVD89 player to your receiver or integrated amplifier (and immediately start saving for an upgrade!) Setting up, you have the following choices:

- **No Surround Speakers:** If the audio system does not have surround speakers, please use the analogue RCA-style cables and set the **Speaker Setup Page > Down-mix** to "Stereo" or "V. Surround".
- **Surround, But No Dolby Digital or DTS Support:** If the audio system has surround speakers and Dolby Pro Logic Surround support, please use the analogue RCA-style cables set the **Speaker Setup Page > Down-mix** to "Left/Right".
- **Surround Speakers and/or DTS and/or Dolby Digital Support:** If your receiver supports Dolby Digital and/or DTS then please use a digital coaxial or optical cable and set the **Audio Setup Page > SPDIF Output** to "Raw". No additional audio cables will be needed unless you listen to SACD (see opposite).

Manufactured under license from Dolby Laboratories. "Dolby" and the double-D symbol are trademarks of Dolby Laboratories. "DTS" and "DTS Digital Out" are trademarks of Digital Theater Systems, Inc.

## Connections for non-Dolby Digital/DTS Receivers, DVD-Audio and SACD

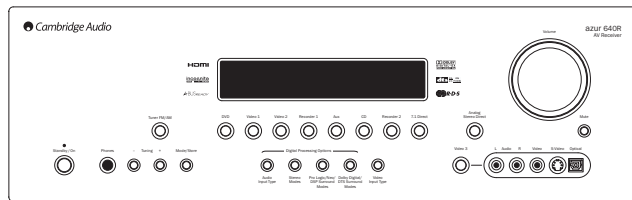
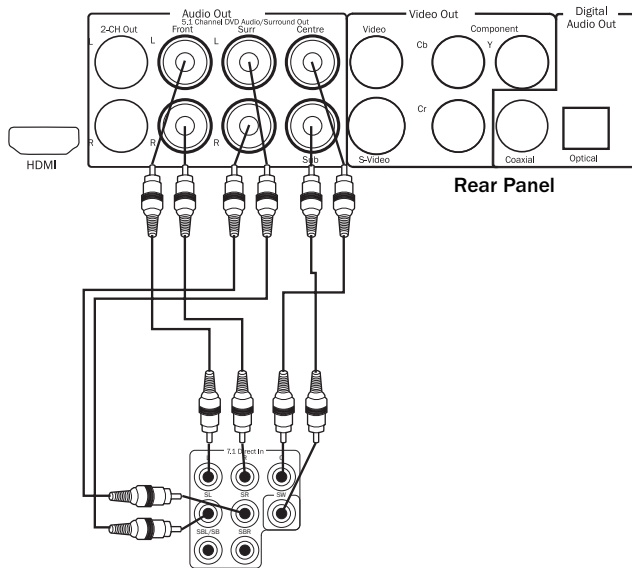

AV Receiver/Integrated Amplifier

### SACD or DVD-Audio playback

To utilize SACD or DVD-Audio you will also need to connect six (6) analogue RCA-style cables from the DVD89 player to your receiver's multi-channel analogue inputs. These multi-channel outputs will also support playback of DVD-Audio, DTS, Dolby Digital and stereo sources. Here are some general notes and guidelines to following depending upon what formats you intend to play:

### Dolby Pro Logic receivers

If you have an older Dolby Pro Logic surround receiver that does not support Dolby Digital or DTS but has multichannel inputs, you will want to connect the 6 analogue outputs of the DVD89 player to the analogue multichannel inputs of your receiver. To do this you must:

- Use six (6) analogue RCA-style cables and set the **Speaker Setup Page > Down-mix** to "5.1CH".
- Enable or select the multi-channel analogue inputs on your receiver.

This is absolutely worth it if you haven't yet upgraded your receiver. Truly discrete audio channels are a wondrous thing, so enjoy them if you can.

## Setting up the player: Advanced

### Setup menu options

The following is an advanced tour of the Setup Menu options which enables control over how your DVD player functions in various situations and with various program material and hardware. The DVD89 player comes with a "safe" default configuration, so you should get performance out of your player even if you don't touch the Setup Menu system. For those of you wanting to understand more and really tweak your settings, read on...

### Entering the setup menu system

1. Press the **SETUP** button on the remote control, and the TV screen displays: 10 SETUP

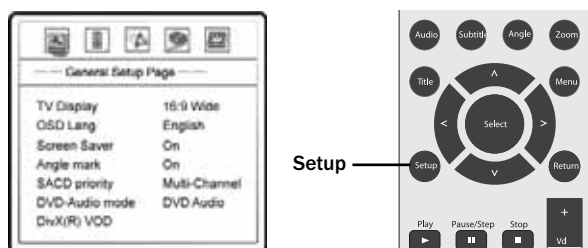

2. Press the **LEFT/RIGHT ARROW** buttons to select the setup page. There are 5 pages: **General Setup**, **Speaker Setup**, **Audio Setup**, **Video Setup**, and **Preference**. Press the **SELECT** button to enter the selected setup page. The **Preference** page can only be accessed when playback is completely stopped, or when there is no disc in the player.
3. Press the **UP/DOWN ARROW** buttons to select the setup item to be changed, and press the **SELECT** button to change the setting. Grayed-out setup items cannot be changed. To allow changing of such items, make sure the item is applicable, that playback is completely stopped, and/or there is no disc in the player. For example, in the Video Setup Page (below), you may use the **UP/DOWN ARROW** buttons to select the "Contrast" setup item, and press the **SELECT** button to change the "Contrast" setting.



4. To select a value from the list of available settings, press the **UP/DOWN ARROW** buttons and then press the **SELECT** button to confirm.
5. To exit the **SETUP** menu, press the **SETUP** button on the remote control.

## General setup page



1. **TV Display:** This is a primary setting and is addressed in the **Setting up the player: Basics** section. To set the aspect ratio of the DVD player's output image to match your TV, select from the following:
  - **16:9 Wide** – 16:9 (widescreen) sources will be displayed in their native aspect ratio, and 4:3 sources will be stretched.
  - **16:9 Wide/SQZ** – 16:9 (widescreen) as well as 4:3 sources will be displayed in their native aspect ratio. Please note that in this mode 4:3 sources will be displayed with black borders on both sides to maintain the correct 4:3 aspect ratio.
  - **4:3 Pan/Scan** – 4:3 TV Pan and Scan. Choose when the display is 4:3. Both sides of a widescreen image are clipped (you lose about 30% of the picture).
  - **4:3 Letterbox** – 4:3 TV Letterbox. Choose when the display is 4:3. Widescreen image is displayed in "letterbox" format with black borders on top and bottom (preferred).

DVD Content	TV Screen Appearance			
	4:3		16:9	
	Pan-Scan	Letterbox	Wide	Wide/SQZ
4:3				
16:9				

2. **OSD Lang (English):** English is the only available language for the US version of this player.
3. **Screen Saver (on/off):** To turn on/off the screen saver function. When the screen saver is on, a moving logo will appear instead of the static image after 2 minutes of inactivity. This is designed to minimize the burn-in issue for plasma and CRT display devices.
4. **Angle Mark (on/off):** To turn on/off the display of angle mark when DVD content with multiple available angles is played.
5. **SACD Priority:** To select which audio tracks to play for SACD (Super Audio CD). The options are:
  - **Multi-Channel** – Play the multi-channel surround audio
  - **2-Channel** – Play the 2-channel stereo audio
  - **CD MODE** – Play the CD layer of a hybrid SACD disc
6. **DVD-Audio Mode:** To select which portion of a hybrid DVD-Audio disc to playback. The options are:
  - **DVD-Audio** – Play the DVD-Audio portion of the disc with surround audio
  - **DVD-Video** – Play the DVD-Video portion of the disc with Dolby Digital or DTS audio

## Speaker setup page



1. **Down-mix Mode:** This sets the audio down-mix mode to convert multi-channel audio into two-channel output. This setting only affects the "Mixed L/R" analogue audio outputs. The options are:

- **Left/Right** - Left and Right channels only. This mode is intended for use with two-channel Dolby Pro Logic receivers. If the content is encoded with Dolby Pro Logic then the encoded audio will be correctly preserved and passed to the receiver for Dolby Pro Logic processing. For stereo content the output will be stereo.
- **Stereo** - This mode down-mixes decoded multi-channel (5.1ch) audio to 2-channel stereo output. For stereo content the output will be stereo. For multi-channel content the surround and center channels will be mixed with the left and right front channels. Recommended for use with TV sets or stereo receiver/amplifiers.
- **V. Surround** - Virtual Surround. This mode creates a virtual surround effect from stereo or multi-channel audio contents.
- **5.1CH** - This mode enables 5.1ch decoded analogue audio output. The number of actual output channels depends on the disc. **Note:** For multi-channel content, only the left front and right front channels will be re-produced from the Down-mix outputs. If you are using two speakers and don't hear dialogue or vocals, double check that this mode is not engaged.

### Analogue multi-channel output settings

The following settings only affect the analogue multi-channel outputs, not the digital coaxial or optical outputs of the DVD player. We recommend using the analogue multi-channel outputs of this player only when you are playing SACD or DVD-Audio discs and/or cannot utilize HDMI or the digital audio outputs with your audio system.

2. **Front Speaker:** To set the sound filtering control for the front speakers. The options are:

- **Large** - Choose if the front speakers are full range (reproduce down to at least 40Hz) and if you do not have a subwoofer. Bass frequencies are passed to the front speakers.
- **Small** - Choose if the front speakers are not "full range" speakers (almost all speakers qualify to be "small"). Bass frequencies are not passed to the front speakers to reduce possible distortion. This is the preferred setting for all systems utilizing a subwoofer.

3. **Center Speaker:** To set the sound filtering control for the center speaker. The options are:

- **Large** - Choose if the center speaker is full range (reproduces down to at least 40Hz) and if you do not have a subwoofer. Bass frequencies are passed to the center speaker.
- **Small** - Choose if the center speaker is not a "full range" speakers (almost all center channels qualify to be "small"). Bass frequencies are not passed to the front speakers to reduce possible distortion. This is the preferred setting for all systems utilizing a subwoofer.
- **Off** - Choose if there is no center speaker. This sends Center Speaker information to the Front Speaker outputs.

4. **Rear Speaker:** To set the sound filtering control for the rear speakers. The options are:

- **Large** - Choose if the rear/surround speakers are full range (reproduce down to at least 40Hz) and if you do not have a subwoofer. Bass frequencies are passed to the rear speakers.
- **Small** - Choose if the rear/surround speakers are not "full range" speakers (almost all speakers qualify to be "small"). Bass frequencies are not passed to the rear speakers to reduce possible distortion.
- **Off** - Choose if there are no rear speakers. This sends Rear Speaker information to the Front Speaker outputs.

5. **Subwoofer:** To enable/disable the Subwoofer output. The options are:

- **On** - Subwoofer output is enabled.
- **Off** - Subwoofer output is disabled.

6. **Channel Delay:** This feature, which is displayed in inches, sets the delay time for the Center and Rear speakers as well as the Subwoofer. The delay is to compensate for differences between the distance of the Front speakers to the listening position, and the distances measured by the other speakers in the system (Center, Surrounds and Subwoofer).

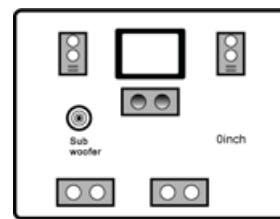

- Measure the distance (in inches) from the primary listening position to the Front Left Speaker. This is your baseline measurement - the primary distance that will determine the adjustments for your system. Your Front Right and Left speakers should measure the same distance. If they do not, please adjust them if possible.



## Speaker setup page continued

- Press the UP/DOWN ARROW buttons to select the first speaker to configure.
  - Measure the distance (in inches) from that speaker to the listening position. If it is LESS than the distance to the Front Left speaker, enter the difference (as close as possible) in inches using the LEFT/RIGHT ARROW buttons. If it is GREATER than the distance to the Front Left speaker, then leave the value at 0.
  - Repeat for each speaker in the system (Center, Left Surround, Right Surround, and Subwoofer) as available.
  - Press the SELECT button to confirm the settings and return to the Speaker Setup Page.
  - If the distance between the listener and the front speakers are 60 inches, and the distance between the listener and the left surround speaker is 80 inches, the distance difference is 20 inches.
  - This DVD player does not support delays for when the distance between the center or surround speakers and the listener are **shorter** than that between the front speakers and the listener.
  - In case the channel delay settings cannot match your speaker configuration, please set all distance difference to 0 inch and use your receiver/amplifier to set the channel delay (if possible).
7. **Channel Trim:** To set the volume of each individual channel.

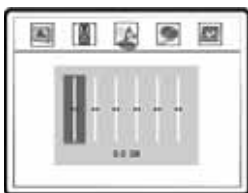

- Press the LEFT/RIGHT ARROW buttons to select the channel to be adjusted.
- Press the UP/DOWN ARROW buttons to raise or lower the volume of the selected channel in 0.5dB increments.
- Press the SELECT button to confirm the settings and return to the **Speaker Setup Page**.

### Example channel delay adjustment:

#### Supported configuration

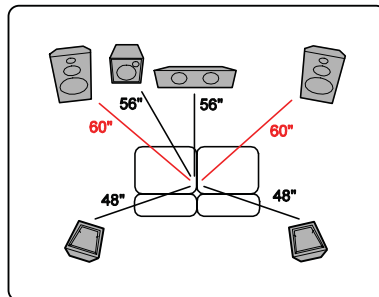

#### Settings:

Center Speaker – 4 Inches  
 Subwoofer – 4 Inches  
 Left Surround – 12 Inches  
 Right Surround – 12 Inches

#### Unsupported configuration

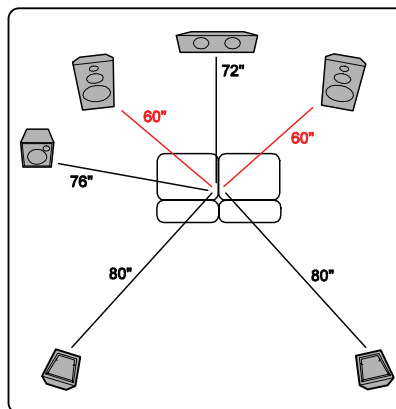

#### Settings:

Center Speaker – 0 Inch  
 Subwoofer – 0 Inch  
 Left Surround – 0 Inch  
 Right Surround – 0 Inch

## Audio setup page

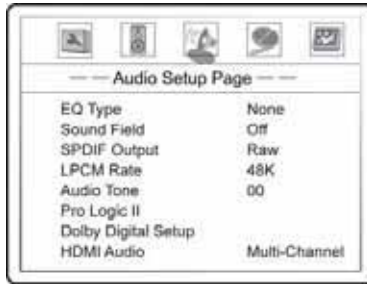

- EQ Type (None/Rock/Pop/Live/Dance/Techno/Classic/Soft):** This sets a corresponding equalization pattern type to the current music track. **Note:** These EQ options are not available for SACD, DTS or DVD-Audio tracks.
- Sound Field (Off/Concert/Living/Room/Hall/Bathroom/Cave/Arena/Church):** These allow users to engage fun sound field effects that will alter the original audio presentation as it was intended. **Note:** These EQ options are not available for SACD, DTS or DVD-Audio tracks.
- SPDIF Output:** This set the bit stream type of the digital audio output for use with Dolby Digital and DTS-compatible receivers. The options are:
  - Raw** – Passes the encoded multi-channel digital audio unaltered. Choose this setting if your receiver/amplifier is capable of decoding Dolby Digital and/or DTS.
  - PCM** – Forces down-mixed 2-channel digital audio output. Choose this setting if your receiver/amplifier only supports stereo digital (PCM) audio.
- LPCM Rate:** To set the maximum Linear PCM output frequency. The options are:
  - 48K** – Supported by most equipment.
  - 96K** – Allows a higher sampling rate and frequency response. Ensure that the receiver/amplifier can support it.
  - 192K** – Allows the highest sampling rate and frequency response. Ensure that the receiver/amplifier can support it and that your dogs are safely away from the listening area.

**Note:** The LPCM rate is selectable only when HDMI Audio is turned off.

- Audio Tone (+/-16):** This function raises or lowers the tone (key/pitch) of the audio track. This is useful for playing Karaoke discs and should not be used for regular music listening or movies.
  - Press the SELECT button to show the tone control window.
  - Press the LEFT/RIGHT ARROW buttons to lower or raise the tone/pitch.
  - Press the SELECT button to confirm the setting.

6. **Pro Logic II:** Taking a step further than most DVD players, the OPPO DVD player allows you to configure Dolby Pro Logic II to expand 2-channel source audio into full 5-channel surround sound. **Note:** Pro Logic II functionality is effective only when **Speaker Setup Page > Down-mix** is set to “5.1ch” and **SPDIF Output** is set to “Raw”.

- Press the SELECT button to enter the Pro Logic II Config page.
- Press the LEFT ARROW button to exit the Pro Logic II Config page.

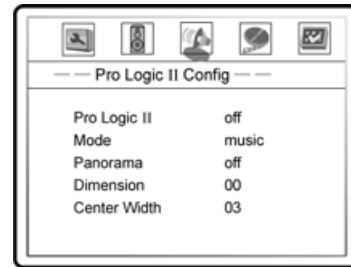

A. **Pro Logic II:** To turn on or off the Pro Logic II processing. The options are:

- On** – Pro Logic II processing is always on
- Off** – Pro Logic II processing is disabled
- Auto** – Pro Logic II processing is on only when Dolby Pro Logic II encoded content is detected.

B. **Mode:** To set the processing mode of Pro Logic II. The options are:

- Music** – The surround experience is tailored for multi-channel music playback
- Movie** – Emphasis is given to the center channel as two-channel audio is decoded and played back into your 5.1 system
- Pro Logic** – This activates decoding and processing of the original Dolby Pro Logic processing with mono-surround channel. We recommend using the Dolby Pro Logic Movie mode in lie of this 4-channel surround format.
- Auto** – Automatically selects processing mode based on the input format

C. **Panorama (Music mode only):** Turns on/off panorama mode. When turned on, the front stereo audio is partially fed into the surround channels for an enveloping effect.

D. **Dimension (Music mode only):** Allows gradual adjustment of the soundfield either towards the front or towards the rear. This is useful in setting a more even balance from all speakers with some rooms.

E. **Center Width (Music mode only):** To control the width of the center channel sound effect by blending the center speaker to the left and right speakers. As the level number increases, the center channel sound moves toward the left and right speakers.

## Audio setup page continued

7. **Dolby Digital Setup:** To configure the Dolby Digital decoder, press the SELECT button to enter the Dolby Digital Setup page and press the LEFT ARROW button to exit the Dolby Digital Setup page.

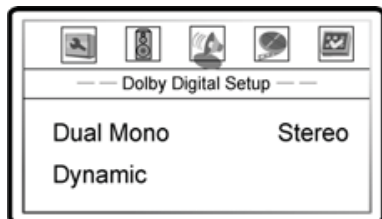

- A. **Dual Mono:** To choose the output for Dolby Digital discs encoded with two independent audio channels, such as bilingual programs. The options are:

- **Stereo** – Stereo output
- **L-Mono** – Left channel output to both Left and Right speakers.
- **R-Mono** – Right channel output to both Left and Right speakers.
- **Mix Mono** – Left and Right channels mixed to both Left and Right speakers.

- B. **Dynamic:** To set the Dynamic Range Compression (DRC). DRC can smooth out the sonic peaks and valleys common with wide-range digital audio. Increasing DRC may make low level audio more audible during low-level listening. Decreasing or turning off DRC restores the sonic energy present in the original recording.

8. **HDMI Audio:** Turns the audio output from the HDMI port on or off.

- A. **Multi-Channel** – Digital audio output via HDMI will be multi-channel PCM format (HDMI 1.1 audio). The Down-mix setting in the “Speaker Setup Page” will affect whether and how multichannel audio content will be down-mixed to stereo. When this option is selected, compressed audio bit streams will be decoded by the DVD player.

- B. **SPDIF** – Digital audio output via HDMI will be the same as the SPDIF (digital coaxial/optical audio) output. The SPDIF setting will affect whether 2-channel PCM or raw compressed bit streams will be carried over via HDMI. When this option is selected and SPDIF is set to “Raw”, the TV or HDMI A/V receiver must decode compressed audio formats. (Copyright protection on some DVD-Audio and Super Audio CD discs may prevent audio output via HDMI with this setting.)

- C. **Off** – No digital audio output via HDMI.

## Video setup page

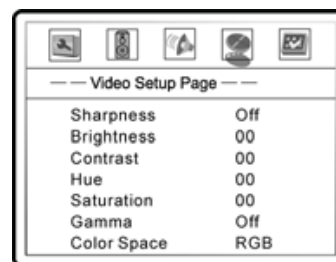

1. **Sharpness:** To set the sharpness of video output. Sharpness level can be set with the following options:

- **Sharp** – Enables edge enhancement which is an artificial and picture-degrading feature. We recommend leaving this off.
- **Soft** – Softens edges by smoothing the image which may cause slight loss of details.
- **Off (recommended)** – Turns off edge enhancement completely.

2. **Brightness:** Adjusts the brightness (black level) of the video output.

- Press the SELECT button to show the Brightness scale, and then use the LEFT/RIGHT ARROW buttons to adjust.
- Press the SELECT button to confirm the new setting.

3. **Contrast:** Adjusts the contrast (white level) of the video output.

**Important:** The ability to set brightness and contrast is no small thing. If you do not have the correct black and white levels then your images can appear washed out or you won't be able to see into the shadows when watching darker scenes in movies. Televisions have brightness (black level) and contrast (white level) controls; however it may take a combination of tweaking both the DVD player and your television to get just the right result. We recommend using a calibration DVD like AVIA Guide to Home Theater or Digital Video Essentials and setting your display for the best possible picture. Once that is done, see if the DVD player settings can get even closer.

4. **Hue:** Adjusts the hue (tint) of the video output.

5. **Saturation:** Adjusts the saturation (color intensity level) of the video output.

6. **Gamma:** Adjusts the Gamma (the actual transition from black to white) of the video output. The available settings are High, Medium, Low and Off.

7. **Color Space:** Selects the color space for the HDMI output. The available options are:

- **Auto (recommended)** – Allows the DVD player to automatically select the best color space based on capability information collected from the TV display.
- **YCbCr 4:4:4** – Forces YCbCr 4:4:4 color space. If you select this option please make sure that your TV is configured to accept YCbCr 4:4:4 signals, otherwise the video color will be incorrect.
- **RGB** – Forces RGB color space. If you select this option please make sure that your TV is configured to accept RGB signals, otherwise the video color will be incorrect.

## Preference page

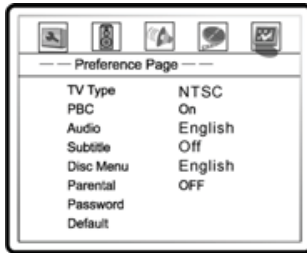

The Preference Page can only be accessed when playback is completely stopped, or when there is no disc in the DVD player.

1. **TV Type:** Sets the output video system (PAL/NTSC) to match the type of TV. The options are:

- **Auto** – No system conversion is performed. The output video system is the same as that encoded on the disc. This requires a TV that supports NTSC and PAL input.
- **PAL** – When playing PAL-encoded discs, no system conversion is performed. NTSC encoded discs are converted to PAL output.
- **NTSC (default)** – When playing NTSC-encoded (Region 1) discs, no system conversion is performed. PAL-encoded discs are converted to NTSC output.

2. **PBC (Play Back Control):** Enables/disables play back control by disc contents. The options are:

- **On** – If the disc contains Play Back Control, follow the disc instructions.
- **Off** – Play back the contents by sequence.

3. **Audio:** Sets the preferred audio language for DVD. If an audio track of the selected language is available on the disc, the audio track will be played back.

4. **Subtitle:** Sets the preferred subtitle language for DVD. If a subtitle of the selected language is available, it will be displayed. When "Auto" is selected, the subtitle display is decided by the disc.

5. **Disc Menu:** Sets the preferred language for displaying DVD disc menus. If a disc menu of the selected language is available, the menu will be shown instead of the default disc menu.

**Important:** If your preferred language is not listed in the Audio, Subtitle or Disc Menu options, select "Other" and enter the Language Code found on the Users Manual that comes with your DVD player.

6. **Parental Control:** Sets parental control ratings in order to prevent minors from watching inappropriate contents. This function requires that the disc being properly rated and encoded.

- Press the SELECT button to bring up the rating selection menu.
- Press the UP/DOWN ARROW buttons to select the rating to allow (G/PG/PG 13/PGR/R/NC17/ADULT). The selected rating and below will be allowed, and any rating above the selected will be blocked.
- Press the SELECT button to confirm the selection. You will be asked for the parental control password. Enter the password (default password: 7890) and press the SELECT button.

7. **Password:** Sets parental control password. To change the password, enter the old password (default: 7890) and then enter a 4-digit number as the new password. Enter the new password again to confirm, and then press the SELECT button.

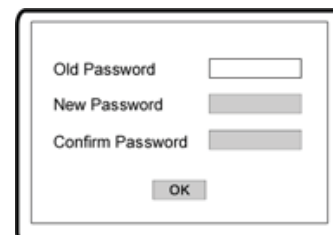

8. **Default:** Resets all settings to the factory default value. The parental control password will not be reset.

Cambridge Audio  
Gallery Court  
Hankey Place  
London SE1 4BB  
England

[www.cambridge-audio.com](http://www.cambridge-audio.com)

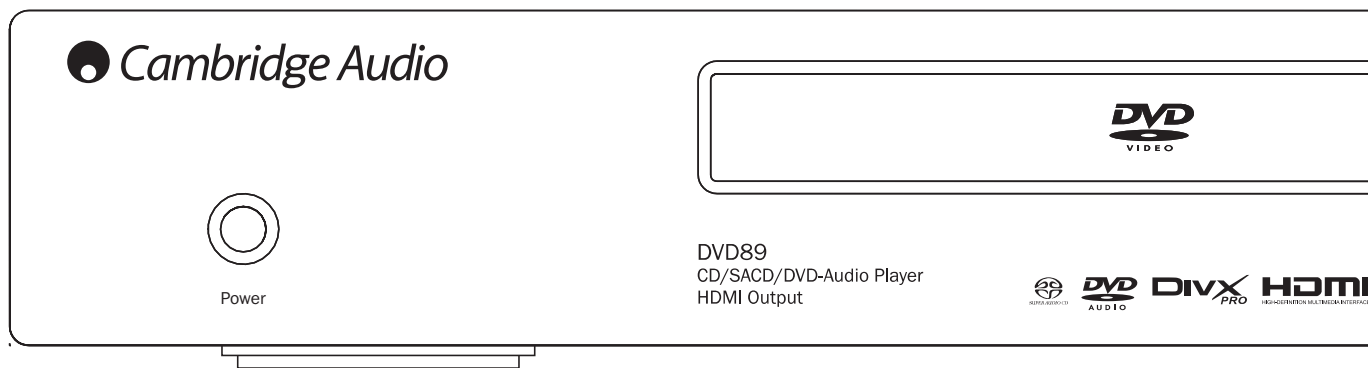

© 2007 Cambridge Audio Ltd

## Free Manuals Download Website

<http://myh66.com>

<http://usermanuals.us>

<http://www.somanuals.com>

<http://www.4manuals.cc>

<http://www.manual-lib.com>

<http://www.404manual.com>

<http://www.luxmanual.com>

<http://aubethermostatmanual.com>

Golf course search by state

<http://golfingnear.com>

Email search by domain

<http://emailbydomain.com>

Auto manuals search

<http://auto.somanuals.com>

TV manuals search

<http://tv.somanuals.com>