

2E42-27/2E42-27R/2E43-27/2E43-27R

SmartSwitch 2200

User's Guide

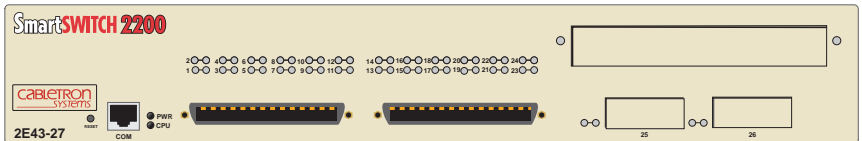

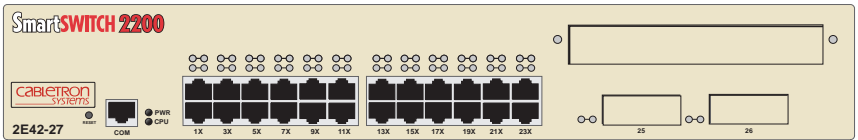

Only qualified personnel should perform installation procedures.

NOTICE

Cabletron Systems reserves the right to make changes in specifications and other information contained in this document without prior notice. The reader should in all cases consult Cabletron Systems to determine whether any such changes have been made.

The hardware, firmware, or software described in this manual is subject to change without notice.

IN NO EVENT SHALL CABLETRON SYSTEMS BE LIABLE FOR ANY INCIDENTAL, INDIRECT, SPECIAL, OR CONSEQUENTIAL DAMAGES WHATSOEVER (INCLUDING BUT NOT LIMITED TO LOST PROFITS) ARISING OUT OF OR RELATED TO THIS MANUAL OR THE INFORMATION CONTAINED IN IT, EVEN IF CABLETRON SYSTEMS HAS BEEN ADVISED OF, KNOWN, OR SHOULD HAVE KNOWN, THE POSSIBILITY OF SUCH DAMAGES.

© 1998 by Cabletron Systems, Inc., P.O. Box 5005, Rochester, NH 03866-5005
All Rights Reserved
Printed in the United States of America

Order Number: 9031960-05 September 1998

Cabletron Systems, SPECTRUM, LANVIEW, QuickSET, and SecureFast are registered trademarks and **SmartSwitch** is a trademark of Cabletron Systems, Inc.

All other product names mentioned in this manual may be trademarks or registered trademarks of their respective companies.

FCC NOTICE

This device complies with Part 15 of the FCC rules. Operation is subject to the following two conditions: (1) this device may not cause harmful interference, and (2) this device must accept any interference received, including interference that may cause undesired operation.

NOTE: This equipment has been tested and found to comply with the limits for a Class A digital device, pursuant to Part 15 of the FCC rules. These limits are designed to provide reasonable protection against harmful interference when the equipment is operated in a commercial environment. This equipment uses, generates, and can radiate radio frequency energy and if not installed in accordance with the operator's manual, may cause harmful interference to radio communications. Operation of this equipment in a residential area is likely to cause interference in which case the user will be required to correct the interference at his own expense.

WARNING: Changes or modifications made to this device which are not expressly approved by the party responsible for compliance could void the user's authority to operate the equipment.

Printed on  Recycled Paper

INDUSTRY CANADA NOTICE

This digital apparatus does not exceed the Class A limits for radio noise emissions from digital apparatus set out in the Radio Interference Regulations of the Canadian Department of Communications.

Le présent appareil numérique n'émet pas de bruits radioélectriques dépassant les limites applicables aux appareils numériques de la class A prescrites dans le Règlement sur le brouillage radioélectrique édicté par le ministère des Communications du Canada.

VCCI NOTICE

This is a Class A product based on the standard of the Voluntary Control Council for Interference by Information Technology Equipment (VCCI). If this equipment is used in a domestic environment, radio disturbance may arise. When such trouble occurs, the user may be required to take corrective actions.

この装置は、情報処理装置等電波障害自主規制協議会（VCCI）の基準に基づくクラスA情報技術装置です。この装置を家庭環境で使用すると電波妨害を引き起こすことがあります。この場合には使用者が適切な対策を講ずるよう要求されることがあります。

CABLETRON SYSTEMS, INC. PROGRAM LICENSE AGREEMENT

IMPORTANT: Before utilizing this product, carefully read this License Agreement.

This document is an agreement between you, the end user, and Cabletron Systems, Inc. ("Cabletron") that sets forth your rights and obligations with respect to the Cabletron software program (the "Program") contained in this package. The Program may be contained in firmware, chips or other media. BY UTILIZING THE ENCLOSED PRODUCT, YOU ARE AGREEING TO BECOME BOUND BY THE TERMS OF THIS AGREEMENT, WHICH INCLUDES THE LICENSE AND THE LIMITATION OF WARRANTY AND DISCLAIMER OF LIABILITY. IF YOU DO NOT AGREE TO THE TERMS OF THIS AGREEMENT, PROMPTLY RETURN THE UNUSED PRODUCT TO THE PLACE OF PURCHASE FOR A FULL REFUND.

CABLETRON SOFTWARE PROGRAM LICENSE

1. **LICENSE.** You have the right to use only the one (1) copy of the Program provided in this package subject to the terms and conditions of this License Agreement.

You may not copy, reproduce or transmit any part of the Program except as permitted by the Copyright Act of the United States or as authorized in writing by Cabletron.
2. **OTHER RESTRICTIONS.** You may not reverse engineer, decompile, or disassemble the Program.
3. **APPLICABLE LAW.** This License Agreement shall be interpreted and governed under the laws and in the state and federal courts of New Hampshire. You accept the personal jurisdiction and venue of the New Hampshire courts.

EXCLUSION OF WARRANTY AND DISCLAIMER OF LIABILITY

1. **EXCLUSION OF WARRANTY.** Except as may be specifically provided by Cabletron in writing, Cabletron makes no warranty, expressed or implied, concerning the Program (including its documentation and media).

CABLETRON DISCLAIMS ALL WARRANTIES, OTHER THAN THOSE SUPPLIED TO YOU BY CABLETRON IN WRITING, EITHER EXPRESSED OR IMPLIED, INCLUDING BUT NOT LIMITED TO IMPLIED WARRANTIES OF MERCHANTABILITY AND FITNESS FOR A PARTICULAR PURPOSE, WITH RESPECT TO THE PROGRAM, THE ACCOMPANYING WRITTEN MATERIALS, AND ANY ACCOMPANYING HARDWARE.

2. **NO LIABILITY FOR CONSEQUENTIAL DAMAGES.** IN NO EVENT SHALL CABLETRON OR ITS SUPPLIERS BE LIABLE FOR ANY DAMAGES WHATSOEVER (INCLUDING, WITHOUT LIMITATION, DAMAGES FOR LOSS OF BUSINESS, PROFITS, BUSINESS INTERRUPTION, LOSS OF BUSINESS INFORMATION, SPECIAL, INCIDENTAL, CONSEQUENTIAL, OR RELIANCE DAMAGES, OR OTHER LOSS) ARISING OUT OF THE USE OR INABILITY TO USE THIS CABLETRON PRODUCT, EVEN IF CABLETRON HAS BEEN ADVISED OF THE POSSIBILITY OF SUCH DAMAGES. BECAUSE SOME STATES DO NOT ALLOW THE EXCLUSION OR LIMITATION OF LIABILITY FOR CONSEQUENTIAL OR INCIDENTAL DAMAGES, OR ON THE DURATION OR LIMITATION OF IMPLIED WARRANTIES, IN SOME INSTANCES THE ABOVE LIMITATIONS AND EXCLUSIONS MAY NOT APPLY TO YOU.

UNITED STATES GOVERNMENT RESTRICTED RIGHTS

The enclosed product (a) was developed solely at private expense; (b) contains “restricted computer software” submitted with restricted rights in accordance with Section 52227-19 (a) through (d) of the Commercial Computer Software - Restricted Rights Clause and its successors, and (c) in all respects is proprietary data belonging to Cabletron and/or its suppliers.

For Department of Defense units, the product is licensed with “Restricted Rights” as defined in the DoD Supplement to the Federal Acquisition Regulations, Section 52.227-7013 (c) (1) (ii) and its successors, and use, duplication, disclosure by the Government is subject to restrictions as set forth in subparagraph (c) (1) (ii) of the Rights in Technical Data and Computer Software clause at 252.227-7013. Cabletron Systems, Inc., 35 Industrial Way, Rochester, New Hampshire 03867-0505.

SAFETY INFORMATION

CLASS 1 LASER TRANSCEIVERS

THE FE-100F3 FAST ETHERNET INTERFACE MODULE, FPIM-05 AND FPIM-07 FDDI PORT INTERFACE MODULES, AND APIM-29 ATM PORT INTERFACE MODULE USE CLASS 1 LASER TRANSCEIVERS. READ THE FOLLOWING SAFETY INFORMATION BEFORE INSTALLING OR OPERATING THESE MODULES.

The Class 1 laser transceivers use an optical feedback loop to maintain Class 1 operation limits. This control loop eliminates the need for maintenance checks or adjustments. The output is factory set, and does not allow any user adjustment. Class 1 Laser transceivers comply with the following safety standards:

- 21 CFR 1040.10 and 1040.11 U.S. Department of Health and Human Services (FDA).
- IEC Publication 825 (International Electrotechnical Commission).
- CENELEC EN 60825 (European Committee for Electrotechnical Standardization).

When operating within their performance limitations, laser transceiver output meets the Class 1 accessible emission limit of all three standards. Class 1 levels of laser radiation are not considered hazardous.

SAFETY INFORMATION

CLASS 1 LASER TRANSCEIVERS

LASER RADIATION AND CONNECTORS

When the connector is in place, all laser radiation remains within the fiber. The maximum amount of radiant power exiting the fiber (under normal conditions) is -12.6 dBm or 55×10^{-6} watts.

Removing the optical connector from the transceiver allows laser radiation to emit directly from the optical port. The maximum radiance from the optical port (under worst case conditions) is 0.8 W cm^{-2} or $8 \times 10^3 \text{ W m}^{-2} \text{ sr}^{-1}$.

Do not use optical instruments to view the laser output. The use of optical instruments to view laser output increases eye hazard. When viewing the output optical port, power must be removed from the network adapter.

DECLARATION OF CONFORMITY

Application of Council Directive(s): **89/336/EEC
73/23/EEC**

Manufacturer's Name: **Cabletron Systems, Inc.**

Manufacturer's Address: **35 Industrial Way
PO Box 5005
Rochester, NH 03867**

European Representative Name: **Mr. J. Solari**

European Representative Address: **Cabletron Systems Limited
Nexus House, Newbury Business Park
London Road, Newbury
Berkshire RG13 2PZ, England**

Conformance to Directive(s)/Product Standards: **EC Directive 89/336/EEC
EC Directive 73/23/EEC
EN 55022
EN 50082-1
EN 60950**

Equipment Type/Environment: **Networking Equipment, for use in a
Commercial or Light Industrial
Environment.**

We the undersigned, hereby declare, under our sole responsibility, that the equipment packaged with this notice conforms to the above directives.

Manufacturer

Mr. Ronald Fotino

Full Name

Principal Compliance Engineer

Title

Rochester, NH, USA

Location

Legal Representative in Europe

Mr. J. Solari

Full Name

Managing Director - E.M.E.A.

Title

Newbury, Berkshire, England

Location

CONTENTS

CHAPTER 1 INTRODUCTION

1.1	Using This Guide	1-1
1.2	Structure of This Guide.....	1-1
1.3	2E4X-27 Features	1-2
1.4	2E4X-27 Overview.....	1-4
1.4.1	Connectivity	1-4
1.4.2	Full Duplex Switched Ethernet.....	1-5
1.4.3	SmartTrunk	1-5
1.4.4	Runtime IP Address Discovery	1-6
1.4.5	Management	1-6
1.4.6	Switching Options	1-7
1.4.7	Standards Compatibility.....	1-7
1.4.8	Year 2000 Compliant	1-7
1.4.9	LANVIEW Diagnostic LEDs	1-7
1.4.10	Optional Features	1-8
1.5	Document Conventions	1-9
1.6	Getting Help.....	1-10
1.7	Related Manuals.....	1-11

CHAPTER 2 NETWORK REQUIREMENTS

2.1	SmartTrunk.....	2-1
2.2	10BASE-T Network	2-1
2.3	100BASE-TX Network	2-2
2.4	100BASE-FX Fiber Optic Network	2-2

CHAPTER 3 INSTALLATION

3.1	Unpacking the 2E4X-27.....	3-2
3.2	Installing Options	3-2
3.3	Installing the 2E4X-27	3-3
3.3.1	Tabletop or Shelf Installation	3-3
3.3.2	Rackmount Installation	3-4
3.3.3	Connecting Power to the 2E42-27 or 2E43-27	3-7
3.3.4	Connecting Power to the 2E42-27R or 2E43-27R	3-8

Contents

3.4	Connecting to the Network.....	3-9
3.4.1	Connecting UTP Cables to Ports 1 Through 24.....	3-9
3.4.1.1	2E42-27 or 2E42-27R Cable Connections....	3-10
3.4.1.2	2E43-27 or 2E43-27R Cable Connections....	3-11
3.4.2	Connecting a UTP Segment to the FE-100TX	3-13
3.4.3	Connecting a Fiber Optic Segment to the FE-100FX and FE-100F3	3-15
3.5	Completing the Installation.....	3-17

CHAPTER 4 TROUBLESHOOTING

4.1	Using LANVIEW.....	4-1
4.2	FE-100TX LED.....	4-4
4.3	Troubleshooting Checklist.....	4-6
4.4	Using the RESET Button	4-7

CHAPTER 5 LOCAL MANAGEMENT

5.1	Overview	5-1
5.2	Local Management Keyboard Conventions	5-2
5.3	Management Terminal Setup.....	5-3
5.3.1	Console Cable Connection.....	5-4
5.3.2	Management Terminal Setup Parameters	5-5
5.3.3	Monitoring an Uninterruptible Power Supply	5-6
5.4	Accessing Local Management	5-7
5.4.1	Navigating Local Management Screens.....	5-8
5.4.2	Selecting Local Management Menu Screen Items.....	5-10
5.4.3	Exiting Local Management Screens.....	5-10
5.5	Device Menu Screen.....	5-12
5.6	Device Configuration Menu Screen	5-14
5.7	General Configuration Screen	5-16
5.7.1	Setting the IP Address.....	5-19
5.7.2	Setting the Subnet Mask	5-20
5.7.3	Setting the Default Gateway.....	5-21
5.7.4	Setting the TFTP Gateway IP Address	5-22
5.7.5	Setting the Device Date.....	5-23
5.7.6	Setting the Device Time	5-23
5.7.7	Entering a New Screen Refresh Time.....	5-24
5.7.8	Setting the Screen Lockout Time	5-24
5.7.9	Setting the Operational Mode.....	5-25
5.7.10	Configuring the COM Port	5-26
5.7.10.1	Changing the Com Port Application.....	5-28
5.7.11	Clearing NVRAM	5-29
5.7.12	Enabling/Disabling IP Fragmentation	5-30

5.8	SNMP Community Names Screen	5-31
5.8.1	Establishing Community Names.....	5-32
5.9	SNMP Traps Screen.....	5-34
5.9.1	Configuring the Trap Table	5-35
5.10	Switch Configuration Screen	5-36
5.10.1	Setting the STA.....	5-38
5.10.2	Setting the Age Time Field	5-38
5.10.3	Setting (Enabling or Disabling) the Port Status	5-38
5.11	Ethernet Full Duplex Configuration Screen	5-39
5.11.1	Setting the Operation Mode.....	5-41
5.12	Device Specific Configuration Menu Screen	5-42
5.13	System Resources Screen	5-44
5.13.1	Setting the Reset Peak Switch Utilization.....	5-46
5.14	High Speed Interface Configuration Menu Screen.....	5-46
5.15	High Speed Interface Configuration Screen.....	5-48
5.15.1	Configuring an FE-100FX or FE-100F3 in Port 25 or 26	5-51
5.15.2	Setting the FE-100FX or FE-100F3 Operational Mode	5-51
5.15.3	Configuring an FE-100TX in Port 25 or 26	5-51
5.15.4	Setting the FE-100TX Operational Mode.....	5-51
5.15.5	Setting the FE-100TX Advertised Ability.....	5-52
5.16	Flash Download Screen	5-53
5.16.1	Image File Download Using BootP	5-55
5.16.2	Image File Download Using TFTP	5-55
5.16.3	Image File Download Using Runtime	5-56
5.17	Port Redirect Function Screen	5-58
5.17.1	Displaying the Source and Destination Entries.....	5-60
5.17.2	Changing Source and Destination Ports.....	5-60
5.18	Broadcast Suppression Screen	5-61
5.18.1	Setting the Threshold.....	5-63
5.18.2	Setting the Reset Peak	5-63
5.19	Device Statistics Menu Screen.....	5-64
5.20	Switch Statistics Screen	5-66
5.21	Interface Statistics Screen.....	5-67
5.21.1	Displaying Interface Statistics.....	5-71
5.21.2	Using the Clear Counters Command.....	5-71
5.22	RMON Statistics Screen.....	5-72
5.22.1	Displaying RMON Statistics.....	5-75
5.22.2	Using the Clear Counters Command.....	5-76
5.23	Network Tools.....	5-76
5.23.1	Built-in Commands	5-79
5.23.2	Special Commands.....	5-88

Contents

APPENDIX A SPECIFICATIONS

A.1	Device Specifications.....	A-1
A.2	Physical Properties	A-1
A.3	Electrical Specifications	A-1
A.4	Environmental Requirements.....	A-2
A.5	Input/Output Ports.....	A-2
A.6	COM Port/Pin Assignments	A-3
A.7	Regulatory Compliance.....	A-3

APPENDIX B FE-100TX, FE-100FX, AND FE-100F3 SPECIFICATIONS

B.1	FE-100TX.....	B-1
B.2	FE-100FX.....	B-2
B.3	FE-100F3	B-3

APPENDIX C OPTIONAL INSTALLATIONS AND MODE SWITCH BANK SETTINGS

C.1	Required Tools.....	C-2
C.2	Removing the Chassis Cover	C-2
	C.2.1 Setting the Mode Switch	C-4
C.3	Installing Optional Fast Ethernet Interface Modules	C-7

INDEX

CHAPTER 1

INTRODUCTION

Welcome to the **2E42-27/2E42-27R/2E43-27/2E43-27R SmartSwitch 2200 User's Guide**. This guide describes the 2E42-27, 2E42-27R, 2E43-27, and 2E43-27R SmartSwitch 2200 devices and provides information concerning network requirements, installation, troubleshooting, and the use of Local Management.

1.1 USING THIS GUIDE

Read through this guide completely to understand the 2E42-27, 2E42-27R, 2E43-27, and 2E43-27R features, capabilities, and Local Management functions. A general working knowledge of Ethernet and IEEE 802.3 type data communications networks and their physical layer components is helpful when using this device.



Unless noted differently, the information in this guide applies to all four of the SmartSwitch 2200 devices, which are referred to as either "2E4X-27" or "device."

1.2 STRUCTURE OF THIS GUIDE

This guide is organized as follows:

Chapter 1, Introduction, outlines the contents of this manual and briefly describes the 2E4X-27 features. Directions about how to obtain additional help and a list of related manuals are also included.

Chapter 2, Network Requirements, explains the network requirements to consider before installing the 2E4X-27.

Chapter 3, Installation, provides instructions on how to install the 2E4X-27 and connect segments to the device.

Chapter 4, Troubleshooting, describes the function of the LANVIEW LEDs, which can help to quickly diagnose network/operational problems.

Chapter 5, Local Management, describes how to access Local Management and use the Local Management screens to manage the 2E4X-27.

Appendix A, **Specifications**, contains information on functionality and operating specifications, connector pinouts, environmental requirements, and physical properties.

Appendix B, **FE-100TX, FE-100FX, and FE-100F3 Specifications**, contains information about FE-100TX pinouts and information concerning cable types used with the FE-100FX and FE-100F3.

Appendix C, **Optional Installations and Mode Switch Bank Settings**, describes how to install optional Fast Ethernet Interface Modules and how to set the Mode Switch.

1.3 2E4X-27 FEATURES

Figure 1-1 shows the 2E42-27 and 2E43-27. Following the figure is a list of the features.

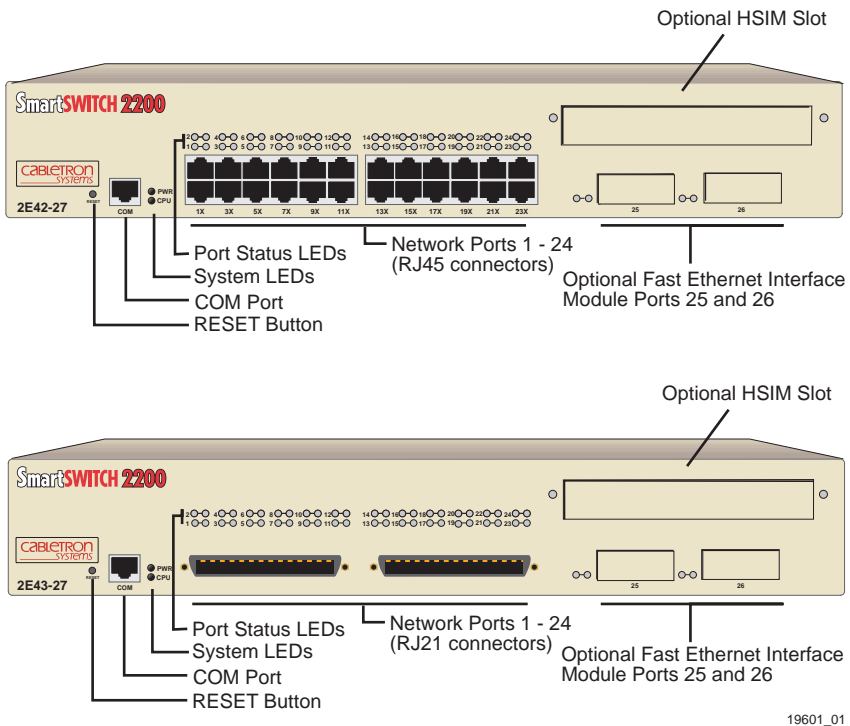

Figure 1-1 The 2E42-27 and 2E43-27

- A 24-port high-speed workgroup switch with two optional ports for Fast Ethernet Interface Modules providing high speed uplinks to 100 Mbps Fast Ethernet technologies and one optional port for a High Speed Interface Module (HSIM). The HSIM provides additional connectivity to various networking technologies.
- Full Duplex Switched Ethernet (FDSE) support for 20 Mbps or 200 Mbps Fast Ethernet links to bandwidth intensive users/servers.
- SmartTrunk, which allows the user to logically group interfaces on the 2E4X-27 via Local Management to provide a higher aggregate bandwidth between Cabletron Systems devices that support the SmartTrunk feature.
- Runtime IP Address Discovery, which allows the 2E4X-27 to send out Reverse Address Resolution (RARP) and Bootstrap Protocol (BootP) requests to determine its Internet Protocol (IP) address.
- Manageable using Simple Network Management Protocol (SNMP) and Remote Monitoring (RMON).
- Support for traditional switching services and with the proper software, Cabletron Systems SecureFast Switching Virtual Network technology.
- Ability to link existing stackable or third party hubs to 100 Mbps Fast Ethernet backbones.
- IEEE 802.3 compatibility with support for IEEE 802.1D and DEC Spanning Tree Algorithms.
- LANVIEW Diagnostic LEDs.
- Available with two power supplies (2E42-27R and 2E43-27R only).

1.4 2E4X-27 OVERVIEW

The 2E4X-27 is a 27-port high-speed network switching device that supports traditional switching (bridging) and Cabletron Systems SecureFast Switching Virtual Network technology. Ports 25 and 26 support optional Fast Ethernet Interface Modules and can provide uplinks to 100BASE-TX or 100BASE-FX Fast Ethernet networks. Port 27 supports an optional High Speed Interface Module (HSIM) that provides additional connectivity to various networking technologies such as Asynchronous Transfer Mode (ATM) and Fiber Distribution Data Interface (FDDI).

The 2E4X-27 is used to connect individual high-bandwidth user devices, such as workstations, and provides a central switching point for multiple Ethernet segments built using devices such as Cabletron Systems HubSTACK or other third party stackable devices.

The 2E4X-27 is a tabletop unit that can be installed in a standard 19-inch rack using the supplied rack mounting hardware.

The 2E42-27 and 2E43-27 have one universal ac power supply with automatic voltage sensing that allows operation using 100–125 or 200–240 Vac, 50/60 Hz.

The 2E42-27R and 2E43-27R have two power supplies. The power supplies load share 50% (+/-5%) of the power required by the device. If one power supply fails, the remaining power supply assumes the entire load of the device without interruption to network traffic. Each power supply module supports its own ac input connection, which allows the user to connect each power supply to a different ac power circuit.

1.4.1 Connectivity

Connectivity for ports 1 through 24 is different for the 2E42-27/2E42-27R and the 2E43-27/2E43-27R.

The 2E42-27/2E42-27R connects to Ethernet networks or workstations through 24 RJ45 ports on the front panel. These ports support Unshielded Twisted Pair (UTP) and Shielded Twisted Pair (STP) cables at lengths up to 100 meters. The ports are IEEE 802.3 10BASE-T compliant.

The 2E43-27/2E43-27R connects to Ethernet networks or workstations through two 50-pin RJ21 connectors. Each connector is wired for 12 ports.

All of the devices have two front panel slots (ports 25 and 26) for optional Fast Ethernet Interface Modules to support an uplink to 100 Mbps Fast Ethernet backbones or a high speed connection to a local server. There is also space for an optional HSIM to provide additional connectivity to various networking technologies.

1.4.2 Full Duplex Switched Ethernet

Each switched Ethernet port supports full wire-speed Ethernet communications and can be configured to operate in Full Duplex Switched Ethernet (FDSE) mode. FDSE allows each port to provide a dedicated 20 Mbps bandwidth for file server or high-end workstation connections. The Fast Ethernet ports provide up to 200 Mbps of bandwidth.

1.4.3 SmartTrunk

SmartTrunk, also referred to as SmartTrunking, is Cabletron Systems' terminology for load balancing or load sharing. SmartTrunk technology provides an easy-to-implement mechanism to group, or aggregate, multiple physical links together to scale the backbone bandwidth beyond the limitations of a single link. All links are user-configurable so administrators can scale the backbone bandwidth by adding SmartTrunk links. The SmartTrunk benefits are as follows:

- All purchased bandwidth is used.
- Distributed, resilient links increase reliability and performance.
- Multiple technologies are supported within a single trunk for maximum flexibility.

For more information about SmartTrunk, refer to the Cabletron Systems *SmartTrunk User's Guide*.

1.4.4 Runtime IP Address Discovery

This feature enables the 2E42-27 to automatically accept an IP address from a Boot Strap Protocol (BootP) server on the network into NVRAM without requiring a user to enter an IP address through Local Management.

When the 2E42-27 is connected to the network and powered up, Runtime IP Address Discovery (RAD) checks the 2E42-27 for an IP address. If one has not yet been assigned (2E42-27 IP address set to 0.0.0.0), RAD checks to see if any of the 2E42-27 interfaces have a link. If so, RAD sends out Reverse Address Resolution Protocol (RARP) and BootP requests to obtain an IP address from a BootP server on the network.

The RAD requests start out at an interval of 1 second. The interval then doubles after every transmission until an interval of 300 seconds is reached. At this point, the interval remains at 300 seconds. The RAD requests continue until an IP address is received from a BootP server, or an IP address is entered using Local Management.

1.4.5 Management

Management of the 2E4X-27 is accomplished using SNMP compliant management tools for in-band management. Out-of-band Local Management is provided through the RJ45 COM port on the front panel using a VT100 terminal or a VT100 terminal emulator. In-band remote management is possible through any SNMP compliant Network Management Software.

Local Management provides the ability to manage the 2E4X-27 and any of the optional Fast Ethernet Interface Modules installed in ports 15 and 16 and the optional High Speed Interface Module (HSIM).

The associated High Speed Interface Module user's guide provides detailed information about Local Management of the HSIM.

Information about how to access and use Local Management is contained in [Chapter 5](#).

1.4.6 Switching Options

The 2E4X-27 provides 802.1D Switching, 802.1Q switching or SecureFast Switching Virtual Network Services between all of the front panel interfaces including any installed Fast Ethernet Interface Modules and HSIM.

802.1Q switching and SecureFast switching allow for future migration to Virtual Network technologies without requiring the replacement of existing equipment.

1.4.7 Standards Compatibility

The 2E4X-27 provides IEEE 802.1D Spanning Tree Algorithm (STA) support to enhance the overall reliability of the network and protect against “loop” conditions. The 2E4X-27 supports a wide variety of industry standard MIBs including RFC 1213 (MIB II), RFC 1757 (RMON), RFC 1371 (RS232 MIB), RFC 1493 (Bridge MIB) and RFC 1354 (FIB MIB). A full suite of Cabletron Systems Enterprise MIBs provide a wide array of statistical information to enhance troubleshooting.

1.4.8 Year 2000 Compliant

The 2E4X-27 has an internal clock that can maintain the current time and date beyond the year 1999.

1.4.9 LANVIEW Diagnostic LEDs

LANVIEW diagnostic LEDs serve as an important troubleshooting aid by providing an easy way to observe the status of individual ports and overall network operations. [Chapter 4](#) provides details about the 2E4X-27 LANVIEW LEDs.

1.4.10 Optional Features

Options for the 2E4X-27 include Fast Ethernet Interface Modules and High Speed Interface Modules to add additional interface capability.

Cabletron Systems provides Fast Ethernet Interface Modules to support uplinks to 100 Mbps Ethernet backbones or high speed connections to local servers. The Fast Ethernet Interface Modules are listed in [Table 1-1](#).

Table 1-1 Fast Ethernet Interface Modules

P/N	Description	Application
FE-100TX	Uses RJ45 connector	Supports Category 5 Unshielded Twisted Pair (UTP) cabling, which has an impedance of 85 to 111 ohms, and Shielded Twisted Pair (STP) cabling.
FE-100FX	Uses SC connector	Supports multimode fiber optic cabling.
FE-100F3	Uses SC connector	Supports single mode fiber optic cabling.

High Speed Interface Modules (HSIMs) are available from Cabletron Systems for additional connectivity to various networking technologies. The HSIMs available for the 2E4X-27 are listed in the Release Notes.

1.5 DOCUMENT CONVENTIONS

The following conventions are used throughout this document:

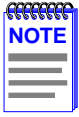

Note symbol. Calls the reader's attention to any item of information that may be of special importance.



Tip symbol. Conveys helpful hints concerning procedures or actions.



Caution symbol. Contains information essential to avoid damage to the equipment.



Electrical Hazard Warning symbol. Warns against an action that could result in personal injury or death due to an electrical hazard.



Warning symbol. Warns against an action that could result in personal injury or death.

1.6 GETTING HELP

For additional support related to this device or document, contact the Cabletron Systems Global Call Center:

World Wide Web	http://www.cabletron.com/
Phone	(603) 332-9400
Internet mail	support@cabletron.com
FTP	ftp://ftp.cabletron.com
Login	<i>anonymous</i>
Password	<i>your email address</i>
To send comments or suggestions concerning this document, contact the Cabletron Systems Technical Writing Department via the following email address: TechWriting@cabletron.com <i>Make sure to include the document Part Number in the email message.</i>	

Before calling the Cabletron Systems Global Call Center, have the following information ready:

- Your Cabletron Systems service contract number
- A description of the failure
- A description of any action(s) already taken to resolve the problem (e.g., changing mode switches, rebooting the unit, etc.)
- The serial and revision numbers of all involved Cabletron Systems products in the network
- A description of your network environment (layout, cable type, etc.)
- Network load and frame size at the time of trouble (if known)
- The device history (i.e., have you returned the device before, is this a recurring problem, etc.)
- Any previous Return Material Authorization (RMA) numbers

1.7 RELATED MANUALS

The following manuals may help to set up, control, and manage the 2E4X-27:

Cabletron Systems *HSIM-A6DP User's Guide*

Cabletron Systems *HSIM-F6 User's Guide*

Cabletron Systems *HSIM-FE6 User's Guide*

Cabletron Systems *HSIM-W87 User's Guide*

Cabletron Systems *HSIM-G01/G09 User's Guide*

Cabletron Systems *Ethernet Technology Guide*

Cabletron Systems *Cabling Guide*

Cabletron Systems *Port Based VLAN User's Guide*

Cabletron Systems *SmartTrunk User's Guide*

These manuals can be obtained from the World Wide Web in Adobe Acrobat Portable Document Format (PDF) at the following site:

<http://www.cabletron.com/>



All documentation for the Cabletron Systems SecureFast VLAN Manager software is contained on the VLAN Manager CD-ROM.

Documents for the Cabletron Systems HSIM-W6 and HSIM-W84 devices are contained on the QuickSET CD-ROM and are also available on the World Wide Web at:
<http://www.cabletron.com/>

CHAPTER 2

NETWORK REQUIREMENTS

Before installing the 2E4X-27 or Fast Ethernet Interface Module (FE-100TX, FE-100FX, or FE-100F3), review the requirements and specifications referred to in this chapter concerning the following:

- SmartTrunk (Section 2.1)
- 10BASE-T Twisted Pair Network (Section 2.2)
- 100BASE-TX Twisted Pair Network (Section 2.3)
- 100BASE-FX Fiber Optic Network (Section 2.4)

The network installation must meet the guidelines to ensure satisfactory performance of this equipment. Failure to follow the guidelines may produce poor network performance.



The Cabletron Systems *Cabling Guide* and *SmartTrunk User's Guide*, referred to in the following sections can be found on the Cabletron Systems World Wide Web site:
<http://www.cabletron.com/>

2.1 SmartTrunk

To connect the 2E4X-27 to a network so it can take advantage of the SmartTrunk feature, there are certain rules concerning port connections and configurations that must be followed for proper operation. Refer to the Cabletron Systems *SmartTrunk User's Guide* for additional information.

2.2 10BASE-T NETWORK

When connecting a 10BASE-T segment to any of the 2E4X-27 ports (Interfaces 1 through 24), ensure that the network meets the Ethernet network requirements of the IEEE 802.3 standard for 10BASE-T. Refer to the Cabletron Systems *Cabling Guide* for details.

2.3 100BASE-TX NETWORK

The 2E4X-27, with an FE-100TX installed in ports 25 and 26, provides an RJ45 connection that supports UTP cabling, which has an impedance of 85 to 111 ohms. The device at the other end of the twisted pair segment must meet IEEE 802.3u 100BASE-TX Fast Ethernet network requirements for the devices to operate at 100 Mbps. Refer to the Cabletron Systems *Cabling Guide* for details.

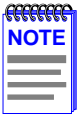

The 2E4X-27 with an FE-100TX installed is capable of operating at either 10 or 100 Mbps. The FE-100TX can automatically sense the speed of the other device and adjusts its speed accordingly.

2.4 100BASE-FX FIBER OPTIC NETWORK

Ports 25 and 26 of the 2E4X-27 support the Cabletron Systems FE-100FX and FE-100F3 fiber optic interface modules. The device at the other end of the fiber optic segment must meet the 100BASE-FX Fast Ethernet network requirements to operate at 100 Mbps. Refer to the Cabletron Systems *Cabling Guide* for details.

Multimode Mode Fiber Optic Cable Length

The maximum multimode fiber optic cable length of a 100BASE-FX segment is covered in the Cabletron Systems *Cabling Guide*.

Single Mode Fiber Cable Lengths

The maximum single mode fiber optic length of a 100BASE-FX segment may be no more than 5 km between Data Terminal Equipment (DTE to DTE) in half duplex mode or 20 km (DTE to DTE) in full duplex mode.

CHAPTER 3

INSTALLATION



Only qualified personnel should install the 2E4X-27.

This chapter provides all instructions required to install the 2E4X-27. A Phillips screwdriver is required to install the device. Follow the order of the sections listed below to correctly install the 2E4X-27.

- Unpacking the 2E4X-27 ([Section 3.1](#))
- Installing Options ([Section 3.2](#))
- Installing the 2E4X-27 (on a shelf or tabletop, or into a standard rack) ([Section 3.3](#))
- Connecting to the Network ([Section 3.4](#))
- Completing the Installation ([Section 3.5](#))

3.1 UNPACKING THE 2E4X-27

1. Open the box and remove the packing material protecting the 2E4X-27.
2. Verify the contents of the carton as listed in [Table 3-1](#).

Table 3-1 Contents of 2E4X-27 Carton

Item	Quantity
2E4X-27 or 2E4X-27R	1
Antistatic wrist strap	1
Console Cable Kit	1
RJ21 Angle Adapter (2E43-27/2E43-27R only)	2
Rackmount Kit	1
Strain-Relief Bracket	1
Release Notes	1
Power Cord (2E42-27 or 2E43-27 only)	1
Power Cord (2E42-27R or 2E43-27R only)	2

3. Remove the black and yellow tape seal on the non-conductive bag to remove the 2E4X-27.
4. Perform a visual inspection of the device for any signs of physical damage, and contact the Cabletron Systems Global Call Center if there are any signs of damage. Refer to [Section 1.6](#), Getting Help, for details.

3.2 INSTALLING OPTIONS



Install any optional equipment before proceeding to [Section 3.3](#).

If the 2E4X-27 is to be installed with an optional Fast Ethernet Interface Module, refer to [Appendix C](#) for installation instructions. The installation instructions for the HSIMs are in the associated user's guide.

3.3 INSTALLING THE 2E4X-27

The 2E4X-27 may be installed on a tabletop, shelf, or in a 19-inch rack. [Section 3.3.1](#) describes a tabletop or shelf installation and [Section 3.3.2](#) describes the rackmount installation.



To prevent possible personal injury and/or damage to the unit, do **NOT** connect power to the 2E4X-27 until instructed to do so.

3.3.1 Tabletop or Shelf Installation

The following two subsections provide guidelines for installation on a tabletop or shelf.

Guidelines for Tabletop and Shelf Installations

Tabletop and shelf installations must be within reach of the network cabling and meet the requirements listed below:

- Locate the 2E4X-27 within seven feet of an appropriately grounded power receptacle that meets the power supply requirements listed in [Appendix A](#).
- In a shelf installation, the shelf must support 13.6 kg (30 lb) of static weight for each 2E4X-27.
- Maintain a temperature of between 5°C (41°F) and 40°C (104°F) at the installation site with fluctuations of less than 10°C (18°F) per hour.
- Maintain a 2-inch clearance from the left, right, and rear sides of the device to provide adequate ventilation.

Installation

For a tabletop or shelf installation, locate the 2E4X-27 within seven feet of its power source and with an unrestricted free surface area as shown in [Figure 3-1](#). Proceed to [Section 3.3.3](#) for 2E42-27/ 2E43-27 power connection instructions and to [Section 3.3.4](#) for 2E42-27R/2E43-27R power connection instructions.



To ensure proper ventilation and prevent overheating, leave a minimum clearance space of 5.1 cm (2.0 in) at the left, right, and rear of the 2E4X-27.

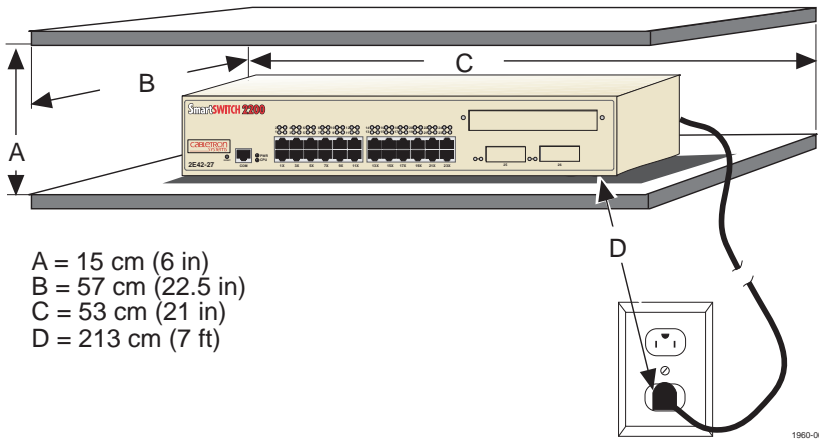

Figure 3-1 Tabletop or Shelf Installation

3.3.2 Rackmount Installation

To install the 2E4X-27 in a 19-inch rack, Cabletron Systems includes an accessory kit containing the rackmount brackets, mounting screws, and a strain-relief bracket for cable management.

Guidelines for the Rackmount Installation

The installation site must be within reach of the network cabling and meet the requirements listed below:

- An appropriate grounded power receptacle must be located within seven feet of the location.
- Maintain a temperature of between 5°C (41°F) and 40°C (104°F) at the installation site with fluctuations of less than 10°C (18°F) per hour.



To ensure proper ventilation and prevent overheating, leave a minimum clearance space of 5.1 cm (2.0 in) at the left, right, and rear of the 2E4X-27.



Before installing the 2E4X-27 into a rack, ensure that the rack supports the device(s) without compromising the stability of the rack. Otherwise, personal injury and/or equipment damage may result.

Installation

Rack mounting the 2E4X-27 involves the following:

- Attaching the strain-relief bracket
- Rack mounting the 2E4X-27 (attaching the mounting brackets and fastening the 2E4X-27 to the rack)

Attaching the Strain-Relief Bracket

Attach the strain-relief bracket to the front of the 2E4X-27 as follows:

1. Locate the strain-relief bracket and four 8-32 x 3/8-inch pan-head screws in the rackmount kit.



Do not attempt to attach the strain-relief bracket with screws other than the 8-32 x 3/8-inch screws included with the 2E4X-27. Use of longer screws may damage the unit or cause electrical shock.

2. Attach the strain-relief bracket to the bottom of the 2E4X-27 using the four 8-32 x 3/8-inch pan-head screws (Figure 3-2).

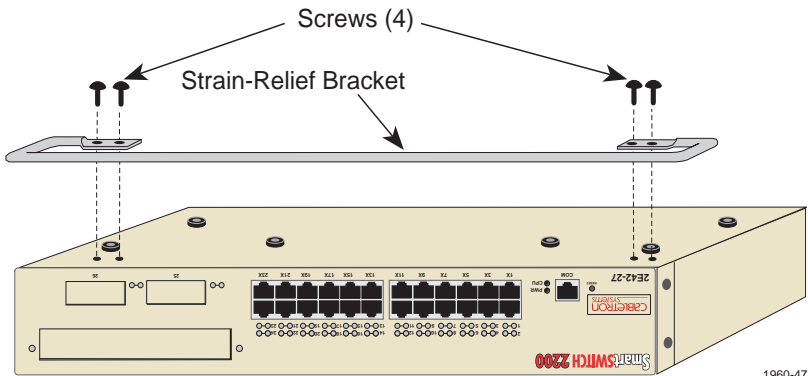

1960-47

Figure 3-2 Attaching the Strain-Relief Bracket

Rack Mounting the 2E4X-27

Proceed as follows to install the 2E4X-27 into a 19-inch rack.

1. Remove and discard the four cover screws (two from each side) located along the front edges of each side of the 2E4X-27.
2. Locate the four 6-32 x 3/8-inch flathead cover replacement screws in the rackmount kit. Use these screws to attach the rackmount brackets to the 2E4X-27 as shown in [Figure 3-3](#).

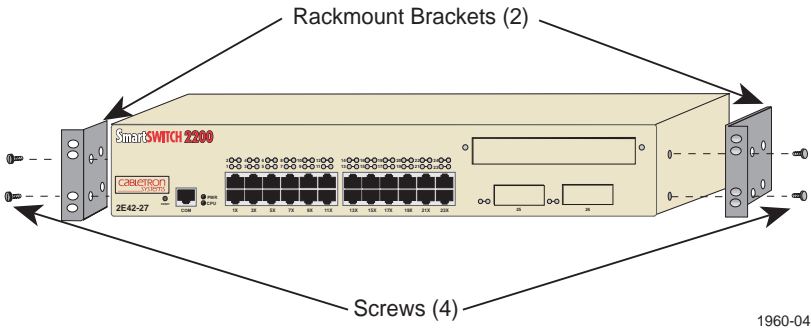

Figure 3-3 Installing the Rackmount Brackets

3. With the mounting brackets installed, position the 2E4X-27 between the vertical frame members of the 19-inch rack and fasten it securely with mounting screws as shown in [Figure 3-4](#).

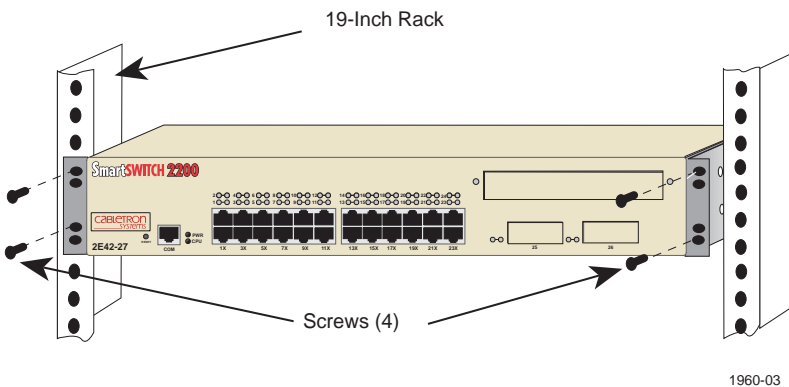

Figure 3-4 Installing the 2E4X-27 in a Rack

3.3.3 Connecting Power to the 2E42-27 or 2E43-27



The 2E42-27 and 2E43-27 have a power supply with automatic voltage sensing that allows connection to power sources ranging from 100–125 Vac or 200–250 Vac, 50/60 Hz.

To connect the 2E42-27 or 2E43-27 to a power source, proceed as follows:

1. Plug the power cord into a grounded wall outlet. The POWER LED turns ON (green) and the CPU LED turns ON (green) briefly.

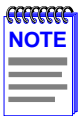

It takes approximately one minute for the 2E42-27 or 2E43-27 to boot up.

2. Observe the LANVIEW LEDs. After a successful boot, the CPU LED turns ON (green). If the CPU LED is not green after one minute, check the power cord connection and power source. If the CPU LED is still not green, contact Cabletron Systems Global Call Center. Refer to [Section 1.6](#) for details.

3.3.4 Connecting Power to the 2E42-27R or 2E43-27R

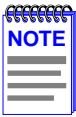

The 2E42-27R and 2E43-27R have two power supplies with automatic voltage sensing that allows connection to power sources ranging from 100–125 Vac or 200–250 Vac, 50/60 Hz.

To connect the 2E42-27R or 2E43-27R to the power sources, proceed as follows:

1. Plug each power cord into a grounded wall outlet, see [Figure 3-5](#). To take advantage of the load sharing and redundancy capabilities, each power cord must be plugged into a dedicated ac outlet. The POWER LED turns ON (green) and the CPU LED turns ON (green) briefly.

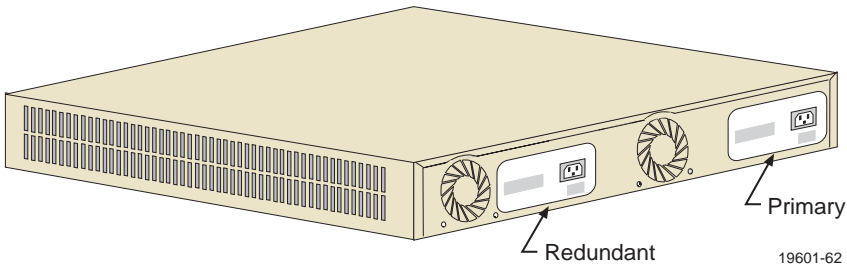
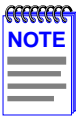

Figure 3-5 2E42-27R/2E43-27R Rear View



It takes approximately one minute for the 2E42-27R or 2E43-27R to boot up.

2. Observe the LANVIEW LEDs. After a successful boot, the CPU LED turns ON (green). If the CPU LED is not green after one minute and turns yellow, there is no power redundancy. Check the power cord connections and the power source. If there are no problems with the power cord connections or power source and the CPU LED is still not green, contact the Cabletron Systems Global Call Center. Refer to [Section 1.6](#) for details.

3.4 CONNECTING TO THE NETWORK

This section provides the procedures for connecting UTP and fiber optic segments from the network or other devices to the 2E4X-27.

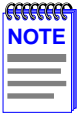

If the 2E4X-27 is being installed in a network using SmartTrunking, there are rules concerning the network cable and port configurations that must be followed for SmartTrunking to operate properly. Before connecting the cables, refer to the *SmartTrunk User's Guide* for the configuration information.

Ports 1 through 24 on the 2E42-27 and 2E42-27R have RJ45 connectors for UTP connections. Ports 1 through 24 on the 2E43-27 and 2E43-27R have two RJ21 connectors for UTP connections. On all of these devices, ports 25 and 26 support FE-100TX, FE-100FX, or FE-100F3 Fast Ethernet Interface Modules.

The FE-100TX has an RJ45 connector for a UTP cable connection. The FE-100FX and FE-100F3 have SC connectors for fiber optic cable connections.

Refer to [Section 3.4.1](#) to make UTP connections to ports 1 through 24.

Refer to [Section 3.4.2](#) to make a UTP connection to an FE-100TX in port slot 25 or 26.

Refer to [Section 3.4.3](#) to make a fiber optic cable connection to an FE-100FX or FE-100F3 in port slot 25 or 26.

Refer to the associated High Speed Interface Module user's guide to make connections to an optional High Speed Interface Module installed in the HSIM slot.

3.4.1 Connecting UTP Cables to Ports 1 Through 24

The 2E42-27 and 2E42-27R use 24 RJ45 connectors for the port 1 through 24 connections. The 2E43-27 and 2E42-27R use two RJ21 connectors for the port connections. Each of the cables connected to these two ports can have 12 twisted pairs.

3.4.1.1 2E42-27 or 2E42-27R Cable Connections

Ports 1 through 24 of the 2E42-27 or 2E42-27R are 10BASE-T ports with internal crossovers. When connecting a workstation, use a straight-through cable. When connecting networking devices, such as another bridge, repeater, or router, use a crossover cable.

To connect an RJ45 twisted pair segment, proceed as follows:

1. Ensure that the device connected to the other end of the segment is powered ON.
2. Connect the twisted pair segment to the 2E42-27 by inserting the RJ45 connector on the twisted pair segment into the desired RJ45 port (Ports 1 through 24) as shown in Figure 3-6.

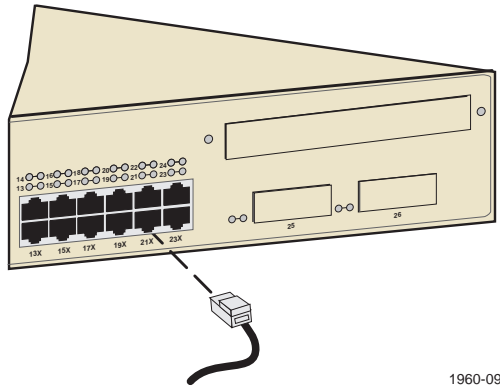

1960-09

Figure 3-6 2E42-27/2E42-27R Twisted Pair Connection

3. Verify that a link exists by checking that the port **RX** LED is ON (flashing yellow, blinking green, or solid green). If the **RX** LED is OFF and the **TX** LED is not blinking yellow, perform the following steps until it is on:
 - a. Verify that the 10BASE-T device at the other end of the twisted pair segment is ON and connected to the segment.

- b. Verify that the RJ45 connectors on the twisted pair segment have the proper pinouts (Figure 3-7) and check the cable for continuity.

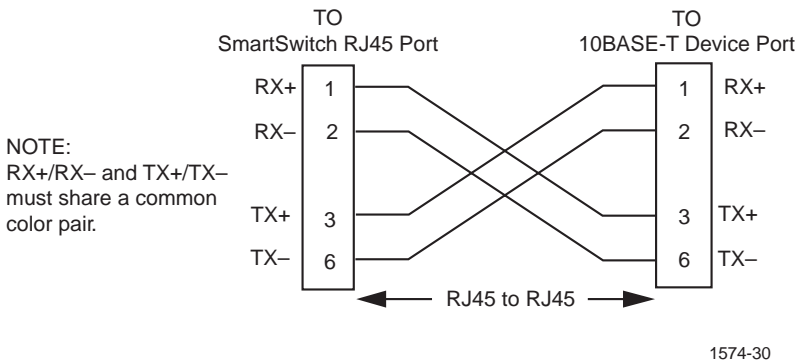

Figure 3-7 Cable Pinouts - (RJ45) Crossover Cable

- c. Check that the twisted pair connection meets the dB loss and cable specifications outlined in Chapter 2.

If a link is not established, contact the Cabletron Systems Global Call Center. Refer to Section 1.6 for details.

4. Repeat steps 1 through 3 above, until all connections have been made.

3.4.1.2 2E43-27 or 2E43-27R Cable Connections

When facing the front panel of a 2E43-27 or 2E43-27R, the left RJ21 is the connector for 10BASE-T ports 1 through 12. The right RJ21 is for the 10BASE-T ports 13 through 24 connections. All 24 ports have internal crossovers.

To connect an RJ21, proceed as follows:

1. Ensure that the device connected to the other end of the segment is powered ON.
2. If using an RJ21 straight connector, plug it into the appropriate RJ21 port as shown in **Figure 3-8** or, if using the RJ21 angle adapter supplied with the device, insert the RJ21 angle adapter as shown in **Figure 3-9**. The RJ21 angle adapter allows the cables to be dressed along the front of the device and easily attached to the strain-relief bracket when using an RJ21 right-angled connector.

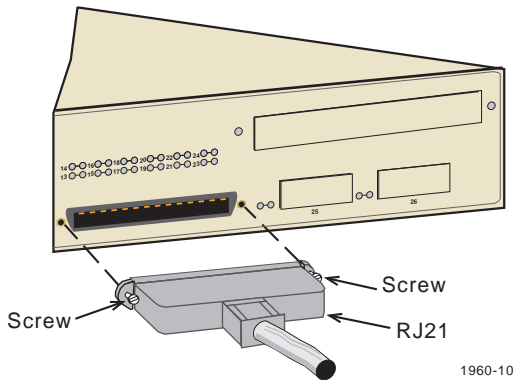

Figure 3-8 2E43-27 or 2E43-27R Straight Cable Connection

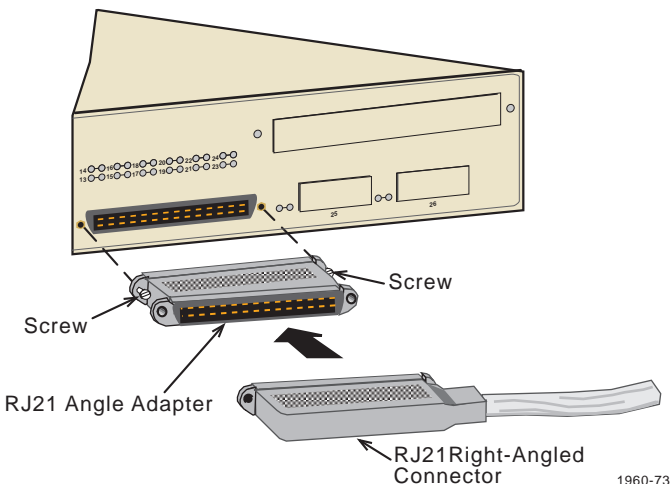

Figure 3-9 Connection Using the RJ21 Angle Adapter

3. Tighten the two screws on the RJ21 straight cable connector or RJ21 angle adapter, as applicable, to secure it to the device.



The cable pinouts for a 25-pair cable (RJ21) can be found in the Cabletron Systems *Cabling Guide*. Refer to [Section 1.7](#) for details on how to obtain this document.

4. If using the RJ21 angle adapter, plug the RJ21 right-angled connector as shown in [Figure 3-9](#).
5. Verify that a link exists by checking that the port **RX** LED is ON (flashing yellow, blinking green, or solid green). If the **RX** LED is OFF and the **TX** LED is not blinking yellow, perform the following steps until it is on:
 - a. Verify that the 10BASE-T device at the other end of the twisted pair segment is ON and connected to the segment.
 - b. Verify that the RJ45 connectors on the twisted pair segment have the proper pinouts and check the cable for continuity.
 - c. Check that the twisted pair connection meets the dB loss and cable specifications outlined in [Chapter 2](#).

If a link is not established, contact the Cabletron Systems Global Call Center. Refer to [Section 1.6](#) for details.

6. Repeat steps 1 through 5 above, until all connections have been made.

3.4.2 Connecting a UTP Segment to the FE-100TX



To ensure proper operation, use only Category 5 Unshielded Twisted Pair (UTP) cabling that has an impedance between 85 and 111 ohms.

An FE-100TX installed in port slot 25 and/or 26 has an internal crossover switch. When connecting a workstation, use a straight-through cable and set the Fast Ethernet Interface Module crossover switch shown in [Figure 3-10](#) to the crossed over position marked with X.

When connecting networking devices, such as another bridge, repeater, or router, use a straight-through cable and set the Fast Ethernet Interface Module crossover switch shown in [Figure 3-10](#) to the not crossed over position, marked with =.

A schematic of a crossover cable is shown in [Figure 3-7](#). If the wires do not cross over, use the switch on the FE-100TX to internally cross over the RJ45 port. [Figure 3-10](#) shows how to properly set the FE-100TX crossover switch.

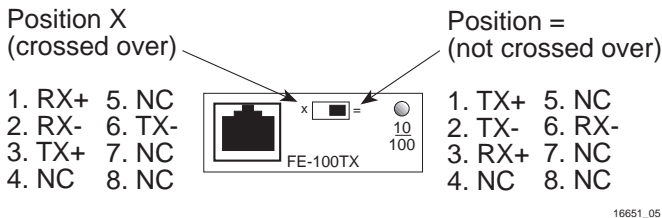

Figure 3-10 FE-100TX Crossover Switch

Connect an FE-100TX to a twisted pair segment as follows:

1. Ensure that the device connected to the other end of the segment is powered ON.
2. Connect the twisted pair segment to the module by inserting the RJ45 connector on the twisted pair segment into the RJ45 port on the module shown in [Figure 3-10](#).
3. Verify that a Link exists by checking that the port RX LED is ON (flashing yellow, blinking green, or solid green). If the RX LED is OFF and the TX LED is not blinking yellow, perform the following steps until it is on:
 - a. Verify that the 100BASE-TX device at the other end of the twisted pair segment is powered up.
 - b. Verify that the RJ45 connector on the twisted pair segment has the proper pinouts.
 - c. Check the cable for continuity.
 - d. Make sure that the twisted pair connection meets the cable specifications outlined in [Section 2.3](#).

- e. Confirm that the crossover switch is in the correct position.

If a link is not established, contact the Cabletron Systems Global Call Center. Refer to [Section 1.6](#) for details.

3.4.3 Connecting a Fiber Optic Segment to the FE-100FX and FE-100F3

The FE-100FX and FE-100F3 have SC style network ports (see [Figure 3-11](#)). Cabletron Systems supplies fiber optic cable that uses SC style connectors, which are keyed to ensure proper crossover of the transmit and receive fibers.

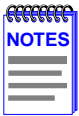

An odd number of crossovers (preferably one) must be maintained between devices so that the transmit port of one device is connected to the receive port of the other device and vice versa.

If the fiber optic cable being used has SC style connectors that do not resemble MIC style connectors, or has SC connectors on one end and a different type on the other, such as ST connectors, ensure that the proper crossing over occurs.

Fiber Optic Network Connection

1. Remove the protective plastic covers from the fiber optic ports on the applicable port on the module and from the ends of the connectors.



The FE-100F3 uses Class 1 lasers. Do not use optical instruments to view the laser output. The use of optical instruments to view laser output increases eye hazard. When viewing the output optical port, power must be removed from the network adapter.



Do not touch the ends of the fiber optic strands, and do not let the ends come in contact with dust, dirt, or other contaminants. Contamination of the ends causes problems in data transmissions. If the ends become contaminated, blow the surfaces clean with a canned duster. A fiber port cleaning swab saturated with optical-grade isopropyl alcohol may also be used to clean the fiber optic ends.

2. Insert one end of the SC connector into the FE-100FX or FE-100F3 installed in the 2E4X-27. See [Figure 3-11](#).
3. At the other end of the fiber optic cable, attach the SC connector to the other device.

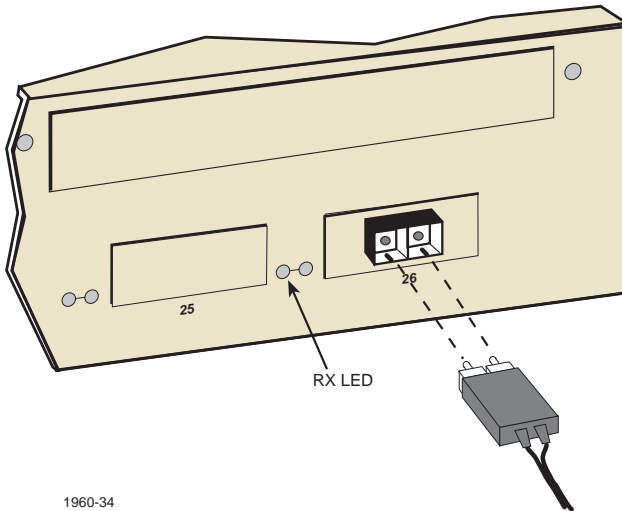

Figure 3-11 FE-100FX and FE-100F3 Ports

4. Verify that a link exists by checking that the port RX LED is ON (flashing yellow, blinking green, or solid green). If the RX LED is OFF and the TX LED is not blinking yellow, perform the following steps until it is on:
 - a. Check that the power is turned on for the device at the other end of the link.
 - b. Verify proper crossover of fiber strands between the applicable port on the 2E4X-27 and the fiber optic device at the other end of the fiber optic link segment.
 - c. Verify that the fiber connection meets the dB loss specifications outlined in [Section 2.4](#).

If a Link has not been established, contact the Cabletron Systems Global Call Center. Refer to [Section 1.6](#) for details.

3.5 COMPLETING THE INSTALLATION

After installing the 2E4X-27 and any optional Fast Ethernet Interface Modules and HSIM as appropriate, and making the connections to the network, proceed as follows:

1. Secure the cables by running the cables along the strain-relief bracket and tying them to the strain-relief bracket using cable ties.
2. The 2E4X-27 is now ready to be set up through Local Management. Refer to **Chapter 5, Local Management**, for information on how to access and use Local Management to configure the 2E4X-27.

CHAPTER 4

TROUBLESHOOTING

This chapter provides information concerning the following:

- Using the LANVIEW diagnostic and status monitoring system
- Troubleshooting network and 2E4X-27 operational problems
- Using the RESET button

4.1 USING LANVIEW

The 2E4X-27 uses Cabletron Systems built-in visual diagnostic and status monitoring system called LANVIEW. The LANVIEW LEDs (Figure 4-1) allow quick observation of the network status to aid in diagnosing network problems. Refer to Table 4-1 for a description of the LEDs.

For a functional description of the LANVIEW LED on the optional Fast Ethernet Interface Module (FE-100TX), refer to Section 4.2.

All LEDs for the High Speed Interface Module (HSIM) are located on the HSIM and are described in the associated HSIM user's guide.

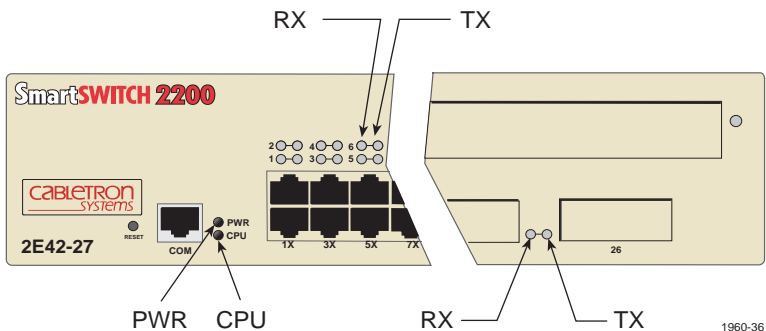
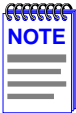

Figure 4-1 LANVIEW LEDs



The terms **flashing**, **blinking**, and **solid** used in the following tables indicate the following:

Flashing indicates an LED flashing randomly.

Blinking indicates an LED flashing at a steady rate (approximately 50% on, 50% off).

Solid indicates a steady LED light. No flashing.

Table 4-1 LANVIEW LEDs

LED	Color	State	Recommended Action
PWR	Green	Functional. Power supply(ies) operating normally.	No action.
	Amber	Indicates loss of power supply redundancy. This indication only applies when there are two power supplies.	1. Ensure that the power cords are plugged in correctly and that there is power at the power source. 2. Contact the Cabletron Systems Global Call Center.
CPU	Off	Power off.	Power up device.
	Red	Blinking. Hardware failure has occurred.	Contact the Cabletron Systems Global Call Center.
		Solid. Resetting, normal power up reset.	No action.
	Amber	Blinking. Crippled.	Contact the Cabletron Systems Global Call Center.
		Solid. Testing.	No action.
	Green	Solid. Functional.	No action.
Amber and Green	Booting. Blinks amber and green while booting.	No action.	

Table 4-1 LANVIEW LEDs (Continued)

LED	Color	State	Recommended Action
RX (Receive)	Off	No link. No activity. Port enabled or disabled.	No error.
	Green	Solid. Port enabled, link, no activity.	No error.
		Blinking. Port disabled, link.	No error.
	Amber	Flashing. Port enabled, link, activity.	No error.
	Red	Diagnostic failure.	Contact the Cabletron Systems Global Call Center for help.
TX (Transmit)	Off	Port enabled, no activity. Should flash green every two seconds indicating BPDUs being sent if STA is enabled and there is a valid link.	<ol style="list-style-type: none"> 1. Ensure that the STA is enabled and that there is a valid link. 2. Contact the Cabletron Systems Global Call Center for help.
	Green	Flashing. Indicates activity. Rate indicates data rate.	No action.
	Amber	Blinking. Port in standby. Port may be disabled due to Spanning Tree.	<ol style="list-style-type: none"> 1. Ensure that the port is not disabled. 2. Contact the Cabletron Systems Global Call Center for help.
	Red	Flashing. Indicates collision rate.	No action.
		Solid. Diagnostic failure.	Contact the Cabletron Systems Global Call Center for help.

4.2 FE-100TX LED

The optional FE-100TX has one LED labeled 10/100. The 10/100 LED together with the receive LED allows the user to determine the link status and the operating speed of the Fast Ethernet Interface Module. The 10/100 LED and the Receive (RX) LED are shown in Figure 4-2.

Table 4-2 and Table 4-3 provide a functional description of the 10/100 LED when the RX LED is on or off, respectively.

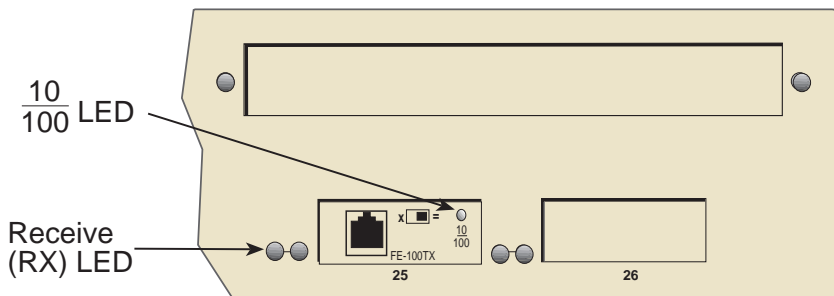

1960-41

Figure 4-2 FE-100TX LED



A link exists if the associated port (25 or 26) RX (Receive) LED is on.

Table 4-2 10/100 LED Indications When RX LED Is On

LED	Color	Indication
10/100	Off	FE-100TX is operating at 10 Mbps.
	Green	FE-100TX is operating at 100 Mbps.

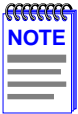

No link exists if the associated port (25 or 26) RX (Receive) LED is off.

Table 4-3 10/100 LED Indications When RX LED Is Off

LED	Color	Indication
10/100	Off	No link or no cable attached. FE-100TX forced to 10 Mbps operation, or is manually set to "auto-negotiate" mode.
	Green	No link or no cable attached. FE-100TX is forced to 100 Mbps operation.

4.3 TROUBLESHOOTING CHECKLIST

If the 2E4X-27 is not working properly, refer to [Table 4-4](#) for a checklist of possible problems, causes, and recommended actions to resolve the problem.

Table 4-4 Troubleshooting Checklist

Problem	Possible Cause	Recommended Action
All LEDs are OFF.	Loss of power.	Check for proper connection of the power cable and its access to a live outlet.
	Installed improperly.	Check the installation.
No Local Management Password screen.	Autobaud is enabled.	Press ENTER (RETURN) (may take up to four times).
	Terminal setup is not correct.	Refer to Chapter 5 for proper setup procedures.
	Improper console cable used.	Refer to Appendix A for proper console port pinouts.
Cannot contact the device from in-band management.	Improper Community Names Table.	Refer to Chapter 5 for Community Names Table setup.
	IP address not assigned.	Refer to Chapter 5 for IP address assignment procedure.
	Port is disabled.	Enable port.
	No link to device.	Check link to device.
Port(s) goes into standby for no apparent reason.	Loop condition detected.	<ol style="list-style-type: none"> 1. Review the network design and delete unnecessary loops. 2. Call the Cabletron Systems Global Call Center if the problem continues.
User parameters (IP address, Device and Module name, etc.) were lost when the 2E4X-27 power was cycled or the front panel RESET button was pressed.	Mode switch (7), NVRAM Reset, was changed sometime before either cycling power or pressing the RESET button causing the user-entered parameters to reset to factory default settings.	<ol style="list-style-type: none"> 1. Reenter the lost parameters as necessary. 2. Call the Cabletron Systems Global Call Center if the problem continues.

4.4 USING THE RESET BUTTON

The RESET button shown in [Figure 4-3](#) resets the 2E4X-27 processor without affecting the NVRAM.



Pressing the RESET button resets the device, and all current switching being performed by the device is halted. A network downtime of up to two minutes will result from this action.

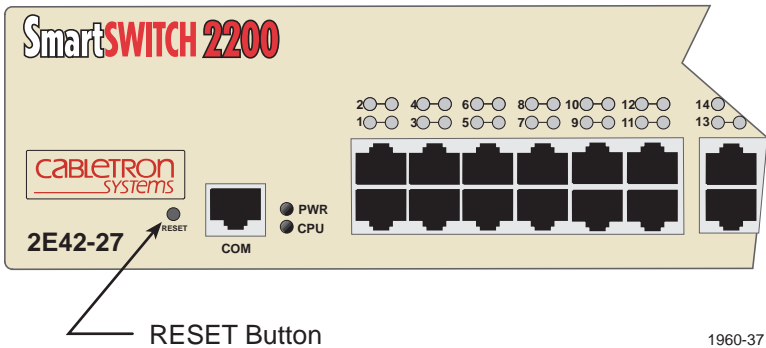

Figure 4-3 RESET Button

To reset the 2E4X-27 processor, use a pen or pencil to press and release the RESET button. The 2E4X-27 goes through a reset process for approximately 45 seconds.

CHAPTER 5

LOCAL MANAGEMENT

This chapter explains how to set up a management terminal to access Local Management. It also explains how to use the Local Management screens and commands.

5.1 OVERVIEW

Local Management for the 2E4X-27 consists of a series of management screens that allow the management of the 2E4X-27 and its attached segments. The management screens allow the user to do the following tasks:

- Assign IP address and subnet mask
- Select a default gateway
- Control access by establishing community names
- Download a new image of the operation software
- Designate which Network Management Workstations receive SNMP traps from the device
- View switch, interface and RMON statistics
- Configure ports to operate in standard or full duplex mode
- Trunking of ports to perform load sharing
- Set the switch operation mode 802.1D, 802.1Q, or SecureFast VLAN)
- Control the number of receive broadcasts that are switched out to the other interfaces

There are three ways to access Local Management:

- Locally using a VT type terminal connected to the COM port
- Remotely using a VT type terminal connected through a modem
- In-band through a Telnet connection

5.2 LOCAL MANAGEMENT KEYBOARD CONVENTIONS

All key names appear as capital letters in this manual. Table 5-1 explains the keyboard conventions and the key functions that are used.

Table 5-1 Keyboard Conventions

Key	Function
ENTER Key RETURN Key	These are selection keys that perform the same Local Management function. For example, "Press ENTER" means that you can press either ENTER or RETURN, unless this manual specifically instructs you otherwise.
ESCAPE (ESC) Key	This key allows an escape from a Local Management screen without saving changes. For example, "Press ESC twice" means the ESC key must be pressed quickly two times.
SPACE Bar BACKSPACE Key	These keys cycle through selections in some Local Management fields. Use the SPACE bar to cycle forward through selections and use BACKSPACE to cycle backward through selections.
Arrow Keys	These are navigation keys. Use the UP-ARROW, DOWN-ARROW, LEFT-ARROW, and RIGHT-ARROW keys to move the screen cursor. For example, "Use the arrow keys" means to press whichever arrow key moves the cursor to the desired field on the Local Management screen.
[–] Key	This key decreases values from a Local Management increment field. For example, "Press [–]" means to press the minus sign key.
DEL Key	The DEL (Delete) key removes characters from a Local Management field. For example, "Press DEL" means to press the Delete key.

5.3 MANAGEMENT TERMINAL SETUP

Use one of the following systems to access Local Management:

- An IBM or compatible PC running a VT series emulation software package
- A Digital Equipment Corporation VT100 type terminal
- A VT type terminal running emulation programs for the Digital Equipment Corporation VT100 series
- A remote VT100 type terminal via a modem connection
- In-band via a Telnet connection

5.3.1 Console Cable Connection

Use the Console Cable Kit provided with the 2E4X-27 to attach the management terminal to the 2E4X-27 COM port as shown in Figure 5-1.

Connect an IBM PC or compatible device, running the VT terminal emulation, to the 2E4X-27 as follows:

1. Connect the RJ45 connector at one end of the cable (supplied in the kit) to the COM port on the 2E4X-27.
2. Plug the RJ45 connector at the other end of the cable into the RJ45-to-DB9 adapter (supplied in the kit).
3. Connect the RJ45-to-DB9 adapter to the communications port on the PC.

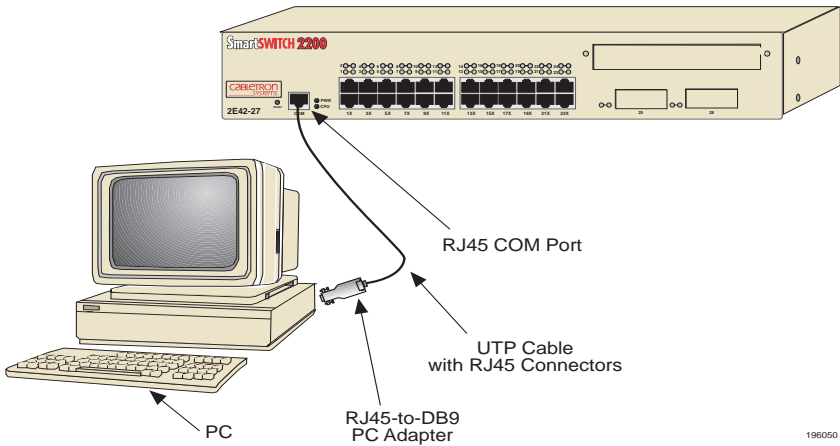

Figure 5-1 Management Terminal Connection

5.3.2 Management Terminal Setup Parameters

Table 5-2 lists the setup parameters for the local management terminal.

Table 5-2 VT Terminal Setup

Display Setup Menu	
Columns ->	80 Columns
Controls ->	Interpret Controls
Auto Wrap ->	No Auto Wrap
Scroll ->	Jump Scroll
Text Cursor ->	Cursor
Cursor Style ->	Underline Cursor Style
General Setup Menu	
Mode ->	VT100, 7 Bit Controls
ID number ->	VT100ID
Cursor Keys ->	Normal Cursor Keys
Power Supply ->	UPSS DEC Supplemental
Communications Setup Menu	
Transmit ->	2400, 4800, 9600, 19200
Receive ->	Receive=Transmit
XOFF ->	XOFF at 64
Bits ->	8 bits
Parity ->	No Parity
Stop Bit ->	1 Stop Bit
Local Echo ->	No Local Echo
Port ->	DEC-423, Data Leads Only
Transmit ->	Limited Transmit
Auto Answerback ->	No Auto Answerback
Keyboard Setup Menu	
Keys ->	Typewriter Keys
Auto Repeat ->	any option
Keyclick ->	any option
Margin Bell ->	Margin Bell
Warning Bell ->	Warning Bell

5.3.3 Monitoring an Uninterruptible Power Supply

If the 2E4X-27 is connected to an Uninterruptible Power Supply (UPS) device for protection against the loss of power, a connection from the 2E4X-27 COM port to the UPS can be made to monitor the power status of the UPS. To use the COM port for this purpose, it must be configured to support the UPS connection using the procedure described in Section 5.7.10. Refer to the UPS documentation for details on how to access the status information.

The Console Cable Kit provided with the 2E4X-27 is used to attach the UPS to the 2E4X-27 COM port as shown in Figure 5-2.

To connect the UPS device to the COM port of the 2E4X-27, proceed as follows:

1. Connect the RJ45 connector at one end of the cable to the COM port on the 2E4X-27.
2. Plug the RJ45 connector at the other end of the cable into the RJ45-to-DB9 male (UPS) adapter.
3. Connect the RJ45-to-DB9 male (UPS) adapter to the female DB9 port on the rear of the UPS device (see the particular UPS device's user instructions for more specific information about the monitoring connection).

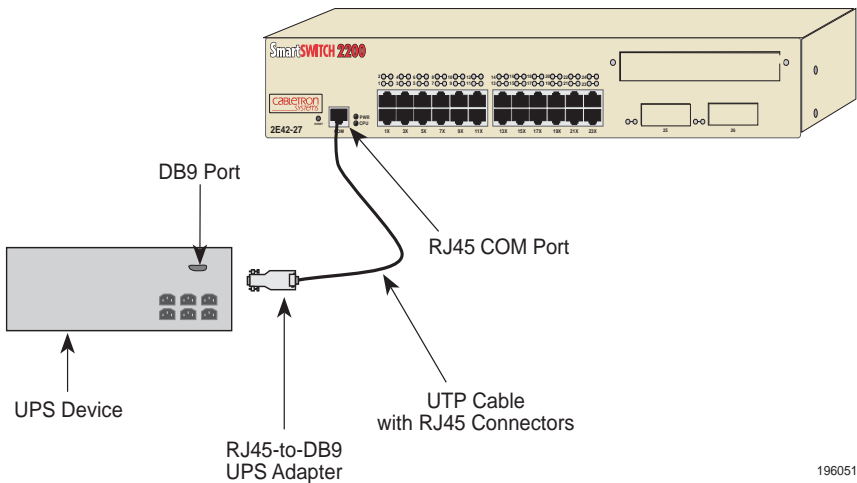
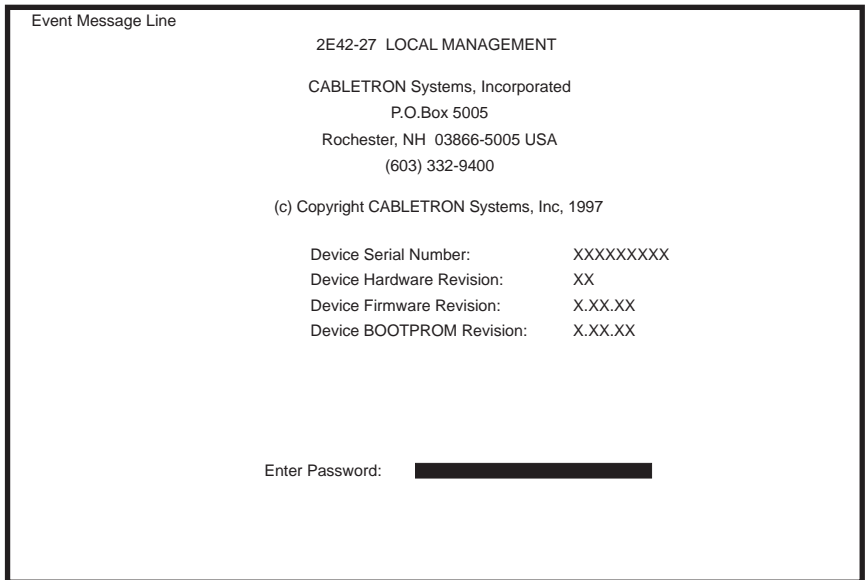

Figure 5-2 Uninterruptible Power Supply (UPS) Connection

5.4 ACCESSING LOCAL MANAGEMENT

Access to Local Management is controlled through the Password screen [Figure 5-3](#). Whenever a connection is made to the 2E4X-27 the Password screen displays. Before continuing, the user must enter a password (community name) which is compared to the previously stored passwords. The level of access allowed the user depends on the password. To set or change passwords, refer to [Section 5.8](#). The following steps describe the procedure to access Local Management.

1. Turn on the terminal. Press ENTER (this may take up to four times, because the COM port auto-senses the baud rate of the terminal) until the 2E4X-27 Local Management Password screen displays. It is the automatic line speed seeking feature of the port that makes it necessary at times to press ENTER several times.



19601-12

Figure 5-3 The 2E4X-27 Local Management Password Screen

2. Enter the Password and press ENTER. The default super-user access password is “*public*” or press ENTER.

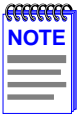

The User's password is one of the community names specified in the SNMP Community Names screen. Access to certain Local Management capabilities depends on the degree of access accorded that community name. Refer to [Section 5.8](#).

If an invalid password is entered, the terminal beeps and the cursor returns to the beginning of the password entry field.

Entering a valid password causes the associated access level to display at the bottom of the screen and the Device Menu screen to appear.

If no activity occurs for several minutes, the Password screen redisplays and the password has to be reentered.

5.4.1 Navigating Local Management Screens

The 2E4X-27 Local Management application consists of a series of menu screens. Navigate through Local Management by selecting items from the menu screens.

The 2E4X-27 support three modes of switch operation. The switching modes are as follows:

- 802.1D Switching (traditional switching)
- 802.1Q Switching (port based switching)
- SecureFast VLAN (Cabletron Systems SecureFast switching)



Refer to the Release Notes shipped with the product to verify which screens are supported in each of the three available switching modes.

Depending on the Operational Mode set for the device, the hierarchy of the Local Management screens differs as shown in [Figure 5-4](#), [Figure 5-5](#) and [Figure 5-6](#). Refer to the appropriate figure that relates to the Operational Mode set for the device to see the applicable Local Management screen hierarchy.

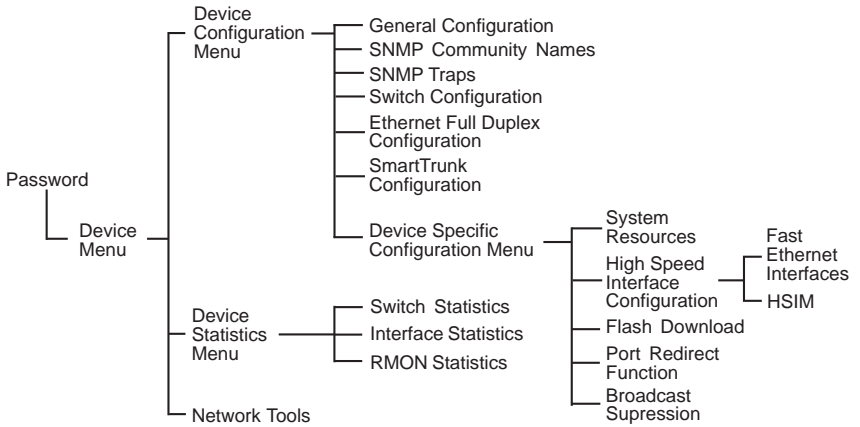

23141-43

Figure 5-4 802.1D Switching Mode, LM Screen Hierarchy

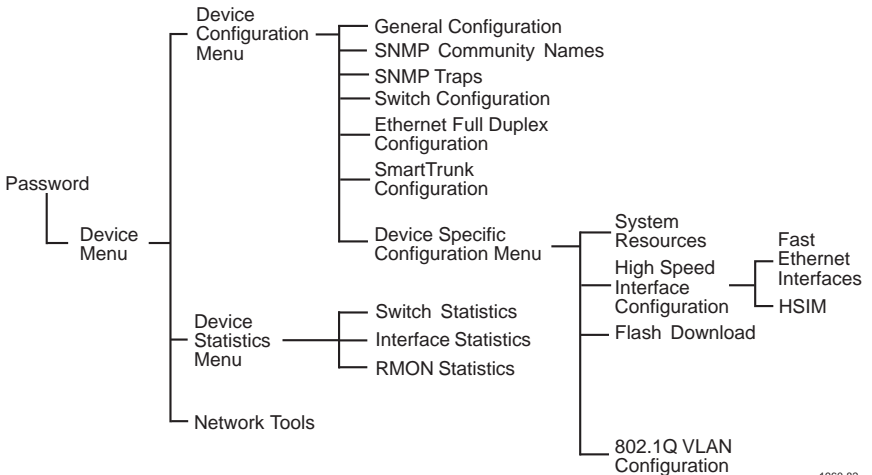

1960-82

Figure 5-5 802.1Q Switching Mode, LM Screen Hierarchy

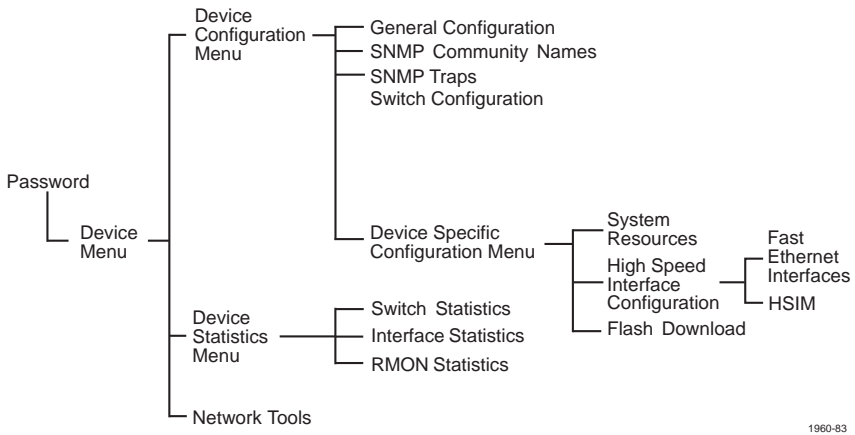

Figure 5-6 SecureFast VLAN Mode, LM Screen Hierarchy

5.4.2 Selecting Local Management Menu Screen Items

Select items on a menu screen by performing the following steps:

1. Use the arrow keys to highlight a menu item.
2. Press ENTER. The selected menu item displays on the screen.

5.4.3 Exiting Local Management Screens

There are two ways to exit the Local Management (LM) screens.

Using the Exit Command

To exit LM using the EXIT screen command, proceed as follows:

1. Use the arrow keys to highlight the **EXIT** command at the bottom of the Local Management screen.
2. Press ENTER. The Password screen displays and the session ends.

Using the RETURN Command

To exit LM using the RETURN command, proceed as follows:

1. Use the arrow keys to highlight the **RETURN** command at the bottom of the Local Management screen.
2. Press ENTER. The previous screen in the Local Management hierarchy displays.

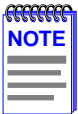

The user can also exit Local Management screens by pressing ESC twice. This exit method does not warn about unsaved changes and all unsaved changes will be lost.

3. Exit from 2E4X-27 Local Management by repeating steps 1 and 2 until the Device Menu screen displays.
4. To end the LM session, use the arrow keys to highlight the **RETURN** command at the bottom of the Device Menu screen.
5. Press ENTER. The Local Management screen displays and the session ends.

5.5 DEVICE MENU SCREEN

The Device Menu screen is the access point for all Local Management screens. Figure 5-7 shows the Device Menu screen.

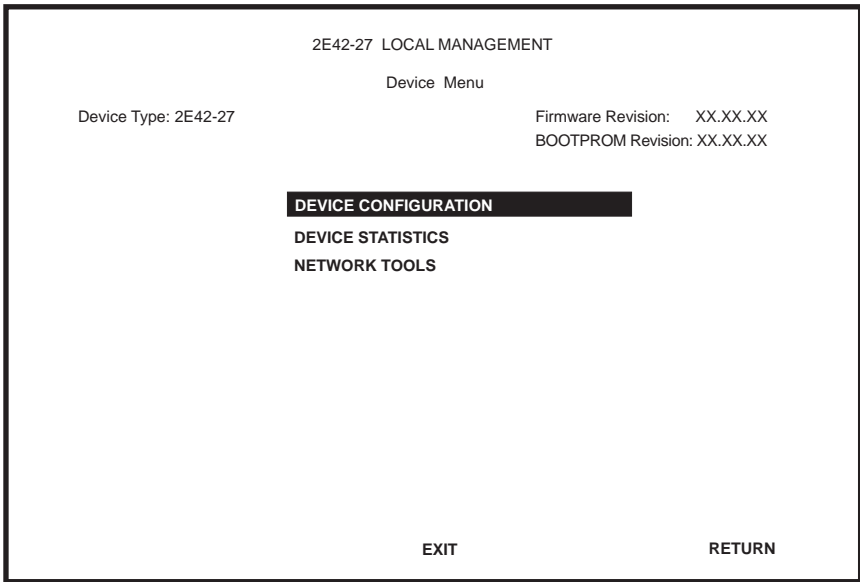

19601_13

Figure 5-7 Device Menu Screen

The following explains each Device Menu screen field as shown in Figure 5-7:

DEVICE CONFIGURATION

The Device Configuration screen provides access to the Local Management screens that are used to configure the 2E4X-27 and also to the Device Specific Configuration Menu screen. The Device Specific Configuration Menu screen provides access to the screens that allow the user to check the 2E4X-27 resources and set operating parameters specific to each port. For details about the Device Configuration Menu screen, refer to Section 5.6. For details about the Device Specific Configuration Menu screen, refer to Section 5.12.

DEVICE STATISTICS

The Device Statistics screen provides statistics and performance information for the 2E4X-27. For details about this screen, refer to [Section 5.19](#).

NETWORK TOOLS

The Network Tools function resides on the 2E4X-27 and consists of a series of commands that allow the user to access and manage network devices. [Section 5.23](#) explains how to use the Network Tools utility.



If the terminal is idle for several minutes, the Password screen redisplay and the session ends.

5.6 DEVICE CONFIGURATION MENU SCREEN

The Device Configuration Menu screen, [Figure 5-8](#), provides access to Local Management screens that allow you to configure and monitor operating parameters, modify SNMP community names, set SNMP traps, configure switch parameters and configure 2E4X-27 ports.

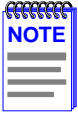

The following menu items on the Device Configuration Menu screen may not display if the operational mode of the device is set to SECURE FAST VLAN:

SWITCH CONFIGURATION

SMARTTRUNK CONFIGURATION

Refer to the Release Notes to see if the above screens are supported in SECURE FAST VLAN mode. [Section 5.7.9](#) describes how to set the operational mode.

To access the Device Configuration Menu screen from the Device Menu screen, use the arrow keys to highlight the **DEVICE CONFIGURATION** menu item and press ENTER. The Device Configuration Menu screen displays.

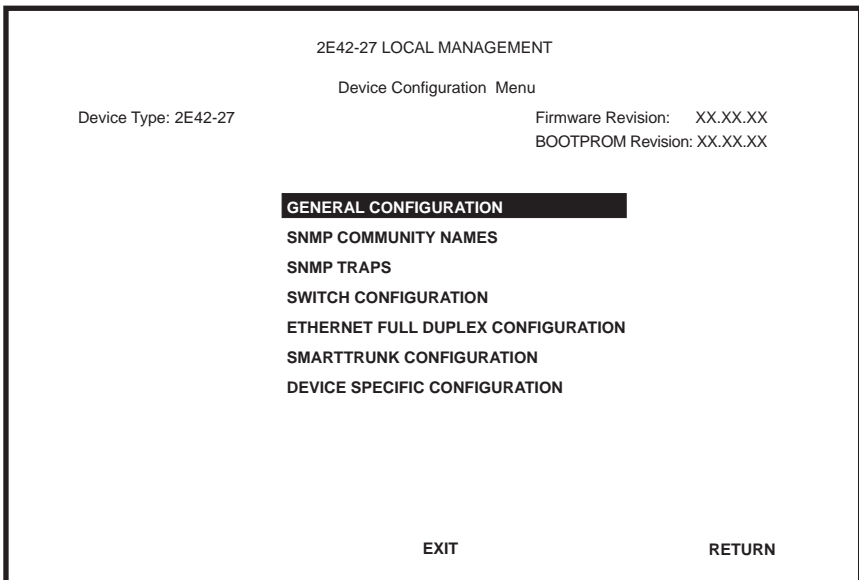

19601_66

Figure 5-8 Device Configuration Menu Screen

The following briefly explains each screen accessible from the Device Configuration Menu screen:

GENERAL CONFIGURATION

The General Configuration screen allows the user to monitor and configure operating parameters for the 2E4X-27. For details, refer to [Section 5.7](#).

SNMP COMMUNITY NAMES

The SNMP Community Names screen allows the user to enter new, change, or review the community names used as access passwords for device management operation. Access is limited based on the password level of the user. For details, refer to [Section 5.8](#).

SNMP TRAPS

The SNMP Traps screen provides display and configuration access to the table of IP addresses used for trap destinations and associated community names. For details, refer to [Section 5.9](#).

SWITCH CONFIGURATION

The Switch Configuration screen provides the basic setup options for modifying switch operation in the network. For details, refer to [Section 5.10](#).

ETHERNET FULL DUPLEX CONFIGURATION

The Ethernet Full Duplex Configuration screen allows each 10 Mbps port (1 to 24) to be set for either Standard Ethernet or Full Duplex operation. The screen also indicates whether or not each port is linked to another 10BASE-T device and if that port is enabled. For details, refer to [Section 5.11](#).

SMARTTRUNK CONFIGURATION

The SmartTrunk Configuration screen allows the user to logically group interfaces to aggregate high speed uplinks. Refer to the Cabletron Systems *SmartTrunk User's Guide* for additional information.

DEVICE SPECIFIC CONFIGURATION

The Device Specific Configuration Menu screen allows the user to select screens to configure ports or check system resources specific to the 2E4X-27. For details, refer to [Section 5.12](#).

5.7 GENERAL CONFIGURATION SCREEN

The General Configuration screen, [Figure 5-9](#), allows the user to set the system date and time, IP addresses and Subnet Masks, the Default Gateway, the TFTP Gateway IP address, and the COM port configuration.

To access the General Configuration screen from the Device Configuration Menu screen, use the arrow keys to highlight the **GENERAL CONFIGURATION** menu item and press ENTER. The General Configuration screen displays.

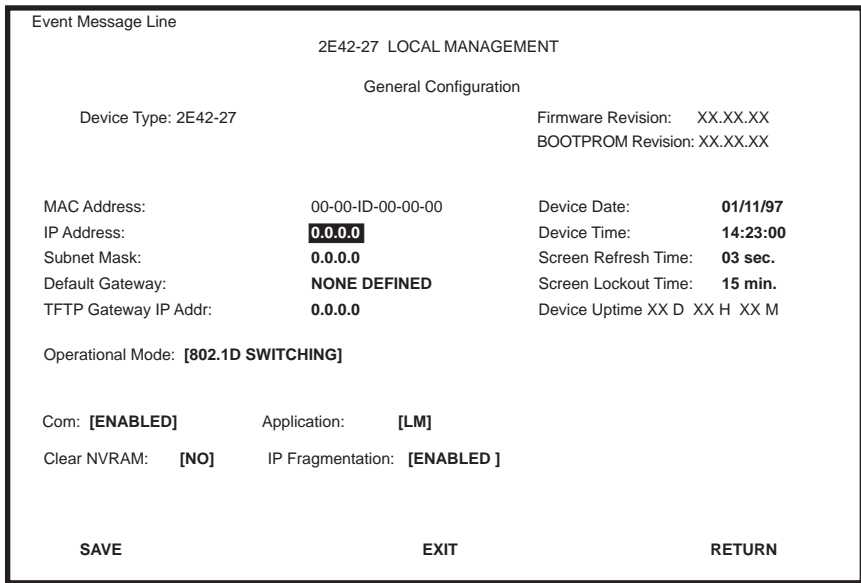

19603-15

Figure 5-9 General Configuration Screen

The following briefly explains each General Configuration screen field:

MAC Address (Read-Only)

Displays the physical address of the 2E4X-27.

IP Address (Modifiable)

Displays and allows the user to set the IP address for the 2E4X-27. To set the IP address, refer to [Section 5.7.1](#). The IP address can also be set through Runtime IP Address Discovery as previously described in [Section 1.4.4](#).

Subnet Mask (Modifiable)

Displays the subnet mask for the 2E4X-27. A subnet mask “masks out” the network bits of the IP address by setting the bits in the mask to 1 when the network treats the corresponding bits in the IP address as part of the network or subnetwork address, or to 0 if the corresponding bit identifies the host. For details about how to change the subnet mask from its default value, refer to [Section 5.7.2](#).

Default Gateway (Modifiable)

Displays the default gateway for the 2E4X-27. This field is not defined until an appropriate value is entered. For details about why and how to set the default gateway, refer to [Section 5.7.3](#).

TFTP Gateway IP Addr (Modifiable)

Displays and allows the user to set the TFTP Gateway IP address for the 2E4X-27. To set the TFTP Gateway IP address, refer to [Section 5.7.4](#).

Device Date (Modifiable)

Contains a value that the device recognizes as the current date. To set a new device date, refer to [Section 5.7.5](#).

Device Time (Modifiable)

Contains a value that the device recognizes as the current time. To enter a new time, refer to [Section 5.7.6](#).

Screen Refresh Time (Modifiable)

Contains the rate at which the screens are updated. This setting determines how frequently (in seconds) information is updated on the screen. To enter a new update time, refer to [Section 5.7.7](#).

Screen Lockout Time (Modifiable)

Contains the maximum number of minutes that the Local Management application displays a device’s screen while awaiting input or action from a user. For example, if the number 5 is entered in this field, the user has up to five minutes to respond to each of the specified module’s Local Management screens.

In this example, after five minutes of “idleness” (no input or action), the terminal “beeps” five times, the Local Management application terminates the session, and the display returns to the Password screen. To enter a new lockout time, refer to [Section 5.7.8](#).

Device Uptime (Read-Only)

Displays the total time that the device has been operating.

Operational Mode (Toggle)

Allows the user to set the 2E4X-27 so it operates as a traditional switch (802.1D SWITCHING), an IEEE 802.1Q switch (802.1Q SWITCHING), or as a Cabletron Systems SecureFast switch (SECURE FAST VLAN).

In 802.1D SWITCHING mode, the 24 ports on the front panel, and each Fast Ethernet Interface Module, and HSIM port(s) are bridged together.

In 802.1Q SWITCHING mode, the device is able to increase its switching functionality by creating and maintaining IEEE port based Virtual Local Area Networks (VLANs).

When the operational mode is set to SECURE FAST VLAN, the device acts as a SecureFast switch. With the Cabletron Systems VLAN Manager software, the device is able to increase its switching functionality by creating and maintaining VLANs.

For details on how to select the Operational Mode, refer to [Section 5.7.9](#).

Com (Toggle)

This field allows the user to enable or disable the COM port. The selection toggles between ENABLED and DISABLED. The default is ENABLED. For details about setting up the COM port, refer to [Section 5.7.10](#).

Application (Toggle)

Displays the application set for the COM port. This field allows the user to set the application that the COM port supports, which includes:

- Local Management (LM) via a terminal or modem connection
- Uninterruptible Power Supply (UPS)

The UPS setting allows the COM port to be used to monitor an American Power Conversion Uninterruptible Power Supply (UPS).

The baud rate setting for LM is automatically sensed. For UPS, the baud rate is automatically set to 2400.

For details about how to configure the COM port, refer to [Section 5.7.10](#).

Clear NVRAM (Toggle)

This allows the user to reset NVRAM to the factory default settings. All user-entered parameters, such as IP address and Community Names, are then replaced with 2E4X-27 default configuration settings. For details, refer to [Section 5.7.11](#).

IP Fragmentation (Toggle)

This allows the user to enable or disable IP Fragmentation. The default setting for this is field is ENABLED. If the 2E4X-27 is to be bridged to an FDDI ring, IP Fragmentation should be enabled. If IP Fragmentation is disabled, all FDDI frames that exceed the maximum Ethernet frame size will be discarded. For details on enabling IP Fragmentation, refer to [Section 5.7.12](#).

5.7.1 Setting the IP Address

To set the IP address, perform the following steps:

1. Use the arrow keys to highlight the **IP Address** field.
2. Enter the IP address into this field using Dotted Decimal Notation (DDN) format.

For example: 134.141.79.120

3. Press ENTER. If the IP address is a valid format, the cursor returns to the beginning of the IP address field. If the entry is not valid, the Event Message Line displays “INVALID IP ADDRESS OR FORMAT ENTERED”. Local Management does not alter the current value and refreshes the IP address field with the previous value.
4. Use the arrow keys to highlight the **SAVE** command, then press ENTER. The warning screen shown in [Figure 5-10](#) displays.

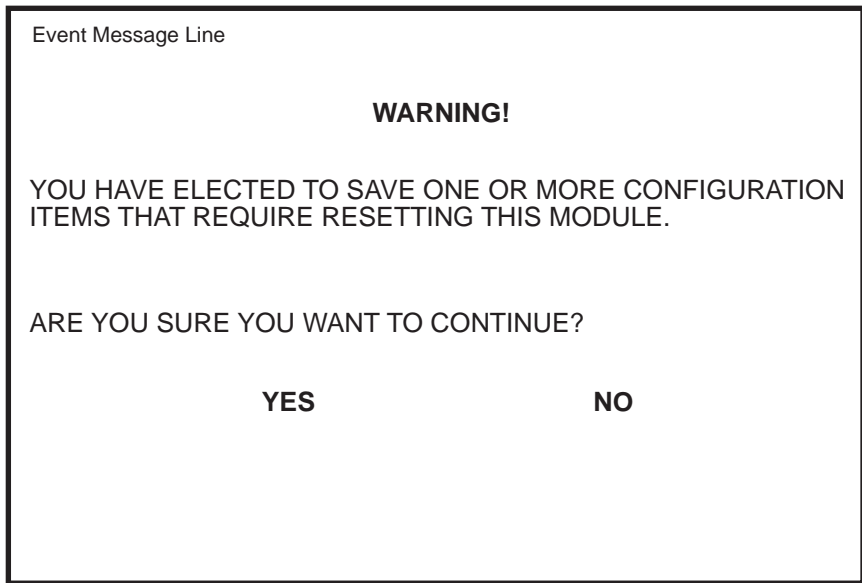

1960-84

Figure 5-10 Configuration Warning Screen

5. Use the arrow keys to highlight the **YES** command, then press ENTER. The changes are saved and the device reboots.

5.7.2 Setting the Subnet Mask

If the management workstation that is to receive SNMP traps from the 2E4X-27 is located on a separate subnet, the subnet mask for the 2E4X-27 may need to be changed from its default.

To change the subnet mask from its default, perform the following steps:

1. Use the arrow keys to highlight the **Subnet Mask** field.
2. Enter the subnet mask into this field using Dotted Decimal Notation (DDN) format.

For example: 255.255.0.0

3. Press ENTER. If the subnet mask is valid, the cursor returns to the beginning of the Subnet Mask field. If the entry is not valid, the Event Message Line displays “INVALID SUBNET MASK OR FORMAT ENTERED”. Local Management does not alter the current value, but it does refresh the Subnet Mask field with the previous value.

4. Use the arrow keys to highlight the **SAVE** command, then press ENTER. The warning screen shown in [Figure 5-11](#) displays.

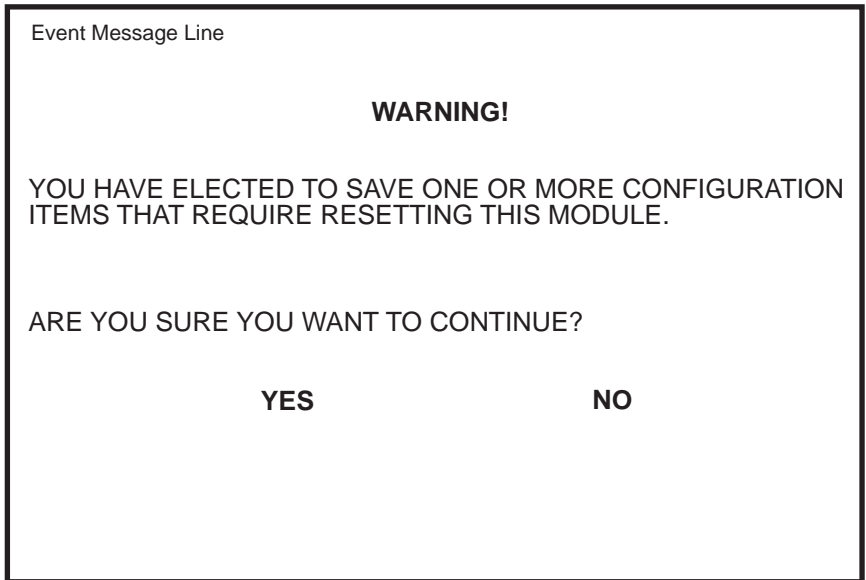

1960-84

Figure 5-11 Configuration Warning Screen

5. Use the arrow keys to highlight the **YES** command, then press ENTER. The changes are saved and the device reboots.

5.7.3 Setting the Default Gateway

If the SNMP management station is located on a different IP subnet than the 2E4X-27, a default gateway must be specified. When an SNMP Trap is generated, the 2E4X-27 sends the Trap to the default gateway. To set the default gateway, perform the following steps:

1. Use the arrow keys to highlight the **Default Gateway** field.
2. Enter the IP address of the default gateway using the DDN format.

For example: 134.141.79.121

3. Press ENTER. If the default gateway entered is a valid format, the cursor returns to the beginning of the Default Gateway field. If the entry is not valid, the Event Message Line displays “INVALID DEFAULT GATEWAY OR FORMAT ENTERED”. Local Management does not alter the current value, but it does refresh the Default Gateway field with the previous value.
4. Use the arrow keys to highlight the **SAVE** command.
5. Press ENTER. The Event Message Line at the top of the screen displays “SAVED OK”.

5.7.4 Setting the TFTP Gateway IP Address

If the network TFTP server is located on a different IP subnet than the 2E4X-27, a Gateway IP address should be specified. To set the TFTP Gateway IP address, perform the following steps:

1. Use the arrow keys to highlight the **TFTP Gateway IP Address** field.
2. Enter the IP address of the TFTP gateway using the DDN format.

For example: 134.141.80.122

3. Press ENTER. If the TFTP gateway IP address entered is a valid format, the cursor returns to the beginning of the TFTP Gateway IP Address field. If the entry is not valid, the Event Message Line displays “INVALID TFTP GATEWAY IP ADDRESS OR FORMAT ENTERED”. Local Management does not alter the current value, but it does refresh the TFTP Gateway IP Address field with the previous value.
4. Use the arrow keys to highlight the **SAVE** command.
5. Press ENTER. The Event Message Line at the top of the screen displays “SAVED OK”.

5.7.5 Setting the Device Date

To set the system date, perform the following steps:

1. Use the arrow keys to highlight the **Device Date** field.
2. Enter the date in an MM/DD/YYYY format.



It is not necessary to add separators between month, day, and year numbers, as long as each entry has the correct number of numeric characters. For example, to set the date to 03/17/1997, type “03171997” in the Device Date field.

3. Press ENTER to set the system calendar to the date in the input field.
4. Use the arrow keys to highlight the **SAVE** command at the bottom of the screen and press ENTER.

If the date entered is a valid format, the Event Message Line at the top of the screen displays “SAVED OK”. If the entry is not valid, Local Management does not alter the current value, but it does refresh the Device Date field with the previous value.

5.7.6 Setting the Device Time

To set the device clock, perform the following steps:

1. Use the arrow keys to highlight the **Device Time** field.
2. Enter the time in a 24-hour format, HH:MM:SS.



When entering the time in the system time field, separators between hours, minutes, and seconds are not needed as long as each entry uses two numeric characters. For example, to set the time to 6:45 P.M., type “184500” in the Device Time field.

3. Press ENTER to set the system clock to the time in the input field.
4. Use the arrow keys to highlight the **SAVE** command at the bottom of the screen and press ENTER.

If the time entered is a valid format, the Event Message Line at the top of the screen displays “SAVED OK”. If the entry is not valid, Local Management does not alter the current value and refreshes the Device Time field with the previous value.

5.7.7 Entering a New Screen Refresh Time

The screen refresh time is set from 3 to 99 seconds with a default of 3 seconds. To set a new screen refresh time, perform the following steps:

- 1.** Use the arrow keys to highlight the **Screen Refresh Time** field.
- 2.** Enter a number from 3 to 99.
- 3.** Press ENTER to set the refresh time to the time entered in the input field.
- 4.** Use the arrow keys to highlight the **SAVE** command at the bottom of the screen and press ENTER.

If the time entered is within the 3 to 99 seconds range, the Event Message Line at the top of the screen displays “**SAVED OK**”. If the entry is not valid, Local Management does not alter the current setting, but it does refresh the Screen Refresh Time field with the previous value.

5.7.8 Setting the Screen Lockout Time

The screen lockout time can be set from 1 to 30 minutes with a default of 15 minutes. To set a new lockout time, perform the following steps:

- 1.** Use the arrow keys to highlight the **Screen Lockout Time** field.
- 2.** Enter a number from 1 to 30.
- 3.** Press ENTER to set the lockout time in the input field.
- 4.** Use the arrow keys to highlight the **SAVE** command at the bottom of the screen and press ENTER.

If the time entered is within the 1 to 30 minutes range, the Event Message Line at the top of the screen displays “**SAVED OK**”. If the entry is not valid, Local Management does not alter the current setting, but it does refresh the Screen Lockout Time field with the previous value.

5.7.9 Setting the Operational Mode

To set the Operational Mode, proceed as follows:

1. Use the arrow keys to highlight the **Operational Mode** field.
2. Press the SPACE bar to step to the appropriate operation mode (**802.1D SWITCHING**, **802.1Q SWITCHING**, or **SECURE FAST VLAN**).
3. Use the arrow keys to highlight the **SAVE** command, then press ENTER. The warning screen shown in [Figure 5-12](#) displays.

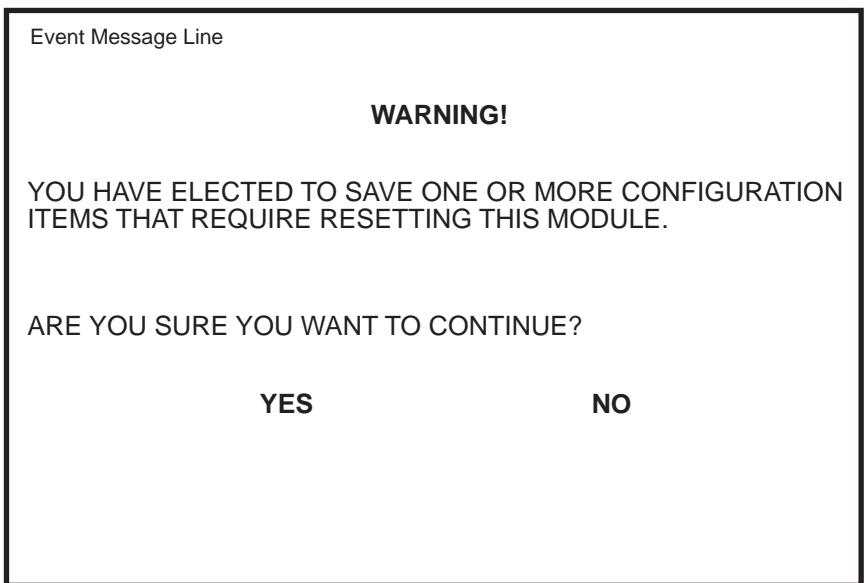

1960-84

Figure 5-12 Configuration Warning Screen

4. Use the arrow keys to highlight the **YES** command, then press ENTER. The changes are saved and the device reboots.

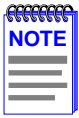

If the 2E4X-27 is set to **802.1Q SWITCHING**, refer to your *Port Based VLAN User's Guide* to configure the devices for this type of operation.

If the 2E4X-27 is set to **SECURE FAST VLAN**, refer to your SecureFast documentation set to configure the devices for this type of operation.

5.7.10 Configuring the COM Port

Upon power up, the COM port is configured to the default settings of ENABLED and LM.



Before altering the COM port settings, ensure that the 2E4X-27 is set with a valid IP address. (Refer to [Section 5.7.1, Setting the IP Address](#).) Read this entire COM port configuration section before changing the settings of the COM port.

The COM port supports the following applications:

- Local Management connections
- American Power Conversion (APC) Uninterruptible Power Supply (UPS) connections



Refer to the Release Notes included with the 2E4X-27 to verify additional COM Port applications that may be supported.

To configure the COM port, proceed as follows:

1. Use the arrow keys to highlight the **Com** field.



Do **NOT** disable or alter the settings of the COM port while operating the current Local Management connection through a terminal. Altering the COM port settings disconnects the Local Management terminal from the port, and ends the Local Management session. If the 2E4X-27 was previously assigned a valid IP address, reenter Local Management by establishing a Telnet connection to the device. If the device does not have a valid IP address and the COM port has been disabled or the settings changed, reset NVRAM on the 2E4X-27 (refer to [Section 5.7.11](#)) to reestablish COM port communications.

2. Press the SPACE bar to choose either **ENABLED** or **DISABLED**. **ENABLED** allows the COM port to be connected to the terminal and used for a particular application. **DISABLED** does not allow the COM port connection to the terminal.



If the COM port is reconfigured without a valid IP address set on the device, the message shown in [Figure 5-13](#) displays. Do not continue unless the outcome of the action is fully understood.

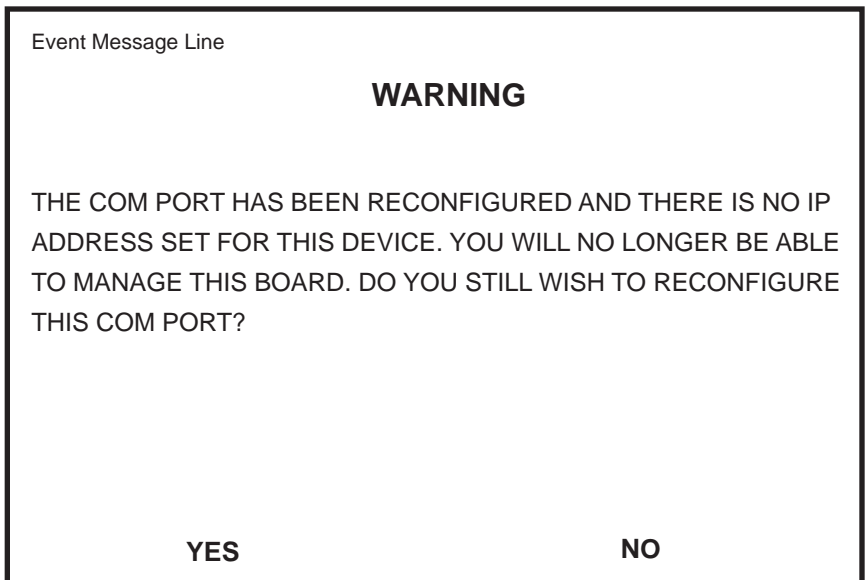

17421_52

Figure 5-13 COM Port Warning Screen

3. Use the arrow keys to highlight **YES**. Press ENTER.
4. If you **ENABLED** the port, proceed to step 5. If you **DISABLED** the port, use the arrow keys to highlight **SAVE** at the bottom of the screen, then press ENTER.

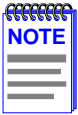

Exiting without saving causes the message “NOT SAVED -- PRESS SAVE TO KEEP CHANGES” to appear. Exiting without saving causes all edits to be lost.

5. When the message “SAVED OK” appears, the edits you made are saved.

5.7.10.1 Changing the Com Port Application

After enabling the COM port as described in [Section 5.7.10](#), one of the applications supported by the COM port (LM or UPS) can be selected. The default application is LM.

To change the COM port application:

1. Use the arrows keys to highlight the **Application** field.
2. Use the SPACE bar or BACKSPACE to step through the available settings until the operation you require appears. [Table 5-3](#) lists the available settings and their corresponding applications.

Table 5-3 COM Port Application Settings

Setting	Application
[LM]	Local Management Session
[UPS]	APC Power Supply SNMP Proxy

3. Press ENTER to accept the application.
4. Use the arrow keys to highlight **SAVE** at the bottom of the screen, then press the ENTER key. The message “SAVED OK” displays, indicating that the edits are saved.



When the COM port is configured to perform the UPS application, all future Local Management connections must be made by establishing a Telnet connection to the device. Ensure that the device has a valid IP address before saving changes to the COM port application. If the device does not have a valid IP address and the changes are saved, refer to [Appendix C](#) for instructions on clearing NVRAM in order to reestablish COM port communications.

5.7.11 Clearing NVRAM



Clearing NVRAM will result in the loss of all user-entered parameters. Do not proceed unless this procedure is completely understood.

Clearing NVRAM allows the user to clear all user-entered parameters, such as, the IP address and Community Names from NVRAM.

Clear NVRAM as follows:

1. Use the arrow keys to highlight the **Clear NVRAM** field.
2. Use the SPACE bar to toggle the field to **YES**.
3. Use the arrow keys to highlight **SAVE** at the bottom of the screen.
4. Press ENTER. The warning screen shown in [Figure 5-14](#) displays.

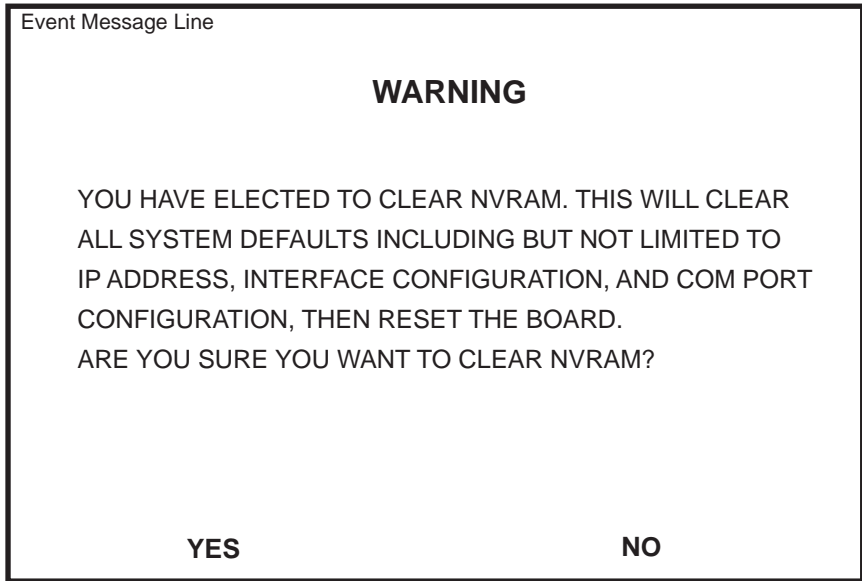

17421-51

Figure 5-14 Clear NVRAM Warning Screen

5. Press **YES** and the message “CLEARING NVRAM. REBOOT IN PROGRESS...” displays.
6. The 2E4X-27 clears NVRAM and reboots. All user-entered parameters default to factory default settings.

5.7.12 Enabling/Disabling IP Fragmentation

To enable or disable IP Fragmentation, proceed as follows:



If the 2E4X-27 is being bridged to an FDDI ring (for example, via an optional HSIM-F6), IP Fragmentation should be enabled. If it is disabled, all FDDI frames that exceed the maximum Ethernet frame size will be discarded.

1. Use the arrow keys to highlight the **IP Fragmentation** field.
2. Press the SPACE bar to choose either **ENABLED** or **DISABLED**.
3. Use the arrow keys to highlight the **SAVE** command.
4. Press ENTER. “SAVED OK” displays in the Event Message Line at the top of the screen.

5.8 SNMP COMMUNITY NAMES SCREEN

The SNMP Community Names screen allows the user to set SNMP Management community names. Community names act as passwords to Local/Remote Management and are agents of security access to the 2E4X-27. Access to the 2E4X-27 is controlled by enacting any of three different levels of security authorization (read-only, read-write, and super-user).

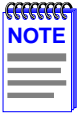

Super-user access gives the user full management privileges, allows existing passwords to be changed, and all modifiable MIB objects for the Cabletron Container MIB and Internet MIB-II to be edited.

To access the SNMP Community Names screen from the Device Configuration Menu screen, use the arrow keys to highlight the **SNMP COMMUNITY NAMES** menu item and press ENTER. The SNMP Community Names screen displays.

Event Message Line

2E42-27 LOCAL MANAGEMENT

SNMP Community Names

Device Type: 2E42-27 Firmware Revision: XX.XX.XX
BOOTPROM Revision: XX.XX.XX

Community Name	Access Policy
public	read-only
public	read-write
public	super-user

SAVE
EXIT
RETURN

19601-16

Figure 5-15 SNMP Community Names Screen

The following explains each SNMP Community Names screen field:

Community Name (Modifiable)

Displays the user-defined name through which a user accesses the 2E4X-27 SNMP Management. Any community name assigned here acts as a password to Local/Remote Management.

Access Policy (Read-Only)

Indicates the access accorded each community name. Possible selections are as follows:

read-only	This community name gives the user read-only access to the 2E4X-27 MIB objects, and excludes access to security-protected fields of read-write or super-user authorization.
read-write	This community name gives the user read-write access to the 2E4X-27 MIB objects, excluding security protected fields for Super-User access only.
super-user	This community name gives the user read-write access to the 2E4X-27 MIB objects and allows the user to change all modifiable parameters including community names, IP addresses, traps, and SNMP objects.

5.8.1 Establishing Community Names

The password used to access Local Management at the Password Screen must have super-user access to view and edit the SNMP Community Names screen. Using a password with read-only or read-write access does not allow the user to view or edit the SNMP Community Names screen.



Any community name assigned in the SNMP Community Names screen is a password to its corresponding level of access to Local Management. The community name assigned super-user access is the only one that gives the user complete access to Local Management.

To establish community names, proceed as follows:

1. Use the arrow keys to highlight the **Community Name** field adjacent to the selected access level.
2. Enter the password in the field (maximum 31 characters).
3. Press ENTER.
4. Repeat steps 1 through 3 to modify the other community names.
5. Use the arrow keys to highlight **SAVE** at the bottom of the screen and press ENTER. The message “SAVED OK” displays. The community names are saved to memory and their access modes implemented.



Exiting without saving causes a “NOT SAVED?” message to display above the **SAVE** command. Edits will be lost if they are not saved before exiting.

5.9 SNMP TRAPS SCREEN

Since the 2E4X-27 is an SNMP compliant device, it can send messages to multiple Network Management Stations to alert users of status changes. The SNMP Traps screen is shown in Figure 5-16.

To access the SNMP Traps screen from the Device Configuration Menu screen, use the arrow keys to highlight the **SNMP TRAPS** menu item and press ENTER. The SNMP Traps screen displays.

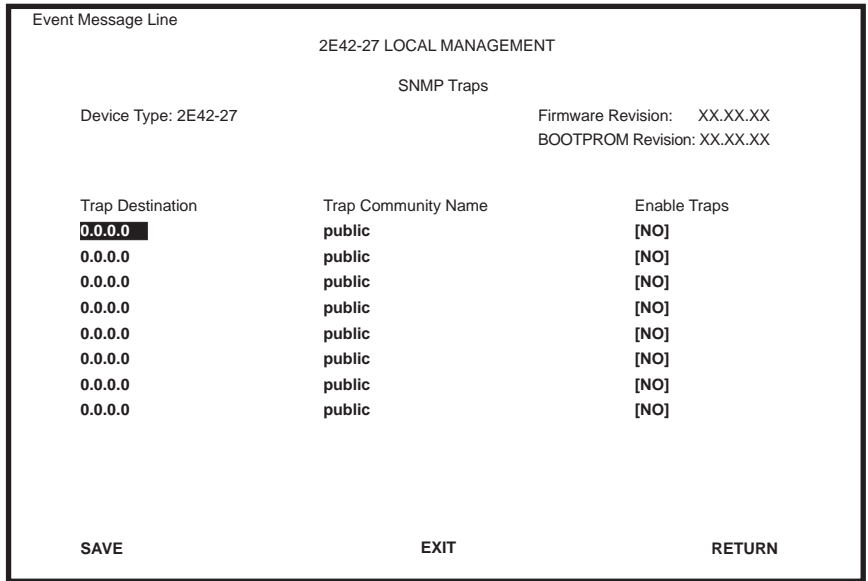

19601-17

Figure 5-16 SNMP Traps Screen

The following explains each field of the SNMP Traps screen.

Trap Destination (Modifiable)

Indicates the IP address of the workstation to receive trap alarms. Up to eight different destinations can be defined.

Trap Community Name (Modifiable)

Displays the Community Name included in the trap message sent to the Network Management Station with the associated IP address.

Enable Traps (Toggle)

Enables transmission of the traps to the network management station with the associated IP address. This field toggles between **YES** and **NO**.

5.9.1 Configuring the Trap Table

To configure the Trap table, proceed as follows:

1. Use the arrow keys to highlight the appropriate **Trap Destination** field.
2. Enter the IP address of the workstation that is to receive traps. IP address entries must follow the DDN format.

For example: 134.141.79.121
3. Press ENTER. If an invalid entry is entered “INVALID IP ENTERED” is displayed in the Event Message Line.
4. Use the arrow keys to highlight the **Trap Community Name** field. Enter the community name.
5. Press ENTER.
6. Use the arrow keys to highlight the **Enable Traps** field. Press the SPACE bar to choose either **YES** (send alarms from the 2E4X-27 to the workstation), or **NO** (prevent alarms from being sent).
7. Use the arrow keys to highlight the **SAVE** command and press ENTER. The message “SAVED OK” displays on the screen.



Exiting without saving causes a “NOT SAVED?” message to appear above the **SAVE** command. Edits will be lost if they are not saved before exiting.

The designated workstations now receive traps from the 2E4X-27.

5.10 SWITCH CONFIGURATION SCREEN

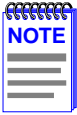

The Switch Configuration screen is not available if the operational mode of the device is set to SECURE FAST VLAN. This screen may only be used when the device is configured to operate as a traditional or 802.1Q switch.

The Switch Configuration screen, [Figure 5-17](#), provides the basic setup options to make a switch operational in your network.

To access the Switch Configuration screen from the Device Configuration Menu screen, use the arrow keys to highlight the **SWITCH CONFIGURATION** menu item and press ENTER. The Switch Configuration screen displays up to 8 ports. To view or edit the fields for other ports, highlight **[9-16]**, **[17-24]**, or **[25-27]** at the bottom of the screen and press the ENTER key.

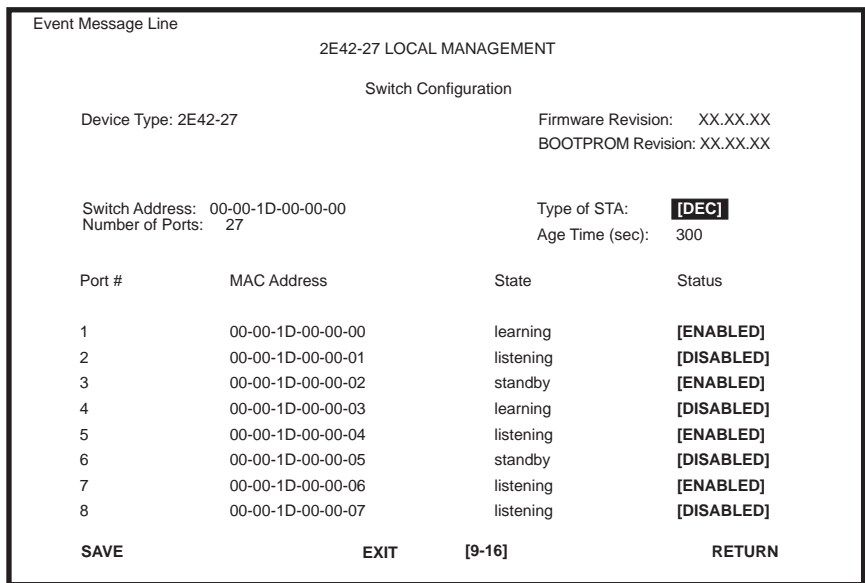

19601-18

Figure 5-17 Switch Configuration Screen

The following describes each field of the Switch Configuration screen:

Switch Address (Read-Only)

Displays the MAC address of the switch.

Number of Ports (Read-Only)

Displays the total number of switched ports on the 2E4X-27. Depending on the number of optional interfaces installed, there can be up to 27 ports.

Type of STA (Toggle)

Allows the user to set the method that switches use to decide which switch is the controlling (Root) switch when two or more switches exist in parallel (Spanning Tree Algorithm). Valid entries include IEEE, DEC, and None. To set the STA, refer to [Section 5.10.1](#).

Age Time (Modifiable)

Allows the user to set the amount of time (in seconds) that the 2E4X-27 keeps an address in its switch table before discarding it. An address is automatically discarded when a valid frame is not received from that address within the time specified in the Age Time field. To change the Age Time field from the default value of 300 seconds, refer to [Section 5.10.2](#).

Port # (Read-Only)

Lists each switched port on the device. If the number of ports is greater than eight, then the additional ports are listed on subsequent screens.

MAC Address (Read-Only)

Displays the base hardware address assigned to each listed port.

State (Read-Only)

Disabled: Management disabled this interface. No traffic is received or forwarded while the interface is disabled.

Listening: The switch is not adding information to the Transparent Database. The switch is monitoring BPDU traffic while preparing to move from the learning to the forwarding state.

Learning: The switch is learning the addresses on this interface. The switch enters the learning state when the Transparent Database is created (during start-up or after being deleted), or when the Spanning Tree Algorithm detects a network topology change.

Forwarding: The switch is operating and this interface is forwarding traffic.

Standby: This interface will not forward any traffic through the switch because a loop condition has been detected by the STA.

Status (Toggle)

Allows the user to disable or enable a port by setting the status of the listed interface to either **ENABLED** or **DISABLED**. To set the port status, refer to [Section 5.10.3](#).

5.10.1 Setting the STA

The Spanning Tree Algorithm (STA) setting allows the user to set the method that the switches use to decide which is the controller (Root) switch when two or more switches are in parallel. The available selections are IEEE, DEC, and NONE.

To set the STA, proceed as follows:

1. Use the arrow keys to highlight the **Type of STA** field.
2. Use the SPACE bar to step to the appropriate setting (**IEEE**, **DEC**, or **NONE**).
3. Use the arrow keys to highlight the **SAVE** command at the bottom of the screen.
4. Press ENTER. The message “SAVED OK” is displayed.

5.10.2 Setting the Age Time Field

To set the Age Time, proceed as follows:

1. Use the arrow keys to highlight the **Age Time** field.
2. Type in the desired Age Time in increments of 10. The available Age Time range is 10 to 1,000,000 seconds with the default value being 300 seconds.
3. Use the arrow keys to highlight the **SAVE** command at the bottom of the screen.
4. Press ENTER. The message “SAVED OK” is displays.

5.10.3 Setting (Enabling or Disabling) the Port Status

To set the status of an interface (port), proceed as follows:

1. Use the arrow keys to highlight the **Status** field of the port.
2. Use the SPACE bar to toggle to either **ENABLED** or **DISABLED**.

3. Use the arrow keys to highlight the **SAVE** command at the bottom of the screen.
4. Press ENTER. The message “SAVED OK” is displayed.

5.11 ETHERNET FULL DUPLEX CONFIGURATION SCREEN

The Ethernet Full Duplex Configuration screen, [Figure 5-18](#), allows the user to set ports 1 through 24, individually or all at once, to either Standard Ethernet or Full Duplex operation, and monitor each port to see whether or not it is enabled and linked to another 10BASE-T device. Refer to [Section 5.15](#) to set the Operation Mode for ports 25 and 26.

To access the Ethernet Full Duplex Configuration screen from the Device Specific Configuration Menu screen, use the arrow keys to highlight the **ETHERNET FULL DUPLEX CONFIGURATION** menu item in the Device Specific Configuration Menu screen and press ENTER. The Ethernet Full Duplex Configuration screen displays.

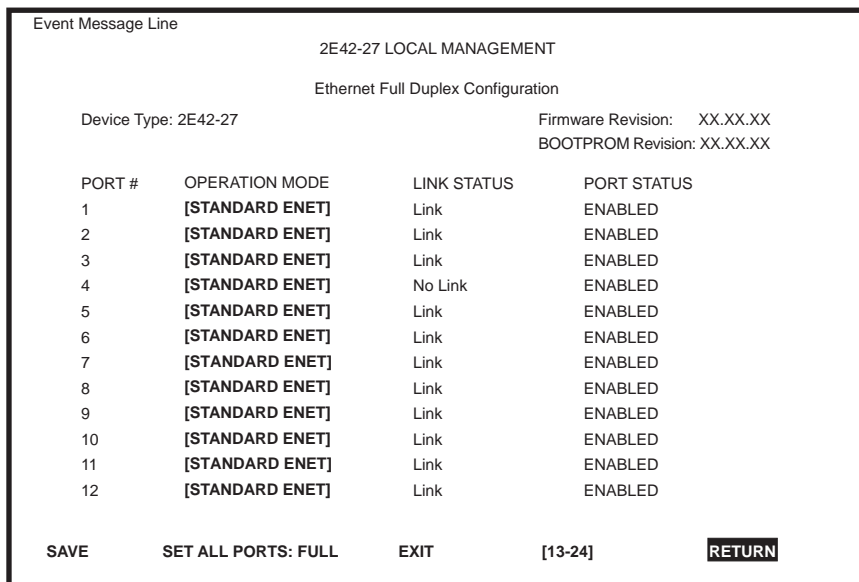

19601-21

Figure 5-18 Ethernet Full Duplex Configuration Screen

This section explains each field of the Full Duplex Configuration screen.

PORT # (Read-only)

Identifies the number of the port.

OPERATION MODE (Toggle)

Allows the user to set the specified port to transmit and receive data separately (Standard) or simultaneously (Full Duplex). Set this field to one of the following values:

- **STANDARD ENET** – The port is running at 10 Mbps (default) and either transmits data or receives data, but not both at the same time. To set Ethernet ports for Standard operation, refer to [Section 5.11.1](#).
- **FULL DUPLEX** – The port transmits and receives data simultaneously at 10 Mbps, thus enabling the port to effectively switch at 20 Mbps. To set Ethernet ports for Full Duplex operation, refer to [Section 5.11.1](#).

LINK STATUS (Read-only)

Indicates whether there is a physical connection from this port to another 10BASE-T device. One of the following values displays:

- **Link** – There is a 10BASE-T link signal present; there is a valid physical connection from this port to another 10BASE-T device.
- **No Link** – No 10BASE-T link signal present; there is no valid physical connection from this port to another 10BASE-T device.

PORT STATUS (Read-only)

Indicates whether the port was turned on or off administratively. One of the following values is displayed:

- **ENABLED** – The port is turned on administratively.
- **DISABLED** – The port is turned off administratively.



Enabling or disabling ports from the Switch Configuration screen is described in [Section 5.10.3](#).

SET ALL PORTS (Toggle)

All ports (1 through 24) can be set at once to either **STANDARD** or **FULL** from this field. To set ports, refer to [Section 5.11.1](#).

[1-12] or [13-24] (Navigation Key)

When the Full Duplex Configuration screen displays, the current operation mode and status information are displayed for the first 12 ports. This field allows the user to step to the second screen for the same type of information for ports 13 through 24. While on the second screen, the user can navigate back to the first screen by highlighting the **[1-12]** field and pressing ENTER. The user can change the Operation Mode fields while in either the first or second screen.

5.11.1 Setting the Operation Mode

The Operational Mode may be set to Standard Ethernet or Full Duplex either one port at a time or all at once. The following steps describe setting the port Operational Mode for individual ports followed by steps to set the Operational Mode for all ports.

To set the Operational Mode for individual ports, proceed as follows:

1. Use the arrow keys to highlight the **Operation Mode** field adjacent to the number of the port(s) that you plan to change.



The Operation Mode for the first 12 ports can be changed on the first screen. To display the Operation Mode for Ports 13 through 24, use the arrow keys to highlight the Ports **[13-24]** field and press ENTER. To again display the Operation Mode for Ports 1 through 12, use the arrow keys to highlight the Ports **[1-12]** field and press ENTER.

2. Press the SPACE bar until the appropriate mode, **FULL DUPLEX** or **STANDARD ENET** displays in the field.
3. Use the arrow keys to highlight the **SAVE** command on the bottom line of the screen.
4. Press ENTER. The message "SAVED OK" displays.

To set the Operation Mode for all ports (1-24), proceed as follows:

1. Use the arrow keys to highlight the **SET ALL PORTS** field.
2. Press the SPACE bar until you see **FULL** or **STANDARD**.
3. Use the arrow keys to highlight the **SAVE** command on the bottom line of the screen.
4. Press ENTER. The message “SAVED OK” displays.

5.12 DEVICE SPECIFIC CONFIGURATION MENU SCREEN

The Device Specific Configuration Menu screen, [Figure 5-19](#), allows the user to select one of five screens to configure ports or check system resources specific to the 2E4X-27.



The following menu items on the Device Specific Configuration Menu screen may not display if the operational mode of the device is set to 802.1Q SWITCHING or SECURE FAST VLAN:

PORT REDIRECT FUNCTION

BROADCAST SUPPRESSION

Refer to the Release Notes to see if the functionality provided above screens is supported. [Section 5.7.9](#) describes how to set the operational mode.

To access the Device Specific Configuration Menu screen from the Device Configuration Menu screen, use the arrow keys to highlight the **DEVICE SPECIFIC CONFIGURATION** menu item and press ENTER. The Device Specific Configuration Menu screen displays.

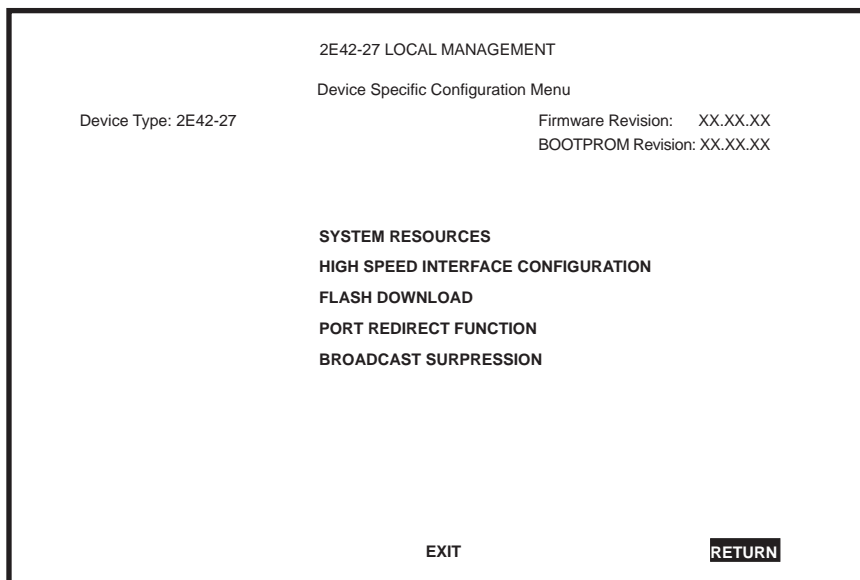

19602-20

Figure 5-19 Device Specific Configuration Menu Screen

The following explains each selectable item in the Device Specific Configuration Menu screen:

SYSTEM RESOURCES

The System Resources screen displays the amount of FLASH memory, DRAM and NVRAM installed, indicates the amount of available memory and provides information on 2E4X-27 operation. For details, refer to [Section 5.13](#).

HIGH SPEED INTERFACE CONFIGURATION

The High Speed Interface Configuration screen provides access to the Fast Ethernet Interfaces screen and the HSIM screen. For details, refer to [Section 5.14](#).

FLASH DOWNLOAD

The FLASH Download screen allows the user to download information from FLASH memory and force the 2E4X-27 to download a new image file from a TFTP server. For details, refer to [Section 5.16](#).

PORT REDIRECT FUNCTION

This menu item can only be selected if the device is set to operate as a traditional switch (802.1D SWITCHING) as described in [Section 5.11.1](#), Setting the Operation Mode. The Port Redirect Function screen allows the user to redirect traffic from one or multiple ports to a specific destination port. For details, refer to [Section 5.17](#).

BROADCAST SUPPRESSION

This menu item can only be selected if the device is set to operate as a traditional switch (802.1D SWITCHING) as described in [Section 5.11.1](#), Setting the Operation Mode. The Broadcast Suppression screen allows the user to set a desired limit of received broadcast frames that will be forwarded per port per second. For details, refer to [Section 5.18](#).

802.1Q VLAN CONFIGURATION

This menu item will only display if the 2E4X-27 has been configured to operate as an 802.1Q switch as described in [Section 5.11.1](#), Setting the Operation Mode. When selected, this menu item opens the VLAN Main Menu screen. For details about the VLAN Local Management screens and how to use them to configure VLANs in the 2E4X-27, refer to the Cabletron Systems *Port Based VLAN User's Guide*.

5.13 SYSTEM RESOURCES SCREEN

The System Resources screen, [Figure 5-20](#), provides information concerning the processor used in the 2E4X-27 and the amount of FLASH memory, DRAM, and NVRAM that is installed and how much of that memory is available. This screen also allows the user to monitor the current processor (switch) utilization and the peak switch utilization

To access the System Resources screen from the Device Specific Configuration Menu screen, use the arrow keys to highlight the **SYSTEM RESOURCES** menu item and press ENTER. The System Resources screen displays.

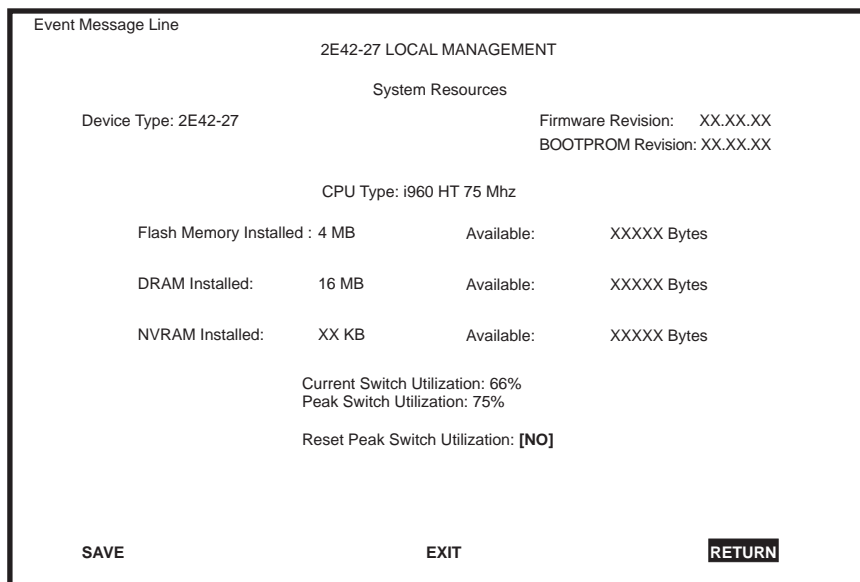

19602-23

Figure 5-20 System Resources Screen

The following briefly explains each field of the System Resources screen.

CPU Type (Read-only)

Indicates the microprocessor used in the 2E4X-27.

Flash Memory Installed (Read-only)

Indicates the amount of FLASH memory installed in the 2E4X-27 and how much is currently available.

DRAM Installed (Read-only)

Indicates the amount of DRAM installed in the 2E4X-27 and how much of it is currently available.

NVRAM Installed (Read-only)

Indicates the amount of NVRAM installed in the 2E4X-27 and how much of it is currently available.

Current Switch Utilization (Read-only)

Shows how much (percentage of processor capacity) of the 2E4X-27 is currently being used.

Peak Switch Utilization (Read-only)

Shows the peak percentage of maximum switching capacity, since last reset.

Reset Peak Switch Utilization (Toggle)

Allows the user to reset the Peak Switch Utilization field. The switch may be set to either YES or NO as described in [Section 5.13.1](#). YES resets the Peak Switch Utilization field to the current system traffic.

5.13.1 Setting the Reset Peak Switch Utilization

To set the Reset Peak Switch Utilization field to **YES** or **NO**, proceed as follows:

1. Use the arrow keys to highlight the **Peak Switch Utilization** field.
2. Press the SPACE bar to select **YES** or **NO**.
3. Use the arrows keys to highlight the **SAVE** command at the bottom of the screen.
4. Press ENTER. The message “SAVED OK” displays.

5.14 HIGH SPEED INTERFACE CONFIGURATION MENU SCREEN



This High Speed Interface Configuration Menu screen does not display unless an optional interface module is installed: one or two Fast Ethernet Interface Modules, or High Speed Interface Module (HSIM).

The High Speed Interface Configuration Menu screen, [Figure 5-21](#), applies to the Fast Ethernet Interface Modules and the High Speed Interface Module.

To access the High Speed Interface Configuration Menu screen from the Device Specific Configuration Menu screen, use the arrow keys to highlight the **HIGH SPEED INTERFACE CONFIGURATION** menu item and press ENTER. The High Speed Interface Configuration Menu screen, [Figure 5-21](#), displays.

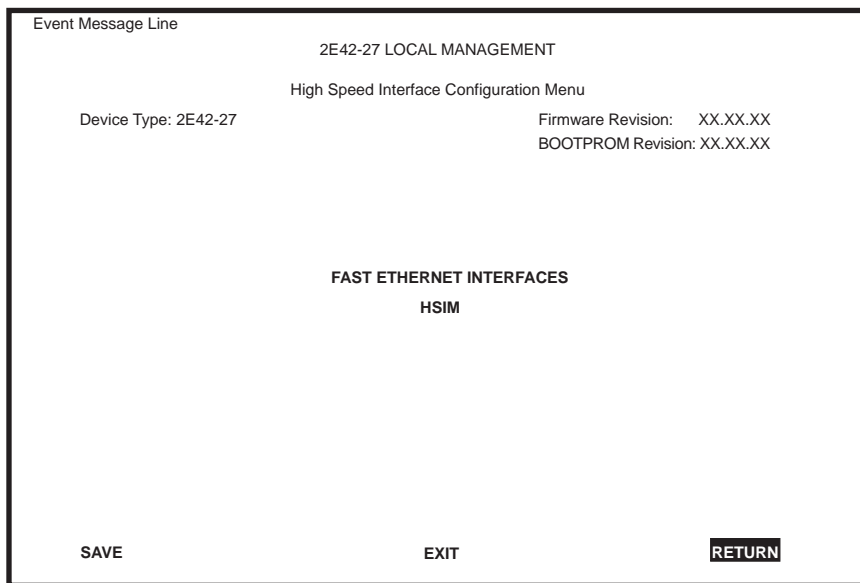

19601-53

Figure 5-21 High Speed Interface Configuration Menu Screen

The following briefly explains each screen accessible from the High Speed Interface Configuration Menu screen.

FAST ETHERNET INTERFACES

Displays the types of interfaces installed in ports 25 and 26, their current operating mode, and indicates if the ports are linked. This screen also allows the user to enable or disable Auto-Negotiation and set the Advertised Ability. For details, refer to [Section 5.15](#).

HSIM

Displays the types of interfaces installed in the High Speed Interface Module (HSIM) slot. The HSIM screens are depicted in their respective user's guides.

5.15 HIGH SPEED INTERFACE CONFIGURATION SCREEN



The High Speed Interface Configuration screen, [Figure 5-22](#), applies only to ports 25 and 26. This screen supports the FE-100TX, FE-100FX, and FE-100F3 Fast Ethernet Interface Modules that operate at 100 Mbps.

The High Speed Interface Configuration screen displays the types of interfaces installed in ports 25 and 26, their current operating mode, and indicates if the ports are linked. This screen also allows the user to enable or disable Auto-Negotiation and set the Advertised Ability.

To access the High Speed Interface Configuration screen from the High Speed Interface Configuration Menu screen, use the arrow keys to highlight the **FAST ETHERNET INTERFACES** menu item and press ENTER. The High Speed Interface Configuration screen displays.

Event Message Line			
2E42-27 LOCAL MANAGEMENT			
High Speed Interface Configuration			
Device Type: 2E42-27	Firmware Revision: XX.XX.XX		
	BOOTPROM Revision: XX.XX.XX		
	Port 25	Port 26	
Port Type	FE-100TX	Unknown	
Link Status	Link	N/A	
Current Oper. Mode	100Base-TXFD	[N/A]	
Desired Oper. Mode	[Auto-Negotiation]	[N/A]	
Advertised Ability	[100Base-TXFD]	[Disabled]	[N/A]
SAVE	EXIT	RETURN	

19601-24

Figure 5-22 High Speed Interface Configuration Screen

The following briefly explains each field of the High Speed Interface Configuration screen.

Port Type (Read-only)

Displays the type of interface (FE-100FX, FE-100TX, FE-100F3, or Unknown) installed in ports 25 and 26. Figure 5-22 shows that there is an FE-100TX interface installed in port 25 and no interface indicated by Unknown in port 26.

Link Status (Read-only)

Indicates whether or not there is a physical connection from this port to another 10BASE-T or 100BASE-TX/FX device. One of the following values displays:

- **Link** – There is a link signal present and a valid physical connection to another device.
- **No Link** – There is no link signal present and no valid physical connection to another device.

Current Oper. Mode (Read-only)

This field displays the current operating mode of ports 25 and 26. Depending on whether a 100BASE-FX, or 100BASE-TX is installed, this field displays the following:

- With a 100BASE-FX interface: 100Base-FX, 100Base-FXFD (full duplex), or N/A when port is empty.
- With a 100BASE-TX interface: Unknown, 10Base-T, 10Base-TFD (full duplex), 100Base-TX, 100Base-TXFD (full duplex) or N/A when port is empty.

Desired Oper. Mode (Selectable)

This field allows the user to select the desired operational mode for an interface in port 25 or 26. The field toggles between 100BASE-FX and 100BASE-FXFD (full duplex) when an FE-100FX or FE-100F3 is installed. [Section 5.15.1](#) describes how to configure a port with an FE-100FX or FE-100F3.

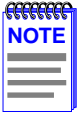

In normal operation, the port with an FE-100TX installed automatically establishes a link with the device at the other end of the segment without requiring user setup. However, Local Management provides the user with the option of manually configuring that port.

If an FE-100TX is installed, the field steps to Auto-Negotiation, 10Base-T, 10Base-TFD (full duplex), 100Base-TX, and 100Base-TXFD (full duplex). In normal operation, the port with an FE-100TX installed is capable of auto-negotiating the operational mode and no further user setup is required. [Section 5.15.3](#) describes how to manually configure an FE-100TX.

In Auto-Negotiation, the FE-100TX negotiates to the highest common denominator of the two interfaces. The order of priority of negotiation is 100BASE-TXFD, 100BASE-TX, 10BASE-TFD, and 10BASE-T.

Advertised Ability (Selectable)

During auto-negotiation, the FE-100TX “tells” the device at the other end of the segment about its capabilities. The capabilities of a port (25 or 26) with an FE-100TX installed are 10Base-T, 10Base-TFD (full duplex mode), 100Base-TX and 100Base-TXFD (full duplex mode). In normal operation, with all capabilities enabled, the FE-100TX “advertises” that it has the ability to operate in any mode. The Network Manager may choose to set up the port so that only a portion of the available capabilities are advertised and the others are disabled. For example, only 100Base-TX and 100Base-TXFD might be enabled so that only devices that operate at 100 Mbps can communicate with that port. [Section 5.15.5](#) describes how to enable or disable advertised modes.

5.15.1 Configuring an FE-100FX or FE-100F3 in Port 25 or 26

When an FE-100FX or FE-100F3 is installed in port 25 or 26, it must be manually set to operate in the same technology as the device at the other end of the connected segment. [Section 5.15.2](#) provides instructions for manually configuring the port with an FE-100FX or FE-100F3 interface.

5.15.2 Setting the FE-100FX or FE-100F3 Operational Mode

Use this field to set the active technology. This field toggles between 100Base-FX and 100Base-FXFD (full duplex). To set the active technology through Local Management, proceed as follows:

1. Use the arrow keys to highlight the **Desired Operational Mode** field.
2. Use the SPACE bar to select **100Base-FX** or **100Base-FXFD** (full duplex).
3. Press ENTER. The port now operates in the chosen mode.
4. Use the arrow keys to highlight the **SAVE** command. Press ENTER. The message “SAVED OK” displays and Local Management saves the changes to memory.

5.15.3 Configuring an FE-100TX in Port 25 or 26

In normal operation, a port (25 or 26) with an FE-100TX interface automatically establishes a link with the device at the other end of the segment and no user setup is required. [Section 5.15.4](#) and [Section 5.15.5](#) provide instructions for manually configuring the port with an FE-100TX installed.

5.15.4 Setting the FE-100TX Operational Mode

Use this field to set the active technology. This field steps between Auto-Negotiation, 10Base-T, 10Base-TFD (full duplex), 100Base-TX, and 100Base-TXFD (full duplex). If Auto-Negotiation is selected, the FE-100TX automatically sets the active technology. To manually set the active technology through Local Management, proceed as follows:

1. Use the arrow keys to highlight the **Desired Oper. Mode** field.

2. Use the SPACE bar to select the desired mode. Press ENTER. If any mode other than Auto-Negotiation is selected, the port only operates in the chosen mode and Auto-Negotiation is disabled.
3. Use the arrow keys to highlight the **SAVE** command. Press ENTER. The message “SAVED OK” displays and Local Management saves the changes to memory. The selected mode is displayed in both the Desired Operational Mode field and the Current Operational Mode field.

5.15.5 Setting the FE-100TX Advertised Ability

In normal operation, a port (25 or 26) with an FE-100TX auto-negotiates to the highest speed possible. Under some circumstances, the Network Administrator may want the port to advertise only some of the available modes and not advertise in other modes. This field steps to 10Base-T, 10Base-TFD (full duplex), 100Base-TX, and 100Base-TXFD (full duplex). To set the advertised ability, proceed as follows:

1. Use the arrow keys to highlight the **Desired Oper. Mode** field.
2. Use the SPACE bar to select the desired mode.
3. Use the LEFT-ARROW key to move back to the **Advertised Ability** selection and use the SPACE bar to select the next mode to enable or disable.
4. Use the RIGHT-ARROW key to move across to the **Enabled/Disabled** field to the right of the selection.
5. Use the SPACE bar to select **Enabled** or **Disabled**. Press ENTER. Continue this process until you have completed enabling or disabling the advertised modes.
6. Use the arrow keys to highlight the **SAVE** command. Press ENTER. The message “SAVED OK” displays and Local Management saves the changes to memory.

5.16 FLASH DOWNLOAD SCREEN

The Flash Download screen, shown in [Figure 5-23](#), allows the user to upgrade the device with a different operating image.

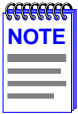

The user may also force the download of an image by changing the position of Switch 6 located inside the device. Refer to [Section C.2.1, **Setting the Mode Switch**](#), for details.

Before downloading an image to the device, copy the image to the network TFTP server.

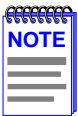

For information on how to set up a workstation as a TFTP server, refer to the specific workstation documentation.

To access the Flash Download screen from the Device Specific Configuration Menu screen, use the arrow keys to highlight the **FLASH DOWNLOAD** menu item and press ENTER. The Flash Download screen displays.

```

TFTP DOWNLOAD. WILL COMMIT TO FLASH. REBOOT IN PROGRESS...
                2E42-27 LOCAL MANAGEMENT

                        Flash Download

Device Type: 2E42-27                                Firmware Revision:  XX.XX.XX
                                                    BOOTPROM Revision: XX.XX.XX

Download Method:  [TFTP]
Reboot After Download:  [YES]
TFTP Gateway IP Addr:  134.141.79.123
Last Image Server IP:  134.141.79.121
Last Image File Name:  /ftpboot/2E42.hex
Download Server IP:    134.141.79.121
Download File Name:    /ftpboot/2E42.hex

EXECUTE                                EXIT                                RETURN
  
```

19601-49

Figure 5-23 Flash Download Screen



Download Server IP and Download Server Filename are displayed only when TFTP or RUNTIME is selected in Download Method.

The following briefly explains each field of the Flash Download screen:

Download Method (Selectable)

This field steps to **BOOTP**, **TFTP**, and **RUNTIME**. If set for BootP, the device sends out a BootP request to determine the IP address of the TFTP server and the file name of the image to be downloaded. If set for TFTP or RUNTIME, the 2E4X-27 attempts a TFTP download based on the IP address and file name entered in the fields at the bottom of the Flash Download screen. [Section 5.16.1](#) describes how to download using BootP. [Section 5.16.2](#) describes how to download using TFTP. [Section 5.16.3](#) describes how to download using Runtime.

Reboot After Download (Modifiable only when RUNTIME is chosen)

This field notifies the user that the 2E4X-27 will reboot after the download is complete. If a Runtime Download is performed, this field toggles between **YES** and **NO**. If **YES** is selected, the device reboots after the download is completed. If **NO** is selected, the device continues using the existing firmware image and stores the new firmware image in FLASH memory. When the device is reset or during the next power-up, the device will boot from FLASH memory using the new image.

TFTP Gateway IP Addr (Selectable)

This field shows the IP address of the TFTP gateway server defined in the General Configuration screen in [Section 5.7.4](#), Setting the TFTP Gateway IP Address.

Last Image Server IP (Read-only)

This field shows the IP address of the server used for the previous FLASH Download.

Last Image File Name (Read-only)

This field shows the complete path and file name of the last image downloaded to FLASH.

If **TFTP** or **RUNTIME** is selected as the download method ([Figure 5-23](#)), the following two additional fields appear:

Download Server IP (Selectable)

The IP address of the TFTP server to be used for the firmware image download is entered in this field.

Download File Name (Selectable)

The complete TFTP Server path and file name of the new image is entered in this field.

5.16.1 Image File Download Using BootP

To download a firmware image to FLASH memory of the 2E4X-27 using BootP, proceed as follows:

1. Use the arrow keys to highlight the **Download Method** field.
2. Use the SPACE bar to select **BOOTP**.
3. Use the arrow keys to highlight the **TFTP Gateway IP Addr** field.
4. Set the IP address of the TFTP gateway server (this defaults to the same IP address set in the **TFTP Gateway IP Addr** field in the General Configuration screen).
5. Use the arrow keys to highlight **EXECUTE** at the bottom of the screen and press ENTER. The message “BOOTP DOWNLOAD. WILL COMMIT TO FLASH. REBOOT IN PROGRESS...” displays in the event message line at the top of the screen and the new image is downloaded into FLASH memory.

5.16.2 Image File Download Using TFTP

To download a firmware image to FLASH memory of the 2E4X-27 using TFTP, proceed as follows:

1. Use the arrow keys to highlight the **Download Method** field.
2. Use the SPACE bar to select **TFTP**.
3. Use the arrow keys to highlight the TFTP Gateway IP Addr field.
4. Set the IP address of the TFTP gateway server (this defaults to the same IP address as that set in the TFTP Gateway IP Addr field on the General Configuration screen).
5. Use the arrow keys to highlight the **Download Server IP** field.

6. Enter the IP address of the TFTP server using the DDN format.
For example: 134.141.79.121
7. Use the arrow keys to highlight the **Download File Name** field.
8. Enter the complete pathway and file name of the image stored on the download server.
For example: **/tftpboot/2E42.hex**
9. Use the arrow keys to highlight **EXECUTE** at the bottom of the screen and press ENTER. The message “TFTP DOWNLOAD. WILL COMMIT TO FLASH. REBOOT IN PROGRESS...” displays in the event message line at the top of the screen and the new image is downloaded into FLASH memory.

5.16.3 Image File Download Using Runtime

To download a firmware image to FLASH memory of the 2E4X-27 using Runtime, proceed as follows:

1. Use the arrow keys to highlight the **Download Method** field.
2. Use the SPACE bar to select **RUNTIME**.
3. Use the arrow keys to highlight the **Reboot After Download** field.
4. Use the SPACE bar to select either **YES** or **NO**. Select **YES** if you want the device to reboot after the download is completed. Select **NO** if you want the device to store the new image in FLASH memory until the device is reset or during the next power-up.
5. Use the arrow keys to highlight the **TFTP Gateway IP Addr** field.
6. Set the IP address of the TFTP gateway server (this defaults to the same IP address as that set in the TFTP Gateway IP Addr field on the General Configuration screen).
7. Use the arrow keys to highlight the **Download Server IP** field.
8. Enter the IP address of the TFTP server using the DDN format.
For example: 134.141.79.121
9. Use the arrow keys to highlight the **Download File Name** field.

10. Enter the complete pathway and file name of the image stored on the download server.

For example: **/tftpboot/2E42.flb**

11. Use the arrow keys to highlight **EXECUTE** at the bottom of the screen and press ENTER. The message “TFTP DOWNLOAD. WILL COMMIT TO FLASH. REBOOT IN PROGRESS...” displays in the event message line at the top of the screen and the new image is downloaded into FLASH memory.

5.17 PORT REDIRECT FUNCTION SCREEN

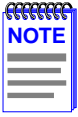

The Port Redirect Function screen may not be available depending on the operational mode setting of the device. Refer to the Release Notes to see which operational modes support the Port Redirect Function screen. **Section C.2.1, Setting the Mode Switch**, describes how to configure the device to operate in this mode.

The Port Redirect Function screen, **Figure 5-24**, allows the user to set each one of the ports 1 through 26 as a source or destination port. A port can be set to have one or more destination ports. For example, port 1 can be set as a source port with three destinations, ports 2, 3, and 4. Traffic from port 1 is then automatically redirected to ports 2, 3, and 4. Port 1 can also serve as a destination port for other ports.

The port redirect function is extremely useful for troubleshooting purposes, as it allows traffic to be sent to a particular port(s) where, with the use of an analyzer or RMON probe, all current traffic from the source port(s) can be examined.

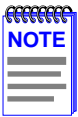

Although all traffic from the source port (including errored frames) is sent to the destination port, normal switching is still performed for all frames on the source port.

To access the Port Redirect Function screen from the Device Specific Configuration Menu screen, use the arrow keys to highlight the **PORT REDIRECT FUNCTION** menu item and press ENTER. The Port Redirect Function screen displays.

```

Event Message Line
                                2E42-27 LOCAL MANAGEMENT

                                Port Redirect Function

Device Type: 2E42-27                                Firmware Revision: XX.XX.XX
                                                    BOOTPROM Revision: XX.XX.XX

   Source Port:                Destination Port:          Remap Errors:
   -----
       1                            2                            ON
       1                            3                            ON
       1                            4                            ON
       2                            1                            OFF
       2                            3                            OFF
       3                            4                            ON
       3                            5                            ON
       3                            6                            ON

Source Port [1]                Destination Port [1]      Errors [ON]           Status [ADD]

SAVE                            NEXT          PREVIOUS          EXIT          RETURN
    
```

19602_22

Figure 5-24 Port Redirect Function Screen

The following definitions briefly explain each field of the Port Redirect Function screen:

Source Port (Read-only)

Shows which ports are currently set as source ports.

Destination Port (Read-only)

Shows which ports are currently set as destination ports.

Remap Errors (Read-only)

Displays whether the corresponding source ports are configured (ON) to send errored frames to the destination ports, or (OFF) to drop all errored frames and only forward traffic without errored frames to the destination ports.

Source Port [n] (Selectable)

Allows a selected port [n] to be changed to a source port.

Destination Port [n] (Selectable)

Allows a selected port [n] to be changed to a destination port.

Status (Toggle)

Allows the addition or deletion of source and destination ports selected in the Source Port [n] and Destination Port [n] fields.

5.17.1 Displaying the Source and Destination Entries

There can be more than one Port Redirect Function screen depending on the number of port redirect entries. Each screen displays up to 10 port redirect entries. If there is more than one screen of redirect entries, the **NEXT** and/or **PREVIOUS** command is displayed at the bottom of the screen, allowing the user to navigate to either the next or previous screen.

For example, with three screens of entries, the **NEXT** command displays at the bottom of the first screen. In the second screen, the **NEXT** and **PREVIOUS** commands are displayed. In the last screen, only the **PREVIOUS** command is displayed.

To display the next screen, use the arrow keys to highlight **NEXT**. Press **ENTER** and the next screen of entries is displayed.

To display the previous screen, use the arrow keys to highlight **PREVIOUS**. Press **ENTER** to view the entries in the previous screen.

5.17.2 Changing Source and Destination Ports

Add or delete source port and destination port entries as follows:

1. Use the arrow keys to highlight the **Source Port** field.
2. Press the **SPACE** bar or **BACKSPACE** one or more times to increment or decrement the port number displayed in the brackets [n] until the appropriate port number is displayed.
3. Use the arrow keys to highlight the **Destination Port** field.
4. Use the **SPACE** bar or **BACKSPACE** to step to the appropriate port number for the destination port.
5. Use the arrow keys to highlight the **Status** field.

6. Use the SPACE bar to select either the **ADD** or **DEL** (delete) and press ENTER. This adds or deletes the port selections made in steps 2 and 4 and also updates the screen Source Port and Destination Port list.



To redirect more than one port, repeat steps 1 through 6 for each additional setting, then go to step 7 to save all the new settings at once.

7. Use the arrow keys to highlight **SAVE** at the bottom of the screen. Press ENTER. The message “SAVED OK” is displayed. This saves the new settings and updates the Source Port and Destination Port read-only fields.

5.18 BROADCAST SUPPRESSION SCREEN

The Broadcast Suppression screen, [Figure 5-25](#), allows the user to set a desired limit of receive broadcast frames that are switched out to the other ports.



The Broadcast Suppression screen may not be available if the operational mode of the device is set to SECURE FAST VLAN or 802.1Q SWITCHING. Refer to the Release Notes to see which operational modes support the Broadcast Suppression screen. [Section 5.7.9, Setting the Operational Mode](#), describes how to configure the device to operate in this mode.

Broadcast frames received above the threshold setting are dropped.

To access the Broadcast Suppression screen from the Device Specific Configuration Menu screen, use the arrow keys to highlight the **BROADCAST SUPPRESSION** menu item and press ENTER. The Broadcast Suppression screen displays.

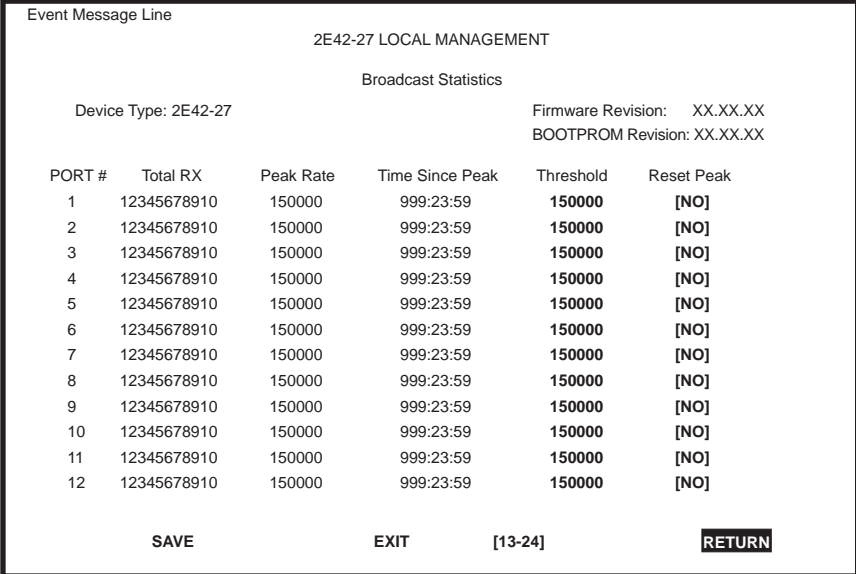

Event Message Line

2E42-27 LOCAL MANAGEMENT

Broadcast Statistics

Device Type: 2E42-27

Firmware Revision: XX.XX.XX
BOOTPROM Revision: XX.XX.XX

PORT #	Total RX	Peak Rate	Time Since Peak	Threshold	Reset Peak
1	12345678910	150000	999:23:59	150000	[NO]
2	12345678910	150000	999:23:59	150000	[NO]
3	12345678910	150000	999:23:59	150000	[NO]
4	12345678910	150000	999:23:59	150000	[NO]
5	12345678910	150000	999:23:59	150000	[NO]
6	12345678910	150000	999:23:59	150000	[NO]
7	12345678910	150000	999:23:59	150000	[NO]
8	12345678910	150000	999:23:59	150000	[NO]
9	12345678910	150000	999:23:59	150000	[NO]
10	12345678910	150000	999:23:59	150000	[NO]
11	12345678910	150000	999:23:59	150000	[NO]
12	12345678910	150000	999:23:59	150000	[NO]

SAVE EXIT [13-24] RETURN

19601-56

Figure 5-25 Broadcast Suppression/Statistics Screen

The following explains each field of the Broadcast Statistics screen:

PORT # (Read-only)

Identifies the number of the port.

Total RX (Read-Only)

Displays the total number of broadcast frames received.

Peak Rate (Read-Only)

Displays the highest number of broadcast frames received in a one second interval.

Time Since Peak (Read-Only)

Displays the time since peak rate was achieved.

Threshold (Modifiable)

Allows the user to set the desired limit of receive broadcast frames that will be forwarded per port per second.

Reset Peak (Toggle)

Allows the user to reset the Peak Rate. Resetting the Peak Rate also resets the Time Since Peak field. The Reset Peak field toggles between **YES** and **NO**.

[1-12] or [13-24] (Navigation Key)

When the Broadcast Suppression/Statistics screen displays, the current statistics are displayed for the first 12 ports. This field allows the user to step to a second screen for the same type of information for ports 13 through 24. While on the second screen, the user can navigate back to the first screen by highlighting the [1-12] field and pressing ENTER. The user can change the **Threshold** or **Reset Peak** fields while in either the first or second screen.

5.18.1 Setting the Threshold

To set the Threshold, proceed as follows:

1. Use the arrow keys to highlight the **Threshold** field for the selected port.
2. Type in the numbers for the desired limit. Only enter value in increments of ten (for example; 10, 20, 30, etc.).
3. Use the arrow keys to highlight the **SAVE** command at the bottom of the screen.
4. Press ENTER. The message "SAVED OK" displays.

5.18.2 Setting the Reset Peak

To set the Reset Peak field to YES or NO, proceed as follows:

1. Use the arrow keys to highlight the **Reset Peak** field for the selected port.
2. Press the SPACE bar to select **YES** or **NO**.

3. Use the arrows keys to highlight the **SAVE** command at the bottom of the screen.
4. Press ENTER. The message “SAVED OK” displays and the Time Since Peak field is also reset.

5.19 DEVICE STATISTICS MENU SCREEN

The Device Statistics Menu screen, [Figure 5-26](#), provides access to screens that allow the user to obtain switch statistics about frame traffic through each interface and view operating statistics about each port.

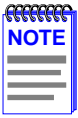

The following menu item on the Device Statistics Menu screen does not display if the operational mode of the device is set to SECURE FAST VLAN:

SWITCH STATISTICS

[Section 5.7.9](#) provides instructions on setting the operational mode.

To access the Device Statistics Menu from the Device Menu screen, use the arrow keys to highlight the **DEVICE STATISTICS** menu item and press ENTER. The Device Statistics Menu screen displays.

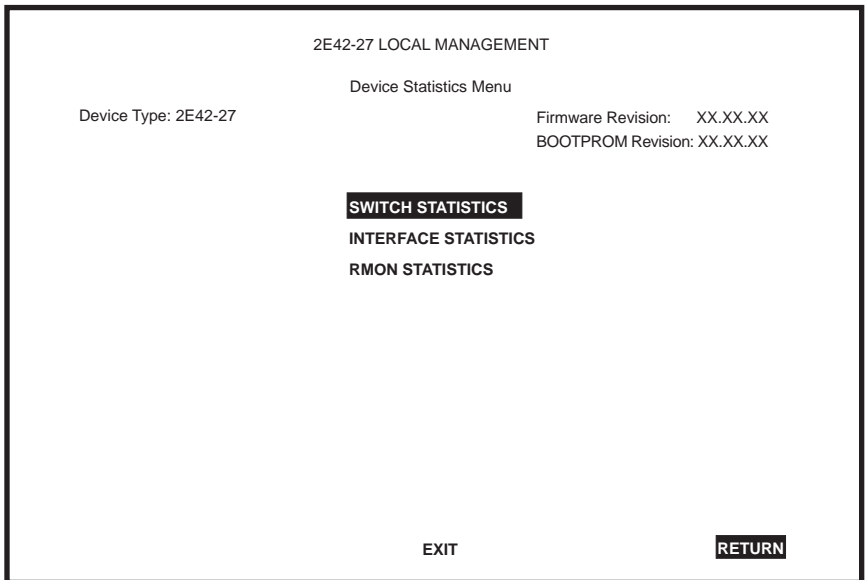

19602-67

Figure 5-26 Device Statistics Menu Screen

The Device Statistics Menu screen displays the following menu items:

SWITCH STATISTICS

The Switch Statistics screen lists the number of frames received, transmitted, filtered, and forwarded by each interface. For details, refer to [Section 5.20](#).

INTERFACE STATISTICS

The Interface Statistics screen provides the MIB-II statistics for each switched network interface, on a interface-by-interface basis. For details, refer to [Section 5.21](#).

RMON STATISTICS

The RMON Statistics screen displays all the statistics gathered by the embedded RMON agent built-in to the 2E4X-27. For details, refer to [Section 5.22](#).

5.20 SWITCH STATISTICS SCREEN

The Switch Statistics screen, [Figure 5-27](#), lists the number of frames received, transmitted, filtered, and forwarded by each interface.

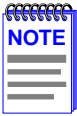

The Switch Statistics screen is not available if the operational mode of the device is set to SECURE FAST VLAN. This screen may only be used when the device is configured to operate as a traditional or 802.1Q switch.

To access the Switch Statistics screen from the Device Statistics Menu screen, use the arrow keys to highlight the **SWITCH STATISTICS** menu item and press ENTER. The Switch Statistics screen displays.

Event Message Line				
2E42-27 LOCAL MANAGEMENT				
Switch Statistics				
Device Type: 2E42-27		Firmware Revision: XX.XX.XX		
		BOOTPROM Revision: XX.XX.XX		
Interface #	Frames Rcvd	Frames Txmtd	Frames Fltrd	Frames Frwded
1	100	100	0	100
2	100	100	0	100
3	100	100	0	100
4	100	100	0	100
5	100	100	0	100
6	100	100	0	100
7	100	100	0	100
8	100	100	0	100
9	100	100	0	100
10	100	100	0	100
11	100	100	0	100
12	100	100	0	100
[13-24]		CLEAR COUNTERS	EXIT	RETURN

19601-26

Figure 5-27 Switch Statistics Screen

The Switch Statistics screen displays the following fields:

Interface # (Read-Only)

Identifies the interface or port number.

Frames Rcvd (Read-Only)

Displays the number of frames received by the interface since last power-up or reset.

Frames Txmtd (Read-Only)

Displays the number of frames transmitted by the interface since last power-up or reset.

Frames Fltrd (Read-Only)

Displays the number of frames filtered by the interface since last power-up or reset.

Frames Frwded (Read-Only)

Displays the number of frames forwarded by the interface.

[1-12], [13-24], or [25-27] (Navigation Key)

When the Switch Statistics screen displays, the statistics are displayed for the first 12 ports. These fields allow the user to step to a second or third screen for the same type of information for ports 13 through 24 or 25 through 27. While on the second or third screen, the user can navigate back to earlier screens by highlighting the [1-12] and/or [13-24] fields and pressing ENTER.

CLEAR COUNTERS (Command)

This command clears all the counters of the ports displayed to zero. To clear the counters, use the arrow keys to highlight **CLEAR COUNTERS** at the bottom of the screen, then press ENTER.

5.21 INTERFACE STATISTICS SCREEN

The Interface Statistics screen, [Figure 5-28](#), is used to gather MIB-II statistics for all the 2E4X-27 interfaces with the exception of an installed HSIM.



Cabletron Systems HSIMs gather their own statistics, and may be viewed via the Local Management screens of the applicable HSIM. Refer to your HSIM documentation for information on how to access these screens.

To access the Interface Statistics screen, use the arrow keys to highlight the **INTERFACE STATISTICS** menu item on the Device Statistics Menu screen and press ENTER. The Interface Statistics screen displays.

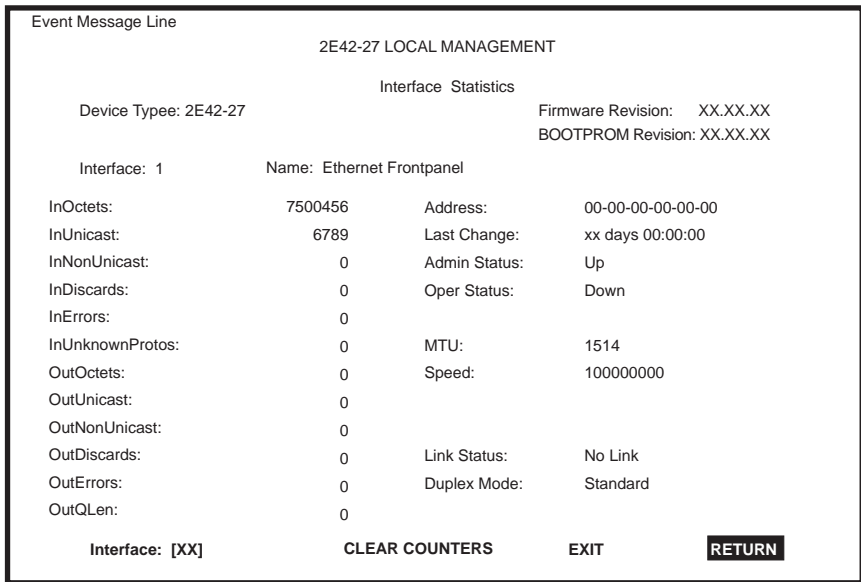

1960_64

Figure 5-28 Interface Statistics Screen

The following definitions explain each field of the Interface Statistics screen:

Interface (Read-Only)

This field displays the interface number for which statistics are currently being displayed. [Figure 5-28](#) shows the Interface field displaying 1. This represents the 10 Mbps interface of CONN 1. To view other interface statistics, refer to [Section 5.21.1](#).

Name (Read-Only)

The Name field displays the type of interface for which statistics are being displayed.

InOctets (Read-Only)

This field displays the total number of octets (bytes) that have been received on the interface. This includes all octets including bad frames, and framing characters.

InUnicast (Read-Only)

The InUnicast field displays the total number of frames that have been received that were sent to a single address.

InNonUnicast (Read-Only)

This field displays the total number of frames that have been received that were delivered to a broadcast or multicast address.

InDiscards (Read-Only)

The InDiscards field displays the total number of inbound frames that were discarded, even though the frames contained no errors. This field may increment because it was in an initialization phase and not ready to forward frames, the switch needed to free up buffer space, or the switch was being overutilized.

InErrors (Read-Only)

This field displays the total number of inbound frames that have been discarded because they contained errors. This field represents the total number of errored frames, regardless of the cause of the error.

InUnknownProtos (Read-Only)

The InUnknownProtos field displays the total number of frames that were discarded because the frames were in an unknown or unsupported format.

OutOctets (Read-Only)

This field displays the total number of octets (bytes) that have been transmitted from the interface.

OutUnicast (Read-Only)

The OutUnicast field displays the total number of frames transmitted that were sent to a single address.

OutNonUnicast (Read-Only)

This field displays the total number of frames transmitted to a broadcast or multicast address.

OutDiscards (Read-Only)

The OutDiscards field displays the total number of outbound frames that were discarded, even though the frames contained no errors. This field may increment, because the switch needed to free up buffer space, or the switch was being overutilized.

OutErrors (Read-Only)

This field displays the total number of outbound frames discarded because they contained errors. This field represents the total number of errored frames, regardless of the cause of the error.

OutQLen (Read-Only)

The OutQLen field displays the length of the frame queue. The field represents the total number of frames contained in queue.

Address (Read-Only)

This field displays the MAC address of the interface that is currently being displayed.

Last Change (Read-Only)

This field displays the last time that the interface was reset.

Admin Status (Read-Only)

This field displays the current status of the interface. If this field displays “Testing”, no frames may be passed on this interface.

Oper Status (Read-Only)

This field displays the current status of the interface. If this field displays “Testing”, no frames may be passed on this interface.

MTU (Read-Only)

The MTU field displays the maximum frame size (in octets) that a frame may contain to be received or transmitted from this interface.

Speed (Read-Only)

The Speed field displays the theoretical maximum of the interface's bandwidth in bits per second.

Link Status (Read-Only)

This field displays the current link status of the interface. This field displays either "Link" or "No Link".

Duplex Mode (Read-Only)

This field indicates whether the interface is operating in normal (standard) or full duplex mode. This field displays either "Standard" or "Full Duplex".

Interface [nn] (Command)

This command is used to enter an interface number for viewing statistics. For instructions on how to use this command, refer to [Section 5.21.1](#).

CLEAR COUNTERS (Command)

This command is used to reset all statistic counters to zero. For details on how to use this field, refer to [Section 5.21.2](#).

5.21.1 Displaying Interface Statistics

To display the statistics for any interface, proceed as follows:

1. Use the arrow keys to highlight the **Interface [nn]** field at the bottom of the screen.
2. Press the SPACE bar to increment (or press the DEL (delete) key to decrement) the interface number.
3. Press ENTER (neither the **Interface #** fields nor the statistics will change until ENTER is pressed).

5.21.2 Using the Clear Counters Command

To reset all the statistics counters of the selected interface to zero, perform the following steps:

1. Use the arrow keys to highlight the **CLEAR COUNTERS** field.
2. Press ENTER, the counters for the selected interface are reset to zero.

5.22 RMON STATISTICS SCREEN

RMON statistics for each interface, on an interface-by-interface basis, are viewed through the RMON Statistics screen shown in Figure 5-29.

Access the RMON Statistics screen by using the arrow keys to highlight the **RMON STATISTICS** field on the Device Statistics Menu screen and pressing ENTER. The RMON Statistics screen displays.

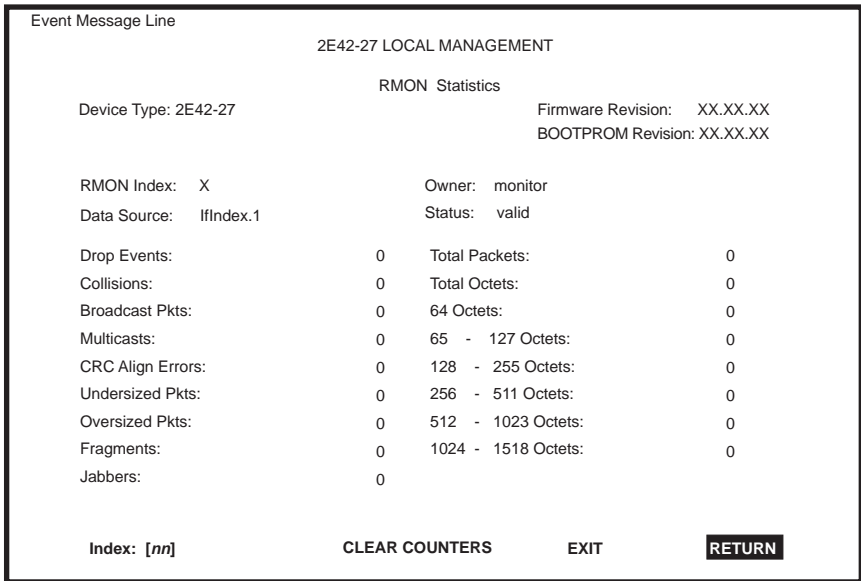

1960-65

Figure 5-29 RMON Statistics Screen

The following briefly defines each field of the RMON Statistics screen:

RMON Index (Read-only)

This field displays the current Ethernet interface for which statistics are being shown. The 2E4X-27 has an embedded RMON agent that gathers statistics for each of its interfaces.

Data Source (Read-only)

This field displays the source of the statistics data that is currently being displayed on the screen. Figure 5-29 shows that the data source for this RMON index is Interface 1 by displaying the name IfIndex.1. If the screen was displaying RMON statistics for Interface 4, the name displayed would be IfIndex.4.

Owner (Read-only)

This field displays the name of the entity that configured this entry.

Status (Read-only)

The Status field displays the current operating status of the displayed interface. This field displays “valid” or “invalid”.

Drop Events (Read-only)

This field displays the total number of times that the RMON agent was forced to discard frames due to the lack of available switch resources.



The Drop Events field does not display the number of frames dropped, it only displays the number of times that the RMON agent was forced to discard frames.

Collisions (Read-only)

This field displays the total number of collisions that have occurred on this interface.

Broadcast Pkts (Read-only)

The Broadcast Pkts field displays the total number of good frames that were directed to the broadcast address. The value of this field does not include multicast frames.

Multicasts (Read-only)

The Multicast field displays the total number of good frames received that were directed to a multicast address. The value of this field does not include frames directed to the broadcast address.

CRC Align Errors (Read-only)

This field displays the number of frames with bad Cyclic Redundancy Checks (CRC) received from the network. The CRC is a 4-byte field in the data frame that ensures that the data received is the same as the data that was originally sent.

Undersized Pkts (Read-only)

The Undersized Pkts field displays the number of frames received whose size was less than the minimum Ethernet frame size of 64 bytes, not including preamble, but have a valid CRC.

Oversized Pkts (Read-only)

The Oversized Pkts field displays the number of frames received whose size exceeded 1518 data bytes, not including preamble, but have a valid CRC.

Fragments (Read-only)

This field displays the number of received frames that are not the minimum number of bytes in length or received frames that had a bad Frame Check Sequence (FCS), were less than 64 bytes in length (excluding framing bits, but including FCS bytes), and have an invalid CRC.

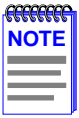

It is normal for the Fragments field to increment. This is because the RMON agent increments the field when runts are detected (which are normal occurrences due to collisions) and when noise hits occur.

Jabbers (Read-only)

This field displays the total number of frames that were greater than 1518 bytes and had either a bad FCS or a bad CRC.

Total Packets (Read-only)

This field displays the total number of frames (including bad frames, broadcast frames, and multicast frames) received on this interface.

Total Octets (Read-only)

This field displays the total number of octets (bytes) of data, including those in bad frames, received on this interface.

64 Octets (Read-only)

Displays the total number of frames, including bad frames, received that were 64 bytes in length (excluding framing bits, but including FCS bytes).

65 – 127 Octets (Read-only)

Displays the total number of frames, including bad frames, received that were between 65 and 127 bytes in length (excluding framing bits, but including FCS bytes).

128 – 255 Octets (Read-only)

Displays the total number of frames, including bad frames, received that were between 128 and 255 bytes in length (excluding framing bits, but including FCS bytes).

256 – 511 Octets (Read-only)

Displays the total number of frames, including bad frames, received that were between 256 and 511 bytes in length (excluding framing bits, but including FCS bytes).

512 – 1023 Octets (Read-only)

Displays the total number of frames, including bad frames, received that were between 512 and 1023 bytes in length (excluding framing bits, but including FCS bytes).

1024 – 1518 Octets (Read-only)

Displays the total number of frames, including bad frames, received that were between 1024 and 1518 bytes in length (excluding framing bits, but including FCS bytes).

Index [nn] (Command)

This command is used to enter an index number for viewing statistics. For instructions on how to use this command, refer to [Section 5.22.1](#).

CLEAR COUNTERS (Command)

This command is used to reset all statistic counters to zero. For details on how to use this command, refer to [Section 5.22.2](#).

5.22.1 Displaying RMON Statistics

To display the statistics for any index, proceed as follows:

1. Use the arrow keys to highlight the **Index [nn]** field at the bottom of the screen.
2. Press the SPACE bar to increment (or press the DEL (delete) key to decrement) the index number.
3. Press ENTER (neither the **RMON Index #** field nor the statistics will change until ENTER is pressed).

5.22.2 Using the Clear Counters Command

To reset all the statistics counters of the selected interface to zero, perform the following steps:

1. Use the arrow keys to highlight the **CLEAR COUNTERS** field.
2. Press ENTER, the counters for the selected index are reset to zero.

5.23 NETWORK TOOLS

The Network Tools function allows the user to access and manage network devices. [Figure 5-30](#) shows the Network Tools Help screen.

To access the Network Tools screen, use the arrow keys to highlight the **NETWORK TOOLS** menu item in the Device Menu screen and press ENTER. The Network Tools screen displays.

```
Welcome to Network Tools

-> help

Commands Available to User

Built in Commands:

arp          bridge      defroute
netstat      ping        reset
show        traceroute

soft_reset   telnet      link_trap
atm_stp_state

SPECIAL:
done, quit, or exit - Exit from the Network Tools.
For help with a specific command, type 'help <command>'.

->
```

090829

Figure 5-30 Network Tools Screen

The Network Tools functions are performed using a series of commands. Entering commands in Network Tools involves typing the command to be executed at the Network Tools prompt, adding any desired or required extensions, and pressing ENTER.

There are two categories of commands in the command set.

- Built-in Commands – Allow the user to access and manage network devices. The commands are: **arp**, **bridge**, **defroute**, **netstat**, **ping**, **reset**, **show**, **traceroute**, **soft-reset**, **telnet**, **link_trap**, and **atm_stp_state**.
- Special Commands – Allow the user to exit from Network Tools. The commands are **done**, **exit**, and **quit**.

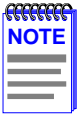

The conventions used in describing the commands in Network Tools are as follows:

Arguments enclosed by [] are required.

Arguments enclosed by < > are optional.

In the following command examples, the information entered by the user is shown in **bold** Helvetica font.

To abort the output or interrupt a process, press the CONTROL key and c key simultaneously, designated as ^C here.

The commands are presented in the following format:

command:

- | | |
|---------------------|---|
| Syntax: | Shows the required command format. It indicates where arguments, if any, must be specified. |
| Description: | Briefly describes the command and its uses. |
| Options: | Lists any additional fields in the appropriate format which may be added to the command. |
| Example: | Shows an example of the command. |

5.23.1 Built-in Commands

The built-in commands listed in this section activate functions on the LM managed device or devices being accessed through Network Tools.

arp:

Syntax: arp <options>

Description: The arp command provides access to the ARP (Address Resolution Protocol) cache, enabling you to view cache data, delete entries, or add a static route. Super-user access is required to delete an entry or add a static route.

Each ARP cache entry lists the network *interface* that the device is connected to, the device's *network address* or IP address, the device's *physical address* or MAC address, and the *media type* of connection to the device. Media types display as numbers, which stand for the following states:

- 1 - Other
- 2 - Invalid entry (cannot ping device, timed out, etc.)
- 3 - Dynamic route entry
- 4 - Static route entry (not subject to change)

You can specify the arp command without options, or with one of the following options:

Options:

- a Views cache data
- d Deletes an IP address entry. Requires additional arguments: <Interface Number> <IP address>
- s Adds a static entry. Requires additional arguments: <Interface Number> <IP address> <MAC address>
- f Flushes the ARP cache

Example:

```
-> arp -a
# Interface      Network Address  Physical Address  Media Type
# 30             122.144.40.111  00.00.0e.12.3c.04 3(dynamic)
# 30             122.144.48.109  00.00.0e.f3.3d.14 3(dynamic)
# 30             122.144.52.68   00.00.0e.12.3c.04 3(dynamic)
# 30             122.144.21.43   00.00.0e.03.1d.3c 3(dynamic)

-> arp -d 1 122.144.52.68

-> arp -s 1 22.44.2.3 00:00:0e:03:1d:3c

-> arp -f
```

05141-67

bridge:

Syntax:

bridge [ENABLE/DISABLE] [IFNUM/ALL]

Description:

The bridge command allows the bridge interface to be enabled or disabled at the user's request, either one at a time or all at once. Specifying a single interface number will affect the bridging status of that interface, while specifying ALL will affect every interface.

Options:

Not Applicable

Example:

```
-> bridge disable all

-> bridge enable 1

-> bridge disable 1
```

05141-68

defroute:

Syntax: defroute
defroute [interface number] [IP address]
defroute delete [interface number] [IP address]

Description: The defroute command allows the user, in the syntax order shown above, to view, set, or delete the default IP route to a managed device through the specified interface.

Options: Not Applicable

Example:

```
-> defroute 2 147.152.42.32
```

05141-69

netstat:

Syntax: netstat [option]

Description: The netstat command provides a display of general network statistics for the managed device. The netstat command must be used with one of the two display options.

Options:

- i Displays status and capability information for each interface.
- r Displays routing information for each interface.

Example:

```
-> netstat -i
Interface + Description  MTU    Speed    Admin   Oper    MAC Addr
# 1 (ethernet - csmacd) 1514   10000000 up      up      0x00 0x00 0x1d 0x07 0x50 0x0e
# 2 (ethernet - csmacd) 1514   10000000 up      up      0x00 0x00 0x1d 0x07 0x50 0x0f
# 3 (ethernet - csmacd) 1514   10000000 up      up      0x00 0x00 0x1d 0x07 0x50 0x10
# 4 (ethernet - csmacd) 1514   10000000 up      up      0x00 0x00 0x1d 0x07 0x50 0x11

-> netstat -r
Destination              Next-hop                Interface
# Default Route          DirectConnection        1
# 134.141.0.0            DirectConnection        2
# 134.141.0.0            DirectConnection        3
```

05141-70

ping:

Syntax: ping [IP address]

Description: The ping command generates an outbound ping request to check the status (alive/not alive) of a device at a specified IP address.

Options: Not Applicable

Example:

```
-> ping 122.144.40.10
122.144.40.10 is alive
```

05141-71

reset:

Syntax: reset**Description:** This reset command initiates a soft reset of the device. The reset command initializes the CPU processor, runs the onboard diagnostics, and restarts the software image, which restores the user configuration settings from NVRAM. The user will be queried to confirm the reset command to ensure against unwanted resets.

The Network Tools connection to the device will be terminated upon execution of this command.

Options: Not Applicable**Example:**

```
-> reset
```

17421-45

show:

Syntax: show <PROTOCOL> <TABLE>

Description: The show command displays information concerning various components of the device. Protocols currently supported are IP, IPX, DECnet, and AppleTalk. Components of those protocols that are currently supported are ARP caches, route tables, FIB tables, server tables, and interface tables. The number of valid entries in the table will be displayed at the end of the table display.

Options: Not Applicable

Example:

```
-> show Appletalk interfaces

# Interface  AdminStatus  OperStatus  MTU  Forwarding  Framing
# 1          enabled      enabled     1500  enabled     ethernet
# 2          disabled    disabled    1500  disabled    ethernet

-> show IP ARP

# Interface  MediaType  PhysicalAddress  NetworkAddress
# 3          3 (dynamic)  00:00:1d:04:40:5d  123.456.40.1
# 4          3 (dynamic)  08:00:20:0e:d8:31  123.456.40.30
```

17421-46

traceroute:

Syntax: traceroute [IP address]

Description: The traceroute command generates a TRACEROUTE request to a specified IP address and provides a display of all next-hop routers in the path to the device. If the device is not reached, the command displays all next-hop routers to the point of failure.

Options: Not Applicable

Example:

```
-> traceroute 122.144.11.52

# next-hop[0] : 122.144.60.45
# next-hop[1] : 122.144.8.113
# next-hop[2] : 122.144.61.45
# 122.144.11.52 is alive : 3 hops away.
```

05141-77

soft_reset:**Syntax:** soft_reset**Description:** This command restarts the software image, which restores the user configuration settings from NVRAM. The user will be queried to confirm the reset command to ensure against unwanted resets.

The Network Tools connection to the device will be terminated upon execution of this command.

Options: Not Applicable**Example:**

```
-> soft_reset
```

22511-76

telnet:

Syntax: telnet [IP address] [Port #]

Description: The telnet command allows the user to communicate with another host (that supports Telnet connections) using the Telnet protocol. The user must specify the remote host using its IP address. The [IP address] field is mandatory. If no Port number is specified, telnet will attempt to contact the host at the default port.

Options: Not Applicable

Example:

```
-> telnet 134.141.12.345
Trying 134.141.12.345
Connected to 134.141.12.345

SunOS UNIX (server1)

login:
```

2251-77

link_trap:

Syntax: link_trap [enable/disable/status] [PORT/all]

Description: The link_trap command allows link traps to be enabled or disabled when specifying a single port, or simultaneously when specifying “all” or no ports. When one or all ports are specified to enable, disable, or find their status, their current condition is displayed.

Options: Not Applicable

Example:

```

-> link_trap status
LINK TRAP STATUS:
    Port 1 is ENABLED      Port 2 is DISABLED
    Port 3 is ENABLED      Port 4 is ENABLED

-> link_trap disable 2
Link traps have been DISABLED on port 2

-> link_trap disable all
Link traps have been DISABLED on all ports (1-24)

-> link_trap status 3
Link traps are ENABLED on port 3

```

2314-78

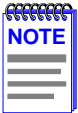
atm_stp_state:

The **atm_stp_state** command is only available if an HSIM-A6DP is installed in the device (e.g., 6E13X-25). This command allows the user to enable, disable, or check the current status of the Spanning Tree Algorithm on all ATM interfaces.

Syntax: `atm_stp_state [STATE]`

Description: The `atm_stp_state` command allows the user to enable, disable, or check the status of the Spanning Tree Algorithm on all ATM interfaces. The user must specify the `STATE` option as `enable`, `disable`, or `status`. The `STATE` field is mandatory.

Options: `enable`, `disable`, `status`

Example:

```

-> atm_stp_state status
Atm Stp is Enabled

-> atm_stp_state disable

-> atm_stp_state enable

```

2314-79

5.23.2 Special Commands

done, quit, exit:

Syntax: done, quit, or exit

Description: The done, quit, or exit command enables the user to exit from Network Tools and return to the Main Menu screen.

Options: Not Applicable

Example:

```
-> done  
  
Connection closed
```

05141-72

APPENDIX A

SPECIFICATIONS

This appendix provides operating specifications for the Cabletron Systems 2E4X-27. Cabletron Systems reserves the right to change these specifications at any time without notice.

A.1 DEVICE SPECIFICATIONS

Processor:	Intel i960 RISC processor
Dynamic Random Access Memory (DRAM):	16 MB
FLASH Memory:	4 MB

A.2 PHYSICAL PROPERTIES

Dimensions:	7.11H x 43.18W x 46.99D (cm) 2.8H x 17W x 18.5D (in)
Weight (Unit) 2E42-27/2E43-27:	3.18 kg (7 lb)
Weight (Unit) 2E42-27R/2E43-27R:	5.45 kg (12 lb)
MTBF (Predicted):	200,000 hours

A.3 ELECTRICAL SPECIFICATIONS

Line Input Range Volts (V)	Input Current Amperes (A)	Frequency Hertz (Hz)	Input Power Volt Amps (VA)
100–125 Vac	1.0 A	50/60 Hz	100 VA
200–240 Vac	0.5 A		

A.4 ENVIRONMENTAL REQUIREMENTS

- Operating Temperature: 5°C to 40°C (41°F to 104°F)
Storage Temperature: -30°C to 73°C (-22°F to 164°F)
Operating Relative Humidity: 5% to 90% (non-condensing)

A.5 INPUT/OUTPUT PORTS

- 2E42-27 and 2E42-27R,
Ports 1 through 24: Ethernet (10BASE-T compliant) with 24 RJ45 type connectors.
- 2E43-27 and 2E43-27R,
Ports 1 through 24: Ethernet (10BASE-T compliant) with RJ21 type connectors. Each connector provides connection for 12 twisted pair.
- Slots for optional ports 25 and 26: Slots accept three types of optional Fast Ethernet Interface Modules: the FE100-TX, the FE100-FX, and the FE100-F3.
- Slot for optional port 27: Slot accepts optional High Speed Interface Modules.

A.6 COM PORT/PIN ASSIGNMENTS

The COM port is a serial communications port that supports Local Management or connection to a UPS.

Table A-1 shows the COM port pin assignments.

Table A-1 COM Port Pin Assignments

Pin	Signal Name	Input/Output
1	Transmit Data (XMT)	Output
2	Data Carrier Detect (DCD)	Output
3	Data Set Ready (DSR)	Input
4	Receive Data (RCV)	Input
5	Signal Ground (GND)	NA
6	Data Terminal Ready (DTR)	Output
7	Request to Send (RTS)	Input
8	Clear to Send (CTS)	NA

A.7 REGULATORY COMPLIANCE

Safety	UL 1950, CSA C22.2 No. 950, EN 60950, IEC 950, and 73/23/EEC
Electromagnetic Compatibility (EMC)	FCC Part 15, EN 55022, CSA C108.8, EN 50082-1, AS/NZS 3548, VCCI V-3, and 89/336/EEC

APPENDIX B

FE-100TX, FE-100FX, AND FE-100F3 SPECIFICATIONS

The 2E4X-27 supports three Fast Ethernet Interface Modules:

- FE-100TX (Section B.1)
- FE-100FX (Section B.2)
- FE-100F3 (Section B.3)

This appendix provides the specifications for these modules.

B.1 FE-100TX

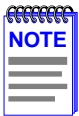

To ensure proper operation, use only Category 5 Unshielded Twisted Pair (UTP) cabling that has an impedance between 85 and 111 ohms.

The slide switch on the FE-100TX determines the crossover status of the cable pairs. If the switch is on the **X** side, the pairs are internally crossed over. If the switch is on the **=** side, the pairs are not internally crossed over. Figure B-1 shows the pinouts for the FE-100TX in both positions.

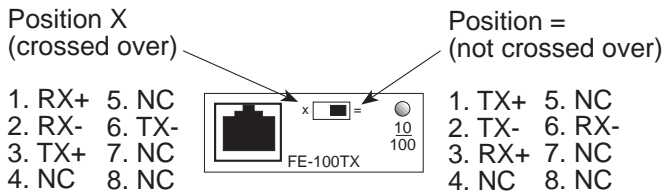

16651_05

Figure B-1 FE-100TX Pinouts

B.2 FE-100FX

The FE-100FX shown in **Figure B-2** uses an SC style connector that supports multimode fiber optic cabling. Specifications for the FE-100FX are listed in **Table B-1**, below.

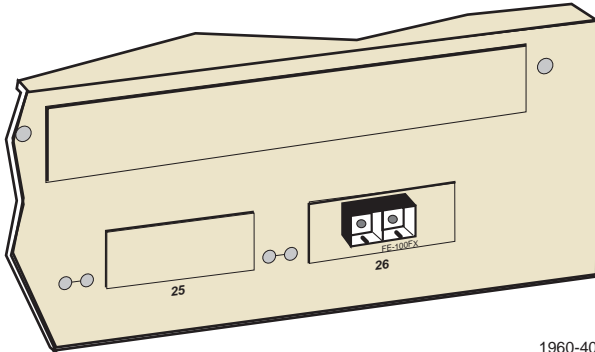
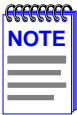

Figure B-2 FE-100FX

Table B-1 Transmitter Power

Cable Type	Worst Case Budget	Typical Budget
50/125 μm fiber optic	6.0 dB	9.0 dB
62.5/125 μm fiber optic	9.0 dB	12.0 dB
100/140 μm fiber optic	15.0 dB	18.0 dB



The transmitter power levels and receive sensitivity levels listed are peak power levels after optical overshoot. A peak power meter must be used to correctly compare the values given above to those measured on any particular port. If power levels are being measured with an average power meter, add 3 dB to the measurement to compare the measured values to the values listed above.

B.3 FE-100F3

The FE-100F3 shown in [Figure B-3](#) uses an SC style connector that supports single mode fiber optic cabling. Specifications for the FE-100F3 are listed in [Table B-2](#), below.

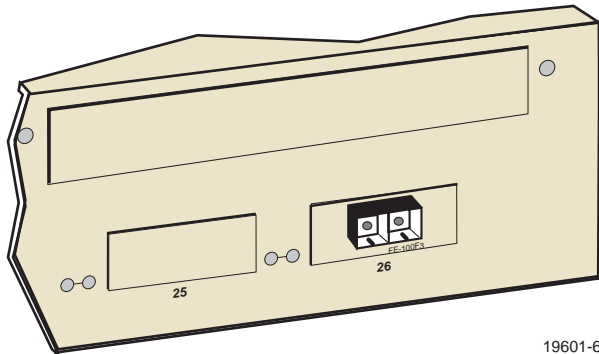
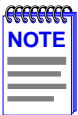

Figure B-3 FE-100F3

Table B-2 Transmitter Power

Cable Type	Worst Case Budget	Typical Budget
8/125 μm fiber optic	>10.0 dB	<10.0 dB
12.5/125 μm fiber optic	>10.0 dB	<10.0 dB



The transmitter power levels and receive sensitivity levels listed are peak power levels after optical overshoot. A peak power meter must be used to correctly compare the values given above to those measured on any particular port. If power levels are being measured with an average power meter, add 3 dB to the measurement to compare the measured values to the values listed above.

APPENDIX C

OPTIONAL INSTALLATIONS AND MODE SWITCH BANK SETTINGS



ONLY QUALIFIED SERVICE PERSONNEL SHOULD ATTEMPT THE FOLLOWING PROCEDURES.

NUR QUALIFIEZIERTE SERVICE PERSONNALL DIE FOLGENDE PROCEDURE FOLGEN SOLLTEN.

SOLAMENTE PERSONAL CALIFICADO DEBE INTENTAR ESTE PROCEDIMIENTO.

The top cover must be removed to gain access to the mode bank switches and to install the Fast Ethernet Interface Modules and the High Speed Interface Module.

This appendix covers the following items:

- Required tools ([Section C.1](#))
- Removing the chassis cover ([Section C.2](#))
- Locations, functions, and settings for the mode switches ([Section C.2.1](#))
- Installing Optional Fast Ethernet Interface Modules ([Section C.3](#))

C.1 REQUIRED TOOLS

You need the following tools to perform the procedures provided in this appendix:

- Antistatic wrist strap
- Phillips screwdriver

C.2 REMOVING THE CHASSIS COVER

This section describes how to remove the 2E4X-27 chassis cover.



DO NOT REMOVE THE COVER FROM THE 2E4X-27 WHILE POWER IS APPLIED TO THE UNIT. HAZARDOUS VOLTAGES ARE PRESENT AND COULD CAUSE PERSONAL INJURY AND/OR DAMAGE THE UNIT.

DO NOT POWER UP THE 2E4X-27 AGAIN UNTIL THE COVER AND SCREWS ARE IN PLACE.

DECKEL VON DAS 2E4X-27 NICHT ABZIEHEN UNTER SPANNUNG. GEFAHR FÜR DAS PERSONNAL UND/ODER DAS GERÄT WEGEN GEFÄHRLICHE SPANNUNGEN ENSTEHT.

2E4X-27 NICHEINSCHALTEN SO LANG DER DECKEL UND SCHRAUBEN NICHT EINGEBAUT SIND.

NO DEBE DE REMOVER LA TAPA DURENTE QUE ESTE CONELTADO A LA CORRIENTE, UNA DESCARGA ELECTRICA LE PUEDE CAUSAR Y PROBOCARLE DAÑOS, AL IGUAL QUE AL APARATO.

NO ENCHUFE A LA CORRIENTE HASTA QUE LA TAPA Y LOS TORNILLOS ESTEN EN SU LUGAR.



CAUTION: THIS UNIT MAY HAVE MORE THAN ONE POWER SUPPLY CORD. DISCONNECT TWO POWER SUPPLY CORDS BEFORE SERVICING TO AVOID ELECTRIC SHOCK.

VORSICHT: DIESES GERÄT HAT MEHR ALS EINEN NETZANSCHLUß. TRENNEN SIE VOR WARTUNGSARBEITEN DIE 2 NET ZANSCHLÜSSE VOM NETZ, UM ELEKTRISCHE SCHLÄGE ZU VERMEIDEN.

ATTENTION: CET APPAREIL COMPORTE PLUS D'UN CORDON D'ALIMENTATION. RAFIN DE PREVENIR LES CHOCS ELECTRIQUES, DEGRANCHER LES DEUX CORDONS D'ALIMENTATION AVANT DE FAIRE LE DEPANNAGE.

To remove the chassis cover, proceed as follows:

1. Disconnect the 2E4X-27 from the network as follows:
 - a. For the 2E42-27/2E43-27, unplug the power cord from the rear of the chassis. For the 2E42-27R/2E43-27R, unplug both power cords from the rear of the chassis.



TURN OFF THE 2E4X-27 BY UNPLUGGING THE POWER CORD FROM THE REAR OF THE CHASSIS.

AM HINTEN DES 2E4X-27 STECHEI ABZIEHEN UM AUS ZU SCHALTEN.

APAGUE EL 2E4X-27 DESENCUFE EL CABLE DE LA UNIDAD.



Before performing step b, mark the cables connected to the 2E4X-27 according to their associated port numbers. This is recommended for ease of reinstallation.

- b. Disconnect all network cables attached to the 2E4X-27.
2. If the 2E4X-27 is rack mounted, remove it from the rack and remove the rackmount brackets (refer to [Chapter 3, Installation](#)).

Appendix C: Optional Installations and Mode Switch Bank Settings

3. Use a Phillips screwdriver to remove the screws attaching the cover to the chassis. (See [Figure C-1](#).)
4. Remove the cover by sliding it back until it clears the front of the chassis and then lifting it straight up and off of the chassis.

To reinstall the chassis cover, perform the removal procedures in reverse.

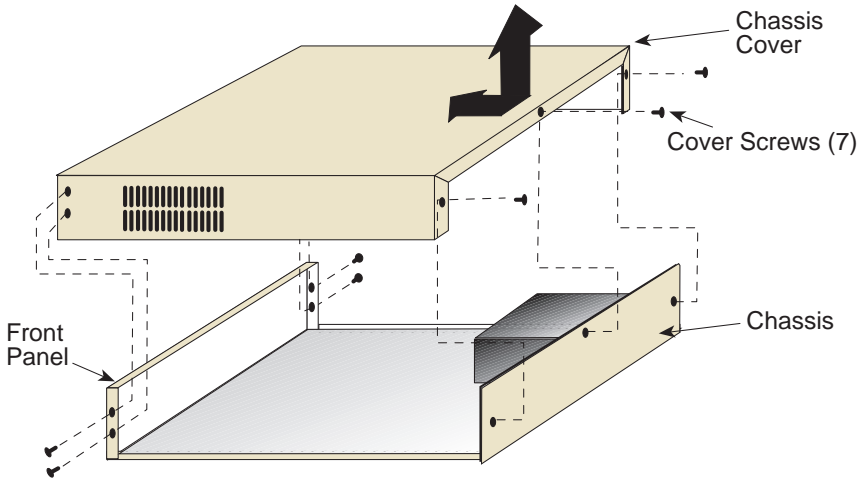

Note: If the device was rack mounted, the four screws fastening the cover to the front panel are removed and installed along with the rackmount brackets.

22511-3C

Figure C-1 Removing the Chassis Cover

C.2.1 Setting the Mode Switch

[Figure C-2](#) shows the location of the mode switches and the switch settings for normal operation. These switches are set at the factory and do not need to be changed.

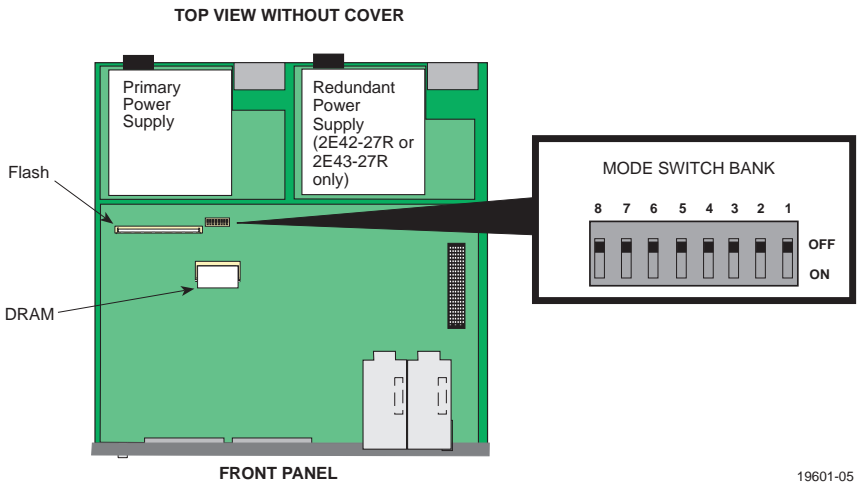

Figure C-2 2E4X-27 Mode Switch Location/Component Layout

Switch definitions and positions are as follows:

- Switches 1 through 4 – For Cabletron Systems use only.
- Switch 5 – COM Port Autobaoud. The default (OFF) position enables Autobaoud sensing on the COM port for Local Management sessions. Changing the switch to the ON position disables Autobaoud sensing and sets the COM port to 9600 baud for Local Management sessions.
- Switch 6 – Forced BootP. Do NOT attempt a Forced BootP unless a BootP server has been configured for the 2E4X-27. The BootP server references the location of a station acting as a Trivial File Transfer Protocol (TFTP) server containing the 2E4X-27 image file. When the position of Switch 6 is changed and the power is cycled to the 2E4X-27, the device requests the image file location from the BootP server and uses TFTP to download the image from the TFTP server. If one of these requirements is not met, the 2E4X-27 will continue to request either the BootP server or the TFTP server until the RESET button on the 2E4X-27 is pressed. Once the RESET button is pressed, the 2E4X-27 will reset after one minute and load the image stored in FLASH memory.

- **Switch 7 – Clear NVRAM.** Changing the position of this switch resets NVRAM on either the next power-up or the next operation of the front panel RESET button. All user-entered parameters, such as the IP address, device names, etc., are reset to the factory default settings. Once the 2E4X-27 resets, you can either use the factory default settings or re-enter your own parameters.
- **Switch 8 – Reset Password/Community Strings.** Changing the position of this switch clears user-entered passwords stored in NVRAM, and restores the factory default passwords on either the next power-up or the next operation of the front panel RESET button. Once the 2E4X-27 resets, you can either use the factory default settings or re-enter your own passwords.

C.3 INSTALLING OPTIONAL FAST ETHERNET INTERFACE MODULES

Figure C-3 shows the locations of the Fast Ethernet Interface Module connectors on for ports 25 and 26 and the High Speed Interface Module for port 27.

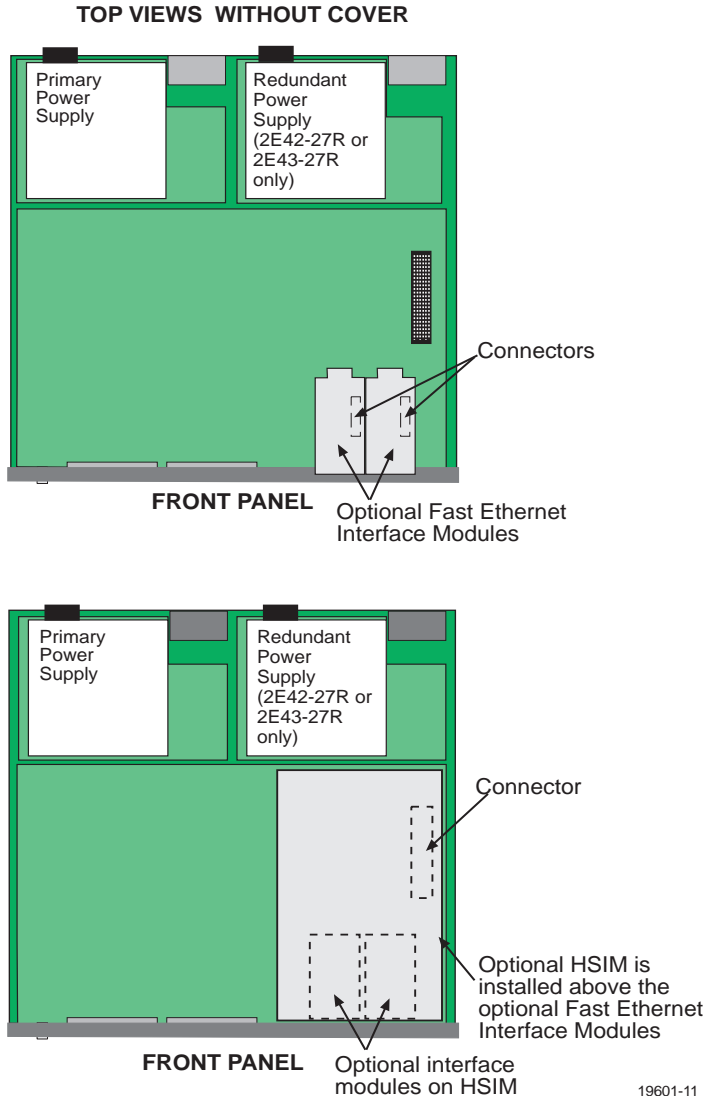

19601-11

Figure C-3 Fast Ethernet Interface Module Connector Location

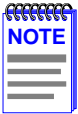

The installation instructions for the High Speed Interface Modules are in the associated user's guide.

To install a Fast Ethernet Interface Module in port slot 25 or 26, proceed as follows:



The FE-100F3 uses Class 1 lasers. Do not use optical instruments to view the laser output. The use of optical instruments to view laser output increases eye hazard. When viewing the output optical port, power must be removed from the network adapter.



The Fast Ethernet Interface Module and the 2E4X-27 are sensitive to static discharges. Use an antistatic wrist strap and observe all static precautions during this procedure. Failure to do so could damage the module or the 2E4X-27.



When installing Fast Ethernet Interface Modules in both port slots 25 and 26, remove the coverplates from both slot openings. In the following instructions, the optional module is shown being installed in port slot 26.

1. Remove the coverplate from the port slot where the Fast Ethernet Interface Module will be installed. Refer to [Figure C-4](#) and proceed as follows:
 - a. Remove the two screws fastening the coverplate to the standoffs. Save the screws.
 - b. Lift and remove the coverplate from the top of the front standoffs.

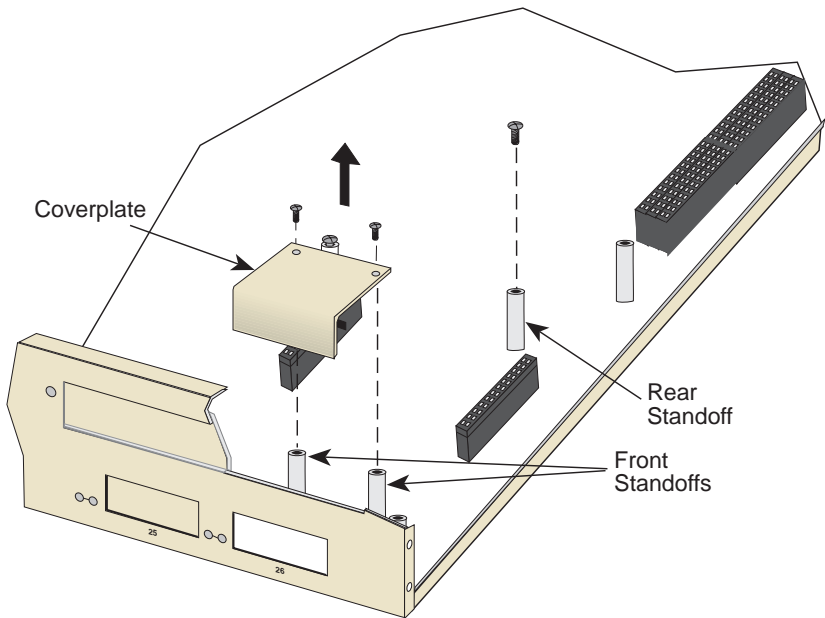

2251-38

Figure C-4 Coverplate Removal

2. Remove the screw from the rear standoff. Save the screw.



When installing an FE-100FX or FE-100F3 module into the 2E4X-27, remove the rubber plug on the module before proceeding.

3. See [Figure C-5](#). Gently pull the faceplate of the 2E4X-27 forward to allow room for the Fast Ethernet Interface Modules to be aligned over the connector.



In the following step, take care when inserting the Fast Ethernet Interface Module into the Motherboard connector, so that the pins do not bend. Otherwise, the Fast Ethernet Interface Board and the Motherboard could be damaged.

- Carefully lower the Fast Ethernet Interface Module onto the standoffs while inserting the module connector into the associated motherboard connector.

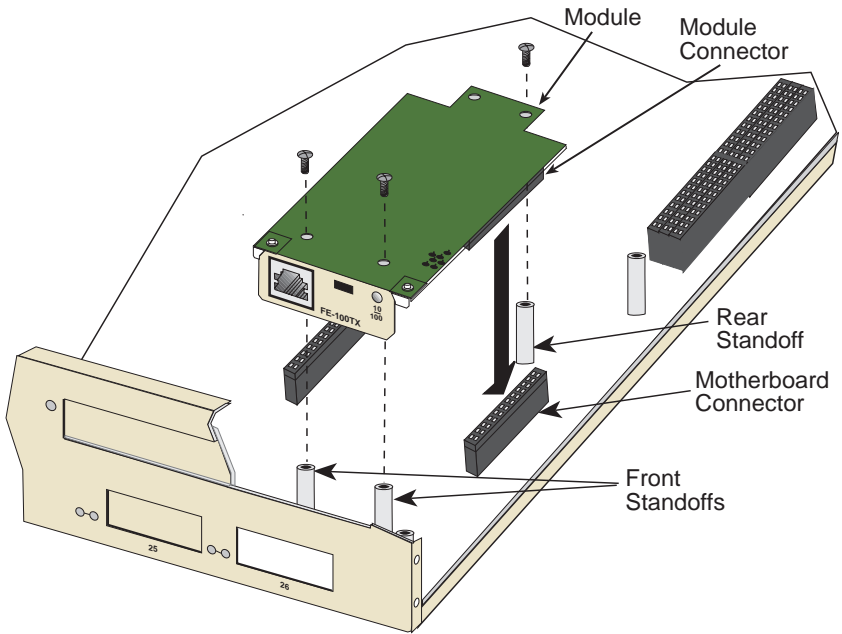

2251-39

Figure C-5 Installing the Fast Ethernet Interface Module

- Press down firmly on the Fast Ethernet Interface Module until the pins slide all the way into the motherboard connector. Ensure that the Fast Ethernet Interface Module seats flush on the standoffs.
- Secure the Fast Ethernet Interface Module with the screws saved in steps 1 and 2.
- Reinstall the cover.

INDEX

Numerics

- 100BASE-TX
 - cable length 2-2
- 10BASE-T
 - connection 3-9
 - requirements 2-1
- 2E4X-27
 - front panel 1-2
 - overview of 1-4
- 802.1D switching
 - setting operational mode for 5-25
- 802.1D switching mode
 - hierarchy of 5-9
- 802.1Q switching
 - setting operational mode for 5-25
- 802.1Q switching mode
 - hierarchy of 5-9

A

- Access policy 5-32
- Age time 5-37

B

- Bridge Configuration screen
 - state 5-37
- Broadcast Suppression screen 5-61
 - peak rate 5-62
 - port # 5-62
 - reset peak 5-63
 - threshold 5-63
 - time since peak 5-62
 - total RX 5-62
- Built-in Commands
 - use of 5-77

C

- Cable Connections 3-10
- Cable specifications
 - 100BASE-FX MMF 2-2
 - 100BASE-T network 2-1
 - 100BASE-TX network 2-2

- Chassis Cover, removal of C-2
- COM port 5-26
 - pin assignments A-3
- Com Port Application 5-28
- Command Set 5-77
- Connecting to the network 3-9
- Crossover switch B-1

D

- Default gateway 5-17, 5-21
- Device Configuration screen 5-14
- Device date 5-17
- Device Menu screen 5-12
- Device Specific Configuration Menu screen 5-42
- Device Statistics Menu screen 5-64
 - bridge statistics 5-65
- Device time 5-17
- Document conventions 1-9

E

- Environmental requirements A-2
- Ethernet Full Duplex Configuration screen 5-39

F

- FE-100F3
 - transmitter specifications B-3
- FE-100FX
 - transmitter specifications B-2
- FE-100TX
 - RJ45 pinouts B-1
- Fiber connection
 - SC to SC 3-15
- Flash Download screen 5-53
 - download file name 5-55
 - download method 5-54
 - download serverIP 5-55
 - last image file name 5-54
 - last image serverIP 5-54
 - reboot after download 5-54

- TFTP gateway IP addr 5-54
- Full Duplex Configuration screen
 - full duplex 5-40
 - link status 5-40
 - operation mode 5-40, 5-41
 - port status 5-40
 - standard enet 5-40

G

- General Configuration screen 5-16
 - application 5-18
 - COM port 5-26
 - default gateway 5-17, 5-21
 - device date 5-17
 - device time 5-17, 5-23
 - IP address 5-16, 5-19
 - MAC address 5-16
 - operational mode 5-18, 5-25
 - screen lock-out time 5-17, 5-24
 - screen refresh time 5-17, 5-24
 - subnet mask 5-17, 5-20

H

- Help 1-10
 - related manuals 1-11
- Hierarchy
 - 802.1D switching mode 5-9
 - 802.1Q switching mode 5-9
 - SecureFast VLAN mode 5-10
- High Speed Configuration Interface screen 5-48
- High Speed Interface Configuration
 - Menu screen 5-46
- High Speed Interface screen
 - advertised ability 5-50
 - configuring an FE-100FX 5-51
 - configuring an FE-100TX 5-51
 - current operational mode 5-49
 - desired operational mode 5-50
 - link status 5-49
 - port type 5-49
 - setting the FE-100FX 5-51
 - setting the FE-100TX 5-51

I

- Installation
 - connecting to the network 3-9
 - Fast Ethernet Interface Module C-7
- Interface Statistics screen
 - address 5-70
 - admin status 5-70
 - CLEAR COUNTERS 5-71
 - duplex mode 5-71
 - InDiscards 5-69
 - InErrors 5-69
 - InNonUnicast 5-69
 - InOctets 5-69
 - interface 5-68, 5-71
 - InUnicast 5-69
 - InUnknownProtos 5-69
 - last change 5-70
 - link status 5-71
 - MTU 5-70
 - name 5-68
 - oper status 5-70
 - OutDiscards 5-70
 - OutErrors 5-70
 - OutNonUnicast 5-70
 - OutOctets 5-69
 - OutQLen 5-70
 - OutUnicast 5-69
 - speed 5-71
- IP address 5-16, 5-19
- IP Fragmentation 5-19
 - enabling/disabling of 5-30

K

- Keyboard conventions 5-2

L

- LANVIEW LEDs 4-1
- Local Management
 - introduction to 1-6
 - Password screen 5-7

M

- Management

use of 1-6
Management Terminal
 COM port connection of 5-3, 5-4
 setup of 5-3, 5-5
Mode Switch
 setting C-4

N

Network connection
 FE-100FX/FE-100F3 3-15
 FX-100TX 3-13
 installation of 3-9
Network Tools
 built-in commands 5-77
 arp 5-79
 atm_stp_state 5-87
 bridge 5-80
 defroute 5-81
 netstat 5-82
 ping 5-82
 reset 5-83
 show 5-84
 soft_reset 5-85
 telnet 5-86
 traceroute 5-84
 description of 5-76
 special commands 5-77
 done 5-88
 exit 5-88
 quit 5-88
Network Tools screen
 accessing of 5-76
NVRAM
 clearing of 5-29

P

Password screen 5-7
Passwords 5-31

Physical properties A-1
Port Redirect Function screen
 destination port 5-59
 remap errors 5-59
 source port 5-59

R

Regulatory Compliance A-3
RESET button 4-7
RMON Statistics screen
 1024 – 1518 octets 5-75
 128 – 255 octets 5-75
 256 – 511 octets 5-75
 512 – 1023 octets 5-75
 64 octets 5-74
 65 – 127 5-74
 65 – 127 octets 5-74
 broadcast pkts 5-73
 CLEAR COUNTERS 5-75
 collisions 5-73
 CRC align errors 5-73
 data source 5-72
 drop events 5-73
 fragments 5-74
 index 5-75
 jabbers 5-74
 multicasts 5-73
 oversize packets 5-74
 owner 5-73
 RMON index 5-72
 status 5-73
 total octets 5-74
 total packets 5-74
 undersize packets 5-73
Runtime IP address discovery 1-6

S

Safety information

- laser iv
 - Screen lock-out time 5-17, 5-24
 - Screen refresh time 5-24
 - Screens
 - Broadcast Suppression screen 5-61
 - Device Configuration screen 5-14
 - Device Menu screen 5-12
 - Device Specific Configuration
 - Menu screen 5-42
 - Device Statistics Menu screen 5-64
 - Ethernet Full Duplex Configuration screen 5-39
 - Flash Download screen 5-53
 - General Configuration screen 5-16
 - hierarchy of 5-8
 - High Speed Interface Configuration
 - Menu screen 5-46
 - High Speed Interface Configuration screen 5-48
 - Network Tools screen 5-76
 - Password screen 5-7
 - Port Redirect Function screen 5-58
 - Port Statistics screen 5-67
 - RMON Statistics screen 5-72
 - SNMP Community Names
 - screen 5-31
 - SNMP Traps screen 5-34
 - Switch Configuration screen 5-36
 - Switch Statistics screen 5-66
 - System Resources screen 5-44
 - SecureFast VLAN mode
 - hierarchy of 5-10
 - setting operational mode for 5-25
 - Setup of
 - management terminal 5-5
 - SmartTrunk
 - introduction to 1-5
 - SNMP Community Names
 - screen 5-31
 - access policy 5-32
 - community name 5-32
 - SNMP Traps screen 5-34
 - enable traps 5-35
 - trap community name 5-34
 - trap destination 5-34
 - trap table configuration 5-35
 - Spanning Tree Algorithm 5-37
 - Special Commands
 - use of 5-77
 - Special Commands, Network Tools 5-88
 - Specifications A-1
 - Standards compatibility 1-7
 - Subnet mask 5-17, 5-20
 - Switch address 5-36
 - Switch Configuration screen 5-36
 - age time 5-37, 5-38
 - MAC address 5-37
 - number of ports 5-37
 - port # 5-37
 - port status 5-38
 - selecting the STA 5-38
 - status 5-38
 - switch address 5-36
 - type of STA 5-37
 - Switch Statistics screen 5-66
 - clearing counters 5-67
 - frames fltrd 5-67
 - frames frwdd 5-67
 - frames rcvd 5-67
 - frames txmtd 5-67
 - interface # 5-66
 - System Resources screen
 - CPU type 5-45
 - current switch utilization 5-46
 - DRAM installed 5-45
 - Flash memory installed 5-45
 - NVRAM installed 5-46
 - peak switch utilization 5-46
 - reset peak switch utilization 5-46
- ## T
- TFTP gateway IP addr 5-54
 - Trap table configuration 5-35
 - Traps
 - enable 5-35

Troubleshooting 4-1
 checklist 4-6

U

Uninterruptible Power Supply
 connection of 5-6
Unpacking 3-2

V

VLAN
 configuration of 5-44

Free Manuals Download Website

<http://myh66.com>

<http://usermanuals.us>

<http://www.somanuals.com>

<http://www.4manuals.cc>

<http://www.manual-lib.com>

<http://www.404manual.com>

<http://www.luxmanual.com>

<http://aubethermostatmanual.com>

Golf course search by state

<http://golfingnear.com>

Email search by domain

<http://emailbydomain.com>

Auto manuals search

<http://auto.somanuals.com>

TV manuals search

<http://tv.somanuals.com>