



installation, start-up, and operating instructions

LOW-BOY OIL-FIRED FURNACE

362AAN

Series B

Cancels: II 362A-75-1 II 362A-105-1
8-96

NOTE: Read the entire instruction manual before starting the installation.

This symbol → indicates a change since the last issue.

Index	Page
SAFETY CONSIDERATIONS.....	1-2
Minimum Clearance to Combustibles.....	2
INTRODUCTION.....	2
LOCATION.....	2-3
Air for Combustion and Ventilation.....	2-3
Duct Work Recommendations.....	3
VENTING INSTRUCTIONS.....	4
Pre-Installation Vent System Inspection.....	4
Masonry Chimney.....	4
Factory-Built Chimneys.....	4
Horizontal Venting.....	4
OIL BURNER.....	4
OIL CONNECTIONS.....	4
BAROMETRIC DRAFT CONTROL.....	4
ELECTRICAL.....	5
FILTERS.....	5
OPERATIONAL CHECKOUT.....	5-6
Start-Up.....	5
Recommended Installation Practices and Combustion Check.....	5-6
Fan Adjustment Check.....	6
Limit Control Check.....	6
For Year-Round Air Conditioning.....	6
Heating.....	6
Cooling.....	6
Constant Blower Switch.....	6
MAINTENANCE.....	6-11
General.....	6
Oil Burner.....	6-7
Heat Exchanger and Flue Pipe.....	7-8
Blower Oiling and Removal.....	8
Keeping Filters Clean.....	8
Airflow Data.....	8
Dimensional Drawing.....	9
Barometric Damper Locations.....	10
Wiring Diagram.....	11
USER'S INFORMATION.....	12
Here's How Your Heating System Works.....	12
Preparing Your Furnace For Operation.....	12
Lighting Your Furnace.....	12
Turning Off Your Furnace.....	12

SAFETY CONSIDERATIONS

FOR YOUR SAFETY

DO NOT STORE OR USE GASOLINE OR OTHER FLAMMABLE VAPORS AND LIQUIDS IN THE VICINITY OF THIS OR ANY OTHER APPLIANCE.

DO NOT ATTEMPT TO START THE BURNER WHEN EXCESS OIL HAS ACCUMULATED, WHEN THE FURNACE IS FULL OF VAPOR, OR WHEN THE COMBUSTION CHAMBER IS VERY HOT.

→  **WARNING:** For use with grade 2 Fuel Oil maximum. Do not use Gasoline, Crankcase Oil, or any Oil containing Gasoline! Failure to follow this warning could lead to sooting, fire, explosion, and/or severe bodily harm.

→  **CAUTION:** Never burn garbage or paper in the heating system and never leave rags, paper, or any flammable items around the unit.

 **CAUTION:** These instructions are intended to be used by qualified personnel who have been trained in installing this type of furnace. Installation of this furnace by an unqualified person may lead to equipment damage and/or a hazardous condition which may lead to bodily harm.

All local and national code requirements governing installation of oil burning equipment, wiring, and flue connections must be followed. Some of the codes (issued by the Canadian Standards Association, the National Fire Protection Agency, and/or the American National Standards Institute) that may be applicable are:

- ANSI/NFPA 31 INSTALLATION OF OIL BURNING EQUIPMENT
- ANSI/NFPA 211 CHIMNEYS, FIREPLACES, VENTS, AND SOLID FUEL BURNING APPLIANCES
- ANSI/NFPA 90B WARM AIR HEATING AND AIR CONDITIONING SYSTEMS
- ANSI/NFPA 70 NATIONAL ELECTRICAL CODE
- CSA B139 INSTALLATION CODE FOR OIL BURNING EQUIPMENT
- CSA C22.1 CANADIAN ELECTRICAL CODE

Only the latest issues of above codes should be used, and are available from either The National Fire Protection Agency, Batterymarch Park, Quincy, MA 02269 or The Canadian Standards Association, 178 Rexdale Blvd., Rexdale, Ontario M9W 1R3

Recognize safety information. This is the safety-alert symbol . When you see this symbol on the furnace and in instructions or manuals, be alert to the potential for personal injury.

Understand the signal words DANGER, WARNING, and CAUTION. These words are used with the safety-alert symbol. DANGER identifies the most serious hazards which **will** result in severe personal injury or death. WARNING signifies a hazard which **could** result in personal injury or death. CAUTION is used to identify unsafe practices which **would** result in minor personal injury or product and property damage.

TABLE 1—MINIMUM CLEARANCES TO COMBUSTIBLE MATERIALS (IN.)

UNIT APPLICATION		LOW-BOY
Sides	Furnace	0
	Supply Plenum and Warm-Air Duct Within 6 ft of Furnace	1
Back		0
Top	Furnace Casing or Plenum	2
	Horizontal Warm-Air Duct Within 6 ft of Furnace	2
Bottom		0*
Flue	Horizontally or Below Pipe	4
Pipe	Vertically Above Pipe	8
Front		8

* Floor may be combustible.

NOTE: Adequate service clearance should be provided over and above these dimensions as required.

INTRODUCTION

→ The model 362AAN Furnaces are available in sizes 105,000 through 155,000 Btuh input capacities.

The furnace is shipped as a packaged unit, complete with burner and controls. It requires a line voltage (115 vac) connection to control box, a thermostat hook-up as shown on wiring diagram, oil line connection(s), adequate duct work, and connection to a properly sized vent.

The air handling capacity of this furnace is designed for cooling airflow. Refer to Table 5 for expected airflows at various external duct static pressures.

LOCATION

 **WARNING:** This furnace is not water tight and is not designed for outdoor installation. This furnace shall be installed in such a manner as to protect electrical components from water. Outdoor installation would lead to a hazardous electrical condition and to premature furnace failure.

 **WARNING:** Do not use this furnace as a construction heater. Use of this furnace as a construction heater exposes furnace to abnormal conditions, contaminated combustion air, and lack of air filters. Failure to follow this warning can lead to premature furnace failure and/or vent failure which could result in a fire hazard and/or bodily harm.

This furnace is approved for reduced clearances to combustible construction, therefore, it may be installed in a closet or similar enclosure. It may be located in a basement or on the same level as area to be heated. In any case, unit should always be installed level.

In a basement or when installed on the floor, it is recommended that unit be installed on a concrete pad that is 1- to 2-in. thick.

On dirt floors, furnace may be installed on concrete blocks. Place blocks under all 4 corners and under center of furnace. Center block 22 in. from back of furnace forward.

The required minimum clearances for this furnace are specified in Table 1.

The furnace should be located as close as possible to chimney or vent in order to keep vent connections short and direct. The furnace should also be located as near as possible to center of air distribution system.

I. AIR FOR COMBUSTION AND VENTILATION

 **WARNING:** Installation of this furnace in an area where it will receive contaminated combustion air must be avoided. Such contamination would include the following: ammonia, chlorine, hydrogen sulfide, halogenated hydrocarbons, carbon tetrachloride, cleaning solvents, hydrochloric acid, water softening chemicals, and similar chemicals. Failure to follow this warning will lead to premature rusting of heat exchanger and possible premature furnace failure and/or vent failure which could result in fire hazard and/or bodily harm.

→ This furnace should be installed in a location in which facilities for ventilation permit satisfactory combustion of oil, proper venting, and maintenance of ambient temperature at safe limits under normal conditions of use. The location should not interfere with proper circulation of air within the confined space. (See NFPA-31, Section 1.5.)

In addition to air needed for combustion, process air shall be provided as required for: cooling of equipment or material, controlling dew point, heating, drying, oxidation or dilution, safety exhaust, and odor control.

In addition to air needed for combustion, air shall be supplied for ventilation, including all air required for comfort and proper working conditions for personnel.

The barometric draft regulator (included with furnace) shall be installed in same room or enclosure as furnace in such a manner as to prevent any difference in pressure between regulator and combustion-air supply.

Air requirements for operation of exhaust fans, kitchen ventilation systems, clothes dryers, and fireplaces shall be considered in determining the adequacy of a space to provide combustion-air requirements.

→ In unconfined spaces in buildings of conventional frame, brick, or stone construction, infiltration MAY be adequate to provide air for combustion, ventilation, and dilution of flue gases. This determination must be made on an individual installation basis and must take into consideration the overall volume of unconfined space, the number of windows and ventilation openings, the number of doors to the outside, internal doors which can close off unconfined space, and overall tightness of building construction. Consideration must also be given to the amount of storage items (furniture, boxes, etc.) within the unconfined space which take away from the air volume. Many new buildings and homes (and older ones that have been weatherized) MUST BE considered as being of tight construction, therefore, infiltration will not be sufficient to supply necessary air for combustion and ventilation.

A building can be considered as being of tight construction when:

1. Walls and ceilings exposed to outside atmosphere have a continuous water vapor retarder with a rating of 1 perm or less with openings gasketed or sealed, and/or
2. Weatherstripping has been added on operable windows and doors, and/or

3. Caulking or sealants are applied to areas such as joints around window and door frames; between sole plates and floors; between wall-ceiling joints; between wall panels; at penetrations for plumbing, electrical, and fuel lines; and at other openings.

If combustion and ventilation air must be supplied to an unconfined space from outside, an opening with a FREE AREA of not less than 1 sq in. per 1000 Btuh of total input of all appliances within unconfined space (but not less than 100 sq in.) must be provided. This opening must be located such that it can not be blocked at any time.

When furnace is installed in a closet or enclosure, 2 ventilation openings, with OPEN AREA as dimensioned in example below are required for combustion air. The openings should be located about 6 in. from top and bottom of enclosure at front of furnace.

→ For Example:

UNIT SIZE	LENGTH (IN.)	HEIGHT (IN.)
036105	18	9
048125	20	10
060155	20	10

For a confined space, where air is taken from an interior space, 2 permanent openings of equal area are required. One opening must be within 12 in. of ceiling and the other within 12 in. of floor. Each opening must have a free area of at least 1 sq in. per 1000 Btuh of total input rating but not less than 100 sq in.

If outside air is supplied to a confined space, then the 2 openings must be equal and located as above. The free area of each must be:

1. One sq in. per 4000 Btuh of total input rating when air is directly communicated from outdoors.
2. One sq in. per 4000 Btuh of total input rating when air is brought in through vertical ducts.
3. One sq in. per 2000 Btuh of total input rating when air is transferred through horizontal ducts.

When ducts are used to supply air, they must be of the same cross sectional area as free area of openings to which they connect.

The minimum dimension of rectangular air ducts must not be less than 3 in.

In calculating free area, consideration shall be given to blocking effect of louvers, grilles, or screens protecting openings. Screens used shall not be smaller than 1/4-in. mesh and shall be readily accessible for cleaning. If free area through a design of louver or grille is known, it shall be used in calculating size design and free area specified. If design and free area are not known, it may be assumed that wood louvers have 20 percent free area and metal louvers and grilles have 60 percent free area. Louvers shall be fixed in open position or interlocked with furnace so they open automatically at furnace start-up and remain open during furnace operation.

⚠	WARNING: Do not block combustion-air openings in the furnace. Any blockage will result in improper combustion which may result in a fire hazard and/or cause bodily harm.
---	--

→ The lack of a proper amount of combustion air can lead to serious furnace operational problems. Some of these problems are:

1. Excessive oil burner after drip and oil fumes.
2. Sooting.
3. Melted oil burner couplings and/or ignitor/relay control.
4. A condition where air band or air shutter settings must be more open than normal to achieve proper combustion.

5. Lockouts on start-up.

II. DUCT WORK RECOMMENDATIONS

The proper sizing of warm air ducts is necessary to ensure satisfactory furnace operation. Duct work should be in accordance with the latest editions of NFPA-90A (Installation of Air Conditioning and Ventilating Systems) and NFPA-90B (Warm Air Heating and Air Conditioning Systems) or Canadian equivalent.

The supply duct work should be attached to flanged opening provided at discharge end of furnace. See Fig. 5 for dimensions of this opening.

The following recommendations should be followed when installing duct work:

1. Install locking-type dampers in all branches of individual ducts to balance out system. Dampers should be adjusted to impose proper static at outlet of furnace.
2. A flexible duct connector of noncombustible material should be installed at unit on both supply- and return-air systems. In applications where extremely quiet operation is necessary, the first 10 ft (if possible) of supply and return ducts should be internally lined with acoustical material.
3. In cases where return-air grille is located close to fan inlet, there should be at least one 90° air turn between fan inlet and grille. Further reduction in sound level can be accomplished by installing acoustical air turning vanes or lining duct as described in item 2 above.
4. When a single air grille is used, duct between grille and furnace must be the same size as return opening in furnace.

⚠	CAUTION: Return-air grilles and warm air registers MUST not be obstructed.
---	---

⚠	WARNING: When supply ducts carry air circulated by furnace to areas outside spaces containing furnace, return air MUST also be handled by a duct sealed to furnace casing and terminating outside space containing furnace. Incorrect duct work termination and sealing will create a hazardous condition which could lead to bodily harm.
---	---

When installing furnace with cooling equipment for year-round operation, the following recommendations must be followed for series or parallel airflow:

1. In series airflow applications, coil is mounted after furnace in an enclosure in supply-air stream. The furnace blower is used for both heating and cooling airflow.

⚠	WARNING: The coil MUST be installed on air discharge side of furnace. Under no circumstances should airflow be such that cooled, conditioned air can pass over furnace heat exchanger. This will cause condensation in heat exchanger and possible failure of heat exchanger which could lead to a fire hazard and/or a hazardous condition which may lead to bodily harm. Heat exchanger failure due to improper installation may not be covered by warranty.
---	---

2. In parallel airflow applications, dampers must be provided to direct air over furnace heat exchanger when heat is desired and over cooling coil when cooling is desired.

IMPORTANT: The dampers should be adequate to prevent cooled air from entering furnace. If manually operated, dampers must be equipped with a means to prevent operation of either cooling unit or furnace unless damper is in full cool or heat position.

VENTING INSTRUCTIONS

Venting of furnace should be to the outside and in accordance with local codes or requirements of local utility.

OIL-FIRED APPLIANCES SHALL BE CONNECTED TO FLUES HAVING SUFFICIENT DRAFT AT ALL TIMES TO ENSURE SAFE AND PROPER OPERATION OF APPLIANCE.

For additional venting information, refer to ANSI/NFPA 211 Chimney, Fireplaces, Vents, and Solid Fuel Burning Appliances and/or CSA B139 Installation Code.

This furnace is certified for use with Type "L" vent (maximum flue gas temperature 575°F).

I. PRE-INSTALLATION VENT SYSTEM INSPECTION

Before furnace is installed, it is highly recommended that any existing vent system be completely inspected.

For any chimney or vent, this should include the following:

1. Inspection for any deterioration in chimney or vent. If deterioration is discovered, chimney must be repaired or vent must be replaced.
2. Inspection to ascertain that vent system is clear and free of obstructions. Any blockage must be cleared before installing furnace.
3. Cleaning chimney or vent if previously used for venting a solid fuel burning appliance or fireplace.
4. Confirming that all unused chimney or vent connections are properly sealed.
5. Verification that chimney is properly lined and sized per the applicable codes. (Refer to list of codes in Safety Considerations section.)

II. MASONRY CHIMNEY

This furnace can be vented into an existing masonry chimney. This furnace must not be vented into a chimney servicing a solid fuel burning appliance. Before venting furnace into a chimney, the chimney MUST be checked for deterioration and repaired if necessary. The chimney must be properly lined and sized per local or national codes.

If furnace is vented into a common chimney, the chimney must be of sufficient area to accommodate the total flue products of all appliances vented into chimney.

The following requirements are provided for a safe venting system:

1. Be sure that chimney flue is clear of any dirt or debris.
2. Be sure that chimney is not servicing an open fireplace.
- 3. Never reduce pipe size below minimum certified furnace pipe size as shown in Table 2.

TABLE 2—MINIMUM CERTIFIED FURNACE PIPE SIZE (IN.)

UNIT SIZE	MINIMUM PIPE DIAMETER
036105	5
048125	5
060155	6

4. All pipe should be supported using proper clamps and/or straps. These supports should be at least every 4 ft.
5. All horizontal runs of pipe should have at least 1/4-in. per ft of upward slope.
6. All runs of pipe should be as short as possible with as few turns as possible.
7. Seams should be tightly joined and checked for leaks.
8. The flue pipe must not extend into chimney but be flush with inside wall.

9. The chimney must extend 3 ft above highest point where it passes through the roof of a building and at least 2 ft higher than any portion of a building within a horizontal distance of 10 ft. It shall also be extended at least 5 ft above highest connected equipment flue collar.

10. Check local codes for any variance.

III. FACTORY-BUILT CHIMNEYS

Listed factory-built chimneys may be used. Refer to chimney manufacturer's instructions for proper installation.

→ IV. HORIZONTAL VENTING

This furnace may be vented horizontally through an outside wall when installed with 1 of the following auxiliary inducer blowers: Tjernlund Products, Inc. Model SS1 (SS1C required in Canada)

available from: Tjernlund Products, Inc.

1601 Ninth Street
White Bear Lake, MN 55110-6795
(612) 426-2993

or

Fields Controls Model SWGII-5

(with a CK-60 or CK-61 control kit)

available from: Fields Controls Company

2308 Airport Road
Kinston, NC 28051
(919) 522-3031

NOTE: In both cases, the 24-v wiring schematic included with inducer is the recommended wiring setup.

The use of either inducer can create a negative pressure in the area where furnace is located if the proper combustion-air openings are not available. This negative pressure can lead to excessive heat being retained in heat exchanger, coking, and fumes. Refer to NFPA-31 Section 1.5 for proper combustion-air requirements.

⚠	CAUTION: USE METALLIC VENT PIPE ONLY! PLASTIC VENTING MATERIALS ARE PROHIBITED!
---	--

OIL BURNER

This furnace is supplied with a high-pressure atomizing retention head type burner (for use with not heavier than grade 2 Fuel Oil). The air tube length, from face of mounting plate to extreme face of end cone, should be as shown in Table 3.

→ **TABLE 3—OIL BURNER AIR TUBE LENGTH**

UNIT SIZE	LENGTH (IN.)
036105	5
048125	5
060155	7

OIL CONNECTIONS

Complete instructions for installation of fuel oil piping will be found in oil burner Installation Instructions included with furnace.

- Oil line entry holes are provided in side panels. Two holes are provided in each location so that a 2-pipe system may be used if desired.
- A properly sized oil filter should be used with all oil burners and should be installed as close to burner as possible. For a 2-pipe system, a minimum capacity of 25 gph is needed.

BAROMETRIC DRAFT CONTROL

The barometric draft control shipped with furnace MUST be used with furnace to ensure proper operation. Instructions for installing control are packed with control. Refer to Fig. 6 for suggested locations.

ELECTRICAL

The appliance must be installed in accordance with current ANSI/NFPA 70 National Electrical Code, CSA C22.1 Canadian Electrical Code Part 1, and/or local codes.

The control system depends on correct polarity of power supply. Connect HOT wire (H) and NEUTRAL wire (N) as shown in Fig. 7.

- A separate line voltage supply MUST be used with a fused disconnect switch or HACR-type circuit breaker between main power panel and unit. (See Fig. 7.) Disconnecting means must be within sight from furnace.

	WARNING: The unit cabinet must have an uninterrupted or unbroken electrical ground to minimize personal injury if an electrical fault should occur. A green ground screw is provided in control box for this connection.
---	---

Use only copper wire for 115-v supply service to unit.

Metallic conduit (where required/used) may terminate at side panel of unit. It is not necessary to extend conduit inside unit from side panel to control box.

When replacing any original furnace wiring, use only 105°C No. 16 AWG copper wire.

Instructions for wiring thermostat (field supplied) are packed in thermostat box. Make thermostat connections as shown in Fig. 7 at 24-v terminal board on control box.

When installing optional accessories to this appliance, follow manufacturer's Installation Instructions included with accessory. Other than wiring for thermostat, wire with a minimum of type "T" insulation (63°F rise) must be used for accessories.

- Two 1/4-in. quick-connect terminals marked EAC and N5 are provided for electronic air cleaner (EAC) connection. (See Fig. 7.) These terminals are energized with 115v (0.5-amp maximum) during blower motor operation.
- Two 1/4-in. quick-connect terminals marked HUM and N6 are provided for 115-v humidifier connection. (See Fig. 7.) These terminals are energized with 115v (0.5-amp maximum) during any call for heat.

FILTERS

	WARNING: Never operate unit without a filter or with filter access door removed. Failure to adhere to this warning could lead to a hazardous condition which could lead to equipment damage and bodily harm.
---	---

An internal filter is provided as standard equipment with furnace. Refer to Keeping Filters Clean section for filter cleaning information.

OPERATIONAL CHECKOUT

DO NOT START BURNER UNLESS BLOWER ACCESS DOOR IS SECURED IN PLACE.

Installation of furnace is now complete and operational checkout may be performed.

I. START-UP

1. Check wiring against wiring diagram shown in Fig. 7.
2. Open valve on oil supply line.
3. Reset primary control.
4. Set thermostat above room temperature.
5. Set main electrical switch to ON position. Burner should start.

DO NOT TAMPER WITH UNIT OR CONTROLS—CALL YOUR SERVICE TECHNICIAN.

II. RECOMMENDED INSTALLATION PRACTICES AND COMBUSTION CHECK

In order to obtain optimum performance from oil burner, the following setup procedures must be followed:

1. A test kit (Bacharach No. 5022 kit or equivalent) to measure smoke, stack draft, over-fire draft, CO₂, and stack temperatures MUST be used in order to obtain proper air band setting. Although all of the above measurements are required for optimum setup and efficiency data, the most important readings that must be taken are smoke number, over-fire draft, and stack draft.
 2. The proper smoke number has been established by engineering tests to be between 0 and 1. This degree of smoke emission is commonly referred to as a "Trace" of smoke. It is recommended to use a Bacharach true spot smoke test set or equivalent.
 3. In order to ensure proper draft through furnace, a barometric draft regulator (supplied with furnace) must be installed as close to outlet of furnace as possible.
- In order for this device to function properly, barometric damper must be mounted with hinge pins horizontal and face of damper vertical. (See instructions included with damper.) The draft regulator should be adjusted after furnace has been firing for at least 10 minutes, and stack draft should be measured and set between -0.025 and -0.035 in. wc. The draft should be checked with a Bacharach MZF draft gage or equivalent.
4. The over-fire draft, which is taken through hole provided in observation door, is a measurement necessary to determine if there is a blockage between oil burner and flue outlet.

There should be a pressure drop of between 0.005 and 0.015 in. wc through furnace. This would set the range of the over-fire draft between -0.01 and -0.03 in. wc. A reading above -0.01 in. wc (for example +0.1 in. wc) would indicate that furnace is in an extremely high-pressure condition in primary section. This condition may be caused by excessive combustion air due to air band being too wide open or a lack of flue draft (chimney effect) or some other blockage, such as soot, in secondary section of heat exchanger.

5. The CO₂ and stack temperature instruments enable you to obtain data required to determine thermal efficiency of furnace.
6. An oil filter should be installed as close to burner as possible with ALL oil burners and is essential on lower firing rate burners. We recommend the use of a low pressure drop oil filter such as the General Filter, Inc. model #1A-25A or equivalent. It is critical that oil capacity be equivalent or greater than fuel pump gear capacity. For a 2-pipe system, this is 25 gph.
7. The oil pressure regulator is factory set to give nozzle oil pressures of 100 psig. The firing rate noted on nameplate may be obtained with "standard" nozzles by adjusting pump pressure as noted in Table 4 or on label on furnace.

On a new installation, air entrapped in oil line leading from tank to nozzle must be thoroughly purged in order to prevent excessive after drip. The oil pump is provided with a special fitting which allows purging of any air between tank and oil pump. The proper procedure for performing this operation is as follows:

- a. Place a piece of clear plastic 1/4-in. diameter tubing over purge fitting on oil pump.
- b. Start oil burner, then open purge fitting and allow burner to run until purge tube is completely free of air bubbles.

→ **TABLE 4—BURNER, NOZZLE, AND PUMP PRESSURE CHART**

UNIT SIZE	FIRING RATE GAL/HR (US)	PUMP PRESSURE (PSIG)	BECKETT OIL BURNER	
			Model	Nozzle
036105	0.76	103	AFG	0.75 gph 70° Hollow
048125	0.90	100	AFG	0.90 gph 70° Hollow
060155	1.12	104	AFG	1.10 gph 70° Hollow

- c. Tighten purge fitting. Allow oil to run to nozzle and fire burner.
- d. If purging takes longer than 30 sec and no flame has been established, burner stops. Push reset button on top of primary control to restart burner.
- e. For detailed information on operation of primary control, refer to instructions included with furnace.

III. FAN ADJUSTMENT CHECK

This furnace is equipped with a 3-speed direct-drive motor to deliver a temperature rise (between return and supply plenums) within range specified on rating plate at external duct static pressure noted on rating plate.

CAUTION: When operating furnace in heating mode, static pressure and temperature rise (supply-air temperature minus return-air temperature) must be within those limits specified on rating label. Failure to follow this warning could lead to severe furnace damage.

Adjust fan speed so that temperature rise is within rise range specified on rating plate. Consult wiring diagram for speed changes on direct-drive motor.

To adjust fan off time, set DIP switches on control board to obtain desired timing. (See Fig. 1.)

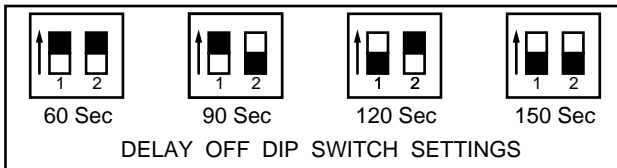

Fig. 1—Fan Off Time DIP Switch Settings (Black Box Represents Switch Position)

IV. LIMIT CONTROL CHECK

After furnace has been in operation for at least 15 minutes, restrict return-air supply by blocking filters or closing return registers and allow furnace to shut down on high limit. The burner should shut off, and main blower should continue to run.

Remove restriction, and burner should come back on in a few minutes.

V. FOR YEAR-ROUND AIR CONDITIONING

This furnace is designed for use in conjunction with cooling equipment to provide year-round air conditioning. The blower has been sized for both heating and cooling, however, fan motor speed may need to be changed to obtain necessary cooling airflow.

VI. HEATING

The blower speed is factory set to deliver required airflow at normal duct static pressure.

VII. COOLING

The blower speed may be field adjusted to deliver required airflow for cooling application. (See Table 5.)

VIII. CONSTANT BLOWER SWITCH

This furnace is equipped with a constant low-speed blower option. Whenever room thermostat is not calling for heating or cooling, blower runs on low speed in order to provide air circulation. If constant blower option is not desired, the rocker switch on side of control box may be used to turn off constant speed.

MAINTENANCE

→ **WARNING:** The ability to properly perform maintenance on this equipment requires certain expertise, mechanical skills, tools, and equipment. If you do not possess these, do not attempt to perform any maintenance on this equipment other than those procedures recommended in the User's Manual. FAILURE TO FOLLOW THIS WARNING COULD RESULT IN POSSIBLE DAMAGE TO THIS EQUIPMENT, SERIOUS PERSONAL INJURY, OR DEATH.

WARNING: Before performing any service functions, unless operations specifically require power to be on, make sure all utilities are turned off upstream of appliance. Failure to comply with this warning will cause a fire hazard and/or bodily harm.

WARNING: To avoid personal injury, make sure electrical supply power is off before servicing.

→ I. GENERAL

In order to keep this furnace in good operating condition and to maintain its warranty, the furnace **MUST** be serviced on an annual basis. This servicing includes a nozzle change, a burner inspection, a visual check of tube passages through flue outlet and cleanout ports, and a visual inspection of combustion chamber when burner is removed.

Depending on above inspection, service could also include a cleaning and vacuuming of heat exchanger tubes and possibly the heat exchanger drum section.

Removal of any heat exchanger components which are sealed by gaskets requires replacement of gasket.

WARNING: Failure to replace any heat exchanger gaskets with new gaskets when any heat exchanger plates or covers are removed could lead to heat exchanger leakage, sooting, and/or a hazardous condition capable of causing bodily harm.

This furnace should never be operated without an air filter. Disposable filters should be replaced at least once a year. If equipped to provide cooling, filters should be replaced a minimum of twice a year. Permanent filters should be cleaned at least twice a year.

ALWAYS KEEP MAIN OIL VALVE TURNED OFF IF BURNER IS SHUT DOWN FOR AN EXTENDED PERIOD OF TIME.

II. OIL BURNER

Contact your service technician for service.

Lubricate burner motor with SAE 10 oil. Once each year, pour 2 teaspoons of oil slowly into each oil cup.

To maintain proper performance, oil burner nozzle must be replaced once a year.

The procedure for nozzle installation and/or replacement is outlined in oil burner instruction manual which came with furnace. For ease of maintenance, the oiling procedure for burner motor, as outlined in burner manual, should be performed at this time.

After replacement of nozzle, burner should be adjusted in accordance with Combustion Check section of this instruction.

→ III. HEAT EXCHANGER AND FLUE PIPE

Ordinarily, it is not necessary to clean heat exchanger or flue pipe every year, but it is necessary to have your service technician check unit before each heating season to determine whether cleaning or replacement of parts is required.

A. Cleaning Secondary Heat Exchanger Tubes and Flue Pipe Only

If cleaning of only the secondary heat exchanger tubes and flue pipe is necessary, the following steps should be performed:

1. Turn off all oil and electrical supplies upstream of furnace.

CAUTION: If furnace has been in operation, some surfaces may be hot. Allow time for unit to cool down.

2. Disconnect flue pipe.
3. For access to cleanout ports, remove blower door and filter. The 2 cleanout ports are located in blower compartment. They protrude through the partition and are located on the left and right of flue pipe. (See Fig. 2.)
4. Unscrew wing clamp nuts and remove cleanout port covers. This allows access to tubes. (See Fig. 2.)

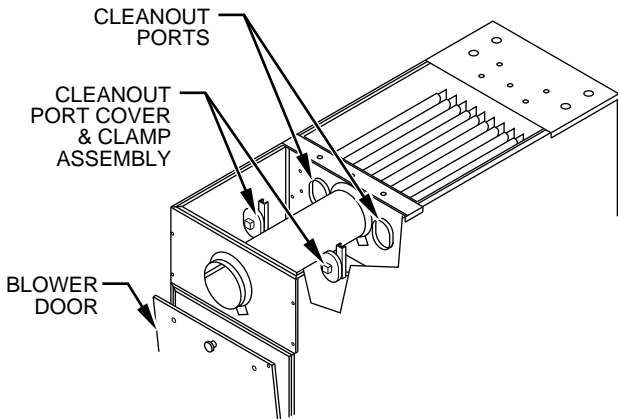

A96310

Fig. 2—Removing Cleanout Port Covers

5. Clean secondary tubes and flue pipe with a stiff brush and vacuum cleaner.
6. Before reinstalling cleanout port covers, the gasket on each cover **MUST** be replaced. Use cleanout port gasket kit Part No. 20196201.
7. Reinstall covers and tighten in place making sure that covers are properly seated over ports and gasket has sealed opening. (See Fig. 3.)

WARNING: Failure to replace cleanout port cover gaskets, failure to properly seat covers over ports, and/or failure to securely tighten wing nuts could lead to flue gas leakage. This could lead to furnace damage, oil fumes, sooting, and severe bodily harm.

8. Reconnect flue pipe.
9. Reinstall filter and blower door.

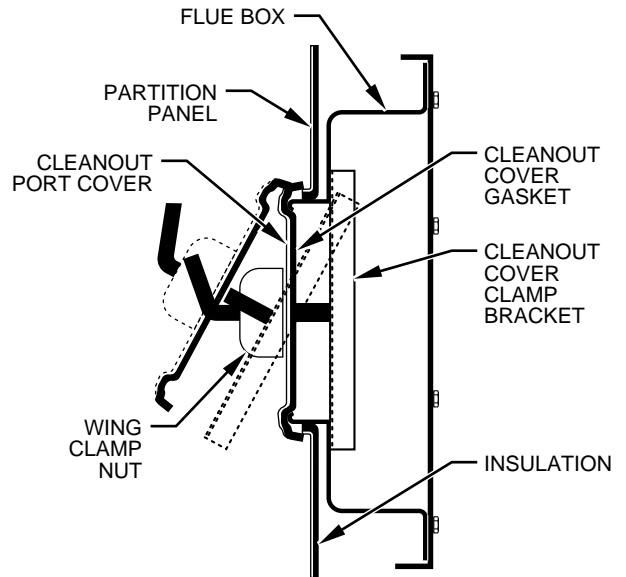

A96311

Fig. 3—Reinstalling Cleanout Port Covers

10. Turn on power to unit and readjust burner for proper operation. Inspect cleanout ports and flue connection to make sure there are no leaks.

B. Cleaning Both Primary and Secondary Heat Exchangers

If a more thorough cleaning is required (both primary and secondary heat exchanger sections), the following steps should be performed:

1. Turn off all oil and electrical supplies upstream of furnace.

CAUTION: If furnace has been in operation, some surfaces may be hot. Allow time for unit to cool down.

2. Remove blower door.
3. Disconnect flue pipe.
4. Remove outside flue collar.
5. Remove top rear panel.

NOTE: Blower removal as described in Blower Oiling and Removal section may be desired for easier access when cleaning with duct work attached.

6. Remove inside collar on flue pipe.
7. Remove top partition.
8. Place field-fabricated cardboard on metal tray beneath collector box to prevent debris from entering blower compartment.
9. Remove flue collector box from secondary heat exchanger tube flange. This exposes inside surfaces of secondary tubes of heat exchanger.
10. Clean secondary tubes and flue pipe with a stiff brush and vacuum cleaner.
11. Remove louvered door.
12. Disconnect limit control wires.
13. Disconnect oil line and remove oil burner from furnace.
14. Remove observation door and collar on observation tube.
15. Remove intermediate panel. Care must be taken not to bend or damage limit control.
16. Loosen to hand tightness the 3 nuts labeled "A" in Fig. 4. Remove screws labeled "B" in Fig. 4. Slide combustion chamber forward out of heat exchanger. Be careful not to bump combustion chamber as it becomes brittle after having been fired.

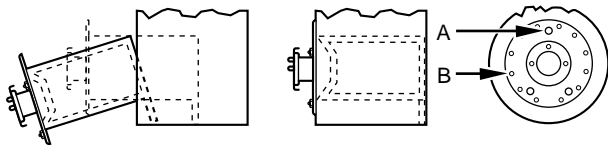

A96398

Fig. 4—Removing Combustion Chamber

- Use a stiff brush and vacuum cleaner to clean inside of primary drum.

CAUTION: Never use incendiary type cleaners (smoke sticks) for cleaning!

WARNING: For all heat exchanger plates that have been removed, the gaskets **MUST** be replaced. Failure to replace gaskets could lead to heat exchanger leakage, sooting, and a hazardous condition which could lead to bodily harm.

- Before reassembly, heat exchanger and combustion chamber should be inspected to determine if replacement is required. After cleaning, place combustion chamber back into primary drum and secure with "B" screws. Ensure that cover plate gasket is in place before tightening screws. Care must be taken not to damage combustion chamber. The "B" screws should be tightened to 35-45 lb-in.
- Tighten "A" nuts to 30 lb-in. of torque (firm, but not overly tight).
- Replace intermediate panel, observation tube collar, observation door, limit wiring, and oil burner.
- Replace collector box on secondary tube flange, ensuring proper placement of gasket. Tighten screws to 35-45 lb-in. of torque.
- Replace top partition, inside collar on flue pipe, top rear panel, outside flue collar, and blower door.
- Reconnect flue pipe and oil line(s).
- Readjust burner for proper operation. Check limit operation as outlined in Limit Control Check section.

IV. BLOWER OILING AND REMOVAL

Periodic oiling of blower motor may be necessary. Check for instructions on inside of blower access door.

If it is ever necessary to remove blower from furnace:

- Turn off all electrical power to furnace.
- Remove blower door.

- Remove screws securing blower legs to blower rails mounted on bottom panel of furnace.
- Slide blower forward on rails toward rear of unit until motor wire connections at terminal block on motor can easily be reached and disconnected.
- Disconnect motor wires at terminal block on motor.
- Remove blower from unit.
- Reverse items 1 through 6 to reinstall blower. Refer to wiring diagram (Fig. 7) of these instructions or diagram located on inside of louvered door to properly rewire unit.

V. KEEPING FILTERS CLEAN

WARNING: Never operate unit without a filter or with filter access door removed. Failure to adhere to this warning could lead to a hazardous condition which could lead to equipment damage and bodily harm.

As a homeowner, keeping filters clean is your most important responsibility. A dirty filter reduces efficiency of your system, causes erratic performance of controls, and could result in damage to motor or heating element.

- Inspect filters at regular intervals depending upon dirt conditions. For new homes, check filters every week for 4 consecutive weeks. In all cases, inspect filters at least every 3 to 4 weeks when system is in constant operation. Replace or clean filter at least at beginning of each season (heating and cooling) and thereafter as needed.
- If a permanent filter is used, it can be cleaned with cold water and soap.

Be sure that filter is thoroughly dry before installing back into furnace.

DURA LAST Filter

WASHABLE

- PERMANENT
- NEEDS NO OIL
- MORE EFFICIENT

LASTS FOR YEARS

WASH FILTERS REGULARLY • RE-INSERT SO HAIRY SIDE CATCHES DUST • NEEDS NO OIL

DURA LAST PRODUCTS CORP. NEW ORLEANS 70130

A95103

→ **TABLE 5—AIRFLOW DATA (CFM)**

UNIT SIZE	BLOWER SPEED	EXTERNAL STATIC PRESSURE IN. WC									
		0.1	0.2	0.3	0.4	0.5	0.6	0.7	0.8	0.9	1.0
036105	High	1795	1735	1675	1605	1550	1485	1425	1350	1275	1220
	Medium	1365	1335	1305	1275	1255	1215	1155	1105	1050	985
	Low	995	965	945	925	900	870	825	775	725	670
048125	High	1905	1845	1770	1695	1630	1565	1490	1425	1325	1220
	Medium	1750	1675	1620	1560	1500	1440	1370	1305	1235	1130
	Low	1390	1350	1305	1260	1220	1180	1120	1060	985	880
060155	High	2025	1960	1905	1850	1800	1665	1575	1500	1415	1315
	Medium	1885	1825	1760	1705	1640	1565	1500	1430	1350	1265
	Low	1555	1490	1445	1410	1350	1280	1230	1155	1085	1005

NOTES: 1. Airflow values in cubic ft per minute (CFM) rounded to nearest 5 CFM.
 2. Data taken without filters in place.

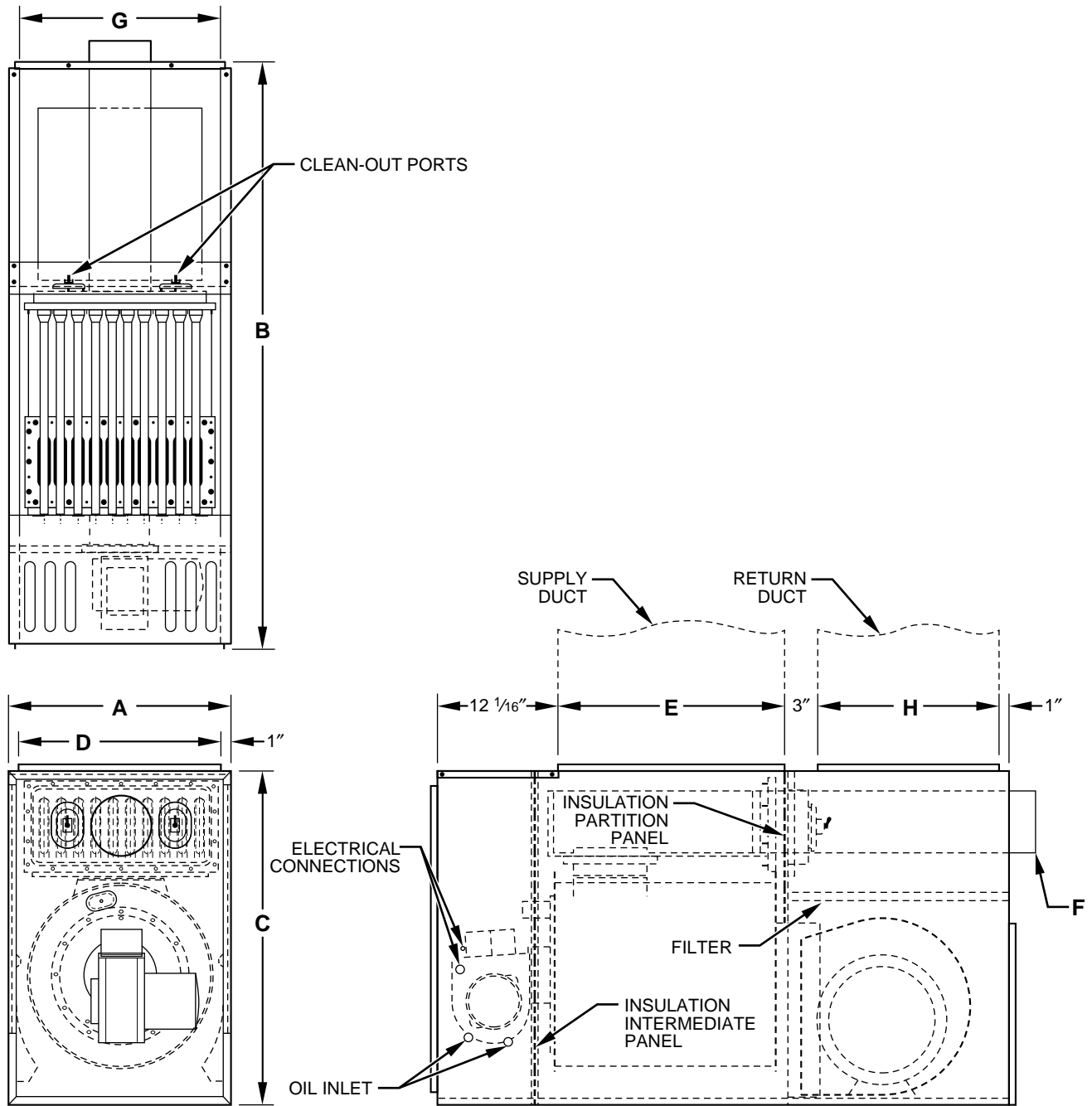

A96309

DIMENSIONS (IN.)

UNIT SIZE	UNIT DIMENSIONS			DUCT SUPPLY OPENING		FLUE DIAMETER	RETURN DUCT	
	Width	Depth	Height	D	E		G	H
	A	B	C					
036105	22	52	33	20	17-1/4	6	20	18
048125	22	57	33	20	22-1/4	6	20	18
060155	22	57	33	20	22-1/4	6	20	18

→ Fig. 5—Dimensional Drawing

BAROMETRIC DAMPER LOCATIONS

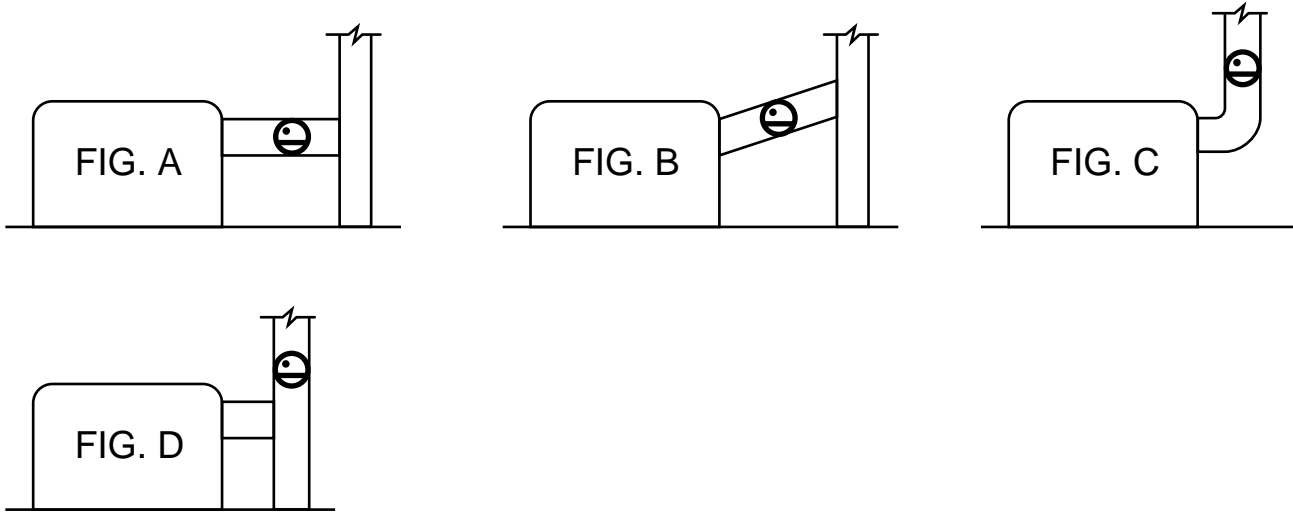

GOOD LOCATIONS

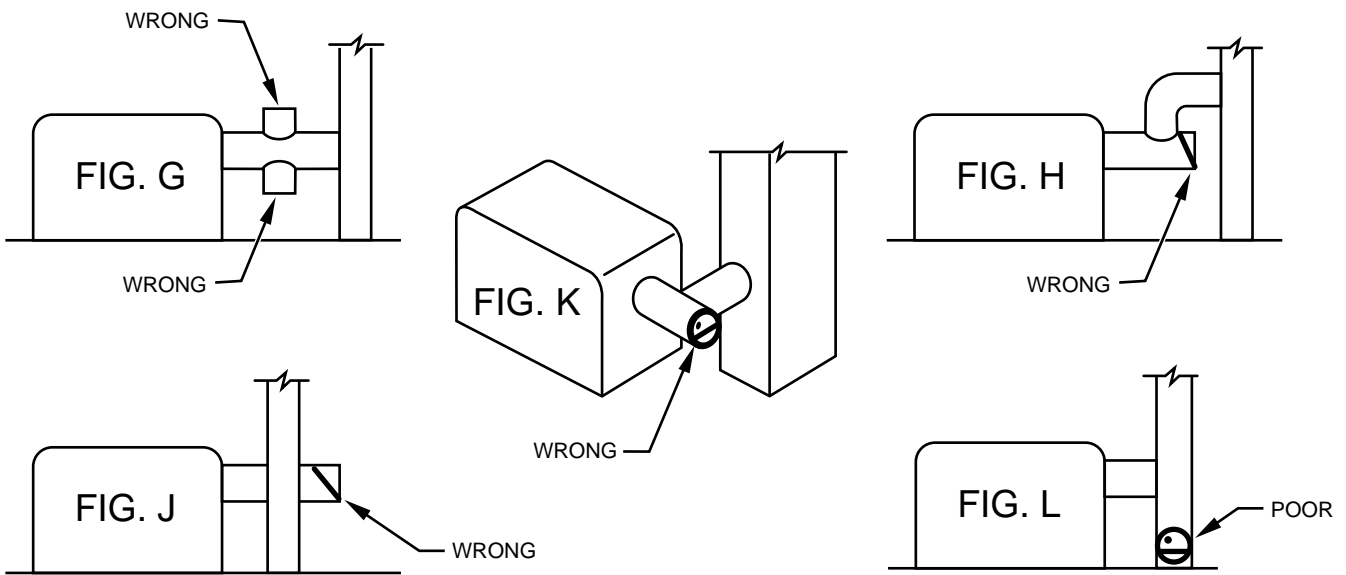

BAD LOCATIONS

Fig. 6—Barometric Damper Locations

A95117

USER'S INFORMATION

I. HERE'S HOW YOUR HEATING SYSTEM WORKS

The furnace operates automatically. It is controlled by a thermostat which you set at the temperature most comfortable to you. When the inside temperature drops below this setting, your thermostat will turn on heating system.

When thermostat calls for heat, power from transformer energizes fan control board. The fan control energizes ignition control. The ignition control lights burner automatically.

The electronic fan control automatically turns on blower after 30 sec. Fan on control is not adjustable. The air which is moved over heat exchanger by the blower is warmed and passes through ducts to room registers.

When thermostat is satisfied, the circuit is de-energized and primary control shuts off burner. The blower continues to run until selectable fan off time period has expired.

The heat sensing switch performs as furnace high-temperature limit switch. If furnace overheats for any reason, the limit switch opens, breaking circuit to burner. The blower motor is energized, and as unit cools, the limit switch closes. This relights burner, but unless overheating condition is corrected, furnace will cycle on limit.

→ This unit is equipped with an interrupted ignition electronic control. If main burner does not ignite within 30 sec from call for heat, the control locks out. The red button on top of control must be depressed for 3 sec in order to reset control. The control CANNOT be reset from room thermostat.

II. PREPARING YOUR FURNACE FOR OPERATION

Before attempting to put your furnace into operation for the heating season, you should perform the following procedures:

 **WARNING:** If you do not follow these instructions exactly, a fire or explosion may result causing property damage, personal injury, or loss of life.

1. Open all warm-air registers and make sure all return-air grilles are unobstructed.
2. If a humidifier is installed with your system, open water supply valve.

3. Set thermostat to lowest setting.
4. Turn on electric power to furnace.
5. Open oil supply valve.
6. Check all connections to ensure there are no leaks.

III. LIGHTING YOUR FURNACE

 **CAUTION:** This furnace is equipped with an interrupted type electronic ignition system. DO NOT ATTEMPT TO LIGHT WITH A MATCH.

→  **DANGER:** HIGH VOLTAGE AT IGNITOR. Severe electrical shock, personal injury, or death could result.

1. This appliance is equipped with an ignition device which automatically lights burner. Do NOT try to light burner by hand.
2. After preparing furnace for heating operation (see previous section) and checking for oil, proceed as follows.
3. For heating/cooling system, set thermostat to HEAT and fan to AUTO. Set thermostat to desired room temperature and turn on electrical power to furnace.
4. The burner should light and system should be controlled by thermostat.

IV. TURNING OFF YOUR FURNACE

Follow these simple procedures to put your furnace into "retirement" for the summer.

1. Set thermostat to lowest setting.
2. Turn off all electrical power to appliance.
3. Turn off oil supply.
4. If applicable, turn off water supply to humidifier.
5. If furnace blower will be necessary for cooling system, remember to turn electrical power back on when needed for air conditioning.

FOR SERVICE CALL

NAME: _____

ADDRESS: _____

TELEPHONE: _____

Free Manuals Download Website

<http://myh66.com>

<http://usermanuals.us>

<http://www.somanuals.com>

<http://www.4manuals.cc>

<http://www.manual-lib.com>

<http://www.404manual.com>

<http://www.luxmanual.com>

<http://aubethermostatmanual.com>

Golf course search by state

<http://golfingnear.com>

Email search by domain

<http://emailbydomain.com>

Auto manuals search

<http://auto.somanuals.com>

TV manuals search

<http://tv.somanuals.com>