

brother®

At your side.

Owner's Manual Manual del usuario

- General Description
- Operating Procedures
- Appendix, etc.
- Descripción general
- Procedimientos de manejo
- Apéndice, etc.

MPRINT

MW-120

Mobile Printer Impresora móvil

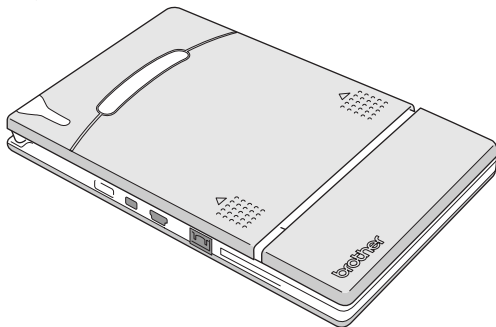

- Before using this printer, be sure to read this Owner's Manual.
- We suggest that you keep this manual in a handy place for future reference.
- Antes de usar esta impresora, asegúrese de leer esta "Manual del usuario".
- Aconsejamos mantener este manual a mano para futuras consultas.

Introduction

Thank you for purchasing the MPrint MW-120 (hereafter referred to as “the printer”).

This monochrome thermal mobile printer is ultra-portable and can be connected to a Pocket PC (PDA running Pocket PC) or a computer to make quick printouts. This User’s Guide contains operating precautions and instructions. Before using this printer, be sure to read this manual for information on its correct operation. In addition, we suggest that you keep this manual in a handy place for future reference. If you haven’t already returned your machine warranty card, take a few minutes to register at www.registermybrother.com.

Federal Communications Commission (FCC) Declaration of Conformity (For USA Only)

Responsible Party :Brother International Corporation
 100 Somerset Corporate Boulevard Bridgewater, NJ 08807-0911 USA
 TEL : (908) 704-1700

declares that the product

Product Name :Brother MPrint MW-120

Model Number :MW-120

complies with Part 15 of the FCC Rules. Operation is subject to the following two conditions: (1) this device may not cause harmful interference, and (2) this device must accept any interference received, including interference that may cause undesired operation.

This equipment has been tested and found to comply with the limits for a Class B digital device, pursuant to Part 15 of the FCC Rules. These limits are designed to provide reasonable protection against harmful interference in a residential installation. This equipment generates, uses, and can radiate radio frequency energy and, if not installed and used in accordance with the instructions, may cause harmful interference to radio communications. However, there is no guarantee that interference will not occur in a particular installation. If this equipment does cause harmful interference to radio or television reception, which can be determined by turning the equipment off and on, the user is encouraged to try to correct the interference by one or more of the following measures:

- Reorient or relocate the receiving antenna
- Increase the separation between the equipment and receiver.
- Connect the equipment into an outlet on a circuit different from that to which the receiver is connected.
- Consult the dealer or an experienced radio/TV technician for help.
- Changes or modifications not expressly approved by Brother Industries, Ltd. could void the user’s authority to operate the equipment.

- The contents of this manual are subject to change without notice.
- The contents of this manual may not be duplicated or reproduced, partially or in full, without permission.
- Please note that we assume no responsibility for damages arising from earthquakes, fire, other disasters, actions of third parties, the user's intentional or negligent operation, misuse or operation under other special conditions.
- Please note that we assume no responsibility for damage (such as losses, loss of business profits, lost profits, business disruptions or a lost means of communication) that may result from the use or inability to use this printer.
- If this printer should be defective due to faulty manufacturing, we shall replace it during the warranty period.
- We assume no responsibility for damages that may result from incorrect operation of this printer by connecting incompatible equipment or using incompatible software.



- Microsoft® and Windows® are registered trademarks of Microsoft Corporation in the United States and other countries.
- Adobe®, Acrobat®, Reader® are either registered trademarks or trademarks of Adobe Systems Incorporated in the United States and/or other countries.
- This printer is installed with IrFront from ACCESS CO., LTD. Copyright (C) 1996–2003 ACCESS CO., LTD.
- All other software and product names mentioned are trademarks or registered trademarks of their respective companies.

Precautions











Precautions indicated as shown below contain important safety information and should be strictly observed.

If the printer malfunctions, immediately stop using it, and then contact the sales representative where it was purchased.

The meanings for marks used in this manual are described below.

 Warning	Failure to observe instructions marked with this symbol may result in death or serious injuries.
 Caution	Failure to observe instructions marked with this symbol may result in injuries or property damage.

Meanings for symbols used in this manual

	Indicates danger
	Indicates danger of fire under certain circumstances
	Indicates danger of electric shock under certain circumstances
	Indicates danger of burns under certain circumstances
	Indicates an action that must not be performed
	Indicates danger of combustion if fire is nearby
	Indicates danger of sustaining injuries if the indicated part of the printer is touched
	Indicates danger of injuries, such as electric shock, if the indicated part if the printer is disassembled
	Indicates danger of electric shock if the operation is performed with wet hands
	Indicates danger of electric shock if the printer is exposed to water



Indicates an action that must be performed



Indicates that the power supply cord must be unplugged from the electrical outlet

Concerning this printer (including the built-in lithium ion battery)

Warning

- Do not use this printer wherever it is prohibited, for exam-

Warning



- Liquid leaking from the printer may indicate that the built-in battery is damaged. Immediately move the printer away from flames, otherwise a fire may result.
In addition, do not touch the leaking liquid. This liquid may damage your eyes or skin if brought in contact with them. If the liquid makes contact with your eyes, immediately rinse them with water and consult a medical professional. If the liquid makes contact with your skin or clothing, immediately rinse them with water.



- Do not try to disassemble or alter this printer, otherwise fire, electric shock or damage may result. For servicing, adjustments or repairs, contact the sales representative where it was purchased. (The warranty does not cover repairs for damage resulting from disassembly or alterations performed by the user.)



- The printer may be damaged if it is dropped or subjected to strong shocks, for example, from being stepped on. If you continue to operate a damaged printer, a fire or an electric shock may result. If the printer is damaged, immediately turn it off, unplug the AC adapter from the electrical outlet, and then contact the sales representative where it was purchased.



- If the printer operates abnormally, for example, if it produces smoke, an unusual odor or an unusual noise, stop using it, otherwise fire, electric shock or damage may result. Immediately turn off the printer, unplug the AC adapter from the electrical outlet, and then contact the sales representative where it was purchased for repairs.



- Do not charge the printer with a charger other than that specified.

Warning



- If the printer is not fully charged after the specified amount of time has passed, stop charging it, otherwise fire, electric shock or damage may result.



Caution



- Keep the printer out of the reach of children, particularly infants, otherwise injuries may result.



- Stop operating the printer if it leaks or becomes discolored, deformed or otherwise defective.

Others



- The built-in lithium ion battery is slightly charged so that the operation of the printer can be verified; however, the battery should be fully charged with the AC adapter before the printer is used.



- Do not leave the printer in a closed car under a hot sun, otherwise it may be damaged.



- If the printer is not to be used for a long period of time, be sure to charge the lithium ion battery at least once every six months in order to prevent a reduction in the efficiency and life of the battery.



- This printer is powered with a built-in lithium ion battery. If this printer can only be used for a short period of time, even though it is fully charged, the battery may have reached the end of its service life. Replace the lithium ion battery with a new one.

Contact the sales representative where the printer was purchased to have the built-in lithium ion battery replaced.



Concerning the AC adapter



Warning



- Only use the AC adapter designed specifically for this printer, otherwise fire, electric shock or damage may result.



- Do not plug the printer into an electrical outlet other than a household outlet (AC 110 V – 120 V), otherwise fire, electric shock or damage may result.



- Do not touch the AC adapter or the power supply plug with wet hands, otherwise electric shock may occur.



















- Do not try to disassemble, alter or repair the AC adapter, otherwise fire, electric shock or injuries may result.
For servicing, adjustments or repairs, contact the sales representative where the printer was purchased.



- Do not spill water or drinks, such as coffee or juice, on the AC adapter. In addition, do not use the adapter in a location where it may get wet. otherwise combustion or electric



 Warning			
  	<ul style="list-style-type: none"> When unplugging the power supply cord, do not pull on the cord, otherwise fire or electric shock may result. 		
  	<ul style="list-style-type: none"> Do not insert foreign objects into the terminals of the AC adapter, otherwise burns or electric shock may result. 		
 	<ul style="list-style-type: none"> Incorrectly using the AC adapter may result in fire or electric shock. Therefore, observe the following precautions. <table style="width: 100%; border: none;"> <tr> <td style="width: 50%; vertical-align: top;"> <ul style="list-style-type: none"> ○ Do not damage it. ○ Do not modify it. ○ Do not twist it. ○ Do not severely bend it. ○ Do not pull on it. </td> <td style="width: 50%; vertical-align: top;"> <ul style="list-style-type: none"> ○ Do not place objects on it. ○ Do not subject it to heat. ○ Do not bind it. ○ Do not allow it to be pinched. </td> </tr> </table> 	<ul style="list-style-type: none"> ○ Do not damage it. ○ Do not modify it. ○ Do not twist it. ○ Do not severely bend it. ○ Do not pull on it. 	<ul style="list-style-type: none"> ○ Do not place objects on it. ○ Do not subject it to heat. ○ Do not bind it. ○ Do not allow it to be pinched.
<ul style="list-style-type: none"> ○ Do not damage it. ○ Do not modify it. ○ Do not twist it. ○ Do not severely bend it. ○ Do not pull on it. 	<ul style="list-style-type: none"> ○ Do not place objects on it. ○ Do not subject it to heat. ○ Do not bind it. ○ Do not allow it to be pinched. 		
	<ul style="list-style-type: none"> If the AC adapter is damaged, request a new one from the sales representative where the printer was purchased. 		
	<ul style="list-style-type: none"> Keep the AC adapter out of the reach of children, particularly infants, otherwise injuries may result. 		
	<ul style="list-style-type: none"> Do not use the AC adapter near microwave ovens, otherwise damage may result. 		
  	<ul style="list-style-type: none"> Do not use the AC adapter near flames or heaters. If the covering of the AC adapter cord melts, fire or electric shock may result. 		
 	<ul style="list-style-type: none"> Before maintaining the printer, for example, when cleaning it, unplug the AC adapter from the electrical outlet, otherwise electric shock may result. 		



Warning



- If the printer is not to be used for a long period of time, be sure to unplug the AC adapter from the unit and the electrical outlet for safety reasons.



- Do not wind the AC adapter cable around the adapter or bend the cable, otherwise the cable may be damaged.

Operating precautions

- Operate this printer in an environment that meets the following requirements.
 - Temperature: 32 – 104 °F / 0 – 40 °C
 - Humidity: 20 – 80 % (Maximum wet-bulb temperature: 80.6 °F / 27 °C)
 - Do not operate or store this printer in a location exposed to extremely high or extremely low temperatures, extreme humidity, extreme dust, or extreme vibrations, otherwise the printer may be damaged or malfunction.
 - Do not use the printer in a location exposed to extreme temperature fluctuations, otherwise condensation may occur, resulting in the printer being damaged or malfunctioning.
 - If condensation occurs, allow it to dry naturally before operating the printer.
- The AC adapter case and the printer may become hot while the printer is charging or printing. This does not indicate a malfunction.
- When the printer is not used, unplug the power supply plug from the electrical outlet.
- Do not block the paper output slot.
- If the AC adapter connector or USB port becomes dirty, incorrect connection or incorrect charging may result. Periodically clean the connector and port with a dry cotton swab.
- When cleaning the printer, use a soft, dry cloth. Do not use benzene or paint thinners, otherwise the printer may become discolored or deformed. (→ Refer to page 13.)
- When using optional accessories, use them as described in their instruction manuals.
- Use thermal paper with this printer. If printed text is written over or stamped, the text may disappear or become discolored. In addition, it may take some time for the ink to dry.
- Do not touch the printer with wet hands.
- Do not leave paper cassette cover open when storing as this may cause paper misfeeding or a paper sensor error.

- Concerning the paper cassette and the handling of the paper
 - Store the paper cassette away from extremely hot, extremely humid or extremely dusty locations and out of direct sunlight, otherwise the paper may become discolored or a malfunction may result.
 - Be sure to close the lid of the paper cassette before storing it, otherwise the paper may become discolored.
 - Do not leave paper cassettes in a closed car under a hot sun, otherwise they may become discolored.
 - After opening the package of paper cassettes, close it again as soon as possible, otherwise the paper may become discolored.
 - Do not use paper that has been exposed to condensation.
 - Do not try to use paper transferred from one paper cassette to another, otherwise a malfunction may result.
 - Do not try to reuse paper that has already passed through the printer, otherwise a malfunction may result.
 - Do not open the paper cassette cover or pull out or push in the paper while the printer is printing, otherwise a malfunction may result.
 - Do not use folded, curled, cut, wet or damp paper, otherwise a paper misfeed or a malfunction may result.
 - Do not touch paper cassettes or paper with wet hands, otherwise a malfunction may result.
 - Do not prepare or replace the paper cassette in an extremely humid location, otherwise a malfunction may result.

- Depending on the environmental conditions of the location and the quality of the material that the adhesive-backed paper is attached to, the adhesive-backed paper may become discolored, peel off, be difficult to remove, leave adhesive behind or damage the surface that it was affixed to. Before using the adhesive-backed paper, test it by affixing a small piece to an inconspicuous area of the intended surface.
- Do not affix the adhesive-backed paper to people, animals or plants. Also, do not affix it to public property or other peoples possessions without permission.

CONTENTS

Introduction	i
Precautions	iii
Operating precautions	xi
1 General Description	2
2 Operating Procedures	3
Charging	3
Turning on the printer	5
Preparing the paper	6
Installing the paper cassette	8
Sending data from a Pocket PC or computer	10
Feeding paper	12
Maintenance	13
Disposing of this printer	15
3 Appendix	16
Product specifications	16
Troubleshooting	17
Indicator lights	20

1 General Description

Right side

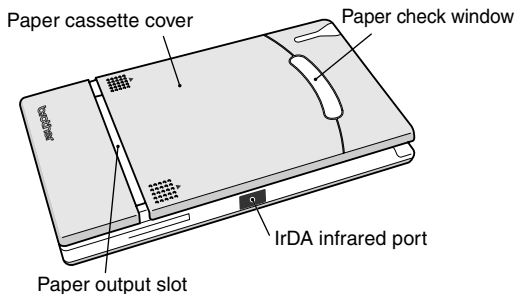

Left side

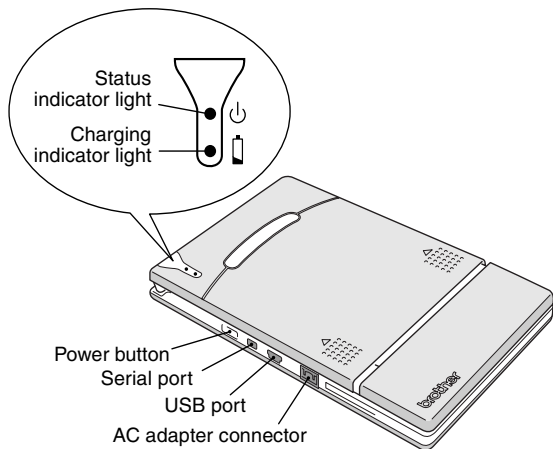

2 Operating Procedures

Charging

This printer is equipped with a built-in lithium ion battery. Use the AC adapter designed specifically for this printer to charge the battery.

After purchasing this printer, be sure to charge the battery fully before using it.

- 1** Plug the AC adapter cable into the AC adapter connector on the printer.

- 2** Plug the AC adapter plug into a household electrical outlet (AC 110 V – 120 V).

Charging of the built-in lithium ion battery automatically begins.

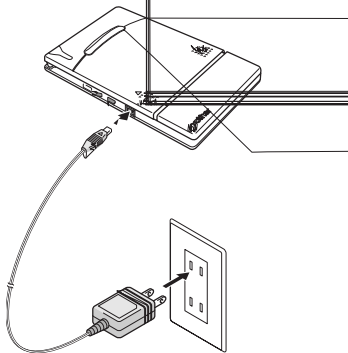

- The charging indicator light comes on in orange.
- When charging is finished, the charging indicator light goes off.



- 3** After charging is finished, disconnect the AC adapter.



- In order to protect the circuitry, the battery cannot be charged if the unit is in a location exposed to extremely high or extremely low temperatures.
- Do not wind the AC adapter cable around the adapter or bend the cable, otherwise the cable may be damaged.

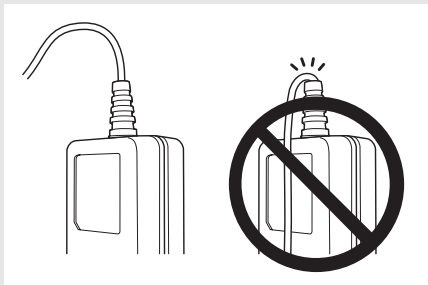

- It takes approximately three hours for the battery to be recharged from completely empty to fully charged (with the printer turned off).

Turning on the printer

- 1 Press and hold the power button for a short while, until the green status indicator light illuminates.

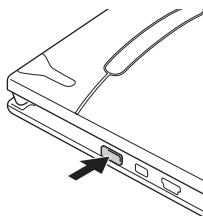

If the power button is pressed again, the printer is turned off.



- In order to prevent this printer from accidentally being turned on, it will not come on if the power button is lightly pressed. Therefore, if the printer does not come on, hold the power button pressed for a little while.
- In order to conserve the built-in lithium ion battery, the printer automatically goes off if no operation is performed or if no data is sent to it for five minutes (except when the battery is being charged with the AC adapter).

Preparing the paper

Use only the paper cassette designed exclusively for this printer. Use of any other paper will result in damage.

To prepare the paper cassette

Prepare the paper cassette before installing it into the printer.

- Be careful not to drop any paper while the paper cassette is being prepared.

- 1** Open the lid of the paper cassette, and then tear off the two pieces (①) on the sides.

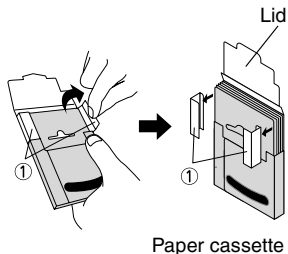

- 2** **Firmly** fold the lid back along the fold (②).

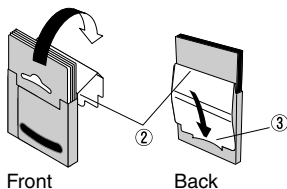

- 3** Insert the tab on the lid into the slit (③) at the back of the cassette.

**■ Handling the paper cassette**

- This printer determines the paper type depending on the installed paper cassette, then automatically selects the settings appropriate for that type of paper. Do not transfer paper to a different paper cassette.
- Do not try to reuse paper that has already passed through the printer.
- The paper cassette is made of cardboard. After all of the paper is used, dispose of the cassette according to local regulations.
- Do not use a torn or deformed paper cassette, otherwise damage may result.
- Do not prepare the paper cassette in an extremely humid location, otherwise a malfunction may result.
- Do not touch paper cassettes or paper with wet hands, otherwise a malfunction may result.
- Store the paper cassette out of extremely hot, extremely humid or extremely dusty locations and out of direct sunlight.
- When storing the paper cassette, be sure to close its lid.
- Do not leave paper cassettes in a closed car under a hot sun.
- Use the paper as quickly as possible, otherwise it may become discolored.

Installing the paper cassette

- 1 Slide the paper cassette cover (on the top of the printer) in direction ①.

→ The paper cassette cover will open in the direction indicated by ②.

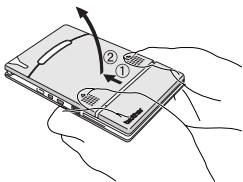

- 2 Insert the paper cassette.

The paper type indication on the paper cassette should face up. The end of the paper should point toward you.

Paper type indication

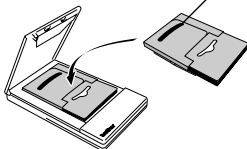

- When loading the paper cassette, make sure that it is correctly aligned and that the end of the paper is not folded, otherwise a paper misfeed may result.

- 3** Close the paper cassette cover in direction ③.

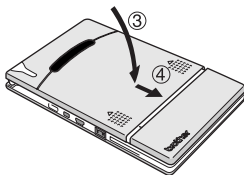

- 4** Slide the paper cassette cover in direction ④.
If the paper cassette is correctly loaded, the paper type indication on the cassette can be seen through the paper check window, and the paper cassette cover will be locked.

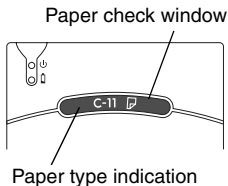

- Do not remove the paper from the paper cassette and load it directly into the printer.
- To change the paper type, install a different paper cassette.
- While the printer is printing, do not apply pressure to the paper output slot or place anything on the printer.

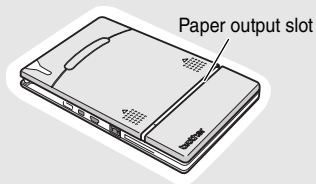

Sending data from a Pocket PC or computer

In order use this printer to print data from a Pocket PC (PDA running Pocket PC) or computer, the software must first be installed onto the Pocket PC or computer as described in the 'software guide' supplied with the printer.

Sending data through an IrDA connection

A Pocket PC can communicate with this printer through its IrDA infrared port.

- 1** Position this printer and the Pocket PC so that their IrDA infrared ports are facing each other and are positioned not more than 7.9" (20 cm) apart.

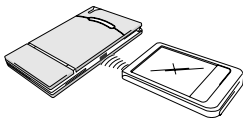

- 2** Start printing from the Pocket PC.

→ While data is being transmitted through the IrDA infrared port, the status indicator light flashes in green.



- During transmission, do not move this printer or the Pocket PC.
- Make sure that there are no obstacles between this printer and the Pocket PC.
- If this printer is connected with a USB cable or if the Pocket PC is connected through a serial connection, the infrared transmission cannot be used.
- IrDA infrared transmission is not possible with personal computers
- For more details, refer to the instruction manual for the Pocket PC.

Sending data through a USB connection

Using the enclosed USB cable, this printer can be connected to a computer or a Pocket PC supporting a USB host interface.

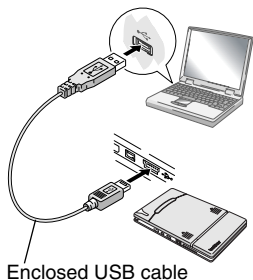

Feeding paper

If a paper misfeed occurs, remove the paper according to the following procedure.

If the paper has fed out of the paper output slot:

- 1** Pull the paper out from the paper output slot.

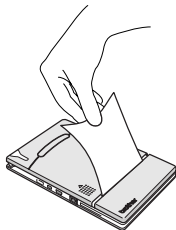

- When pulling out the paper, be sure not to tear it.

If the paper has not fed out of the paper output slot:

- 1** Open the paper cassette cover.
- 2** Remove the paper cassette.
- 3** Pull out the misfed paper.

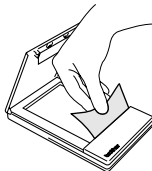

- When pulling out the paper, be sure not to tear it.



- Pulling out the paper will not affect the operation of the printer.

Maintenance



- Be sure to turn off the printer before cleaning it.

Cleaning the printer

Clean the front of the printer.

- 1** Clean off any dust or other dirt from the printer by wiping it with a soft, dry cloth.

If the printer is extremely dirty, wipe it with a slightly damp cloth.



- Do not use benzene or paint thinners, otherwise the printer may become discolored or deformed.

Cleaning the paper cassette sensor

If the paper cassette sensor is dirty, it will not be able to correctly detect the paper cassette, and a malfunction may result.

- 1** Clean the paper cassette sensor with a dry cotton swab.

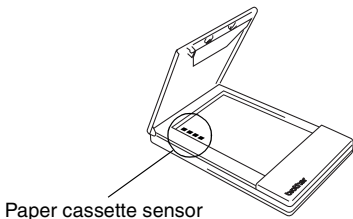

Cleaning the pick-up roller

If the pick-up roller is dirty, paper may not be fed correctly.

1 Affix a piece of cellophane tape to the pick-up roller.

2 Remove the cellophane tape from the pick-up roller.

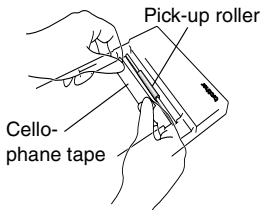

→ Any dirt on the pick-up roller is removed with the tape.

Rotate the pick-up roller and repeat the procedure to clean the entire surface of the roller.

Disposing of this printer

Before disposing of this printer, be sure to remove the built-in lithium ion battery.

Removing the lithium ion battery

- 1** Turn off the printer, and then disconnect the AC adapter.
- 2** Using a screwdriver, loosen the four screws at the back of the printer, and then remove the back cover.
- 3** Disconnect the connector, and then remove the lithium ion battery.

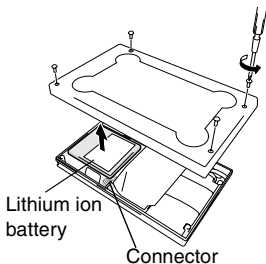

- Removing the back cover will void the warranty. Do not remove the back cover unless the printer is to be disposed of.
- The lithium ion battery is attached to the printer with adhesive tape. When removing the lithium ion battery, grasp it, and then pull it off of the printer. Be careful not to pull on the cable.
- When unplugging the connector, do not pull on the cable.
- Risk of explosion if battery is replaced by incorrect type.
Dispose of used batteries according to local regulations concerning special waste.

3 Appendix

Product specifications

Printer specifications

Indicators		Status indicator light (red/green)
		Charging indicator light (orange)
Printing	Method	Direct thermal printing with a line thermal print head
	Resolution	300 dpi × 300 dpi
	Print speed	15 seconds/sheet (standard text on thermal paper with 7 % coverage at an ambient temperature of 74.6 °F / 25 °C)
	No. of pages that can be printed	Approximately 100 pages can be printed continuously if the battery is fully charged (standard text on thermal paper with 7 % coverage at an ambient temperature of 74.6 °F / 25 °C)
Paper supply method		Brother paper cassette, automatic paper feed mechanism
Paper		Brother A7 cut paper (2.9" (74 mm) × 4.1" (105 mm))
Power supply		Compact switching AC adapter for charging, lithium ion battery (built in) 7.4 V
Interface		Serial Interface (RS-232C) Complies with USB Ver. 1.1 and an infrared port compliant with IrDA 1.2
Dimensions		3.9" (100 mm) (W) × 6.3" (160 mm) (D) × 0.7" (17.5 mm) (H)
Weight		0.66 lbs. (300 g) (including the built-in lithium ion battery and a paper cassette containing 50 sheets of plain thermal paper)

Paper sizes (print area)

Normal type	A7 size: 2.9" (74 mm) × 4.1" (105 mm) (2.7" (69 mm) × 3.9" (100 mm))
Label sheets (four down)	2.9" (74 mm) × 1.0" (26.25 mm) (2.7" (69 mm) × 0.8" (21.25 mm))
Label sheets (two down)	2.9" (74 mm) × 2.1" (52.5 mm) (2.7" (69 mm) × 1.9" (47.5 mm))

Troubleshooting

Symptoms & remedies

Symptom: The printer cannot be turned on.	Remedy: Press and hold the power button for a short while. (→ Refer to page 5.) Remedy: The built-in lithium ion battery needs recharging. (→ Refer to page 3.)
Symptom: Although the print command was issued, the printer does not print.	With an IrDA connection: Remedy: Make sure that there is no obstacle between this printer and the PDA, and check that they are within 7.9" (20 cm) of each other. (→ Refer page 10.) Remedy: Disconnect the USB cable. (→ Refer to page 10.) Remedy: Disconnect the serial cable. With a USB connection: Remedy: Check that this printer is securely connected to the computer with the USB cable. (→ Refer to page 11.) With a serial connection: Remedy: Check that this printer is securely connected to the computer with the serial cable.
Symptom: There is a paper misfeed.	Remedy: Remove the paper. (→ Refer to page 12.)

Symptom: Even though the misfed paper was removed, the error cannot be cancelled.	Remedy: Some torn paper may still remain in the printer. Contact the sales representative where the printer was purchased.
Symptom: An indicator light is lit or flashing.	Remedy: Refer to the explanation in "Indicator lights" on page 20.
Symptom: The paper does not feed.	<p>Remedy: Make sure that the lid of the paper cassette is firmly folded along the fold (②). (→ Refer to page 6.)</p> <p>Remedy: Make sure that the paper cassette cover is securely closed. (→ Refer to page 9.)</p> <p>Remedy: The paper may be dirty. Pull out the first sheet from the back of the paper cassette, and then install the paper cassette again. (→ Refer to pages 6 and 8.)</p> <p>Remedy: Clean the pick-up roller. (→ Refer to page 14.)</p>
Symptom: The print is faint (light).	Remedy: Make sure that the paper cassette cover is securely closed. (→ Refer to page 9.)

Symptom: The paper cassette cover cannot be closed.

Remedy: The parts indicated by "A" in the illustration below have locked up. Refer to the illustration and use the tip of a ball-point pen to slide the indicated part in the direction of the arrow to free it.

Paper cassette cover

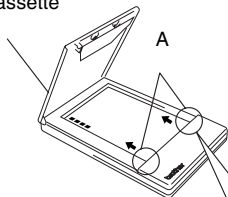

Push with the tip of a ball-point pen to slide it.

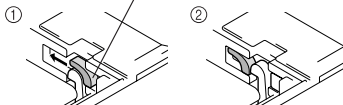

Free the part on the opposite side using the same method

Indicator lights

■ Status indicator light

A green light indicates the printer is operating correctly, while red indicates an error has occurred.

Indicator light color	Indicator light status	Printer status
Green	Constantly lit	Waiting to receive data
	Flashing	Receiving data
Red	Flashing	An error has occurred.
	Constantly lit	A system error has occurred.

If an error has occurred, check for the following causes.

Error description	Remedy
There is no paper cassette installed.	Correctly install a paper cassette containing paper.
The paper cassette is installed facing the wrong direction.	
There is no more paper.	
A paper misfeed occurred.	Remove the misfed paper.
A transmission error occurred.	Check the transmission status.
An overheat error occurred.	The inside of the printer has started to overheat.

If a system error has occurred:
The printer may be damaged. Contact the sales representative where it was purchased.

■ Charging indicator light

With the charging indicator light, the status of the power supply can be checked. The charging indicator light has two functions.

① Checking the charging status (when the AC adapter is connected)

Indicator light color	Indicator light status	Printer status
Orange	Constantly lit	Charging
	Off	Finished charging
	Flashing	Malfunctioning built-in battery

② Checking the battery level (while running off the built-in lithium ion battery)

Indicator light status	Battery level
Off	More than 60% charged
Flashes once	Less than 60% charged
Flashes twice	Less than 30% charged
Continues to flash 3 times	Almost empty



MW-120 Accessories

Stock No.	Description
C-11	A7 Thermal paper (4.1" (105 mm) x 2.9" (74 mm))
C-21	A7 Label (4.1" (105 mm) x 2.9" (74 mm))
C-41	A7 Cut label sheet (4/Sheet) (1.0" (26.25 mm) x 2.9" (74 mm))
C-42	A7 Cut label sheet (2/Sheet) (2.1" (52.5 mm) x 2.9" (74 mm))
C-51	Carbon Paper (2 ply)
2S-100	Two way stand
PG-100	Paper guide
PCS-100	Carrying Case
RC-120	Serial Cable (D-sub/9pins)

Count:

50 sheets/cassette (thermal paper)

30 sheets/cassette (all others)

Brother® Printer One Year Limited Warranty and Replacement Service (For USA Only)

Who is covered:

- This limited warranty ("warranty") is given only to the original end-use/retail purchaser (referred to in this warranty as "Original Purchaser") of the accompanying product, consumables and accessories (collectively referred to in this warranty as "this Product").
- If you purchased a product from someone other than an authorized Brother reseller in the United States or if the product was used (including but not limited to floor models or refurbished product), prior to your purchase you are not the Original Purchaser and the product that you purchased is not covered by this warranty.

What is covered:

- This Product includes a Machine and Consumable and Accessory Items. Consumable and Accessory Items include but are not limited to paper cassettes.
- Except as otherwise provided herein, Brother warrants that the Machine and the accompanying Consumable and Accessory Items will be free from defects in materials and workmanship, when used under normal conditions.
- This warranty applies only to products purchased and used in the United States. For products purchased in, but used outside, the United States, this warranty covers only warranty service within the United States (and does not include shipping outside the United States).

What is the length of the Warranty Periods:

- Machines: one year from the original purchase date.

- Accompanying Consumable and Accessory Items: 90 days from the original purchase date or the rated life of the Consumable Item, whichever occurs first.

What is NOT covered:

This warranty does not cover:

- (1) Physical damage to this Product;
- (2) Damage caused by improper installation, improper or abnormal use, misuse, neglect or accident (including but not limited to transporting this Product without the proper preparation and/or packaging);
- (3) Damage caused by another device or software used with this Product (including but not limited to damage resulting from use of non Brother®-brand parts and Consumable and Accessory Items);
- (4) Consumable and Accessory Items that expired in accordance with a rated life; and,
- (5) Problems arising from other than defects in materials or workmanship.

This limited warranty is VOID if this Product has been altered or modified in any way (including but not limited to attempted warranty repair without authorization from Brother and/or alteration/removal of the serial number).

What to do if you think your Product is eligible for warranty service:

Report your issue to our Customer Service Hotline at 1-877-276-8437 or 1-877-BROTHER within the applicable warranty period. Supply Brother with a copy of your dated bill of sale showing that this Product was purchased within the U.S.

Brother® Printer One Year Limited Warranty and Replacement Service (For USA Only)

What Brother will ask you to do:

After contacting Brother you may be required to deliver (by hand if you prefer) or send the Product properly packaged, freight prepaid, to the together with a photocopy of your bill of sale. **You are responsible for the cost of shipping, packing product, and insurance (if you desire). You are also responsible for loss or damage to this Product in shipping.**

If the Machine and/or accompanying Consumable and Accessory Items are not covered by this warranty (either stage), you will be charged for shipping the Machine and/or accompanying Consumable and Accessory Items back to you.

The foregoing are your sole (i.e., only) and exclusive remedies under this warranty.

What Brother will do:

If the problem reported concerning your Machine and/or accompanying Consumable and Accessory Items is covered by this warranty and if you first reported the problem to Brother within the applicable warranty period, Brother will repair or replace the Machine and/or accompanying Consumable and Accessory Items at no charge to you for parts or labor. The decision as to whether to repair or replace the Machine and/or accompanying Consumable and Accessory Items is made by Brother in its sole discretion. Brother reserves the right to supply a refurbished or remanufactured replacement Machine and/or accompanying Consumable and Accessory Items and use refurbished parts provided such replacement products conform to the manufacturer's specifications for new product/parts. The repaired or replacement Machine and/or accompanying Consumable and Accessory Items will be returned to you freight prepaid.

Brother® Printer One Year Limited Warranty and Replacement Service (For USA Only)

What happens when Brother elects to replace your Machine:

When a replacement Machine is authorized by Brother will send to you a replacement Machine with the understanding that you will, after receipt of the replacement Machine, supply the required proof of purchase information, together with the Machine that Brother agreed to replace. You are then expected to pack the Machine that Brother agreed to replace in the package from the replacement Machine and return it to Brother using the freight bill supplied by Brother in accordance with the instructions provided by Brother. Since you will be in possession of two machines, Brother will require that you provide a valid major credit card number. Brother will issue a hold against the credit card account number that you provide until Brother receives your original Product and determines that your original Product is entitled to warranty coverage. Your credit card will be charged up to the cost of a new Product only if: (i) you do not return your original Product to Brother within five (5) business days; (ii) the problems of your original Product are not covered by the limited warranty; (iii) the proper packaging instructions are not followed and has caused damage to the product; or (iv) the warranty period on your original Product has expired or has not been sufficiently validated with a copy of the proof of purchase (bill of sale). The replacement Machine you receive (even if refurbished or remanufactured) will be covered by the balance of the limited warranty period remaining on the original Product, plus an additional thirty (30) days. You will keep the replacement Machine that is sent to you and your original Machine shall become the

property of Brother. **Retain your original Accessory Items and a copy of the return freight bill, signed by the courier.**

Limitations:

Brother is not responsible for damage to or loss of any equipment, media, programs or data related to the use of this Product. Except for that repair or replacement as described above, Brother shall not be liable for any direct, indirect, incidental or consequential damages or specific relief. Because some states do not allow the exclusion or limitation of consequential or incidental damages, the above limitation may not apply to you.

THIS WARRANTY IS GIVEN IN LIEU OF ALL OTHER WARRANTIES, WRITTEN OR ORAL, WHETHER EXPRESSED BY AFFIRMATION, PROMISE, DESCRIPTION, DRAWING, MODEL OR SAMPLE. ANY AND ALL WARRANTIES OTHER THAN THIS ONE, WHETHER EXPRESS OR IMPLIED, INCLUDING IMPLIED WARRANTIES OF MERCHANTABILITY AND FITNESS FOR A PARTICULAR PURPOSE, ARE HEREBY DISCLAIMED.

- This Limited Warranty is the only warranty that Brother is giving for this Product. It is the *final expression and the exclusive and only statement* of Brother's obligations to you. It replaces all other agreements and understandings that you may have with Brother or its representatives.

Brother® Printer One Year Limited Warranty and Replacement Service (For USA Only)

- This warranty gives you certain rights and you may also have other rights that may vary from state to state.
- This Limited Warranty (and Brother's obligation to you) may not be changed in any way unless you and Brother sign the same piece of paper in which we (1) refer to this Product and your bill of sale date, (2) describe the change to this warranty and (3) agree to make that change.

Important: *We recommend that you keep all original packing materials, in the event that you ship this product.*

Register your product:

By registering your product with Brother International Corporation, you will be recorded as the original owner of the product. Your registration with Brother:

- may serve as a confirmation of the purchase date of your product should you lose your receipt;
- may support an insurance claim by you in the event of product loss covered by insurance; and,
- will help us notify you of enhancements to your product and special offers.

Please complete the Brother Warranty Registration online at www.register-mybrother.com.

Important Information

Should you have questions, or need information about your Brother Product, we have a variety of support options for you to choose from:

USA-Customer Service:

Customer Service
877-276-8437 / 877-BROTHER (voice)

Customer Service
901-379-1210 (fax)

Automated Faxback
800-521-2846

World Wide Web
www.brother.com

Supplies / Accessories
www.brothermall.com
or 888-879-3232

BROTHER INTERNATIONAL CORPORATION
100 SOMERSET CORPORATE BLVD.
BRIDGEWATER, NEW JERSEY 08807-0911

Please record your model and serial number and your date and location of Purchase below for your records. Keep this information with your proof of purchase (bill of sale) in case your Product requires service.

Model # _____

Serial # _____

Date of purchase: _____

Store where purchased: _____

Location of store: _____

Important: We recommend that you keep all original packing materials, in the event you ship this product.

Manual del usuario

Introducción

Gracias por la adquisición de la MPrint MW-120 (designada a partir de aquí como "la impresora").

Esta impresora móvil térmica y monocromática es ultraportátil y puede conectarse a un PC de bolsillo (PDA con Pocket PC) o a un equipo para llevar a cabo impresiones rápidas.

Esta "Guía del usuario" contiene precauciones e instrucciones de manejo. Antes de usar esta impresora, asegúrese de leer este manual para informarse acerca de su manejo correcto.

Asimismo, aconsejamos mantener este manual a mano para futuras consultas.

Si todavía no ha enviado la tarjeta de garantía de su máquina, tómese un momento para registrarla en www.registermybrother.com.

Declaración de conformidad de la Federal Communications Commission (Comisión federal de comunicaciones, FCC) (sólo para Estados Unidos)

Parte responsable : Brother International Corporation
100 Somerset Corporate Boulevard Bridgewater, NJ 08807-0911 USA
TEL: (908) 704-1700

declara que el producto

Nombre del producto : MPrint MW-120 de Brother

Número de modelo : MW-120

cumple con la Parte 15 de las Normas de la FCC. El funcionamiento está sujeto a las dos condiciones siguientes: (1) este dispositivo no puede causar interferencias perjudiciales, y (2) este dispositivo debe aceptar cualquier interferencia que reciba, que incluye interferencias que puedan causar un funcionamiento no deseado.

Este equipo se ha comprobado y cumple los límites establecidos para un dispositivo digital de clase B, conforme a la Parte 15 de la normativa de la FCC. Estos límites se han diseñado para proporcionar una protección razonable contra las interferencias indeseables en una instalación doméstica. Este equipo genera, utiliza y puede emitir energía de radiofrecuencia y, si no se instala y se usa según las instrucciones, puede causar interferencias perjudiciales a las comunicaciones de radio. No obstante, no se garantiza que no se producirán interferencias en una instalación específica. Si este equipo causara interferencias perjudiciales en la recepción de radio o de televisión, lo cual se puede comprobar apagando y encendiendo el dispositivo, el usuario puede corregir la interferencia llevando a cabo una o más de las medidas siguientes:

- Volver a orientar o cambiar de sitio la antena de recepción
- Aumentar la separación entre el equipo y el receptor.
- Conectar el equipo a una toma o a un circuito diferente del que está conectado el receptor.
- Consultar con el distribuidor o con un técnico experto en radio y TV.
- Debe usarse el cable de interfaz que se incluye para garantizar la conformidad con los límites para un dispositivo digital de Clase B.
- Los cambios o las modificaciones no expresamente aprobados por Brother Industries, Ltd., anulan la autorización del usuario para utilizar el equipo.

- El contenido de este manual está sujeto a cambios sin previo aviso.
- El contenido de este manual no se puede duplicar ni reproducir, ni parcial ni totalmente, sin una autorización.
- No asumimos ninguna responsabilidad por daños que sean consecuencia de terremotos, incendios u otros siniestros, de acciones de terceros, o del uso indebido o la utilización en circunstancias especiales, ya sea de manera intencionada o negligente, por parte del usuario.
- No asumimos ninguna responsabilidad por daños (como pérdidas, pérdida de beneficios comerciales, beneficios perdidos, interrupciones de la actividad comercial o pérdida de medios de comunicación) que puedan derivarse del uso de esta impresora o de la imposibilidad de usarla.
- Si esta impresora presenta fallos debidos a una fabricación defectuosa, nos comprometemos a reponerla durante el periodo de garantía.
- No asumimos ninguna responsabilidad por los daños que puedan derivarse de la utilización indebida de software o equipos incompatibles en esta impresora.



- Microsoft[®], Windows[®], Windows NT[®] y Windows Mobile[™] son marcas comerciales registradas o marcas comerciales de Microsoft Corporation en Estados Unidos y otros países.
- Adobe[®], Acrobat[®], Reader[®] son marcas comerciales registradas o marcas comerciales de Adobe Systems Incorporated en los Estados Unidos y/o en otros países.
- Esta impresora tiene instalado IrFront de ACCESS CO., LTD. Copyright (C) 1996–2003 ACCESS CO., LTD.
- Los nombres de productos y aplicaciones de software restantes mencionados en este documento son marcas comerciales o marcas registradas de sus respectivas compañías.

Precauciones







Las precauciones que se describen a continuación contienen información de seguridad importante y deben seguirse rigurosamente.





Si la impresora presenta algún fallo de funcionamiento, deje de utilizarla inmediatamente y póngase en contacto con el representante de ventas del establecimiento en el que la adquirió.

Los significados de los símbolos utilizados en este manual se explican a continuación.









 Advertencia	El incumplimiento de las instrucciones marcadas con este símbolo puede producir lesiones graves e incluso la muerte.
 Precaución	El incumplimiento de las instrucciones marcadas con este símbolo puede producir lesiones o daños materiales.

Significado de los símbolos utilizados en este manual

	Indica peligro
	Indica peligro de incendio en determinadas circunstancias
	Indica peligro de descarga eléctrica en determinadas circunstancias
	Indica peligro de quemaduras en determinadas circunstancias
	Indica una acción que no se debe realizar
	Indica peligro de combustión si hay fuego en las proximidades
	Indica peligro de sufrir lesiones si se toca la parte de la impresora especificada

	Indica peligro de lesiones, como descargas eléctricas, si se desmonta la parte de la impresora especificada
	Indica peligro de descarga eléctrica si la operación se realiza con las manos mojadas
	Indica peligro de descarga eléctrica si la impresora está expuesta al agua
	Indica una acción que se debe realizar
	Indica que el cable de alimentación se debe desenchufar de la toma de corriente eléctrica.

Indicaciones relativas a esta impresora (incluida la batería de ión-litio integrada)

 Advertencia	
	<ul style="list-style-type: none"> No utilice esta impresora en lugares donde esté prohibido hacerlo, como por ejemplo en un avión, ya que podría afectar a los equipos y ocasionar un accidente.
	<ul style="list-style-type: none"> Si esta impresora se va a utilizar en entornos especiales, como por ejemplo cerca de aparatos médicos, asegúrese de antemano de que no se producirán efectos perjudiciales debidos a las ondas electromagnéticas. No asumimos ninguna responsabilidad por lesiones resultantes de interferencias causadas por las ondas electromagnéticas.
 	<ul style="list-style-type: none"> No inserte objetos extraños en la impresora o en sus conectores y puertos, ya que podría ocasionar un incendio, una descarga eléctrica u otros daños.
  	<ul style="list-style-type: none"> Si algún objeto extraño cae dentro de la impresora, apáguela de inmediato, desenchufe el adaptador de CA de la toma de corriente eléctrica y póngase en contacto con el representante de ventas del establecimiento en el que la adquirió. Si sigue utilizando la impresora, puede producirse un incendio, una descarga eléctrica u otros daños.

Advertencia



- No utilice, recargue, ni guarde la impresora en los siguientes lugares; de lo contrario, podría ocasionar una fuga, un incendio, una descarga eléctrica u otros daños.
 - Cerca del agua, como por ejemplo en un cuarto de baño o cerca de un calentador de agua, o en un lugar con un nivel elevado de humedad
 - En un lugar donde esté expuesta a la lluvia o a la humedad
 - En un lugar con mucho polvo
 - En un lugar muy caliente, como cerca de una llama o de un calentador, o en una zona expuesta a la luz directa del sol
 - En un automóvil cerrado expuesto a un sol intenso
 - En un lugar en el que pueda formarse condensación















- Una fuga de líquido de la impresora puede indicar que la batería integrada se ha dañado. Aparte la impresora de las llamas inmediatamente; de lo contrario, puede producirse un incendio.
No toque el líquido derramado. Este líquido puede provocar lesiones si entra en contacto con los ojos o la piel. Si el líquido entra en contacto con los ojos, lávelos inmediatamente con agua y consulte a un médico. Si entra en contacto con la piel o la ropa, lávelas inmediatamente con agua.





- No trate de desmontar o alterar la impresora, ya que al hacerlo podría provocar un incendio, una descarga eléctrica u otros daños. Para las tareas de mantenimiento, ajuste o reparación, póngase en contacto con el representante de ventas del establecimiento en el que adquirió la impresora. (La garantía no cubre las reparaciones de los daños debidos al desmontaje o a alteraciones que haya realizado el usuario.)

Advertencia

- | | |
|--|---|
| 

 | <ul style="list-style-type: none"> • La impresora puede resultar dañada si se cae o se somete a golpes fuertes, como por ejemplo, si alguien la pisa. Si sigue utilizando una impresora dañada, puede producirse un incendio o una descarga eléctrica. Si la impresora está dañada, apáguela inmediatamente, desenchufe el adaptador de CA de la toma de corriente y póngase en contacto con el representante de ventas del establecimiento en el que la adquirió. |
| 

 | <ul style="list-style-type: none"> • Si la impresora no funciona normalmente, si por ejemplo despidе humo o un olor raro o emite ruidos extraños, deje de usarla, ya que de lo contrario podría producirse un incendio, una descarga eléctrica u otros daños. Apague la impresora inmediatamente, desenchufe el adaptador de CA de la toma de corriente y póngase en contacto con el representante de ventas del establecimiento en el que la adquirió para que se lleven a cabo las reparaciones pertinentes. |
|  | <ul style="list-style-type: none"> • No cargue la impresora con un cargador distinto del especificado. |
| 

 | <ul style="list-style-type: none"> • Si la impresora no se carga completamente una vez transcurrido el periodo de tiempo especificado, detenga la carga, porque de lo contrario podría producirse un incendio, una descarga eléctrica u otros daños. |

Precaución

- | | |
|---|--|
|  | <ul style="list-style-type: none"> • Mantenga la impresora fuera del alcance de los niños, especialmente de los más pequeños, ya que podrían sufrir lesiones. |
|  | <ul style="list-style-type: none"> • Deje de utilizar la impresora si detecta alguna fuga o si observa decoloraciones, deformaciones o algún otro defecto. |

Otros



- La batería de ión-litio integrada tiene una ligera carga, de modo que se puede comprobar el funcionamiento de la impresora; no obstante, la batería debe cargarse por completo con el adaptador de CA antes de usar la impresora.



- No deje la impresora en automóviles cerrados expuestos a un sol intenso, porque podría resultar dañada.



- Si la impresora no se va a utilizar durante un periodo prolongado de tiempo, asegúrese de cargar la batería de ión-litio al menos una vez cada seis meses con el fin de impedir que se reduzcan su eficiencia y su vida útil.



















- Esta impresora está alimentada por una batería de ión-litio integrada. Si la impresora sólo se puede utilizar durante un breve periodo de tiempo, a pesar de estar completamente cargada, es posible que la batería haya llegado al final de su vida útil. Sustituya la batería de ión-litio por una nueva.

Póngase en contacto con el representante de ventas del establecimiento en el que adquirió la impresora para cambiar la batería de ión-litio integrada.



Indicaciones relativas al adaptador de CA

 Advertencia	
  	<ul style="list-style-type: none"> Utilice sólo el adaptador de CA diseñado específicamente para esta impresora; de no hacerlo, podría provocar un incendio, una descarga eléctrica u otros daños.
  	<ul style="list-style-type: none"> No enchufe la impresora en una toma de corriente que no corresponda al estándar doméstico (CA 110 V – 120 V), porque de lo contrario podría producirse un incendio, una descarga eléctrica u otros daños.
 	<ul style="list-style-type: none"> No toque el adaptador de CA o el enchufe de suministro eléctrico con las manos mojadas, ya que podría sufrir una descarga eléctrica.
  	<ul style="list-style-type: none"> No trate de desmontar, alterar o reparar el adaptador de CA, porque podría provocar un incendio, una descarga eléctrica o lesiones. Para las tareas de mantenimiento, ajuste o reparación, póngase en contacto con el representante de ventas del establecimiento en el que adquirió la impresora.
  	<ul style="list-style-type: none"> No derrame agua ni bebidas, como café o zumos, sobre el adaptador de CA. Asimismo, no utilice el adaptador en un lugar donde pueda mojarse, ya que podrían producirse combustiones o descargas eléctricas.
 	<ul style="list-style-type: none"> Si el enchufe de suministro eléctrico se ensucia, por ejemplo de polvo, desconéctelo de la toma de corriente y límpielo con un paño seco. Si continúa usando un enchufe de suministro eléctrico sucio, puede producirse un incendio.

Advertencia



- Para desenchufar el cable de suministro eléctrico, no tire del cable, porque podría provocar un incendio o una descarga eléctrica.



- No inserte objetos extraños en los terminales del adaptador de CA, porque al hacerlo podría ocasionar quemaduras o descargas eléctricas.



- Un uso incorrecto del adaptador de CA puede ocasionar incendios o descargas eléctricas. Por tanto, respete las siguientes precauciones.



- No lo dañe.
- No lo modifique.
- No lo retuerza.
- No lo doble excesivamente.
- No tire de él.
- No coloque objetos sobre él.
- No lo exponga al calor.
- No lo ate.
- No permita que quede atrapado entre dos objetos.



- Si el adaptador de CA está dañado, pida uno nuevo al representante de ventas del establecimiento en el que adquirió la impresora.



- Mantenga el adaptador de CA fuera del alcance de los niños, especialmente de los más pequeños, ya que podrían sufrir lesiones.



- No utilice el adaptador de CA cerca de hornos microondas, porque podrían producirse daños.



- No utilice el adaptador de CA cerca de llamas o calentadores. Si se derrite el aislante que rodea el cable del adaptador de CA, pueden producirse incendios o descargas eléctricas.



 **Advertencia**

- Antes de efectuar una operación de mantenimiento de la impresora, por ejemplo durante su limpieza, desenchufe el adaptador de CA de la toma de corriente para evitar que se produzca una descarga eléctrica.



- Si la impresora no se va a utilizar durante un periodo prolongado de tiempo, asegúrese de desenchufar el adaptador de CA de la unidad y de la toma de corriente por razones de seguridad.



- No enrolle el cable del adaptador de CA en torno al adaptador ni lo doble, porque podría dañarse.

Precauciones de uso

- Utilice esta impresora en un entorno que cumpla los siguientes requisitos.
 - Temperatura: 32 – 104 °F / 0 – 40 °C
 - Humedad: 20 – 80 % (Temperatura húmeda máxima: 80,6 °F /

- Utilice papel térmico con esta impresora. Si se estampa o se escribe encima del texto impreso, éste puede desaparecer o decolorarse. Asimismo, la tinta puede tardar unos minutos en secarse.
- No toque la impresora con las manos mojadas.
- No deje abierta la cubierta del paquete de papel cuando guarde la impresora, porque podrían producirse fallos de alimentación o errores del sensor del papel.
- Indicaciones relativas al paquete de papel y a la manipulación del papel
 - Guarde el paquete de papel lejos de lugares con condiciones extremas de temperatura o humedad, con mucho polvo o expuestos a la luz directa del sol, ya que el papel podría decolorarse y pueden producirse fallos.
 - Asegúrese de cerrar la tapa del paquete de papel antes de guardarlo, ya que de lo contrario el papel podría decolorarse.
 - No deje paquetes de papel en automóviles cerrados expuestos a un sol intenso, porque podrían decolorarse.
 - Después de abrir la caja de paquetes de papel, ciérrela de nuevo lo antes posible, porque de lo contrario el papel podría decolorarse.
 - No utilice papel que haya estado expuesto a la condensación.
 - No intente usar papel transferido de un paquete de papel a otro, porque pueden producirse fallos de funcionamiento.
 - No trate de reutilizar papel que ya ha pasado por la impresora, ya que pueden producirse fallos de funcionamiento.
 - No abra la cubierta del paquete de papel ni empuje el papel o tire de él mientras la impresora está imprimiendo, ya que podría producirse un fallo de funcionamiento.

- No utilice papel doblado, ondulado, cortado, mojado o húmedo, ya que puede producirse un fallo de funcionamiento o un error de alimentación del papel.
- No toque los paquetes de papel o el papel con las manos mojadas, ya que pueden producirse fallos.
- No prepare o reemplace el paquete de papel en un lugar con un nivel elevado de humedad, porque podrían producirse fallos de funcionamiento.
- Dependiendo de las condiciones ambientales del lugar y de la calidad del material al que está pegado el papel adhesivo, puede que éste se decolore, se despegue, sea difícil de separar, manche de adhesivo la impresora o dañe la superficie a la que estaba adherido. Antes de utilizar papel adhesivo, haga una prueba pegando un trozo pequeño a un área poco visible de la superficie que se pretende utilizar.
- No pegue el papel adhesivo sobre personas, animales o plantas. No lo pegue tampoco en propiedades públicas o en bienes pertenecientes a otras personas sin que éstas lo autoricen.

CONTENIDO

Introducción	i
Precauciones	iii
Precauciones de uso	xii
1 Descripción general	2
2 Procedimientos de uso	3
Carga	3
Encendido de la impresora	5
Preparación del papel	6
Instalación del paquete de papel	8
Envío de datos desde un equipo o PC de bolsillo ...	10
Alimentación del papel	12
Mantenimiento	13
Eliminación de la impresora	15
3 Apéndice	16
Especificaciones del producto	16
Diagnóstico de problemas	18
Luces indicadoras	21

1 Descripción general

Lado derecho

Cubierta del paquete de papel

Ventana de comprobación de papel

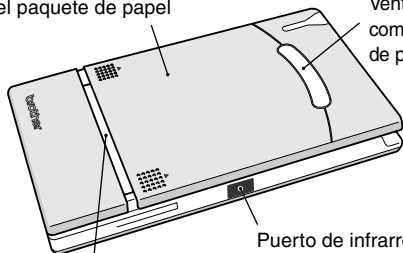

Ranura de salida de

Puerto de infrarrojos IrDA

Lado izquierdo

Luz indicadora de estado

Luz indicadora de carga



Botón de encendido

Puerto serie

Puerto USB

Conector del adaptador de CA

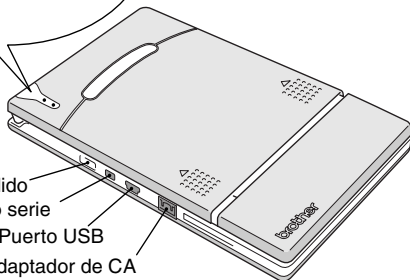

2 Procedimientos de uso

Carga

Esta impresora está equipada con una batería de ión-litio integrada. Utilice el adaptador de CA diseñado específicamente para esta impresora para cargar la batería.

Tras adquirir esta impresora y antes de usarla, cargue completamente la batería.

1 Inserte el cable del adaptador de CA en el conector correspondiente de la impresora.

2 Inserte el enchufe del adaptador de CA en la toma de corriente de la pared (CA 110 V – 120 V). La carga de la batería de ión-litio integrada comienza automáticamente.

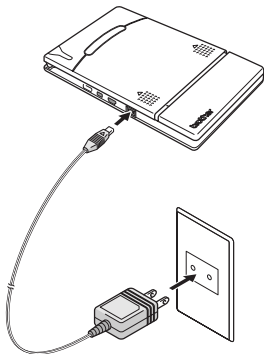

- La luz indicadora de carga se enciende con color naranja.
- Cuando se termina de cargar, la luz indicadora de carga se apaga.



3 Cuando se haya terminado de cargar, desenchufe el adaptador de CA.



- A fin de proteger los circuitos, la batería no se puede cargar si la unidad está situada en un lugar expuesto a temperaturas extremas.
- No enrolle el cable del adaptador de CA en torno al adaptador ni lo doble, porque podría dañarse.

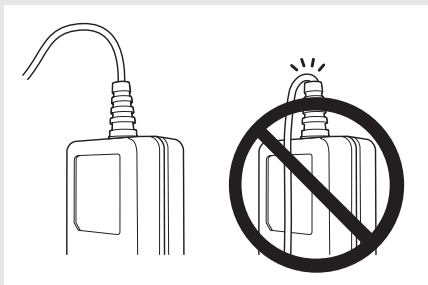

- La batería tarda unas tres horas en recargarse completamente desde un estado de descarga total (con la impresora apagada).

Encendido de la impresora

- 1** Pulse y mantenga pulsado el botón de encendido durante unos segundos, hasta que la luz indicadora de estado de color verde se ilumine.

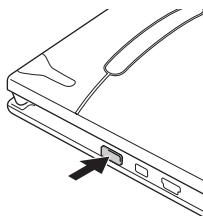

Si el botón de encendido se pulsa de nuevo, la impresora se apaga.



- Con el fin de impedir el encendido accidental, la impresora no se enciende si el botón de encendido se pulsa levemente. Por tanto, si la impresora no se enciende, mantenga pulsado el botón de encendido durante unos segundos.
- A fin de evitar un desgaste innecesario de la batería de ión-litio integrada, la impresora se apaga automáticamente si no se ejecuta ninguna operación o si no se envían datos durante cinco minutos (salvo cuando la batería se está cargando con el adaptador de CA).

Preparación del papel

Utilice sólo el paquete de papel diseñado exclusivamente para esta impresora. El uso de cualquier otro tipo de papel ocasionará daños a la unidad.

Para preparar el paquete de papel

Prepare el paquete de papel antes de instalarlo en la impresora.

- Tenga cuidado de no dejar caer papel mientras prepara el paquete de papel.

- 1** Abra la tapa del paquete de papel y arranque las dos piezas (①) de los lados.

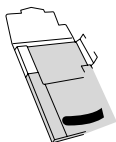

- 2** Con firmeza, vuelva a colocar la tapa a lo largo del pliegue (②).

- 3** Inserte la pestaña de la tapa dentro de la ranura (③) situada en la parte trasera del paquete.



■ Manipulación del paquete de papel

- Esta impresora determina el tipo de papel en función del paquete de papel instalado y selecciona automáticamente la configuración apropiada para ese papel. No trasvase papel a un paquete diferente.
- No trate de reutilizar papel que ya ha pasado por la impresora.
- El paquete de papel está hecho de cartón. Después de usar todo el papel, deseche el paquete siguiendo las normativas locales.
- No utilice un paquete de papel roto, deformado o con cualquier otra irregularidad, ya que pueden producirse daños.
- No prepare el paquete de papel en una zona con un nivel elevado de humedad, porque pueden producirse fallos de funcionamiento.
- No toque los paquetes de papel o el papel con las manos húmedas, ya que podrían producirse fallos de funcionamiento.
- Guarde el paquete de papel lejos de lugares con niveles elevados de temperatura, humedad o polvo, o que estén expuestos a la luz directa del sol.
- Al guardar el paquete de papel, asegúrese de cerrar la tapa.
- No deje paquetes de papel en un automóvil cerrado expuesto a un sol intenso.
- Utilice el papel lo antes posible, ya que de lo contrario podría decolorarse.

Instalación del paquete de papel

- 1** Deslice la cubierta del paquete de papel (situada en la parte superior de la impresora) en la dirección ①.

→ La cubierta del paquete de papel se abrirá en la dirección indicada por ②.

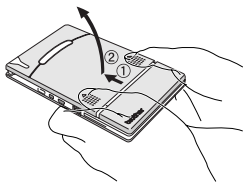

- 2** Inserte el paquete de papel.

La indicación del tipo de papel que aparece en el paquete debe quedar hacia arriba. El extremo del papel debe apuntar hacia usted.

Indicación del tipo de papel

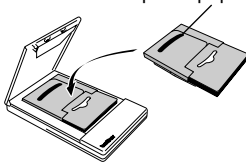

- Al cargar el paquete de papel, asegúrese de que lo ha alineado correctamente y de que el extremo final del papel no está doblado. De lo contrario, podría producirse un fallo en la alimentación.

- 3** Cierre la cubierta del paquete de papel en la dirección ③.

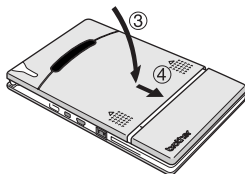

- 4** Deslice la cubierta del paquete de papel en la dirección ④.

Si el paquete de papel se ha cargado correctamente, se podrá ver la indicación del tipo de papel situada en el paquete a través de la ventana de comprobación de papel y la cubierta del paquete estará bloqueada.

Ventana de comprobación de papel

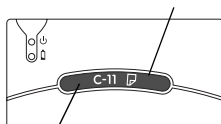

Indicación del tipo de papel



- No saque el papel del paquete; cargue el paquete directamente en la impresora.
- Para cambiar el tipo de papel, instale un paquete de papel diferente.
- Mientras la impresora está imprimiendo, no aplique presión sobre la ranura de salida de papel ni coloque ningún objeto sobre la impresora.

Ranura de salida de papel



Envío de datos desde un equipo o PC de bolsillo

Para que esta impresora imprima datos desde un equipo o PC de bolsillo (PDA con Pocket PC), se debe instalar primero el software correspondiente en el equipo o PC de bolsillo, tal y como se describe en la "Guía del software" suministrada con la impresora.

Envío de datos a través de la conexión IrDA

Un PC de bolsillo se puede comunicar con esta impresora a través de su puerto de infrarrojos IrDA.

- 1** Coloque la impresora y el PC de bolsillo de manera que sus puertos de infrarrojos IrDA estén uno frente al otro a una distancia no superior a 7,9" (20 cm).

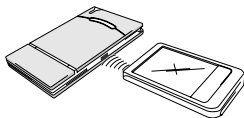

- 2** Empiece a imprimir desde el PC de bolsillo.

→ Mientras los datos se transmiten a través del puerto de infrarrojos IrDA, la luz indicadora de estado parpadea en verde.



- Durante la transmisión, no mueva la impresora ni el PC de bolsillo.
- Asegúrese de que no hay ningún obstáculo entre la impresora y el PC de bolsillo.
- Si la impresora está conectada mediante un cable USB o el PC de bolsillo está conectado a través de una conexión serie, no se puede utilizar la transmisión por infrarrojos.
- La transmisión por infrarrojos IrDA no es posible con los equipos personales.
- Para obtener información detallada, consulte el manual de instrucciones del PC de bolsillo.

Envío de datos a través de una conexión USB

Mediante el cable USB adjunto, la impresora se puede conectar a un equipo o PC de bolsillo que admita una interfaz USB.

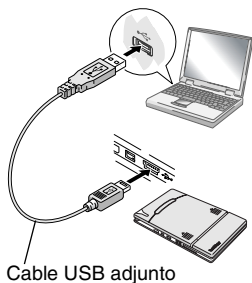

Alimentación del papel

Si se produce un fallo en la alimentación de papel, extraiga el papel tal y como se describe en el procedimiento siguiente.

Si el papel sobresale por la ranura de salida del papel:

- 1** Extraiga el papel tirando de él por la ranura de salida.

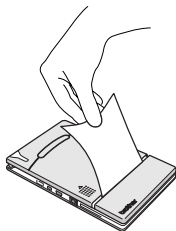

- Al tirar del papel, tenga cuidado de que no se rasgue.

Si el papel no sobresale por la ranura de salida del papel:

- 1** Abra la cubierta del paquete de papel.
- 2** Saque el paquete de papel.
- 3** Saque el papel que ha generado el error de alimentación.

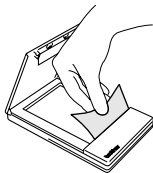

- Al tirar del papel, tenga cuidado de que no se rasgue.



- Tirar del papel hacia fuera no afectará al funcionamiento de la impresora.

Mantenimiento



- Asegúrese de apagar la impresora antes de limpiarla.

Limpieza de la impresora

Limpie la parte delantera de la impresora.

- 1 Elimine el polvo o la suciedad de la impresora pasando por encima un trapo suave y seco. Si la impresora está muy sucia, límpiela con un trapo ligeramente humedecido.



- No utilice benceno o disolventes, ya que la impresora podría decolorarse o deformarse.

Limpieza del sensor del paquete de papel

Si el sensor del paquete de papel está sucio, no podrá detectar correctamente el paquete de papel y pueden producirse fallos.

- 1 Limpie el sensor del paquete de papel con una torunda de algodón seca.



Sensor del paquete de papel

Limpeza del rodillo de captación

Si el rodillo de captación está sucio, pueden producirse problemas de alimentación del papel.

1 Pegue un trozo de cinta adhesiva en el rodillo de captación.

2 Quite la cinta adhesiva del rodillo de captación.

→ La suciedad que pudiera haber en el rodillo de captación se elimina al despegar la cinta.

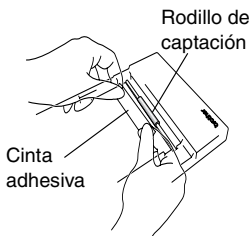

Gire el rodillo de captación y repita el procedimiento hasta limpiar toda su superficie.

Eliminación de la impresora

Antes de desechar la impresora, quite la batería de ión-litio integrada.

Extracción de la batería de ión-litio

1 Apague la impresora y desconecte el adaptador de CA.

2 Con un destornillador, afloje los cuatro tornillos situados en la parte trasera de la impresora y extraiga la cubierta trasera.

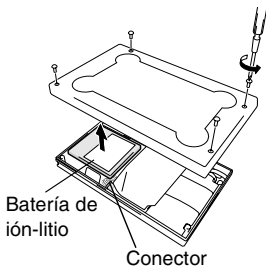

3 Desenchufe el conector y extraiga la batería de ión-litio.



- Al abrir la cubierta trasera, la garantía quedará invalidada. No quite la cubierta trasera a menos que tenga intención de desechar la impresora.
- La batería de ión-litio está fijada a la impresora con cinta adhesiva. Sujete la batería de ión-litio y tire de ella para sacarla de la impresora. Tenga cuidado de no tirar del cable.
- No tire del cable para desenchufar el conector.
- Existe riesgo de explosión si la batería se reemplaza por otra de un tipo incorrecto. Deseche las baterías usadas de acuerdo con las regulaciones locales para residuos especiales.

3 Apéndice

Especificaciones del producto

Especificaciones de la impresora

Indicadores		Luz indicadora de estado (roja/verde)
		Luz indicadora de carga (naranja)
Impresión	Método	Impresión térmica directa con un cabezal de impresión térmica de línea
	Resolución	300 ppp × 300 ppp
	Velocidad de impresión	15 segundos/hoja (texto estándar sobre papel térmico con cobertura del 7 % a una temperatura ambiente de 74,6 °F / 25 °C)
	Nº de páginas que se pueden imprimir	Se pueden imprimir unas 100 páginas de manera continua si la batería está completamente cargada (texto estándar sobre papel térmico con cobertura del 7 % a una temperatura ambiente de 74,6 °F / 25 °C)
Método de suministro de papel	Paquete de papel Brother, mecanismo automático de alimentación de papel	
Papel	Papel cortado A7 de Brother (2,9" (74 mm) × 4,1" (105 mm))	
Suministro eléctrico	Adaptador de CA de conmutación compacto para la carga, batería de ión-litio (integrada) de 7,4 V	
Interfaz	Interfaz serie (RS-232C) Compatible con USB versión 1.1 y un puerto de infrarrojos compatible con IrDA 1.2	
Dimensiones	3,9" (100 mm) (anchura) × 6,3" (160 mm) (profundidad) × 0,7" (17,5 mm) (altura)	
Peso	0,66 lbs. (300 g) (incluido el peso de la batería de ión-litio integrada y el de un paquete de papel con 50 hojas de papel térmico normal)	

Tamaños de papel (área de impresión)

Tipo normal	Tamaño A7: 2,9" (74 mm) × 4,1" (105 mm) (2,7" (69 mm) × 3,9" (100 mm))
Hojas de etiquetas (cuatro en vertical)	2,9" (74 mm) × 1,0" (26,25 mm) (2,7" (69 mm) × 0,8" (21,25 mm))
Hojas de etiquetas (dos en vertical)	2,9" (74 mm) × 2,1" (52,5 mm) (2,7" (69 mm) × 1,9" (47,5 mm))

Diagnóstico de problemas

Síntomas y soluciones

Síntoma: La impresora no se puede encender.	Solución: Pulse y mantenga pulsado el botón de encendido durante unos segundos. (→ Consulte la página 5.) Solución: Es necesario recargar la batería de ión-litio integrada. (→ Consulte la página 3.)
Síntoma: Aunque se ha dado la orden de imprimir, la impresora no imprime.	Con una conexión IrDA: Solución: Asegúrese de que no existen obstáculos entre la impresora y el PDA, y compruebe que se encuentran a menos de 7,9" (20 cm) de distancia. (→ Consulte la página 10.) Solución: Desenchufe el cable USB. (→ Consulte la página 10.) Solución: Desconecte el cable de conexión en serie. Con una conexión USB: Solución: Compruebe que la impresora está bien conectada al equipo mediante el cable USB. (→ Consulte la página 11.) Con una conexión en serie: Solución: Compruebe que la impresora esté conectada con seguridad al ordenador mediante el cable de conexión en serie.
Síntoma: Hay un fallo en la alimentación de papel.	Solución: Saque el papel. (→ Consulte la página 12.)

<p>Síntoma: Aunque se ha quitado el papel que ha causado el fallo de alimentación, no se puede cancelar el error.</p>	<p>Solución: Puede que haya quedado algún trozo de papel en la impresora. Póngase en contacto con el representante de ventas del establecimiento en el que la adquirió.</p>
<p>Síntoma: Una luz indicadora está iluminada o parpadea.</p>	<p>Solución: Consulte la explicación que aparece en la sección “Luces indicadoras” de la página 21.</p>
<p>Síntoma: El papel no entra en la impresora.</p>	<p>Solución: Asegúrese de que la tapa del paquete de papel está bien doblada a lo largo del pliegue (②). (→ Consulte la página 6.)</p> <p>Solución: Asegúrese de que la cubierta del paquete de papel está firmemente cerrada. (→ Consulte la página 9.)</p> <p>Solución: El papel puede estar sucio. Quite la primera hoja de la parte trasera del paquete de papel y vuelva a instalar el paquete. (→ Consulte las páginas 6 y 8.)</p> <p>Solución: Limpie el rodillo de captación. (→ Consulte la página 14.)</p>
<p>Síntoma: La impresión es débil (apenas perceptible).</p>	<p>Solución: Asegúrese de que la cubierta del paquete de papel está firmemente cerrada. (→ Consulte la página 9.)</p>

Síntoma: La cubierta del paquete de papel no se puede cerrar.

Solución: Las piezas indicadas con una "A" en la figura siguiente están bloqueadas. Consulte la figura y, con la punta de un bolígrafo, deslice la pieza indicada en la dirección de la flecha para liberarla.

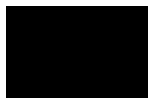
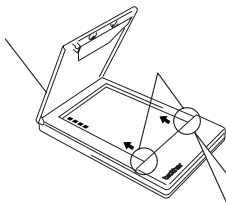

Libere la pieza del lado opuesto usando el mismo método

Luces indicadoras

■ Luz indicadora de estado

Una luz verde indica que la impresora está funcionando correctamente y una luz roja indica que se ha producido un error.



Color de la luz indicadora	Estado de la luz indicadora	Estado de la impresora
Verde	Encendida permanentemente	Esperando para recibir datos
	Parpadeando	Recibiendo datos
Rojo	Parpadeando	Se ha producido un error.
	Encendida permanentemente	Se ha producido un error en el sistema.

Si se ha producido un error, compruebe las siguientes causas posibles.

Descripción del error	Solución
No hay ningún paquete de papel instalado. El paquete de papel se ha instalado al revés. No queda papel.	Instale correctamente un paquete de papel que contenga papel.
Se ha producido un fallo en la alimentación de papel.	Saque el papel que ha provocado el fallo de alimentación.
Se ha producido un error de transmisión.	Compruebe el estado de la transmisión.
Se ha producido un error de sobrecalentamiento.	El interior de la impresora ha empezado a sobrecalentarse. Espere a que se enfríe.

Si se ha producido un error de sistema:
La impresora puede estar dañada. Póngase en contacto con el representante de ventas del establecimiento en el que la adquirió.

■ Luz indicadora de carga

La luz indicadora de carga permite comprobar el estado del suministro eléctrico. La luz indicadora de carga tiene dos funciones.



- ① Comprobación del estado de carga (cuando el adaptador de CA está conectado)

Color de la luz indicadora	Estado de la luz indicadora	Estado de la impresora
Naranja	Encendida permanentemente	En carga
	Apagada	Carga completada
	Parpadeando	Fallo en la batería integrada

- ② Comprobación del nivel de la batería (cuando la batería de ión-litio integrada se está agotando)

Estado de la luz indicadora	Nivel de la batería
Apagada	Nivel de carga superior al 60%
Parpadea una vez	Nivel de carga inferior al 60%
Parpadea dos veces	Nivel de carga inferior al 30%
Continúa parpadeando 3 veces	Casi vacía



- Cuando el nivel de carga de la batería sea inferior al 60%, recárguela.
- Si la luz indicadora de carga parpadea mientras la impresora está imprimiendo, conecte inmediatamente el adaptador de CA y cargue la batería. La impresora puede dejar de imprimir.

Accesorios de la unidad MW-120

Lote N°	Descripción
C-11	Papel térmico A7 (4,1" (105 mm) x 2,9" (74 mm))
C-21	Etiqueta A7 (4,1" (105 mm) x 2,9" (74 mm))
C-41	Hoja de etiquetas cortadas A7 (4/hoja) (1,0" (26,25 mm) x 2,9" (74 mm))
C-42	Hoja de etiquetas cortadas A7 (2/hoja) (2,1" (52,5 mm) x 2,9" (74 mm))
C-51	Papel carbón (2 hojas)
2S-100	Soporte de dos posiciones
PG-100	Guía de papel
PCS-100	Estuche para el transporte

Recuento:

50 hojas/paquete (papel térmico)

30 hojas/paquete (todos los demás)

brother®

Free Manuals Download Website

<http://myh66.com>

<http://usermanuals.us>

<http://www.somanuals.com>

<http://www.4manuals.cc>

<http://www.manual-lib.com>

<http://www.404manual.com>

<http://www.luxmanual.com>

<http://aubethermostatmanual.com>

Golf course search by state

<http://golfingnear.com>

Email search by domain

<http://emailbydomain.com>

Auto manuals search

<http://auto.somanuals.com>

TV manuals search

<http://tv.somanuals.com>