

OWNER'S
MANUAL

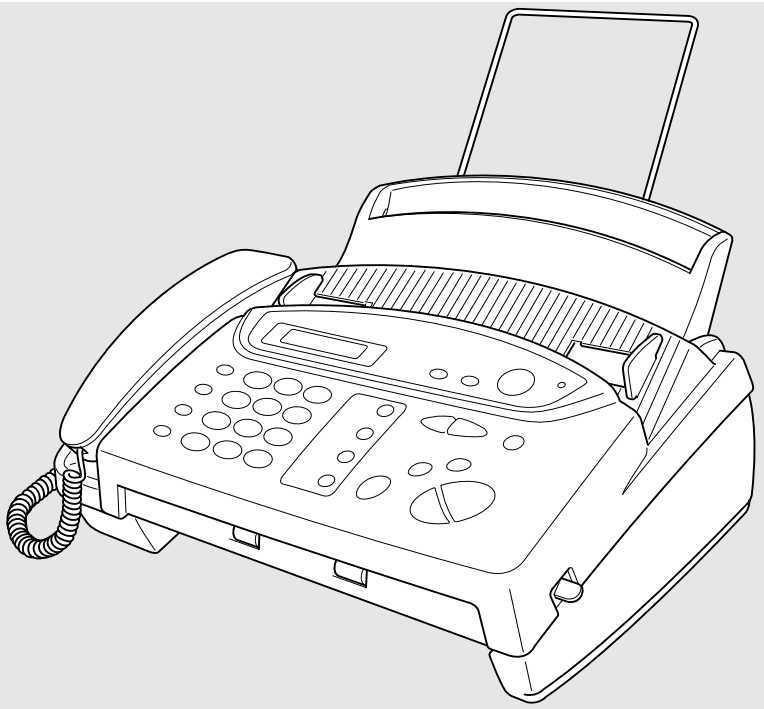

CE

FAX-T74 FAX-T76

.....

brother

Using This Manual

Thank you for purchasing a Brother fax machine (FAX).

This machine has been designed to be simple to use, with LCD screen prompts to guide you through functions. However, you can use your machine to its fullest potential by taking a few minutes to read this manual.



Additionally, your machine has a Help Key. Press **Copy/Help** and then press **Start** to print a list of basic operational steps and functions.

Finding Information

All chapter headings and subheadings are listed in the Table of Contents. You will be able to find information about a specific feature or function by checking the Index at the back of this manual. Also, throughout this manual, you'll see special symbols alerting you to important information, cross-references, and warnings. Illustrations of some screen displays also help you choose the correct key-presses.

Symbols Used In This Manual



Note or additional information.



The machine would be damaged or would not work correctly if this is not observed.



Warnings detail precautions you must take to avoid possible personal injury.

User-Friendly Programming

We have designed your fax machine with on-screen programming and a Help key. User-friendly programming helps you take full advantage of all the functions your machine has to offer. *See “Using This Manual”.*

Because you do all your programming on the LCD, we created step-by-step on-screen prompts to help you program your machine. All you need to do is follow the prompts as they guide you through the function menu selections and programming options and settings.

A complete list of the function selections, options, and settings that are available is provided in the appendix of this manual. *See “Function Selection Table” on page 78.*

Function Mode

You can access the Function Mode by pressing **Menu/Set**.

When you enter the Function Mode, your machine displays a list of main menu options from which you can choose. These options appear one after the other on the display. Select an option by pressing **Menu/Set** when the option appears on the LCD.

You can “scroll” more quickly through options by pressing **▶**. When the screen displays your selection, press **Menu/Set**. (Use **◀** to scroll backward if you passed your choice or to save key strokes. Both arrow keys show all options, in the opposite order.)

When you finish a function, the screen displays **ACCEPTED**.



If you want to exit the Function Mode, press **Stop**.

Alternating Displays

The LCD sometimes alternates between the currently selected option, and a help message giving brief instructions about how to proceed. The display you’ll probably see most often is shown below, showing you that when you place a document in the feeder, you can either dial a number to send it as a fax or press the copy key to make a copy of the document.

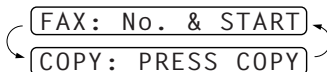

THIS EQUIPMENT IS DESIGNED TO WORK WITH A TWO WIRE ANALOGUE PSTN LINE FITTED WITH THE APPROPRIATE CONNECTOR.

APPROVAL INFORMATION

Brother advises that this product may not function correctly in a country other than which it was originally purchased, and does not offer any warranty in the event that this product is used on public telecommunication lines in another country.

Table of Contents

Using This Manual

User-Friendly Programming

| | |
|-------------------------|----|
| Table of Contents | iv |
|-------------------------|----|

PREPARATION AND SIMPLE USE GUIDE

| | |
|------------------------------|----|
| Control Panel Overview | 13 |
|------------------------------|----|

BASIC USE

Chapter 1 Setup

| | |
|--|----|
| Custom Settings | 17 |
| Setup Quick Dial Numbers for Easy Dialling | 18 |

Chapter 2 Sending a Fax

| | |
|---------------------------|----|
| Scanning Adjustment | 21 |
| Sending Operation | 21 |
| Dialling a Number | 22 |

Chapter 3 Receiving a Fax

| | |
|----------------------------|----|
| Answer Mode Settings | 24 |
| Receiving a Fax | 27 |

Chapter 4 Making Copies

| | |
|----------------------|----|
| Copy Functions | 29 |
|----------------------|----|

Chapter 5 Telephone

| | |
|------------------------|----|
| Making a Call | 31 |
| Answering a Call | 32 |

Chapter 6 Printing Reports

| | |
|---------------------------|----|
| Types of Reports | 33 |
| Transmission Report | 33 |
| Setting Reports | 33 |

ADVANCED USE

Chapter 7 Advanced Sending

| | |
|---------------------------|----|
| Advanced Operations | 35 |
|---------------------------|----|

Chapter 8 Advanced Receiving

| | |
|---|----|
| Operation from an External or Extension Telephone | 42 |
| Telephone Services | 43 |

| | | |
|-------------------|---|----|
| Chapter 9 | Polling | |
| | Polling Receive | 47 |
| | Polled Transmit | 49 |
| Chapter 10 | Remote Fax Options (FAX-T74) | |
| | Fax Forwarding | 51 |
| | Remote Retrieval | 51 |
| Chapter 11 | Message Manager (Only for FAX-T76) | |
| | Message Manager Mode | 56 |
| | Fax Forwarding/Paging | 61 |
| | Remote Retrieval | 62 |

MAINTENANCE

| | | |
|-------------------|--|----|
| Chapter 12 | Troubleshooting and Maintenance | |
| | Error Messages | 66 |
| | Clearing Jams | 67 |
| | Difficulty with Operation | 69 |
| | Regular Maintenance | 70 |
| Chapter 13 | Important Information | |
| | Important Safety Instructions | 75 |

APPENDIX

| | | |
|-------------------|--------------------------------|----|
| Chapter 14 | Specifications | |
| | Specifications | 77 |
| | Function Selection Table | 78 |
| | Entering Text | 81 |
| | About Fax Machines | 82 |
| | Glossary | 83 |
| | Index | 86 |
| | Accesssory List | 89 |

Preparation and Simple Use Guide

Simple steps to prepare and use the machine.

Follow these simple steps below to prepare and use the machine.

However, before you perform these steps, refer to the Important Safety Information, Precautions, Advice for Preparation and Simple Use Guide on page 5.

If you need further information, refer to BASIC USE or ADVANCED USE.

1 Make sure you have the items shown below.

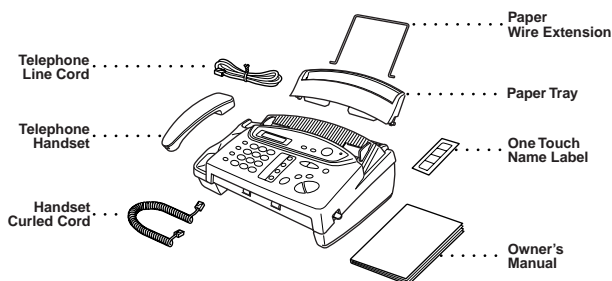

2 Attach the paper wire extension and paper tray.

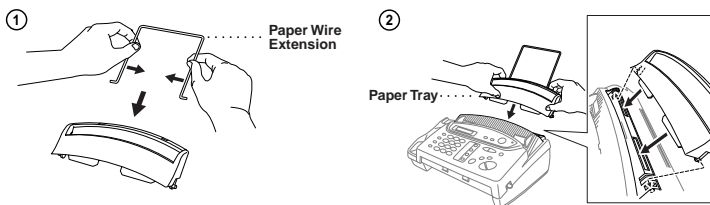

3 Remove Ribbon Protection Sheet.

- ① Open the top cover by lifting the lever on the right side of the top cover.

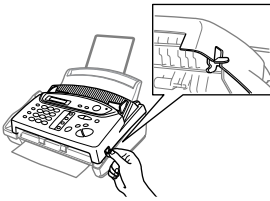

- ② Remove the ribbon protection sheet.

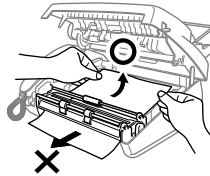

- ③ Remove the print cartridge and observe how the ribbon is wound on the print cartridge frame. Ensure that you purchase additional ribbons to reduce your printing costs.

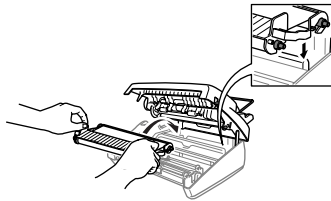

- ④ Close the top cover.

4 Load paper

- ① Place up to 30 sheets of paper in the paper tray.

Acceptable Paper

Size : A4

Weight : 64 g/m² – 90 g/m²

Thickness : 0.08-0.10 mm

Tap the stack of paper so the edges are even.

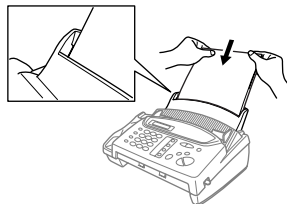
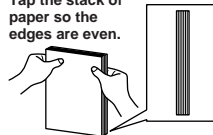

5 Connect the handset, power cord and telephone line cord.

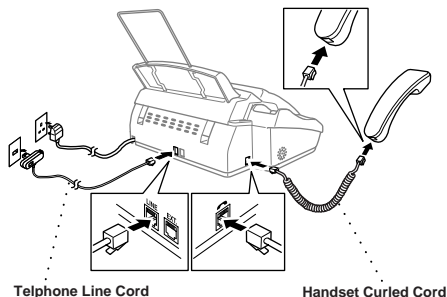

6 Set date and time

- ① Press **Menu/Set, 1, 2.**
- ② Enter the last two digits of the year, and press **Menu/Set.** "01" represents the year 2001 in the machine.
- ③ Enter two digits for the month and press **Menu/Set.**
- ④ Enter two digits for the day and press **Menu/Set.**
- ⑤ Enter the time in 24 hour format and press **Menu/Set.**
- ⑥ Press **Stop** to exit. (See "Setting the Date and Time" in this chapter.)

7 Set station ID

- ① Press **Menu/Set, 1, 3.**
- ② Enter your fax number (up to 20 digits) and press **Menu/Set.**
- ③ Enter your telephone number (up to 20 digits) and press **Menu/Set.**
- ④ Enter your name (up to 20 characters) using the dial pad and the chart.
 To enter a space press ► twice.
- ⑤ Press **Menu/Set.**
- ⑥ Press **Stop.** (See "Setting the Station ID" in this chapter.)

| Press Key | once | twice | three times | four times | five times |
|-----------|------|-------|-------------|------------|------------|
| 2 | A | B | C | 2 | A |
| 3 | D | E | F | 3 | D |
| 4 | G | H | I | 4 | G |
| 5 | J | K | L | 5 | J |
| 6 | M | N | O | 6 | M |
| 7 | P | Q | R | 7 | P |
| 8 | T | U | V | 8 | T |
| 9 | W | X | Y | 9 | W |

8 Using the telephone

- ① Pick up the handset.
- ② When you hear a dial tone, dial the number, using the dial pad.
- ③ To hang up, replace the handset on its cradle.

9 Sending a fax automatically

- ① Insert the document face down in the document feeder.
- ② Enter the fax number you want to call.
- ③ Press **Start**.
IMPORTANT : Do not pick up the handset.

10 Receiving a fax and a voice call

Press **Mode** to select how to receive calls.

FAX ONLY

The machine automatically answers every call as a fax call. You cannot receive a voice call, but you can dial out and make a voice call when the machine is idle.

FAX/TEL

The machine automatically answers every call. If the call is a fax, it prints the fax. If the call is not a fax, it signals you to pick up the handset.

MANUAL

You must answer all calls yourself.
If you hear fax tones, press **Start**.

TAD: ANSWER MACH

(FAX-T74)—This is the only setting in which you can use an **external** answering machine. When your telephone answering device (TAD) is connected to your machine, it will answer every call (see page 11, Connecting an External Telephone Answering Device (TAD)). Once the external telephone answering device (TAD) answers, the machine listens for fax tones. If it detects fax tones, it will receive the fax and print it.

The TAD setting works only with an external telephone answering device (TAD). Ring Delay and F/T Ring Time do not work in this setting.

TAD: MSG MGR

The FAX-T76 provides you with a built-in digital Message Manager for fax and voice. When you set the machine to answer calls, it will record up to 15 minutes of messages.

11 Making a Single Copy

- ① Place document face down in the feeder.
- ② Press **Copy/Help**.
- ③ Press **Copy/Help**. *See Chapter 4 for Multiple Copies, Reduce/Enlarge and Sort/Stack.*

Your machine cannot scan anything closer than 4 mm from the edge of the paper. Set the resolution to **S.FINE** or **PHOTO**.

12 Receiving Messages while outgoing (Only for FAX-T76)

- ① Press **Menu/Set, 8, 1**. The screen prompts you to choose a **DOC** (Document) setting.
- ② Press **◀** or **▶** to select **ON** (or **OFF**), and press **Menu/Set**.
The screen prompts you to choose a **VOICE** setting.
- ③ Press **◀** or **▶** to select your setting from the list (**ON**, **OFF** or **EXT**), and press **Menu/Set** when the screen displays your selection.
- ④ Press **Stop** to exit.
- ⑤ Press **Menu/Set, 8, 3**. The screen prompts you to choose an OGM.
- ⑥ Press **◀** or **▶** to reach **TAD MESSAGE**.
This is the only setting you can select if you want to turn the Message Manager on.
- ⑦ Press **Menu/Set**.
- ⑧ Press **◀** or **▶** to select **RECORD MSG** and press **Menu/Set**.
- ⑨ Pick up the handset to record a message.
For example: Hello. We are unable to take your call at this time. Please leave a message after the tone. If you wish to send a fax, please press *51, wait for the fax tones, then press the start button on your machine. See *“Recording the Message Manager’s Outgoing Message (TAD MESSAGE)” on page 57*.
- ⑩ Replace the handset. The Message Manager plays your OGM.
- ⑪ Press **Stop** to exit.
- ⑫ Activate Message Manager (TAD) Mode by pressing .

Advice for Preparation and Simple Use Guide

Packing

Whenever you transport the machine, use the packing materials that came with your machine and pack the machine correctly.

Choosing a Location

Place your fax machine on a flat, stable surface, such as a desk. Select a place that is free of vibration and shocks. Locate the machine near a telephone socket and a standard, earthed Mains socket.

Avoid placing your machine in a busy area. Do not place near heaters, air conditioners, water, chemicals or refrigerators. Do not expose the machine to direct sunlight, excessive heat, moisture or dust. Do not connect your machine to electrical outlets controlled by wall switches or automatic timers. Disruption of power can wipe out information in the unit’s memory. Do not connect your machine to electrical outlets on the same circuit as large appliances or other equipment that might disrupt the power supply. Avoid interference sources, such as speakers or the base units of cordless phones.

Connecting the Power Cord



- This fax must be earthed using a 3-pin plug.
- Since the machine is earthed through the power outlet, you can protect yourself from potentially hazardous electrical conditions on the telephone network by keeping the power to your machine on when you connect it to a telephone line. Similarly, you can protect yourself when you want to move your machine, by disconnecting the telephone line first, and then the power cord.
- Lightning and power surges can damage this product! We recommend that you use a quality surge protection device on the AC power line as well as on the telephone line, or unplug the lines during a lightning storm.

Memory Storage

Your machine is equipped with an internal battery that will keep the date and time information for up to about 15 hours (FAX-T76), about 9 hours (FAX-T74) after power has been cut off. After that time, the date and time will be lost and you will have to re-enter the information. In the event of a power failure, all settings in the **INITIAL SETUP**, **SETUP RECEIVE**, **SETUP SEND**, **SET QUICK-DIAL**, **REMOTE FAX OPT** and **SETUP TAD** functions are stored permanently except **POLLING RX**, **CONTRAST**, **RESOLUTION**, **OVERSEAS MODE**, **CALL RESERVE**, **TIMER** and **POLLED TX**.

On the FAX-T76, it will retain the data for Out-of-Paper Reception, Memory Transmission and Message Manager for up to 6 hours after a power interruption.

Setting the Date and Time

The screen displays, the date and time you set, whenever the machine is in stand-by mode. *It will* print the date and time on every fax you send.

In the event of a power failure, the machine maintains date and time information for about 15 hours. All other settings remain unaffected.

- 1** Press **Menu/Set**, **1**, **2**.
- 2** Enter the two digits of the year, and press **Menu/Set**. "01" is registered as 2001 in the machine.
- 3** Enter two digits for the month and press **Menu/Set**.
- 4** Enter two digits for the day and press **Menu/Set**.
- 5** Enter the time in 24 hour format and press **Menu/Set**.
- 6** Press **Stop** to exit.

Using the speakerphone

Instead of using the handset, you can press **Speaker Phone**.

On the FAX-T76, you can switch from handset to Speakerphone by pressing **Speaker Phone**, then replacing the handset. You can switch from Speakerphone to handset by lifting the handset.

Automatic Redial

See "*Dialling a Number*" on page 22.

If the line is busy when you send a fax using automatic transmission, the machine will automatically redial up to 4 times (3 times for Ireland) at 2 minute intervals.

Setting the Station ID

See “Set station ID”, step 7 in *Preparation and Simple Use Guide* (on page 3).

You can store your name, fax number, and telephone number, which will be printed on all fax pages that you send. See “*Electronic Cover Page*” on page 35.

It is important that you enter the fax and telephone numbers in the internationally standardised format, i.e. in accordance with the following strict sequence:

- The “+” (plus) character (by pressing * key)
- Your Country Code (e.g. “44” for the United Kingdom, “41” for Switzerland)
- Your local area code minus any leading “0” (“9” in Spain)
- A space
- Your number on the local exchange, using spaces to aid readability as appropriate.

As an example, If your machine was installed here at Brother International in the UK, your telephone number would be 0161 330 6531. You would therefore enter +44 161 330 6531 into your STATION ID.

- 1 Press **Menu/Set**, **1**, **3**.
- 2 Enter your fax number (up to 20 digits) and press **Menu/Set**.
- 3 Enter your telephone number (up to 20 digits) and press **Menu/Set**.
- 4 Enter your name (up to 20 characters) using the dial pad and the chart. To enter a space press ► twice.
- 5 Press **Menu/Set**.
- 6 Press **Stop**.



- When you enter your name, see “*Entering Text*” on page 81.
- The telephone number you enter is used only for the Call Back Message and Cover Page features.
- If you do not enter a fax number, no additional information can be entered.
- To enter a space, press ► once between numbers and twice between characters.
- If your Station ID has already been programmed, the screen prompts “1” to make a change, or “2” to exit without changing.

Setting the Document

- Documents must be between 14.8 and 21.6 cm wide, and 15 and 60 cm long. Your fax machine can only scan an image 20.8 cm wide, regardless of how wide the paper is.
- Make sure you insert documents face down, top edge first.

- Adjust the paper guides to fit the width of your document.

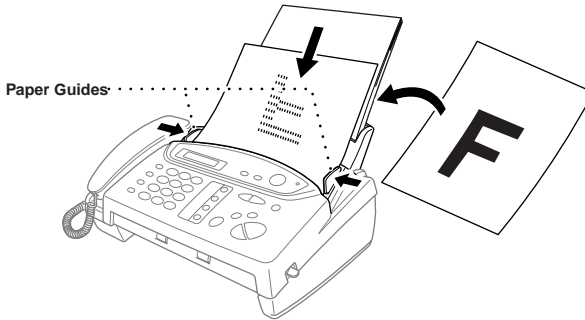

- The automatic document feeder (ADF) can hold up to 10 pages, feeding each one individually through the fax machine. Use standard ($64 \text{ g/m}^2 \sim 90 \text{ g/m}^2$) paper when using the ADF; if you're using heavier paper, feed each sheet individually to prevent paper jams.
- Press **Resolution** (before you send the fax) to select the resolution for the document you're sending. If you wish to send STANDARD resolution, i.e. a general fax with no graphics, then the default is STANDARD, and the resolution button need not be pressed.



- **DO NOT use, curled, wrinkled paper, folded, ripped paper, or paper with staples, paper clips, paste, or tape attached.**
- **DO NOT use, cardboard, newspaper, or fabric.**
- **DO NOT use paper on which correction fluid has been used**
- **Make sure documents written with ink are completely dry.**

Making a Copy

See "Making a Single Copy", step 11 in Preparation and Simple Use Guide (see page 4).



Do NOT pull the paper while copying is in progress. To cancel, press Stop.

Setting the Dialling Mode (Tone/Pulse)

Your machine is initially set to **TONE**. If you are using a **PULSE** dial line, you can change the setting to **PULSE** by following the steps below.

- 1 Press **Menu/Set**, **1**, **1**. The screen prompts you to select **TONE** or **PULSE**.
- 2 Use **◀** or **▶** to select the dialling mode, and press **Menu/Set** when the screen displays the dialling mode you want.
- 3 Press **Stop** to exit.



Although this equipment can use either Pulse or Tone signalling, only the performance of the Tone signalling is subject to regulatory requirements for correct operation. It is therefore strongly recommended that the equipment is set to use the Tone signalling for access to public or private emergency services. The Tone signalling also provides faster call set up.

Multi-Line Connections (PABXs)

Most offices use a central telephone system. While it is often relatively simple to connect the machine to a key system or a PABX (Private Automatic Branch Exchange), we suggest that you contact the company that installed your telephone system and ask them to connect the machine for you. It is advisable to have a separate line for the machine. You can then leave the machine in **FAX ONLY** Mode to receive faxes any time of day or night.

If the machine is to be connected to a multi-line system, ask your installer to connect the unit to the last line on the system. This prevents the unit from being activated each time a telephone call is received.

If you are installing the machine to work with a PABX:

- 1 It is not guaranteed that the unit will operate correctly under all circumstances with a PABX. Any cases of difficulty should be reported first to the company that handles your PABX.
- 2 If all incoming calls will be answered by a switchboard operator, it is recommended that the Answer Mode be set to **MANUAL**. All incoming calls should initially be regarded as telephone calls.
- 3 The unit may be used with either pulse or tone dialling telephone service.

Using Extension Telephones

It may be that your premises are already wired with parallel extension telephones, or you intend to add extension telephones to your line, in addition to your machine. While the simplest arrangement is straightforward parallel connection, there are some reasons as to why this arrangement will cause unsatisfactory service, the most obvious of which is inadvertent interruption of a facsimile transmission by someone picking up an extension telephone in order to make an outgoing call. Additionally, remote activation may not operate reliably in such a simple configuration.

This machine may also be set to make a delayed transmission (i.e. a transmission at a pre-set time). This pre-set job may coincide with someone picking up an extension handset.

Such problems can easily be eliminated however, if you arrange modification of your extension wiring circuit, such that extension devices are connected “downstream” of your machine, in a master/slave configuration. In such a configuration, this machine can always detect whether a telephone is in use, thus it will not attempt to seize the line during that time. This is known as “telephone off-hook detection.”

The inadvisable configuration is shown in figure 1 below, and the recommended master/slave configuration is shown in figure 2.

This new connection configuration can be arranged by your contacting BT, Kingston upon Hull Telecommunications, your PABX maintainer or a qualified telephone installation company as appropriate. Simply explained, the extension telephone circuit should be terminated on a normal modular plug (BT 431A style), which in turn should be inserted into the modular socket of the white “T”-shaped connector provided as part of the line cord assembly.

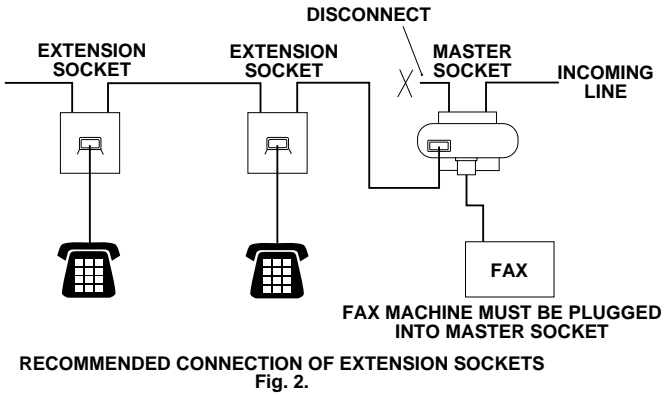
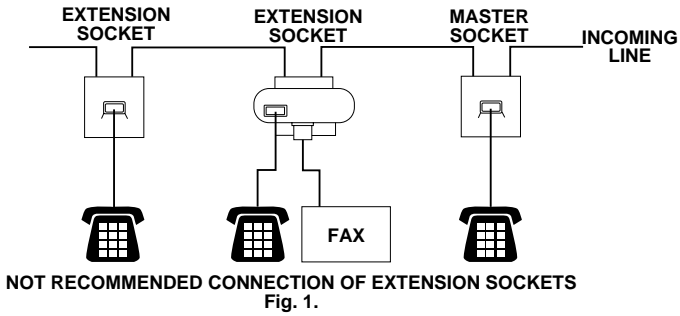

Connecting an External Telephone Answering Device (TAD)

Connections

- 1 You may connect an external TAD to your machine, as shown below.

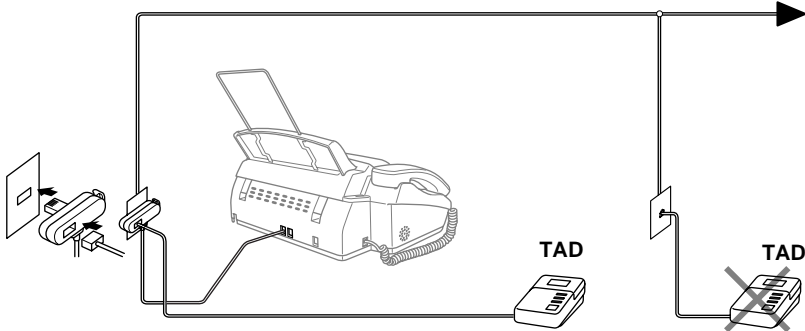

- 2 Set the number of rings to one or two on your external TAD. (The fax machine's Ring Delay setting does not apply.)
- 3 Record the outgoing message on your external TAD (see below).
- 4 Set the external TAD to answer calls.
- 5 Set **MESSAGE STORE** (Function menu 8-1) to **VOICE:EXT.** (Only for FAX-T76)
- 6 Set the Answer Mode to **TAD:ANSWER MACH.** (Only for FAX-T74)
On the FAX-T76, set the Answer Mode to **TAD:MSG MGR.**



Do not connect a TAD elsewhere on the same phone line—your machine and TAD will both try to control the line.

Outgoing Message (OGM) of External TAD

Timing is important in recording this message.

- 1 Record four seconds of silence at the beginning of your message. (This allows your machine time to listen for the fax CNG tones of automatic transmissions before they stop.)
- 2 Try to record the shortest possible message on your telephone answering device (ideally less than 10 seconds).
- 3 End your message by giving your Remote Activation Code for people sending manual faxes. For example:

“After the beep, leave a message or send a fax manually by pressing *51.”

Please note that some faxes that are sent manually cannot be received automatically because some fax machines do not send a fax tone in manual mode. In these cases you must inform callers that they must enter the remote activation code to send a fax.

Sequence of External TAD Reception

When you leave your machine set in TAD mode, all calls will be answered by the externally connected telephone answering device, and fax calls will be received automatically provided they come from a machine which sends standard Calling tone (CNG).

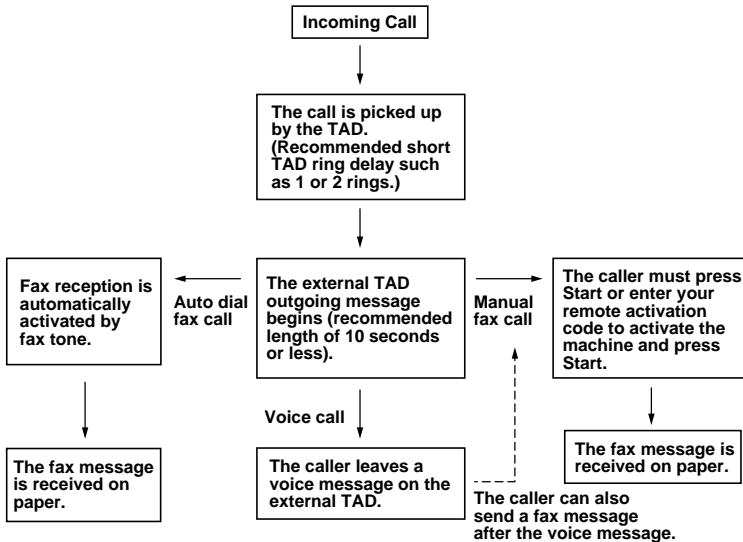

Connecting an External Telephone

Your machine is equipped with a handset that you can use as a regular phone. However, you can also connect a separate telephone to your machine, as shown below.

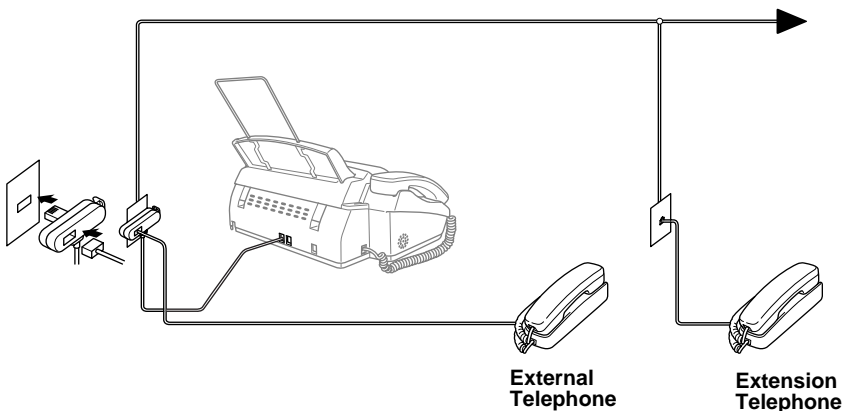

Whenever this external phone (or TAD) is in use, the screen displays **EXT. TEL IN USE**, and, if the fax handset is lifted, an alarm sounds.

To disconnect the call on the external phone and switch to the fax, lift the handset and press **Tel** (FAX-T74) or **Speaker Phone** (FAX-T76).

Control Panel Overview

FAX-T74

PREPARATION
AND SIMPLE USE

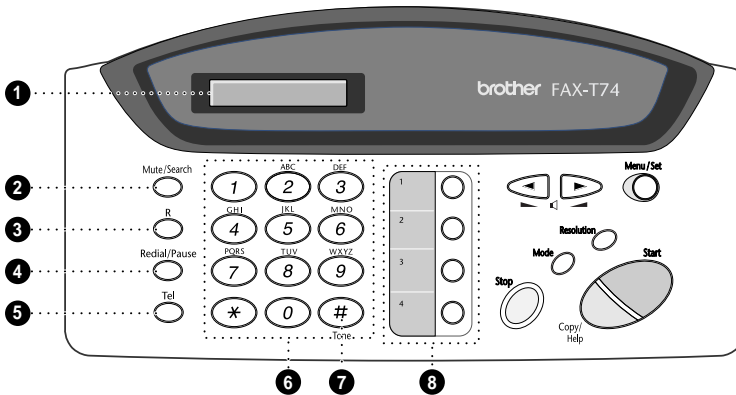

1 Liquid Crystal Display

The LCD displays messages to help you set up and operate your fax machine.

2 Mute/Search

Lets you put calls on hold. Also, lets you dial stored phone numbers by pressing # and a two-digit number. Also lets you look up numbers stored in the dialing memory.

3 R

Use this key to gain access to an outside line and/or to recall the operator or transfer a call to another extension when it is connected to a PABX.

4 Redial/Pause

Redials the last number called. Also inserts a pause in autodial numbers.

5 Tel

Use to shuttle the line between handset and monitor speaker.

6 Dial Pad

Dials phone and fax numbers, and can be used as a keyboard for entering information into the fax machine.

7 Tone

Lets you switch the dialling type during a telephone call from PULSE to TONE.

8 One Touch Dial Keys

These 4 keys give you access to 4 previously stored phone numbers.

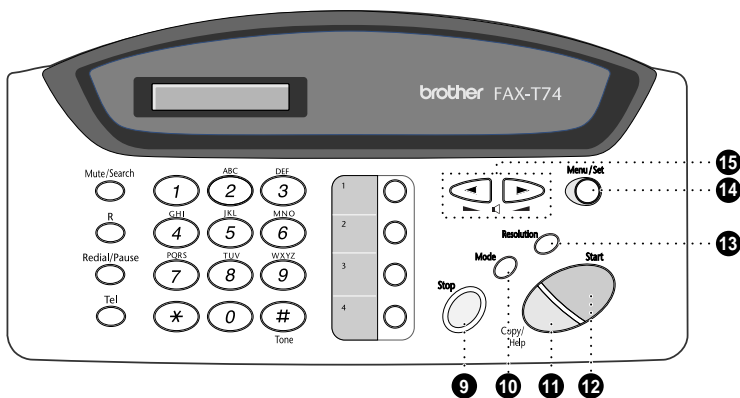

9 Stop

Stops a fax, cancels an operation, or exits from function menu mode.

10 Mode

Use to select how the fax machine will handle incoming calls.

11 Copy/Help

Makes a copy. If no originals are in the ADF, it prints a quick reference Help List.

12 Start

Starts an operation, such as sending a fax.

13 Resolution

Sets the resolution when you send a fax or make a copy.

14 Menu/Set

Lets you access the function menu and programming mode. Also, stores a function setting into the fax machine.

15 ◀ (Left Arrow)

▶ (Right Arrow)

◀ ◻ ▶ (Volume)

Moves the LCD cursor to the left or right. Adjust speaker and ring volume.

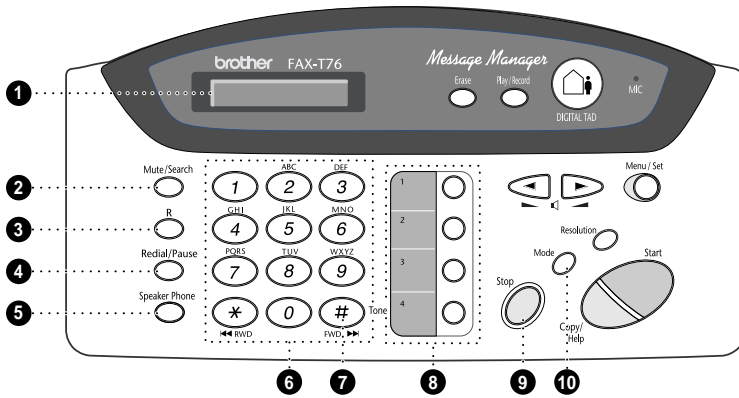

1 Liquid Crystal Display

The LCD displays messages to help you set up and operate your fax machine.

2 Mute/Search

Lets you put calls on hold. Also, lets you dial stored phone numbers by pressing # and a two-digit number. Also lets you look up numbers stored in the dialing memory.

3 R

Use this key to gain access to an outside line and/or to recall the operator or transfer a call to another extension when it is connected to a PABX.

4 Redial/Pause

Redials the last number called. Also inserts a pause in autodial numbers.

5 Speaker Phone

Lets you speak to the person at the other end and dial telephone and fax numbers without lifting the handset.

6 Dial Pad

Dials phone and fax numbers, and can be used as a keyboard for entering information into the fax machine.

7 Tone

Lets you switch the dialling type during a telephone call from PULSE to TONE.

8 One Touch Dial Keys

These 4 keys give you access to 4 previously stored phone numbers.

9 Stop

Stops a fax, cancels an operation, or exits from function menu mode.

10 Mode

Use to select how the fax machine will handle incoming calls.

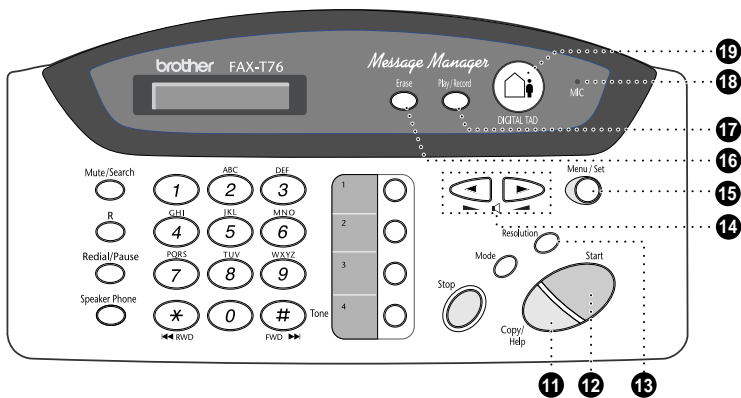

11 Copy/Help

Makes a copy. If no originals are in the ADF, it prints a quick reference Help List.

12 Start

Starts an operation, such as sending a fax.

13 Resolution

Sets the resolution when you send a fax or make a copy.

14 ◀ (Left Arrow)

▶ (Right Arrow)

◀ ◻ ▶ (Volume)

Moves the LCD cursor to the left or right. Adjust speaker and ring volume.

15 Menu/Set

Lets you access the function menu and programming mode. Also, stores a function setting into the fax machine.

16 Erase

Lets you delete voice messages, fax messages or all messages.

17 Play/Record

Lets you listen to voice messages and print fax messages stored in memory. This also lets you record telephone calls.

18 MIC (Microphone)

Picks up your voice when you speak to another party using Speaker Phone.

19 DIGITAL TAD

Lets you activate Message Manager. Also, notifies you that you have voice or fax messages in the memory.

1 Setup

Custom Settings

Volume Settings

Beeper Volume

You can set the beeper to **LOW**, **HIGH** or **OFF**. The machine comes set to **LOW**. When the beeper is set to **LOW** or **HIGH**, the machine beeps every time you press a key or make an error, and at the end of sending or receiving a fax.

- 1 Press **Menu/Set**, **1**, **4**.
- 2 Press ◀ or ▶ to select your setting.
- 3 When the screen displays the setting you want, press **Menu/Set**.
- 4 Press **Stop** to exit.

Speaker Volume

You can adjust the speaker volume. If you have FAX-T74, you must lift the handset, then press **Tel** before you can adjust the volume. If you have FAX-T76, press **Speaker Phone**.

Press ▶ or ◀ to adjust the volume level. The display shows the setting you are choosing. Each key press changes the volume to the next setting. The new setting will remain until you change it again.



If you have FAX-T76, you can adjust the speaker volume while you are listening to your OGM (Outgoing Message) and ICMs (incoming messages).



If you turn Incoming Recording Monitor to **OFF (Menu/Set, 8, 5)** on the FAX-T76, the Speaker for screening calls will be disabled and you won't hear callers leaving messages. The volume for other operations can still be controlled using ▶ and ◀.

Ring Volume

You can adjust the ring volume when your fax machine is idle. You can select a ring volume level or press ▶ or ◀ until the ring is off.

Press ▶ or ◀ to adjust the volume level. With each key press, the fax machine rings so you can hear the current setting and the display shows the setting you are choosing. Each key press changes the volume to the next setting. The new setting will remain until you change it again.

PABX and TRANSFER

Your machine is initially set to be connected with PSTN (Public Switched Telephone Network) lines. However many offices use a central telephone system or Private Automatic Branch Exchange (PABX). Your fax can be connected to most types of PABX. You can gain access to the outside line from your fax connected to PABX by just pressing **R**.

Also, you can transfer a call to another extension by pressing **R**.

Setting PABX

If your machine is connected to a PABX system, set **PBX:ON**. If not, set **OFF**.

- 1 Press **Menu/Set, 1, 5**. The screen displays
- 2 Press **◀** or **▶** to select **ON** (or **OFF**), and press **Menu/Set** when the screen displays your selection.
- 3 Press **Stop** to exit.

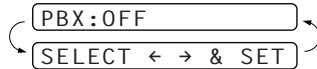

You can program an **R** keypress as part of a number stored in a One Touch or Speed Dial location. When programming the One Touch or Speed Dial number (Function menu 6-1 or 6-3) press **R** first (the screen displays “!”), then enter the telephone number. If you do this, you do not need to press **R** each time before you dial using a One Touch or Speed Dial location. See “*Storing One Touch Dial Numbers*” on page 18, and “*Storing Speed Dial Numbers*” on page 19. However, if PBX is set to OFF, you can’t use the One Touch or Speed Dial number that an **R** keypress is programmed into.

Setting the Clock Change

You can easily let the machine’s clock gain or lose one hour by using this feature.

- 1 Press **Menu/Set, 1, 6**. The screen displays
- 2 Press **◀** or **▶** to select Summer Time to gain an hour or Winter time to lose an hour, and press **Menu/Set**.
- 3 Press **1** to change to Winter Time or Summer Time—**OR**—Press **2** to exit without changing.

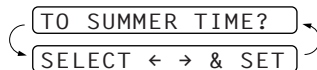

Setup Quick Dial Numbers for Easy Dialling

You can set up Quick Dial numbers (three types) for easy dialling: One Touch, Speed Dial and Groups for Broadcasting of faxes.

Storing One Touch Dial Numbers

You can store 4 fax/phone numbers that you can dial by pressing one key. You can also store names with these numbers. When you press a One Touch key, the screen displays the name or number as the call is dialled. See “*One Touch Dialling*” on page 22.



One Touch keys are not the dial pad keys. They are the 4 keys (numbers 1-4) located to the right of the dial pad.

- 1 Press **Menu/Set, 6, 1**.
- 2 Press the One Touch key where you want to store a number. The screen displays the location you selected.
- 3 Enter a number (up to 20 digits), and press **Menu/Set**. The screen prompts you to enter a name for this number.
- 4 Use the dial pad to enter the name (up to 15 characters). See “*Entering Text*” on page 81—**OR**—Go to Step 5 to store the number without a name.

- 5 Press **Menu/Set**. The screen prompts you to select the type of number this is. Use ◀ or ▶ to select the type you want.

FAX a fax only number
TEL a telephone (voice) number
F/T both a fax and telephone (voice) number

- 6 Press **Menu/Set**. Return to Step 2 to store another One Touch dial number—**OR**—Press **Stop** to exit.

When you dial a One Touch dial number, the screen displays the name you've stored, or, if you haven't stored a name, the number you've stored.

Storing Speed Dial Numbers

You can store Speed Dial numbers, which you dial by pressing only four keys. There are 50 Speed Dial locations. Even if you lose electrical power, numbers stored in memory will not be lost.

- 1 Press **Menu/Set, 6, 2**.

The screen prompts you to enter a location.

SPEED-DIAL? #

- 2 Use the dial pad to enter a two-digit location (00–50).

- 3 Press **Menu/Set**. The screen displays your entry, then prompts you to enter the number you're storing.

#05:
 ENTER & SET

- 4 Enter the number (up to 20 digits).

- 5 Press **Menu/Set**. The screen now prompts you to store a name with this number.

NAME:

- 6 Use the dial pad to enter the name (up to 15 characters).

You can use the chart of *“Entering Text” on page 81* to help you enter letters. —**OR**— Press **Menu/Set** and go to Step 8 to store the number without a name.

- 7 Press **Menu/Set**.

- 8 The screen prompts you to select the type of number this is. Use ◀ or ▶ to select the type you want.

FAX a fax number
TEL a telephone (voice) number
F/T both a fax and telephone number

- 9 Press **Menu/Set**.

- 10 Return to Step 2 to store another Speed Dial number. —**OR**— Press **Stop** to exit.

Changing One Touch and Speed Dial Numbers

If you try to store a One Touch or Speed Dial number in a location where a number is already stored, the screen displays the current name stored there, then prompts you to either change it or exit.

1.CHANGE 2.QUIT

- 1** Press **1** to change the number stored, or press **2** to exit without making a change.
- 2** Enter a new number.
 - ◆ If you want to erase the number, press **Stop** when the cursor is to the far left of the digits.
 - ◆ If you want to change a digit, use ◀ or ▶ to position the cursor under the digit you want to change, then enter it.
- 3** Follow the directions in Storing One Touch Dial or Speed Dial Numbers.

Scanning Adjustment

Contrast

If your document is very light or very dark, you might want to set the contrast accordingly. Use **LIGHT** to send a light document. Use **DARK** to send a dark document.

- 1 Insert the document, face down, in the feeder.
- 2 Press **Menu/Set, 3, 3**.
- 3 Use **◀** or **▶** to select **AUTO, LIGHT, or DARK**.
- 4 When the screen displays your selection, press **Menu/Set**. The screen displays:
- 5 Press **2** if you have finished choosing settings, and go to Step 6—**OR**—Press **1** if you want to select additional settings. The display returns to Setup Send menu.
- 6 Enter a fax number and press **Start** to send a fax.

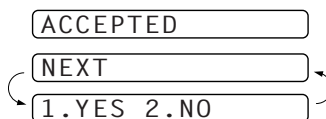

Resolution

When you have a document in the feeder, you can use the **Resolution** key. Press **Resolution** continuously until you see your selection on the screen. If you want to set a different resolution for each page, see *“Multiple Resolution Transmission” on page 41*.

- Standard:** suitable for most typed documents.
- Fine:** good for small print; transmits a little slower than standard resolution.
- Super Fine:** good for small print or artwork; transmits slower than fine resolution.
- Photo:** use when document has varying shades of grey; slow transmission time.

Sending Operation

Manual Transmission

Manual transmission lets you hear the dial tone, ringing and fax receiving tones before sending the fax.

- 1 Insert the document face down in the feeder.
- 2 Pick up the handset and listen for a dial tone—**OR**—press **Speaker Phone**.
- 3 Enter the fax number you want to call. See *“Dialling a Number” on page 22*.
- 4 When you hear the fax tone, press **Start**. If you’re using the handset, hang up.

Automatic Transmission

This is the easiest way to send a fax.

IMPORTANT: Do **not** pick up the handset—**OR**—press **Speaker Phone**.

- 1 Insert the document face down in the feeder.
- 2 Enter the fax number you want to call. See *“Dialling a Number” on page 22*.
- 3 Press **Start**.

Dialling a Number

If you are sending a fax, press **Start** after pressing the Quick-Dial key. If you picked up the handset, press **Start** when the receiving fax machine answers with fax tones.

One Touch Dialling

- 1 Pick up the handset—**OR**—Press **Speaker Phone**.
- 2 When you hear a dial tone, press the Quick-Dial key of the location you want to call. See *“Storing One Touch Dial Numbers” on page 18*.
- 3 To hang up, replace the handset—**OR**—Press **Speaker Phone**.



If you try to use a One Touch location with no number stored in it, you hear a warning sound, and screen displays **NOT ASSIGNED**. The display returns to normal after 2 seconds.

Speed Dialling

- 1 Pick up the handset—**OR**—Press **Speaker Phone**.
- 2 When you hear a dial tone, press **Mute/Search**, press **#**, then press the two-digit Speed Dial number.
- 3 To hang up, replace the handset—**OR**—Press **Speaker Phone**.



If you are sending a fax, press **Start** after pressing the Speed Dial number. If you picked up the handset, press **Start** when the receiving fax machine answers with fax tone.

Search

You can search for names you have stored in One Touch and Speed Dial memories. Names are displayed alphabetically.

- 1 Pick up the handset—**OR**—Press **Speaker Phone** and press **Mute/Search**.
- 2 Enter the first letter of the name you're looking for using the dial pad.
- 3 Press **◀** or **▶** to search the memory.
- 4 Press **Start** to begin dialling.
- 5 When the call is over, hang up, or press **Speaker Phone**.

Redial

If you're sending a fax manually and the line is busy, you can retry the number by pressing **Redial/Pause**.

- 1** Press **Redial/Pause**.
- 2** Press **Start**. (Only for Ireland)

3 Receiving a Fax

Answer Mode Settings

Select Answer Mode

Manual—You must answer all calls yourself. If you hear fax tones, press **Start** or key * 5 1 from an extension phone to begin receiving the fax, then hang up.

Fax Only—The machine automatically answers every call as a fax call. You cannot receive a voice call, but you can dial out and make a voice call.

F/T—The machine automatically answers every call. If the call is a fax, it prints the fax. If the call is not a fax, it signals you with an F/T pseudo-ring, different from the phone company ringing, to alert you to pick up the call. If you select this setting, you'll need to set the Ring Delay and F/T Ring Time features (on the following pages). *See "For F/T (Fax/Tel) Mode Only" on page 42.*

TAD (FAX-T74)—This is the only setting in which you can use an **external** answering machine. Your telephone answering device is connected to your machine via the socket in the line cord plug, and answers every call. Once the external telephone answering device (TAD) answers, the machine listens for fax tones. If it detects fax tones, it receives the fax.

The TAD setting works only with an external telephone answering device (TAD). Ring Delay and F/T Ring Time do not work in this setting.

TAD (FAX-T76)—The FAX-T76 provides you with a built-in digital Message Manager for fax and voice. When you set the machine to answer calls, it will record up to 15 minutes of messages. *See "Message Manager (Only for FAX-T76)" on page 56* for more information.

FAX-T74

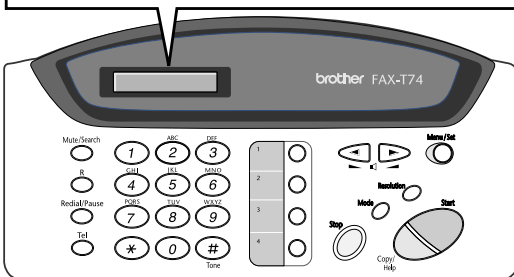
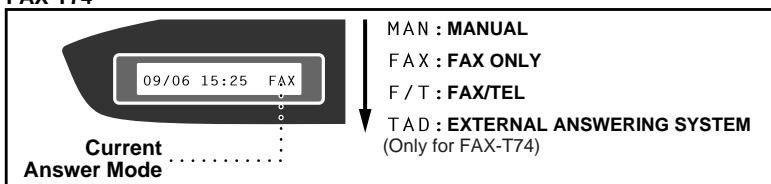

FAX-T76

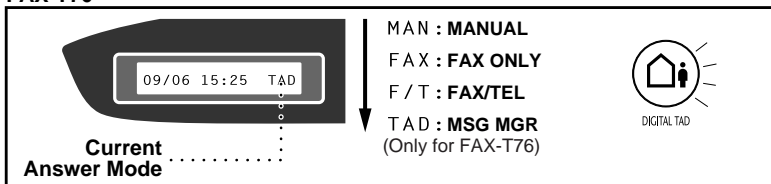

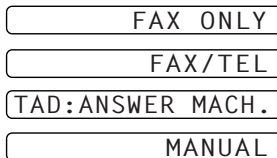

To select or change your Answer Mode

- 1 Press **Mode**. The screen displays your current selection.
The options on the FAX-T74 are:

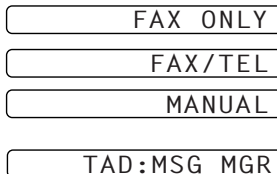

The options on the FAX-T76 are:



Or, if TAD Mode is switched **ON** by pressing  (**DIGITAL TAD** button), it overrides your Answer Mode Setting, so the display shows:

- 2 Continue to press **Mode** until your new selection appears. After 2 seconds, the screen returns to the date and time display, along with your new Answer Mode setting.



If you're changing Answer Mode while in another operation, the screen returns to the current operation display.

Setting the Ring Delay

The Ring Delay setting determines the number of times the machine rings before it answers. See *“Operation from an External or Extension Telephone” on page 42*. Also see *“For F/T (Fax/Tel) Mode Only” on page 42*.

- 1 Press **Menu/Set, 2, 1**. If you have a FAX-T74, go to Step 3.
- 2 Press **◀** or **▶** to select **RING DELAY**, and press **Menu/Set**.
- 3 Press **◀** or **▶** to select how many times the line rings before the machine answers, and press **Menu/Set** when the screen displays your selection.
- 4 Press **Stop** to exit.

Setting the F/T Ring Time

You need to determine how long the machine will give its special F/T pseudo-ring when you have a voice call. This ringing happens after the initial ringing from the phone company. Only the machine rings for 20, 30, 40, or 70 seconds; no other phones on the same line during the special F/T pseudo-ring.

- 1 Press **Menu/Set, 2, 2**.
- 2 Press **◀** or **▶** to select how long the machine will ring to alert you that you have a voice call, and press **Menu/Set** when the screen displays your selection.

- 3 Press **Stop** to exit.



Even if the caller hangs up during the F/T pseudo-ringing, the machine continues the F/T pseudo-ringing for the set time.

Please note that some faxes cannot be received automatically in F/T mode, because some fax machines do not send the standard Group 3 calling tone (“CNG”), but this is not common.



This machine does not generate ringing conditions to any extension telephones. Any such extension telephones will only ring during the period set on ring delay.

Recording the Fax/Tel Outgoing Announcement (F/T MESSAGE) (Only for FAX-T76)

This is the announcement played by your machine (not an external TAD) when someone calls and your machine is set to F/T mode. Although callers hear your announcement, they cannot leave a message. See “*Erasing the Outgoing Message (OGM)*” on page 57 for directions to erase the announcement.

- 1 Press **Menu/Set**, **8**, **3**. The screen prompts you to choose **F/T MESSAGE**, **TAD MESSAGE** or **PAGING MSG**.
- 2 Press **◀** or **▶** to select **F/T MESSAGE**, and press **Menu/Set**.
- 3 Press **◀** or **▶** to select **RECORD MSG** and press **Menu/Set**, then pick up the handset to record a message.
- 4 Replace the handset. Your announcement is played.
- 5 Press **Stop** to exit.



It is not necessary to have an outgoing message. The F/T mode will work fine without one. It is only to help the caller understand the status of your machine.

For example, you can leave a message that says:

“Hello, please wait, we are trying to connect you. If you wish to send a fax, please wait until you hear a fax tone and press the Start key, or, press * 5 1 (your three-digit remote activation code) and press the Start key.”

Fax Detect

When you use this feature, you don't have to press **Start** when you answer a fax call and hear calling beeps. Just hold the handset and wait for several seconds. When you see **RECEIVE** on the fax screen or when you hear "chirps" through the handset of an extension phone connected to another wall jack, just replace the handset, and your machine does the rest (see page 10 fig.2).

- Selecting **ON** allows the machine to receive fax calls automatically, even if you lift the handset of an extension phone or a phone or TAD connected to the machine.
- Selecting **SEMI** lets the fax machine receive the call only if you've answered it at the machine.
- Selecting **OFF** means you'll have to activate the machine yourself, by pressing **Start** or by pressing * **5 1** if you are not at your machine. *See "Operation from an External or Extension Telephone" on page 42. Also see "For F/T (Fax/Tel) Mode Only" on page 42.*

In case Fax Detect does not work, because of a poor phone line connection, just press **Start** or press the Activation Code * **5 1**. (You have to set Remote Activation to **ON** in **Menu/Set, 2, 4** to use * **5 1**.)

- 1 Press **Menu/Set, 2, 3**.
- 2 Use ◀ or ▶ to select **ON, SEMI** or **OFF**, and press **Menu/Set** when the screen displays your selection.
- 3 Press **Stop** to exit.

If you've set the feature to **ON**, but your machine doesn't automatically connect a fax call when you lift an external or extension phone handset, press * **5 1**.

At the machine, lift the handset and press **Start**.

Receiving a Fax

Printing a Reduced Incoming Document

You can always reduce the size of an incoming fax to a fixed percentage with your machine. If you choose **AUTO**, the machine chooses the level of reduction for you regardless of the original size of the incoming document.

- 1 Press **Menu/Set, 2, 5**. The screen displays
- 2 Use ◀ or ▶ to select the reduction ratio you want—**AUTO, 100%, 93%, 87%**, or **75%**. Choose **100%** if you don't want a reduction.
- 3 Press **Menu/Set** when the screen displays your selection.
- 4 Press **Stop** to exit.

5 . REDUCTION



If you receive faxes that are split on two pages, change the reduction to **AUTO**—OR—choose a lower reduction percentage.



- When you use Auto Reduction to reduce incoming documents to fit on one page of recording paper, you can do so only as long as the original document is not longer than 35 cm. If the original is longer than 35 cm, the data will not be reduced and will carry over to print on a second page.
- When you use Auto Reduction and you receive an incoming document that is smaller than your recording paper, no reduction will take place, and you will get the same size recorded as the original.

Reception into Memory

As soon as the paper cassette becomes empty during fax reception, the screen will display “**CHECK PAPER**”; please put some paper in the paper cassette. See “*Load paper*” on page 2.

If the MEMORY RECEPTION switch is ON at this time...

The current fax reception will continue, with the remaining page(s) being stored in memory, subject to available memory. Subsequent incoming faxes will also be stored into memory until the memory is full, following which no further incoming fax calls will be automatically answered; all data will be printed as soon as fresh paper is put in the paper cassette.

If the MEMORY RECEPTION switch is OFF at this time...

The current fax reception will continue, with the remaining page(s) being stored in memory, subject to available memory. Subsequent incoming fax calls will not be automatically answered until fresh paper is put in the paper cassette. The last fax received will be printed as soon as fresh paper is put in the cassette.

1 Press **Menu/Set, 2, 6**. The screen displays

6 . MEM . RECEIVE

2 Use ◀ or ▶ to select **ON** or **OFF**, and press **Menu/Set** when the screen displays your selection.

3 Press **Stop** to exit.

Printing a Fax from Memory (Only for FAX-T74)

If you have fax storage ON for remote retrieval, you can still print a fax from the machine’s memory when you are at your machine. See “*Setting Fax Storage*” on page 51.

1 Press **Menu/Set, 8, 4**.

2 Press **Start**.

3 Press **Stop**.

Copy Functions

To make a single copy that is not reduced, enlarged or sorted, you only have to press one key. The default resolution for a single copy is Super Fine. Set the resolution to PHOTO for photographs. Remember, your machine cannot scan anything closer than one-eighth inch from the edge of the paper.

Making a Single Copy

- 1 Place the original face down in the ADF.
- 2 Press **Copy/Help** twice.
To cancel, press **Stop**.
Do NOT pull on the paper while copying is in progress.

Copy Options: Single or Multiple Copies, Reduce/Enlarge, Sort/Stack

You can choose additional copy options. First, you can select the number of copies. Next, you can choose whether multiple copies will be STACKED (all copies of page 1, then all copies of page 2, etc.) or SORTED (collated). Finally, you can choose an enlargement or reduction ratio. To automatically reduce the copy to the paper size you have set for the paper tray, select **AUTO**. To reduce the copy by a fixed percentage, choose **93%**, **87%**, **75%** or **50%**. Or, to enlarge the copy, select **150%**, **125%** or **120%**. To copy a document at its original size, select **100%**.

- 1 Place the original face down in the ADF.
- 2 Press **Copy/Help**.
- 3 Enter the number of copies you want (1-99).
For example: Press 9 for nine copies.
To start copying now, press **Copy/Help**.
If you would like to select additional copy options, like **SORT**, **ENLARGE** or **REDUCE**, press **Menu/Set**.
- 4 Press ◀ or ▶ to select **SORT** or **STACK**.
For example: Select **SORT**.
To start copying now without enlarging or reducing, press **Copy/Help**.
To reduce or enlarge the image, press **Menu/Set**.

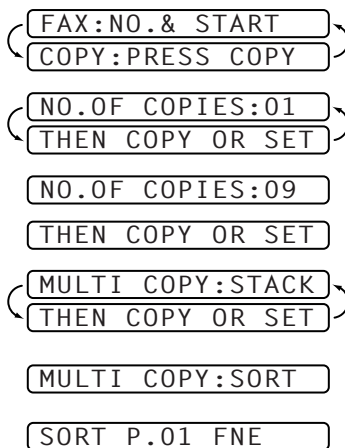

5 Press ◀ or ▶ to select an enlargement or reduction ratio.

ELG/RDC : 100%

ELG/RDC : 120%

•

•

ELG/RDC : 75%

ELG/RDC : 75%

For example: 75 %.

6 Press **Copy/Help**.

SORT P.01 FNE



If you are making multiple copies and get a **MEMORY FULL** message while you are scanning the first page, press **Stop** to cancel the job. Then make a single copy. If you selected SORT and the **MEMORY FULL** message appears while scanning subsequent pages, you can press **Copy/Help** to copy the portion that is in memory, or press **Stop** to cancel. To restart the copy job using less memory, press **Copy/Help** for stacked copies.

Making a Call

You can use your machine to make voice telephone calls, by dialling manually or by using One Touch or Speed Dial memory. You can use the handset or if you have the FAX-T76 you can use the Speakerphone to make and receive calls. For more details, see *“Dialling a Number” on page 22 and 22.*

The “full-duplex” digital Speakerphone allows you to operate the phone hands free, or allows more than one person in the room to participate in a two-way phone conversation. When using the Speakerphone, make sure that you speak clearly. If the other party has difficulty hearing you, move closer to the microphone.

On Hook Dialling

- 1 Dial the number by using the dial pad or Quick-Dial keys.
The number you are dialling, or the name you have stored for One Touch or Speed Dial is displayed on the LCD.
- 2 For FAX-T74 press **Start** and pick up the handset when you hear the call answered on the monitor speaker. If you press **Tel** before lifting the handset, the call will be disconnected. Replace the handset to finish the call.
For the FAX-T76, press **Start**, and when the call is answered, you can now speak to the party at the other end without lifting the handset. Press **Speaker Phone** when you finish the conversation.

Redial

If you're calling someone and the line is busy, you can retry the number by pressing **Redial/Pause**.

- 1 Pick up the handset—**OR**—Press **Speaker Phone**.
- 2 Press **Redial/Pause**.
- 3 To hang up, replace the handset—**OR**—Press **Speaker Phone**.

Pause

Press **Redial/Pause** to insert a pause between digits to be dialled.

If your fax machine is connected to a PABX, you may need to insert an additional number prefix (e.g. “9”) and a “pause” before each fax or telephone number to gain access to the outside line. When you press **Redial/Pause**, a dash “-” will appear on the display. By storing a pause, you can create a delay of 3.5 seconds.

Tone/Pulse

If you have pulse dialling service, but need to send tone signals (for telephone banking, for example). Follow the directions below, but if you have touch tone service, you do not need this feature to send tone signals.

- 1 Lift the handset and press **#**.
Any digits dialled after this sends tone signals.
When you hang up, the machine returns to pulse dialling service.

Answering a Call

F/T (FAX/TEL) Mode

When you share one line for your telephone and fax machine, in the F/T (FAX/TEL) mode, the fax machine can determine whether an incoming call is a fax or a telephone call. *See “Answer Mode Settings” on page 24.*

Answering Calls with the Speakerphone (Only for FAX-T76)

When the machine rings, instead of lifting the handset, press **Speaker Phone**. Speak clearly, toward the microphone. To end the call, press **Speaker Phone**.

If you have a bad telephone line connection, the other party might hear your voice echoed during the call. Hang up and try the call again—**OR**—Pick up the handset.

Mute

- 1** Press **Mute/Search** to put a call on hold.
- 2** You can put down the handset without disconnecting the call.
- 3** Pick up the machine’s handset or press **Speaker Phone** to release the call from hold.

If you press **Mute/Search** without lifting the handset or pressing **Speaker Phone**, this key works as the Search key.

Tel Key (Only for FAX-T74)

This key is used to enter into a telephone conversation one you have picked up the handset of an external telephone during the F/T pseudo-ring. If you press the **Tel** key and then replace the handset, then you will be listening through the monitor speaker, but the other party will not be able to hear you.

Types of Reports

You can print the following lists and reports:

1. XMIT REPORT

Choose if Transmission Verification Report is printed after all Faxes sent.

2. JOURNAL

Journal lists information about the last 30 incoming and outgoing faxes. TX means Transmit; RX means Receive.

3. QUICK-DIAL

Lists names and numbers stored in One Touch and Speed Dial memory, in numerical order.

4. TEL. INDEX

Quick-dial list (above), alphabetically.

5. SYSTEM SETUP

Lists settings for **INITIAL SETUP**, **SETUP RECEIVE**, **REMOTE FAX OPT** and **SETUP TAD**.

6. MEMORY STATUS

Lists summary information and amount of occupied memory.

Transmission Report

You can use the Xmit Report as proof that you sent a fax. This report lists the name or fax number of the receiving party, the time and date of transmission, and if the transmission was successful.

When the feature is **OFF**, the report is printed automatically only if there's an error during transmission. If the report indicates **ERROR**, send the document again. If the report indicates you should check the readability of certain pages, resend those pages.

When the feature is **ON**, the report is printed with every fax you send.

- 1 Press **Menu/Set**, **7**, **1**.
- 2 Press **◀** or **▶** to select **ON** or **OFF**, and press **Menu/Set**.
- 3 Press **Stop** to exit.

Setting Reports

To Print a Report

- 1 Press **Menu/Set**, **7**.
- 2 Enter the number (see list above) of the report you want to print. For example, press **5** to print the **SYSTEM SETUP**.
- 3 Press **Start**.
- 4 Press **Stop** to exit.

Journal Period

You can set the machine to print activity reports at specific intervals (1, 3, 6, 12, 24 hours, 2, 4 or 7 days). If you set the interval to **OFF**, you can print the report by following the steps in the previous section.

- 1** Press **Menu/Set, 7, 2**.
- 2** Press ◀ or ▶ to display **JOURNAL PERIOD**, and press **Menu/Set**.
- 3** Press ◀ or ▶ to choose your setting. If you choose 7 days, the screen prompts you to choose a day at which to begin the 7-day countdown.
- 4** When the screen displays the setting you want, press **Menu/Set**.
- 5** Enter the time to begin printing, in 24-hour format (for example, enter 19:45 for 7:45 PM), and press **Menu/Set**.
- 6** Press **Stop** to exit.

Advanced Operations

Electronic Cover Page

The cover page is generated at the receiving party's machine. Your cover page includes the name stored in the One Touch or Speed Dial memory. If you're dialling manually, the name is left blank. *See "Setup Quick Dial Numbers for Easy Dialling" on page 18.*

The cover page indicates the fax is from your Station ID, and the number of pages you're sending. If you have **COVERPG SETUP** set to **ON** (Function menu 3-1), the number of pages remains blank.

You can select a comment to include on your cover page.

See "Setting the Station ID" on page 7.

Instead of using one of the comments above, you can enter up to two customized messages, each 27 characters long.

See "Entering Text" on page 81.

Cover Page for Next Fax Only

Make sure Station ID is set up. *See "Set station ID" on page 3.* This feature does not work without the Station ID.

You can set the fax to send a cover page with a particular document. This cover page will include the number of pages in your document.

- 1 Insert the document in the feeder.
- 2 Press **Menu/Set**, **3**, **1**.
- 3 Press **Menu/Set** when the screen displays **NEXT FAX ONLY**.
- 4 Press ◀ or ▶ to select **ON** (or **OFF**), and press **Menu/Set**.
- 5 Press ◀ or ▶ to view the comment selections.
- 6 Press **Menu/Set** when the screen displays your selection.
- 7 Enter two digits to indicate the number of pages you are sending. (Enter 00 to leave the number of pages blank.)
If you make a mistake, press ◀ to back up and re-enter the number of pages.
- 8 Press **Menu/Set**. The screen displays:
- 9 Press **1** if you want to select additional settings. The display returns to the Setup Send menu—**OR**—Press **2** if you are finished choosing settings, and go to Step 10.
- 10 Enter the fax number you're calling and then press **Start**.

Always Send Cover Page

Make sure Station ID is set up. See “Set station ID” on page 3. This feature does not work without the Station ID.

You can set the machine to send a cover page whenever you send a fax. The number of pages in your fax is not included when you use this setting.

- 1 Press **Menu/Set, 3, 1**.
- 2 Press ◀ or ▶ to select **ON** (or **OFF**).
- 3 Press **Menu/Set** when the screen displays **COVERPAGE:ON**. (If you select **ON**, a coverpage is always sent when you send a fax.)
- 4 If you selected **ON**, the screen displays the cover page comment options. Press ◀ or ▶ to view comment selections.
 - 1 .NOTE OFF
 - 2 . PLEASE CALL
 - 3 . URGENT
 - 4 . CONFIDENTIAL
 - 5 . (user defined)
 - 6 . (user defined)
 - ACCEPTED
 - NEXT
 - 1 . YES 2 . NO
- 5 Press **Menu/Set** when the screen displays your selection. The screen displays:
- 6 Press **1** if you want to select additional settings. The display returns to the Setup Send menu—**OR**—Press **2** to exit if you are finished choosing settings.

Using a Printed Cover Page

If you prefer using a printed cover page that you can write on, you can print the sample page and attach it to your fax.

- 1 Press **Menu/Set, 3, 1**.
- 2 Press ◀ or ▶ to select **PRINT SAMPLE**, and press **Menu/Set** when the screen displays your selection.
- 3 Press **Start**. Your machine prints a copy of your cover page.

| | |
|--------------------|-------------------|
| === COVER PAGE === | |
| TO: | _____ |
| FROM: | _____ |
| FAX: | _____ |
| TEL: | _____ |
| | PAGE[S] TO FOLLOW |
| COMMENT: | |

Composing Your Own Comments

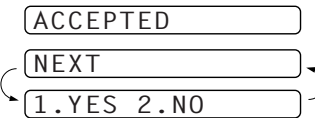
- 1 Press **Menu/Set, 3, 2**. The screen displays: **COVERPAGE NOTE**.
- 2 Use ◀ or ▶ to choose position 5 or 6 for your customized comment, and press **Menu/Set**.
- 3 Use the dial pad to enter your customized comment. See “*Entering Text*” on page 81.
- 4 Press **Menu/Set**. The screen displays:
- 5 Press **1** if you want to select additional settings. The display returns to the Setup Send menu—**OR**—Press **2** if you are finished choosing settings and exit.

Overseas Mode

After the fax is sent, this feature turns itself off.

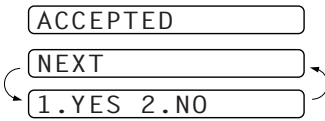
- 1 Insert the document.
- 2 Press **Menu/Set, 3, 5**.
- 3 Press ◀ or ▶ to select **ON** (or **OFF**), and press **Menu/Set** when the screen displays your selection. The screen displays
- 4 Press **1** if you want to select additional settings. The display returns to the Setup Send menu—**OR**—Press **2** if you have finished choosing settings, then go to Step 5.
- 5 Enter the fax number you are calling, and press **Start**.

Memory Transmission

You can scan a fax into the machine's memory. This will be sent as soon as the scan is completed. This way, you don't have to wait for the entire fax to be transmitted before you retrieve your original.

- If you get a **MEMORY FULL** message while scanning the first page of a fax, press **Stop** to cancel the scan.
- If you get a **MEMORY FULL** message while scanning in a subsequent page, you'll have the option to press **Start** to transmit the pages scanned so far, or to press **Stop** to cancel the operation. In this case, send the fax by the Manual Transmission.

- 1** Insert the document in the feeder.
- 2** Press **Menu/Set, 3, 9**.
- 3** To change the default setting, press ◀ or ▶ to select **ON** (or **OFF**) and press **Menu/Set**. Go to Step 5—**OR**—For the next fax transmission only, press ◀ or ▶ to select **NEXT FAX ONLY** and press **Menu/Set**.
- 4** For the next fax only, press ◀ or ▶ to select **ON** (or **OFF**) and press **Menu/Set**.
- 5** Press **1** to select additional settings. The display returns to the **SETUP SEND** menu—**OR**—Press **2** if you are finished choosing settings and go to Step 6.
- 6** Enter the fax number and then press **Start** to begin scanning the document into memory. Once the scan is complete, the machine dials the call.



Depending on your typical faxes, **MEMORY FULL** errors can occur frequently. If this happens, change the Memory Transmission setting back to **OFF**.

Call Reservation

You can send a fax and let the other party know that you want to speak to him after the fax transmission is complete. The other fax machine will ring as if it were receiving a telephone call; if the other party picks up the handset, your machine will ring. Lift the handset to have a conversation. If you set Call Reservation and Call Back message to **ON**, your machine leaves a message if the other party does not answer.

- 1** Insert the document in the feeder.
- 2** Press **Menu/Set, 3, 6**. The screen displays the current setting for Call Reservation.
- 3** Press ◀ or ▶ to select **ON** (or **OFF**).
- 4** If you set Call Reservation to **ON**, press **Menu/Set** when the screen displays your selection. The screen displays the current setting for Call Back Message.
- 5** Press ◀ or ▶ to select **ON** (or **OFF**), and press **Menu/Set** when the screen displays your selection. The screen displays
- 6** Press **1** if you want to select additional settings. The display returns to the Setup Send menu—**OR**—Press **2** if you are finished choosing settings, and go to Step 7. The screen prompts you to enter the fax number you want to call.
- 7** Enter the fax number, and press **Start**.

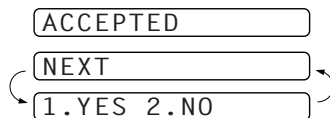

- 8 If you've set Call Reservation to ON, pick up your handset if the machine rings.





You cannot use auto redial with Call Reservation. You cannot use Call Reservation with Delayed Transmission or with Polling. You must register your Station ID to set Call Back Message to **ON**.

Print Sample Call Back Message

- 1 Press **Menu/Set, 3, 6**.
- 2 Press **◀** or **▶** to select **PRINT SAMPLE**, and press **Menu/Set**.
- 3 Press **Start**.

Delayed Transmission (Timer)

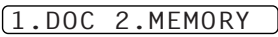
You can use this function to send a fax up to 24 hours later.

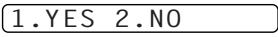
- 1 Insert the document in the feeder.
- 2 Press **Menu/Set, 3, 7**.
- 3 Enter the time you want the fax to be sent, in 24-hour format (for example, enter 19:45 for 7:45 PM), and press **Menu/Set**. The screen displays

- 4 Press **1** to select **DOC**. —OR— Press **2** to select **MEMORY**. If you select **1.DOC**, the machine will not start scanning the document until the preset time. The document must be left in the feeder.



- 5 Press **1** if you want to select additional settings. The display returns to the Setup Send menu—OR—Press **2** if you are finished choosing settings and go to Step 6. The screen prompts you to enter the fax number.
- 6 Enter the fax number, and press **Start**. The machine will wait until the time you have entered to send the fax.

Broadcasting

Using the numbers you have stored in Groups, One Touch and Speed Dial memory, you can “broadcast” faxes automatically to up to 54 different locations in a few simple steps. If the Memory TX is **ON** or **NEXT FAX ONLY**, you can broadcast.

- 1 Insert the document in the feeder.
- 2 Press **Menu/Set, 3, 9** to select **ON** or **NEXT FAX ONLY** and press **Menu/Set**.
- 3 Enter the One Touch and Speed Dial numbers (one after the other) or Group Number you have stored.
- 4 Press **Start**. The machine stores the document in memory, then transmits it to all the numbers you entered. If the line is busy, the machine will retry.



Press **Stop** during transmission to cancel the current fax broadcast.

Setting Number Groups for Broadcasting

Number Groups allow you to send the same fax message to many fax numbers by pressing only one Quick-Dial key (Broadcasting).

- **First**, you'll need to store each fax number as a One Touch or Speed Dial number.
- **Next**, you can combine them into a Number Group. Each Number Group uses a Quick-Dial key.
- **Finally**, you can have up to 4 small Number Groups, or you can assign up to 53 numbers to one large Group. See *"Storing One Touch Dial Numbers" on page 18*.

- 1** Press **Menu/Set, 6, 3**. The screen displays **SELECT QUICKDIAL**.
- 2** Select a Quick-Dial key where you wish to store the number. (For example, press Quick-Dial key **2** to use as a Group.)
- 3** Use the dial pad to enter the group number (for example, press **1** for Group 1).
- 4** Press **Menu/Set**. Enter the One Touch or Speed Dial numbers in this group. For example, for One Touch **3**, press One Touch dial key (e.g. 03). For Speed Dial location 09, press **Mute/Search**, then press **0, 9** on the dial pad. The LCD shows ***03, #09**.

- 5** Press **Menu/Set**. The screen prompts you to enter a name.
- 6** Use the dial pad to enter a name for the group (for example, NEW CLIENTS), and press **Menu/Set**. See *"Entering Text" on page 81*.
- 7** Press **Stop** to exit.



You can print a list of all One Touch and Speed Dial numbers. Group numbers will be marked in the column of **"GROUP"**. See *"Printing Reports" on page 33*.

Next-Fax Reservation

Even if your machine is receiving another fax, you can prepare to send your next fax. This way, you don't have to wait for it to finish sending or receiving the other fax. You can dial this fax call manually, or by using Redial or One Touch dialling. (When you use One Touch Dial, only the memory location—not the name of the person you're calling—is displayed.)

- 1** Insert the documents in the feeder. If necessary, press **Resolution** to adjust resolution.
- 2** Enter the fax number, and press **Start**.
- 3** Press **Menu/Set**. The screen displays **NEXT-FAX RESERVD**.
- 4** To cancel the reservation, remove the documents and press **Stop**.



You can't use this feature if there is a document waiting in the feeder (possibly for Delayed Transmission or Polling Transmit), or when the timer has been interrupted.



If you use Next-Fax Reservation, the machine will send a document without storing it in memory.

Cancelling a Scheduled Job

You can cancel tasks you've scheduled such as Timer or Polling Transmit.

- 1 Press **Menu/Set, 4**. Any waiting jobs appear on the display. If no job is waiting, the screen displays **NO JOB WAITING**.
- 2 If you have more than two jobs waiting, use **◀** or **▶** to select the job you want to cancel. Press **Menu/Set** when the screen displays your selection—**OR**—If you have only one job waiting, go to Step 3.
- 3 Press **1** to cancel—**OR**—Press **2** to quit without cancelling.
- 4 Press **Stop** to exit.

Interrupting Timer and Polled Transmit Jobs

You can send a fax or make a copy now, even if you have the machine set to send a fax later, or if you have it set to be polled. However, you cannot use automatic redial or the function mode.

- 1 Press **Menu/Set, 5**.
- 2 Wait 2 seconds, then remove the documents that are waiting in the feeder.
- 3 Place the document you want to send now in the feeder.
- 4 Enter the number for the fax you want to send now, and press **Start**.
- 5 After the transmission is finished, return the first document to the feeder.
- 6 Press **Menu/Set, 5** to restore the timer.



If you set Timer or Polled Transmit using the memory (that is, if you have already scanned the document into the machine's memory and will send it from there), you don't have to interrupt to send a fax or make a copy.

Multiple Resolution Transmission

Use this feature to select separate resolution settings for each page of the fax you're sending. This could be useful if you're sending a fax with photos and letters, or some pages with small print and others with normal print. Resolution settings return to **STANDARD** after the fax is sent.

- 1 Inset documents in feeder, then press **Menu/Set, 3, 4**.
- 2 Use **◀** or **▶** to select resolution for page 1, and press **Menu/Set**.
- 3 Repeat Step 2 for subsequent pages. Press **Stop** when you're finished. The screen displays:
- 4 Press **1** if you want to select additional settings. The display returns to the Setup Send menu—**OR**—Press **2** if you are finished choosing settings, and go to Step 5. The screen prompts you to enter the fax number you want to call.
- 5 Enter the fax number you're calling, and press **Start**.

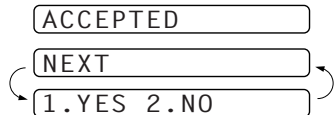

If you want to copy a document using multiple resolutions, press **Copy/Help** in Step 5.

Operation from an External or Extension Telephone

If you answer a fax call on an external or extension phone, you can make your machine take over by using the Activation Code. When you press the Activation Code * 5 1, the machine starts to receive a fax. See “Setting the F/T Ring Time” on page 25.

If the machine answers a voice call and F/T pseudo-rings for you to take over, use the Deactivation Code # 5 1 to take the call at an extension phone. The Deactivation Code is used only in F/T mode. (You have to set Remote Activation to ON in Menu/Set, 2, 4 to use * 5 1 or # 5 1.)

If you answer a call, and no one is on the line, assume you’re receiving a fax.

- If you are using the machine phone, press **Start**, then hang up.
- If you are using an extension phone, press * 5 1, wait for fax receiving tones (chirps), then hang up.
- If you are using an external phone, press * 5 1 and wait for the phone to be disconnected (the screen displays **RECEIVE**) before you hang up. (Your caller will have to press **Start** to send the fax.)



If you accidentally pick up an extension phone when a fax message is being received, you may disrupt the transmission or render some portions unreadable.

Extension telephones are not permitted in some countries, in such a case the deactivation code will not work.

The Remote Activation Code also can be used by your callers. When you are using an external TAD, your outgoing message (OGM) should end with the statement “to send a fax, press * 5 1”. See “Outgoing Message (OGM) of External TAD” on page 11.

For F/T (Fax/Tel) Mode Only

When the machine is in F/T mode, it will use the F/T Ring Time (F/T pseudo-ringing) to alert you to a voice call.

- If you’re at the machine, you can lift the handset to answer.
- If you’re at an extension phone, you’ll need to lift the handset during the F/T Ring Time and press # 5 1 between the F/T pseudo-rings.
- If no one is on the line, or if someone wants to send you a fax, send the call back to the machine by pressing * 5 1.

Remote Call Transfer

In order to set the Remote Activation, you should first set **Menu/Set, 2, 4 REMOTE CODE** to ON. See “Changing Remote Codes” on page 43.

This function works when you receive the incoming Voice call at the remote DECT cordless phone externally connected to the fax machine. See “Connecting an External Telephone” on page 12.

You can transfer voice call to the fax machine. But you can not transfer the incoming voice call from the fax machine to the DECT cordless phone.

To transfer telephone call to the fax machine

When you pick up the voice call at remote DECT cordless phone and would like to transfer it to the fax machine,

- 1 Press Activation Voice Code * **8 1** at remote cordless phone.
- 2 The fax machine rings (pseudo-ring same as current F/T ring) and the display shows “**PICK UP PHONE**”.
- 3 Pick up the handset and press **Tel** or **Speaker Phone**—**OR**—just press **Speaker Phone** at the fax machine in order to transfer the voice call to the fax machine.



Don't hang up the call from the cordless phone until the voice call has been transferred to the fax machine. You will know when this is because you will no longer be able to hear or talk to the caller via the cordless phone. If you do not wait until this point before hanging up from the cordless phone, the call will be lost.

If nobody answers at the fax machine, pseudo-ringing stops after 30 seconds. In that case, it may still be possible to speak with the caller from the cordless phone. Speech between the fax machine and the cordless phone (= intercom) is not possible.

Changing Remote Codes

Remote Codes might not work with some telephone systems. The preset Activation Code is * **5 1**. The preset Deactivation Code is # **5 1**. The preset Activation Voice Code is * **8 1**.



If you are always disconnected when accessing your external TAD remotely, try changing the Activation Code from * **5 1** to **###** and the Deactivation Code from # **5 1** to **1 1 1**. You cannot use the same number for the Activation Code and the Deactivation Code.

To change Remote Codes

- 1 Press **Menu/Set**, **2**, **4**.
- 2 Press ◀ or ▶ to select **ON** (or **OFF**), and press **Menu/Set** when the screen displays the setting you want.
- 3 If you want to, enter a new Remote Activation Code, then press **Menu/Set**.
- 4 If you want to, enter a new Remote Deactivation Code, then press **Menu/Set**.
- 5 If you want to, enter a new Activation Voice Code, then press **Menu/Set**.
- 6 Press **Stop** to exit.

Telephone Services

Your FAX supports the Caller ID and BT Call Sign (For U.K. Only) telephone services offered by some telephone companies.

Caller ID (Caller IDentification)

Caller ID is a telephone service that allows the subscriber to see a display of the caller's phone number as the telephone rings. It is a fast way to screen your calls. You can respond quickly to calls you missed, because Caller IDs are received and stored in your machine's memory. In addition to the standard Caller ID features, you can select a Caller ID and have your machine dial the number for you.



- To get the Caller ID Service: apply for the Caller ID service at your local telephone company, if available.
- To PABX Users :
Calling line identification signals are not generally delivered to your Brother fax machine if it is connected behind a private branch exchange (PBX) system or other call routing device.

Advantages of Caller ID

For Business

All businesses profit from a quicker response to customer calls.

At Home

Residential customers can protect themselves from unwanted calls by seeing the callers name or number before they answer.

Set the Caller ID to ON

If you have BT Caller ID on your line, then this function should be set to **ON** to display the caller's phone number on the fax LCD as the telephone rings.

- 1 Press **Menu/Set, 0, 1**. The screen displays;
- 2 Press **◀** or **▶** to choose **ON**, and press **Menu/Set**.
- 3 Press **Stop** to exit.

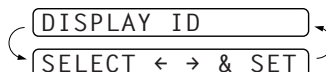

How Does the Caller ID Work?

The Caller ID Appears on the Display When Your Telephone Rings

As your telephone rings, the display shows you the caller's phone number. If the callers name is stored in your machine as a Speed Dial, or One Touch dial, the callers name will be displayed. Once you pick up the handset, the caller's ID disappears. You will see up to the first 16 characters of the number on the display.



- If **"# UNAVAILABLE"** appears on the display, it means that the call came from outside your caller ID service area. *
 - If **"# WITHHELD"** appears on the display, it means the caller intentionally blocked the transmission of his/her ID. *
 - If no caller ID was transmitted to your fax machine, **"PICK UP PHONE"** will remain on the display.
- * Depends on network Function.

The Caller ID is Stored in Your Machine's Memory

The machine can store a maximum of the last 30 incoming caller IDs in the memory, along with the time and date of reception. The 31st call will cause the oldest ID to be erased.

The Caller ID information stored in the memory can be used for the following.

■ Selecting a Caller ID from the Memory for Call Reply.

You can scroll through the Caller IDs on the display and select one for your machine to dial. (See below)

■ Printing the Caller ID List.

You can review calls you received by checking the Caller IDs in memory. This report will list the Date, Time, Phone Number (Caller ID), and type of call (Comment).



Please set up the number of rings to more than 02 in the Ring Delay (See “*Setting the Ring Delay*” on page 25) before you use the Caller ID. If you set up the number of rings to 01, you cannot receive the Caller ID.

Selecting a Caller ID from the Memory for Call Reply

You can display the caller IDs that are stored in the memory and select the caller you want your machine to dial. Call Reply is a convenient feature whereby your Brother fax can dial back a voice/fax call “on-hook” to the opposite party associated with a Caller ID number which has been captured into memory. This saves you from having to copy and dial back to that number manually.

- 1 Press **Menu/Set, 0, 1**. The screen displays;
- 2 Press **◀** or **▶** to select **DISPLAY ID**, and press **Menu/Set**. The caller ID of the last call will appear on the display. If no ID is stored, the beeper will sound and “**NO CALLER ID**” will appear on the display.
- 3 Press **◀** or **▶** to scroll through the Caller IDs in the memory, and press **Menu/Set** to automatically dial the Caller ID number. Wait until the screen prompts you to press the **Start** key.
- 4 Press **Start**.
If you wish to send a fax, insert a document into the feeder. Then press **Start**.

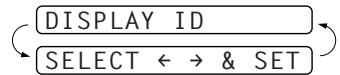

To cancel the Call Reply (for example, when you selected the Wrong Caller ID), simply press **Stop** and begin again ; the Caller ID will not be lost.

To Activate Certain Network Services When Using Call Reply



You may wish (in order to activate certain network services), to insert a special prefix to be dialled in front of the Caller ID number when using the Call Reply feature. For example,

- Your outgoing Caller ID withheld

The required prefix, typically three to six digits (including # and * symbols) in length, may be inserted after displaying the desired Caller ID in step 3 on the previous page. (You can enter the prefix up to 20 digits on the machine.) The complete number string including the prefix will then be dialled by pressing **Start**.

Select the desired Caller ID, wait 2 seconds until you see the date and time the caller ID was received.

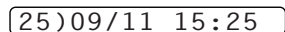

Enter the prefix by using number keys up to 20 digits.



- The display will be cleared when you press any of the number keys.
- To cancel the prefix (such as when you entered the wrong number), simply press **Stop**.

The display will return to the desired Caller ID you selected.

- If you press **Stop** again, the machine will return to the current date and time display. You are no longer in the call reply mode.
- Any problems or queries in using network services should be raised in the first instance with your network operator(s).
- With Call Reply, automatic redial does not function in cases where the called party is busy or doesn't answer.

Call Reply to DDI numbers via Caller ID

Calls derived from a caller ID number to destinations connected to a "Direct Dial Inward (DDI)" private exchange system may fail to connect, or may be answered in the first instance by the called premises' main switchboard rather than by the intended extension. Brother is not liable for any call charges thus incurred.

Clearing the Caller ID Stored in Memory (Only for FAX-T76)

For the effective use of the memory, it is recommended that you should clear the Caller ID stored into memory by pressing **Erase** when the display shows the number.

Printing Caller ID List

- 1** Press **Menu/Set, 0, 1**.
- 2** Press **◀** or **▶** to select **PRINT REPORT**, and press **Menu/Set**.
- 3** Press **Start**.

BT Call Sign (For U.K. Only)

This machine feature lets you use the BT Call Sign subscriber service which allows you to have at least two separate telephone numbers on one phone line. Each phone number has its own distinctive ringing pattern, so you know which phone number is ringing. This is one way you can have a separate phone number for your machine.

Your machine has a BT Call Sign compatible distinctive ringing function, allowing you to dedicate a second phone number (on the same phone line) just for receiving faxes.



You can switch it off temporarily, then turn it back on. When you get a new fax number, make sure you reset this function.



- **To have your external TAD answer only the main number, the machine must be in Manual Mode.**
- **In FAX mode, the machine will answer all incoming calls on the line.**

Setting the machine to work with BT Call Sign

- 1** Set the machine to **MANUAL** mode.
- 2** Press **Menu, 0, 2**. The screen displays the current setting of this feature.
- 3** Press **◀** or **▶** to select **ON** (or **OFF**).
- 4** Press **Set**.
- 5** Press **Stop** to exit.



Polling is the process of retrieving faxes from another machine. You can use your machine to “poll” other machines, or you can have someone poll your machine.

All parties involved in polling need to set up their machines to accommodate polling. When someone polls your machine to receive a fax, they pay for the call; if you poll someone’s fax machine to receive a fax, you pay for the call. *See “Polled Transmit” on page 49.*

Polling Receive

Secure Polling

Secure Polling is a way to keep your documents and from “falling into the wrong hands” while the fax machine is set up for polling. You can use Secure Polling only with another Brother fax machine. Your four-digit ID number must be entered on the fax machine that polls for your documents.



Some machines do not respond to the polling function.

Setup for Polling Receive

Polling Receive is when you call another fax machine to receive a fax from it.

- 1 Press **Menu/Set, 2, 7**. The screen displays
- 2 Press **◀** or **▶** to choose **STANDARD**, and press **Menu/Set**.
The screen prompts you to enter the fax number you want to poll, and then to press **Start**.
- 3 Enter the fax number you are polling, and press **Start**.
The screen displays **DIALING**.



Setup for Polling Receive with Secure Code

You need to make sure you are using the same ID number as the other party.

- 1 Press **Menu/Set, 2, 7**. The screen displays
- 2 Press **◀** or **▶** to choose **SECURE**, and press **Menu/Set**.



- 3 Enter a four-digit number.
This is the same as the security code of the fax machine you are polling.
- 4 Press **Menu/Set**.
The screen prompts you to enter the fax number you want to poll, and then to press **Start**.
- 5 Press **Start**.

Setup Delayed Polling Receive

You can set your machine to begin Polling Receive at a later time.

- 1 Press **Menu/Set**, **2**, **7**. The screen displays
- 2 Press ◀ or ▶ to choose **TIMER**, and press **Menu/Set**.
- 3 The screen prompts you to enter the time you want to begin polling.
- 4 Enter the time (in 24-hour format) you want to begin polling.
For example, enter 21:45 for 9:45 PM.
- 5 Press **Menu/Set**. The screen prompts you to enter the fax number you are polling and then to press **Start**.
- 6 Enter the fax number, and press **Start**. The machine makes the polling call at the time you entered.

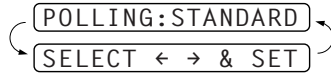

You can set up only one Delayed Polling.

Sequential Polling

Your machine can request documents from several fax units in a single operation. You just specify several destinations in Step 4. Afterward, a Sequential Polling Report will be printed.

- 1 Press **Menu/Set**, **2**, **7**. The screen displays
- 2 Press ◀ or ▶ to choose **STANDARD**, **SECURE** or **TIMER**, and press **Menu/Set** when the screen displays the setting you want.
- 3 If you selected **STANDARD**, the screen prompts you to enter the fax number you want to poll, and then to press **Start**.
 - If you selected **SECURE**, enter a four-digit number and press **Menu/Set**.
 - If you selected **TIMER**, enter the time (in 24-hour format) you want to begin polling and press **Menu/Set**.
- 4 Specify the destination fax machines, which you wish to poll by using One Touch, Speed Dial or a Group.
- 5 Press **Start**.
Your machine polls each number or group number in turn for a document.





Cancelling a Scheduled Job

This function allows you to cancel tasks that you've scheduled such as Delayed Fax, Delayed Polling Receive or Polling Transmit.

- 1 Press **Menu/Set, 4**. Any waiting jobs appear on the display. If nothing is waiting, the screen displays **NO JOB WAITING**.
- 2 If you have more than two jobs waiting, use ◀ or ▶ to select the job you want to cancel. Press **Menu/Set** when the screen displays your selection—**OR**—If you have only one job waiting, go to Step 3.
- 3 Press **1** to cancel—**OR**—Press **2** to exit without cancelling.
- 4 Press **Stop** to exit.

Polled Transmit

Polling Transmit is when you set up your fax machine to wait with a document so another fax machine can retrieve it.

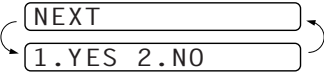

- 1 Place document to be retrieved in feeder.
- 2 Press **Menu/Set, 3, 8**. The screen displays

- 3 Press ◀ or ▶ to choose **STANDARD**, and press **Menu/Set**. The screen displays

- 4 Press **1** to select **DOC** if you want your machine to scan the printed document at the time it is polled—**OR**—Press **2** to select **MEMORY**.

- 5 Press **1** if you want to select additional settings. The display returns to the Setup Send menu—**OR**—Press **2** if you are finished choosing settings and go to Step 6. See *"Interrupting Timer and Polled Transmit Jobs"* on page 41.
- 6 Press **Start**. The screen displays **POLLED WAITING**.

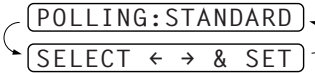

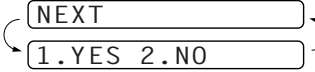
If you pressed **1** in Step 4, the printed document remains in the ADF until your machine is polled. However, you can "interrupt" it to send another fax.

Setup for Polling Transmit with Secure Code

When you set **POLLING:SECURE** to ON, anyone who polls your machine must enter the polling ID number.

- 1 Place document in feeder.
- 2 Press **Menu/Set**, **3**, **8**. The screen displays . The diagram shows two rectangular boxes. The top box contains the text "POLLING: STANDARD". The bottom box contains the text "SELECT <- -> & SET". A curved arrow on the left points from the top box to the bottom box, and a curved arrow on the right points from the bottom box to the top box.
- 3 Press **<** or **>** to choose **SECURE**, and press **Menu/Set**.
- 4 Enter a four-digit number, and press **Menu/Set**. The screen displays . The diagram shows a single rectangular box containing the text "ACCEPTED".
- 5 Press **1** to select **DOC** if you want your machine to scan the printed document at the time it is polled—**OR**—Press **2** to select **MEMORY**. . The diagram shows two rectangular boxes. The top box contains the text "NEXT". The bottom box contains the text "1. YES 2. NO". A curved arrow on the left points from the top box to the bottom box, and a curved arrow on the right points from the bottom box to the top box.
- 6 Press **1** if you want to select additional settings. The display returns to the Setup Send menu—**OR**—Press **2** if you are finished choosing settings and go to Step 7.
- 7 Press **Start** and wait for the fax to be polled.

This chapter is for Models FAX-T74. If you have model FAX-T76 your remote fax options are handled by the Message Manager. See *“Message Manager (Only for FAX-T76)” on page 56.*

Setting Fax Storage

If you set Fax Storage to **ON**, you will be able to retrieve fax messages from another location, using Fax Forwarding or Remote Retrieval functions. The screen will indicate when you have a fax stored in memory.

- 1 Press **Menu/Set, 8, 2**. The screen prompts you to choose a fax setting.
- 2 Press **◀** or **▶** to select **ON** (or **OFF**), and press **Menu/Set** when the screen displays your selection.
- 3 Press **Stop** to exit.



If there are faxes in memory when you turn the Fax Storage **OFF**, the screens prompts you to erase any faxes in memory. See *“Printing a Fax from Memory (Only for FAX-T74)” on page 28.*

If you press **1**, all fax data is erased and Fax Storage is turned off. If the fax data in memory has not been printed before, it will be printed first, and then erased. If you press **2**, data is not erased, and Fax Storage remains on.

Fax Forwarding



You cannot use Fax Forwarding or Remote Retrieval when “Fax Storage” is set to **OFF**.

Programming a Fax Forwarding Number

When Fax Forwarding is set to **ON**, your fax machine stores the received fax in memory, then dials the fax machine phone number you have programmed, and forwards the fax message.

- 1 Press **Menu/Set, 8, 1**.
- 2 Press **◀** or **▶** to select **ON** (or **OFF**), and press **Menu/Set**.
The screen prompts you to enter the number of the fax machine where faxes will be forwarded.
- 3 Enter the forwarding number (up to 20 digits), and press **Menu/Set**.
- 4 Press **Stop** to exit.

Remote Retrieval

You can call your machine from any touch tone phone (or remote Group 3 fax machine) and use a Remote Access Code and other button presses to retrieve fax messages.

Changing the Remote Access Code

Enter your Remote Access Code when the fax machine picks up your call, so you can access features remotely. The access code is preset to 1 5 9 *, but you can change this.

- 1 Press **Menu/Set, 8, 3**.
- 2 Enter a three-digit number from 000 to 900, and press **Menu/Set**.
The * cannot be changed. Do not use the same digits that appear in your Remote Activation or Deactivation Code.
- 3 Press **Stop** to exit.

Using Your Remote Access Code

- 1 Dial your fax machine phone number from a touch tone phone.
- 2 When your fax machine answers and beeps, immediately enter your Remote Access Code (1 5 9 *).
- 3 The fax machine signals if there are any messages received:
1 long beep—Fax message(s)
No long beep—no messages
- 4 The fax machine then prompts you with two short beeps to enter a command. If you wait longer than 30 seconds to enter a command, the machine hangs up. If you enter an invalid command, the machine beeps three times.
- 5 Press **9 0** to reset the machine when you finish.
- 6 Hang up.



If your fax machine is set to MANUAL mode, you can access your machine remotely by phoning it and letting it ring for about 100 seconds. Your fax machine will answer the phone after 100 seconds of ringing, and you then have 30 seconds to enter your Remote Access Code.

Remote Commands

Follow the commands below to access features remotely. When you call the fax machine and enter your Remote Access Code (1 5 9 *), the system will signal you with two short beeps to enter a remote control command.

| Remote control commands | Detail Operation |
|---|---|
| 95 Change Fax Forwarding Setting | |
| 1 OFF | If you hear one long beep, the change is accepted. If you hear three short beeps, you cannot change it because the conditions (ex. registering fax forwarding) have not been completed. You can register your fax forwarding number by using 4. FAX FWD NO. Once you have registered the number, the machine will automatically turn to "FAX FWD : ON" mode. Then, receive a Memory Status List by entering 961. Check the List to make sure the Fax Forwarding number you registered is correct. Then enter the confirmation command 955. Now the machine will start Fax Forwarding. |
| 2 Fax forwarding | |
| 4 FAX FWD No. | |
| 6 FAX STORAGE ON | You can set FAX STORAGE ON or OFF. |
| 7 FAX STORAGE OFF | |
| 96 Retrieve FAX | |
| 1 Memory Status List | You must use a remote fax machine in order to receive a List or stored fax message(s). |
| 2 Retrieve all FAX | |
| 3 Erase FAX in the memory | If you hear one long beep, you can erase fax message(s) from the memory. |
| 97 Check the receiving status | You can check whether your fax machine has received any fax message(s). If yes, you will hear one long beep. If no, you will hear three short beeps. |
| 1 DOC | |
| 98 Change Answer Mode | If you hear one long beep, you can change the answer mode. If you hear three short beeps, you cannot change it. |
| 1 TAD | |
| 2 F/T | |
| 3 FAX | |
| 90 Exit | After a long beep, you can exit remote control. |

Retrieving the Memory Status List

You can retrieve the Memory Status List from a remote fax machine to see if you have any fax messages.

- 1 Dial your fax machine's number.
- 2 When you hear the beep, immediately enter your Remote Access Code (1 5 9 *).
- 3 When you hear two short beeps, use the dial pad to press **9 6 1**.
- 4 Using the dial pad, enter the number (up to 20 digits) of the remote fax machine where you want the Memory Status List forwarded, and then press **# #**.



You cannot use * and # as dial numbers. However, if you want to store a pause, press #.

- 5 After you hear your fax machine beep, hang up and wait.
Your fax machine calls the remote fax machine. Your fax machine then sends the Memory Status List to the fax machine which you are calling from.

Retrieving Fax Messages

- 1 Dial your fax machine's number.
- 2 When you hear the beep, immediately enter your Remote Access Code (1 5 9 *).
- 3 As soon as you hear two short beeps, use the dial pad to press **9 6 2**.
- 4 Using the dial pad, enter the number (up to 20 digits) of the remote fax machine where you want your fax messages forwarded to, and then press **# #**.



You cannot use * and # as dial numbers. However, if you want to store a pause, press #.

- 5 After you hear your fax machine beep, hang up and wait.
Your fax machine calls the remote fax machine. The fax machine which you are calling from prints your fax messages.

Changing the Fax Forwarding Number

You can change the default setting of your fax forwarding number from a remote fax machine.

- 1 Dial your fax machine's number.
- 2 When you hear the beep, immediately enter your Remote Access Code (1 5 9 *).
- 3 When you hear two short beeps, use the dial pad to press **9 5 4**.
- 4 Enter the new number of the remote fax machine where you want your fax messages forwarded, and then press **##**.



You cannot use * and # as dial numbers. However, if you want to store a pause, press #. Also, if your fax machine is connected to a PABX, you can press # first before the fax machine's number. The # works as well as R key.

- 5 To retrieve the Memory Status List, when you hear two short beeps, use the dial pad to press **9 6 1**.
- 6 Use the dial pad to enter the number of the remote fax machine (up to 20 digits), and then press **##**.
- 7 After you hear your fax machine beep, hang up and wait.
Your fax machine calls the remote fax machine. Your fax machine then sends the Memory Status List showing the new forwarding number to the fax machine that you are calling from.
- 8 Check the forwarding number.
If the forwarding number is incorrect, return to Step 1 to reset it.

11 Message Manager (Only for FAX-T76)

Message Manager Mode

Message Manager Mode allows you to store incoming fax and voice messages in a flexible memory. The memory stores **15** minutes of voice messages, or up to **20** pages of fax messages. The actual number of pages stored in memory varies depending on the content and the resolution used. Memory is shared between fax and voice messages, which are stored on a “first-come, first-served” basis. Any voice or fax message can be retrieved remotely.

You must record an Outgoing Message in order to use the Message Manager Mode. See “*Recording the Message Manager’s Outgoing Message (TAD MESSAGE)*” on page 57.

Flexible Memory Settings (Message Store)

Message Manager Mode offers you six flexible memory settings, so that you can decide which kinds of messages you want to receive.

- 1. DOC:ON, VOICE:ON** Both voice and fax messages are stored. You can use the Fax Forwarding or Paging features and retrieve voice and fax messages remotely.
- 2. DOC:ON, VOICE:EXT** You need an external answering machine connected to the fax machine for this setting. Fax messages are stored in the Message Manager memory, but voice messages are stored in your external answering machine. Retrieve voice messages from the external answering machine. You cannot use the Paging feature for voice message with this setting.
- 3. DOC:ON, VOICE:OFF** All memory is used to store fax messages—no voice messages will be stored.
- 4. DOC:OFF, VOICE:ON** All memory is used to store voice messages—no fax messages will be stored. Incoming faxes will print on paper. You can use the Paging feature, and retrieve voice messages remotely.
- 5. DOC:OFF, VOICE:EXT** You need an external answering machine connected to the fax machine for this setting. Incoming faxes are not stored in memory, but will print on paper. Voice messages are stored in the external answering machine.
- 6. DOC:OFF, VOICE:OFF** Incoming faxes are not stored in memory, but will print on paper. Voice calls are not stored in memory.

Setting Up Message Manager

You must set up Message Manager in the following order:

- 1** Set the Message Store.
- 2** Record the Message Manager’s Outgoing Message (**TAD MESSAGE**).
- 3** Activate Message Manager (TAD) Mode by pressing .

Setting the Message Store

Select the setting from the descriptions of “Flexible Memory Settings”.

- 1 Press **Menu/Set, 8, 1**. The screen prompts you to choose a **DOC** (Document) setting.
- 2 Press **◀** or **▶** to select **ON** (or **OFF**), and press **Menu/Set**.
The screen prompts you to choose a **VOICE** setting.
- 3 Press **◀** or **▶** to select your setting from the list (**ON**, **OFF** or **EXT**), and press **Menu/Set** when the screen displays your selection.
- 4 Press **Stop** to exit.

Recording the Message Manager’s Outgoing Message (TAD MESSAGE)

Recording the Message Manager’s Outgoing Message (TAD MESSAGE) is the second step you need to follow before you can turn on the Message Manager. Make sure your OGM (Outgoing Message) is less than 20 seconds long.

- 1 Press **Menu/Set, 8, 3**. The screen prompts you to choose an OGM.
- 2 Press **◀** or **▶** to reach **TAD MESSAGE**.
This is the only setting you can select if you want to turn the Message Manager on.
- 3 Press **Menu/Set**.
- 4 Press **◀** or **▶** to select **RECORD MSG** and press **Menu/Set**.
- 5 Pick up the handset to record a message.
For example: Hello. We are unable to take your call at this time. Please leave a message after the signal. If you wish to send a fax, please press *5 1, wait for the fax tones, then press the start button on your machine. *See “Recording the Fax/Tel Outgoing Announcement (F/T MESSAGE) (Only for FAX-T76)” on page 26.*
- 6 Replace the handset. The Message Manager plays your OGM.
- 7 Press **Stop** to exit.

Listening the Outgoing Message (OGM)

- 1 Press **Menu/Set, 8, 3**.
- 2 Press **◀** or **▶** to select **TAD MESSAGE** (or **F/T MESSAGE** or **PAGING MSG.**), and press **Menu/Set** when the screen displays your selection.
- 3 Press **◀** or **▶** to select **PLAY MSG** and press **Menu/Set**. Adjust volume by pressing **◀** or **▶**.
- 4 Press **Stop** to exit.

Erasing the Outgoing Message (OGM)

- 1 Press **Menu/Set, 8, 3**.
- 2 Press **◀** or **▶** to select **TAD MESSAGE** (or **F/T MESSAGE** or **PAGING MSG.**), and press **Menu/Set** when the screen displays your selection.
- 3 Press **◀** or **▶** to select **ERASE MSG** and press **Menu/Set**.

4 Press **1** to erase the OGM—**OR**—Press **2** to exit without erasing.

5 Press **Stop** to exit.

Activating Message Manager Mode

Press and hold  until the screen displays **TAD:MSG MGR**.

When  light is out, the Message Center is off. See “Setting Up Message Manager” on page 56.

Message Indicator

The  light flashes when you have new messages and/or faxes waiting for your review.

The LCD screen displays the total number of voice (including memos) and/or fax messages stored in Message Manager memory.

VOICE:03 DOC:02

If you press the flashing  to turn off the Message Manager before getting you new messages, they won't be lost. The new messages will be played automatically and the LCD will ask you to acknowledge the new faxes:

PRINT DOC?
1.YES 2.NO

Press **1** to print (and automatically delete) the faxes from memory—**OR**—Press **2** to save the faxes in memory until printing is convenient.

What Happens When the Memory Is Full...



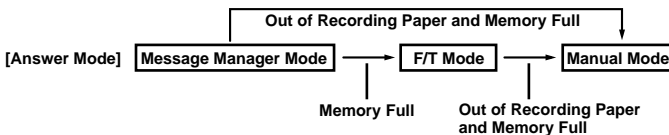

If the memory becomes full when you have set your machine to Message Manager mode, the machine will change to F/T mode automatically. In this mode, the machine can accept incoming faxes automatically. Then, if your machine should run out of paper, the answer mode will shift automatically to manual mode. In manual mode the call is not answered, so your caller will know to try again later.



Print the Memory Status List and select the item to be cleared. This will clear space for new messages and faxes to be stored in memory. See “Printing Reports” on page 33.

Playing Voice Messages

Follow the steps below to listen to voice messages.

1 Press **Play/Record**. Adjust volume by pressing  or .

All new messages are played in the order they were recorded. The display shows the number of the current message, and the total number of messages.

If Caller ID information was received, the machine beeps during the message and displays the Caller ID information for one second.

During playback, the screen displays the time and date the message was recorded.

2 Press ***** (RWD) at the end of the message to repeat a message. Use **#** (FWD) to skip to the next message. You can press ***** and **#** repeatedly until you reach the message you want to play.

3 Press **Stop** to exit.

Printing a Fax Message

Once you print a new fax message stored in memory, it is erased from the memory automatically.

- 1 Press **Play/Record**. After two seconds, the machine begins to play voice messages.
- 2 After playing voice messages, the display asks if you want to print fax messages that are in the memory. There is no display if there are no faxes.

PRINT DOC?

1. YES 2. NO
- 3 To print the fax messages, press **1**—**OR**—Press **2** to exit without printing.

Backup Printing Option

When you choose **DOC:ON** in the Message Manager mode, all incoming fax messages are stored in the available memory for retrieval. To print a backup copy automatically, turn this option on.

- 1 Press **Menu/Set**, **8**, **2**. The screen prompts you to select a setting.
- 2 Press **◀** or **▶** to display **ON** (or **OFF**), and press **Menu/Set** when the screen displays your selected setting.
- 3 Press **Stop** to exit.

Erasing Messages

If you choose to erase all fax messages, the machine will print any previously unprinted fax messages before erasing them from memory. Fax messages cannot be erased individually.

You can erase voice messages individually, or all at once.

To erase voice messages individually

- 1 Press **Play/Record**. The machine beeps and begins message playback. Each message is preceded by one long beep, and followed by two short beeps.
- 2 To erase a specific message, press **Erase** immediately after the two short beeps, or while the message is playing. The screen prompts:

ERASE THIS MSG.?

1. YES 2. NO
- 3 Press **1** to erase the message—**OR**—Press **2** to cancel.
- 4 Press **Stop** to exit.

To erase messages all at once

- 1 Press **Erase**. The screen prompts you to choose what kind of messages you want to erase.

ERASE ALL VOICE?

SELECT ← → & SET
- 2 Press **◀** or **▶** to select erasing all voice messages (**ALL VOICE**), all document messages (**ALL DOC.**), or all messages—both voice and fax—(**ALL MSG**), and press **Menu/Set**.
- 3 Press **1** to erase—**OR**—Press **2** to cancel.

Setting the Maximum Time for Incoming Messages

Your machine comes set to receive voice messages up to 35 seconds long. You can change this setting to any length from 35 seconds to 60 seconds, from 20 seconds to 60 seconds (for Ireland), in 5-second increments.

- 1 Press **Menu/Set, 8, 4**. The screen prompts you to select a maximum time.
- 2 Press **◀** or **▶** to select the maximum time setting for incoming messages, and press **Menu/Set** when the screen displays your setting.
- 3 Press **Stop** to exit.

Setting the Toll Saver

When you set the Toll Saver feature, the machine answers after 4 rings if you don't have messages, and after 2 rings if you do have messages. This way, when you call the machine, if it rings 3 times, you know you have no messages, and can hang up, avoiding any toll charge.



When Toll Saver is **ON**, it overrides your Ring Delay setting. Toll Saver must be off for the machine to operate using your Ring Delay setting. See *“Setting the Ring Delay” on page 25*.

- 1 Press **Menu/Set, 2, 1**.
- 2 Press **◀** or **▶** to select **TOLL SAVER** (or **RING DELAY**), and press **Menu/Set** when the screen displays your selection.
- 3 Press **◀** or **▶** to select **ON** (or **OFF**), and press **Menu/Set**.
- 4 Press **Stop** to exit.

ICM Recording Monitor

This feature lets you turn **OFF** (or **ON**) the speaker volume for voice messages. When you turn the monitor **OFF**, you will not hear messages as they come in.

- 1 Press **Menu/Set, 8, 5**.
- 2 Press **◀** or **▶** to select **OFF** (or **ON**), and press **Menu/Set** when the screen displays your selection.
- 3 Press **Stop** to exit.

Recording a Conversation

You can record a telephone conversation by pressing **Play/Record** during the conversation. Your recording can be as long as the Incoming Message Maximum Time. You and the other party will hear a beep every 15 seconds while recording. You cannot record a conversation using the Speakerphone.

Fax Forwarding/Paging

When Paging is set to ON, your machine dials the pager number you have programmed and, when connected, plays the Paging OGM message you have recorded for 60 seconds. This activates your pager and let you know you have a fax or voice message in the Message Manager memory.

When Fax Forwarding is set to ON, your machine dials the fax machine phone number you've programmed, and forwards any faxes you've received.



You cannot use Paging and Fax Forwarding at the same time.

Programming a Fax Forwarding Number

- 1 Press **Menu/Set, 8, 6**.
- 2 Press **◀** or **▶** until the screen displays **FAX FORWARD**, and press **Menu/Set**.
The screen prompts you to enter the number of the fax machine where faxes will be forwarded.
- 3 Enter the forwarding number (up to 20 digits), and press **Menu/Set**.
- 4 Press **Stop** to exit.

You can change a Fax Forwarding number remotely.

Recording the Paging Outgoing Message (OGM)

Before paging can work, you should first record the Paging OGM.

- 1 Press **Menu/Set, 8, 3**. The screen prompts you to choose an OGM.
- 2 Press **◀** or **▶** to reach **PAGING MSG.**, and press **Menu/Set**.
- 3 Press **◀** or **▶** to select **RECORD MSG**, and press **Menu/Set**.
- 4 Pick up the handset to record a message.
- 5 Press **Stop**. The Message Manager plays your OGM.
- 6 Press **Stop**.

Programming the Paging Number

- 1 Press **Menu/Set, 8, 6**.
- 2 Press **◀** or **▶** until the screen displays **PAGING**, and press **Menu/Set**.
The screen prompts you to enter your pager number.
- 3 Enter your paging number up to 20 digits and press **Menu/Set**.
This is the telephone number which your machine must call.
- 4 Press **Stop** to exit.



You cannot change a Paging number remotely.

Remote Retrieval

This section is for the FAX-T76. (If you have the FAX-T74, please see chapter 10 for your remote fax options.)

You can call your machine from any touch tone phone (or remote Group 3 fax machine set for tone) and use a Remote Access Code and Remote Control Commands to retrieve voice (and fax) messages. You can also program and change some settings for your Message Manager.

Using the Remote Access Code

- 1 Dial your machine phone number from a touch tone phone.
- 2 When your machine answers and beeps, immediately enter your Remote Access Code.
- 3 The machine signals the kinds of messages received:
 - 1 long beep—**Fax message(s)**
 - 2 long beeps—**Voice message(s)**
 - 3 long beeps—**Fax and Voice message(s)**
 - No beeps—**no messages**
- 4 The machine then prompts you with two short beeps to enter a command. If you wait longer than 30 seconds to enter a command, the machine hangs up. If you enter an invalid command, the machine beeps three times.
- 5 Press **9 0** to reset the machine when you finish.
- 6 Hang up.



If your fax machine is set to MANUAL mode, you can access the Message Manager remotely by phoning your machine and letting it ring for about 100 seconds. Your fax machine will answer the phone after 100 seconds of ringing, and you then have 30 seconds to enter your Remote Access Code.

Changing the Remote Access Code

Enter your Remote Access Code when the machine picks up your call, so you can access features remotely. The access code is preset to 1 5 9 *, but you can change this.

- 1 Press **Menu/Set, 8, 7**.
- 2 Enter a three-digit number from 000 to 900 and press **Menu/Set**.
The * cannot be changed. Do not use the same digits that appear in your Remote Activation or Deactivation Code.
- 3 Press **Stop** to exit.



When you call your machine and enter the Remote Access Code, you must press the fourth digit (three-digit number plus *).

Remote Control Commands

Follow the commands below to access features remotely. When you call the fax machine and enter your Remote Access Code (1 5 9 *), the system will signal you with two short beeps to enter a remote control command.

| Remote control commands | | Detail Operation |
|--|---------------------------|---|
| 91 Playing voice messages | | After one long beep, the machine plays ICM. |
| | 1 ◀ (Skip back) | Press 1 while listening to an ICM to play it again. If you press 1 before a message, you will hear the previous message. |
| | 2 ▶ (Skip next) | While playing ICM, you can skip to next message. |
| | 9 STOP Playing | Stop playing the ICM. |
| 92 Record Memo | | After one long beep, you can record a memo. You can stop recording by pressing 9 . |
| 93 Erase all ICM | | If you hear one long beep, the erase is accepted. If you hear three short beeps, you cannot erase because all voice messages have not been played, or there is no voice message to erase. *This code erases all recorded messages, not one at a time. |
| 94 Play and Record OGM in memory | | |
| 1 Play | 1 TAD MSG | The machine plays the selected OGM. You can stop playing OGMs by pressing 9 . |
| | 2 F/T MSG | |
| | 3 PAGING MSG | |
| 2 Record | 1 TAD MSG | After one long beep, you can record the selected OGM. You will hear the message played once. You can stop recording the message by pressing 9 . |
| | 2 F/T MSG | |
| | 3 PAGING MSG | |
| 95 Changing Fax Forwarding/Paging setting | | |
| | 1 OFF | If you hear one long beep, the change is accepted. If you hear three short beeps, you cannot change it because the conditions have not been met (Example: registering paging number). You can register your fax forwarding number by using 4. FAX FWD NO (<i>See “Changing the Fax Forwarding Number” on page 65</i>). Once you have registered the number, the machine will automatically turn to “FAX FWD:ON” mode. Then retrieve a Memory Status List by entering 9 6 1 to make sure that the Fax Forwarding number you registered is correct in the List. |
| | 2 Fax Forwarding | |
| | 3 Paging | |
| | 4 FAX FWD NO. | |
| 96 Retrieve Fax | | |
| | 1 Memory Status List | Enter the number of a remote fax machine to receive a report or stored fax messages. <i>See “Retrieving the Memory Status List” on page 64. Also see “Retrieving Fax Messages” on page 64.</i> |
| | 2 Retrieve all FAX | |
| | 3 Erase FAX in the memory | If you hear one long beep, you can erase the fax message from the memory. |

| Remote control commands | Detail Operation | | |
|---|---|---------|--|
| 97 Check the receiving status <table border="1" style="margin-left: 20px;"> <tr> <td>1 Document</td> </tr> <tr> <td>2 Voice</td> </tr> </table> | 1 Document | 2 Voice | You can check whether your fax machine has received any Document or Voice messages. If yes, you will hear one long beep. If no, you will hear three short beeps. |
| 1 Document | | | |
| 2 Voice | | | |
| 98 Change Answer Mode <table border="1" style="margin-left: 20px;"> <tr> <td>1 TAD</td> </tr> <tr> <td>2 F/T</td> </tr> <tr> <td>3 FAX</td> </tr> </table> | 1 TAD | 2 F/T | 3 FAX |
| 1 TAD | | | |
| 2 F/T | | | |
| 3 FAX | | | |
| 90 Exit | After a long beep, you can exit remote control. | | |

Retrieving the Memory Status List

You can retrieve the Memory Status List from a remote fax machine to see if you have any fax messages.

- 1** Dial your fax machine's number.
- 2** When you hear the beep, immediately enter your Remote Access Code (1 5 9 *).
- 3** When you hear two short beeps, use the dial pad to press **9 6 1**.
- 4** Using the dial pad, enter the number (up to 20 digits) of the remote fax machine where you want the Memory Status List forwarded, and then press **# #**.



You cannot use * and # as dial numbers. However, if you want to store a pause, press #.

- 5** After you hear your fax machine beep, hang up and wait.
Your fax machine calls the remote fax machine. Your fax machine then sends the Memory Status List to the fax machine that you are calling from.

Retrieving Fax Messages

- 1** Dial your fax machine's number.
- 2** When you hear the beep, immediately enter your Remote Access Code (1 5 9 *).
- 3** As soon as you hear two short beeps, use the dial pad to press **9 6 2**.
- 4** Using the dial pad, enter the number (up to 20 digits) of the remote fax machine where you want your fax messages forwarded, and then press **# #**.



You cannot use * and # as dial numbers. However, if you want to store a pause, press #.

- 5** After you hear your fax machine beep, hang up and wait.
Your fax machine calls the remote fax machine. The fax machine that you are calling from prints your fax messages.

Changing the Fax Forwarding Number

You can change the default setting of your fax forwarding number from a remote fax machine.

- 1 Dial your fax machine's number.
- 2 When you hear the beep, immediately enter your Remote Access Code (1 5 9 *).
- 3 When you hear two short beeps, use the dial pad to press **9 5 4**.
- 4 Enter the new number of the remote fax machine where you want your fax messages forwarded, and then press **##**.



You cannot use * and # as dial numbers. However, if you want to store a pause, press #. Also, if your fax machine is connected to a PABX, you can press # first before the fax machine's number. The # works as well as R key.

- 5 To retrieve the Memory Status List, when you hear two short beeps, use the dial pad to press **9 6 1**.
- 6 Use the dial pad to enter the number of the remote fax machine (up to 20 digits), and then press **##**.
- 7 After you hear your fax machine beep, hang up and wait.
Your fax machine calls the remote fax machine. Your fax machine then sends the Memory Status List showing the new forwarding number to the fax machine that you are calling from.
- 8 Check the forwarding number.
If the forwarding number is incorrect, return to Step 1 to reset it.

12 Troubleshooting and Maintenance

Error Messages

You may occasionally encounter a difficulty with your machine or telephone line. If this happens, your machine often identifies the problem and displays an error message. The list below explains the most common error messages.

| ERROR MESSAGE | CAUSE | ACTION |
|--|--|---|
| CHECK PAPER | The paper is jammed in the machine. | See <i>“Clearing Jams” on page 67.</i> |
| CHECK PAPER PRESS START KEY | The FAX/MFC is out of paper or paper is not properly loaded in the multipurpose sheet feeder. | Refill the paper or remove the paper and load it again and then press Start . |
| CLEAN UP SCANNER | The scanner is dirty. | See <i>“Regular Maintenance” on page 70.</i> |
| COMM.ERROR | A poor quality phone line resulted in a communications error. | Try the call again. |
| CONNECTION FAIL | You have requested a polling call from another party, but the other fax machine is not in Poll Waiting mode. | Verify the other parties polling setup. |
| DISCONNECTED | The other party has disconnected during a call or fax. | Try calling the other party. |
| DOCUMENT JAM | The documents were not inserted or fed properly, or were too long. | See <i>“Clearing Jams” on page 67.</i> |
| MACHINE ERROR XX | There is a mechanical problem. | Cut the power off. Then contact your Brother dealer for service. |
| NO RESPONSE/ BUSY | The number you called does not answer or is busy. You may also have reached a number not connected to a fax. | Check the number and call again. |
| NOT ASSIGNED | You’ve tried accessing a One Touch or Speed Dial location with no number assigned to it. | See <i>“Setup Quick Dial Numbers for Easy Dialling” on page 18</i> for information about storing One Touch or Speed Dial numbers. |
| PRINTER FAULT | The print head has overheated. | Unplug the machine and wait 30 minutes for it to cool. |
| SCANNER ERROR | Scanner needs cleaning. | Clean the white tape and the glass strip under the tape. See <i>“Regular Maintenance” on page 70.</i> If you still get a scanner error, contact Brother dealer for service. |
| TOP COVER OPEN | The top cover is not completely closed. | Close the top cover. |

Clearing Jams

Document Jam

- 1 Remove any paper that is not jammed from the ADF.
- 2 Open the top cover by lifting the lever on the right side of the top cover.
- 3 Pull the document toward the front of the machine.
- 4 Close the cover.

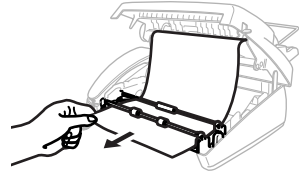

Paper Jam

- 1 Remove any paper that is not jammed.



- 2 Open the top cover by lifting the lever on the right side of the top cover.

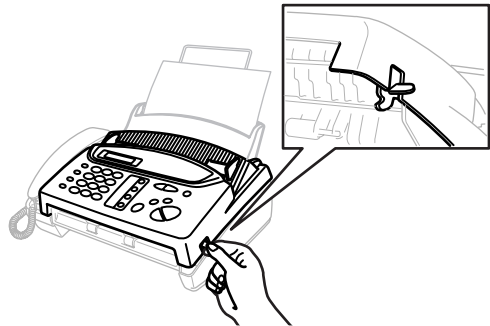

Top Cover

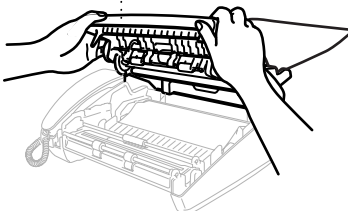

- 3** Pull the jammed paper gently from the paper tray toward the *front* of the machine. If the paper is jammed, then pull it toward the *back* of the machine.

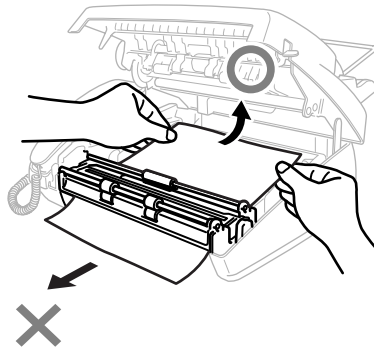
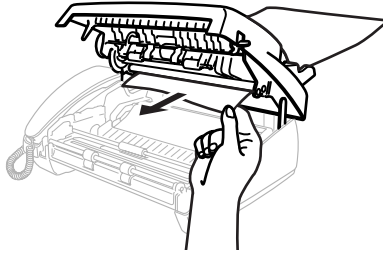

- 4** Remove the print cartridge and turn the spool to tighten the ribbon.
- 5** Install the cartridge.
- 6** Close the top cover.
- 7** Load the paper.

Difficulty with Operation

If you think there is a problem with your machine, make a copy first. If the copy looks good, the problem is probably not your machine. Check the difficulties below and follow the troubleshooting tips.

| DIFFICULTY | SUGGESTIONS |
|---|---|
| Printing or Receiving Faxes | |
| Condensed Print and Horizontal Streaks; Top and Bottom of Sentences Cut Off | If your copy looks good, you probably had a bad connection, with static or interference on the phone line. Ask the other party to send a fax again. If the copy looks bad, clean the scanner area. If there is still a problem, call Brother dealer for service. |
| Vertical Black Lines When Receiving | The sender's scanner may be dirty. Ask the sender to make a copy to see if the problem is with the sending machine. Try receiving from another fax machine. If the problem continues, contact the Brother dealer for service. |
| Phone Line or Connections | |
| Fax Machine Does Not Answer When Called | Make sure the machine is in the correct receiving mode for your setup (either FAX, F/T (FAX/TEL) or TAD). Check for dial tone. If possible, call your machine to hear it answer. If there is still no answer, check the telephone line cord connection. Connect a standard telephone handset to the machine's telephone jack. If there is no ringing when you call your machine, call your Telephone Company to check the line. |
| No Dial Tone on the Handset | Press Speaker Phone — OR —Lift the handset. If you hear no dial tone, check telephone line cord connections at the machine and wall jack. Check that the handset is connected to the machine's handset jack. Test the wall jack with another single line telephone. If no dial tone on the wall outlet, call your Telephone Company. |
| Sending Faxes | |
| Poor Transmitting Quality | Try changing your resolution to FINE or SUPERFINE (<i>See "Resolution" on page 21</i>). Make a copy to verify the machine's scanner operation. |
| Dialling Does Not Work | Check for a dial tone. Change TONE/PULSE setting (<i>See "Setting the Dialling Mode (Tone/Pulse)" on page 8</i>). Check all line cord connections. Check power cord connection. Send a manual fax by pressing Speaker Phone — OR —Lifting the handset, and dialling the number. Wait to hear fax receiving tones before pressing Start . |

| DIFFICULTY | SUGGESTIONS |
|--|---|
| Vertical Black Lines When Sending | Use your machine to make a copy. If the copy shows the same problem, the scanner area is dirty. Lift the front cover and check the document path. Clean the scanner's white pressure tape and the glass strip under the tape using isopropyl alcohol and a lint-free cloth. |
| Handling Incoming Calls | |
| F/T Pseudo-Ring in F/T Mode | The machine knows the incoming call is not a fax so it is signalling you to answer the telephone call. Pick up the machine's handset or answer from an extension phone and press your machine's Remote Deactivation Code (default setting is # 5 1). |
| Transferring a Call to the Machine | If you have answered the machine's handset, press Start , and hang up immediately. If you answered at an extension phone, press your three-digit Remote Activation Code (the factory setting is * 5 1). When your machine answers, hang up. |
| Fax Machine "Hears" Voice as CNG Tone | If your machine is set to Fax Detect ON , and it answers voice calls by trying to receive a fax, try turning Fax Detect to OFF . |
| Transmission Verification Report Prints "RESULT:ERROR" | There is probably temporary noise or static on the phone line. Try sending the fax again. If the problem continues, call the Telephone Company to check your phone line. |

Regular Maintenance

Cleaning the Scanner

Clean the white tape and the glass strip under the tape with isopropyl alcohol on a lint-free cloth. Be careful not to bend the spring plate or drop anything into the machine. Before cleaning, unplug the power cord for safety.

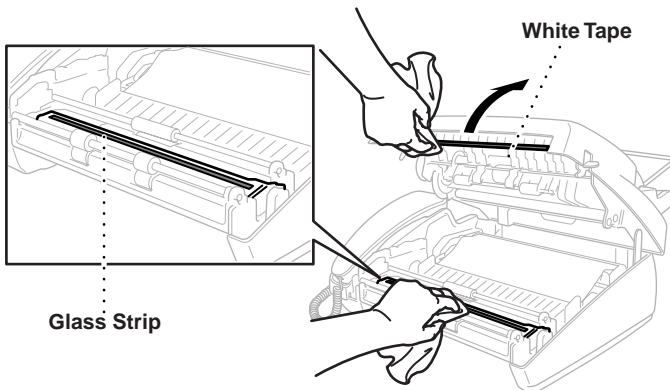

Cleaning the Print Head

To clean the machine print head, wipe the metal part and plastic part with a lint-free cloth that is dry or lightly moistened with isopropyl alcohol. Before cleaning, unplug the power cord for safety.

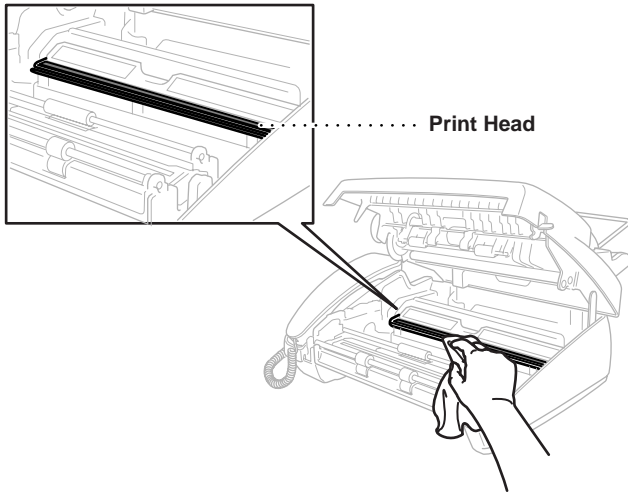

WARNING

After you have just used the machine, some internal parts of the machine are extremely **HOT!** So please be careful.

Changing the Ribbon

- 1 Open the top cover by lifting the lever on the right side of the top cover.

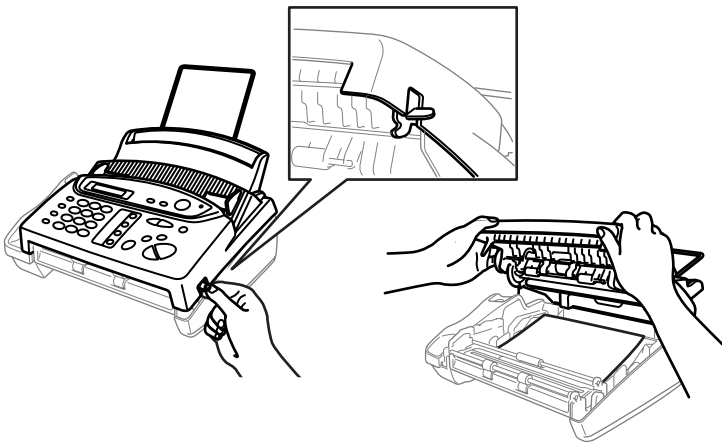

- 2** Remove the print cartridge containing the used ribbon and set it upside—down with the blue gear in the upper left corner.

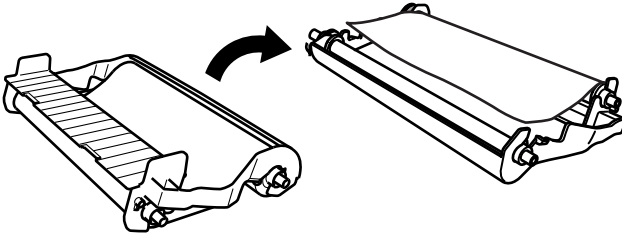

- 3** Take the used ribbon out of the cartridge:
- Snap out the upper white spool and slide the roll off the blue gear. (Do not remove the blue gear.)
 - Lift out the lower roll.

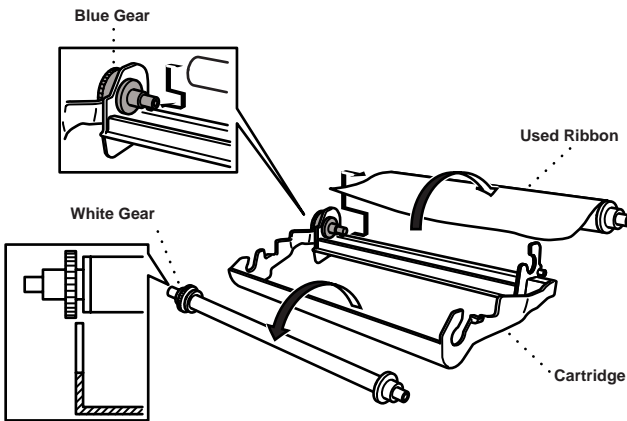

- 4** Slide the white elastic off the new refill rolls and set them down with the full roll in the lower position. (The ribbon's shiny side is facing *down*.)

- 5 Remove the white gear and spools from the ends of the used cardboard cores. Then insert them into the same positions in the new cores.

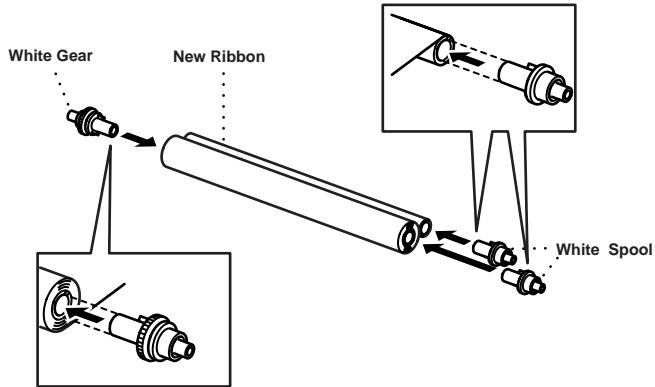

- 6 Slip the upper left cardboard core onto the blue gear of the cartridge and insert the rolls into the cartridge holders.

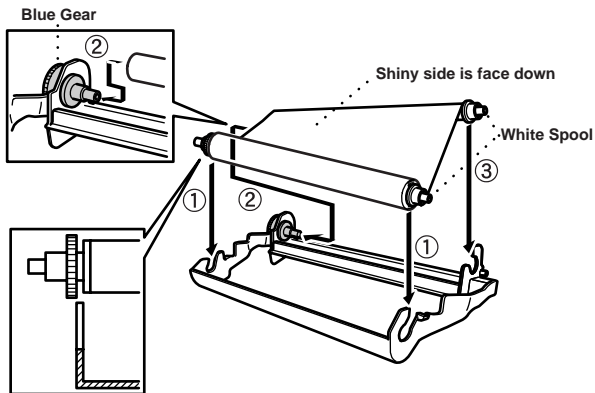

- 7 Turn the upper right white spool *clockwise* to tighten the ribbon, as shown.

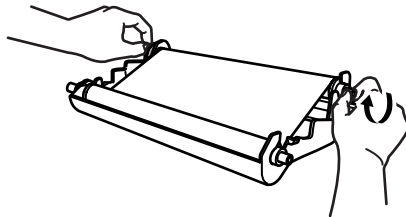

8 Turn the cartridge over and re-install it into the machine: Insert the recessed  first and place the cartridge into its four holders.

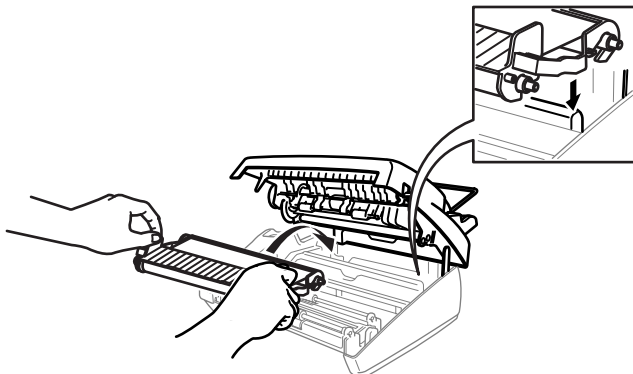
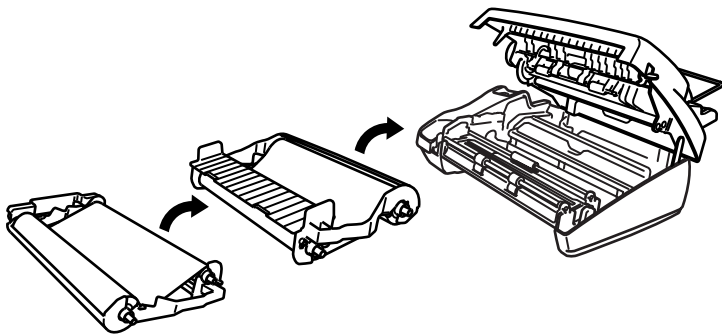

9 Press down on both sides of the top cover to close it securely.

Important Safety Instructions

- 1** Read all of these instructions.
- 2** Save them for later reference.
- 3** Follow all warnings and instructions marked on the product.
- 4** Unplug this product from the wall outlet before cleaning. Do not use liquid or aerosol cleaners. Use a damp cloth for cleaning.
- 5** Do not use this product near water.
- 6** Do not place this product on an unstable cart, stand, or table. The product may fall, causing serious damage to the product.
- 7** Slots and openings in the cabinet and the back or bottom are provided for ventilation; to ensure reliable operation of the product and to protect it from overheating, these openings must not be blocked or covered. The openings should never be blocked by placing the product on a bed, sofa, rug, or other similar surface. This product should never be placed near or over a radiator or heater. This product should never be placed in a built-in installation unless proper ventilation is provided.
- 8** This product should be operated from the type of power source indicated on the label. If you are not sure of the type of power available, consult with your dealer or local power company.
- 9** This product is equipped with a 3-wire earthed plug. This plug will fit into only an earthed socket. This is a safety feature. If you are unable to insert the plug into the outlet, contact your electrician to replace your obsolete socket. Do not defeat the purpose of an earthed plug.
- 10** Do not allow anything to rest on the power cord. Do not place this product where people can walk on the cord.
- 11** If an extension cord is used with this product, make sure that the total ampere ratings on the products plugged into the extension cord do not exceed the extension cord ampere rating. Also, make sure that the total of all products plugged into the wall or floor socket does not exceed the socket rating.
- 12** Do not place anything in front of the machine that will block received faxes. Do not place anything in the path of received faxes.
- 13** Do not touch a document during printing.
- 14** Never push objects of any kind into this product through cabinet slots, since they may touch dangerous voltage points or short out parts resulting in a risk of fire or electric shock. Never spill liquid of any kind on the product.
- 15** Do not attempt to service this product yourself, as opening or removing covers may expose you to dangerous voltage points and/or other risks. Refer all servicing to service personnel.
- 16** This product has no mains ON/OFF switch. It is therefore highly important that access to the mains plug and the mains socket to which the plug is connected, is never obstructed, in case for some reason the mains power to the machine must be quickly disconnected.

- 17** Unplug this product from the mains power and telephone line sockets, and refer servicing to qualified Service Personnel under the following conditions:
- A** When the power cord is damaged or frayed.
 - B** If liquid has been spilled into the product.
 - C** If the product has been exposed to rain or water.
 - D** If the product does not operate normally when the operating instructions are followed. Adjust only those controls that are covered by the operating instructions. Improper adjustment of other controls may result in damage and will often require extensive work by a qualified technician to restore the product to normal operation.
 - E** If the product has been dropped or the cabinet has been damaged.
 - F** If the product exhibits a distinct change in performance, indicating a need for service.
- 18** To further protect your product against power surges, we recommend the use of a power protection device (Surge Protector). This device is not supplied with this product, and can be found at any reputable Electrical, and Electronic outlet.

Specifications

| | |
|--------------------------------|---|
| Type | Desktop facsimile transceiver |
| Compatibility | ITU-T Group 3 |
| Coding system | Modified Huffman (MH) |
| Modem speed | 14400/12000/9600/7200/4800/2400; Automatic Fallback (FAX-T76) 9600/7200/4800/2400; Automatic Fallback (FAX-T74) |
| Document input width | 148 mm to 216 mm |
| Scanning/Printing width | 208 mm |
| Paper cassette | 30 Sheets (85 g/m ²) |
| Printer type | Line Thermal with Ribbon |
| Grey scale | 64 levels (Dithered) |
| Display | LCD, 16 characters |
| Polling types | Standard, Secure, Delayed, Sequential |
| Contrast control | Automatic/Light/Dark (manual setting) |
| Resolution | <ul style="list-style-type: none">• Horizontal 8 dot/mm• Vertical Standard—3.85 line/mm Fine, Photo—7.7 line/mm Superfine, Photo (copy)—15.4 line/mm |
| Memory capacity | 512 KB (up to 20 pages*) |
| One Touch dial | 4 stations |
| Speed Dial | 50 stations |
| Automatic redial | 4 times at 2 minute intervals 3 times at 2 minute intervals (Only for Ireland) |
| Speaker type | Full Duplex, Digital (FAX-T76) Monitor (FAX-T74) |
| Auto answer | 1, 2, 3 or 4 rings 2, 3 or 4 rings (Only for Ireland) |
| Communication source | Public switched telephone network |
| Operating environment | 5 – 35°C |
| Power source | 220 – 240 V AC 50/60 Hz |
| Power consumption | Standby: under 5 watts — Peak: under 170 watts |
| Dimensions | 334 x 301 x 281 (mm) |
| Weight | 3.6 kg |

Specifications are subject to change for improvement without prior notice.

*“Pages” refers to the ITU-T #1 (in Out of Paper Reception in ECM mode).

Function Selection Table

1. INITIAL SETUP

| Function | Description | Factory Set | Chapter |
|------------------------|---|-------------|--------------------------------------|
| 1. TONE/PULSE | Selects the dialling mode. | TONE | See Preparation and Simple Use Guide |
| 2. DATE/TIME | Enter date and time for LCD display and to print on transmissions. | — | |
| 3. STATION ID | Program the name, fax number and telephone number to appear on each transmitted page. | — | |
| 4. BEEPER | Adjust the volume level of the beeps when you press a key, an error occurs or a document is sent or received. | LOW | 1 |
| 5. PBX | Turn on if PABX (Private Automatic Branch Exchange) is connected to your machine. | OFF | 1 |
| 6. CLOCK CHANGE | Adjust the machine's clock by one hour for summer/winter time. | — | 1 |

2. SETUP RECEIVE

| Function | Description | Factory Set | Chapter |
|-------------------------|--|---|---------|
| 1. RING DELAY | Number of rings before the machine answers in F/T, FAX or TAD (Message Manager) mode. | RING DELAY:02 TOLL SAVER:OFF (FAX-T76 Only) | 3 |
| 2. F/T RING TIME | Sets the time for "F/T pseudo-ring" in F/T mode. | 30 | 3 |
| 3. FAX DETECT | Receive fax messages without pressing the Start key. | ON | 3 |
| 4. REMOTE CODE | Enter code to activate or deactivate machine from a remote location or to transfer voice call from DECT cordless phone to the machine. | OFF (* 5 1, # 5 1, * 8 1) | 8 |
| 5. REDUCTION | Reduces size of image. | AUTO | 3 |
| 6. MEM.RECEIVE | Automatically stores any incoming faxes in its memory if it runs out of paper. | ON | 3 |
| 7. POLLING RX | You call another fax machine to receive a fax from it. | — | 9 |

3. SETUP SEND

| Function | Description | Factory Set | Chapter |
|--------------------------|--|-----------------|---------|
| 1. COVERPG SETUP | Automatically sends a cover page you program or prints a sample coverpage. | OFF | 7 |
| 2. COVERPAGE NOTE | Program customized message for fax cover page. | — | 7 |
| 3. CONTRAST | Change lightness or darkness of a fax you are sending. | AUTO | 2 |
| 4. RESOLUTION | Allows you to change resolutions page by page. | STANDARD | 7 |
| 5. OVERSEAS MODE | Adjusts for sometimes difficult overseas transmissions. | OFF | 7 |
| 6. CALL RESERVE | You can send a fax, then speak or print a sample call back message. | OFF | 7 |
| 7. TIMER | Send documents later. | — | 7 |
| 8. POLLED TX | Set Polled Transmission for someone to poll your fax machine to receive a fax. | — | 9 |
| 9. MEMORY TX | You can send faxes from memory. | OFF | 7 |

4. CANCEL JOB

| Function | Description | Factory Set | Chapter |
|----------|--------------------------------------|-------------|---------|
| | Cancel a delayed fax or polling job. | | 7, 9 |

5. INTERRUPT

| Function | Description | Factory Set | Chapter |
|----------|--|-------------|---------|
| | Send a fax now, even if you have the machine set to send a fax later, or if you have it set for Polling. | | 7 |

6. SET QUICK-DIAL

| Function | Description | Factory Set | Chapter |
|--------------------------|---|-------------|---------|
| 1. ONE-TOUCH DIAL | Dial numbers stored in memory by pressing only one key. | — | 1 |
| 2. SPEED-DIAL | Dial numbers stored in memory by pressing only four keys. | — | 1 |
| 3. SETUP GROUPS | Set up a Group number for broadcasting. | — | 7 |

7. PRINT REPORTS

| Function | Description | Factory Set | Chapter |
|-------------------------|--|--------------------|---------|
| 1. XMIT REPORT | Print lists and reports of activity. (Details in chapter 6) | OFF | 6 |
| 2. JOURNAL | | JOURNAL:OFF | 6 |
| 3. QUICK-DIAL | | — | 6 |
| 4. TEL. INDEX | | — | 6 |
| 5. SYSTEM SETUP | | — | 6 |
| 6. MEMORY STATUS | | — | 6 |

8. REMOTE FAX OPT (FAX-T74 Only)

| Function | Description | Factory Set | Chapter |
|--------------------------|--|-------------|---------|
| 1. FAX FWD | Set your fax machine to forward faxes. | OFF | 10 |
| 2. FAX STORAGE | Store incoming faxes in memory for remote retrieval. | OFF | 10 |
| 3. REMOTE ACCESS | Set code for retrieving faxes. | 1 5 9 * | 10 |
| 4. PRINT DOCUMENT | Print incoming faxes stored in the memory. | | 3 |

8. SETUP TAD (FAX-T76 Only)

| Function | Description | Factory Set | Chapter |
|---------------------------|--|---|---------|
| 1. MESSAGE STORE | Select if memory will store fax, voice or both. | DOC:OFF VOICE:ON | 11 |
| 2. BACKUP PRINT | Automatically prints a copy of faxes received into memory. | ON | 11 |
| 3. OGM | Select/Record outgoing message. | TAD MESSAGE | 3, 11 |
| 4. ICM MAX. TIME | Select maximum length of incoming messages. | 35 seconds 30 seconds (For Ireland) | 11 |
| 5. ICM REC. MONITR | Select ON or OFF for voice messages as they come in. | ON | 11 |
| 6. FAX FWD/PAGING | Set fax machine to forward fax/ message—OR—to call your pager. | OFF | 11 |
| 7. REMOTE ACCESS | Set code for retrieving messages. | 1 5 9 * | 11 |

0. MISCELLANEOUS

| Function | Description | Factory Set | Chapter |
|--|---|-------------|---------|
| 1. CALLER ID (Only for the U.K. and Ireland) | View and dial back, or print a list of the last 30 Caller IDs stored in memory. | ON | 8 |
| 2. BT CALLSIGN (Only for the U.K.) | Use with BT Call Sign. | OFF | 8 |

Entering Text

When you are setting certain functions, such as the Station ID, you may need to enter text into the machine. Most keys on the dial pad have three or four letters printed above them. The keys for 0, #, and * don't have printed letters because they are used for special characters.

By pressing the appropriate number on the dial pad the correct number of times, you can access the character you want.

| Press Key | one time | two times | three times | four times | five times |
|-----------|----------|-----------|-------------|------------|------------|
| 2 | A | B | C | 2 | A |
| 3 | D | E | F | 3 | D |
| 4 | G | H | I | 4 | G |
| 5 | J | K | L | 5 | J |
| 6 | M | N | O | 6 | M |
| 7 | P | Q | R | S | 7 |
| 8 | T | U | V | 8 | T |
| 9 | W | X | Y | Z | 9 |

Inserting spaces

If you want to enter a blank space, press ► twice.

Making corrections

If you entered a letter incorrectly and want to change it, press ◀ to move the cursor after the last correct letter. Then press **Stop**; all letters after the cursor are deleted. Re-enter the correct text and/or digits.

Repeating letters

If you need to enter a character assigned to the same key as the previous character, press ► to move the cursor to the right.

Special characters and symbols

Press *, # or 0 repeatedly to move the cursor under the special character or symbol you want, then press ► to select it.

Press * for (space) ! " # \$ % & ' () * + , - . / €

Press # for ; : < = > ? @ [] ^ _

Press 0 for Ä Ë Ö Ü À Ç È É 0

About Fax Machines

If you're a first-time fax machine user, fax operation might seem a little mysterious. You'll soon get used to the unusual fax tones on your phone line, and be able to send and receive faxes easily.

Fax Tones and Handshake

When someone is sending a fax, the fax machine sends fax calling tones, (CNG tones)—soft, beeps at 4-second intervals. You'll hear them when you dial and press **Start**, and they continue for about 40 seconds after dialling. During that time, the sending machine must begin the “handshake” with the receiving machine. Each time you use automatic procedures to send a fax, you are sending CNG tones over the phone line. You'll soon learn to listen for these soft beeps each time you answer a phone on your fax line, so you can know if you are receiving a fax message.

The receiving fax responds with fax receiving tones—loud, chirping sounds. A receiving fax chirps for about 40 seconds over the phone line, and the screen displays **RECEIVE**. If your fax machine is set to the **FAX ONLY** Mode, it will answer every call automatically with fax receiving tones.

Even if the other party hangs up, your fax machine continues to send the “chirps” for about 40 seconds, and the screen continues to display **RECEIVE**. To cancel the receiving mode, press **Stop**.

When your fax machine is in **FAX/TEL (F/T)** mode, it answers with a short beep. After this beep, the fax machine listens for CNG tones, and, if heard, it will respond with receiving tones.

The fax “handshake” is the time in which the sending machine's CNG tones and the receiving machine's “chirps” overlap. This must be for at least 2 to 4 seconds, so the fax machines can understand how each is sending and receiving the fax. The handshake cannot begin until the call is answered, and the CNG tones only last for about 40 seconds after the number is dialled. Therefore, it's important for the receiving machine to answer the call in as few rings as possible.



When you have an external telephone answering device (TAD) on your fax line, your TAD will determine the number of rings before the call is answered. Pay special attention to the directions in the Installation chapter for connecting a TAD to your fax machine.

ECM (Error Correction Mode)

The Error Correction Mode (ECM) is a way for the fax machine to check the integrity of a fax transmission while it is in progress. ECM transmissions are possible only between machines that both have the ECM feature. If they do, you may send and receive fax messages that are continuously checked for their integrity.

Sufficient memory must be available in your machine for this feature to work.

Glossary

- ADF (Automatic Document Feed)** Refers to the number of pages that can be placed in the document feeder and fed one at a time automatically.
- Automatic fax transmission** Sending a fax without picking up the handset or pressing **Speaker Phone**.
- Backup Print** Sets your machine to print a copy of faxes that are received and stored in memory.
- Beeper** The sound that the speaker makes when the keys are pressed, an error occurs or a document has been received or transmitted.
- Broadcasting** The ability to send the same fax message to more than one location.
- Call Back Message** Allows you to send a fax and then leave a message for the other party to call you back.
- Call Reservation** Allows you send a fax and then at the end of transmission, you can talk with the other party.
- Caller ID** A service purchased from the Telephone Company that lets you see the number (or name) of the party calling you.
- Cancel Job** Cancels a programmed job, for instance, Delayed Fax or Polling.
- CNG tones** The special tones (beeps) sent by fax machines during automatic transmission to tell the receiving machine that they are from fax machine.
- Communication error (or Comm. Error)** An error during fax sending or receiving, usually caused by line noise or static.
- Contrast** Setting to compensate for dark or light documents, by lightening dark documents or darkening light documents.
- Cover Page** Prints a page at the other party's machine, that contains the sender and recipient's name and fax number, number of pages and comment. You can generate an electronic cover page at the other end with pre-programmed information from memory or you can print a sample cover page to fax with your document.
- Delayed Transmission** Sends your fax at a later time that day.
- ECM (Error Correction Mode)** Detects errors during fax transmission and resends the page(s) of the document that had an error.
- F/T Ring Time** The length of time the machine rings (when the answer mode setting is FAX/TEL) to notify you to pick up a voice call that it answered.
- Fax Forwarding** Sends a fax received in memory to another preprogrammed fax number.
- Fax tones** The signals sent by sending and receiving fax machines while communicating information.
- Fine Mode** Resolution is 196 x 203 dpi. It is used for small print and graphs.
- Grey scale** The shades of grey available for copying and faxing photographs.
- Group number** A combination of One Touch and/or Speed Dial numbers that are stored on a One Touch Dial key for Broadcasting.
- ICM (incoming message)** A recorded voice message received into an external answering machine or the FAX-T76's digital Message Manager.

- Interrupt** Temporarily puts a waiting job on hold while you perform another operation.
- Journal** Lists information about the last 30 incoming and outgoing faxes.
- Journal Period** The preprogrammed time period between automatically printed Journal Reports.
You can print Journal on demand without interrupting this cycle.
- LCD (Liquid crystal display)** The display screen on the machine that shows interactive messages during On-Screen Programming and defaults to the date and time when the machine is idle.
- Manual fax** When you press **Speaker Phone—OR—**lift the handset so you can hear the receiving fax machine answer before you press Start to begin transmission.
- Memory Status List** Shows how much memory is being used, how much is left, and the type of messages in memory.
- Memory usage** Instructs the machine how to allocate the memory.
- Message Manager** The Message Manager is an electronic messaging facility for faxes and voice mail. Callers can send you faxes or leave voice messages for you, and you can retrieve these from a remote location.
- Next Fax Reservation** Accepts the next document in the document feeder for transmission while the machine is still receiving.
- OGM (Outgoing Message)** The message callers hear when you call your Message Manager or external answering machine.
- Out of Paper Reception** Receives faxes into the machine's memory when the machine is out of paper.
- Overseas Mode** Makes temporary changes to the fax tones to accommodate noise and static on overseas phone lines.
- Paging** Feature enables your fax unit to call your pager when a fax and/or a voice message is received into its memory.
- Pause** Allows you to place a 3.5 second delay in the dialling sequence stored on One Touch and Speed Dial numbers.
- Photo Mode** A resolution setting that uses varying shades of grey for the best representation of photographs.
- Polling** The process of a fax machine calling another fax machine to retrieve waiting fax messages.
- Print reduction** reduces the size of incoming faxes.
- Pulse** A form of dialling on a telephone line.
- Quick-Dial** Keys on the machine control panel where you can store numbers for easy dialling. You must use a separate key for each number.
- Quick-Dial List** A listing of names and numbers stored in One Touch and Speed Dial memory, in numerical order.
- Remote access** The ability to access your Message Manager remotely from a touch tone phone.
- Remote access code** The four-digit code that allows you to call and access your Message Manager from a remote location.
- Remote activation** allows you to transfer a fax call, answered at an extension phone, to the machine.

- Resolution** The number of vertical and horizontal lines per mm. See: Standard, Fine, Super Fine, Photo.
- Ring Delay** The number of telephone rings before the machine answers a call in F/T or FAX ONLY mode.
- Scanning** The process of sending an electronic image of an original paper document into your computer.
- Standard resolution** 98 x 203 dpi. It is used for regular size text and quickest transmission.
- Station ID** The stored information that appears on the top of faxed pages. It includes the sender's name and fax number.
- Super fine resolution** 392 x 203 dpi. Best for very small print and line art.
- System Setup List** A printed report that shows the current setting of your machine.
- Thermal transfer** A printing process in which heat transfers carbon ink from a ribbon to plain paper.
- Toll Saver** A Message Manager setting that allows the machine to answer after two ring when a message(s) was received and after four rings when there are no messages. The caller can hang up (after two rings) without paying for the call if there are no messages to retrieve.
- Tone** A form of dialling on the telephone line used for Touch Tone telephones.
- Transmission** The process of sending documents over the phone lines from your fax machine to the receiving fax machine.
- TX/RX** TX means Transmit. RX means Receive.
- Xmit Report (Transmission Report)** A listing of each transmission, showing caller ID, date, time, and number of pages.

Index

A

Activation Code11, 26, 27, 42, 43
Alternating Displays ii
Answer Mode11, 24, 25
Assembly1
Automatic Document Feeder (ADF)8

B

Backup Printing59
Beeper17
beeps52, 62
Broadcasting39, 40

C

Call Back Message39
Call Reservation38, 39
Caller ID43-46
Cancelling a Job49
Cleaning70, 71
Connecting3, 6, 11, 12
Contrast21
Control Panel13-16
Copy29
Corrections81
Cover Page35-37

D

Date and Time6
Deactivation Code42, 43
Delayed Polling48
Delayed Transmission39
Dialling Mode8
Document7
Document Size7

E

ECM (Error Correction Mode)82
Enlarged Copies29
Entering Text81
Erasing Messages57, 59
Error Messages66
Extension Cord75
Extension Telephone9, 26, 42
External Telephone12, 42
External Telephone Answering Device
(TAD)11

F

F/T (Fax/Tel) Mode24, 32, 42
F/T (Fax/Tel) Outgoing Announcement
(OGM)26
F/T (Fax/Tel) Ring Time25
F/T Pseudo-Ringing25
Fax Detect27
Fax Forwarding61
Fax Only Mode24
Fax Redial23
Fax Storage51
Fax Tones and Handshake82
Fine Resolution21
Flexible Memory Settings56
Function Modeii
Function Selection Table78-81

G

Grey Scale77
Groups40

H

Helpi, 14, 16
Hold13, 15, 32

| | |
|----------------------------------|-------------|
| I | |
| ICM Recording Monitor | 60 |
| Inserting Spaces | 81 |
| Installation | 1 |
| Interrupting | 41 |
| J | |
| Jams | 67-68 |
| Journal | 33 |
| Journal Period | 34 |
| L | |
| Loading Paper | 2 |
| M | |
| Maintenance | 70 |
| Manual Mode | 24 |
| Manual Transmission | 21 |
| Maximum Message Time | 60 |
| Memory | 28, 56 |
| Memory Status List | 33 |
| Memory Storage | 6 |
| Memory Transmission | 38 |
| Message Manager Mode | 56 |
| Message Store | 56 |
| Multi-Line Connections | 9 |
| Multiple Copies | 29 |
| Multiple Resolution | 41 |
| Mute | 13, 15, 32 |
| N | |
| Next-Fax Reservation | 40 |
| O | |
| OGM (Outgoing Message) | 57, 61 |
| One Touch Dialling | 18, 22 |
| On-Screen Programming | ii |
| Operation | 42 |
| Overseas Mode | 37 |
| P | |
| PABX | 17, 18, 31 |
| Packing List | 1 |
| Paging | 61 |
| Paper Size | 2 |
| Pause | 31 |
| Photo Resolution | 21 |
| Playing Messages | 58 |
| Polling | 47 |
| Power | 5, 6, 75-76 |
| Printing | 28, 33, 36 |
| Program Fax Forward Number | 51, 61 |
| Q | |
| Quick Dial | 18 |
| Quick-Dial List | 33 |
| R | |
| Recording a Conversation | 60 |
| Recording Monitor | 60 |
| Recording Paper | 2 |
| Redial | 23 |
| Reducing Copy | 29 |
| Reduction | 27, 29 |
| Remote Access Code | 52, 62 |
| Remote Activation | 42 |
| Remote Code | 43 |
| Remote Commands | 53, 63 |
| Remote Deactivation | 42 |
| Remote Retrieval | 51, 62 |
| Reports | 33 |
| Resolution | 21 |
| Ring Delay | 25 |
| Ring Volume | 17 |

S

| | |
|-----------------------------|----|
| Safety Instructions | 75 |
| scroll | ii |
| Sequential Polling | 48 |
| Setting Up | 1 |
| Sort | 29 |
| Speaker Volume | 17 |
| Speakerphone | 32 |
| Special Characters | 81 |
| Specification | 77 |
| Speed Dialling | 19 |
| Stack | 29 |
| Standard Resolution | 21 |
| Station ID | 7 |
| Super Fine Resolution | 21 |
| System Setup List | 33 |

T

| | |
|--|----|
| TAD MESSAGE | 57 |
| TAD Mode | 24 |
| Telephone Answering Device (TAD) | 11 |
| Temporary Cover Page | 35 |
| Toll Saver | 60 |
| Tone/Pulse | 8 |
| Transmission Verification Report | 33 |
| Troubleshooting | 66 |

V

| | |
|-------------------|----|
| Voice Calls | 31 |
| Volume | 17 |

Accessory List

| Model Name | Description |
|------------|--|
| PC-70 | Printing Cartridge (1 set per box) |
| PC-71RF | 1 re-fill for use in PC-70 Printing Cartridge |
| PC-72RF | 2 re-fills for use in PC-70 Printing Cartridge |
| PC-74RF | 4 re-fills for use in PC-70 Printing Cartridge |

***For optimum print quality and product performance within published specifications, use only the correct Brother replacement ribbon. The use of other ribbons may invalidate your warranty.**

(For FAX-T74)→

Change Answer Mode

Press **9 8**.
then for TAD, press **1**.
Fax/Telephone (F/T), press **2**.
Fax, press **3**.

Exit Remote Operation

Press **9 0**.

Change Remote Access Code

- 1** Press **Menu/Set**, **8**, **3**.
- 2** Enter a three- digit number. The * cannot be changed.
- 3** Press **Menu/Set**.
- 4** Press **Stop** to exit.

(For FAX-T76)



Check Receiving Status

Press **9 7**.
then for Fax message, press **1**.
Voice message, press **2**.
1 long beeps – received messages
3 short beeps – no messages

Change Answer Mode

Press **9 8**.
then for Message Centre, press **1**.
Fax/Telephone (F/T), press **2**.
Fax Only, press **3**.

Exit Remote Operation

Press **9 0**.

REMOTE CONTROL ACCESS CARD

Using Remote Access Code

- 1** Dial your machine phone number from a touch tone phone.
- 2** Enter your Remote Control Access Code (159*) after the beep.
- 3** Your machine signals the kinds of messages received:
1 long beeps – Fax message(s)
No beeps – no messages
- 4** After 2 short beeps, enter a command.
- 5** Press **9 0** to reset your machine when you finish.
- 6** Hang up.

MESSAGE CENTRE REMOTE CONTROL ACCESS CARD

Using Remote Access Code

- 1** Dial your fax machine phone number from a touch tone phone.
- 2** Enter your Remote Control Access Code (159*) after the beep.
- 3** The fax machine signals the kinds of messages received:
1 long beep – Fax message(s)
2 long beeps – Voice message(s)
3 long beeps – Fax and Voice message(s)
No beeps – no messages
- 4** After 2 short beeps, enter a command.
- 5** Press **9 0** to reset the machine when you finish.
- 6** Hang up.

Remote Commands

Change Fax Forwarding Setting

Press **9 5**.

then to **Turn feature off** press **1**.

Enter Fax Forwarding press **2**.

Program Fax Forward Number press **4**. Enter the new number of the remote fax machine where you want your fax messages forwarded, and then press **##**. Press **9 6 1** after two short beeps, then enter the number of remote fax machine, and then **##** to retrieve Memory Status List.

Turn Fax Storage on press **6**.

Turn Fax Storage off press **7**.

Retrieve a Fax

Press **9 6**.

then to **Print a Memory Status List** press **1**, then enter the number of remote fax machine, and then **##**.

After the beep, hang up and wait.

Retrieve all faxes press **2**, then enter the number of remote fax machine, and then **##**. After the beep, hang up and wait.

Erase all fax messages press **3**.

Check the Receiving Status

Press **9 7 1**.

1 long beep – Fax message(s)

3 short beeps – no messages

②

③

Changing Remote Access Code

1 Press **Menu/Set**, **8**, **7**.

2 Enter a three-digit number from 000 to 900. The * cannot be changed.

3 Press **Menu/Set**.

4 Press **Stop** to exit.

Remote Commands

Listen to Voice Messages

Press **9 1**.

then to **Repeat a message** press **1**.

Skip to next message, press **2**.

Stop playing the message press **9**.

Record a Memo

Press **9 2**.

Wait for the beep, then speak.

then to **Stop recording** – press **9**.

Erase All Messages

Press **9 3**. If you hear three beeps, all messages have not yet been heard, and the messages will not be erased.

Play/Record Outgoing Message

Press **9 4**.

then to **Play Message Centre OGM** press **1 1**.

Play F/T OGM press **1 2**.

Record new Message Centre OGM press **2 1**, then speak after beep. press **9** to stop.

Record new F/T OGM press **2 2**, then speak after beep. press **9** to stop.

Change Paging/Fax Forwarding Setting

Press **9 5**.

then to **Turn feature off** press **1**.

Enter Fax Forwarding press **2**.

Enter Paging press **3**.

②

③

Program Fax Forward Number

press **4**. Enter the new number of the remote fax machine where you want your fax messages forwarded, and then press **##**. Press **9 6 1** after two short beeps, then enter the number of remote fax machine, and then **##** to retrieve Memory Status List.

Retrieve a Fax

Press **9 6**.

then to **Print a Memory Status List** press

1, then enter the number of remote fax machine, and then **##**. After the beep, hang up and wait.

Retrieve all faxes press **2**, then enter the number of remote fax machine, and then **##**. After the beep, hang up and wait.

Erase all fax messages press **3**.

④



EC Declaration of Conformity for Facsimile machines under R & TTE DIRECTIVE.

Manufacturer

BROTHER INDUSTRIES (U.K.) LTD.

Vauxhall Industrial Estate,
Ruabon, Wrexham, LL14 6HA, UK.

Authorised Representative

Brother International Europe Ltd.,

Brother House, 1 Tame Street,
Audenshaw, Manchester, M34 5JE, UK.

Herewith declare that:

Products description : Brother Fax Machines
Type : Group 3 Thermal Transfer
Model Name : FAX-T74 / FAX-T76

Are in conformity with provisions of the R & TTE DIRECTIVE (99/5/EC)

Standards applied:

Harmonized : Safety : EN 60950 : up to Amd 4, 1996
: EMC : EN55022 / 1998 Class B
: EN50082-1 / 1992
(valid through 30 Jun, 2001)
: EN55024
(effective from 1 Jul, 2001)
: EN61000-3-2 / 1995 + A2 / 1998
: EN61000-3-3 / 1995

Year in which CE marking was first affixed : 2000

brother®

This machine is approved for use in the country of purchase only, local Brother companies or their dealers will only support fax machines purchased in their own countries.

UK/IRE/GNE
LE4391004
Printed in U.K.

Free Manuals Download Website

<http://myh66.com>

<http://usermanuals.us>

<http://www.somanuals.com>

<http://www.4manuals.cc>

<http://www.manual-lib.com>

<http://www.404manual.com>

<http://www.luxmanual.com>

<http://aubethermostatmanual.com>

Golf course search by state

<http://golfingnear.com>

Email search by domain

<http://emailbydomain.com>

Auto manuals search

<http://auto.somanuals.com>

TV manuals search

<http://tv.somanuals.com>