

# Breville

*the Smart Grinder™*

Instruction Booklet



**BCG800**

# CONGRATULATIONS

on the purchase of your new Breville  
Smart Grinder™

## CONTENTS

- 4** Breville recommends safety first
- 7** Know your Breville Smart Grinder™
- 10** Assembling your Breville Smart Grinder™
- 12** Operating your Breville Smart Grinder™
- 16** Care & cleaning for your Breville Smart Grinder™
- 18** Hints & tips
- 20** Troubleshooting

At Breville we are very safety conscious. We design and manufacture consumer products with the safety of you, our valued customer, foremost in mind. In addition we ask that you exercise a degree of care when using any electrical appliance and adhere to the following precautions.

## **IMPORTANT SAFEGUARDS**

### **READ ALL INSTRUCTIONS BEFORE USE AND SAVE FOR FUTURE REFERENCE**

- Carefully read all instructions before operation and save for future reference.
- Remove and safely discard any packaging material and promotional labels before using the Breville Smart Grinder™ for the first time.
- To eliminate a choking hazard for young children, remove and safely discard the protective cover fitted to the power plug of the Breville Smart Grinder™.
- Do not place the Breville Smart Grinder™ near the edge of a bench or table during operation.
- Do not place the Breville Smart Grinder™ on or near a hot gas burner, electric element or where it could touch a heated oven.
- Do not operate the Breville Smart Grinder™ on a sink drain board.
- Ensure that the surface is level, clean and free of water.
- The Breville Smart Grinder™ is not intended to be operated by means of an external timer or separate remote control system.
- To protect against electric shock, do not immerse the grinder base, power cord or power plug in water or allow moisture to come in contact with these parts.
- Always switch the Breville Smart Grinder™ off at the power outlet and unplug if Breville Smart Grinder™ is to be left unattended, if not in use, before cleaning, before attempting to move, disassembling, assembling and when storing.
- The Breville Smart Grinder™ is not intended for use by young children or infirm persons unless they have been adequately supervised by a responsible person to ensure they can use the Breville Smart Grinder™ safely.
- Do not use attachments other than those provided with the Breville Smart Grinder™.
- Do not operate the Breville Smart Grinder™ without locking the bean hopper lid in position. Keep fingers, hands, hair, clothing and utensils away from the bean hopper during operation.
- The coffee grinder should not be switched on until the bean hopper and hopper lid are locked into position in the grinding chamber.
- Do not operate the Breville Smart Grinder™ for longer than 2 minutes as this could cause overheating. Allow the Breville Smart Grinder™ to cool down for 20 minutes after long operation.
- Do not use the Breville Smart Grinder™ for any other purpose than grinding coffee beans.
- Do not use pre ground coffee in bean hopper. The Breville Smart Grinder™ will not grind food that is sticky, or extremely hard, or make pastes of any fruits, seeds or herbs ie. curry pastes, nut batters.
- Keep the Breville Smart Grinder™ and accessories clean. Follow the Care and Cleaning instructions provided on Page 16.

## **IMPORTANT SAFEGUARDS FOR ALL ELECTRICAL APPLIANCES**

- This appliance is for household use only.
- Unwind power cord fully before use.
- Do not let power cord hang over the edge of a table or counter, or touch hot surfaces.
- Do not use the appliance for anything other than its intended purpose as described in this instruction book. Do not use outdoors. Do not use in moving vehicles or boats.
- Close supervision is necessary when any appliance is used by or near children.
- Regularly inspect the supply power cord and actual appliance for any damage. Do not operate if damaged in any way or after the appliance malfunctions. Immediately cease use of the appliance and call Breville Customer Service on Ph: 1300 139 798 (Australia) or Ph: 0800 273 845 (New Zealand).
- If the supply cord is damaged it must be replaced by the manufacturer, its service agent or similarly qualified persons in order to avoid a hazard.
- For any maintenance other than cleaning, call Breville Customer Service on Ph: 1300 139 798 (Australia) or Ph: 0800 273 845 (New Zealand)
- Consult a qualified electrician if the grounding instructions are not completely understood, or if doubt exists as to whether the appliance is properly grounded.

## **BREVILLE ASSIST™ PLUG**

- Your Breville appliance comes with a unique Assist™ Plug, conveniently designed with a finger hole in the power plug for easy and safe removal from the wall outlet. For safety reasons it is recommended you plug your Breville appliance directly into its own electrical outlet on a dedicated circuit separate from other appliances. If the electrical circuit is overloaded with other appliances, your appliance may not function properly. Using in conjunction with a power strip or extension cord is not recommended.

**SAVE THESE INSTRUCTIONS.  
FOR HOUSEHOLD USE ONLY**

# KNOW

your Breville Smart Grinder™

# KNOW YOUR BREVILLE SMART GRINDER™

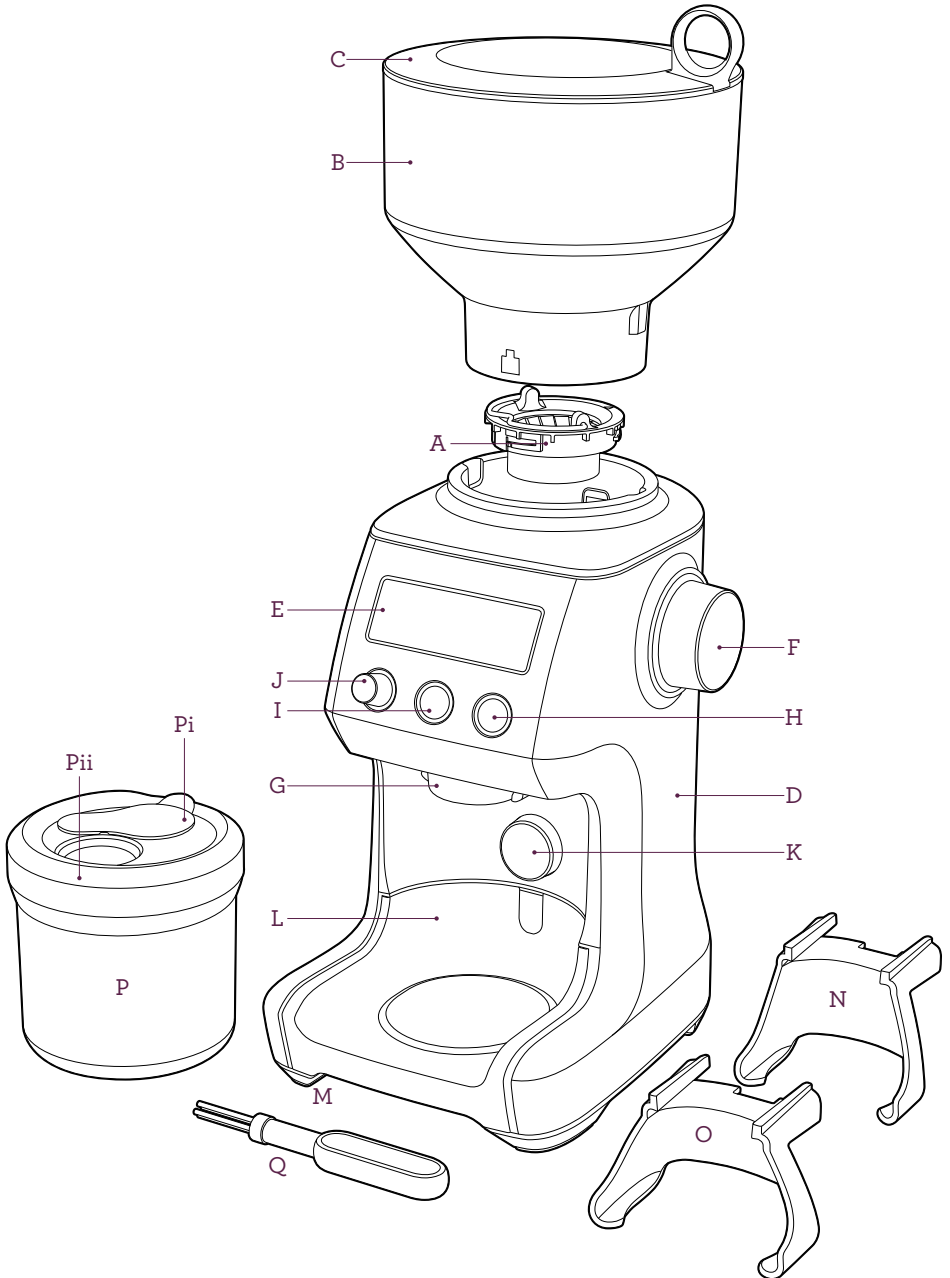



**A. Hardened Stainless Steel Conical Burrs**  
Reduce grinding heat to protect the oils in the coffee bean.

- Removable Upper Burr
- Lower Burr

**B. Bean Hopper**  
450g bean hopper with locking system for easy removal and bean transfer.

**C. Bean Hopper Lid**  
Air tight seal to maximise bean freshness.

**D. Brushed Stainless Steel Body**

**E. Backlit LCD Screen**  
Displays grind setting, number of shots/cups and customised amount.

**F. Grind Size Dial**  
25 custom grind settings from espresso to plunger.

**G. Grind Outlet**

**H. START/CANCEL Button**  
Starts & stops operation.

**I. AMOUNT Button**  
Selects number of shots or cups.

**J. ADJUST AMOUNT Dial**  
Adjusts preset amount 'Less' or 'More' to suit personal taste.

**K. Portafilter Activation Switch**

**L. Grind Catch Tray**  
Catches grind overspill. Removable for easy cleaning.

**M. Slip Reducing Feet**

## ACCESSORIES

**N. Portafilter Cradle 50-54mm**

**O. Portafilter Cradle 58mm**

**P. Grinds Container**  
For storing ground coffee.  
**Pi - Container Cap**  
**Pii - Container Lid**

**Q. Conical Burr Cleaning Brush**

## NOT SHOWN

**Grinding Chamber**  
Minimises static of beans before dispensing.

**Automatic Thermal Safety Shut Off**  
Protects motor from overheating.

**Power Saving/Sleep Mode**  
Unit powers down to standby after 5 minutes of non use.

**Cord Storage**

# ASSEMBLING

your Breville Smart Grinder™

## ASSEMBLING

### BEFORE FIRST USE

Before first use, remove and safely discard all promotional labels and packing materials attached to your Breville Smart Grinder™.

Wash hopper, cradles, grind container, container lid and cleaning brush in warm soapy water and dry thoroughly. Wipe exterior of grinder with a soft damp cloth and dry thoroughly.

Place grinder on flat level surface and plug power cord into 230-240V outlet and switch Power 'ON'.

### ASSEMBLING YOUR BREVILLE SMART GRINDER™

#### Bean Hopper

Align tabs and place bean hopper into position. Turn the bean hopper dial 90° to lock into position. Fill with coffee beans and place lid on top of bean hopper.

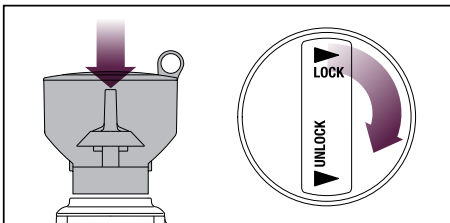

The bean hopper can be removed by turning knob anti clockwise and lifting upwards to pull bean hopper out.

The locking system allows you to remove and transfer hopper without having to remove the beans.

#### NOTE

If Bean Hopper has not been locked into position, 'LOCK BEAN HOPPER' message will be displayed on the LCD screen disabling the operation of the grinder for safety.

# OPERATING

your Breville Smart Grinder™

# OPERATING YOUR BREVILLE SMART GRINDER™

## STEP 1:

### Selecting your Grind Size

For each coffee style, Espresso, Percolator, Filter and Plunger, the grind size will differ. Within each coffee style there is a range of settings.

Experiment with different grind settings to achieve the brew that best suits your taste.

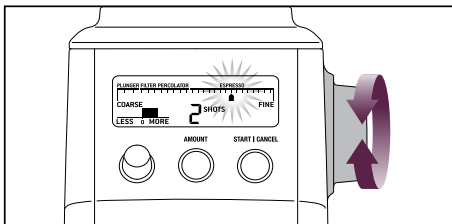

### Grinding for Espresso Coffee Machines

If you are using Dual Wall Filters, we suggest the coarser 11-20 setting. For Single Wall Filters, use the finer 17-25 setting in the ESPRESSO range.

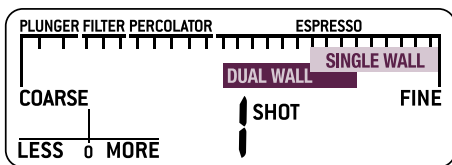

## NOTE

If the grind dial is tight, run grinder empty briefly by pressing the START/CANCEL button whilst turning the dial.

## STEP 2:

### Selecting your Grind Amount

Select the desired amount of grinds required by pressing the AMOUNT button.

To increase, keep pressing the AMOUNT button to the maximum number of shots or cups, as shown in the Coffee Chart below.

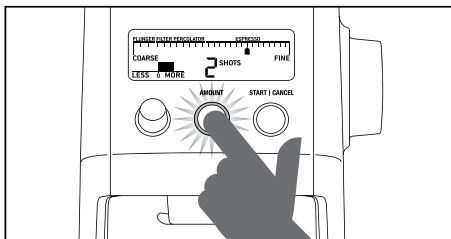

The amount dispensed will vary depending on the grind setting. The Breville Smart Grinder™ will automatically adjust the dose for the grind selected.

## NOTE

You can increase the amount already selected during operation by pressing the AMOUNT button.

## COFFEE CHART

COFFEE TYPE	PLUNGER	DRIP FILTER	PERCOLATOR	ESPRESSO (DUAL WALL)	ESPRESSO (SINGLE WALL)
GRIND SIZE	COARSE	MEDIUM COARSE	MEDIUM	FINE	EXTRA FINE
GRIND SETTING	1-2	3-5	6-10	11-20	17-25
AMOUNT	1 UP TO 12 CUPS	1 UP TO 12 CUPS	1 UP TO 12 CUPS	1 UP TO 8 SHOTS	1 UP TO 8 SHOTS

## STEP 3:

### Using Auto or Manual Grinding Mode

You can **START** and **STOP** the grinding operation in 2 ways.

#### 1. Automatic Grinding (AUTO STOP)

- **'Press & Release'** START/CANCEL button or PORTAFILTER SWITCH once to activate.
- Grinding will **automatically stop** when the selected grind amount is dispensed.

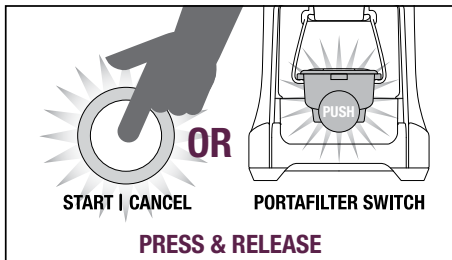

#### 2. Manual Grinding (MANUAL START/STOP)

- **'Press & Hold'** either START/CANCEL button or PORTAFILTER SWITCH for as long as you require. **'Release'** START/CANCEL button or PORTAFILTER SWITCH and the grinding will stop.

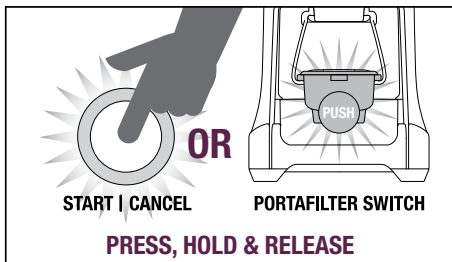

## STEP 4:

### Grinding into your Portafilter, Grind Container or Drip Filter Basket

#### 1. Grinding into Portafilter

- Choose the cradle size that fits your portafilter (either small 50-54mm or large 58mm).
- Slide cradle into position under grind outlet.

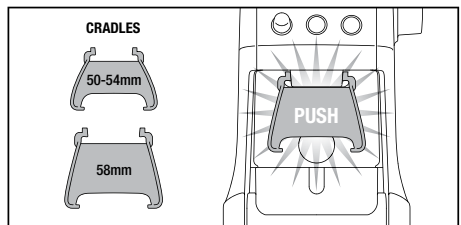

- Insert portafilter into cradle.
- Use AUTOMATIC or MANUAL grinding function to start operation using the START/CANCEL or PORTAFILTER SWITCH.
- Simply slide cradle out to remove.

#### NOTE

You can grind direct into your portafilter even if it does not fit into the cradles supplied; without the cradle attached, press the 'PORTAFILTER SWITCH' with your finger or portafilter.

#### NOTE

It is normal for the correct amount of coffee to appear overfilled in your portafilter. Untamped coffee is three times the volume of tamped coffee.

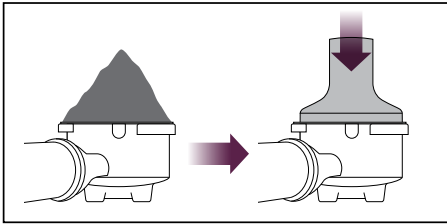

## 2. Grinding into Grind Container

- Slide in grind container with cap open directly under grind outlet.
- Use **AUTOMATIC** or **MANUAL** grinding function to start operation using the **START/CANCEL** button on the control panel.

You can grind into grind container without the lid. However, we recommend keeping the lid on to prevent coffee grinds from escaping.

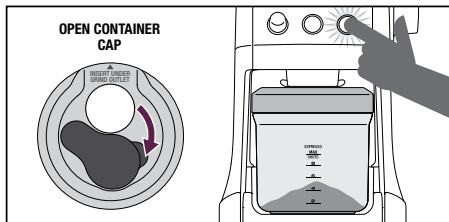

## 3. Grinding into Drip Filter Basket

- Place your drip filter basket under grind outlet.
- Use **AUTOMATIC** or **MANUAL** grinding function to start operation using the **START/CANCEL** button on the control panel.

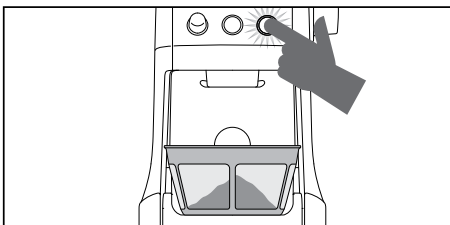

## CUSTOMISING YOUR GRIND AMOUNT

The **ADJUST AMOUNT** function gives you the ability to modify the preset amount to deliver more or less grinds into your portafilter or grind container.

### Increasing the Grind Amount

To increase the grind amount selected, turn the **ADJUST AMOUNT** dial to the right.

Each bar adjustment will increase the grind amount by 5%, up to a maximum of 25% more.

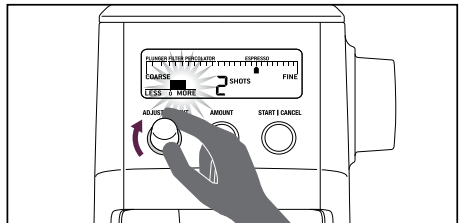

### Decreasing the Grind Amount

To decrease grind amount selected, turn the **ADJUST AMOUNT** dial to the left. Each bar adjustment will decrease the grind amount by 5%, up to a minimum of 25% less.

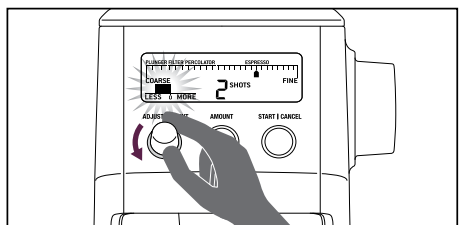

## ENERGY SAVING FEATURE

The grinder will automatically switch off if not used after 5 minutes.

To reactivate the machine whilst in **POWER SAVING/SLEEP MODE**, press any button on the grinder control panel.

# CARE & CLEANING

for your Breville Smart Grinder™



## CARE & CLEANING

1. Unplug power cord from power outlet before cleaning.
2. Wash the grind container and lid, bean hopper and lid in warm soapy water, rinse and dry thoroughly.
3. Wipe and polish exterior of appliance with a soft damp cloth.

### NOTE

Do not use alkaline or abrasive cleaning agents, steel wool or scouring pads, as these can damage the surface.

### NOTE

We recommend you do not clean any grinder parts or accessories in the dishwasher.

## CLEANING CONICAL BURRS

Regular cleaning helps the burrs achieve consistent grinding results which is especially important when grinding for espresso coffee.

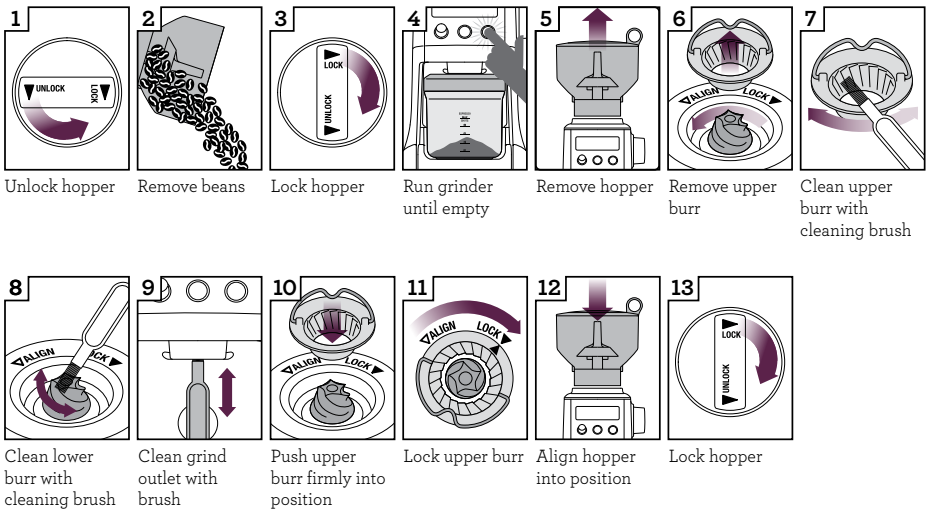

# HINTS & TIPS

### HINTS & TIPS

- Fresh grinds are the key to making coffee with more flavour and body.
- Coffee flavour and strength is a personal preference. Vary the type of coffee beans, amount of coffee and fineness of grind to achieve the flavour you prefer.
- Use freshly roasted coffee beans, preferably with a 'roasted on' date.
- Store coffee beans in a dark, cool and dry place. Vacuum seal if possible.
- Buy in small batches to reduce the storage time and store no more than one week's supply at any time.
- Once coffee is ground it quickly loses its flavour and aroma. For the best results grind beans immediately before brewing.
- Do not store beans in the bean hopper for a prolonged period.
- When storing appliance, run grinder empty to clear of ground beans left in chamber.
- Run grinder for 2 seconds before each use for maximum freshness.
- Clean the bean hopper and conical burrs regularly.

# TROUBLESHOOTING

## TROUBLESHOOTING

PROBLEM	POSSIBLE CAUSE	WHAT TO DO
<b>Grinder does not start after pressing START/CANCEL button</b>	<ul style="list-style-type: none"> <li>Grinder not plugged in!</li> <li>Grinder is overheated.</li> <li>Bean hopper not attached correctly. 'LOCK BEAN HOPPER' will be displayed on LCD screen.</li> </ul>	<ul style="list-style-type: none"> <li>Plug power cord into power outlet.</li> <li>Remove power plug from power outlet. Leave for 20 minutes to cool down before using again.</li> <li>Lock bean hopper into position.</li> </ul>
<b>Motor starts but no ground coffee coming from grind outlet</b>	<ul style="list-style-type: none"> <li>Incorrect button press.</li> <li>No coffee beans in bean hopper!</li> <li>Grinder/bean hopper is blocked.</li> </ul>	<ul style="list-style-type: none"> <li>Press START/CANCEL or PORTAFILTER SWITCH to activate.</li> <li>Fill bean hopper with fresh coffee beans.</li> <li>Remove bean hopper. Inspect bean hopper &amp; grind heads for blockage. Replace parts and try again.</li> </ul>
<b>Motor starts but operates with a loud 'racket' noise</b>	<ul style="list-style-type: none"> <li>Grinder is blocked with foreign item or chute is blocked.</li> <li>Moisture clogging grinder.</li> </ul>	<ul style="list-style-type: none"> <li>Remove bean hopper, inspect burrs &amp; remove any foreign body.</li> <li>Clean burr heads and chute (refer to Care &amp; Cleaning instructions on Page 16).</li> <li>Leave burrs to dry thoroughly before re-assembling. It is possible to use a hair dryer to blow air into grinder inlet (lower burr) to dry.</li> </ul>
<b>Unable to lock bean hopper into position</b>	<ul style="list-style-type: none"> <li>Coffee beans obstructing bean hopper locking device.</li> </ul>	<ul style="list-style-type: none"> <li>Remove bean hopper. Clear coffee beans from top of burrs. Re-lock bean hopper into position and try again.</li> </ul>
<b>Not enough/too much coffee grind</b>	<ul style="list-style-type: none"> <li>Grind amount requires adjustment.</li> </ul>	<ul style="list-style-type: none"> <li>Press AMOUNT button to change grind amount.</li> <li>Use ADJUST AMOUNT dial to fine tune the amount 'More or Less'.</li> </ul>

## TROUBLESHOOTING

PROBLEM	POSSIBLE CAUSE	WHAT TO DO
<b>Portafilter overfills</b>		<ul style="list-style-type: none"><li>• It is normal for the correct amount of coffee to appear overfilled in your portafilter. Untamped coffee is three times the volume of tamped coffee.</li></ul>
<b>Emergency stop?</b>		<ul style="list-style-type: none"><li>• Press START/CANCEL button to stop operation.</li><li>• Unplug power cord from power outlet.</li></ul>



# Breville

## Breville Customer Service Centre

### Australian Customers

**Mail:** PO Box 22  
Botany, NSW, 2019  
AUSTRALIA

**Phone:** 1300 139 798

**Fax:** (02) 9384 9601

**Email:** Customer Service:  
askus@breville.com.au

### New Zealand Customers

**Mail:** Private Bag 94411  
Greenmount, Auckland  
NEW ZEALAND

**Phone:** 0800 273 845

**Fax:** 0800 288 513

**Email:** Customer Service:  
askus@breville.com.au

[www.breville.com.au](http://www.breville.com.au)

Breville is a registered trademark of Breville Pty. Ltd. A.B.N. 98 000 092 928.  
Copyright Breville Pty. Ltd. 2010.

Due to continued product improvement, the products illustrated/photographed  
in this brochure may vary slightly from the actual product.

**BCG800 Issue - A10**



## Free Manuals Download Website

<http://myh66.com>

<http://usermanuals.us>

<http://www.somanuals.com>

<http://www.4manuals.cc>

<http://www.manual-lib.com>

<http://www.404manual.com>

<http://www.luxmanual.com>

<http://aubethermostatmanual.com>

Golf course search by state

<http://golfingnear.com>

Email search by domain

<http://emailbydomain.com>

Auto manuals search

<http://auto.somanuals.com>

TV manuals search

<http://tv.somanuals.com>