

LTC 8569, LTC 8570 Series, LTC 8571, LTC 8572 Series



Security Systems

EN | Instruction Manual
Code Merger Units

BOSCH

Important Safeguards

1. **Read, Follow, and Retain Instructions** - All safety and operating instructions should be read and followed before operating the unit. Retain instructions for future reference.
2. **Heed Warnings** - Adhere to all warnings on the unit and in the operating instructions.
3. **Attachments** - Attachments not recommended by the product manufacturer should not be used, as they may cause hazards.
4. **Installation Cautions** - Do not place this unit on an unstable stand, tripod, bracket, or mount. The unit may fall, causing serious injury to a person and serious damage to the unit. Use only manufacturer-recommended accessories, or those sold with the product. Mount the unit per the manufacturer's instructions. Appliance and cart combination should be moved with care. Quick stops, excessive force, or uneven surfaces may cause the appliance and cart combination to overturn.
5. **Cleaning** - Unplug the unit from the outlet before cleaning. Follow any instructions provided with the unit. Generally, using a damp cloth for cleaning is sufficient. Do not use liquid cleaners or aerosol cleaners.
6. **Servicing** - Do not attempt to service this unit yourself. Opening or removing covers may expose you to dangerous voltage or other hazards. Refer all servicing to qualified service personnel.
7. **Damage Requiring Service** - Unplug the unit from the main AC power source and refer servicing to qualified service personnel under the following conditions:
 - When the power supply cord or plug is damaged.
 - If liquid has been spilled or an object has fallen into the unit.
 - If the unit has been exposed to water and/or inclement weather (rain, snow, etc.).
 - If the unit does not operate normally, when following the operating instructions. Adjust only those controls specified in the operating instructions. Improper adjustment of other controls may result in damage, and require extensive work by a qualified technician to restore the unit to normal operation.
 - If the unit has been dropped or the cabinet damaged.
 - If the unit exhibits a distinct change in performance, this indicates that service is needed.
8. **Replacement Parts** - When replacement parts are required, the service technician should use replacement parts specified by the manufacturer or that have the same characteristics as the original part. Unauthorized substitutions may result in fire, electrical shock or other hazards.
9. **Safety Check** - Upon completion of servicing or repairs to the unit, ask the service technician to perform safety checks to ensure proper operating condition.
10. **Power Sources** - Operate the unit only from the type of power source indicated on the label. If unsure of the type of power supply to use, contact your dealer or local power company.
 - For units intended to operate from battery power, refer to the operating instructions.
 - For units intended to operate **with External Power Supplies**, use only the recommended approved power supplies.
 - For units intended to operate with a limited power source, this power source must comply with EN60950. Substitutions may damage the unit or cause fire or shock.
 - For units intended to operate at 24VAC, normal input voltage is **24 VAC**. Voltage applied to the unit's power input should not exceed 30VAC. User-supplied wiring, from the 24VAC supply to unit, must be in compliance with electrical codes (Class 2 power levels). Do not ground the 24VAC supply at the terminals or at the unit's power supply terminals.
11. **Coax Grounding** - If an outside cable system is connected to the unit, ensure that the cable system is grounded. U.S.A. models only - Section 810 of the National Electrical Code, ANSI/NFPA No.70, provides information regarding proper grounding of the mount and supporting structure, grounding of the coax to a discharge unit, size of grounding conductors, location of discharge unit, connection to grounding electrodes, and requirements for the grounding electrode.
12. **Grounding or Polarization** - This unit may be equipped with a polarized alternating current line plug (a plug with one blade wider than the other). This safety feature allows the plug to fit into the power outlet in only one way. If unable to insert the plug fully into the outlet, try reversing the plug. If the plug still fails to fit, contact an electrician to arrange replacement of the obsolete outlet. Do not defeat the safety purpose of the polarized plug. Alternately, this unit may be equipped with a 3-wire grounding plug (a plug with a third pin, for grounding). This safety feature allows the plug to fit into a grounding power outlet only. If unable to insert the plug into the outlet, contact an electrician to arrange replacement of the obsolete outlet. Do not defeat the safety purpose of the grounding plug.
13. **Lightning** - For added protection during a lightning storm, or when this unit is left unattended and unused for long periods of time, unplug the unit from the wall outlet and disconnect the cable system. This will prevent damage to the unit due to lightning and power line surges.

For Indoor Product

1. **Water and Moisture** - Do not use this unit near water - for example, in a wet basement, in an unprotected outdoor installation or in any area classified as a wet location.
2. **Object and Liquid Entry** - Never push objects of any kind into this unit through openings, as they may touch dangerous voltage points or short out parts that could result in a fire or electrical shock. Never spill liquid of any kind on the unit.
3. **Power Cord and Power Cord Protection** - For units intended to operate with 230VAC, 50Hz, the input and output power cord must comply with the latest versions of IEC Publication 227 or IEC Publication 245.
Power supply cords should be routed so they are not likely to be walked on or pinched. Pay particular attention to location of cords and plugs, convenience receptacles, and the point of exit from the appliance.
4. **Overloading** - Do not overload outlets and extension cords; this can result in a risk of fire or electrical shock.

For Outdoor Product

Power Lines - An outdoor system should not be located in the vicinity of overhead power lines, electric lights or power circuits, or where it may contact such power lines or circuits. When installing an outdoor system, extreme care should be taken to keep from touching power lines or circuits, as this contact might be fatal. U.S.A. models only - refer to the National Electrical Code Article 820 regarding installation of CATV systems.

For Rack-mount Product

1. **Ventilation** - This unit should not be placed in a built-in installation or rack, unless proper ventilation is provided, or the manufacturer's instructions have been adhered to. The equipment must not exceed its maximum operating temperature requirements.
2. **Mechanical Loading** - Mounting of the equipment in a rack shall be such that a hazardous condition is not achieved due to uneven mechanical loading.

Safety Precautions



CAUTION

RISK OF ELECTRIC SHOCK. DO NOT OPEN!



CAUTION: TO REDUCE THE RISK OF ELECTRIC SHOCK, DO NOT REMOVE COVER (OR BACK). NO USER SERVICEABLE PARTS INSIDE. REFER SERVICING TO QUALIFIED SERVICE PERSONNEL.



This symbol indicates the presence of uninsulated "dangerous voltage" within the product's enclosure. This may constitute a risk of electric shock.



The user should consult the operating and maintenance (servicing) instructions in the literature accompanying the appliance.



Attention: Installation should be performed by qualified service personnel only in accordance with the National Electrical Code or applicable local codes.



Power Disconnect. Units with or without ON-OFF switches have power supplied to the unit whenever the power cord is inserted into the power source; however, the unit is operational only when the ON-OFF switch is in the ON position. The power cord is the main power disconnect for all units.

FCC & ICES INFORMATION

(U.S.A. and Canadian Models Only)

This device complies with part 15 of the FCC Rules. Operation is subject to the following two conditions:





- (1) This device may not cause harmful interference, and
- (2) This device must accept any interference received, including interference that may cause undesired operation.

NOTE: This equipment has been tested and found to comply with the limits for a Class B digital device, pursuant to Part 15 of the FCC Rules and ICES-003 of Industry Canada. These limits are designed to provide reasonable protection against harmful interference when the equipment is operated in a residential installation. This equipment generates, uses and can radiate radio frequency energy, and if not installed and used in accordance with the instructions, may cause harmful interference to radio communications. However, there is no guarantee that interference will not occur in a particular installation. If this equipment does cause harmful interference to radio or television reception, which can be determined by turning the equipment off and on, the user is encouraged to try to correct the interference by one or more of the following measures:

- Reorient or relocate the receiving antenna.
- Increase the separation between the equipment and receiver.
- Connect the equipment into an outlet on a circuit different from that to which the receiver is connected.
- Consult the dealer, or an experienced radio/TV technician for help.

Intentional or unintentional changes or modifications, not expressly approved by the party responsible for compliance, shall not be made. Any such changes or modifications could void the user's authority to operate the equipment. The user may find the following booklet, prepared by the Federal Communications Commission, helpful: [How to Identify and Resolve Radio-TV Interference Problems](#). This booklet is available from the U.S. Government Printing Office, Washington, DC 20402, Stock No. 004-000-00345-4.







Sécurité

	ATTENTION RISQUE D'ÉLECTROCUTION. NE PAS OUVRIR!	
ATTENTION : POUR ÉVITER TOUT RISQUE D'ÉLECTROCUTION, N'ESSAYEZ PAS DE RETIRER LE CAPOT (OU LE PANNEAU ARRIÈRE). CET APPAREIL NE CONTIENT AUCUN COMPOSANT SUSCEPTIBLE D'ÊTRE RÉPARÉ PAR L'UTILISATEUR. CONFIEZ LA RÉPARATION DE L'APPAREIL À DU PERSONNEL QUALIFIÉ.		
	Ce symbole signale que le produit renferme une « tension potentiellement dangereuse » non isolée susceptible de provoquer une électrocution.	
	Ce symbole invite l'utilisateur à consulter les instructions d'utilisation et d'entretien (dépannage) reprises dans la documentation qui accompagne l'appareil.	
	Attention : l'installation doit exclusivement être réalisée par du personnel qualifié, conformément au code national d'électricité américain (NEC) ou au code d'électricité local en vigueur.	
	Coupure de l'alimentation. Qu'ils soient pourvus ou non d'un commutateur ON/OFF, tous les appareils reçoivent de l'énergie une fois le cordon branché sur la source d'alimentation. Toutefois, l'appareil ne fonctionne réellement que lorsque le commutateur est réglé sur ON. Le débranchement du cordon d'alimentation permet de couper l'alimentation des appareils.	

Sicherheitshinweise

	VORSICHT ELEKTRISCHE SPANNUNG. NICHT ÖFFNEN!	
VORSICHT: UM EINEN ELEKTRISCHEN SCHLAG ZU VERMEIDEN, IST DIE ABDECKUNG (ODER RÜCKSEITE) NICHT ZU ENTFERNEN. ES BEFINDEN SICH KEINE TEILE IN DIESEM BEREICH, DIE VOM BENUTZER GEWARTET WERDEN KÖNNEN. LASSEN SIE WARTUNGSARBEITEN NUR VON QUALIFIZIERTEM WARTUNGSPERSONAL AUSFÜHREN.		
	Das Symbol macht auf nicht isolierte „gefährliche Spannung“ im Gehäuse aufmerksam. Dies kann zu einem elektrischen Schlag führen.	
	Der Benutzer sollte sich ausführlich über Anweisungen für die Bedienung und Instandhaltung (Wartung) in den begleitenden Unterlagen informieren.	
	Achtung! Die Installation sollte nur von qualifiziertem Kundendienstpersonal gemäß jeweils zutreffender Elektrovorschriften ausgeführt werden.	
	Unterbrechung des Netzanschlusses. Geräte mit oder ohne Netzschalter haben Spannung am Gerät anliegen, sobald der Netzstecker in die Steckdose gesteckt wird. Das Gerät ist jedoch nur betriebsbereit, wenn der Netzschalter (EIN/AUS) auf EIN steht. Wenn das Netzkabel aus der Steckdose gezogen wird, ist die Spannungszuführung zum Gerät vollkommen unterbrochen.	

Precauciones de Seguridad

	ATTENZIONE PERICOLO DI SCOSSA ELETTRICA. NON APRIRE.	
PRECAUCIÓN: PARA DISMINUIR EL RIESGO DE DESCARGA ELÉCTRICA, NO RETIRE LA CUBIERTA (NI LA PARTE POSTERIOR). NO EXISTEN PIEZAS DE RECAMBIO EN EL INTERIOR DEL EQUIPO. EL PERSONAL DE SERVICIO CUALIFICADO SE ENCARGA DE REALIZAR LAS REPARACIONES.		
	Este símbolo indica que existen puntos de tensión peligrosos sin aislamiento dentro de la cubierta de la unidad. Estos puntos pueden constituir un riesgo de descarga eléctrica.	
	El usuario debe consultar las instrucciones de funcionamiento y mantenimiento (reparación) en la documentación que se suministra con el aparato.	
	Atención: la instalación la debe realizar únicamente personal cualificado de conformidad con el National Electric Code o las normas aplicables en su país.	
	Desconexión de la alimentación. Las unidades con o sin interruptores de encendido/apagado reciben alimentación eléctrica siempre que el cable de alimentación esté conectado a la fuente de alimentación. Sin embargo, la unidad sólo funciona cuando el interruptor está en la posición de encendido. El cable de alimentación es la principal fuente de desconexión de todas las unidades.	

Veiligheidsmaatregelen

	VOORZICHTIG GEVAARVOOR ELEKTRISCHE SCHOK. NIET OPENEN!	
<p>VOORZICHTIG: OPEN DE BEHUIZING OF DE ACHTERKANT VAN HET APPARAAT NIET. ZO VERMINDERT U HET RISICO OP ELEKTRISCHE SCHOKKEN. IN HET APPARAAT BEVINDEN ZICH GEEN ONDERDELEN DIE U ZELF KUNT REPAREREN. LAAT SERVICE EN ONDERHOUD UITVOEREN DOOR GEKwalificeerd personeel.</p>		



	Dit symbool geeft aan dat er binnen in het apparaat ongeïsoleerde, gevaarlijke spanning aanwezig is die mogelijk elektrische schokken kan veroorzaken.
---	--

	De gebruiker dient de bedienings- en onderhoudsvoorschriften te raadplegen in de documentatie die werd meegeleverd met het apparaat.
---	--

	Attentie: het apparaat mag alleen door gekwalificeerd personeel worden geïnstalleerd. De installatie dient in overeenstemming met de nationale elektrische richtlijnen of de van toepassing zijnde lokale richtlijnen te worden uitgevoerd.
---	---

	Spanning uitschakelen. Apparatuur met of zonder aan-uitschakelaar staat onder spanning zolang de stekker is aangesloten op de wandcontactdoos. De apparatuur is uitsluitend in werking als de aan-uitschakelaar aan staat. Het netsnoer is de "hoofdschakelaar" voor alle apparatuur.
---	---

Sicurezza

	ATTENZIONE PERICOLO DI SCOSSA ELETTRICA. NON APRIRE.	
<p>ATTENZIONE: PER RIDURRE IL RISCHIO DI SCOSSE ELETTRICHE NON RIMUOVERE LA COPERTURA (O IL PANNELLO POSTERIORE). L'UNITÀ NON CONTIENE COMPONENTI INTERNI RIPARABILI DALL'UTENTE. PER QUALSIASI INTERVENTO, RIVOLGERSI A PERSONALE TECNICO QUALIFICATO.</p>		



	Questo simbolo indica la presenza di "tensione pericolosa" non isolata all'interno del contenitore del prodotto. Ciò comporta un potenziale rischio di scosse elettriche.
---	---

	Si consiglia di consultare le istruzioni operative e di manutenzione (interventi tecnici) contenute nella documentazione fornita con il dispositivo.
---	--

	Attentive: l'installazione deve essere effettuata esclusivamente da personale tecnico qualificato in conformità con il National Electrical Code o con le normative locali vigenti.
---	--

	Scollamento dell'alimentazione. Le unità dotate o sprovviste di interruttori ON-OFF vengono alimentate quando si inserisce il cavo nella presa dell'alimentazione. L'unità è tuttavia in funzione solo quando l'interruttore ON-OFF si trova nella posizione ON. Il cavo di alimentazione costituisce il dispositivo di scollegamento dell'alimentazione principale per tutte le unità.
---	---

Medidas de Segurança

	UWAGA NIEBEZPIECZEŃSTWO PORAŻENIA PRĄDEM ELEKTRYCZNYM NIE OTWIERAĆ!	
<p>CUIDADO: PARA REDUZIR O RISCO DE CHOQUE ELÉCTRICO, NÃO RETIRE A TAMPA (OU A PARTE POSTERIOR). NO INTERIOR, NÃO EXISTEM PEÇAS QUE POSSAM SER REPARADAS PELO UTILIZADOR. REMETA A ASSISTÊNCIA PARA OS TÉCNICOS QUALIFICADOS.</p>		

	Este símbolo indica a presença de "tensão perigosa" não isolada dentro da estrutura do produto, o que pode constituir risco de choque eléctrico.
---	--

	O utilizador deve consultar as instruções de funcionamento e manutenção (assistência) nos documentos que acompanham o aparelho.
---	---

	Atenção: a instalação deve ser executada apenas por técnicos qualificados da assistência, de acordo com o código eléctrico nacional ou os códigos locais aplicáveis.
---	--

	Corte de corrente. As unidades com ou sem interruptores ON-OFF (ligar/desligar) recebem corrente sempre que o fio de alimentação está introduzido na fonte de alimentação; contudo, a unidade apenas está operacional quando o interruptor ON-OFF está na posição ON. O fio de alimentação destina-se a desligar a corrente em todas as unidades.
---	---

Zasady Bezpieczeństwa

	CUIDADO RISCO DE CHOQUE ELÉCTRICO. NÃO ABRIR!	
<p>PRZESTROGA: ABY ZMNIEJSZYĆ RYZYKO PORAŻENIA ELEKTRYCZNEGO, NIE NALEŻY ZDEJMOWAĆ POKRYWY GÓRNEJ (ani tyłnej). WEWNĄTRZ URZĄDZENIA NIE MA ŻADNYCH ELEMENTÓW, KTÓRE MOGĄ BYĆ NAPRAWIANE SAMODZIELNIE PRZEZ UŻYTKOWNIKA. SERWIS NALEŻY ZLECAĆ WYKwalifikowanym pracownikom obsługi.</p>		

	Ten symbol wskazuje na obecność nieizolowanego „niebezpiecznego napięcia” we wnętrzu urządzenia. Napięcie to grozi porażeniem elektrycznym.
---	---

	Użytkownik powinien zapoznać się z instrukcjami obsługi i konserwacji (serwisu), zamieszczonymi w dokumentacji towarzyszącej urządzeniu.
---	--

	Uwaga: Instalacja może być wykonywana wyłącznie przez wykwalifikowanych pracowników obsługi, zgodnie z zasadami kodeksu National Electrical Code lub innych obowiązujących norm.
---	--

	Odłączanie zasilania. Niezależnie od wyposażenia w wyłącznik zasilania, prąd do urządzenia jest doprowadzany zawsze, gdy przewód zasilania jest podłączony do źródła zasilania; jednak urządzenie działa tylko wtedy, gdy wyłącznik zasilania jest włączony. Przewód zasilania jest głównym wyłącznikiem zasilania we wszystkich urządzeniach.
---	--

Table of Contents

Important Safeguards	2
Safety Precautions	3
FCC Information	4
1 UNPACKING	7
2 SERVICE	7
3 DESCRIPTION	7
4 POWER SPECIFICATIONS	8
5 INSTALLATION	9
5.1 General	9
5.2 Camera Address Offset Feature	9
6 OPERATION	10
7 CONFIGURATION EXAMPLE	11
8 PINOUTS	13
9 TROUBLESHOOTING	13

1 UNPACKING

Unpack and handle this electronic equipment carefully. Ensure that the following items are included:

LTC 8569:

- Two (2) cables with 9-pin D-sub connectors
- Connector Kit, containing eight (8) pieces of a twelve (12) pin connector
- Installation manual

LTC 8570:

- Four (4) cables with 9-pin D-sub connectors
- Connector Kit, containing eight (8) pieces of a twelve (12) pin connector
- Installation manual

LTC 8571:

- Two (2) cables with 9-pin D-sub connectors
- Connector Kit, containing sixteen (16) pieces of a twelve (12) pin connector
- Installation manual

LTC 8572:

- Four (4) cables with 9-pin D-sub connectors
- Connector Kit, containing sixteen (16) pieces of a twelve (12) pin connector
- Installation manual

If an item appears to have been damaged in shipment, replace it properly in its carton and notify the shipper. If any items are missing, notify your Bosch Security Systems, Inc. Sales Representative or Customer Service. The shipping carton is the safest container in which the unit may be transported. Save it for possible future use.

2 SERVICE

If the unit ever needs repair service, the customer should contact the nearest Bosch Security Systems, Inc. Service Center for return authorization and shipping instructions.

Service Centers

USA

Phone: 800-366-2283 or 717-735-6638

fax: 800-366-1329 or 717-735-6639

CCTV Spare Parts

Phone: 800-894-5215 or 408-956-3853 or 3854

fax: 408-957-3198

e-mail: BoschCCTVparts@ca.slr.com

Canada

Phone: 514-738-2434

Europe, Middle East & Asia Pacific Region

Phone: 32-1-440-0711

For additional information, see www.boschsecuritysystems.com.

3 DESCRIPTION

The LTC 8569, LTC 8570, LTC 8571, and LTC 8572 Series are control code merger and line driver units used to combine biphasic control code from multiple systems. Models are available having either 2 or 4 inputs, and 32 or 64 outputs. The table below summarizes the models available:

Inputs	Code Outputs	
	32	64
2	LTC 8569	LTC 8571
4	LTC 8570	LTC 8572

These units will accept signal inputs from any device capable of generating biphasic control code. This includes the following:

- Allegiant® main CPU bays
- LTC 8568/00 Signal Distribution units
- An output from another Code Merger unit
- Digital Recorders, such as Divar™ Series, DESA™ Series, & System4 Server Series
- Code Converters or Code Translators
- LTC 5136 AutoDome® Controllers
- System4 Series Multiplexers
- LTC 8780, LTC 8784, and LTC 8786 Series Data Converter units

Two 2-meter (6 ft) data cables, for interface to Allegiant main CPU bays, are supplied with the 2-channel versions; four cables are supplied with the 4-channel versions. These units can provide data to any device capable of accepting biphas control code, including the following:

- Allegiant Satellite systems
- AutoDome Series cameras
- Conventional Allegiant Receiver/Driver Series
- Allegiant LTC 8770 Relay Follower Series

Control code wiring to the remote devices can be connected to the outputs of the code mergers using either star or daisy chain wiring configurations. Each output is capable of driving up to eight (8) remote devices using a daisy chain wiring configuration. Multiple units may be cascaded to obtain additional biphas code outputs.

The Code Merger units also provide an address offset functionality. This feature is convenient when it is necessary to convert camera address numbers, encoded within the biphas data, to a higher value. Offset increments of 16, 32, or 48 can be enabled via an internal dip switch selection.

4 POWER SPECIFICATIONS

Model No.	Rated Voltage	Voltage Range	Power ¹
LTC 8569/60	120 VAC, 50/60 Hz	108 to 132	12 W
LTC 8570/60	120 VAC, 50/60 Hz	108 to 132	12 W
LTC 8569/50	220-240 VAC, 50/60 Hz	198 to 264	12 W
LTC 8570/50	220-240 VAC, 50/60 Hz	198 to 264	12 W
LTC 8571/60	120 VAC, 50/60 Hz	108 to 132	12 W
LTC 8572/60	120 VAC, 50/60 Hz	108 to 132	12 W
LTC 8571/50	220-240 VAC, 50/60 Hz	198 to 264	12 W
LTC 8572/50	220-240 VAC, 50/60 Hz	198 to 264	12 W

¹Nominal power at rated voltage.

5 INSTALLATION

5.1 General

Code Merger units are supplied in an indoor rated enclosure designed to fit a standard EIA 19" rack. Install the unit in the rack using appropriate mounting hardware (not supplied).

Input connections to a Code Merger are made to any of its 9-pin D-type connectors. The pinouts of the supplied 2-meter (6 feet) data cables can be connected directly to the control code output connector of an Allegiant Series Matrix Switcher system. Remember to tighten all connector attachment screws at each connection point.

If the control code sources are beyond the length of the cable, or are not Allegiant systems, the data cables must be adapted as necessary, for connection to the control device. If desired, a user-supplied 9-pin D-type connector may be used for interfacing to the Code Mergers. Pinouts for the 9-pin connectors are described within this manual.

Connect shielded twisted pair cable (Belden 8760 or equivalent) between the camera site receiver/driver locations, and any of the 32/64 outputs provided on the rear panel of the Code Merger unit. The same data is generated from all outputs, thus it is irrelevant which one is used.

Eight (8) pairs of removable screw terminal blocks are provided, each having four (4) connection groups per block. Typically, a single camera site receiver/driver or AutoDome is connected to each output, but the biphasic output of these units is rated to handle up to eight (8) devices, when connected in a daisy chain configuration, to a maximum of 1.5 km (5000 ft).

In a daisy chain connection, the cable is looped through each AutoDome camera or receiver/driver along the way. Only the last unit in the daisy chain connection must be terminated. The remaining receiver/drivers must have the terminating resistor removed when the looping cable is connected.

Select and maintain a wire color convention to avoid confusion at the various camera sites.

Example: White to "+", Black to "-", and Shield to "S".

Follow the standard installation instructions, provided with the AutoDome Camera or Allegiant Series Receiver/Driver unit, for setting device address and connecting the data cable to the unit.

Connect the AC power cord to an appropriate power source. The green Power LED on the code merger unit front panel should illuminate when power is applied.

5.2 Camera Address Offset Feature

(effective May 2003, Date Code 0314)

Code Merger units contain an optional feature that can be used to offset the camera addresses for data being received by code merger inputs 2, 3, and 4. Input 2 can be set to offset addresses by 16, input 3 by an offset of 32, and/or input 4 by an offset of 48. This feature allows code mergers to be used in multi-device systems where some of the control devices do not support offset camera addresses of the data being generated. Refer to sample configuration diagrams for additional details.

The cover of the Code Merger must be removed to access the dip switch used for configuration of options. Follow the instructions below to set the camera address offset.

WARNING:

- Removal of the cover should only be performed by qualified service personnel.

The unit should always be disconnected from the mains power source before removing the cover, and remain disconnected while the cover is removed.

- Electrostatic-sensitive device. Use proper ESD safety precautions to avoid electrostatic discharge to sensitive electronic components.
- The top cover is fastened to the case by four (4) screws located on the rear of the unit. Remove these screws as shown in Figure 1.
- After the screws have been removed, the cover slides back and off the unit.

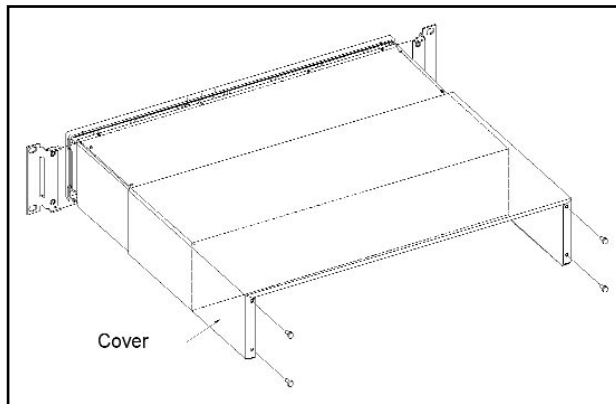

Figure 1 - Cover and Rack Brackets Removal

- Locate dip switch # S101, as shown in Figure 2.

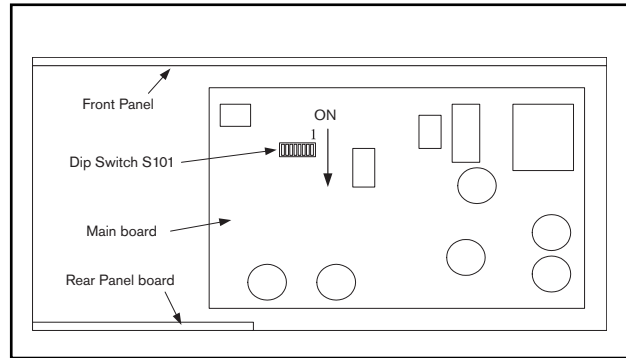

Figure 2 - Dip Switch Location

- Make the desired changes per the table below:

S101 Dip Switch	Switch OFF	Switch ON
2	No change 2 offset by 16	Data received by Input 2 offset by 16
3	No change 3 offset by 32	Data received by Input 3 offset by 32
4	No change 4 offset by 48	Data received by Input 4 offset by 48

- All other switches should be left in the OFF position.
- Reverse the procedure to reinstall the cover.

6 OPERATION

When AC power is applied to the Code Merger, the front panel POWER LED illuminates. When biphasic code is received at any of its inputs, the signal is reconstituted and distributed from all of its outputs. The CODE LED on the front panel will flash as output data is being produced.

7 CONFIGURATION EXAMPLES

Refer to Figures 3 – 6 for various connection option guidelines.

- The control code outputs from multiple Allegiant Series Switchers are combined so that each system can control any of the common cameras. If the switcher is close enough, the supplied data interface cable may be used directly. If a switcher is beyond the distance of the supplied cable, the cable can be spliced to a user-supplied shielded twisted pair that is connected to the Signal Distribution outputs of the remote switcher.

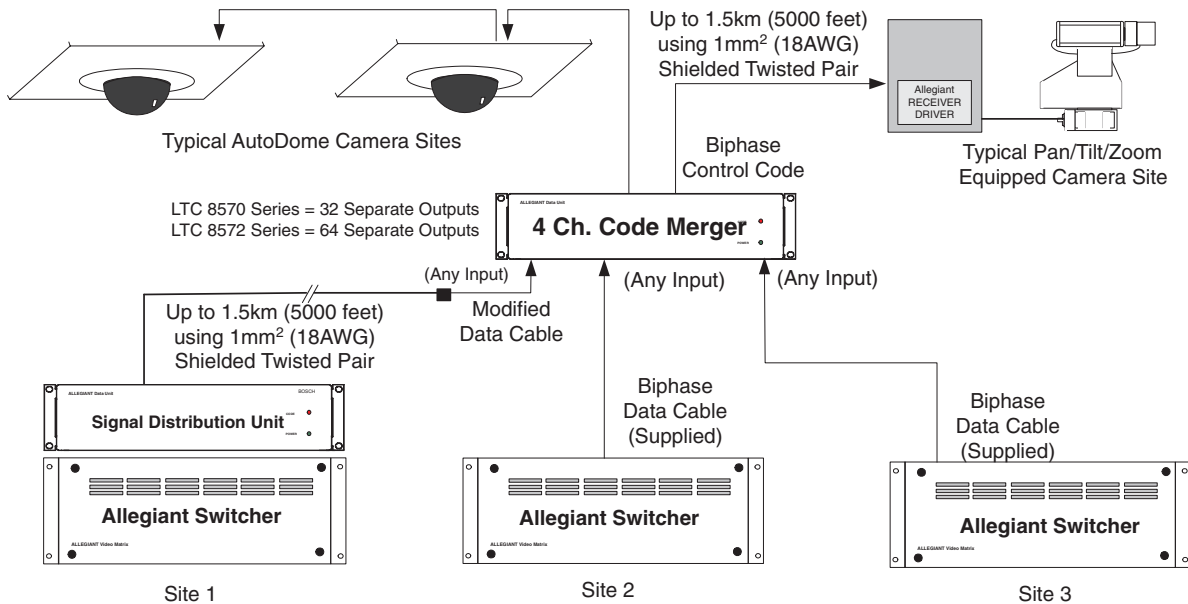

Figure 3 - Code Merger Unit With Multiple Allegiant Series Systems

- A Code Merger can combine control data generated by any device generating biphase control code. This allows each control device to operate any of the system's cameras.

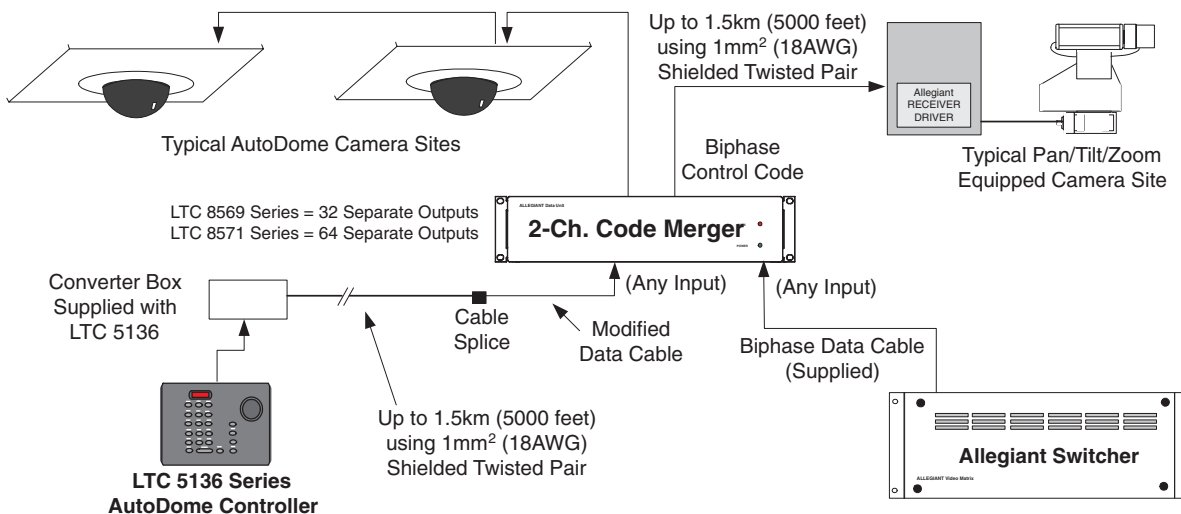

Figure 4 - AutoDome Controller Combined with Allegiant Series System

3. A Code Merger can combine control data generated by multiple devices, each having a different or overlapping range of control code camera addresses. In this example, one Divar controls only system cameras 1 to 16. The other Divar controls only system cameras 17 to 32 (as configured per the Divar instruction manual), but the Allegiant is able to control all cameras.

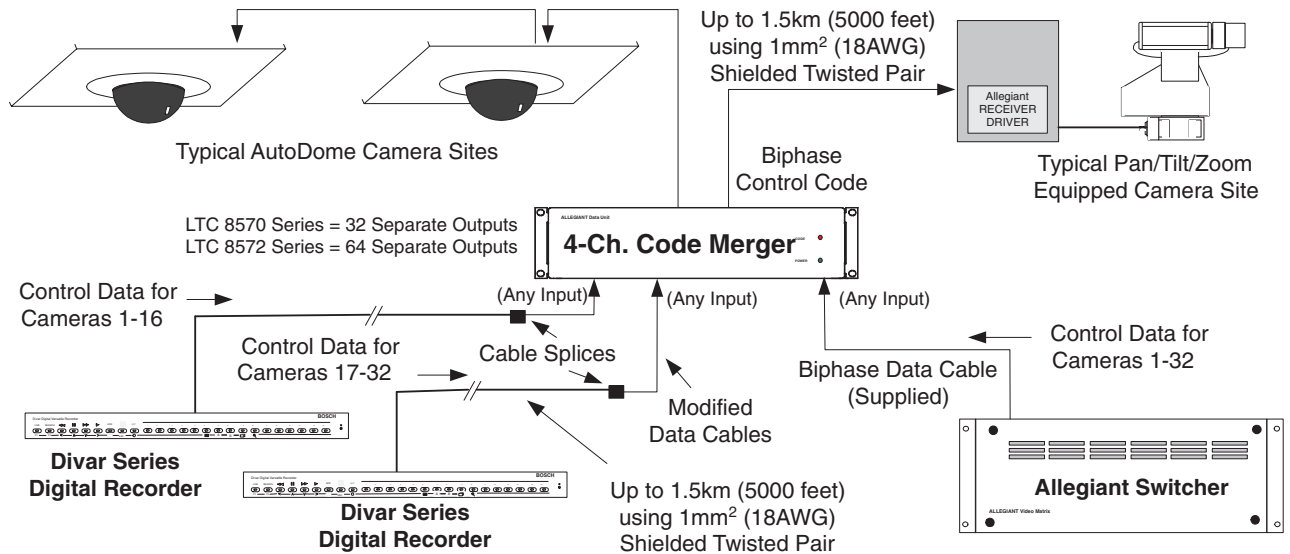

Figure 5 - Allegiant Combined with Divar Series Digital Recorders

4. The 32 channel System4 Server Series of digital recorders uses two (2) separate multiplexer units for camera video connections. Each unit has its own biphase control code output that can only generate data for camera addresses 1 to 16. Thus it is necessary to offset the control code being generated by the second multiplexer for system cameras 17 to 32, so that their addresses match those being sent by the Allegiant. This is easily done by configuring input 2 of the Code Merger to operate in the "address offset" mode.

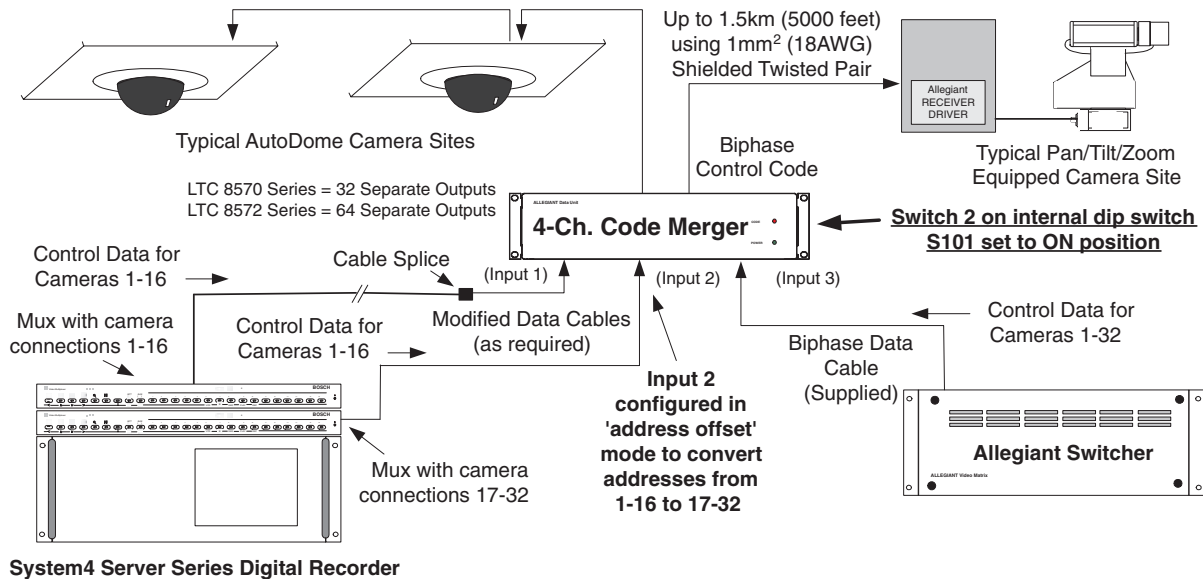
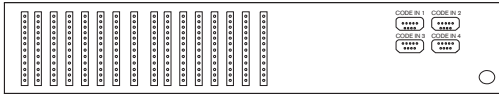

Figure 6 - Allegiant Combined with System4 Server Using Address Offset

8 Pinouts



LTC 8569 Series: 8 12-Pin Connectors LTC 8569/60 Series and LTC 8571/60 Series: 2 D-Connect
 LTC 8571 Series: 16 12-Pin Connectors LTC 8570/60 Series and LTC 8572/60 Series: 4 D-Connect



Figure 7 - Code Merger Connectors

12-Pin Output Data Connectors

Pin ¹	Connection	Pin	Connection
1 +	Data +	7 +	Data +
2 S	Shield	8 S	Shield
3 -	Data -	9 -	Data -
4 +	Data +	10 +	Data +
5 S	Shield	11 S	Shield
6 -	Data -	12 -	Data -

1. Pins are not numbered; numbers represent pin sequence from top to bottom.

9-Pin Data Input Connectors

Pin	Connection
1	+ Code
2	-- Code
3	Shield
4	No Connection
5	No Connection
6	No Connection
7	No Connection
8	No Connection
9	No Connection

Supplied 9-Pin Data Cables

(Replacement part number 303 0753 005)

Male side Color	Connection	Female side	Typical Wire (actual color)
1	+ Code	1	Brown
2	- Code	2	Red
3	Shield	3	Orange
4	Gnd	4	Yellow
5	Gnd	5	Green
6	No Connection	—	—
7	No Connection	—	—
8	12VAC	8	White
9	12VAC	9	Black

9 TROUBLESHOOTING

Problem	Solution
Front panel POWER LED is not lit.	Check AC power connections.
No front panel CODE LED action when data is being received.	Check data input polarity connections at both the Code Merger input and controller device output.
No apparent control code being generated at one output.	Swap output connections to another output. Note: All outputs generate the same data.

Bosch Security Systems, Inc.
850 Greenfield Road
Lancaster, PA 17601 USA
Tel: 800-326-3270
Fax: 1-717-735-6560
www.boschsecuritysystems.com

Bosch Security Systems B.V.
P.O. Box 80002
5600 JB Eindhoven
The Netherlands
Tele +31 40 27 80000

Bosch Security Systems Pte Ltd.
38C Jalan Pemimpin
Singapore 577180
Republic of Singapore
Tel: 65 (6) 319 3486

© 2004 Bosch Security Systems GmbH
3935 890 04213 04-12 | Updated March 15, 2004 | Data subject to change without notice.

BOSCH

Free Manuals Download Website

<http://myh66.com>

<http://usermanuals.us>

<http://www.somanuals.com>

<http://www.4manuals.cc>

<http://www.manual-lib.com>

<http://www.404manual.com>

<http://www.luxmanual.com>

<http://aubethermostatmanual.com>

Golf course search by state

<http://golfingnear.com>

Email search by domain

<http://emailbydomain.com>

Auto manuals search

<http://auto.somanuals.com>

TV manuals search

<http://tv.somanuals.com>