

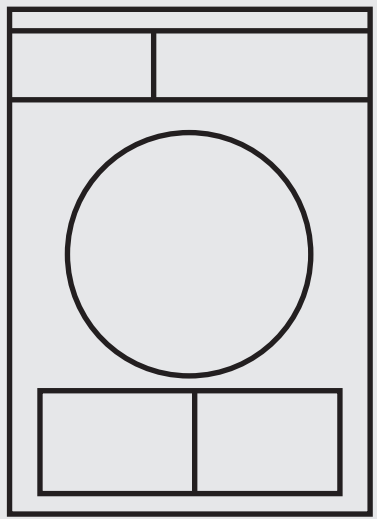

Dryer
V20-UL



en Operating, Care and
Installation Instructions



Household Appliances

Table of Contents

Definitions	3
IMPORTANT SAFETY INSTRUCTIONS	4
GROUNDING INSTRUCTIONS	5
INSTALLATION INSTRUCTIONS	6
Introduction	6
Information concerning waste disposal	6
Before installing the dryer	6
Installation location	7
Washer-dryer connecting set	7
Built under Installation	7
Electrical connection	8
Integrated socket	8
Exhaust air connection	8
Installation – step by step	10
Check list before using the dryer	10
Preparing to transport the dryer	10
OPERATING INSTRUCTIONS	11
Your new dryer	11
Panel	12
Safety information	13
Intended Use	13
Before switching on the dryer	13
Using the dryer	13
Protecting the dryer	13
Before using the dryer for the first time	13
Temporary disconnection of the dryer	13
Laundry	14
Identification of fabrics	14
Drying tips	14
Protection of the environment	14
Program selection	15
Automatic programs	15
Time programs	15
Option	15
Indicator of program sequence	15
Operation	16
Using the dryer	16
Cleaning and care	17
Cleaning the dryer	17
Cleaning the lint filter	17
Cleaning the exhaust duct	18
Cleaning the moisture sensor	18
Cleaning the bearing shield	18
Troubleshooting	19
SERVICE and REPAIR	20
STATEMENT OF WARRANTIES BOSCH CLOTHES DRYERS	21
Exclusions	21
Program selection table	22
Summary of instructions	23

Congratulations on having selected a Bosch clothes dryer, the choice of those that demand exceptional performance from their clothes dryer.

This dryer complies with UL 2158 Electric Clothes Dryers.

A distinctive feature of your dryer is low energy consumption.

An easy operation philosophy, a variety of customized drying programs and a solid touch and feel make this appliance a user-friendly assistant in your household.

The Bosch dryer offers the following standard features:

- High efficiency precision drying system.
- Exceptionally quiet operation.
- Sensor controlled auto cycles.
- Timed cycles for 20 and 40 minutes.

Each dryer which leaves our factory has undergone a thorough performance test and is in full working condition. If you have any questions especially concerning installation of the dryer – our customer service team will be happy to advise you.

Further information and a selection of our products can be found on our web site:
www.boschappliances.com

Information

Please read and follow these operating and installation instructions and all other information enclosed with the dryer.

Definitions

WARNING

WARNING – This indicates that death or serious injuries may occur as a result of not observing this warning.

CAUTION

CAUTION– This indicates that injuries or significant damage may occur as a result of not observing this warning.

CAUTION

CAUTION – This indicates that minor injuries or damage may occur as a result of not observing this warning.

 This symbol is used to draw the user's attention to something in particular.

IMPORTANT SAFETY INSTRUCTIONS

WARNING

To reduce the risk of fire, electric shock, serious injury or death to persons and /or damage when using your dryer, follow basic precautions, including the following.

1. Read all instructions before using the dryer. Bosch dryers are provided with Operating, Care and Installation Instructions.
2. Do not dry articles that have been previously cleaned, washed, soaked, or spotted with gasoline, dry cleaning solvents, other flammable, or explosive substances as they give off vapors that could ignite or explode.
3. Do not allow children to play on or with the appliance. Close supervision of children is necessary when the appliance is used near children.
4. When children become old enough to operate the appliance, it is the legal responsibility of the parents or legal guardians to ensure that they are instructed in safe.
5. Before the appliance is removed from service or discarded, remove the door to the drying compartment.
6. Do not reach into the appliance if the drum is rotating.
7. Do not install or store this appliance where it will be exposed to the weather.
8. Do not tamper with the controls.
9. Do not repair or replace any part of the appliance or attempt any service unless specifically recommended in the user-maintenance instructions or in published user repair instructions that you understand and have the skills to carry out.
10. Do not use fabric softeners or products to eliminate static unless recommended by the fabric manufacturer.
11. Do not use heat to dry articles containing foam rubber (may be labeled latex foam) or similarly textured rubber-like materials. Foam rubber materials can ignite by spontaneous combustion.
12. Keep area around the exhaust opening and adjacent surrounding areas free from the accumulation of lint, dust and dirt. An obstructed port might reduce the airflow.
13. Clean lint screen before or after each load.
14. The interior of the machine should be cleaned periodically by qualified service personnel.
15. Always be sure to unplug the dryer from the electrical supply before attempting any service. Disconnect the power cord by grasping the plug, not the cord.
16. Store all laundry chemicals and aids in a cool dry place according to the manufacturer's instructions in an area where children cannot reach them.
17. To reduce the risk of fire, clothes, cleaning rags, mop heads and the like which have traces of any flammable substance, such as vegetable oil, cooking oil, petroleum based oils or distillates, waxes, fats, etc., must not be placed in the dryer. These items may contain some flammable substance(s) even after washing, which may smoke or catch fire by itself.
18. Do not place items exposed to cooking oils in your dryer. Items contaminated with cooking oils may contribute to a chemical reaction that could cause a load to catch fire.
19. Do not sit on top of the dryer.
20. To reduce the risk of fire or electrical shock, DO NOT use an extension cord or an adapter to connect the dryer to the electrical power supply.
21. The dryer must only be used for its intended purpose.
22. Use the integrated socket only for listed appliances.
23. Always check pockets and remove any objects. Cigarette lighters are particularly hazardous.
24. Replace worn out power cords and/or loose plugs.
25. Do not operate the dryer if any guards and/or panels have been removed.
26. Do not operate the dryer if any parts are missing or broken.
27. Do not bypass any safety devices.
28. Do not use a plastic or non-metal flexible duct with this dryer. Plastic or non-metal flexible duct are a potential fire hazard.

29. Do not operate this dryer until you are sure that the dryer has been installed according to the INSTALLATION INSTRUCTIONS and that installation and grounding are in compliance with all local regulations and/or other applicable regulations and requirements.
30. Failure to install, maintain and/or operate the dryer according to the manufacturer's instructions may result in injury and/or damage.
31. To avoid floor damage and mold growth, do not let spills or splashout cause standing water around or under the appliance.

Notes:

- A The IMPORTANT SAFEGUARDS and WARNINGS presented in this manual do not cover all possible conditions that may occur. Common sense, caution and care must be exercised when installing, maintaining or operating the dryer.
- B Always contact your dealer, distributor, service agent or the manufacturer about any problems or conditions that you do not understand.
- C Follow also the Safety Information in the INSTALLATION INSTRUCTIONS and the OPERATING INSTRUCTIONS.

GROUNDING INSTRUCTIONS

This appliance must be grounded. In the event of malfunction or breakdown, grounding will reduce the risk of electric shock by providing a path of least resistance for the electric current.

This appliance is equipped with a cord having an equipment-grounding conductor and a grounding plug. The plug must be plugged into an appropriate outlet that is properly installed and grounded in accordance with all local codes and ordinances.

CAUTION

Improper connection of the equipment grounding conductor can result in a risk of electric shock.

Check with a qualified electrician or service person if you are in doubt as to whether the dryer is properly grounded.

DO NOT modify the plug provided with the appliance. If it does not fit the outlet, have a proper outlet installed by a qualified electrician.

KEEP THESE INSTRUCTIONS FOR FUTURE REFERENCE.

In case of change of ownership, manual should be conveyed with the dryer.

SAVE THESE INSTRUCTIONS

INSTALLATION INSTRUCTIONS

Introduction

Read these installation instructions completely and carefully. They will save you time and effort and help to ensure optimum dryer performance. Be sure to observe all listed warnings and cautions.

These installation instructions are intended for use by qualified installers. In addition to these instructions the dryer must be installed in accordance with all local codes or, in the absence of a local code:

- In the **U.S.A.**, in accordance with the National Electric Code, ANSI/NFPA70 – latest edition/State and Municipal codes and/or local codes.
- In **Canada**, in accordance with the Canadian Electric Code C22.1 – latest edition/Provincial and Municipal codes and/or local codes.

Information concerning waste disposal

Disposal of the packaging

WARNING

Keep children away from shipping carton and packaging components. Danger of suffocation from plastic foil and folding cartons.

All packaging materials are environmentally friendly and can be reused. Please dispose of packaging in an environmentally friendly manner.

Please ask your dealer or inquire at your local authority about the current means of disposal.

Disposal of the old appliance

WARNING

If appliance is no longer usable, pull out main plug, cut off power cord and discard with main plug.

To prevent children from locking themselves in the appliance, remove the door.

Old appliances are not worthless rubbish! Valuable raw materials can be reclaimed from environmentally friendly recycling.

Please ask your dealer or inquire at your local authority about the current means of disposal.

Before installing the dryer

Unpacking the appliance

CAUTION

The dryer is very heavy. Do not lift it by yourself. Do not lift the appliance by projecting components (e.g. door) – due to risk of breakage.

CAUTION

Remove the appliance packaging carefully to prevent damage to the surfaces.

Check the dryer for transportation damage. Do not connect a dryer which is visibly damaged. If in doubt, contact your dealer.

Supplied components

The dryer is delivered as a complete unit. The operating instructions and supplied accessories can be found in the drum.

CAUTION

After removing the packaging, immediately remove any objects from the drum.

Installation location

⚠ CAUTION ⚠

Do not install the dryer:

- outdoors,
- in an environment with dripping water,
- near flammable materials,
- in rooms which are at risk of frost,
- in rooms which may contain gas or other fuels,
- in cupboards with lockable doors or in closets.

It is not allowed to install the dryer in a small room with door.

The installation room must be well ventilated, otherwise the dryer will operate below optimum performance.

Do not operate the dryer at temperatures above 104°F (40°C) and below 41°F (5°C). Low temperatures affect the automatic program sequence and may prolong the drying times.

The installation surface for the dryer must be clean, level and firm. Do not install the appliance on carpets! Compensate for uneven floors with the height-adjustable feet.

Install the dryer and level side to side and front to back. Use a bubble level. Never remove the height-adjustable feet!

The size of the installation area depends on the dimensions of the dryer. Ensure that there is adequate room for the swivel range of the door!

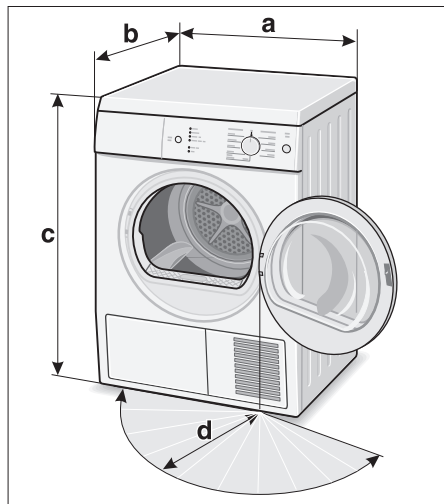

	Dimension	Weight
a	23.6" (600 mm)	85.8 lbs (39 kg)
b	23.0...24.2" (585...615 mm)	with packaging
c	33.1... 34.2" (840...868 mm)	90.2 lbs (41 kg)
d	17.7" (450 mm)/ angle	170-180°

Washer-dryer connecting set

The dryer can be placed on top of a Bosch washer of the same dimensions to save space.

Use the special washer-dryer sets which can be obtained from customer service or your local dealer.

- **WTZ11310**
washer-dryer connection set (standard)
- **WTZ11300**
washer-dryer connection set with removable worktop

⚠ CAUTION ⚠

For reasons of safety, the dryer must be installed by an expert. Always use the connection set to secure the dryer to the washer – risk of injury.

Built under Installation

The appliance can be built under; that is, you can install the dryer under-counter in a kitchen cabinet opening. The cabinet opening should be square and have dimensions as shown in the figure.

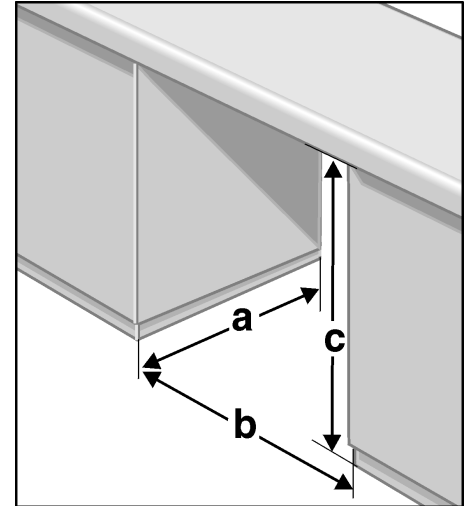

- a** 600 mm minimum // 23 5/8" (additionally approx. 150 mm // 5.9" for exhaust air connection - rear)
- b** 600 mm minimum // 23 5/8" (additionally approx. 150 mm // 5.9" for exhaust air connection - left-hand side)
- c** 850 mm minimum // 33 1/2"

i If installed under a countertop, the countertop must be continuous and securely attached to neighboring cabinets.

CAUTION

An opening of at least 31 square inches (200 cm²) must be available at the front and side of the closet.

You can use the cover for appliance underneath worktop which can be obtained from customer service or your local dealer (**WTZ10290**).

Electrical connection

CAUTION

Connect to individual Branch Circuit.

- Do not use an adapter.
- Do not use an extension cord.
- Do not remove ground prong.

Your dryer comes with a power supply cord:

- UL listed in the USA,
- CSA listed in Canada.

When installing the receptacle for the dryer cord, ensure that the power supply cord is accessible when the dryer is in the installed position.

The power cord should only be replaced by a qualified person. Use a 4-wire power supply cord.

Grounding instruction

The dryer comes with a cord which has an equipment grounding conductor and a grounding plug. The plug must be plugged into an appropriate outlet which has been properly installed and grounded in accordance with all local regulations and ordinances.

CAUTION

Improper connection of the equipment grounding conductor may result in electric shock. Have the appliance checked by a qualified electrician or service technician if you are in doubt as to whether the dryer has been properly grounded.

Integrated socket

This appliance is equipped with a socket for connecting a washer without fuses. Only the listed washer may be connected. For all other connections Bosch will assume no liability.

CAUTION

Use copper conductors only.
Connect to a 30 A minimum individual branch circuit, fused at 30 A maximum.
Use receptacle only for:
208 – 240 VAC 60 Hz 11 A
washer: WFR2460UC,
WFL2060UC.

Exhaust air connection

You can use the exhaust air set which can be obtained from customer service or your local dealer (**WTZ1130**).

Also any products which are commercially available can be used for the exhaust air duct:

- flexible tubes,
- galvanised sheet metal ducts or tubes,
- connection, transfer and by-pass adapters for use in flat duct or tubular ducting systems,
- wall boxes for ventilation into the open air or into an air shaft,
- adapters for rectangular ducts,
- rectangular ducts or plastic tubes one-way flap.

CAUTION

All materials must be heat-resistant up to 80 °C and humidity-resistant.

WARNING

1. To reduce the risk of fire, this dryer **MUST BE EXHAUSTED OUTDOORS**.
2. To reduce the risk of fire, do not use the ductwork longer than recommended.
3. **DO NOT** use a plastic or non-metal duct with this dryer.
4. **DO NOT** use a duct smaller than 4 inches in diameter.
5. **DO NOT** use exhaust hoods with magnetic latches.
6. **DO NOT** exhaust the dryer into a chimney, furnace cold air duct, attic, crawl space, or any other ductwork used for venting.
7. **DO NOT** install a flexible duct in an enclosed wall, ceiling or floor.
8. **DO NOT** crush or kink the duct.
9. Do clean and inspect the exhaust system on a regular basis; at least once a year.
10. The exhaust duct must terminate in a manner to prevent back drafts or entry of birds or other wildlife.

The Bosch dryers are intended to be vented outdoors. To prevent build-up of moisture and accumulation of lint indoors, as well as to maintain maximum drying efficiency, it is recommended that the dryer is vented outdoors.

-  Position the exhaust air duct so that there is no counter-pressure (e.g. from wind) on the exhaust outlet.

Rear panel connection

The dryer is delivered with an exhaust air outlet on the rear of the appliance. The exhaust air vent on the left-hand side panel is closed and covered.

Select the most suitable exhaust air outlet.

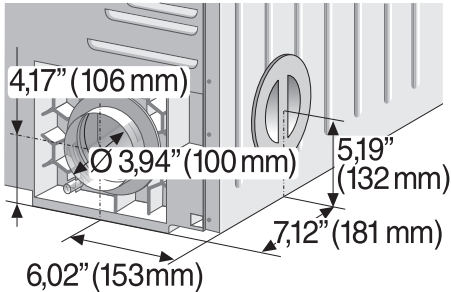

Left-hand side panel connection

1. Remove the cover from the side panel.

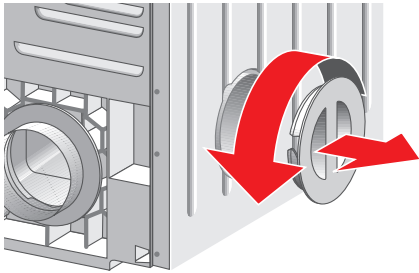

2. Remove the bayonet ring from the rear panel and attach it to the side panel vent.

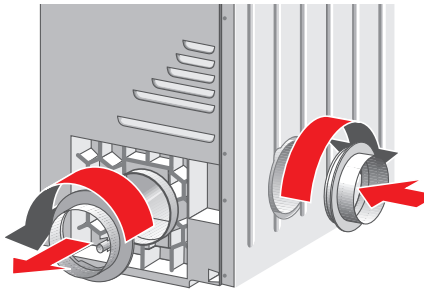

3. Close off the rear panel vent with the cover.

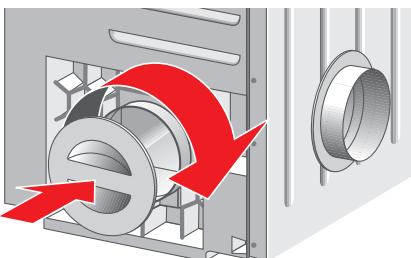

Ductwork

To ensure optimum performance, the ducting system of the dryer should be as short as possible with a minimum number of elbows. Your dryer will work best when the venting system has as few air flow restrictions as possible. Exhaust ducting which is longer than recommended may extend drying time, cause lint to accumulate and affect dryer performance and dryer life-time.

Four-inch (approx. 100 mm) diameter ducting should be used. Use either rigid metal or flexible metal ducting material.

DO NOT use plastic or non-metal duct with this dryer.

DO NOT assemble the ductwork with screws or fasteners that extend into the duct. They will serve as an accumulation point for lint.

Joints should be secured with duct tape.

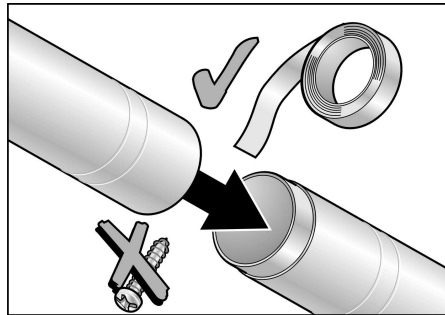

All joints should be tight to avoid leaks. The male end of each duct section must point away from the dryer.

Whether connecting to an existing venting system or a new venting system, make sure that all ducting is clean and free of lint.

The maximum permitted length for both rigid and flexible metal duct is shown in the table below.

Number of 90° Turns or Elbows	Rigid Duct	Flexible Duct
0	66 ft. (2011 cm)	45 ft. (1372 cm)
1	56 ft. (1707 cm)	36 ft. (1097 cm)
2	48 ft. (1463 cm)	29 ft. (884 cm)
3	39 ft. (1189 cm)	22 ft. (671 cm)
4	30 ft. (914 cm)	16 ft. (488 cm)

Note:

Left-hand side exhaust installation has a 90° turn inside the dryer. To determine maximum exhaust length, add one 90° turn to the chart.

More than two 90° turns are not recommended. For best performance, separate all turns by at least 4 ft. of straight duct, including distance between last turn and exhaust hood.

Condensation outlet

If water from condensation builds up in the exhaust air duct, it is recommended that a condensation collector (as commercially available) is fitted or that a drain hole of approximately 3 mm in diameter is introduced in the lowest section of the exhaust air duct.

Exhaust vent hood

The exhaust duct must end with an approved exhaust vent hood with swing out damper(s). DO NOT use an exhaust vent hood with magnetic latches.

To avoid exhaust restriction, the outlet must be a minimum of 12 inches (30 cm) above ground level or any other obstructing surface.

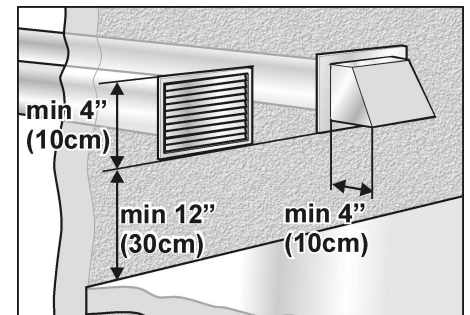

Required parts

The parts required for the exhaust air system (elbows, lines, exhaust air outlets) are not included in standard delivery of the dryer.

Installation – step by step

1. Unpack the dryer.
2. Remove all objects from the drum.
3. Check the dryer for visible damage.
4. Position the dryer near the installation location.

i If space is very restricted, it is recommended to fit the exhaust air duct to the dryer before the dryer is moved to its final installation location.

5. Move the dryer to its final location and align.

CAUTION

Do not slide dryer across the floor if height-adjustable feet have been extended. Feet and/or dryer base may be damaged if dryer is slid across floor with height-adjustable feet extended.

6. Position and then level the dryer.

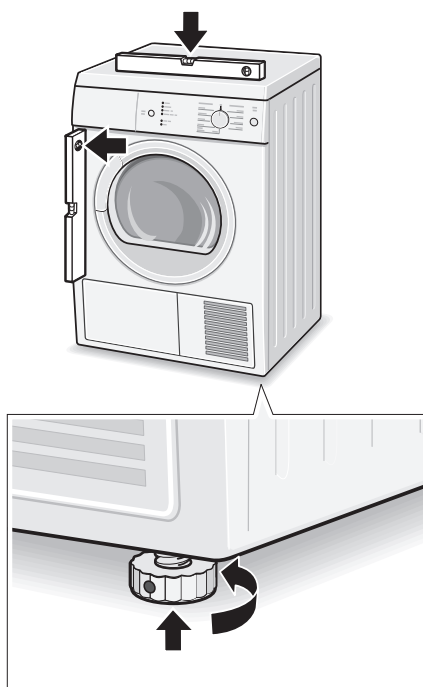

The dryer should be level with all four feet firmly on the ground. The dryer must not wobble.

If the dryer is not level or if it does wobble, the feet must be adjusted. Adjust the height-adjustable feet until the dryer does not rock and is level, both front-to-back and side-to-side.

7. Insert plug into the wall receptacle.

Check list before using the dryer

1. Check that steps 1-7 have been implemented properly.
2. Ensure that the dryer is connected to the power supply.
3. Read the operating instructions to understand how your dryer operates.
4. Conduct an appliance test:
 - Check that the drum is empty.
 - Close the dryer door.
 - Switch the dryer to **Extra dry** and then press the Start button.
 - After 3-5 minutes press the Stop button and open the door.
5. If the interior of the dryer feels warm, the dryer has been connected properly. Switch the dryer to **Off**.
6. If the dryer does not work, switch the dryer to **Off**. Look in the troubleshooting section (page 19) of the OPERATING INSTRUCTIONS and find the fault.

Preparing to transport the dryer

1. Rotate the program selector to **Off**.
2. Pull out power supply plug.
3. Place any accessories in the drum.
4. Close the door and secure with adhesive tape.
5. Screw the height-adjustable feet of the dryer into the housing to prevent them from being damaged during transportation.

OPERATING INSTRUCTIONS

Your new dryer

Open the door...



...and close the door.

Lint filter

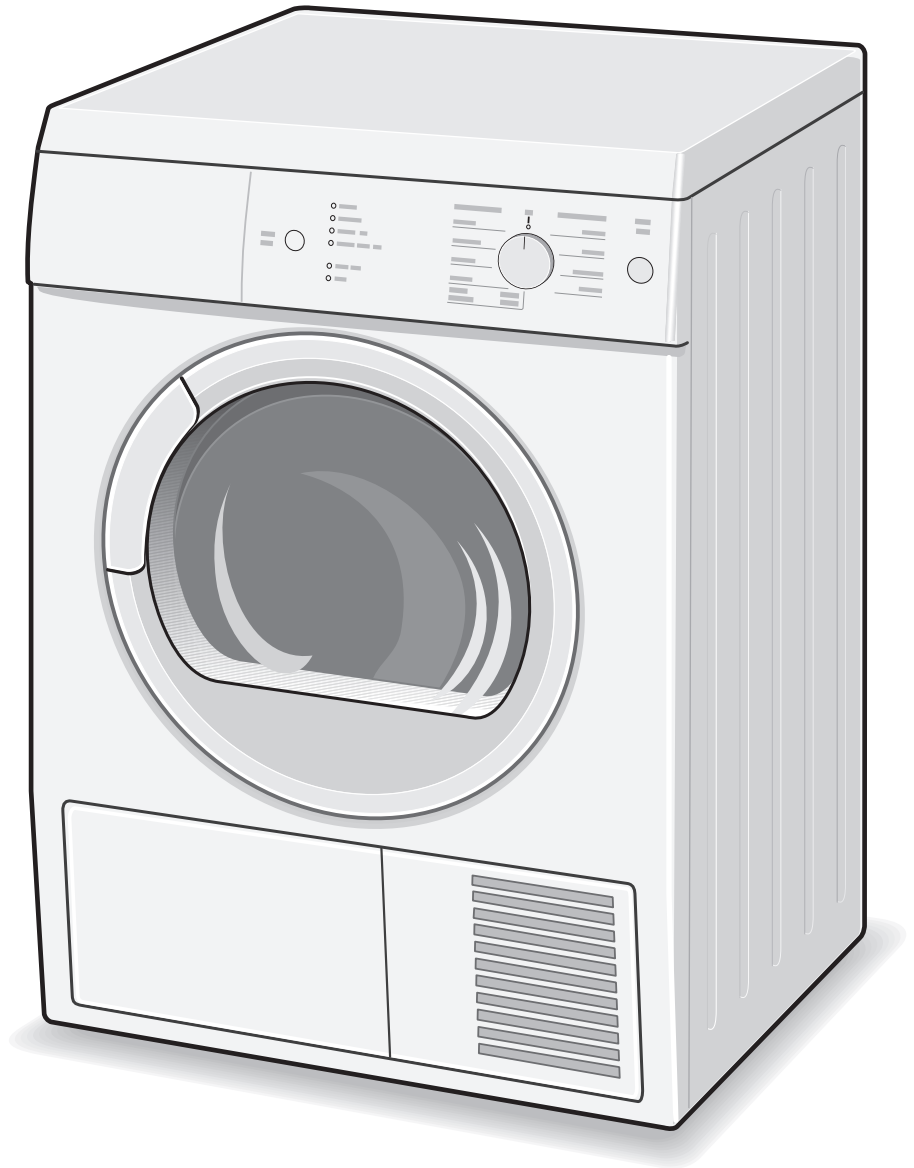
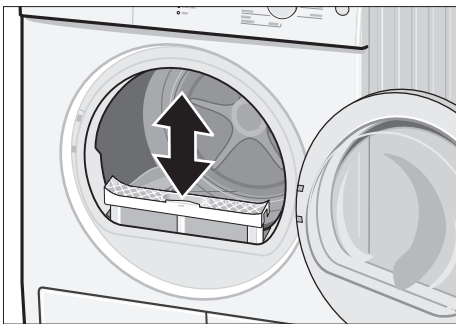

Panel

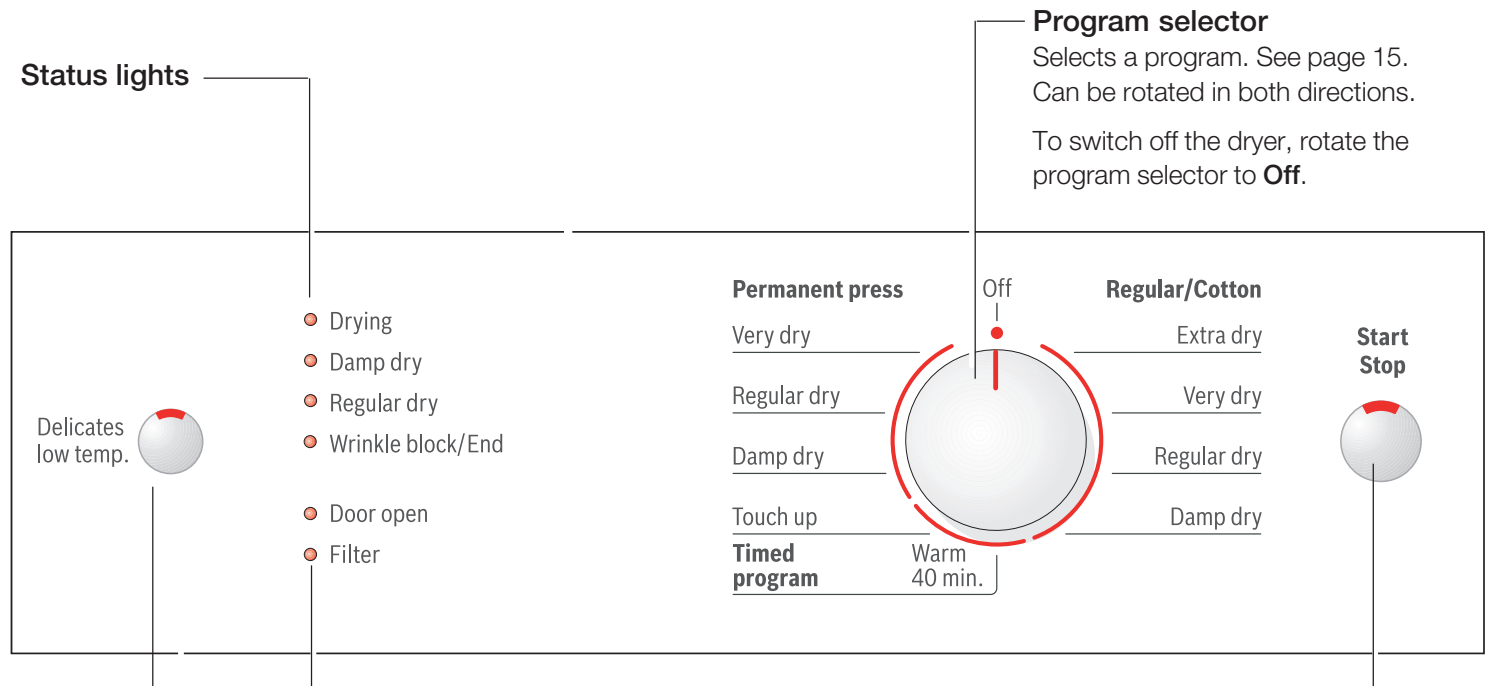

Program selector

Selects a program. See page 15.
Can be rotated in both directions.

To switch off the dryer, rotate the program selector to **Off**.

- Drying
- Damp dry
- Regular dry
- Wrinkle block/End
- Door open
- Filter

Permanent press

Very dry

Regular dry

Damp dry

Touch up

Timed program

Off
Warm
40 min.

Regular/Cotton

Extra dry

Very dry

Regular dry

Damp dry

**Start
Stop**

Indicator lights (LED)

Door open Close door.

Filter Clean fluff filter.

Start/Stop button

Starts, interrupts and ends the drying process.

Button for additional option

Delicates low temp.

Reduced temperature, the drying time is extended correspondingly; for sensitive textiles ☞, e.g. polyacrylic, polyamide, elastane, acetate.

Safety information

WARNING!

Always follow the IMPORTANT SAFETY INSTRUCTIONS (see page 4).

WARNING!

EXPLOSION HAZARD!

Keep flammable materials and vapors, such as gasoline, away from the dryer.

Do not dry anything that has ever had anything flammable on it (even after washing).

Do not dry anything that has ever had any type of oil on it (including cooking oils).

Items containing foam, rubber or plastic must be dried on a clothes-line or by using an Air fluff cycle.

Do not allow items containing flammable materials, such as lighters, to remain in clothes while drying.

Failure to follow these instructions may result in explosion or fire.

Risk of death or injury!

Intended Use

Use the dryer only in the house and for drying normal amounts of laundry for the household.

Use only for drying textiles which were washed with water.

Before switching on the dryer

Install the dryer in accordance with the installation instructions (from page 6).

Do not use a dryer which is visibly damaged. If in doubt, contact your dealer.

Using the dryer

Do not leave children unsupervised near the dryer.

Keep pets away from the dryer.

Before closing the door, check the contents of the drum.

Remove all objects from pockets. Lighters are particularly hazardous.

Risk of explosion!

Switch off the dryer at the end of the program.

Protecting the dryer

Do not climb on the dryer.

Do not lean or sit on the door.

Risk of dryer tipping over!

Do not store or use solvent detergent boosters or stain remover in the vicinity of the dryer.

The dryer could be damaged.

Do not lift the dryer by projecting components.

Risk of breakage!

Risk of injury!

Before using the dryer for the first time

Before you use the dryer for the first time:

1. Read these operating instructions carefully.
2. Check that the supply voltage corresponds with the voltage specifications on the rating plate of the dryer, see rear side of the dryer.
3. Remove all objects from the drum.
4. Check the dryer for visible damage. If damages found contact your dealer.
5. Wipe the inside of the drum with a damp cloth.
6. Conduct an appliance test, see page 10.
7. If the dryer does not work, switch the dryer to **Off**. Look in the troubleshooting section (page 19) of the operating instructions and find the fault.

Temporary disconnection of the dryer

Operate your dryer only when you are at home. If you intend going on vacation or are not using your dryer for an extended period of time, you should:

1. Turn off the circuit breaker.
2. Pull out the power supply plug if possible.
3. Clean the lint filter.

Laundry

Identification of fabrics

Observe the treatment symbols on the textile labels. They provide valuable information as well as limitations about the drying process.

Do not dry the following textiles in the dryer:

- Air-tight textiles (e.g. rubberized).
- Delicate fabrics (silk, synthetic curtains).

Drying tips

In principle, the following applies to all drying programs:

- To ensure a uniform drying result, sort the laundry according to fabric type and drying program.
- Fasten zippers, hooks and eyes. Fasten loose belts, apron strings, etc..
- Do not overdry easy-care laundry – risk of wrinkling! Leave laundry to dry in the air.
- Do not iron laundry immediately after drying. Place the laundry in a pile for a short while. Residual moisture will then be distributed uniformly.
- Knitted textiles (e.g. T-shirts, cotton jersey laundry) often shrink when dried for the first time. Do not use the **Very dry/Extra dry** program.

Protection of environment

Tips on saving energy

To save energy, money and time, Bosch recommends the following:

- **Drain the laundry thoroughly!**
Before drying, spin the laundry thoroughly in the washing machine. Use the highest possible spin speed for the type of laundry! Higher spin speeds reduce the drying time and the energy consumption.
- **Use optimum load!**
Use maximum recommended loads. However, do not exceed loads.
- **Clean filter!**
Clean the filter before and after each drying process (see page 17).
- **Ventilate the room!**
During the drying process provide an adequate supply of fresh air.
- **Do not dry unsuitable materials!**
Do not dry rubberized or air-tight items.
- **Do clean and inspect the exhaust system on a regular basis!**
Blockages may extend drying time.

Program selection

For optimum drying results your dryer offers several program groups and additional options.

Select the required drying program from the program table according to the examples (see page 22).

Automatic programs

There are automatic programs for different types of textiles (regular/cotton, permanent press).

Regular/Cotton

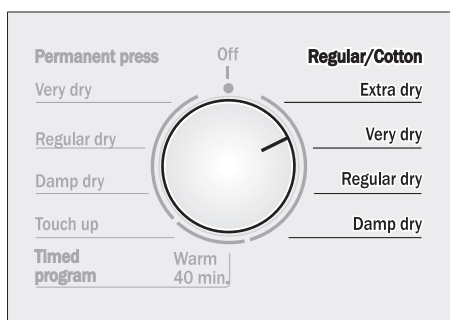

Permanent Press

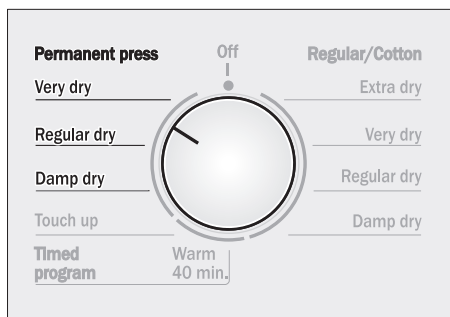

The program sequence of automatic programs is controlled via sensors. The duration of the program depends on the measured degree of moisture in the laundry and on the selected degree of dryness (e.g. damp dry or extra dry).

Time programs

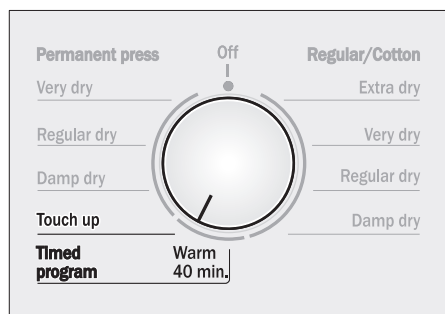

Time programs run at specific temperatures. Suitable for predried, multi-ply, delicate textiles or individual small items. Also for subsequent drying.

- Warm 40 min.
- Touch up (20 min) for extreme temperature sensitive textiles.

Option

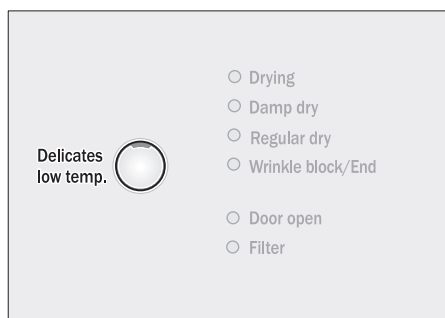

Delicates low temp.

Press the **Delicates low temp.** button for temperature sensitive textiles. Observe the care information or symbols on the textiles. The temperature of the drying process is reduced, the drying time is extended.

- i** For extreme temperature sensitive textiles (e.g. camisoles, paints) press the **Delicates low temp.** button to reduce the temperature of the drying process.

Indicator of program sequence

The dryer uses an electronic scanning system for all programs except the time programs. A moisture sensor continuously checks the moisture in the laundry. Drying ends automatically as soon as the selected degree of dryness has been reached.

The drum continues to rotate at specific intervals for one hour to prevent creasing.

The current state of the process and the level reached during the program sequence is indicated via indicator lights (Drying, Damp dry, Regular dry, Wrinkle block/End).

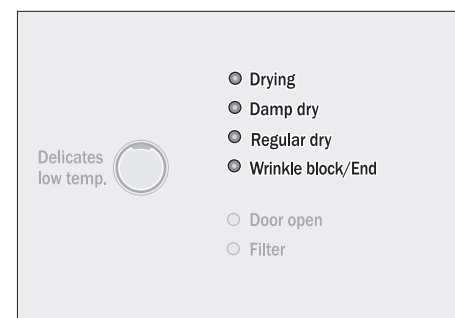

- i** If the indicator light **Wrinkle block/End** illuminates when the program selector is in Off-Position – turn off the circuit breaker and call for customer service!

Operation

Using the dryer



1. Open the door.

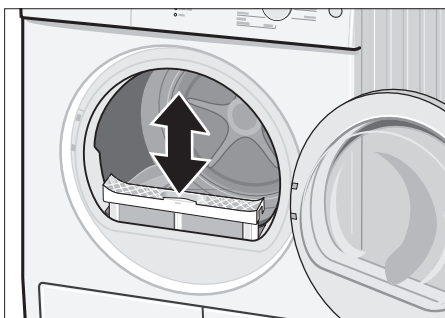

2. Check lint filter.

The filter should be cleaned after and before every drying process. Cleaning the filter reduces the drying time and saves energy.

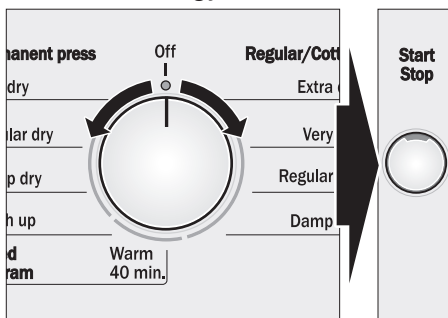

3. Rotate program selector to the desired program.

Select the program which corresponds to the laundry in the dryer from the program selection table (see page 22).

The **Start/Stop** indicator light starts flashing.

i Lint filter indicator flashes for 5 seconds – Check lint filter!

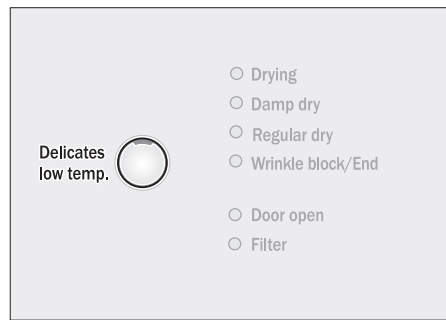

4. If required, select **Delicates low temp.** by pressing the button.

See explanation on page 15.

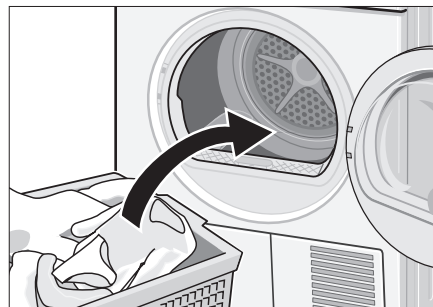

5. Place laundry in the empty drum. Put each piece of laundry into the machine separately.

For best results the laundry to be dried must be sorted according to type of laundry and desired degree of drying. For further information see page 14.

i Observe drying symbols of the laundry manufacturer.

Ensure that there is only laundry in the drum. Check that all items are completely in the drum.

6. Close the door.

i If the door has not been closed properly, the dryer will not start.

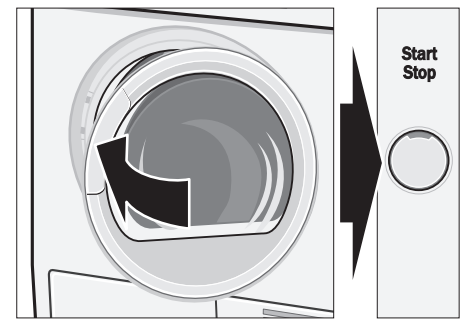

7. Press the **Start/Stop** button. The **Start/Stop** indicator light illuminates.

If an automatic program has been selected, the indicator lights indicate the progress of the program sequence.

i At the end of the program sequence **Damp dry** is emitted (if set).

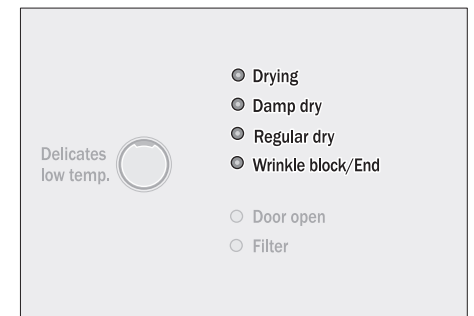

i At program end the LED **Wrinkle block/End** illuminates.

i When the drying process is complete (program or selected time program ended), the drum rotates at specific intervals. This prevents the laundry from creasing.

8. Open the door.

9. Take the laundry out of the dryer.

10. Rotate the program selector to **Off**. The dryer light goes out.

11. Clean the filter. The filter should be cleaned after each drying process. Cleaning the filter reduces the drying time and saves energy.

12. Close the door.

Cleaning and care

Cleaning the dryer



WARNING!

RISK OF EXPLOSION!

Never use solvents or highly flammable liquids for cleaning.

CAUTION!

Incorrect cleaning may damage the dryer. Do not spray with a water jet. Do not use scouring agents or all-purpose cleaners. Do not use steam cleaners.

Wipe the housing and fascia with a soft cloth and soapy water only.

Wipe the drum, door seal and inside of the door with a damp cloth only.

Immediately remove washing and cleaning agent residue.

Cleaning the lint filter

A dirty filter extends the drying time and increases energy consumption.

The filter should be cleaned before and after each drying process, however at the latest when the **Filter** indicator light illuminates.

If the **Filter** indicator light illuminates during a drying program, clean the filter immediately.

i The program interrupts automatically.

1. Switch off the dryer. Program selector to **Off**.

CAUTION

The inside of the door heats up during the drying process.

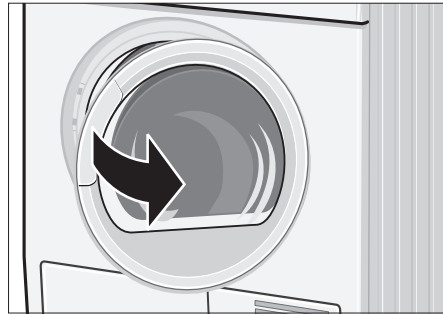

2. Open the door.

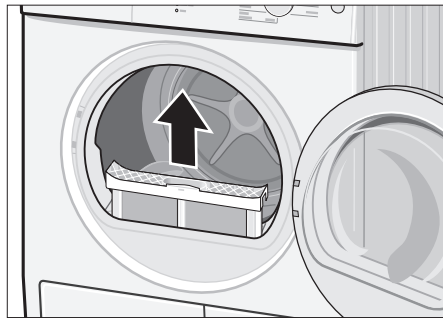

3. Pull out filter...

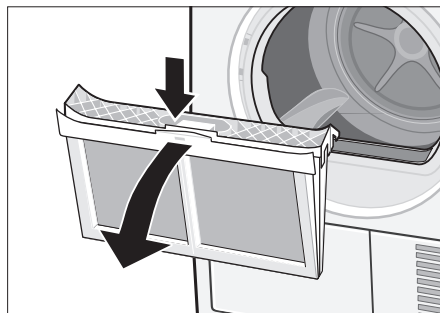

4. ...and open.

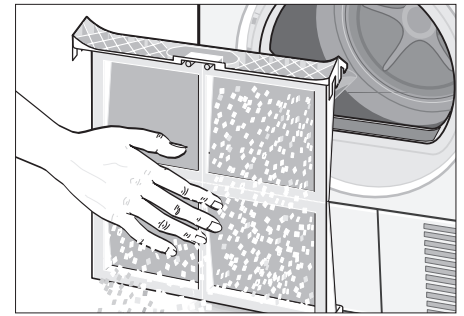

5. Remove fluff (run hand over filter).

The filter should be rinsed once a year under warm running water. The filter must be dried thoroughly before being replaced.

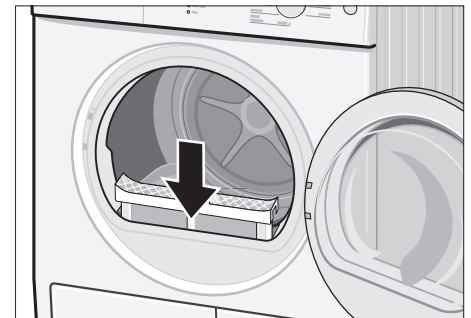

6. Close filter and re-insert.
7. Close the door.

Cleaning the exhaust duct

Inspect and clean the exhaust ducting at least once a year to prevent clogging. A partially clogged exhaust can lengthen the drying time.

1. Switch off the dryer and allow it to cool down.
2. Pull out power supply plug.
3. Disconnect the duct from the dryer.
4. Vacuum and reconnect the duct.

Cleaning the moisture sensor

Occasionally the moisture sensor has to be cleaned because a fine layer of transparent buildup is deposited on the sensors.

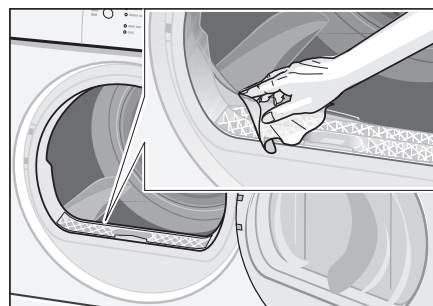
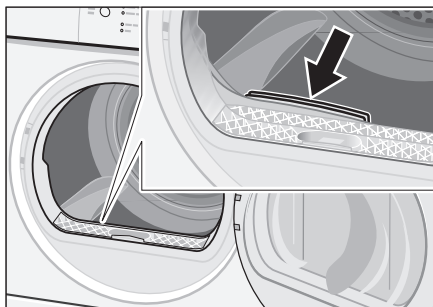

This deposit can easily be removed by wiping the sensors (the two bars next to the lint filter) with a cloth and a little white vinegar. Use white vinegar only! Clean the moisture sensor once a month.

Cleaning the bearing shield

Over time, fluff from the drying process collects in the bearing shield.

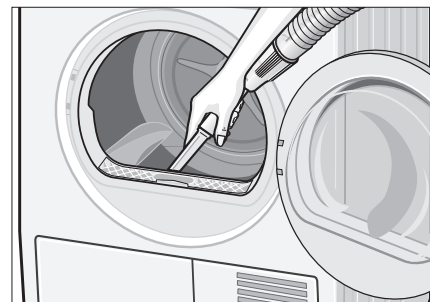

This fluff can be easily removed using your vacuum cleaner, at least once a month.

Troubleshooting

WARNING!

RISK OF ELECTRICAL SHOCK !
EXPLOSION HAZARD!

Repairs or replacement of parts may be carried out by authorized technicians only.

Before calling the customer service, check whether you can rectify the fault yourself by means of the following table.

If a fault cannot be rectified or a repair is required:

1. Set program selector to **Off**.
2. Turn off the circuit breaker.
3. Pull the mains plug out of the socket.
4. Call customer service (see page 20).

Problem	Possible cause	Remedial action
Dryer does not start. Start/Stop indicator light does not illuminate.	Main plug not inserted at all or not inserted correctly.	Insert main plug correctly.
	A fuse of power supply has tripped.	Replace/switch on fuse.
	Start/Stop button not pressed.	Press Start/Stop button.
	Door not closed.	Close door.
	Ambient temperature below 41 °F/5 °C.	Increase room temperature.
Program has been interrupted. Filter indicator light illuminates, a warning signal is emitted and the display shows "F:01" or "F:02".	Lint filter dirty.	Clean filter as described on page 17. Switch off/switch on again.
	Exhaust air duct is blocked or too long.	Clean exhaust air duct. Reduce exhaust air duct to maximum length as described on page 9. Switch off/switch on again.
	Fault in program sequence or malfunction.	Switch off dryer, leave to cool down for 30 min, switch on again. Restart program.
	The room/cabinet is not adequately ventilated.	Provide an adequate supply of fresh air. Switch off/switch on again.
Start/Stop indicator light does not illuminate. Wrinkle block/Finished indicator lights. The display shows "-0-".	Fault in program sequence or malfunction.	Switch off dryer, leave to cool down for 30 min, switch on again. Restart program.
Degree of drying has not been reached or the drying time is too long. Display may indicate "F:04".	Moisture sensor dirty.	Clean moisture sensor as described on page 18. Switch off/switch on again.
	Exhaust air duct is blocked or too long.	Clean exhaust air extraction. Reduce exhaust air duct to maximum length as described on page 9. Switch off/switch on again.
	Laundry was too wet.	Spin laundry at higher speed in the washing machine. Switch off/switch on again.
	Unsuitable program selected.	Select program with aid of the program selection table (see page 22). Switch off/switch on again.
	Maximum drying time was exceeded.	Clean lint filter (see page 17). Spin laundry at a higher speed in your washer.
	Motor limit temperature was exceeded.	Switch off dryer, leave to cool down for 30 min. Switch on again. Start program.

SERVICE and REPAIR

CAUTION

CAUTION – Label all wires prior to disconnection when servicing controls. Wiring errors can cause improper and dangerous operation. Verify proper operation after servicing.

The Bosch dryers require no special care other than the care and cleaning noted above.

i If you are having a problem with your dryer, before calling for service please refer to Table on page 19, following.

If service becomes necessary, contact your dealer or installer or an authorized service center. Do not attempt to repair the appliance yourself. Any work performed by unauthorized personnel may void the warranty.

If you are having a problem with your Bosch dryer and are not pleased with the service you have received:

- First, please contact your installer or the Bosch Authorized Service Contractor in your area and explain to them why you are not satisfied. This will usually correct the problem.
- If after working with your installer or service person the problem still has not been resolved to your satisfaction, please let us know by either writing to us at,

BSH Home Appliances
5551 Mc Fadden Avenue
Huntington Beach, CA 92649

or, calling us at

1-800-944-2904.

Please be sure to include, if writing, or have available, if calling, the following information:

- Model Number
- Serial Number
- Date of Original Purchase
- Date Problem Originated
- Explanation of Problem

Also, if writing, please be sure to include a daytime telephone number and a copy of the sales invoice.

You will find the model number and serial number information on the rating plate.

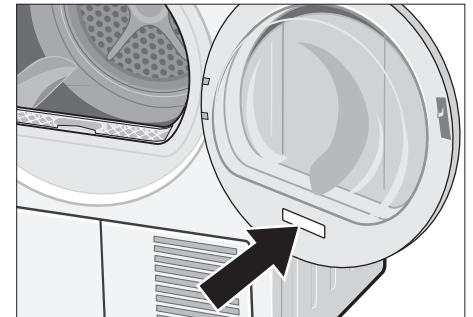

STATEMENT OF WARRANTIES BOSCH CLOTHES DRYERS

The warranties provided by BSH Home Appliances (“Bosch”) in this Statement of Warranties apply only to Bosch Clothes dryers sold to the

first using purchaser by Bosch or its authorized dealers, retailers or service centers in the United States

or Canada. The Warranties provided herein are not transferable.

LENGTH OF WARRANTY	SCOPE OF WARRANTY
1 Year Full Limited Warranty From Date of Installation*	Bosch will repair or replace, free of charge, any component part that proves defective under conditions of normal home use, labor and shipping costs included. Warranty repair service must be performed by an authorized Bosch Service Center.
2 Year Limited Warranty From Date of Installation*	Bosch will provide replacement parts, free of charge, for any component part that proves defective under conditions of normal home use, shipping costs included, labor charges excluded.
2 Year Limited Warranty on Electronics From Date of Installation*	Bosch will repair or replace, free of charge, any microprocessor or printed circuit board that proves defective under conditions of normal home use during the first through second year from the date of original installation, labor charges excluded.
2 Year Limited Warranty on Motor From Date of Installation*	Bosch will repair or replace, free of charge, any motor or component part of the motor that proves defective under conditions of normal home use during the first through second year from the date of original installation, labor charges excluded.
* Date of installation shall refer to the earlier of the date the clothes dryer is installed or ten business days after the delivery date.	

Exclusions

This warranty does not cover service calls or repairs to correct the installation of the clothes dryer, to provide instructions on the use of your clothes dryer, to replace house fuses or correct plumbing or the electric wiring in your home or to repair any clothes dryer that’s use was in a manner other than what is normal and customary for home use.

In addition, the warranties provided in this Statement exclude any defects or damage arising from accident, alteration, misuse, abuse, improper installation, unauthorized service work, external forces beyond Bosch’s control, such as fire, flood, and other acts of God, or installation not in accordance with local electrical and plumbing codes.

Labor charges incurred in the repair or replacement of any clothes dryer after a period of one year from date of installation shall not be covered by this warranty. Any and all replaced and/or repaired parts shall assume the identity of the original for purposes of the applicable warranty period.

TO THE EXTENT PERMITTED BY LAW, THIS WARRANTY IS IN LIEU OF ALL OTHER EXPRESS AND IMPLIED WARRANTIES, INCLUDING THE IMPLIED WARRANTIES OF MERCHANTABILITY AND FITNESS FOR A PARTICULAR PURPOSE. BOSCH DOES NOT ASSUME ANY RESPONSIBILITY FOR INCIDENTAL OR CONSEQUENTIAL DAMAGES.

TO OBTAIN WARRANTY SERVICE, CONTACT THE NEAREST BOSCH AUTHORIZED SERVICE CENTER OR CALL 1-800-944-2904, OR WRITE TO:
 BSH HOME APPLIANCES CORP.,
 5551 MC FADDEN AVENUE
 HUNTINGTON BEACH
 CA 92649.
 BE SURE TO PROVIDE YOUR CLOTHES DRYER’S MODEL, SERIAL NUMBER, PURCHASE DATE AND THE SELLER’S NAME, ADDRESS. AND A COPY OF THE SALES INVOICE.

Program selection table

Automatic programs		
For Cottons and coloreds made of cotton or linen. Press Delicates low temp. button for temperature-sensitive textiles.		Regular/Cottons
	<u>For laundry,</u>	
Bed linen and table linen, towels	which is to be ironed	Damp dry
Bed linen and table linen, towels, T-shirts, sports shirts, overalls		
T-shirts, sports shirts, dresses, trousers, overalls, underwear		
Terry towels, kitchen towels, hand towels, bed linen, underwear, cotton socks	which is not to be ironed	Regular dry
Terry towels, kitchen towels, hand towels, bed linen, underwear, cotton socks	which is not to be ironed, thick multi-ply	Very dry
Terry bathrobes and terry bed linen	which is particularly thick or multi-ply	Extra dry
Easy-care (drip-dry) laundry made of synthetic and blended fabric, cotton e.g. polyester Press the Delicates low temp. button for very temperature-sensitive textiles.		Permanent Press
	<u>For laundry,</u>	
Trousers, dresses, skirts, shirts, blouses, leggings, sports clothing with synthetic-rich fibers, lingerie	which is not to be or only lightly ironed	Damp dry
Shirts, blouses, sports clothing	which is not to be ironed	Regular dry
Bed linen and table linen, track suits, anoraks, blankets	which is not to be ironed, thick multi-ply	Very dry
Timed program		
Pre-dried textiles with low moisture content, individual small items, e.g. bath towels, bathing suits, dish cloths. For smallest loading condition from 0.22 lb–0.44 lb (0.1 kg – 0.2 kg) (i.e. one small towel), for this a time dry program should be selected. Also for subsequent drying. Press the Delicates low temp. button for temperature-sensitive textiles.		Warm 40 min. / Touch up (20 min.)

Summary of instructions

Safety information

⚠ WARNING! ⚠

Always follow the IMPORTANT SAFETY INSTRUCTIONS (see page 4).

⚠ WARNING! ⚠

EXPLOSION HAZARD!

Keep flammable materials and vapors, such as gasoline, away from the dryer.

Do not dry anything that has ever had anything flammable on it (even after washing).

Do not dry anything that has ever had any type of oil on it (including cooking oils).

Items containing foam, rubber or plastic must be dried on a clothes-line or by using an Air fluff cycle.

Do not allow items containing flammable materials, such as lighters, to remain in clothes while drying.

Failure to follow these instructions may result in explosion or fire.

Risk of death or injury!

Use the dryer only in the house and for drying normal amounts of laundry for the household. Use only for drying textiles which were washed with water.

⚠ CAUTION ⚠

Before using your dryer read and follow all installation and operating instructions.

Preparing the dryer

- i** Check the lint filter. The filter should be cleaned before and after every drying process.



Selecting a program

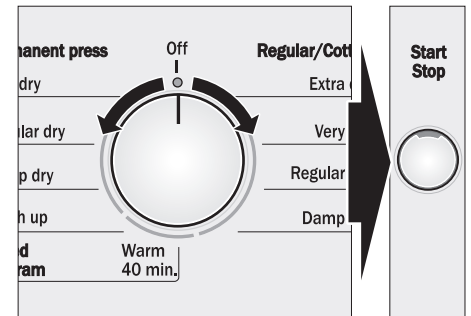

Choose an option...

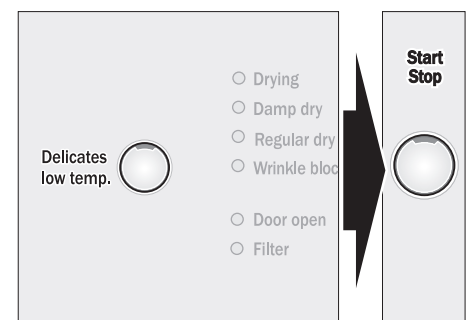

...and start the dryer.

Switch off the dryer

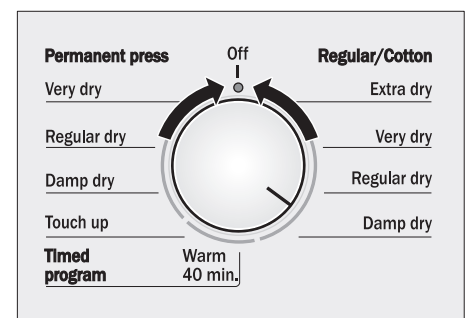

Free Manuals Download Website

<http://myh66.com>

<http://usermanuals.us>

<http://www.somanuals.com>

<http://www.4manuals.cc>

<http://www.manual-lib.com>

<http://www.404manual.com>

<http://www.luxmanual.com>

<http://aubethermostatmanual.com>

Golf course search by state

<http://golfingnear.com>

Email search by domain

<http://emailbydomain.com>

Auto manuals search

<http://auto.somanuals.com>

TV manuals search

<http://tv.somanuals.com>