

DOMINO COOKERS  
DOMINO-KOCHFELD  
ПЛИТЫ DOMINO  
“DOMINO” VIRYKLÉS

GES 23203 E

**Gebrauchsanleitung**

**Blomberg**

## **Please read this manual first.**

Dear Customer,

We would like you to obtain best performance with your product that has been manufactured in modern facilities and passed through strict quality control procedures.

Therefore, we advise you to read through this User Manual carefully before using your product and keep it for future reference. If you hand over the product to someone else, deliver the User Manual as well.

## **The User Manual will help you use the product in a fast and safe way.**

- Read the User Manual before installing and starting the product.
- You must strictly observe the safety instructions.
- Keep this User Manual within easy reach for future reference.
- Also read other documents supplied with the product.  
Remember that this User Manual may also be applicable for several other models.  
Differences between models are explicitly identified in the manual.

## **Explanation of symbols**

Throughout this User Manual the following symbols are used:

 Important information or useful hints about usage.

 Warning for hazardous situations with regard to life and property.

 Warning for electric shock.

 Warning for risk of fire.

 Warning for hot surfaces.



**Arçelik A.Ş.**  
Karaağaç caddesi No:2-6  
34445 Sütlüce/Istanbul/TURKEY  
Made in TURKEY

# Table of Contents

---

<b>1</b>	<b>General information</b> .....	<b>4</b>	Future transportation.....	13
	Overview.....	4		
	Technical Data.....	5		
	Injector table.....	5		
<b>2</b>	<b>Safety instructions</b> .....	<b>6</b>		
	Basic safety instructions.....	6		
	Safety when working with gas .....	6		
	Intended use .....	7		
	Safety for children .....	7		
<b>3</b>	<b>Installation</b> .....	<b>9</b>		
	Before installation.....	9		
	Installation and connection.....	10		
	Gas conversion.....	12		
	Disposal .....	13		
	Disposing of packaging material .....	13		
	Old equipment.....	13		
<b>4</b>	<b>Preparation</b> .....	<b>14</b>		
	Tips for saving energy.....	14		
	Initial operation .....	14		
	First cleaning of the appliance .....	14		
<b>5</b>	<b>How to use the hob</b> .....	<b>15</b>		
	General information on cooking.....	15		
	How to use hobs.....	15		
<b>6</b>	<b>Maintenance and care</b> .....	<b>17</b>		
	General information .....	17		
	How to clean the hob.....	17		
<b>7</b>	<b>Troubleshooting</b> .....	<b>18</b>		

# 1 General information

## Overview

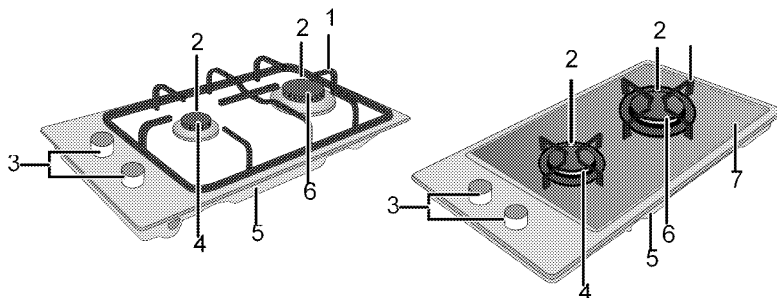

- 1 Pan support
- 2 Spark plug
- 3 Control panel
- 4 Auxiliary burner

- 5 Base cover
- 6 Rapid burner
- 7 Burners' plate

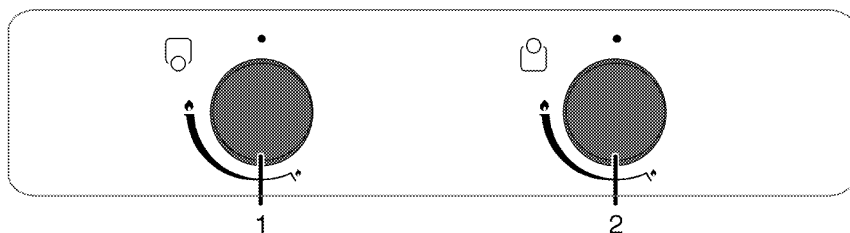

1 Auxiliary burner Front

2 Rapid burner Rear

## Technical Data

Voltage/frequency	220-240 V ~ 50 Hz
Cable type / cross section	H05RR-FG 3 x 0,75 mm <sup>2</sup>
Cable length	max. 2 m
Gas device category	II 2H3B/P
Gas type/pressure	NG 20/20 mbar
Total gas consumption	3.9 kW
Conversion to gas type/pressure <sup>s</sup> – optional	NG 20/13 mbar NG 20/10 mbar - LPG 30/28-30 mbar - Propane 31/37 mbar
Outer dimensions (height/width/depth)	75 mm/288 mm/510 mm
Installation dimension (width/depth)	268 mm/490 mm
<b>Burners</b>	
Front	<b>Auxiliary burner</b>
Power	1000 W
Rear	<b>Rapid burner</b>
Power	2900 W

## Injector table

Position hob zone Gas type / Gas pressure	1000 W	2900 W
	Front	Rear
G 20/10 mbar	90	155
G 20/13 mbar	84	145
G 20/20 mbar	72	115
G 30/28-30 mbar	50	87
G 31/ 37 mbar	50	87

## 2 Safety instructions

---

### Basic safety instructions

- The manufacturer reserves its right to make changes in the technical specifications in order to improve the appliance quality without any prior notice. Figures included in this manual are for schematic purpose only and may not match exactly with your appliance. Values stated on the markings of the appliance or in other printed documents supplied with the appliance are obtained under laboratory conditions as per relevant standards. These values may vary according to the usage of the appliance and ambient conditions.
- This appliance is not intended for use by persons (including children) with reduced physical, sensory or mental capabilities, or lack of experience and knowledge, unless they have been given supervision or instruction concerning use of appliance by a person responsible for their safety. Children should be supervised to ensure that they do not play with the appliance.
- Never use when judgement or coordination is impaired by the use of alcohol and/or drugs.
- Do not operate the appliance if it is defective or shows any visible damage.
- Do not carry out any repairs or modifications on the appliance. However, you may remedy some malfunctions; see *Troubleshooting, page 18*.
- Be careful when using alcoholic drinks in your dishes. Alcohol evaporates in high temperatures and may catch fire when it comes in contact with hot surfaces.
- Do not heat closed food containers and glass jars. Pressure that may build-up in the jar can cause it to burst.
- Ensure that no flammable materials are adjacent to the appliance as the sides become hot during use.
- Do not leave empty pots or pans on plates that are switched on. They may get damaged.
- Since it may be hot, do not leave plastic or aluminum dishes on the surface of appliance. These kind of dishes should not be used to keep food either.
- Check all controls on the appliance are switched off after use.



For the warranty to be valid, the appliance must be installed by a qualified person in accordance with current regulations.

### Safety when working with gas

- Any works on gas equipment and systems may only be carried out by authorised qualified persons who are Gas Safe registered.
- "Prior to the installation, ensure that the local distribution conditions (nature of the gas and

gas pressure) and the adjustment of the appliance are compatible."

- "This appliance is not connected to a combustion products evacuation device. It shall be installed and connected in accordance with current installation regulations. Particular attention shall be given to the relevant requirements regarding ventilation;" See *Before installation, page 9*
- "The use of gas cooking appliance results in the production of heat and moisture in the room in which it is installed. Ensure that the kitchen is well ventilated: keep natural ventilation holes open or install a mechanical ventilation device (mechanical extractor hood). Prolonged intensive use of the appliance may call for additional ventilation, for example increasing the level of the mechanical ventilation where present."
- Gas appliances and systems must be regularly checked for proper functioning. Please arrange for annual maintenance.
- Clean the gas burners regularly. The flames should be blue and burn evenly.
- Good combustion is required in gas appliances. In case of incomplete combustion, carbon monoxide (CO) might develop. Carbon monoxide is a colourless, odourless and very toxic gas, which has a lethal effect even in very small doses.
- Request information about gas emergency telephone numbers and safety measures in case of

gas smell from you local gas provider.

### **What to do when you smell gas**

- ⚠ Risk of explosion and poisoning!  
Put out all naked flames and do not smoke, strike matches or do anything that could cause ignition.  
Do not operate any electric switches (e.g. light switch, TV, computer, cooker or door bell).  
Do not use a telephone or mobile phone.

1. Turn off all valves on gas appliances and gas meter at the main control valve, unless it's in a confined space or cellar.
2. Open doors and windows.
3. Check all tubes and connections for tightness. If you still smell gas leave the property.
4. Warn the neighbours.
5. Call the fire-brigade. Use a telephone outside the house.
  - 5.1 If you have door or gates that are secured by an electric lock, or entry phone, please open these manually.
6. Do not re-enter the property until you are told it is safe to do so.

### **Intended use**

This product is designed for domestic use. Commercial use is not admissible. The manufacturer shall not be liable for any damage caused by improper use or handling errors.

### **Safety for children**

- Accessible parts of the appliance will become hot whilst the

- appliance is in use and until the appliance has cooled, children should be kept away.
- Do not store any items above the appliance that children may reach.
  - The packaging materials will be dangerous for children. Keep the packaging materials away from children. Please dispose of all parts of the packaging according to environmental standards.



## 3 Installation

### Before installation

The hob is designed for installation in a commercial worktop. A safety distance must be left between the appliance and the kitchen walls and furniture. See figure (values in mm).

- Remove packaging materials and transport locks.

- Surfaces, synthetic laminates and adhesives used must be heat resistant (100 °C minimum).
- The worktop must be aligned and fixed horizontally.
- Cut aperture for the hob in worktop as per installation dimensions.

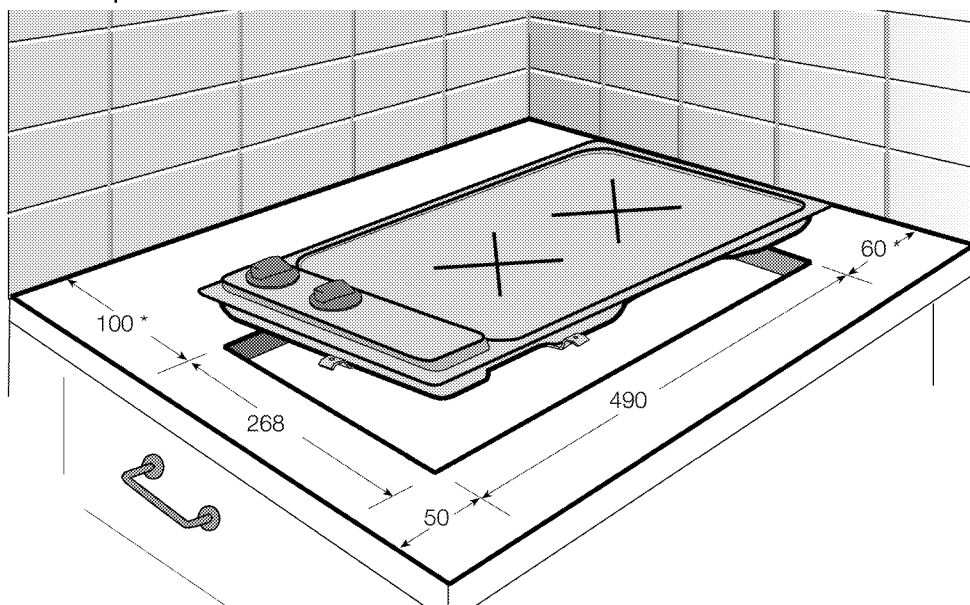

\* min.

### Room ventilation

The air for combustion is taken from the room air and the exhaust gases are emitted directly into the room. Good room ventilation is essential for safe operation of your appliance. If there is no window or door available for room ventilation, an extra ventilation must be installed.

Do not install this appliance in a room below ground level unless it is open to ground level on at least one side.

Failure to install correctly is dangerous and could result in prosecution. Prolonged intensive use of the appliance may call for additional ventilation, for example the opening of a window, or the use of permanent fixed mechanical ventilation system, for example, an extractor fan or cooker hood that ventilates to the outside.

Room size	Ventilation opening
smaller than 5 m <sup>3</sup>	min. 100 cm <sup>2</sup>
5 m <sup>3</sup> to 10 m <sup>3</sup>	min. 50 cm <sup>2</sup>
greater than 10 m <sup>3</sup>	not required
In the cellar or basement	min. 65 cm <sup>2</sup>

## Installation and connection

- For installation the appliance must be connected in accordance with all local gas and/or electrical regulations.

### Connection to the mains supply

#### This appliance must be earthed!

Our company shall not be held responsible for any damage caused by using the appliance without an earthed socket.

-  Risk of electric shock, short circuit or fire by unprofessional installation!

The appliance may be connected to the mains supply only by an authorized qualified person and the appliance is only guaranteed after correct installation.

-  Risk of electric shock, short circuit or fire by damage of the mains lead!

The mains lead must not be clamped, bent or trapped or come into contact with hot parts of the appliance.

If the mains lead is damaged, it must be replaced by a qualified electrician.

- The mains supply data must correspond to the data specified

on the rating plate of the appliance. The rating plate is located at the rear housing of the appliance.

- The appliance mains cable must correspond to the specifications and the power consumption; see *Technical Data, page 5*.

-  The plug should be easily accessible after installation (but not above the hob).

Plug the mains lead into the socket.

-  Risk of electric shock!  
Before starting any work on the electrical installation, please disconnect the appliance from the mains supply.

### Connection to the gas supply

-  Risk of explosion or poisoning by unprofessional installation.  
The appliance may be connected to the gas distribution system only by an authorized qualified person who is Gas Safe registered.

-  Risk of explosion!  
Before starting any work on the gas installation, please shut off the gas supply.

- "The adjustment conditions for this appliance are stated on the label (or data plate)."

-  Your appliance is adjusted for Natural gas.

- Natural gas installation must be adjusted before the appliance is installed.
- There must be a flex pipe at the outlet of the installation for the natural gas connection and the tip

of this pipe must be closed with a plug.

- Service Representative will remove the plug during connection and connect your appliance by means of a straight connection device (coupling).
- Make sure that the natural gas valve is readily accessible.
- If you need to use your appliance later with a different type of gas, you must consult the authorised Service for the related conversion procedure.

### Leakage control at the connection point

- Make sure that all knobs on the appliance are turned off. Make sure that the gas supply is on. Prepare soapy foam and apply it onto the connection edge of the hose for gas leakage control.
- Soapy part will froth if there is a gas leakage. In this case, inspect the gas connection once again.

**i** Never use a match or lighter to check for gas leakage.

### Installation

1. Prepare the counter according to the installation dimensions in the user manual.
2. In order to avoid the foreign substances and liquids penetrating between the hob and the worktop, please apply the putty supplied in the package to the contour of the housing in the worktop before installation but make sure that the putty does not overlap.

3. Place the hob onto the counter so that the control buttons will face forwards.

### Bottom view (clamp holes)

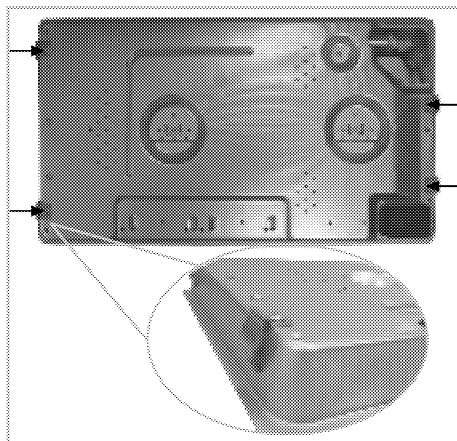

**i** Connection clamps will be supplied as installed onto the hob.

Clamping to different holes is not a good practice in terms of safety since it can damage the gas and electrical system.

### Final check

1. Open gas supply.
2. Check gas installations for secure fitting and tightness.
3. Ignite burners and check appearance of the flame.

**i** The flames should be blue and burn smoothly. If the flames appear yellowish, check secure position of the burner cap or clean the burner. Switch off gas and let burner cool before touching it.

## Gas conversion

-  Risk of explosion!  
Before starting any work on the gas installation, please shut off the gas supply.

In order to change your appliance's gas type, change all injectors and make flame adjustment for all valves at reduced flow rate position.

### Exchange injector for the burners

1. Take off burner cap and burner body.
2. Unscrew injectors.
3. Fit new injectors.
4. Check all connections for secure fitting and tightness.

-  New injectors have their position marked on their packing or injector table on *Injector table, page 5* can be referred to.

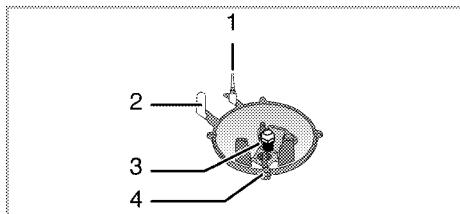

- 1 Flame failure device (model dependant)
- 2 Sparking plug
- 3 Injector
- 4 Burner

-  Unless there is an abnormal condition, do not attempt to remove the gas burner taps. You must call an Authorised service agent if it is necessary to change the taps.

### Reduced gas flow rate setting for hob taps

1. Ignite the burner that is to be adjusted and turn the knob to the reduced position.
2. Remove the knob from the gas tap.
3. Use an appropriately sized screwdriver to adjust the flow rate adjustment screw.

For LPG (Butane - Propane) turn the screw clockwise.

For the natural gas, you should turn the screw **counter-clockwise** once.

» The normal length of a straight flame in the reduced position should be 6-7 mm.

4. If the flame is higher than the desired position, turn the screw clockwise. If it is smaller turn anticlockwise.

5. For the last control, bring the burner both to high-flame and reduced positions and check whether the flame is on or off.

Depending on the type of gas tap used in your appliance the adjustment screw position may vary.

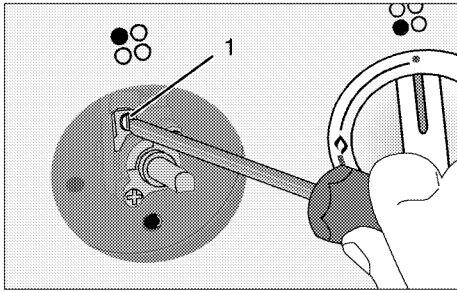

1 Flow rate adjustment screw

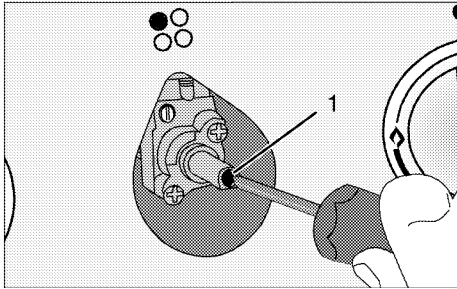

1 Flow rate adjustment screw

-  If the gas type of the unit is changed, then the rating plate that shows the gas type of the unit must also be changed.

## Disposal

### Disposing of packaging material

Packaging materials are dangerous to children. Keep packaging materials in a safe place out of reach of children. Packaging materials of the product are manufactured from recyclable materials. Dispose of them properly and sort in accordance with recycled waste instructions. Do not dispose of them with normal domestic waste.

## Old equipment



This appliance bears the selective sorting symbol for waste electrical and electronic equipment (WEEE). This means that this appliance must be handled pursuant to European Directive 2002/96/EC in order to be recycled or dismantled to minimize its impact on the environment. For further information, please contact your local or regional authorities. Electronic appliances not included in the selective sorting process are potentially dangerous for the environment and human health due to the presence of hazardous substances.

## Future transportation

-  Do not place other items on the top of the appliance. The appliance must be transported upright.

Store the appliance's original box and transport the appliance in its original carton. Follow the guidance marks that are printed on the carton.

-  Verify the general appearance of your equipment by identifying possible damage during the transportation.

Secure the caps and pan supports with adhesive tape.

### If you do not have the original carton

Pack the appliance in bubble wrap or thick cardboard and tape it securely in order to prevent damage during transportation.

## 4 Preparation

---

### Tips for saving energy

The following tips will help you to use your appliance in an ecological way and to save energy:

- Use pots/pans with lids for cooking. Without a lid, the energy consumption may be up to four times higher.
- Choose the burner/plate which is suitable to the saucepan base. Always choose the correct size of saucepans for your meals. For larger burners/plates more energy is needed.

### Initial operation

#### First cleaning of the appliance

 The surface may get damaged by some detergents or cleaning materials.

Do not use aggressive detergents, cleaning powder/cream or any sharp objects.

1. Remove all packaging materials.
2. Wipe the surfaces of the appliance with a damp cloth or sponge and dry with a cloth.

## 5 How to use the hob

### General information on cooking

⚠ Risk of fire by overheated oil!  
When you heat oil, do not leave it unattended.

**Never try to extinguish the fire with water!** When oil has caught fire, immediately cover the pot or pan with a lid. Switch off the hob if safe to do so and phone the fire service.

- Ensure handles of pans cannot accidentally be caught or knocked and do not get hot by adjacent heating zones. Avoid pans that are unstable and easily tipped. Pans that are too heavy to move easily when filled can also be a hazard. Only use flat bottomed pots or pans.
- Use pans which have sufficient capacity for the amount of food being cooked so they don't boil over and cause unnecessary cleaning.

Do not place lids on the burners. Always position pans centrally over the burners. When transferring pans from one burner to another always lift the pans do not slide them.

### Cooking with gas

- The size of the pan and the size of the gas flame should match each other. Adjust the gas flames so that they do not go beyond the bottom of the pan always place

the pan onto the pan support in a central position.

### How to use hobs

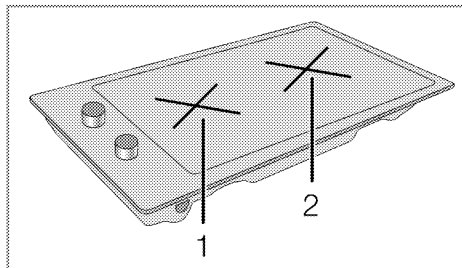

- 1 Auxiliary burner 12-18 cm
- 2 Rapid burner 22-24 cm is list of advised diameter of pots to be used on related burners.

The large flame symbol corresponds to the highest cooking power, the small flame symbol corresponds to the lowest cooking power. In the off position (top) the gas supply to the burner is turned off.

### Ignite the gas burners

The burners are ignited with the hob control knobs.

1. Keep hob control knob pressed.  
» A spark ignites at the plate.
2. Turn anticlockwise to the large flame symbol.  
» The emanating gas is lit.
3. Adjust to the desired cooking power.

### Switch off the gas burners

Turn burner control knob to off position (top).

## Flame failure device (model dependant)

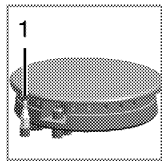

1 . Flame failure device

In case of any flame failure for any reasons in the top burners, the flame failure device immediately cuts off the gas flow.

- Turn the knob clockwise direction by pressing and wait for its ignition.

- Keep the knob at pressed position for 3-5 seconds after you see the flame around the burner.
- Repeat the sequence of operations if the flame does not ignite. After you release the knob, if the ignition does not continue repeat the same process by keeping the knob pressed for 15 seconds.



Risk of deflagration incase of unburned gas!

Do not press the knob for longer than 15 seconds if there was no ignition.



Wait for one minute and then repeat the ignition process.



## 6 Maintenance and care

---

### General information

-  Risk of electric shock!  
Switch off the electricity before cleaning appliance to avoid an electric shock.
-  Hot surfaces may cause burns!  
Allow the appliance to cool down before you clean it.
-  The surface may get damaged by some detergents or cleaning materials.  
Do not use aggressive detergents, cleaning powder/cream or any sharp objects.

Clean the appliance thoroughly after each use; in this way it will be possible to remove cooking residues more easily, thus avoiding these from burning the next time the appliance is used.

No special cleaning agents are required for cleaning the appliance. It is recommended to use warm water with washing liquid, a soft cloth or sponge and use a dry cloth for drying.

**Do not use any abrasive cleaning materials!**

-  Do not use steam cleaners for cleaning.

### How to clean the hob

#### Gas hobs

1. Remove pan supports and burner caps and clean them.
2. Clean the hob.
3. Refit burner caps and check that they are securely positioned.
4. While placing pan supports, take care that burners are centered to pan supports.

#### Ceramic hobs

Always rinse off fully with a clean cloth wrung out in clean water (as residue could damage the ceramic glass surface next time the hob is used).

In no case should crusts be stretched off with serrated edge knives, steel wool or the like.

Remove calcium stains (yellow staining) with small amounts of decalcifying agents such as Durgol, vinegar or lemon juice.

Apply agent with a sponge and, in the event of heavier soiling, let it work in for a longer period of time. Afterwards, wash off hob with water.

-  Sugar-based food such as custard and syrup should immediately be scraped off without waiting for the surface to cool down. Otherwise the hob may be permanently damaged.

## 7 Troubleshooting

-  Risk of explosion or poisoning by unprofessional repair. Repairs on the appliance must be carried out by an approved service centre.

### Normal operating conditions

- Smoke and smell may emit for a couple of hours during the first operation.
- When the metal parts are heated, they may expand and cause noise.

**Before you call the service, please check the following points.**

### Gas

Malfunction/problem	Possible cause	Advice/remedy
No ignition spark is produced.	No electric supply to the appliance.	Check fuses in the fuse box.
No gas is emitted.	Main gas tap is closed.	Open gas tap.
	Safety tube is bent.	Install safety tube without bends.
Burners do not burn smoothly or not at all.	Burners are dirty.	Clean burner parts.
	Burners are not dry.	Dry burner parts.
	Burner cap is not securely positioned.	Position burner correctly.
	Gas tap is closed.	Open gas tap.
	Gas container is empty (in case of LPG connection).	Replace gas container.

If the problem has not been solved:

1. Separate unit from the mains supply (deactivate or unscrew fuse).
2. Call the after-sales service of your store reseller.

-  Do not attempt to repair the appliance yourself. There are no customer service items inside the appliance.

## Free Manuals Download Website

<http://myh66.com>

<http://usermanuals.us>

<http://www.somanuals.com>

<http://www.4manuals.cc>

<http://www.manual-lib.com>

<http://www.404manual.com>

<http://www.luxmanual.com>

<http://aubethermostatmanual.com>

Golf course search by state

<http://golfingnear.com>

Email search by domain

<http://emailbydomain.com>

Auto manuals search

<http://auto.somanuals.com>

TV manuals search

<http://tv.somanuals.com>