



**G-Converter Chassis:
RMU200**

**230VAC Power Supply:
PSU200-230**

**48VDC Power Supply:
PSU200-DC**

**SNMP Management Card:
MTU200C-SNMP**

Rev 3.6

G-Converter Chassis



TECHNICAL: (0118) 965 6000

SALES: (0118) 965 5100

FAX: (0118) 965 5001

ADDRESS: 464 Basingstoke Road, Reading, Berkshire RG2 0QN

WEB: www.blackbox.co.uk

How To Contact your Local Black Box

Italy:**Black Box Italia S.P.A****Tel: 0227400280****Fax: 0227400219****Web Site: www.blackbox.it****Australia:****Black Box Catalog Australia PTY LTD****Tel: 0398797100****Fax: 0398702955****Deutschland:****Black Box Deutschland****Tel: 0811/5541-0****Fax: 0811/5541-499****Web Site: www.blackbox-deutschland.com****Brazil:****Black Box Do Brasil.****Tel: (011) 5515-4000****Fax: (011) 5515-4002****Web Site: www.blackbox.com.br****Switzerland:****Datacom Black Box Services AG****Tel: 0554517070****Fax: 0554517075****Web Site: www.black-box.ch****Canada:****Black Box Canada Corp.****Tel: 0416-736-8000****Fax: 0416-736-7348****Web Site: www.blackbox.com****Netherlands:****Black Box Datacom BV****Tel: 03032417799****Fax: 0302414746****Web Site: www.blackbox.nl/****Mexico:****Black Box De Mexico S.A. de C.V****Tel: 05-420-0100****Fax: 05-420-0123****Web Site: www.blackbox.com.mx****Belgium:****Black Box****Tel: 027258550****Fax: 027259212****Web Site: www.blackbox.be****Japan:****Black Box Catalog****Tel: 03-3820-5011****Fax: 03-3820-5010****Web Site: www.blackbox.co.jp/**

France:

Black Box Catalogue

Tel: 0145606700

Fax: 0145606747

Web Site: www.blackbox.fr

U.S.A

Black Box Corporation

Tel: 724-746-5500

Fax: 724-746-0746

Web Site: www.blackbox.com

Spain:

Black Box Comunicaciones S.A.

Tel: 34 91 663 0200

Fax: 34 91 661 84 35

Web Site: www.blackbox.es

Chile

Black Box Chile

Tel: 00 562 223 8811

Fax: 00 562 225 1002

Web Site: www.Blackbox.cl



Contents

Introduction	7
Overview	7
Manager Card	8
Manager Card LED Indication	9
Removal of Manager Card	9
Power Supplies	9
Installation.....	10
Environmental Considerations	10
Card Cage System.....	10
Manager Card	10
Power Supplies	10
Channel Cards.....	10
Management – Overview	11
Supervisor Port (terminal management)	12
Supervisor Terminal Requirements.....	12
Supervisor Terminal Emulation	12
General set-up Display Layout.....	13
General Keyboard Conventions	14
Cursor Movement	14
Parameter Changing.....	14
Accepting all changes and Updating the Configuration.....	14
Abandoning Changes	15
Changing the Configuration Page	15
Restoring the Factory Default Configuration	15
10 Base-T Port (Telnet Management).....	16
System Name	16
Location	16
IP Address	16
Subnet Mask.....	16
Gateway.....	16
Supervisor Terminal Requirements.....	17
Supervisor Terminal Emulation	17
General set-up Display Layout.....	18
General Keyboard Conventions	19
Cursor Movement	19
Parameter Changing.....	19
Accepting all changes and Updating the Configuration.....	19
Abandoning Changes	20
Changing the Configuration Page	20
Restoring the Factory Default Configuration	20
Telnet Screen.....	20



Ethernet Screen21
 IP Screen22
 Alarms Screen23
 Events Screen.....24

SNMP Management.....25
 System name25
 Location25
 IP Address25
 IP Address25
 Gateway.....25
 Supervisor Terminal Requirements.....25
 Supervisor Terminal Emulation26
 General set-up Display Layout.....26
 Typical Configuration Display.....27
 General Keyboard Conventions28
 Cursor Movement28
 Parameter Changing.....28
 Accepting all changes and Updating the Configuration.....28
 Abandoning Changes29
 Changing the Configuration Page29
 Restoring the Factory Default Configuration29

Diagnostics30
 Manager Card30
 Power Supply.....30
 Fan Assembly30
 SNMP Traps30

Appendix A- Warnings31

Appendix B –Approval Requirements33

Appendix C - EMC Requirements34

G-Converter System's Chassis

User Manual



WARNING - BEFORE INSTALLATION, PLEASE REFER TO SAFETY INSTRUCTIONS IN APPENDIX A, AND EMC INSTRUCTIONS IN APPENDIX C

Certified Compliant in the EC, when fitted with G.703/704 to X.21 interface/rate converter Data Channel cards, and in accordance with the installation instructions.

Low Voltage Directive (73/23/EEC and amendment 93/68/EEC)

EN60950 : 1992 (Safety)

Electromagnetic Compatibility directive (89/336/EEC and subsequent amendments to date):

EN55022 : 1994 (Emissions)

EN50024 : 1998 (Immunity)

Telecommunications Terminal Equipment directive (91/263/EEC and amendment 93/68/EEC) where indicated in approvals requirements section.



Introduction

This manual provides information covering installation and set-up procedures of the G-Converter Card Cage System.

Accommodation within the Card Cage System is provided for up to 18 Channel Cards; 1 Manager Card; and 2 Power Supplies. All cards may be 'hot swapped'. The Card Cage System is normally supplied with a single 40W 230V AC Power Supply Module. Additional Power Supply Modules can be supplied to meet specific requirements.

Overview

The Card Cage System, manufactured from extruded aluminium, comprises 21 slots, within a 19-inch, 3U enclosure. A PCB back plane, which provides interconnection between the front and rear sections of the Channel cards, is located towards the back of the enclosure. Channel connection is achieved by simply plugging the appropriate front and rear sections into the back plane.



G-Converter System

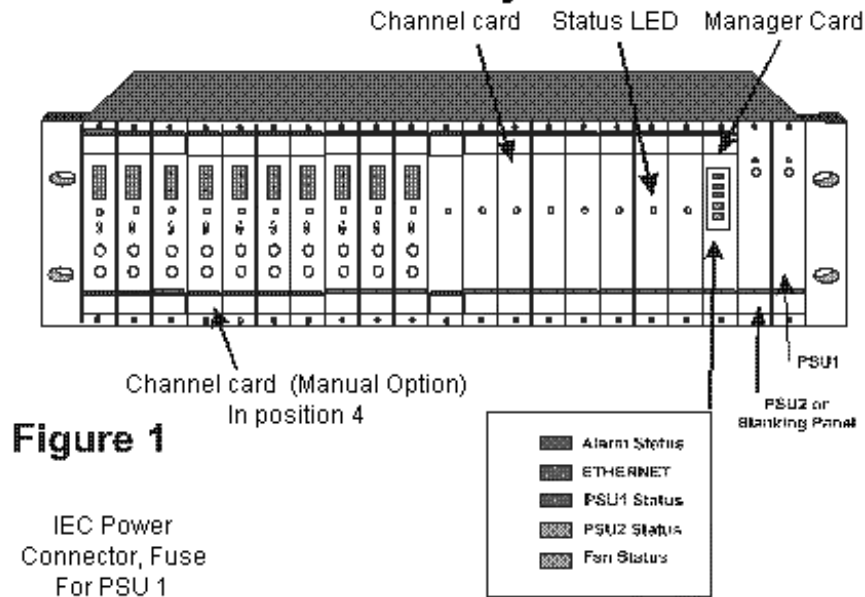

Figure 1

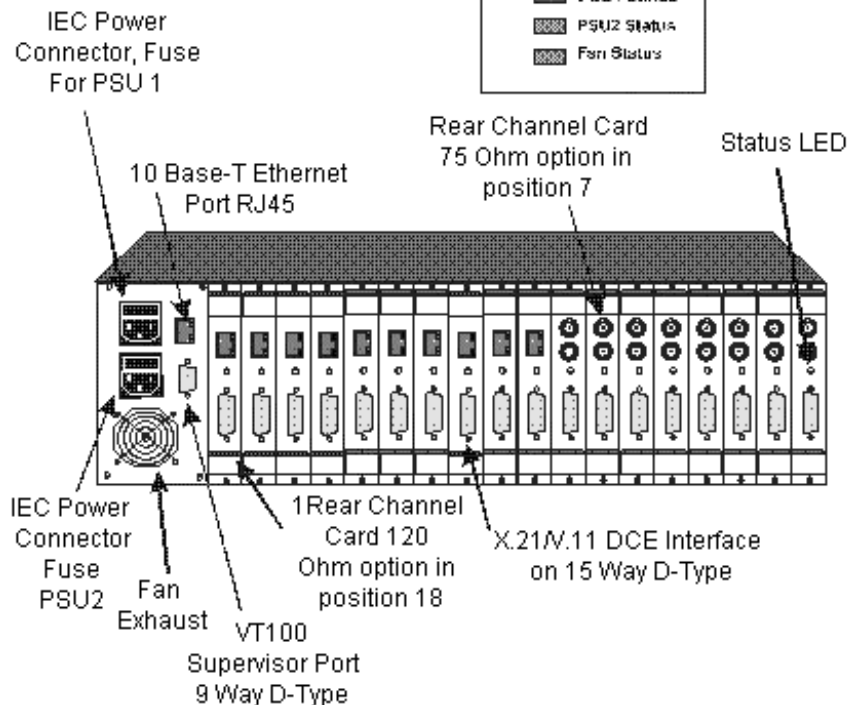

Figure 2

Manager Card

The Manager Card is a single section card that plugs into Slot 19 of the Card Cage System. This card provides the facilities for setting up and controlling all types of Data Channel Cards, additionally it is used to log and report faults on the Channel Cards, Power Supplies and Cooling Fan. Both a 10 Base-T Ethernet port and an RS232 Supervisor port are provided. Access to these ports is via the fixed rear panel of the Card Cage System.

The Manager Card is essential for controlling most types of Data Channel Cards, exceptions being the G-Converter 2.048Mbps and the G-Converter Nx64k.



The Nx64 Channel Cards are universal and may be operated with/or without a Manager Card. Rotary switches, recessed into the front panel, permit selection of the data rate in [N x 64k increments]. The selected N rate is simultaneously confirmed via the numeric display.

The 2.048Mbps Channel Cards have no set up or alarm features negating the need for the Manager Card.

Manager Card LED Indication

On the front of the Manager Card are five LEDs. In order, from top to bottom, they are:-

LED name	Function
Manager Card operational	Red = faulty, green =ok
Ethernet activity	Amber = TX and RX, green = link active, Off = no link
PSU 1 operational	Red = faulty, green =ok
PSU 2 operational	Red = faulty, green =ok
Fan operational	Red = faulty, green =ok

Removal of Manager Card

The Manager Card can only be fitted in slot 19.

The Manager Card can be ‘hot swapped’ by simply releasing the retaining screws on the top and bottom of the Manager Panel and with the aid of the injector/ejector handles withdraw the card. Simply reverse this process to install the card.

N.B if the Data Channel Cards were powered during the swapping of a Manager Card then the new Manager Card will interrogate the data channel cards for set up parameters and store these in its non volatile memory.

Power Supplies

The Card Cage provides accommodation for up to two Euro-cassette types, 40 watt, Power Supply Modules. Typically, a single Power Supply will be fitted; adding a second Power Supply reduces the probability of power failure.

The Power Supplies are connected to individually fused and filtered IEC inlets; each module is capable of powering the fully populated Card Cage. If two modules are installed loading is shared between them. In the event of one of the modules failing the other will supply the complete Power requirement of the Card Cage.

Installation

Before installation, refer to the safety warnings, approvals requirements and emc requirements in the appendices.

Environmental Considerations

The equipment must be operated under the following atmospheric conditions:

Temperature: 0 to 40 degrees centigrade.
Humidity: 0% to 90% non-condensing.

Card Cage System

The Card Cage System should be housed in a cabinet that is considered by EN60950 to be a suitable electrical and fire enclosure. *Refer to Appendix A for safety warnings.* A fixing flange is fitted to the front of the Card Cage to mount the unit into the cabinet.

Manager Card

Note: THE MANAGER CARD MUST ONLY BE PLUGGED INTO SLOT 19.

The Manager Card is connected to the 9 Way-D Supervisor Port, and the RJ45 10Base-T port, located adjacent to the fan on the rear of the Card Cage. Connection between individual Channel Cards and the Manager Card is achieved via the back plane (See Figures 1 and 2).

There are no user configurable links on the Manager Card.

Power Supplies

The Power Supplies are installed in Slots 20 and 21. Slot 21 is located on the extreme right hand side of the Card Cage, when viewing it from the front, (See Figure 1). Mains power for Slots 20 and 21 is provided by a pair of IEC connectors, the upper connector is allocated for Slot 21, the lower connector for Slot 20.

When only one Power Supply is fitted it should be into Slot 21 with mains power being supplied via the upper IEC connector. A blanking panel should be installed to cover Slot 20.

Channel Cards

Channel Cards for the Card Cage may be selected to meet several requirements; the cards are fitted into slots 1 to 18. The cards can be 'hot swapped' by simply releasing the retaining screws on the top and bottom of the panel and with the aid of the injector/ejector handles carefully withdrawing the card. Simply reverse this process to install a card.

Management – Overview

This manual deals with the set-up configurations specific to the Card Cage assembly. Configuration of the various Channel Cards available is detailed in a separate manual.

A choice of three methods is available to manage the Channel Cards: Terminal Management via the Supervisor Port, Telnet and SNMP.

Supervisor Port (terminal management)

This RS232 option is presented on a female 9 Way-D connector. It can support VT52, VT100, ADDSVP, ADM3A, H1500, N8009, and TVI920 terminal emulation modes. Selection of the required option is made on the power up screen.

Supervisor Terminal Requirements

The terminal should be configured as follows:

8 bits per character, no parity, one stop bit, speed 19.2 Kbps.

A 'modem' or 'straight' serial cable is suitable for connection of the Supervisor port (the Supervisor port pin-out is described in Appendix C).

Supervisor Terminal Emulation

The Manager Card supports several terminal emulations. When connection is made between the terminal and the RS232 Supervisor port, the following screen will appear:

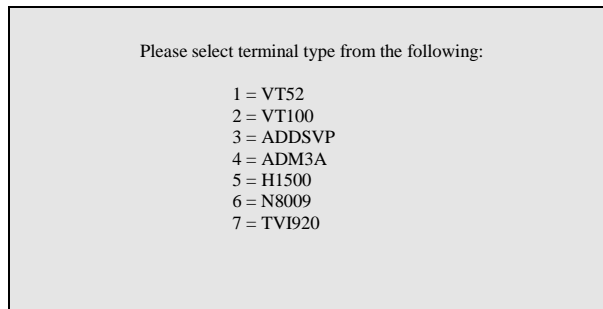

```

Please select terminal type from the following:

1 = VT52
2 = VT100
3 = ADDSVP
4 = ADM3A
5 = H1500
6 = N8009
7 = TVI920

```

The terminal type or emulation in use should be selected by pressing the relevant number key on the PC or terminal. The terminal will then show the basic configuration screen for the chassis's set-up.

You may return to this screen at any time by pressing 'CTRL' and 'E' at the same time.



General set-up Display Layout

There are three main areas on the Supervisor set-up screen used to change parameters for the Card Cage System:

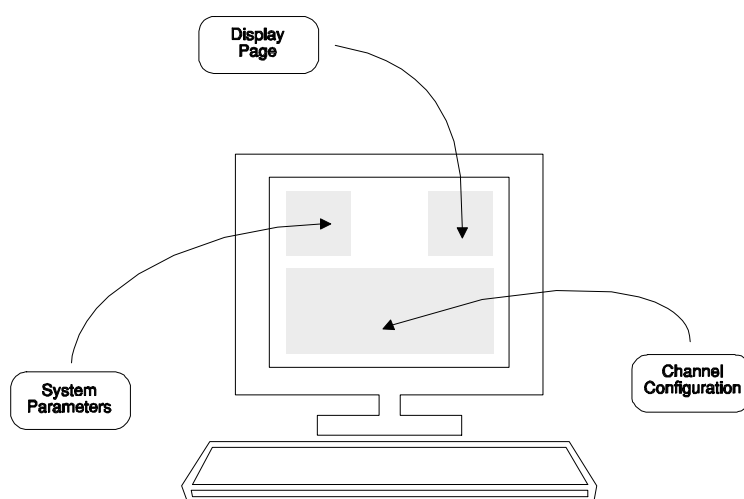

Upper left –
System parameters

Upper right –
Other **display pages** which may be selected.

Bottom –
Configuration.

```

Telnet - 10.0.0.154
Connect Edit Terminal Help
16:24 24/08/2000 Rack System U1.06
=====
System Name :>Blackbox * Slots 1-18 :
Location : Reading Ethernet :
IP Address : 10.0.0.154 IP :
Subnet Mask : 0.0.0.0 Alarms :
Gateway : 0.0.0.0 (modified) Events :
Telnet :

Slot 1 : G-SYS 1 120R, X.21 Ok Slot 10 :
Slot 2 : G-SYS 1 120R, X.21 Ok Slot 11 : G-SYS 1
Slot 3 : G-SYS 1 120R, X.21 Ok Slot 12 :
Slot 4 : Slot 13 :
Slot 5 : Slot 14 :
Slot 6 : Slot 15 : G-SYS 1 120R, X.21 Ok
Slot 7 : Slot 16 : G-SYS 1 120R, X.21 Ok
Slot 8 : Slot 17 : G-SYS 1 120R, X.21 Ok
Slot 9 : Slot 18 : G-SYS 1 120R, X.21 Er

Cursor keys to move, CTRL-U to save, ESC to abandon
=====
Enter string followed by <CR>
    
```

Typical Configuration Display

Figure 3

General Keyboard Conventions

Only a few keys are required to configure the chassis and are summarised as follows:

→ (Right arrow)	Moves the cursor to the next field to the right.
← (Left arrow)	Moves the cursor to the next field to the left.
↑ (Up arrow)	Moves the cursor to the next field upwards.
↓ (Down arrow)	Moves the cursor to the next field downwards.
+ (Plus) or <SPACEBAR>	Toggles the parameter value up to the next available setting.
- (Minus)	Toggles the parameter value down to the next available setting.
<ENTER> or <RETURN>	Accepts the current display page (otherwise the same as ↓).
<CTRL> and U	Updates all changes.
<ESC>	Abandons all changes since the last <CTRL> U.
<CTRL> and P	Refresh screen.

Cursor Movement

The cursor symbol “>” is moved around the screen to the required field using the **arrow keys**.

Parameter Changing

If it is possible to modify the field over which the cursor is placed, an appropriate message is shown at the bottom of the screen. No message will appear if the field is non-configurable.

Pressing the **Space** bar, the “+” key or the “-“ key will cycle through the choices available for a parameter.

Accepting all changes and Updating the Configuration

If “**Control**” and “**U**” are pressed at the same time after the configuration has been altered, the configuration is updated at the local and remote end as necessary and held in non-volatile Memory.

Abandoning Changes

Pressing **ESC** at any point before a configuration is updated will cause the message “**Abandon Changes? (y/n)**” to appear at the bottom of the screen. If “**n**” is selected, the message will disappear and editing may continue. If “**y**” is pressed, all modifications will be abandoned and the last updated configuration will be re-printed on the screen.

Changing the Configuration Page

The Configuration Page required, e.g. “Alarms”, is selected by moving the cursor to the **upper right area** and pressing Enter when alongside the required page. The currently selected page is indicated by a ‘*’.

Restoring the Factory Default Configuration

The system may be reset to the factory default configuration by pressing **CTRL-R** four times when the cursor is on the Terminal emulation page (see page 12). A ‘Confirm’ message will be displayed before the configuration is reset. The previous configuration will be lost.

10 Base-T Port (Telnet Management)

This method uses the 10 Base-T RJ45 (Ethernet) port. When a Telnet compatible PC is connected to this port a management platform identical to that available via the Supervisor Port is supported.

Before Telnet or SNMP management is used, it is essential that the notes relating to Supervisor Port Management be studied. (See pages12-15).

To enable SNMP or Telnet management, information must be added to the Manager Card via the Supervisor Port. The user must first set up various parameters namely IP address, Subnet Mask and Gateway.

The information required is:

System Name

A text field to identify the system. May be up to 32 characters.

Location

A text field to identify the location of the system. May be up to 32 characters.

IP Address

The IP address of the system. This must be set from the supervisor port to enable SNMP or Telnet access.

Subnet Mask

The Subnet mask of the local network. This must be set from the supervisor port before SNMP and Telnet access is required.

Gateway

The IP address of the default gateway from the local network.

To assist the process of adding this information, the relating to Supervisor port management is detailed below.



Supervisor Terminal Requirements

The terminal should be configured as follows:

8 bits per character, no parity, one stop bit, speed 19.2 Kbps.

A 'modem' or 'straight' serial cable is suitable for connection of the Supervisor port (the Supervisor port pin-out is described in Appendix C).

Supervisor Terminal Emulation

The Manager Card supports several terminal emulations. When connection is made between the terminal and the RS232 Supervisor port, the following screen will appear:

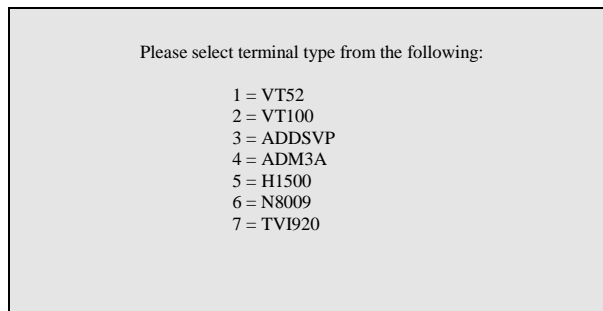

The terminal type or emulation in use should be selected by pressing the relevant number key on the PC or terminal. The terminal will then show the basic configuration screen for the chassis's set-up.

You may return to this screen at any time by pressing '**CTRL**' and '**E**' at the same time.

G-Converter Chassis

General set-up Display Layout

There are three main areas on the Supervisor set-up screen used to change parameters for the Card Cage System:

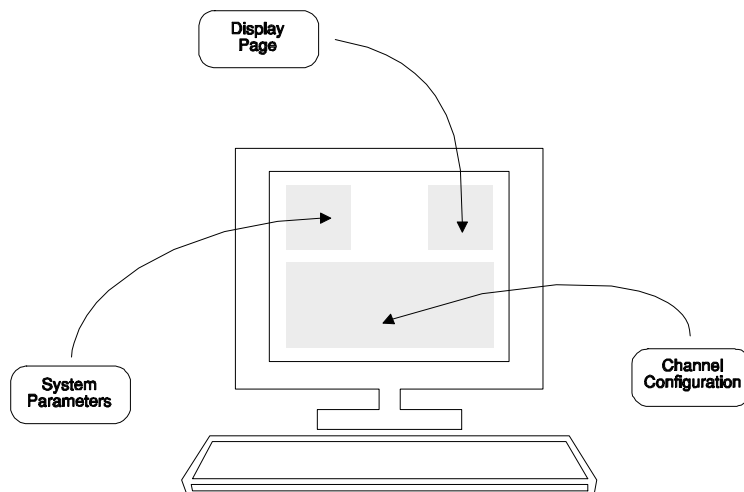

Upper left –
System parameters

Upper right –
Other **display pages** which may be selected.

Bottom –
Configuration.

```
Telnet - 10.0.0.154
Connect Edit Terminal Help
16:24 24/08/2000 Rack System U1.06
-----
System Name :>Blackbox * Slots 1-18 :
Location : Reading Ethernet :
IP Address : 10.0.0.154 IP :
Subnet Mask : 0.0.0.0 Alarms :
Gateway : 0.0.0.0 (modified) Events :
Telnet :

Slot 1 : G-SYS 1 120R, X.21 Ok Slot 10 :
Slot 2 : G-SYS 1 120R, X.21 Ok Slot 11 : G-SYS 1
Slot 3 : G-SYS 1 120R, X.21 Ok Slot 12 :
Slot 4 : Slot 13 :
Slot 5 : Slot 14 :
Slot 6 : Slot 15 : G-SYS 1 120R, X.21 Ok
Slot 7 : Slot 16 : G-SYS 1 120R, X.21 Ok
Slot 8 : Slot 17 : G-SYS 1 120R, X.21 Ok
Slot 9 : Slot 18 : G-SYS 1 120R, X.21 Er

Cursor keys to move, CTRL-U to save, ESC to abandon
-----
Enter string followed by <CR>
```

Typical Configuration Display

Figure 4

General Keyboard Conventions

Only a few keys are required to configure the chassis and are summarised as follows:

→ (Right arrow)	Moves the cursor to the next field to the right.
← (Left arrow)	Moves the cursor to the next field to the left.
↑ (Up arrow)	Moves the cursor to the next field upwards.
↓ (Down arrow)	Moves the cursor to the next field downwards.
+ (Plus) or <SPACEBAR>	Toggles the parameter value up to the next available setting.
– (Minus)	Toggles the parameter value down to the next available setting.
<ENTER> or <RETURN>	Accepts the current display page (otherwise the same as ↓).
<CTRL> and U	Updates all changes.
<ESC>	Abandons all changes since the last <CTRL> U.
<CTRL> and P	Refresh screen.

Cursor Movement

The cursor symbol “>” is moved around the screen to the required field using the **arrow keys**.

Parameter Changing

If it is possible to modify the field over which the cursor is placed, an appropriate message is shown at the bottom of the screen. No message will appear if the field is non-configurable.

Pressing the **Space** bar, the “+” key or the “-“ key will cycle through the choices available for a parameter.

Accepting all changes and Updating the Configuration

If “**Control**” and “**U**” are pressed at the same time after the configuration has been altered, the configuration is updated at the local and remote end as necessary and held in non-volatile Memory.

Abandoning Changes

Pressing **ESC** at any point before a configuration is updated will cause the message “**Abandon Changes? (y/n)**” to appear at the bottom of the screen. If “**n**” is selected the message will disappear and editing may continue. If “**y**” is pressed, all modifications will be abandoned and the last updated configuration will be re-printed on the screen.

Changing the Configuration Page

The Configuration Page required, e.g. “Alarms”, is selected by moving the cursor to the **upper right area** and pressing Enter when alongside the required page. The currently selected page is indicated by a ‘*’.

Restoring the Factory Default Configuration

The system may be reset back to the factory default configuration by pressing **CTRL-R** four times when the cursor is on the Terminal emulation page (see page 12). A ‘Confirm’ message will be displayed before the configuration is reset. The previous configuration will be lost.

Telnet Screen

```
Terminal - G-Converter System
File Edit Settings Phone Transfers Help
22:48 18/01/2000 Rack System V1.05
-----
System Name  :>                               Slots 1-18  :
Location     :                               Ethernet    :
IP Address   : 10.0.0.14                       IP          :
Subnet Mask  : 255.255.255.0                   Alarms      :
Gateway      : 0.0.0.0                         Events      :
                                           * Telnet    :

Set Password :
TCP Port     : 23
Inbound CR   : CR,LF
Outbound CR  : CR
Terminal     : ANSI
Inbound IP   : 0.0.0.0
Inbound Mask : 0.0.0.0

Cursor keys to move, CTRL-U to save, ESC to abandon
-----
Enter string followed by <CR>
```

The Telnet screen allows Telnet specific parameters to be set.

TCP Port TCP port being used (Read only)

- Inbound CR** Specify CR > CR, LF translation on input stream.
- Outbound CR** Specify CR > CR, LF translation on output stream.
- Terminal** Terminal type (Read Only)
- Inbound IP*** Telnet allowed only from this IP address
- Inbound Mask*** Mask for inbound only from this address

*Setting a bit to 1 in an inbound mask means the corresponding bits specified in Inbound IP and the IP address from which the Telnet is being established must match for a Telnet connection to be permitted.

Ethernet Screen

```

Terminal - G-Converter System
File Edit Settings Phone Transfers Help
22:51 18/01/2000 Rack System V1.05
-----
System Name :>
Location :
IP Address : 10.0.0.14
Subnet Mask : 255.255.255.0
Gateway : 0.0.0.0
Slots 1-18 :
* Ethernet :
IP :
Alarms :
Events :
Telnet :

Frames Sent : 0
Bad Frames : 0
Deferred Frames : 0
Heartbeat Errors : 0
Late Collisions : 0
Retry Limit Reached : 0
Fifo Underrun : 0
Carrier Sense Lost : 0
Frames Received : 58
Bad Frames : 0
Miss : 0
Length Violations : 0
Alignment Violations : 0
CRC Errors : 0
Fifo Overrun : 0
Late Collisions : 0

Cursor keys to move, CTRL-U to save, ESC to abandon
-----
Enter string followed by <CR>

```

The Ethernet page displays Ethernet Statistics for the unit.

IP Screen

```
Terminal - G-Converter System
File Edit Settings Phone Transfers Help
22:52 18/01/2000 Rack System V1.05
-----
System Name :>
Location :
IP Address : 10.0.0.14
Subnet Mask : 255.255.255.0
Gateway : 0.0.0.0

Slots 1-18 :
Ethernet :
* IP :
Alarms :
Events :
Telnet :

IP Packets Sent : 0
Forwards : 0
Discards : 0
No Routes : 0
Fragments OK : 0
Fragments Failed : 0
Fragments Created : 0

IP Packets Received : 44
Header Errors : 0
Address Errors : 0
Unknown Protocols : 0
Discards : 0
Reassembly Required : 0
Reassembly OKs : 0
Reassembly Fails : 0

Cursor keys to move, CTRL-U to save, ESC to abandon
-----
Enter string followed by <CR>
```

The IP page displays the IP Statistics for the unit.

The TX statistics are on the left, RX statistics on the right. The statistics shown are since power on and are self-explanatory.

Alarms Screen

```

Terminal - G-Converter System
File Edit Settings Phone Transfers Help
22:52 18/01/2000 Rack System V1.05
-----
System Name  :>
Location     :
IP Address   : 10.0.0.14
Subnet Mask  : 255.255.255.0
Gateway      : 0.0.0.0

PSU1 Fail    : None      Operational
PSU2 Fail    : None      Failed
Fan Fail     : None      Failed

Slots 1-18  :
Ethernet    :
IP          :
* Alarms    :
Events      :
Telnet      :

Cursor keys to move, CTRL-U to save, ESC to abandon
-----
Enter string followed by <CR>

```

The Alarms page shows the current alarms status of the chassis, not the individual C The level of alarm for each fault condition can be configured from here as minor. The options are;

No action:	Fault condition is not reported
Log only:	Fault condition is recorded in event log.
Minor:	as "Log only" but minor alarm is illuminated on the front panel and an SNMP trap(s) will be sent if configured.
Major:	as "Log only" but major alarm is illuminated on the front panel and an SNMP trap(s) will be sent if configured.

G-Converter Chassis

Events Screen

```
Terminal - G-Converter System
File Edit Settings Phone Transfers Help
22:52 18/01/2000 Rack System V1.05
-----
System Name :> Slots 1-18 :
Location : Ethernet :
IP Address : 10.0.0.14 IP :
Subnet Mask : 255.255.255.0 Alarms :
Gateway : 0.0.0.0 * Events :
Telnet :
Set Time :
Events :
EVO110: 20:59 17/01/2000 Configuration Update
EVO111: 20:59 17/01/2000 System Reset
EVO112: 21:07 17/01/2000 Configuration Update
EVO113: 21:07 17/01/2000 Configuration Update
EVO114: 21:09 17/01/2000 System Reset
EVO115: 21:10 17/01/2000 Configuration Update
EVO116: 21:10 17/01/2000 Configuration Update
EVO117: 22:39 17/01/2000 System Reset
EVO118: 22:41 18/01/2000 System Reset
EVO119: 22:42 18/01/2000 System Reset
-----
Cursor keys to move, CTRL-U to save, ESC to abandon
-----
Enter string followed by <CR>
```

The information given is event number, time and date and a text string detailing the nature of the event. The system clock is also set from this screen. Enter a string in the format hh—mm—ss dd/mm/yy. A two-digit year is used representing a 100-year window from 1996 to 2095.

SNMP Management

To enable SNMP or Telnet management, information must be added to the Manager Card via the Supervisor Port. The user must first set up various parameters namely IP address, Subnet Mask and Gateway.

The information required is:

System name

A text field to identify the system. May be up to 32 characters.

Location

A text field to identify the location of the system. May be up to 32 characters.

IP Address

The IP address of the system. This must be set from the Supervisor port to enable SNMP or Telnet access.

IP Address

The Subnet mask of the local network. This must be set from the Supervisor port before SNMP and Telnet access is required.

Gateway

The IP address of the default gateway from the local network.

To assist the process of adding this information, the relating to Supervisor port management is detailed below.

Supervisor Terminal Requirements

The terminal should be configured as follows:

8 bits per character, no parity, one stop bit, speed 19.2 Kbps.

A 'modem' or 'straight' serial cable is suitable for connection of the Supervisor port (the Supervisor port pin-out out is described in Appendix C).



Supervisor Terminal Emulation

The Manager Card supports several terminal emulations. When connection is made between the terminal and the RS232 Supervisor port, the following screen will appear:

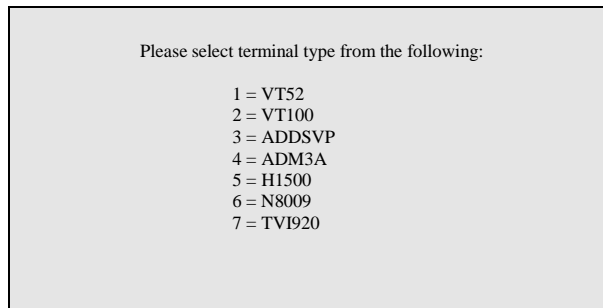

The terminal type or emulation in use should be selected by pressing the relevant number key on the PC or terminal. The terminal will then show the basic configuration screen for the chassis's set-up.

You may return to this screen at any time by pressing 'CTRL' and 'E' at the same time.

General set-up Display Layout

There are three main areas on the Supervisor set-up screen used to change parameters for the Card Cage System:

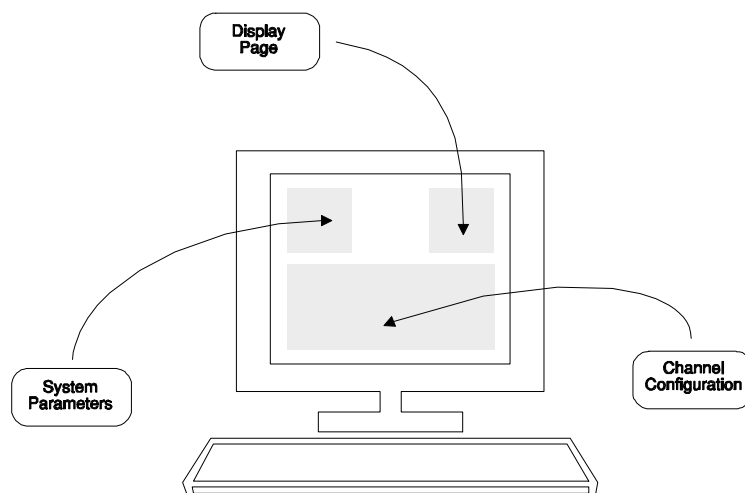

Upper left –
System parameters

Upper right –
Other **display pages** which may be selected.

Bottom –
Configuration.

Typical Configuration Display

```

Telnet - 10.0.0.154
Connect Edit Terminal Help
16:24 24/08/2000 Rack System U1.06
=====
System Name :>Blackbox * Slots 1-18 :
Location : Reading Ethernet :
IP Address : 10.0.0.154 IP :
Subnet Mask : 0.0.0.0 Alarms :
Gateway : 0.0.0.0 (modified) Events :
Telnet :

Slot 1 : G-SYS 1 120R, X.21 Ok Slot 10 :
Slot 2 : G-SYS 1 120R, X.21 Ok Slot 11 : G-SYS 1
Slot 3 : G-SYS 1 120R, X.21 Ok Slot 12 :
Slot 4 : Slot 13 :
Slot 5 : Slot 14 :
Slot 6 : Slot 15 : G-SYS 1 120R, X.21 Ok
Slot 7 : Slot 16 : G-SYS 1 120R, X.21 Ok
Slot 8 : Slot 17 : G-SYS 1 120R, X.21 Ok
Slot 9 : Slot 18 : G-SYS 1 120R, X.21 Er

Cursor keys to move, CTRL-U to save, ESC to abandon
=====
Enter string followed by <CR>

```

Figure 5

General Keyboard Conventions

Only a few keys are required to configure the chassis and are summarised as follows:

→ (Right arrow)	Moves the cursor to the next field to the right.
← (Left arrow)	Moves the cursor to the next field to the left.
↑ (Up arrow)	Moves the cursor to the next field upwards.
↓ (Down arrow)	Moves the cursor to the next field downwards.
+ (Plus) or <SPACEBAR>	Toggles the parameter value up to the next available setting.
- (Minus)	Toggles the parameter value down to the next available setting.
<ENTER> or <RETURN>	Accepts the current display page (otherwise the same as ↓).
<CTRL> and U	Updates all changes.
<ESC>	Abandons all changes since the last <CTRL> U.
<CTRL> and P	Refresh screen.

Cursor Movement

The cursor symbol “>” is moved around the screen to the required field using the **arrow keys**.

Parameter Changing

If it is possible to modify the field over which the cursor is placed, an appropriate message is shown at the bottom of the screen. No message will appear if the field is non-configurable.

Pressing the **Space** bar, the “+” key or the “-“ key will cycle through the choices available for a parameter.

Accepting all changes and Updating the Configuration

If “**Control**” and “**U**” are pressed at the same time after the configuration has been altered, the configuration is updated at the local and remote end as necessary and held in non-volatile Memory.

Abandoning Changes

Pressing **ESC** at any point before a configuration is updated will cause the message “**Abandon Changes? (y/n)**” to appear at the bottom of the screen. If “**n**” is selected the message will disappear and editing may continue. If “**y**” is pressed, all modifications will be abandoned and the last updated configuration will be re-printed on the screen.

Changing the Configuration Page

The Configuration Page required, e.g. “Alarms”, is selected by moving the cursor to the **upper right area** and pressing Enter when alongside the required page. The currently selected page is indicated by a ‘*’.

Restoring the Factory Default Configuration

The system may be reset back to the factory default configuration by pressing **CTRL-R** four times when the cursor is on the Terminal emulation page (see page 12). A ‘Confirm’ message will be displayed before the configuration is reset. The previous configuration will be lost.

This method uses the 10Base-T RJ45 port (Ethernet) port. An SNMP management package i.e. (Open View, SNMP) can be used along with the supplied MIB to manage the Card Cage System.

If additional Channel Cards are installed after the initial installation, a new MIB may be required, please contact Black Box for information

The MIB must be compiled and installed in accordance with the instructions for the specific SNMP management application being used. You should refer to the user guide for your SNMP management software for more details.

Diagnostics

For diagnostics of the Channel Cards see the relevant Data Channel Card manual.

Manager Card

The upper LED of the 5 LED display being illuminated red indicates Manager Card faults. If the Manager is suspected to be faulty, test the functionality of the card by substitution with a known working card.

Power Supply and Fan faults are also indicated on the Manager Card LED display,[the LED display is shown in the diagram at the top of Page 8], in case of failure, the LED is illuminated red.

Power Supply operation is additionally indicated by a single LED, on the front panel of the module, this LED should be green if the Card Cage is powered.

Power Supply

The Power Supply is a 40Watt universal input (88 Vac to 264 Vac) delivering 5volts to the back plane PCB. The Manager Card monitors the output voltage of the Power Supplies; a corresponding red LED on the Manager Card front panel indicates deviation outside limits. If a Power Supply Module is suspect and the chassis contains two Power Supplies then it can be 'hot swapped' with a replacement unit. To 'hot swap' a Power Supply Module, release the two retaining screws on the top and bottom of the Power Supply front panel and remove the unit. Simply reverse this process to install a card. **Ensure that if a Power Supply is removed it is allowed a minute to discharge before it is plugged back into a rack system.**

If the green LED on the Power Supply is not illuminated then check the fuse in the IEC connector. If the fuse has blown replace it with a "Little fuse" 5 x20mm 1.0A anti-surge. If the PSU blows a fuse for the second time then it is faulty and should be returned for repair.

There are no user serviceable parts within the Power Supply.

Fan Assembly

This is a high reliability component and should not fail. **Replacement of this component should only be performed by a qualified engineer. Under no circumstances should the fan be replaced while the chassis is powered.**

SNMP Traps

When managing the unit via SNMP, it is possible to configure the chassis to send SNMP Trap messages to a remote system when a fault condition occurs. Any fault conditions configured to generate a minor or major alarm will also generate Traps.

Appendix A- Warnings

WARNING: This unit is a Class one product and thus relies on the protective earth in the 230volt-AC power mains leads. Under no circumstances must the unit be operated with this earth disconnected.

INSTALLATION OF EQUIPMENT

WARNING: Installation of this equipment must only be performed by suitably trained service personnel.

This equipment allows connection only of suitable equipment to its ports, the safety status of which are defined below.

SELV Ports:

- i) 10BaseT*
- ii) Supervisor*

The above named ports are classified as SELV (Safety Extra Low Voltage) in accordance with in Clause 2.3 of EN60950 (BS7002, IEC950 as applicable), and **must only** be connected to equipment which similarly complies with the SELV safety classification.

Fire/Electrical enclosure

WARNING: To comply with the requirements of EN60950 the Card Cage System must be located in a suitable cabinet complying with the requirements of EN60950 for a fire and electrical enclosure.

Non 'hot swap' components.

WARNING: The Card Cage System has the ability to have certain cards removed whilst the unit is powered up and operating. These cards are;

- i) Manager Card front.*
- ii) Data Channel Cards front and rear*
- iii) Power Supplies front*

The Power Supply rear panel that accommodates the mains inlet connectors, fan, 10Base-T RJ45 and Supervisor D-type must under no circumstances be removed.

WARNING: **Mains accessibility**
The mains socket outlet must be installed near the equipment and must be easily accessible.

WARNING: **Exposed Mains.**
When the Power Supply Modules are removed from the Card Cage, the connector on the back plane will contain mains voltage. Do not insert anything other than a Power Supply Module into the exposed aperture of the Card Cage System.

WARNING: **Earth point.**
The central earth point for the Card Cage System is located on the right hand panel of the Card Cage (when viewed from the front) This stud is marked with an earth symbol and should on no account be tampered with.

WARNING: **Fuse Operation.**
Failure of one mains fuse will not necessarily remove mains power totally.

WARNING: **Fuse.**
Only to be replaced with a 5 x20mm 1.0A anti-surge fuse.

WARNING: **Mains Isolation**
To isolate unit form mains supply BOTH IEC sockets must be disconnected.



Appendix B –Approval Requirements

The G-Converter System carrying the BABT/CE168 assessment symbols and approval number, is approved for connection to the networks identified in this Appendix as follows:

G.703/G.704

At the time of writing three types of data channel card are approved. They are the G-Converter Card Nx64, G-Converter Card Nx64M and the G-Converter Card 2.048Mbps. They have Pan European approval to CTR12 and CTR13 (where appropriate) via RJ45 Connector (120 Ohms Balanced). The 75 Ohms unbalanced variants have approval to PD7024.

Appendix C - EMC Requirements

To ensure compliance with the EMC directive, some care must be taken to ensure that the units are installed properly, using suitable screened cables and connections. The following must be observed:

This product relies on the use of screened cables for connection to the 9 Way 'D-Type' Supervisor port. The cable must have the foil or braid screen connected effectively to the metal headshell to ensure continued compliance.

The diagram below illustrates an example of a suitable screen connection. Note how the foil or braid screen is bent back over the 'C' clip to achieve a pressure contact of the screen against the shell:

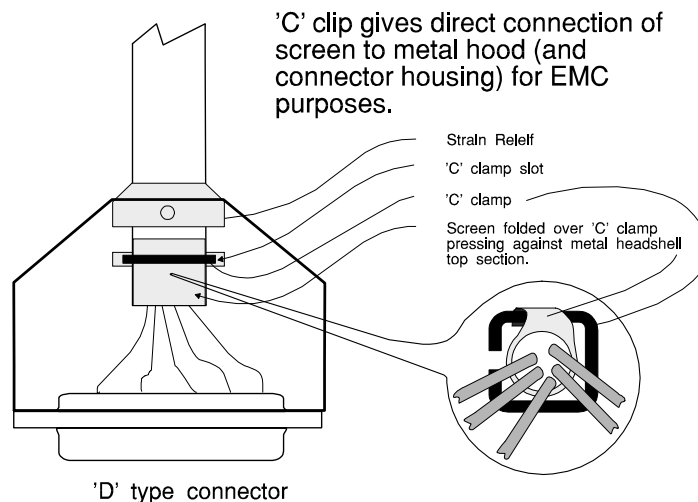

It is important to keep the screen to shell connection as short as possible.

10 Base-T Supervisor Port Connections		
Description	Type At Connector	RJ45 Socket
TxP	Output	1
TxN	Output	2
RxP	Input	3
RxN	Input	6

Supervisor Port Connections		
Description	Type At Connector	DCE – 9-Way D-Type Female Socket
DCD	Output	1
RxD	Output	2
TxD	Input	3
DTR	N/C	4
Common	GND	5
DSR	Output	6
RTS	Input	7
CTS	Output	8
RI	N/C	9



Free Manuals Download Website

<http://myh66.com>

<http://usermanuals.us>

<http://www.somanuals.com>

<http://www.4manuals.cc>

<http://www.manual-lib.com>

<http://www.404manual.com>

<http://www.luxmanual.com>

<http://aubethermostatmanual.com>

Golf course search by state

<http://golfingnear.com>

Email search by domain

<http://emailbydomain.com>

Auto manuals search

<http://auto.somanuals.com>

TV manuals search

<http://tv.somanuals.com>