

CHICAGO

Electric[®]Power Tools

19.2V 1/2" CORDLESS IMPACT WRENCH

Model 96448

SET UP AND OPERATING INSTRUCTIONS



Diagrams within this manual may not be drawn proportionally.

Due to continuing improvements, actual product may differ slightly from the product described herein.

Distributed exclusively by Harbor Freight Tools[®]

3491 Mission Oaks Blvd., Camarillo, CA 93011

Visit our website at: <http://www.harborfreight.com>



**Read this material before using this product.
Failure to do so can result in serious injury.
SAVE THIS MANUAL.**

Copyright[©] 2007 by Harbor Freight Tools[®]. All rights reserved. No portion of this manual or any artwork contained herein may be reproduced in any shape or form without the express written consent of Harbor Freight Tools.

For technical questions or replacement parts, please call 1-800-444-3353.

CONTENTS

IMPORTANT SAFETY INFORMATION	3
GENERAL SAFETY RULES	4
Work Area	4
Electrical Safety	4
Personal Safety	4
Tool Use and Care.....	5
Service	5
SPECIFIC SAFETY RULES	5
GROUNDING	7
Grounded Tools: Tools with Three Prong Plugs	7
Double Insulated Tools: Tools with Two Prong Plugs.....	8
Extension Cords	8
Symbology.....	9
SPECIFICATIONS.....	10
UNPACKING	10
SET UP INSTRUCTIONS.....	10
Tool Features.....	10
Charging	11
OPERATING INSTRUCTIONS.....	12
MAINTENANCE, AND SERVICE.....	13
Replacing the Carbon Brushes	13
Troubleshooting.....	14
PARTS LIST	15
ASSEMBLY DIAGRAM.....	16
WARRANTY	17

SAVE THIS MANUAL

Keep this manual for the safety warnings and precautions, assembly, operating, inspection, maintenance and cleaning procedures. Write the product's serial number in the back of the manual near the assembly diagram (or month and year of purchase if product has no number). Keep this manual and the receipt in a safe and dry place for future reference.

IMPORTANT SAFETY INFORMATION

In this manual, on the labeling, and all other information provided with this product:



This is the safety alert symbol. It is used to alert you to potential personal injury hazards. Obey all safety messages that follow this symbol to avoid possible injury or death.

 **DANGER**

DANGER indicates a hazardous situation which, if not avoided, will result in death or serious injury.

 **WARNING**

WARNING indicates a hazardous situation which, if not avoided, could result in death or serious injury.

 **CAUTION**

CAUTION, used with the safety alert symbol, indicates a hazardous situation which, if not avoided, could result in minor or moderate injury.

NOTICE

NOTICE is used to address practices not related to personal injury.

CAUTION

CAUTION, without the safety alert symbol, is used to address practices not related to personal injury.

GENERAL SAFETY RULES



WARNING! Read all instructions

Failure to follow all instructions listed below may result in electric shock, fire, and/or serious injury. The term “power tool” in all of the warnings listed below refers to your mains-operated (corded) power tool or battery-operated (cordless) power tool.

SAVE THESE INSTRUCTIONS

1. **Work area safety**

- a. Keep work area clean and well lit. *Cluttered or dark areas invite accidents.*
- b. Do not operate power tools in explosive atmospheres, such as in the presence of flammable liquids, gases or dust. *Power tools create sparks which may ignite the dust or fumes.*
- c. **Keep children and bystanders away while operating a power tool. Distractions can cause you to lose control.**

2. **Electrical safety**

- a. Power tool plugs must match the outlet. Never modify the plug in any way. Do not use any adapter plugs with earthed (grounded) power tools. *Unmodified plugs and matching outlets will reduce risk of electric shock.*
- b. Avoid body contact with earthed or grounded surfaces such as pipes, radiators, ranges and refrigerators. *There is an increased risk of electric shock if your body is earthed or grounded.*
- c. **Do not expose power tools to rain or wet conditions. Water entering a power tool will increase the risk of electric shock.**
- d. **Do not abuse the cord. Never use the cord for carrying, pulling or unplugging the power tool. Keep cord away from heat, oil, sharp edges or moving parts. Damaged or entangled cords increase the risk of electric shock.**

3. **Personal safety**

- a. Stay alert, watch what you are doing and use common sense when operating a power tool. Do not use a power tool while you are tired or under the influence of drugs, alcohol or medication. *A moment of inattention while operating power tools may result in serious personal injury.*
- b. **Use safety equipment. Always wear eye protection. Safety equipment such as dust mask, non-skid safety shoes, hard hat, or hearing protection used for appropriate conditions will reduce personal injuries.**
- c. Remove any adjusting key or wrench before turning the power tool on. *A wrench or a key left attached to a rotating part of the power tool may result in personal injury.*

- d. Do not overreach. Keep proper footing and balance at all times. *This enables better control of the power tool in unexpected situations.*
- e. Dress properly. Do not wear loose clothing or jewelry. Keep your hair, clothing and gloves away from moving parts. *Loose clothes, jewelry or long hair can be caught in moving parts.*

4. **Power tool use and care**

- a. Do not force the power tool. Use the correct power tool for your application. *The correct power tool will do the job better and safer at the rate for which it was designed.*
- b. Do not use the power tool if the Trigger does not turn it on and off. *Any power tool that cannot be controlled with the Trigger is dangerous and must be repaired.*
- c. **Disconnect the battery pack from the power tool before making any adjustments, changing accessories, or storing power tools. *Such preventive safety measures reduce the risk of starting the power tool accidentally.***
- d. **Store idle power tools out of the reach of children and do not allow persons unfamiliar with the power tool or these instructions to operate the power tool. *Power tools are dangerous in the hands of untrained users.***
- e. Maintain power tools. Check for misalignment or binding of moving parts, breakage of parts and any other condition that may affect the power tools operation. If damaged, have the power tool repaired before use. *Many accidents are caused by poorly maintained power tools.*
- f. Keep tools clean. *Properly maintained tools are less likely to bind and are easier to control.*
- g. Use the power tool, accessories and sockets etc., in accordance with these instructions and in the manner intended for the particular type of power tool, taking into account the working conditions and the work to be performed. *Use of the power tool for operations different from those intended could result in a hazardous situation.*

5. **Service**

- a. Have your power tool serviced by a qualified repair person using only identical replacement parts. *This will ensure that the safety of the power tool is maintained.*

SPECIFIC SAFETY RULES

- 1. Maintain labels and nameplates on the tool. These carry important safety information. If unreadable or missing, contact Harbor Freight Tools for a replacement.
- 2. Avoid unintentional starting. Prepare to begin work before turning on the tool.

3. Do not lay the tool down until it has come to a complete stop. Moving parts can grab the surface and pull the tool out of your control.
4. When using a handheld power tool, maintain a firm grip on the tool with both hands to resist starting torque.
5. Do not leave the tool unattended when it is plugged into an electrical outlet. Turn off the tool, and unplug it from its electrical outlet before leaving.
6. Use clamps (not included) or other practical ways to secure and support the workpiece to a stable platform. Holding the work by hand or against your body is unstable and may lead to loss of control.

7.  The battery charger gets hot during use. The charger's heat can build up to unsafe levels and create a fire hazard if it does not receive adequate ventilation, due to an electrical fault, or if it is used in a hot environment.

Do not place the charger on a flammable surface. Do not obstruct any vents on the charger. **Especially avoid placing the charger on carpets and rugs; they are not only flammable, but they also obstruct vents under the charger.** Place the charger on a stable, solid, nonflammable surface (such as a stable metal workbench or concrete floor) at least 1 foot away from all flammable objects, such as drapes or walls. Keep a fire extinguisher and a smoke detector in the area. Frequently monitor the charger and battery during use.

8. This product is not a toy. Keep it out of reach of children.
9. People with pacemakers should consult their physician(s) before use. Electromagnetic fields in close proximity to heart pacemaker could cause pacemaker interference or pacemaker failure. In addition, people with pacemakers should:
 - Avoid operating alone.
 - Do not use with power switch locked on.
 - Properly maintain and inspect to avoid electrical shock.
 - Any power cord must be properly grounded. Ground Fault Circuit Interrupter (GFCI) should also be implemented – it prevents sustained electrical shock.
10. Some dust created by power sanding, sawing, grinding, drilling, and other construction activities, contains chemicals known [to the State of California] to cause cancer, birth defects or other reproductive harm. Some examples of these chemicals are: Lead from lead-based paints
Crystalline silica from bricks and cement or other masonry products
Arsenic and chromium from chemically treated lumber
Your risk from these exposures varies, depending on how often you do this type of work. To reduce your exposure to these chemicals: work in a well ventilated area, and work with approved safety equipment, such as those dust masks that are specially designed to filter out microscopic particles. (California Health & Safety Code § 25249.5, *et seq.*)

11. Only use the included battery to power the Impact Wrench. Never attempt to use a battery from any other powered tool in place of the battery for this tool.
12. The warnings, precautions, and instructions discussed in this instruction manual cannot cover all possible conditions and situations that may occur. It must be understood by the operator that common sense and caution are factors which cannot be built into this product, but must be supplied by the operator.

SAVE THESE INSTRUCTIONS.

GROUNDING

WARNING

Improperly connecting the grounding wire can result in electric shock.



Check with a qualified electrician if you are in doubt as to whether the outlet is properly grounded. Do not modify the power cord plug provided with the tool. Never remove the grounding prong from the plug. Do not use the tool if the power cord or plug is damaged. If damaged, have it repaired by a service facility before use. If the plug will not fit the outlet, have a proper outlet installed by a qualified electrician.

Grounded Tools: Tools with Three Prong Plugs

1. Tools marked with “Grounding Required” have a three wire cord and three prong grounding plug. The plug must be connected to a properly grounded outlet. If the tool should electrically malfunction or break down, grounding provides a low resistance path to carry electricity away from the user, reducing the risk of electric shock. **(See 3-Prong Plug and Outlet.)**
2. The grounding prong in the plug is connected through the green wire inside the cord to the grounding system in the tool. The green wire in the cord must be the only wire connected to the tool’s grounding system and must never be attached to an electrically “live” terminal. **(See 3-Prong Plug and Outlet.)**
3. The tool must be plugged into an appropriate outlet, properly installed and grounded in accordance with all codes and ordinances. The plug and outlet should look like those in the following illustration. **(See 3-Prong Plug and Outlet.)**

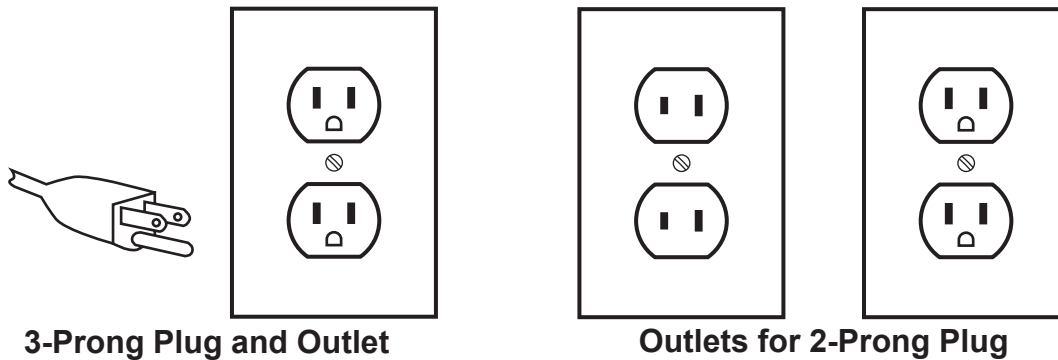

3-Prong Plug and Outlet

Outlets for 2-Prong Plug

Double Insulated Tools: Tools with Two Prong Plugs

1. Tools marked “Double Insulated” do not require grounding. They have a special double insulation system which satisfies OSHA requirements and complies with the applicable standards of Underwriters Laboratories, Inc., the Canadian Standard Association, and the National Electrical Code.
(See Outlets for 2-Prong Plug.)
2. Double insulated tools may be used in either of the 120 volt outlets shown in the preceding illustration. (See Outlets for 2-Prong Plug.)

Extension Cords



1. **Grounded** tools require a three wire extension cord. **Double Insulated** tools can use either a two or three wire extension cord.
2. As the distance from the supply outlet increases, you must use a heavier gauge extension cord. Using extension cords with inadequately sized wire causes a serious drop in voltage, resulting in loss of power and possible tool damage.
(See Table A.)
3. The smaller the gauge number of the wire, the greater the capacity of the cord. For example, a 14 gauge cord can carry a higher current than a 16 gauge cord.
(See Table A.)
4. When using more than one extension cord to make up the total length, make sure each cord contains at least the minimum wire size required. (See Table A.)
5. If you are using one extension cord for more than one tool, add the nameplate amperes and use the sum to determine the required minimum cord size.
(See Table A.)
6. If you are using an extension cord outdoors, make sure it is marked with the suffix “W-A” (“W” in Canada) to indicate it is acceptable for outdoor use.

7. Make sure the extension cord is properly wired and in good electrical condition. Always replace a damaged extension cord or have it repaired by a qualified electrician before using it.
8. Protect the extension cords from sharp objects, excessive heat, and damp or wet areas.

RECOMMENDED MINIMUM WIRE GAUGE FOR EXTENSION CORDS* (120/240 VOLT)					
NAMEPLATE AMPERES (at full load)	EXTENSION CORD LENGTH				
	25 Feet	50 Feet	75 Feet	100 Feet	150 Feet
0 – 2.0	18	18	18	18	16
2.1 – 3.4	18	18	18	16	14
3.5 – 5.0	18	18	16	14	12
5.1 – 7.0	18	16	14	12	12
7.1 – 12.0	18	14	12	10	-
12.1 – 16.0	14	12	10	-	-
16.1 – 20.0	12	10	-	-	-

TABLE A * Based on limiting the line voltage drop to five volts at 150% of the rated amperes.

Symbology

	Double Insulated	$V\sim$	Volts Alternating Current
	Canadian Standards Association	A	Amperes
	Underwriters Laboratories, Inc.	n_0 xxxx/min.	No Load Revolutions per Minute (RPM)

SPECIFICATIONS

Charger Input	120 V~, 60 Hz, 1.8 A
Charger Output	7.2 - 24 V, 1.5 A
Charge Time	1-3/4 - 2 Hours.
Speed	0-2300 RPM
Maximum Torque	220 ft-lb
Battery Cell Type	NiCd, 1700 mAh, 1.2 V, Item 96756

UNPACKING

When unpacking, check to make sure that the item is intact and undamaged. If any parts are missing or broken, please call Harbor Freight Tools at the number shown on the cover of this manual as soon as possible.

List of contents

Description	Qty
Impact Wrench	1
Charger	1
Battery	1
Replacement Carbon Brush	4

SET UP INSTRUCTIONS



Read the **ENTIRE IMPORTANT SAFETY INFORMATION** section at the beginning of this manual including all text under subheadings therein before set up or use of this product.

!WARNING

Risk of accidental starting; resulting in serious personal injury. Turn the Forward/Reverse Switch to the center, locked position and unplug the battery from the Impact Wrench before making any adjustments to the tool.

Note: For additional information regarding the parts listed in the following pages, refer to the Assembly Diagram near the end of this manual.

Tool Features

1. Always make sure the Trigger (36) of the Impact Wrench is not depressed, the Forward/Reverse Switch (32) is in the center, locked position, the Battery (37) is removed from the Impact Wrench, and the Charger (39) is unplugged from an electrical outlet prior to making any adjustments to the tool.

Trigger (36): Squeeze the Trigger to turn the Impact Wrench on and release pressure on the Trigger to turn the Impact Wrench off.

Forward/Reverse Switch (32): The Forward/Reverse Switch allows you to change the rotational direction of the Impact Wrench. For a clockwise rotation, move the Forward/Reverse Button to the right. For a counterclockwise rotation, move the Forward/Reverse Button to the left. To avoid damage to the Impact Wrench, always wait until the tool completely stops before changing rotational directions.

1/2" Drive Impact Head (7): The 1/2" Impact Head features a spring and ball to securely hold a socket.

Battery (37): The power source for the Impact Wrench is a rechargeable, 19.2 VDC Battery. Make sure to follow all safety precautions when working with the Battery.

Charger (39): The Charger is powered by plugging the Power Plug into a 120 volt, grounded, electrical outlet. NEVER attempt to power the Charger with any other electrical source other than a 120 volt, grounded electrical outlet.

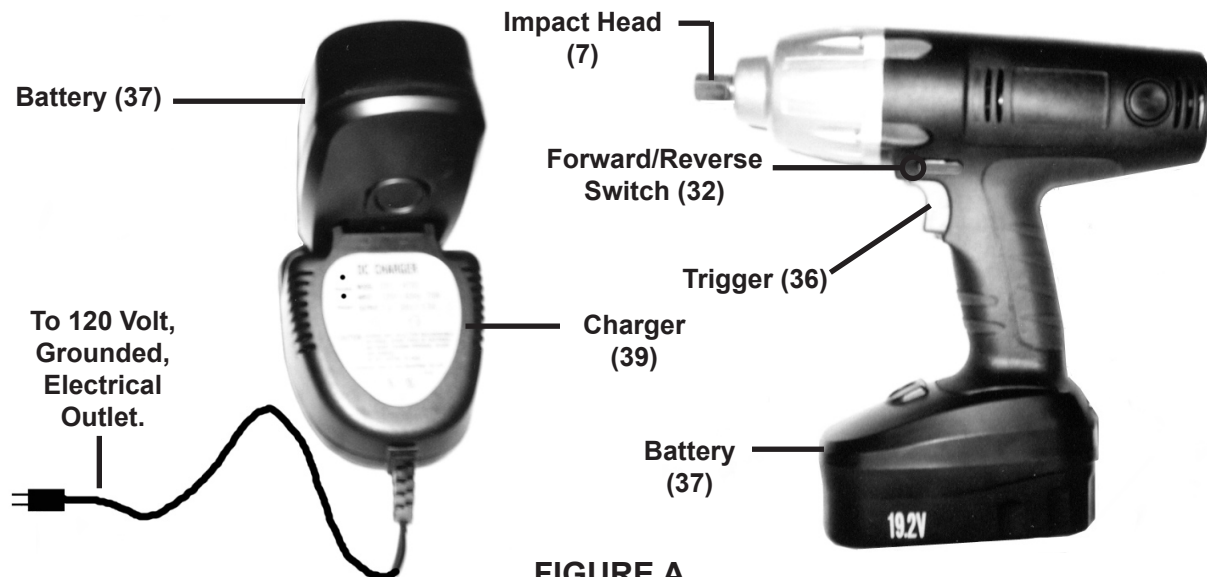

FIGURE A

Charging

1. The Battery (37) must be charged between 1-3/4 to 2 hours, prior to the first use of the Impact Wrench.
2. After first use, the Battery (37) should only be recharged when the performance of the Impact Wrench begins to diminish. Severe heat is destructive to batteries; the more heat generated, the faster the battery will lose power. A battery that gets too hot can be permanently damaged. Never discharge the battery by continuing to pull the Trigger after the tool's performance begins to diminish. Stop the tool, re-charge the battery, and use the fresh battery for optimal performance

3. When the Battery requires recharging, a 1-3/4 hour charge allows the tool to operate at full power. Do not recharge the Battery longer than 2 hours, as damage to the Battery and/or Impact Wrench will occur.
4. Slide the Battery off the handle of the Impact Wrench. Insert the Battery into the socket of the Charger (39). Then plug the Charger into the nearest 120 volt, grounded, electrical outlet.
5. Verify that the RED Charging Indicator Light comes on. If it does not illuminate, check the power connection or try a different electrical outlet. Charge the Battery for 1-3/4 hours. NOTE: When the Battery is fully charged the RED Charging Indicator Light will turn off, and the GREEN Charged Light will illuminate.
6. While charging, the Battery and Charger may become warm to the touch. This is normal and does not indicate a problem.
7. Once the Battery is fully charged, disconnect the Charger from the electrical outlet. Remove the Battery from the Charger, and insert the Battery into the handle of the Impact Wrench.

NOTE: Allow the battery to cool down before recharging it.

NOTE: To prevent accidents, turn off the tool and disconnect its power supply after use. Clean, then store the tool indoors out of children's reach.

OPERATING INSTRUCTIONS



Read the **ENTIRE IMPORTANT SAFETY INFORMATION** section at the beginning of this manual including all text under subheadings therein before set up or use of this product.

General operating instructions

1. Before installing a socket, make sure the Battery (37) is removed from the Impact Wrench to avoid accidental starting. Then, firmly insert the Socket onto the 1/2" Impact Head (7) of the tool. (See Figure A.)
2. Always fix the workpiece securely in place, using a vise or clamps (not included).
3. Insert the fully charged Battery into the handle of the Impact Wrench.
4. Use the Forward/Reverse Switch (32) to select the turning rotation of the Impact Wrench.
5. Insert the socket onto the nut that is to be loosened/tightened.
6. Hold the Impact Wrench firmly with both hands, as torque from the Motor will cause the tool to twist. Then, squeeze the Trigger (36) to turn on the Impact Wrench.

7. When finished, release the Trigger to stop the Impact Wrench. Then, remove the Battery and socket from the tool.
8. Make sure to store the Impact Wrench in a dry, clean location out of reach of children and other unauthorized people.

MAINTENANCE AND SERVICING

WARNING

Risk of serious personal injury from accidental starting or electric shock. Turn the Forward/Reverse Switch to the center, locked position and disconnect the Battery before performing any inspection, maintenance, or cleaning procedures.

Damaged equipment can fail, causing serious personal injury. Do not use damaged equipment. If abnormal noise or vibration occurs, have the problem corrected before further use.

Cleaning and Maintenance

1. **BEFORE EACH USE**, inspect the general condition of the tool. Check for loose screws, misalignment or binding of moving parts, cracked or broken parts, damaged electrical wiring, and any other condition that may affect its safe operation.
2. **AFTER USE**, clean external surfaces of the tool with clean, moist cloth.
3. **WARNING! If the supply cord of this power tool is damaged, it must be replaced only by a qualified service technician.**
4. Dispose of the rechargeable NiCd battery according to State, Local and Federal regulations. Contact a local recycling center for disposal directions.

Replacing the Carbon Brushes

1. It may become necessary at sometime to replace or clean the two Carbon Brushes (29) when the Motor performance decreases, or stops working completely.
2. Remove the two Brush Holder Caps (28), then the two Carbon Brushes (29), keeping track of the orientation and location of each.
3. If either Carbon Brush is worn more than halfway, replace both Carbon Brushes. If the Carbon Brushes are just dirty, however, they may be cleaned by rubbing them with a pencil eraser. If cleaning used brushes, try to install them in the same holders and orientation as when they were removed.

4. When installing the Carbon Brushes, make sure the carbon portion of the Carbon Brushes contact the Motor's Rotor and that the springs face away from the Motor. Also, make sure the springs operate freely.
5. After replacement or cleaning, replace the two Brush Holder Caps.

NOTE: New Carbon Brushes tend to arc or spark until they wear and conform to the Motor's Rotor.

Troubleshooting

Problem	Possible Causes	Possible Solutions
Trigger Switch locked in place.	1. Forward/Reverse Switch is in center position.	1. Move button to the left or right for forward or reverse operation.
Impact Wrench operates slowly or without force.	1. Battery weak.	1. Recharge Battery completely.
Impact Wrench does not turn on.	1. Battery completely discharged.	1. Recharge Battery completely.
Battery will not hold charge.	1. Battery dead.	1. Replace with new Battery.

PLEASE READ THE FOLLOWING CAREFULLY

THE MANUFACTURER AND/OR DISTRIBUTOR HAS PROVIDED THE PARTS LIST AND ASSEMBLY DIAGRAM IN THIS MANUAL AS A REFERENCE TOOL ONLY. NEITHER THE MANUFACTURER OR DISTRIBUTOR MAKES ANY REPRESENTATION OR WARRANTY OF ANY KIND TO THE BUYER THAT HE OR SHE IS QUALIFIED TO MAKE ANY REPAIRS TO THE PRODUCT, OR THAT HE OR SHE IS QUALIFIED TO REPLACE ANY PARTS OF THE PRODUCT. IN FACT, THE MANUFACTURER AND/OR DISTRIBUTOR EXPRESSLY STATES THAT ALL REPAIRS AND PARTS REPLACEMENTS SHOULD BE UNDERTAKEN BY CERTIFIED AND LICENSED TECHNICIANS, AND NOT BY THE BUYER. THE BUYER ASSUMES ALL RISK AND LIABILITY ARISING OUT OF HIS OR HER REPAIRS TO THE ORIGINAL PRODUCT OR REPLACEMENT PARTS THERETO, OR ARISING OUT OF HIS OR HER INSTALLATION OF REPLACEMENT PARTS THERETO.

PARTS LIST

Part	Description
1	Screw (1)
2	Washer (1)
3	Front Cover
4	Bearing
5	Rubber Washer
6	Plate Washer
7	Impact Head
8	Impact Shaft
9	Bearing (1)
10	Torque Spring
11	Buffer Pad
12	Spring Pad
13	Master Impact Driver
14	Steel Ball
15	Planetary Gear
16	Straight Pin
17	Bearing Pad
18	Bearing (2)
19	Inner Rim
20	Rim Shaft

Part	Description
21	Bearing (3)
22	Armature
23	Plate
24	Washer (2)
25	Stator
26	Bearing (2)
27	Carbon Brush Shaft
28	Brush Holder Cap
29	Carbon Brush
30	Brush Holder
31	Connector
32	Forward/Reverse Switch
33	Right Body
34	Left Body
35	Carrying Strap
36	Trigger
37	Battery
38	Screw (2)
39	Charger (not shown)

ASSEMBLY DIAGRAM

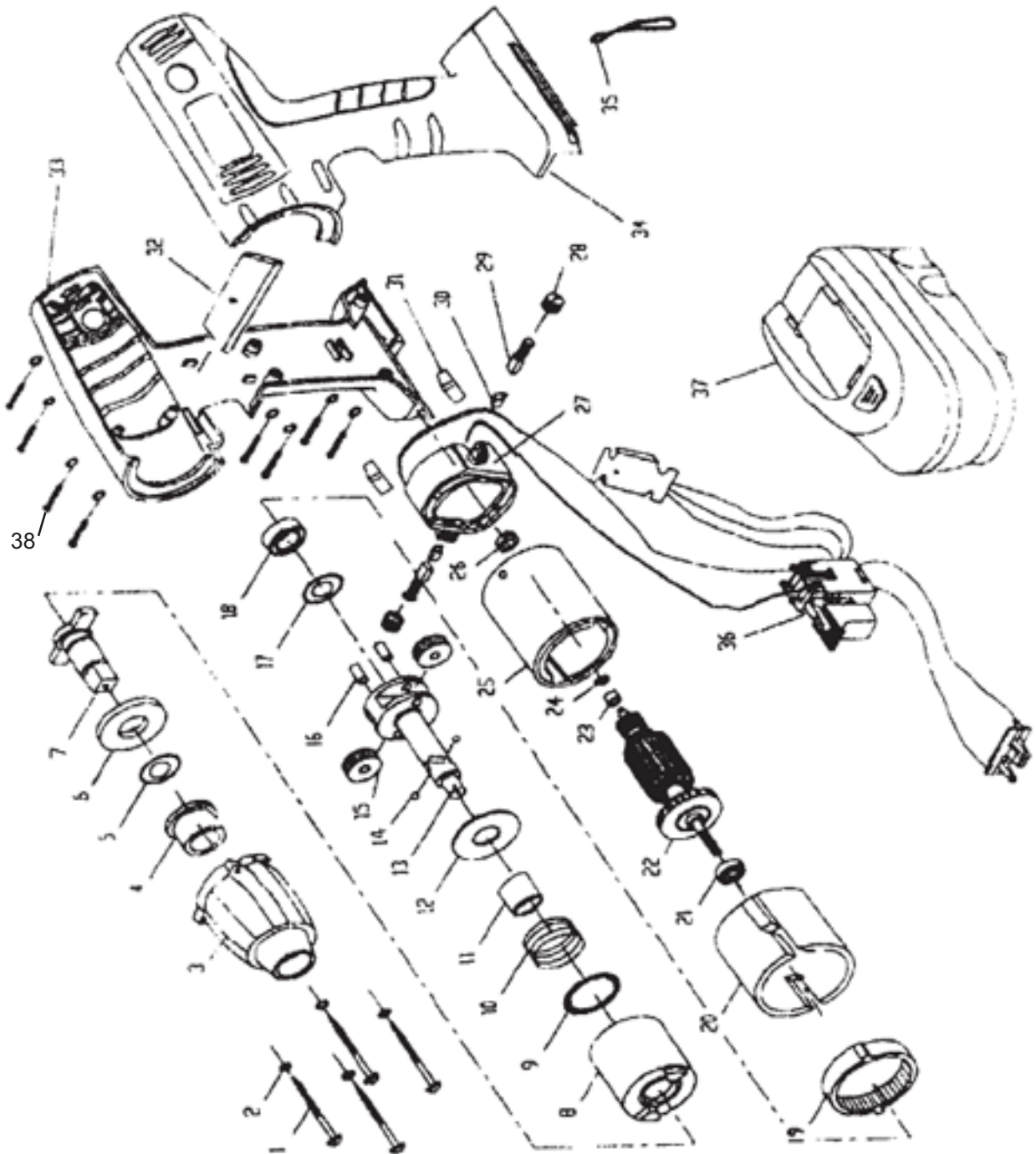

Record Product's Serial Number Here: _____

Note: If product has no serial number, record month and year of purchase instead.

Note: Some parts are listed and shown for illustration purposes only, and are not available individually as replacement parts.

LIMITED 90 DAY WARRANTY

Harbor Freight Tools Co. makes every effort to assure that its products meet high quality and durability standards, and warrants to the original purchaser that this product is free from defects in materials and workmanship for the period of 90 days from the date of purchase. This warranty does not apply to damage due directly or indirectly, to misuse, abuse, negligence or accidents, repairs or alterations outside our facilities, criminal activity, improper installation, normal wear and tear, or to lack of maintenance. We shall in no event be liable for death, injuries to persons or property, or for incidental, contingent, special or consequential damages arising from the use of our product. Some states do not allow the exclusion or limitation of incidental or consequential damages, so the above limitation of exclusion may not apply to you. THIS WARRANTY IS EXPRESSLY IN LIEU OF ALL OTHER WARRANTIES, EXPRESS OR IMPLIED, INCLUDING THE WARRANTIES OF MERCHANTABILITY AND FITNESS.

To take advantage of this warranty, the product or part must be returned to us with transportation charges prepaid. Proof of purchase date and an explanation of the complaint must accompany the merchandise. If our inspection verifies the defect, we will either repair or replace the product at our election or we may elect to refund the purchase price if we cannot readily and quickly provide you with a replacement. We will return repaired products at our expense, but if we determine there is no defect, or that the defect resulted from causes not within the scope of our warranty, then you must bear the cost of returning the product.

This warranty gives you specific legal rights and you may also have other rights which vary from state to state.

3491 Mission Oaks Blvd. • PO Box 6009 • Camarillo, CA 93011 • (800) 444-3353

Free Manuals Download Website

<http://myh66.com>

<http://usermanuals.us>

<http://www.somanuals.com>

<http://www.4manuals.cc>

<http://www.manual-lib.com>

<http://www.404manual.com>

<http://www.luxmanual.com>

<http://aubethermostatmanual.com>

Golf course search by state

<http://golfingnear.com>

Email search by domain

<http://emailbydomain.com>

Auto manuals search

<http://auto.somanuals.com>

TV manuals search

<http://tv.somanuals.com>