

# CHICAGO

## Electric Power Tools

### 3/8" SINGLE SPEED, ELECTRIC DRILL

Model 46804

#### ASSEMBLY AND OPERATING INSTRUCTIONS



**TO PREVENT SERIOUS INJURY,  
READ AND UNDERSTAND ALL WARNINGS  
AND INSTRUCTIONS BEFORE USE.**

3491 Mission Oaks Blvd., Camarillo, CA 93011  
Visit our Web site at: <http://www.harborfreight.com>

Copyright © 2004 by Harbor Freight Tools®. All rights reserved. No portion of this manual or any artwork contained herein may be reproduced in any shape or form without the express written consent of Harbor Freight Tools.

**For technical questions and replacement parts, please call 1-800-444-3353.**

## PRODUCT SPECIFICATIONS

Power Requirements	120 VAC, 60 Hz, Single Phase, 3.8 Amps
No Load Speed	2800 RPM
Drilling Capacity	Wood - 1", Metal - 3/8"
Weight	2.8 Lbs.
Features: Reversible, Single Speed, Fan-Cooled Motor, Keyed Chuck.	



## SAVE THIS MANUAL

You will need this manual for the safety warnings and precautions, assembly, operating, inspection, maintenance and cleaning procedures, parts list and assembly diagram. Keep your invoice with this manual. Write the invoice number on the inside of the front cover. Keep this manual and invoice in a safe and dry place for future reference.

## GENERAL SAFETY RULES

### WARNING!

**READ AND UNDERSTAND ALL INSTRUCTIONS**  
Failure to follow all instructions listed below may result in  
electric shock, fire, and/or serious injury.  
**SAVE THESE INSTRUCTIONS**

### WORK AREA

1. **Keep your work area clean and well lit.** Cluttered benches and dark areas invite accidents.
2. **Do not operate power tools in explosive atmospheres, such as in the presence of flammable liquids, gases, or dust.** Power tools create sparks which may ignite the dust or fumes.
3. **Keep bystanders, children, and visitors away while operating a power tool.** Distractions can cause you to lose control. Protect others in the work area from debris such as chips and sparks. Provide barriers or shields as needed.

## ELECTRICAL SAFETY

4. **Grounded tools must be plugged into an outlet properly installed and grounded in accordance with all codes and ordinances. Never remove the grounding prong or modify the plug in any way. Do not use any adapter plugs. Check with a qualified electrician if you are in doubt as to whether the outlet is properly grounded.** If the tools should electrically malfunction or break down, grounding provides a low resistance path to carry electricity away from the user.
5. **Double insulated tools are equipped with a polarized plug (one blade is wider than the other). This plug will fit in a polarized outlet only one way. If the plug does not fit fully in the outlet, reverse the plug. If it still does not fit, contact a qualified electrician to install a polarized outlet. Do not change the plug in any way.** Double insulation  eliminates the need for the three wire grounded power cord and grounded power supply system.
6. **Avoid body contact with grounded surfaces such as pipes, radiators, ranges, and refrigerators.** There is an increased risk of electric shock if your body is grounded.
7. **Do not expose power tools to rain or wet conditions.** Water entering a power tool will increase the risk of electric shock.
8. **Do not abuse the Power Cord. Never use the Power Cord to carry the tools or pull the Plug from an outlet. Keep the Power Cord away from heat, oil, sharp edges, or moving parts. Replace damaged Power Cords immediately.** Damaged Power Cords increase the risk of electric shock.
9. **When operating a power tool outside, use an outdoor extension cord marked “W-A” or “W”.** These extension cords are rated for outdoor use, and reduce the risk of electric shock.

## PERSONAL SAFETY

10. **Stay alert. Watch what you are doing, and use common sense when operating a power tool. Do not use a power tool while tired or under the influence of drugs, alcohol, or medication.** A moment of inattention while operating power tools may result in serious personal injury.
11. **Dress properly. Do not wear loose clothing or jewelry. Contain long hair. Keep your hair, clothing, and gloves away from moving parts.** Loose clothes, jewelry, or long hair can be caught in moving parts.

12. **Avoid accidental starting. Be sure the Power Switch is off before plugging in.** Carrying power tools with your finger on the Trigger invites accidents.
13. **Remove adjusting keys or wrenches before turning the power tool on.** A wrench or a key that is left attached to a rotating part of the power tool may result in personal injury.
14. **Do not overreach. Keep proper footing and balance at all times.** Proper footing and balance enables better control of the power tool in unexpected situations.
15. **Use safety equipment. Always wear ANSI approved eye protection.** Dust mask, non-skid safety shoes, hard hat, or hearing protection must be used for appropriate conditions.

#### TOOL USE AND CARE

16. **Use clamps (not included) or other practical ways to secure and support the workpiece to a stable platform.** Holding the work by hand or against your body is unstable and may lead to loss of control.
17. **Do not force the tool. Use the correct tool for your application.** The correct tool will do the job better and safer at the rate for which it is designed.
18. **Do not use the power tool if the Trigger does not turn it on or off.** Any tool that cannot be controlled with the Power Switch is dangerous and must be replaced.
19. **Disconnect the Power Cord Plug from the power source before making any adjustments, changing accessories, or storing the tool.** Such preventive safety measures reduce the risk of starting the tool accidentally.
20. **Store idle tools out of reach of children and other untrained persons.** Tools are dangerous in the hands of untrained users.
21. **Maintain tools with care. Keep cutting tools sharp and clean.** Properly maintained tools with a sharp cutting bits are less likely to bind and are easier to control. Do not use a damaged tool. Tag damaged tools "Do not use" until repaired.
22. **Check for misalignment or binding of moving parts, breakage of parts, and any other condition that may affect the tool's operation. If damaged, have the tool serviced before using.** Many accidents are caused by poorly maintained tools.



23. **Use only accessories that are recommended by the manufacturer for your model.** Accessories that may be suitable for one tool may become hazardous when used on another tool.

### SERVICE

24. **Tool service must be performed only by qualified repair personnel.** Service or maintenance performed by unqualified personnel could result in a risk of injury.
25. **When servicing a tool, use only identical replacement parts. Follow instructions in the “*Inspection, Maintenance, And Cleaning*” section of this manual.** Use of unauthorized parts or failure to follow maintenance instructions may create a risk of electric shock or injury.

## SPECIFIC SAFETY RULES

1. **Hold tool by insulated gripping surfaces when performing an operation where cutting tools may contact hidden wiring or its own cord. Contact with a ‘live’ wire will make exposed metal parts on the tool ‘live’ and shock the operator.**
2. **Maintain labels and nameplates on the Drill.** These carry important information. If unreadable or missing, contact Harbor Freight Tools for a replacement.
3. **Always wear safety impact goggles and heavy work gloves when using the Drill.** Using personal safety devices reduce the risk for injury. Safety impact eye goggles and heavy work gloves are available from Harbor Freight Tools.
4. **Maintain a safe working environment.** Keep the work area well lit. Make sure there is adequate surrounding workspace. Always keep the work area free of obstructions, grease, oil, trash, and other debris. Do not use a power tool in areas near flammable chemicals, dusts, and vapors. Do not use this product in a damp or wet location.
5. **Make sure to read and understand all instructions and safety precautions as outlined in the manufacturer’s manual for the drill.**
6. **When using a hand-held power tool, always maintain a firm grip on the tool with both hands to resist starting torque.**
7. **Always keep the extension cord away from moving parts on the tool.**
8. **Avoid unintentional starting.** Make sure you are prepared to begin work before turning on the Drill.

9. **Make sure the Drill bit being used is free from burrs and any other foreign matter which could damage the tool.**
10. **Never leave the Drill unattended when it is plugged into an electrical outlet.** Turn off the tool, and unplug it from its electrical outlet before leaving.
11. **Always unplug the Drill from its electrical outlet before performing and inspection, maintenance, or cleaning procedures.**
12. **Let Bits cool before touching changing or adjusting them.** Bits heat up dramatically while in use, and are capable of severe burns.
13. **Do not force the Drill.** This tool will do the work better and safer at the speed and capacity for which it was designed.
14. **Always secure the workpiece in a vise or other appropriate device; never attempt to hold the workpiece in your hand while drilling.**
15.  **WARNING!** People with pacemakers should consult their physician(s) before using this product. Electromagnetic fields in close proximity to a heart pacemaker could cause interference to or failure of the pacemaker.
16.  **WARNING!** Some dust created by power sanding, sawing, grinding, drilling, and other construction activities, contain chemicals known (to the State of California) to cause cancer, birth defects or other reproductive harm. Some examples of these chemicals are: lead from lead-based paints, crystalline silica from bricks and cement or other masonry products, arsenic and chromium from chemically treated lumber. Your risk from these exposures varies, depending on how often you do this type of work. To reduce your exposure to these chemicals: work in a well ventilated area, and work with approved safety equipment, such as those dust masks that are specially designed to filter out microscopic particles.  
(California Health & Safety Code 25249.5, et seq.)

## GROUNDING

### WARNING!

Improperly connecting the grounding wire can result in the risk of electric shock. Check with a qualified electrician if you are in doubt as to whether the outlet is properly grounded. Do not modify the power cord plug provided with the tool. Never remove the grounding prong from the plug. Do not use the tool if the power cord or plug is damaged. If damaged, have it repaired by a service facility before use. If the plug will not fit the outlet, have a proper outlet installed by a qualified electrician.

### GROUNDING TOOLS: TOOLS WITH THREE PRONG PLUGS

1. Tools marked with “Grounding Required” have a three wire cord and three prong grounding plug. The plug must be connected to a properly grounded outlet. If the tool should electrically malfunction or break down, grounding provides a low resistance path to carry electricity away from the user, reducing the risk of electric shock. **(See Figure A.)**
2. The grounding prong in the plug is connected through the green wire inside the cord to the grounding system in the tool. The green wire in the cord must be the only wire connected to the tool’s grounding system and must never be attached to an electrically “live” terminal. **(See Figure A.)**
3. Your tool must be plugged into an appropriate outlet, properly installed and grounded in accordance with all codes and ordinances. The plug and outlet should look like those in the following illustration. **(See Figure A.)**

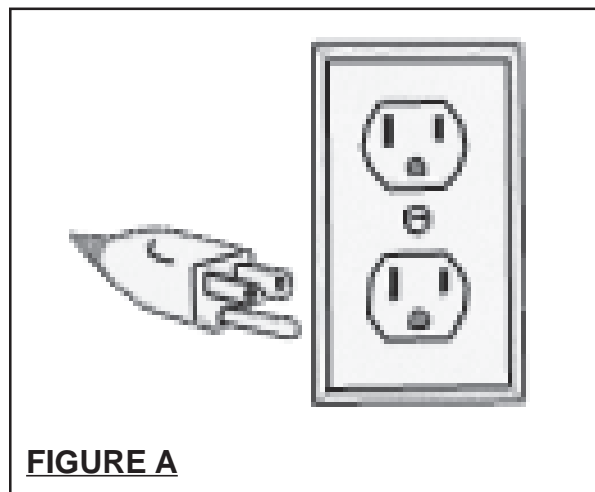

## DOUBLE INSULATED TOOLS: TOOLS WITH TWO PRONG PLUGS

**Note: This Drill has a Two Prong Plug.**

4. Tools marked "Double Insulated" do not require grounding. They have a special double insulation system which satisfies OSHA requirements and complies with the applicable standards of Underwriters Laboratories, Inc., the Canadian Standard Association, and the National Electrical Code. **(See Figure B.)**
5. Double insulated tools may be used in either of the 120 volt outlets shown in the following illustration. **(See Figure B.)**

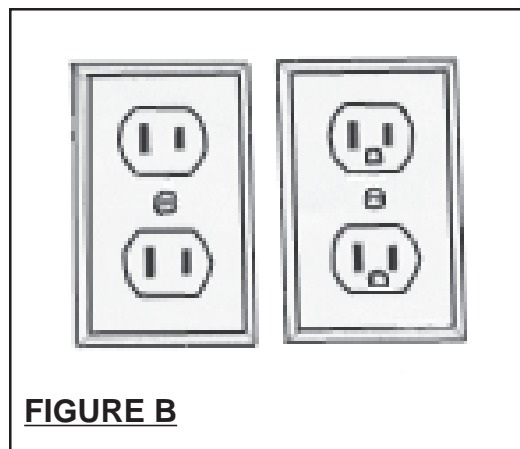

## EXTENSION CORDS

1. **Grounded** tools require a three wire extension cord. **Double Insulated** tools can use either a two or three wire extension cord.
2. As the distance from the supply outlet increases, you must use a heavier gauge extension cord. Using extension cords with inadequately sized wire causes a serious drop in voltage, resulting in loss of power and possible tool damage. **(See Figure C, next page.)**
3. The smaller the gauge number of the wire, the greater the capacity of the cord. For example, a 14 gauge cord can carry a higher current than a 16 gauge cord. **(See Figure C.)**
4. When using more than one extension cord to make up the total length, make sure each cord contains at least the minimum wire size required. **(See Figure C.)**
5. If you are using one extension cord for more than one tool, add the nameplate amperes and use the sum to determine the required minimum cord size. **(See Figure C.)**

SKU 46804 For technical questions, please call 1-800-444-3353.

Page 8





6. If you are using an extension cord outdoors, make sure it is marked with the suffix "W-A" ("W" in Canada) to indicate it is acceptable for outdoor use.
7. Make sure your extension cord is properly wired and in good electrical condition. Always replace a damaged extension cord or have it repaired by a qualified electrician before using it.
8. Protect your extension cords from sharp objects, excessive heat, and damp or wet areas.

<b>RECOMMENDED MINIMUM WIRE GAUGE FOR EXTENSION CORDS*</b> <b>(120 VOLT)</b>					
<b>NAMEPLATE AMPERES (At Full Load)</b>	<b>EXTENSION CORD LENGTH</b>				
	<b>25 FEET</b>	<b>50 FEET</b>	<b>75 FEET</b>	<b>100 FEET</b>	<b>150 FEET</b>
<b>0 - 2.0</b>	<b>18</b>	<b>18</b>	<b>16</b>	<b>16</b>	<b>16</b>
<b>2.1 - 3.4</b>	<b>18</b>	<b>18</b>	<b>16</b>	<b>14</b>	<b>14</b>
<b>3.5 - 5.0</b>	<b>18</b>	<b>18</b>	<b>16</b>	<b>14</b>	<b>12</b>
<b>5.1 - 7.0</b>	<b>18</b>	<b>16</b>	<b>14</b>	<b>12</b>	<b>12</b>
<b>7.1 - 12.0</b>	<b>16</b>	<b>14</b>	<b>12</b>	<b>10</b>	<b>-</b>
<b>12.1 - 16.0</b>	<b>14</b>	<b>12</b>	<b>10</b>	<b>-</b>	<b>-</b>
<b>16.1 - 20.0</b>	<b>12</b>	<b>10</b>	<b>-</b>	<b>-</b>	<b>-</b>

**FIGURE C**                      \*Based on limiting the line voltage drop to five volts at 150% of the rated amperes.

## SYMBOLOLOGY

	<b>Double Insulated</b>
	<b>Canadian Standards Association</b>
	<b>Underwriters Laboratories, Inc.</b>
<b>V ~</b>	<b>Volts Alternating Current</b>
<b>A</b>	<b>Amperes</b>
<b>n<sub>o</sub>xxxx/min.</b>	<b>No Load Revolutions per Minute (RPM)</b>

## UNPACKING

When unpacking, check to make sure all the parts shown on the **Parts List on page 14** are included. If any parts are missing or broken, please call Harbor Freight Tools at the number shown on the cover of this manual as soon as possible.

## OPERATING INSTRUCTIONS

**NOTE:** For additional information regarding the parts listed in the following pages, refer to the **Assembly Diagram on page 15**.

**Warning!! Always wear ANSI approved safety glasses and full face shield when operating your Drill. Failure to do so could result in dust, shavings, or loose particles being thrown into your eyes.**

**CAUTION:** Always make sure the Power Cord of the Drill is unplugged from its electrical outlet *prior* to making any adjustments to the tool.

FIGURE 1

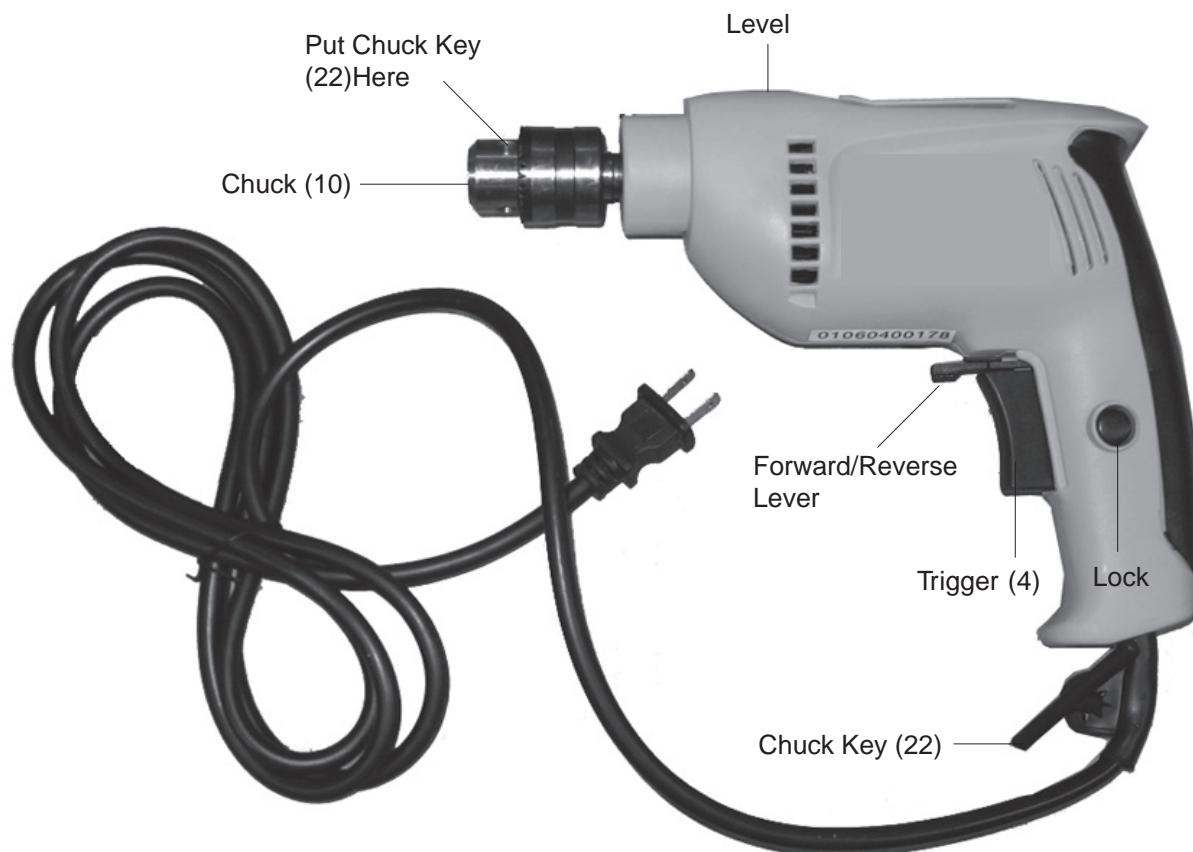

## OPERATING INSTRUCTIONS (continued)

**To Install Bits:** See **FIGURE 1** on page ten and **FIGURE 2** below.

1. Insert the Chuck Key (22) in one of the holes on the Chuck (10) and turn it counterclockwise to open the jaws of the Chuck (10).
2. Insert a bit (not included). Keep the bit straight as you turn the Chuck Key (22) clockwise to close the jaws of the Chuck (22). Once tightened, visually check to see if it is in straight. If not, repeat the process and straighten the bit. When it is straight, use the Chuck Key (22) to tighten the Chuck (10).
3. To remove a bit (not included), insert the Chuck Key (22) in a Chuck Hole and turn it counterclockwise until the jaws open and release the bit.

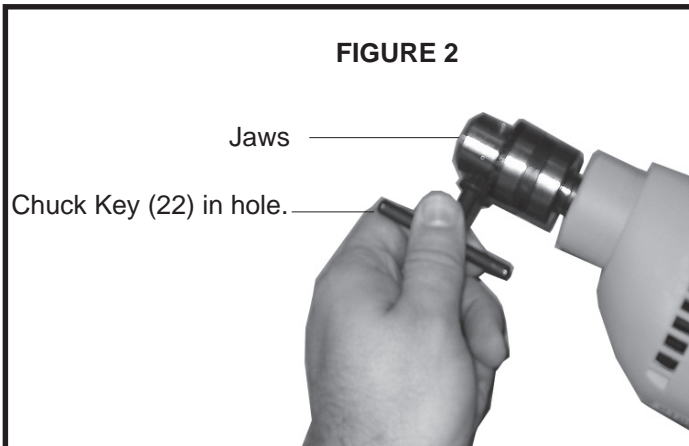

### Using the Lock Button

When you are drilling for extended times and want to take your finger off of the Trigger, use the Lock Button.

Squeeze the Trigger to start the drill, then push the Lock Button. The drill will stay on. When you are finished, just squeeze and release the Trigger to stop the drill.

See **FIGURE 1** on page 10.

**Note:** Always use sharp bits. Dull or damaged bits may cause undue stress on the drill and possibly break, causing injury. Bits are available at Harbor Freight Tools.

**Note:** When holding the drill in your hand, the Forward/Reverse Lever points toward the right and the unit will drill forward. When it is pointed to the left, the unit will drill in reverse. See **FIGURE 1** on page 10. The Forward/Reverse Lever does not act as a locking mechanism. To lock Trigger, see “Using the Lock Button” above.

**Note:** To ensure you are drilling or driving screws on a level plane, use the built-in level on the top of the Drill.

## OPERATING INSTRUCTIONS (continued)

**When drilling wood:** Place the bit at the point to be drilled. If you are drilling a hard, smooth surface, use a punch to mark the drill location. Set the Forward/Reverse Lever to forward (right). Grasp the handle firmly and slowly squeeze the Trigger (4). Never force the tool. Only apply light pressure when drilling. To stop drilling, release the Trigger. **Note:** The further you pull back on the Trigger (4), the faster the bit will rotate. Maximum drilling depth capacity for wood is 1 inch.

**Metal Drilling: Always wear work gloves when handling sheet metal.**

Always clamp sheet metal. Use a punch to mark the position of the hole. When used, light machine oil will prolong the life of the bit and increase drilling action. With steel, use oil as a lubricant; aluminum, use turpentine or paraffin; brass, copper and cast iron, use no lubricant. Do not force the tool. Start slowly and let the weight of the tool do the job. Apply only light pressure for horizontal drilling. Maximum drilling depth capacity for metal is 3/8 of an inch.

**Plastic and plastic coated chipboard:**

Use high speed steel drill bits and refer to the wood drilling section on this page.

**Warning!** If the bit jams in a workpiece, or if the drill stalls, stop the tool and immediately unplug it. Determine the reason for jamming before resuming. To remove a bit, reverse the direction by turning the Forward/Reverse Lever to the left.

**Warning!** If the drill abnormally shakes, gets hot, smokes and smells, sparks, or the jaws of the Chuck (10) get stuck in a workpiece, cut off the power supply and have the Drill inspected by a qualified service technician.

## INSPECTION, MAINTENANCE, AND CLEANING

1.  **WARNING!** Make sure that the tool is unplugged from its electrical outlet before performing any inspection, maintenance, or cleaning procedures.
2. **BEFORE EACH USE**, inspect the general condition of the Drill. Check for loose screws, misalignment or binding of moving parts, cracked or broken parts, damaged electrical wiring, and any other condition that may affect its safe operation. If abnormal noise or vibration occurs, have the problem corrected before further use. **Do not use damaged equipment.**
3. Periodically check the mounting screws and tighten if necessary.
4. Clean the unit with a damp cloth. Never use solvents to clean the unit.
5. Inspect the chuck and remove any dirt or debris.
6. The following should only be done by a qualified service technician. Inspect the Carbon Brushes (17) periodically. See the Assembly Drawing on page 15. Remove the Brush Holder (16) on the side of the drill. Take the Carbon Brush (17) out of the Brush Holder (17). If it is dirty, use a pencil eraser to clean it. If it is worn, replace it and insert the Carbon Brush (17) into the Brush Holder (17). If one brush is bad, replace both.

## PARTS LIST

Part No.	Description
1	Rubber Grip
2	Blister
3	Right Cover
4	Trigger
5	Fender Ring
6	Circle Key
7	Slip Bearing
8	Cogwheel
9	Bearing
10	Chuck
11	Spindle
12	Rolling Bearing
13	Rotor
14	Bearing
15	Stator
16	Brush Holder
17	Carbon Brush
18	Screw
19	Terminal Plate
20	Cord Sheath
21	Left Cover
22	Chuck Key

### PLEASE READ THE FOLLOWING CAREFULLY

THE MANUFACTURER AND/OR DISTRIBUTOR HAS PROVIDED THE PARTS LIST AND ASSEMBLY DIAGRAM IN THIS MANUAL AS A REFERENCE TOOL ONLY. NEITHER THE MANUFACTURER OR DISTRIBUTOR MAKES ANY REPRESENTATION OR WARRANTY OF ANY KIND TO THE BUYER THAT HE OR SHE IS QUALIFIED TO MAKE ANY REPAIRS TO THE PRODUCT, OR THAT HE OR SHE IS QUALIFIED TO REPLACE ANY PARTS OF THE PRODUCT. IN FACT, THE MANUFACTURER AND/OR DISTRIBUTOR EXPRESSLY STATES THAT ALL REPAIRS AND PARTS REPLACEMENTS SHOULD BE UNDERTAKEN BY CERTIFIED AND LICENSED TECHNICIANS, AND NOT BY THE BUYER. THE BUYER ASSUMES ALL RISK AND LIABILITY ARISING OUT OF HIS OR HER REPAIRS TO THE ORIGINAL PRODUCT OR REPLACEMENT PARTS THERETO, OR ARISING OUT OF HIS OR HER INSTALLATION OF REPLACEMENT PARTS THERETO.

SKU 46804    **For technical questions, please call 1-800-444-3353.**    Page 14

## ASSEMBLY DIAGRAM

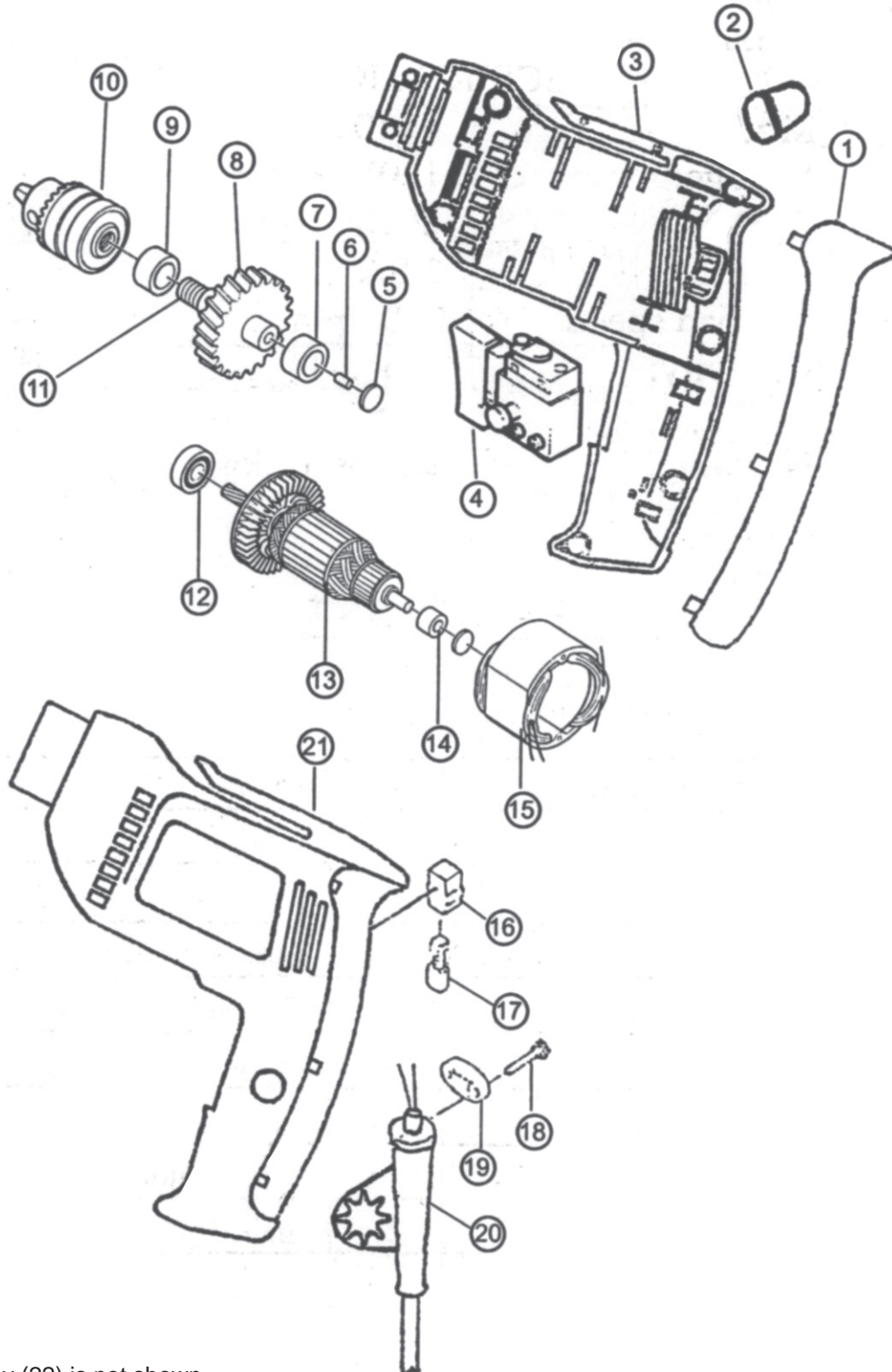

The Chuck Key (22) is not shown.

**NOTE:** Some parts are listed and shown for illustration purposes only, and are not available individually as replacement parts.

SKU 46804 For technical questions, please call 1-800-444-3353.

Page 15

## Free Manuals Download Website

<http://myh66.com>

<http://usermanuals.us>

<http://www.somanuals.com>

<http://www.4manuals.cc>

<http://www.manual-lib.com>

<http://www.404manual.com>

<http://www.luxmanual.com>

<http://aubethermostatmanual.com>

Golf course search by state

<http://golfingnear.com>

Email search by domain

<http://emailbydomain.com>

Auto manuals search

<http://auto.somanuals.com>

TV manuals search

<http://tv.somanuals.com>