

INTIMIDATOR™

SPOT LED 150

User Manual

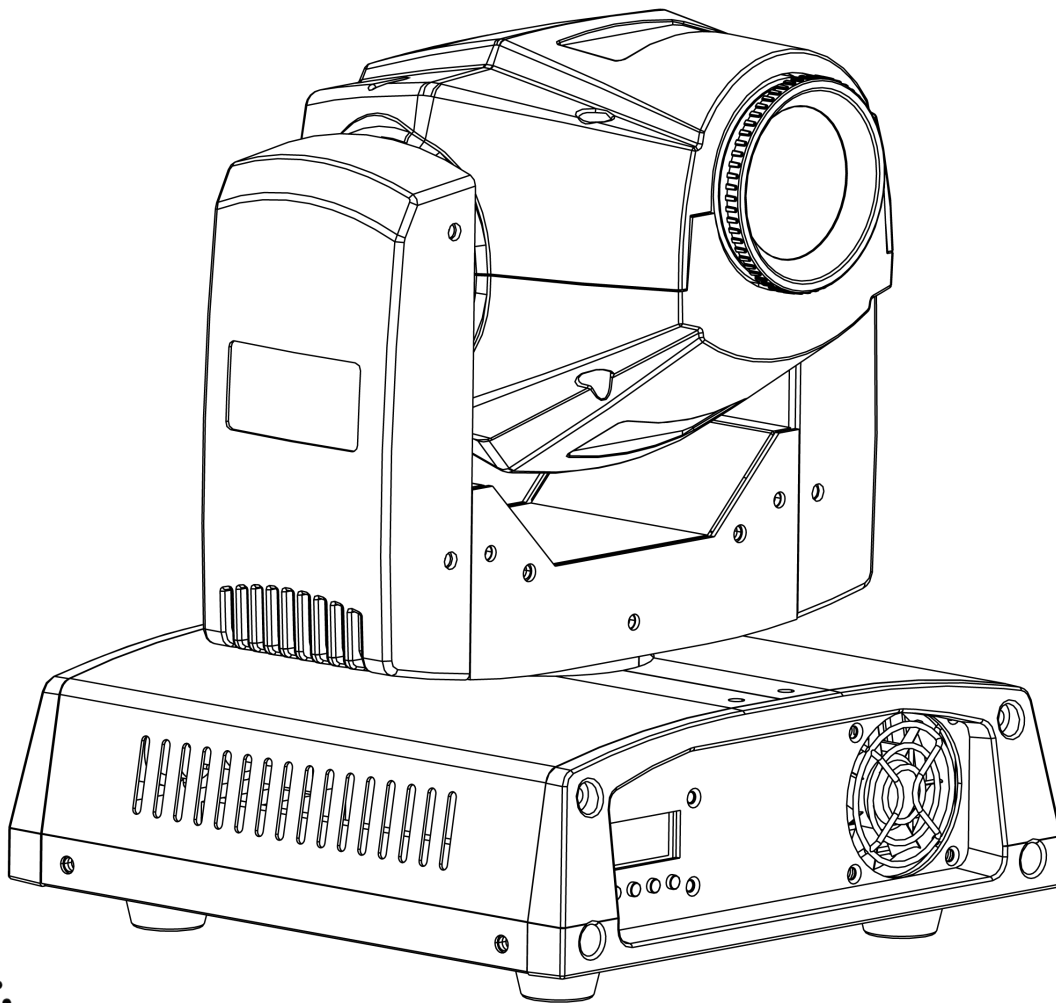

CHAUVET®
Value · Innovation · Performance
It's **Green** Thinking.™

TABLE OF CONTENTS

1. Before You Begin	3
What Is Included	3
Unpacking Instructions.....	3
Claims.....	3
Text Conventions	3
Symbols	3
Disclaimer	3
Product at a Glance	4
Safety Notes.....	4
2. Introduction	5
Product Overview.....	5
Product Dimensions	6
3. Setup	7
AC Power	7
Fuse Replacement.....	7
Power Linking.....	7
Mounting	8
Orientation	8
Rigging.....	8
4. Operation	9
Control Panel Operation.....	9
Menu Map	9
Configuration (DMX)	10
Starting Address.....	10
DMX Personalities.....	10
DMX Channel Assignments and Values	11
11-CH.....	11
6-CH.....	13
Configuration (Standalone)	14
Sound Active Mode	14
Automatic Mode	14
Manual Pan/Tilt Operation	14
Pan/Tilt Angle Restrict.....	14
Display Orientation.....	15
Master/Slave Mode	15
Reset Software.....	15
5. Technical Information	16
Product Maintenance	16
6. Technical Specifications	17
Returns.....	18
Contact Us	18

1. BEFORE YOU BEGIN

What Is Included

- Intimidator™ Spot LED 150
- 2 x Mounting Brackets
- 2 x Mounting Bolts
- Safety Eyebolt
- Power Cord
- Warranty Card
- Quick Reference Guide

Unpacking Instructions

Immediately upon receipt, carefully unpack the product and check the container to make sure you have received all the parts indicated above in good condition.

Claims



If the container or the material inside the container (the product and included accessories) appear damaged from shipping, or show signs of mishandling, upon receipt notify the carrier immediately, not CHAUVET®. Failure to do so in a timely manner may invalidate your claim with the carrier. In addition, keep the container and all the packing material for inspection.

For other issues such as missing components or parts, damage not related to shipping, or concealed damage, file a claim with CHAUVET® within 7 days of receiving the merchandise.

Text Conventions

Convention	Meaning
1~512	A range of values
50/60	A set of values of which only one can be chosen
Settings	A menu option not to be modified
Menu > Settings	A sequence of menu options to be followed
<ENTER>	A key to be pressed on the product's control panel
ON	A value to be entered or selected

Symbols

Symbol	Meaning
	Critical installation, configuration, or operation information. Failure to comply could make the product not work, damage it, and harm the user.
	Important installation or configuration information. Failure to comply with this information may prevent the product from functioning correctly.
	Useful information.

Disclaimer

The information and specifications contained in this document are subject to change without notice. CHAUVET® assumes no responsibility or liability for any errors or omissions that may appear in this manual. CHAUVET® reserves the right to update the existing document or to create a new document to correct any errors or omissions.

You can download the latest version of this document from www.chauvetlighting.com.

© Copyright 2012 CHAUVET®. All rights reserved.

Printed in P.R.C. Electronically published by CHAUVET® in the United States of America.

Author	Date	Editor	Date
A. Diaz	3/21/12	S. Graham	3/21/12

Product at a Glance

Use on Dimmer	⊘	Auto Programs	✓
Outdoor Use	⊘	Auto-ranging Power Supply	✓
Sound Activated	✓	Replaceable Fuse	✓
DMX	✓	User Serviceable	⊘
Master/Slave	✓	Duty Cycle	⊘

Safety Notes

Please read the following Safety Notes carefully before working with the product. The Notes include important safety information about installation, usage, and maintenance.



- This product is not intended for permanent installation.
- Always connect the product to a grounded circuit to avoid the risk of electrocution.
- Always disconnect the product from the power source before cleaning or replacing the fuse.
- Avoid direct eye exposure to the light source while the product is on.
- Make sure the power cord is not crimped or damaged.
- Never disconnect the product from power cord by pulling or tugging on the cord.
- If mounting the product overhead, always secure to a fastening device using a safety cable.
- Make sure there are no flammable materials close to the product when operating.
- Do not touch the product's housing when operating because it may be very hot.



- Always make sure that the voltage of the outlet to which you are connecting the product is within the range stated on the decal or rear panel of the product.
- The product is for indoor use only! (IP20) To prevent risk of fire or shock, do not expose the product to rain or moisture.
- Always install the product in a location with adequate ventilation, at least 20 in (50 cm) from adjacent surfaces.
- Be sure that no ventilation slots on the product's housing are blocked.
- Never connect the product to a dimmer.
- Make sure to replace the fuse with another of the same type and rating.
- Never carry the product from the power cord or any moving part. Always use the hanging/mounting bracket or the handles.
- The maximum ambient temperature (Ta) is 104° F (40° C). Do not operate the product at higher temperatures.
- In the event of a serious operating problem, stop using the product immediately.
- Never try to repair the product. Repairs carried out by unskilled people can lead to damage or malfunction. Please contact the nearest authorized technical assistance center.



- Keep this User Manual. If you sell the product to another user, be sure that they also receive this document.

2. INTRODUCTION

Product Overview

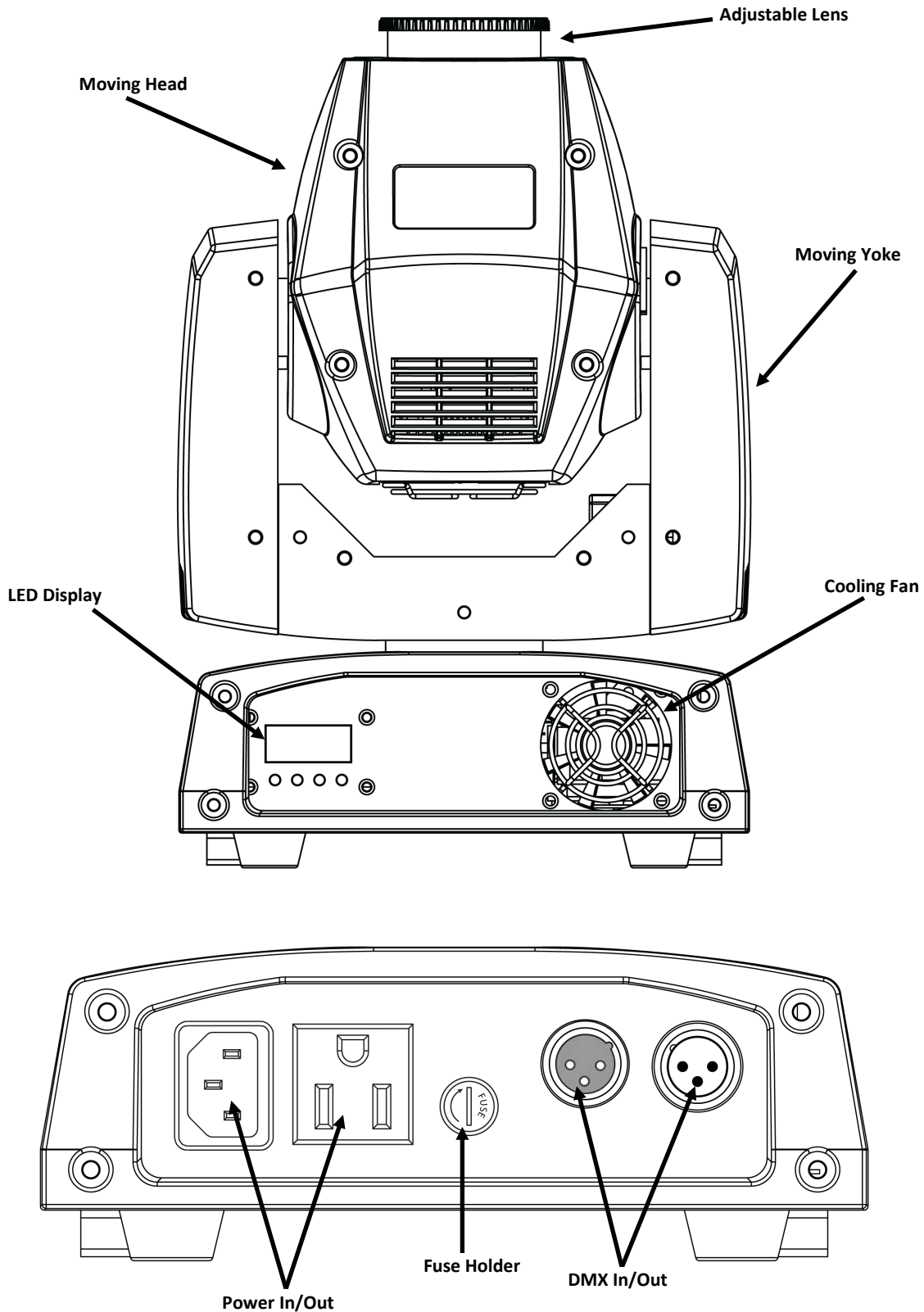

Product Dimensions

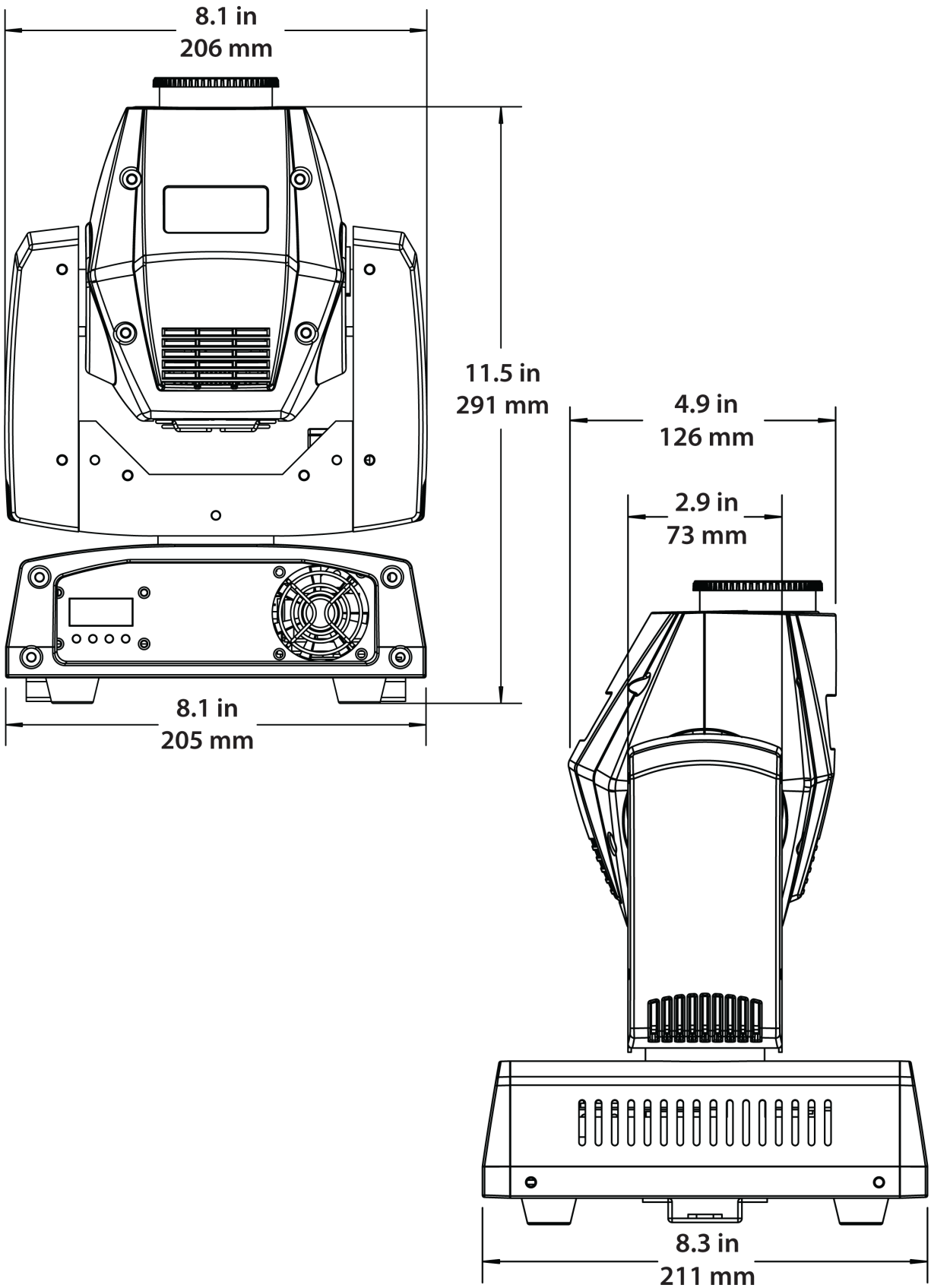

3. SETUP

AC Power The Intimidator™ Spot LED 150 has an auto-ranging power supply and it can work with an input voltage range of 100~240 VAC, 50/60 Hz.

To determine the product's power requirements (circuit breaker, power outlet, and wiring), use the current value listed on the label affixed to the product's back panel, or refer to the product's specifications chart. The listed current rating indicates the product's average current draw under normal conditions.



Always connect the product to a protected circuit (circuit breaker or fuse). Make sure the product has an appropriate electrical ground to avoid the risk of electrocution or fire.



Never connect the product to a rheostat (variable resistor) or dimmer circuit, even if the rheostat or dimmer channel serves only as a 0~100% switch.



Disconnect the product from power before replacing the fuse.

Fuse Replacement

1. Using a flat-head screwdriver, unscrew the fuse holder from the back of the product.
2. Remove the blown fuse from the holder and replace with a fuse of the exact same type and rating.
3. Insert the fuse holder back in place, re-tighten, and reconnect power.

Power Linking The product provides power linking via the Edison outlet located in the back of the unit. Please see the diagram below for further explanation.

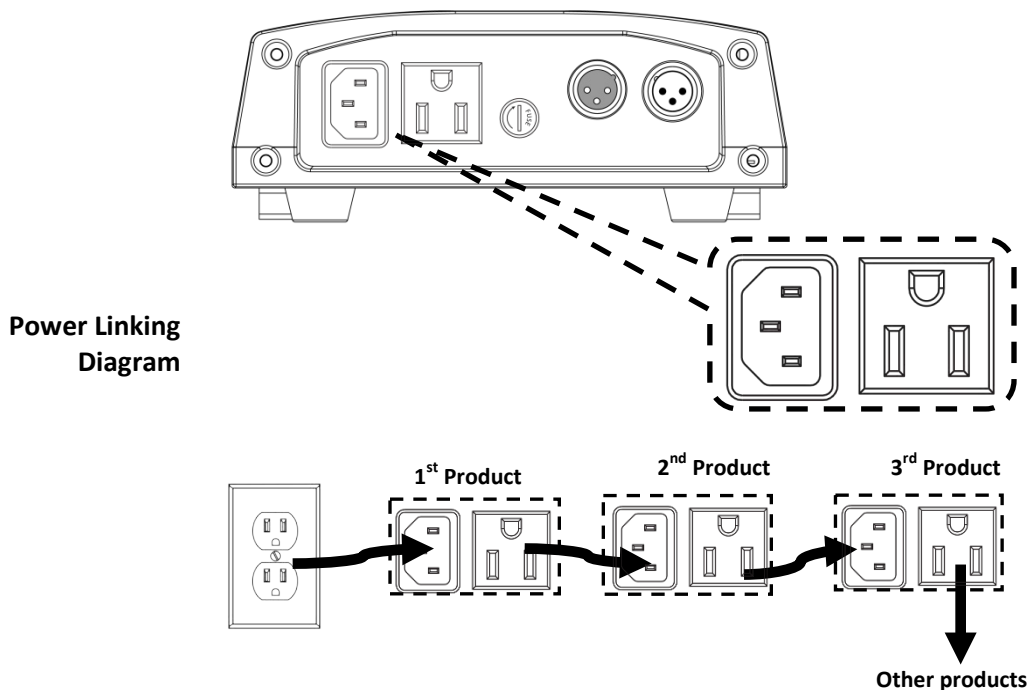

You can power link up to 6 Intimidator™ Spot LED 150 units on 120 VAC or up to 12 Intimidator™ Spot LED 150 units on 230 VAC.



The power linking diagram shown above corresponds to the North American version of the product ONLY! If using the product in other markets, you must consult with the local CHAUVET® distributor as power linking connectors and requirements may differ in your area.

Mounting Before mounting the product, read and follow the [Safety Notes](#).

Orientation The Intimidator™ Spot LED 150 may be mounted in any position; however, make sure adequate ventilation is provided around the product.

- Rigging**
- Before deciding on a location, always make sure there is easy access to the product for maintenance and programming purposes.
 - Make sure that the structure or surface onto which you are mounting the product can support the product's weight. See the [Technical Specifications](#) section of this manual for weight information.
 - When mounting the product overhead, always use a safety cable. Mount the product securely to a rigging point, whether an elevated platform or a truss.
 - When rigging the product onto a truss, you should use a mounting clamp of appropriate weight capacity. The bracket has a 13 mm hole, which is appropriate for this purpose.
 - When power linking multiple products, you must always consider the length of the power linking cable and mount the products close enough for the cable to reach.
 - The rubber feet also serve as floor supports/allow for surface mounting. When mounting the product on the floor, make sure that the product and cables are away from people and vehicles.

Mounting Diagram

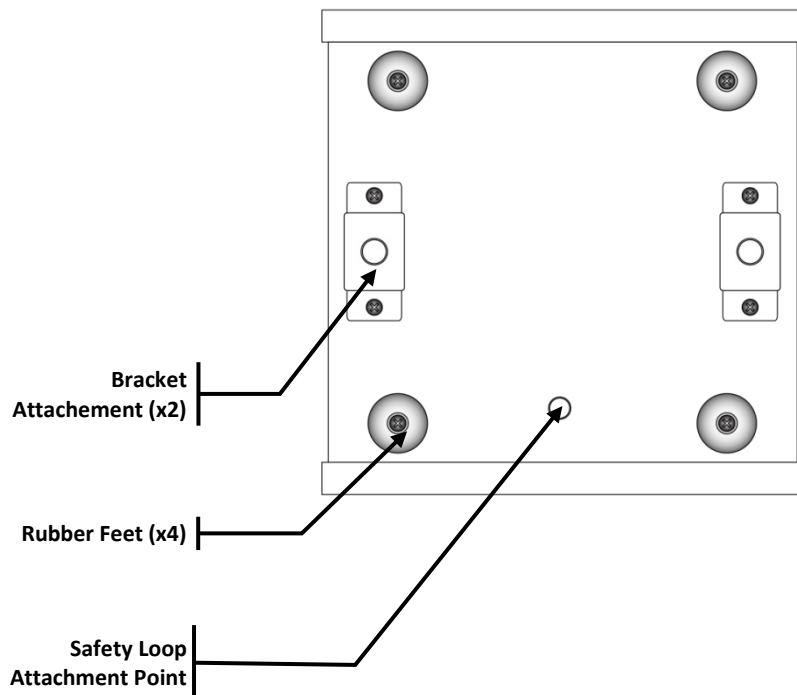

4. OPERATION

Control Panel Operation

To access the control panel functions, use the four buttons located underneath the display.

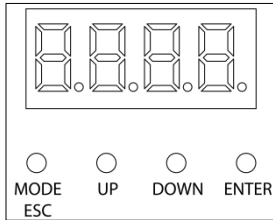

Button	Function
<MODE/ESC>	Press to find an operation mode or to back out of the current menu option
<UP>	Press to scroll up the list of options or to find a higher value
<DOWN>	Press to scroll down the list of options or to find a lower value
<ENTER>	Press to activate a menu option or a selected value

Menu Map

Mode	Programming Steps	Description
DMX Mode	001-512	Sets the DMX starting address
Operating Mode	SLAv (Son)	Slave operating mode
	NASL (SLoU)	Automatic Mode, Slow Program
	NAFA (FASt)	Automatic Mode, Fast Program
	NStS (SrUn)	Sound Active Mode
Pan	Normal Pan PAn	Normal Pan operation
	Inverse Pan r PAn	Inverse Pan operation
Tilt	Normal Tilt tiL	Normal Tilt operation
	Inverse Tilt r tiL	Inverse Tilt operation
Display	Normal Display diS	Change the LCD display text position
	Inverse Display r diS	
Channel Mode	11-Channel Mode 11CH	Selects the DMX personality
	6-Channel Mode 6CH	
Manual Pan Restrict	Pan 540 PA54	Select Pan angle restrictions
	Pan 360 PA36	
	Pan 180 PA18	
Manual Tilt Restrict	Tilt 270 Ti27	Select Tilt angle restrictions
	Tilt 180 Ti18	
	Tilt 90 Ti 9	
Reset	rESt	Resets fixture
Load	LoAd	Load factory defaults

Configuration (DMX)

Set the product in DMX mode to control with a DMX controller.

1. Connect the product to a suitable power outlet.
2. Turn the product on.
3. Connect a DMX cable from the DMX output of the DMX controller to the DMX input socket on the product.

Starting Address

When selecting a starting DMX address, always consider the number of DMX channels the selected DMX mode uses. If you choose a starting address that is too high, you could restrict the access to some of the product's channels.

The Intimidator™ Spot LED 150 uses up to 11 DMX channels in its 11-channel DMX mode, which defines the highest configurable address to **502**.

If you are not familiar with the DMX protocol, you may refer to the *DMX Primer* online at www.chauvetlighting.com.

To select the starting address, do the following:

1. Press **<MODE/ESC>** repeatedly until **001** shows on the display.
2. Press **<ENTER>**.
3. Use **<UP>** or **<DOWN>** to select the starting address.
4. Press **<ENTER>**.

DMX Personalities











The Intimidator™ Spot LED 150 has two DMX personalities, an 8-channel personality and a 14-channel personality.



To choose which DMX personality to use, follow the steps below:

1. Press **<MODE/ESC>** repeatedly until either **14CH** (to choose the 14-channel personality) or **8CH** (to choose the 8-channel personality) shows on the display.
2. Press **<ENTER>**.

DMX Channel Assignments and Values

11-CH	Channel	Function	Value	Setting
	1	Pan	000 ⇔ 255	0-540°
	2	Tilt	000 ⇔ 255	0-270°
	3	Fine Pan	000 ⇔ 255	Fine control of panning
	4	Fine Tilt	000 ⇔ 255	Fine control of tilting
	5	Speed	000 ⇔ 255	Pan/Tilt speed (fast to slow)
	6	Color Wheel	000 ⇔ 005	White
			006 ⇔ 011	Yellow
			012 ⇔ 017	Magenta
			018 ⇔ 023	Green
			024 ⇔ 029	Red
			030 ⇔ 035	Cyan
			036 ⇔ 041	Orange
			042 ⇔ 047	Blue
			048 ⇔ 053	Light Green
			054 ⇔ 063	Amber
			064 ⇔ 069	White + Yellow
			070 ⇔ 075	Yellow + Magenta
			076 ⇔ 081	Magenta + Green
			082 ⇔ 087	Green + Red
			088 ⇔ 093	Red + Cyan
			094 ⇔ 099	Cyan + Orange
			100 ⇔ 105	Orange + Blue
	106 ⇔ 111	Blue + Light Green		
	112 ⇔ 117	Light Green + Amber		
	118 ⇔ 127	Amber + White		
	128 ⇔ 191	Color cycling rainbow with increasing speed		
	192 ⇔ 255	Reverse color cycling rainbow with increasing speed		
	7	Shutter	000 ⇔ 003	Blackout
			004 ⇔ 007	Open
			008 ⇔ 215	Strobe (0-20 Hz)
			216 ⇔ 255	Open
	8	Dimmer	000 ⇔ 255	0-100%

9	Gobo Wheel							
		000 - 005	006 - 011	012 - 017	018 - 023	024 - 029		
								
		030 - 035	036 - 041	042 - 047	048 - 053	054 - 063		
		064 ⇔ 071	Gobo 9 shake, from slow to fast					
		072 ⇔ 079	Gobo 8 shake, from slow to fast					
		080 ⇔ 085	Gobo 7 shake, from slow to fast					
		086 ⇔ 091	Gobo 6 shake, from slow to fast					
		092 ⇔ 097	Gobo 5 shake, from slow to fast					
		098 ⇔ 103	Gobo 4 shake, from slow to fast					
		104 ⇔ 109	Gobo 3 shake, from slow to fast					
		110 ⇔ 115	Gobo 2 shake, from slow to fast					
		116 ⇔ 121	Gobo 1 shake, from slow to fast					
		122 ⇔ 127	Open					
		128 ⇔ 191	Cycle effect with increasing speed					
		192 ⇔ 255	Reverse cycle effect with increasing speed					
10	Control Functions	000 ⇔ 007	No function					
		008 ⇔ 027	Blackout while pan/tilt moving					
		028 ⇔ 047	Blackout while moving gobo wheel					
		048 ⇔ 067	Disable blackout while pan/tilt/moving gobo wheel					
		068 ⇔ 087	Blackout while moving color wheel					
		088 ⇔ 107	Disable blackout while pan/tilt/moving color wheel					
		108 ⇔ 127	Disable blackout while moving gobo/color wheel					
		128 ⇔ 147	Disable blackout while moving all options					
		148 ⇔ 167	Reset pan					
		168 ⇔ 187	Reset tilt					
		188 ⇔ 207	Reset color wheel					
		208 ⇔ 227	Reset gobo wheel					
		228 ⇔ 247	Reset all channels					
		248 ⇔ 255	No function					
		11	Auto Programs	000 ⇔ 007	No function			
				008 ⇔ 023	Auto program 1			
024 ⇔ 039	Auto program 2							
040 ⇔ 055	Auto program 3							
056 ⇔ 071	Auto program 4							
072 ⇔ 087	Auto program 5							
088 ⇔ 103	Auto program 6							
104 ⇔ 119	Auto program 7							
120 ⇔ 135	Auto program 8							
136 ⇔ 151	Sound controlled program 1							
152 ⇔ 167	Sound controlled program 2							
168 ⇔ 183	Sound controlled program 3							
184 ⇔ 199	Sound controlled program 4							
200 ⇔ 215	Sound controlled program 5							
216 ⇔ 231	Sound controlled program 6							
232 ⇔ 247	Sound controlled program 7							
248 ⇔ 255	Sound controlled program 8							

6-CH	Channel	Function	Value	Setting
	1	Pan	000 ⇄ 255	0-540°
	2	Tilt	000 ⇄ 255	0-270°
	3	Color	000 ⇄ 005	White
			006 ⇄ 011	Yellow
			012 ⇄ 017	Magenta
			018 ⇄ 023	Green
			024 ⇄ 029	Red
			030 ⇄ 035	Cyan
			036 ⇄ 041	Orange
			042 ⇄ 047	Blue
			048 ⇄ 053	Light Green
			054 ⇄ 063	Amber
			064 ⇄ 069	White + Yellow
			070 ⇄ 075	Yellow + Magenta
			076 ⇄ 081	Magenta + Green
			082 ⇄ 087	Green + Red
			088 ⇄ 093	Red + Cyan
			094 ⇄ 099	Cyan + Orange
			100 ⇄ 105	Orange + Blue
	106 ⇄ 111	Blue + Light Green		
	112 ⇄ 117	Light Green + Amber		
	118 ⇄ 127	Amber + White		
	128 ⇄ 191	Color cycling rainbow with increasing speed		
	192 ⇄ 255	Reverse color cycling rainbow with increasing speed		
	4	Shutter	000 ⇄ 003	Blackout
			004 ⇄ 007	Open
			008 ⇄ 215	Strobe (0-20 Hz)
			216 ⇄ 255	Open
	5	Dimmer	000 ⇄ 255	0-100%
	6	Gobo Wheel		
				
			064 ⇄ 071	Gobo 9 shake, from slow to fast
			072 ⇄ 079	Gobo 8 shake, from slow to fast
			080 ⇄ 085	Gobo 7 shake, from slow to fast
			086 ⇄ 091	Gobo 6 shake, from slow to fast
			092 ⇄ 097	Gobo 5 shake, from slow to fast
			098 ⇄ 103	Gobo 4 shake, from slow to fast
			104 ⇄ 109	Gobo 3 shake, from slow to fast
			110 ⇄ 115	Gobo 2 shake, from slow to fast
			116 ⇄ 121	Gobo 1 shake, from slow to fast
			122 ⇄ 127	Open
			128 ⇄ 191	Cycle effect with increasing speed
			192 ⇄ 255	Reverse cycle effect with increasing speed

Configuration (Standalone)

Set the product in one of the standalone modes to control without a DMX controller.

1. Connect the product to a suitable power outlet.
2. Turn the product on.



Never connect a product that is operating in any standalone mode (either Static, Automatic, or Sound) to a DMX string connected to a DMX controller. Products in standalone mode may transmit DMX signals that could interfere with the DMX signals from the controller.

Sound Active Mode

To enable the Sound Active mode, do the following:

1. Press **<MODE/ESC>** repeatedly until one of the following shows on the display: **NASi**, **NAFA**, **NStS**, or **SLAv**.
2. Press **<UP>** or **<DOWN>** to select **NStS**.
3. Press **<ENTER>**.



The product will only respond to low frequencies of music (bass and drums).

Automatic Mode

To enable the Automatic Mode, follow the instructions below:

1. Press **<MODE/ESC>** repeatedly until one of the following shows on the display: **NASi**, **NAFA**, **NStS**, or **SLAv**.
2. Press **<UP>** or **<DOWN>** to select **NASi** (for a slow light show) or **NAFA** (for a fast light show).
3. Press **<ENTER>**.

Manual Pan/Tilt Operation

To select whether you want the Intimidator™ Spot LED 150 to operate with normal panning or inverted panning, do the following:

1. Press **<MODE/ESC>** repeatedly until **PAn** shows on the display.
2. Press **<UP>** or **<DOWN>** to select normal pan operation (**PAn**) or inverse pan operation (**r PAn**).
3. Press **<ENTER>**.

To select whether you want the Intimidator™ Spot LED 150 to operate with normal tilting or inverted tilting, do the following:

1. Press **<MODE/ESC>** repeatedly until **tiL** shows on the display.
2. Press **<UP>** or **<DOWN>** to select normal pan operation (**tiL**) or inverse pan operation (**r tiL**).
3. Press **<ENTER>**.

Pan/Tilt Angle Restrict

You are able to restrict the pan and tilt angles on the Intimidator™ Spot LED 150 to achieve the effect you like.

To select which pan angle to use, do the following:

1. Press **<MODE/ESC>** repeatedly until **PA54** shows on the display.
2. Press **<UP>** or **<DOWN>** to select either 540° (**PA54**), 360° (**PA36**) or 180° (**PA18**).
3. Press **<ENTER>**.

To select which tilt angle to use, do the following:

1. Press **<MODE/ESC>** repeatedly until **Ti27** shows on the display.
2. Press **<UP>** or **<DOWN>** to select either 270° (**Ti27**), 180° (**Ti18**) or 90° (**Ti 9**).
3. Press **<ENTER>**.

Display Orientation

You are able to flip the LED display for easy readability in any mounting situation.

To select your display angle:

1. Press **<MODE/ESC>** repeatedly until **diS** shows on the display.
2. Press **<UP>** or **<DOWN>** to select normal display mode (**diS**) or inverse display mode (**r diS**).
3. Press **<ENTER>**.

Master/Slave Mode

The Master/Slave mode allows a single Intimidator™ Spot LED 150 unit (the “master”) to control the actions of one or more Intimidator™ Spot LED 150 units (the “slaves”) without the need of a DMX controller. The master unit will be set to operate in either Automatic or Sound Active mode, while the slave units will be set to operate in Slave Mode. Once set and connected, the slave units will operate in unison with the master unit.

Configure the units as indicated below.

Slave units:

1. Press **<MODE/ESC>** repeatedly until **SLAv** shows on the display.
2. Press **<ENTER>** to accept.
3. Set the DMX address to **001**.
4. Connect the DMX input of the first slave unit to the DMX output of the master unit.
5. Connect the DMX input of the subsequent slave units to the DMX output of the previous slave unit.
6. Finish setting and connecting all the slave units.

Master unit:

1. Set the master unit to operate in either Automatic or Sound mode.
2. Make the master unit the first unit in the DMX daisy chain.

- **Configure all the slave units before connecting the master unit to the DMX daisy chain.**
- **Never connect a DMX controller to a DMX string configured for Master/Slave operation because the controller may interfere with the signals from the master unit.**
- **Do not connect more than 31 slave units to the master unit.**



Reset Software

To reset the software on the Intimidator™ Spot LED 150, do the following:

1. Press **<MODE/ESC>** repeatedly until **rESt** shows on the display.
2. Press **<ENTER>**. The product will reset all settings in the software to the default factory settings.

5. TECHNICAL INFORMATION

Product Maintenance

Dust build up reduces light output performance and can cause overheating. This can lead to reduction of the light source's life and/or mechanical wear. To maintain optimum performance and minimize wear, you should clean your lighting products at least twice a month. However, be aware that usage and environmental conditions could be contributing factors to increase the cleaning frequency.

To clean the product, follow the instructions below:

- Unplug the product from power.
- Wait until the product is cold.
- Use a vacuum (or dry compressed air) and a soft brush to remove dust collected on the external surface/vents.
- Clean all external optics with a mild soap solution, ammonia-free glass cleaner, or isopropyl alcohol.
- Apply the solution directly to a soft, lint-free cotton cloth or a lens cleaning tissue.
- Softly drag any dirt or grime to the outside edges of the external optics.
- Gently polish the external optics until they are free of haze and lint.



Always dry the external optics carefully after cleaning them.



Do not spin the cooling fan/fans using compressed air because you could damage it/them.

6. TECHNICAL SPECIFICATIONS

Dimensions and Weight	Length	Width	Height	Weight
	8.1 in (205 mm)	8.3 in (211 mm)	11.5 in (291 mm)	9.3 lbs (4.2 kg)
Note: Dimensions in inches rounded to the nearest decimal digit.				
Power	Power Supply Type	Range	Voltage Selection	
	Switching (internal)	100~240 V, 50/60 Hz	Auto-ranging	
	Parameter	120 V, 60 Hz	230 V, 50 Hz	
	Consumption	88 W	92 W	
	Operating	0.7 A	0.4 A	
Power I/O	Power I/O	US/Worldwide	UK/Europe	
	Power input connector	IEC	IEC	
	Power output connector	Edison	IEC	
	Power Cord plug	Edison (US)	Local plug	
Light Source	Type	Power	Lifespan	
	LED	25 W (1.5 A)	50,000 hours	
	Color	Quantity	Current	
	White	1	350 mA	
Photo Optic	Parameter			
	Illuminance @ 2 m	2714 lux		
	Beam angle	15°		
	Strobe rate	0-20 Hz		
	Pan & Tilt	540		270
	Pan/Tilt Ranges	540°, 360°, 180° Pan		270°, 180°, 90° Tilt
Thermal	Maximum External Temp.	Cooling System		
	104° F (40° C)	Convection		
DMX	I/O Connectors	Connector Type	Channel Range	
	3-pin XLR	Sockets	6, 11	
Ordering	Product Name	Item Code	Item Number	
	Intimidator™ Spot LED 150	08010176	INTSPOTLED150	



UL 1573
CSA C22.2 No. 166
E113093

In case you need to return a product or request support, follow the procedure below:

- If you live in the U.S., contact CHAUVET® World Headquarters (see below).
- If you live in the UK or Ireland, contact CHAUVET® Europe Ltd. (see below).
- If you live in any other country, DO NOT contact CHAUVET®. Instead, contact your distributor of record. See www.chauvetlighting.com for distributors outside the U.S., United Kingdom, or Ireland.



If you live outside the U.S., United Kingdom, or Ireland, contact your distributor of record and follow their instructions on how to return CHAUVET® products to them. Visit our website for contact details.

Returns

Call the corresponding CHAUVET® Tech Support office and request a Return Merchandise Authorization (RMA) number before shipping the product. Be prepared to provide the model number, serial number, and a brief description of the cause for the return.

You must send the merchandise prepaid, in its original box, and with its original packing and accessories. CHAUVET® will not issue call tags.

Clearly label the package with the RMA number. CHAUVET® will refuse any product returned without an RMA number.



Write the RMA number on a properly affixed label. DO NOT write the RMA number directly on the box.

Before sending the product, clearly write the following information on a piece of paper and place it inside the box:

- Your name
- Your address
- Your phone number
- The RMA number
- A brief description of the problem

Be sure to pack the product properly. Any shipping damage resulting from inadequate packaging will be your responsibility. As a suggestion, proper UPS packing or double-boxing is always a safe method to use.



CHAUVET® reserves the right to use its own discretion to repair or replace returned product(s).

Contact Us

World Headquarters

CHAUVET®

General Information

Address: 5200 NW 108th Avenue
Sunrise, FL 33351
Voice: (954) 929-1115
Fax: (954) 929-5560
Toll free: (800) 762-1084

Technical Support

Voice: (954) 929-1115 (Press 4)
Fax: (954) 756-8015
Email: tech@chauvetlighting.com

World Wide Web

www.chauvetlighting.com

United Kingdom & Ireland

CHAUVET® Europe Ltd.

General Information

Address: Unit 1C
Brookhill Road Industrial Estate
Pinxton, Nottingham, UK
NG16 6NT
Voice: +44 (0)1773 511115
Fax: +44 (0)1773 511110

Technical Support

Email: uktech@chauvetlighting.com

World Wide Web

www.chauvetlighting.co.uk

Free Manuals Download Website

<http://myh66.com>

<http://usermanuals.us>

<http://www.somanuals.com>

<http://www.4manuals.cc>

<http://www.manual-lib.com>

<http://www.404manual.com>

<http://www.luxmanual.com>

<http://aubethermostatmanual.com>

Golf course search by state

<http://golfingnear.com>

Email search by domain

<http://emailbydomain.com>

Auto manuals search

<http://auto.somanuals.com>

TV manuals search

<http://tv.somanuals.com>