



Belkin Wireless Cable/DSL Gateway Router

User Manual



F506230-3

Table of Contents

Introduction	1-3
Knowing your Belkin Router	4-5
Quick Setup	
<i>Setting up Your Belkin Wireless Cable/DSL Router</i>	6
<i>Configure your computers' networking settings.</i>	7
<i>Configure the Router to your ISP's settings</i>	8-10
General Setup	
<i>Getting Started</i>	12
STEP 1: Obtain information about your Internet Service Provider (ISP) and your network	13-19
STEP 2: Connect your computers to Router	20-22
STEP 3a: Setup your computers for networking	23-32
STEP 3b: Setting up Wireless Computers for Connection to the Router . .	33-34
Step 4: Configuring your Belkin Wireless Cable/DSL Router (the Router) for connection to the Internet	35-46
Wireless Configuration	47-48
Other Features	49-55
Wireless Networking Using 802.11b	56-59
Glossary of Wireless Networking Terms	60-61
Glossary of Wired Networking Terms	62-63
Troubleshooting	64-66
Information	67-69

Introduction

Thank You for purchasing the Belkin Wireless Cable/DSL Gateway Router (the Router). In minutes you will be able to network your computers and share your Internet connection. The following is a list of features that make your new Router an ideal solution for your home or small office network.

Key Features

Integrated Wireless 802.11b Access Point

Wide Area Coverage at High Speeds

The Belkin Wireless Access Point provides coverage over an indoor area up to 300 feet in radius and an outdoor area over 1800 feet in radius.

Up to 128-bit Security Encryption

Your Router is capable of encrypting (scrambling) the transmitted radio waves so you can be sure that your data is secure. This optional feature allows you to encrypt at 64-bits or 128-bits using a key that you enter yourself.

Web-Based User Interface

Setting up the Router's functions is done through your web browser. You can do this easily without having to install additional software onto the computer. There are no disks to install or keep track of and, best of all, you can make changes and perform setup functions from any computer on the network quickly and easily.

NAT Firewall Security

Your Router employs Network Address Translation (NAT) to protect your network from the outside world by isolating it from the Internet. NAT monitors all of the data coming in from the Internet and will only let through the information you want.

Integrated 10/100 3-Port Switch

The Router has a built-in, 3-port network switch to allow your wired computers to share printers, data and MP3 files, digital photos, and much more. The switch features automatic detection so it will adjust to the speed of connected devices. The switch will transfer data between computers and the Internet simultaneously without interrupting or consuming resources.

Introduction

Built-in DHCP Server

Dynamic Host Configuration Protocol (DHCP) on-board makes for the easiest possible connection of a network. The DHCP server will assign IP addresses to each computer automatically so there is no need for a complicated networking setup.

MAC Address Filtering

For added security, you can set up a list of Media Access Control (MAC) addresses (unique client identifiers) that are allowed access to your wireless network. Every computer equipped with a wireless network adapter has its own MAC address. Simply enter these MAC addresses into a list using the web-based user interface and you can control access to your network.

Applications and Advantages

- ***Wireless roaming with a laptop around the home or office***
Offers the freedom of networking—without cables.
- ***Difficult-to-wire environments***
Enables networking in buildings with solid or finished walls, or open areas where wiring is difficult to install.
- ***Frequently changing environments***
Adapts easily in offices or environments that frequently rearrange or change locations.
- ***Temporary LANs for special projects or peak time***
Sets up temporary networks such as at trade shows, exhibitions and constructions sites, which need networks on a short-term basis—Also companies who need additional workstations for a peak activity period.
- ***SOHO (Small Office/Home Office) networking needs***

Provides the easy and quick small network installation SOHO users need.

Introduction

Package Contents

- Belkin Wireless Cable/DSL Gateway Router
- Power Supply
- Belkin SOHO Networking Software CD
- User Manual

System Requirements

- Broadband Internet connection such as a cable or DSL modem with RJ45 (Ethernet) connection
- At least one computer with an installed wired or wireless network interface adapter
- TCP/IP networking protocol installed on each computer
- CAT5e networking cable (or better)
- Microsoft Internet Explorer 4.0 or later, or Netscape 4.0 or later

Knowing your Belkin Router

The Router has been designed to be placed on a desktop or mounted to a wall. The unique vertical design minimizes the desktop space required. All of the cables exit from the rear of the Belkin Router for better organization and utility. The LED indicators are easily visible on the front of the Router to provide you with information about network activity and status.

Front Panel

Ready Light—When lit, indicates that the unit is receiving power.

Wireless Status Light—When lit, indicates that the Wireless Router's wireless radio is enabled.

WAN Link Status

- **Link**—indicates that there is an active connection with the cable or DSL modem. If this light is off, the link is not established.
- **Activity**—When the WAN link status light is flashing, this means that data is flowing between the Router and the cable or DSL modem.

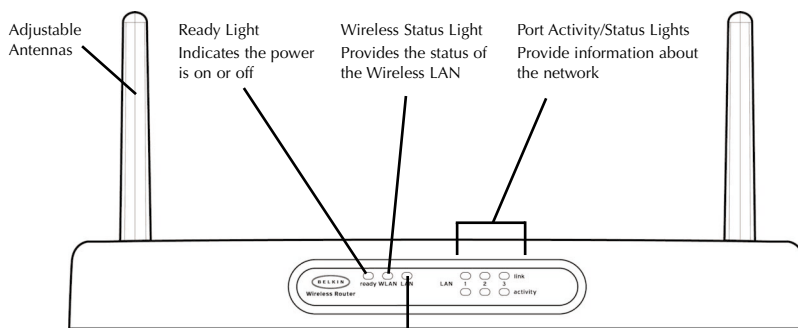

Front Panel

WAN Link Status Light
Provides information about the connection to the cable or DSL modem

Knowing your Belkin Router

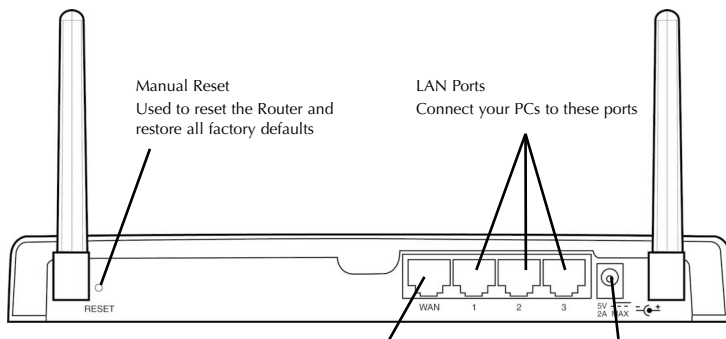

Rear Panel

WAN Port
Connect your cable or DSL modem to this port

DC Power Jack
Connect the included power supply to this jack

Port Activity/Status Lights

- **Link**—Solid indicates that there is a link between the Router and the computer connected to that port.
- **Activity**—When an activity light is flashing, data is flowing between the Router and the computer connected to that port.

Rear Panel

Power Input Jack—Connect 5V DC power supply.

WAN Port—Connect the network cable from the cable or DSL modem to the WAN port.

LAN Ports—Numbered 1–3. Connect the network cable from your PCs to these ports. Note: the computers do not need to be connected sequentially. For example, in a two-computer network you can connect one computer to Port 3 and another to Port 1.

Quick Set up

Quick Set up—Setting up Your Belkin Wireless Cable/DSL Router

If you are familiar with networking, you can use this Quick Setup procedure to setup your Router. If you need more detail to setup your Router, please read further into this manual.

Setting up the Router is accomplished in 3 easy steps

1. Connect the Router to your network.
2. Configure your computers' networking settings.
3. Configure the Router to your ISP's settings.

Connect the Router to your network.

1. Power down your equipment.
2. Connect a network cable between each of your PCs and the Router. Connect each PC to one of the ports on the rear of the Router labeled LAN.
3. Connect a network cable between the Router and your cable or DSL modem. Be sure this cable is plugged into the port labeled "WAN" on the Router.
4. Power on the cable or DSL modem.
5. Connect the power adapter to the Router.
6. After the cable or DSL modem and the Router are turned on, the Router's WAN link light should be on. This indicates that the modem and the Router are connected to each other.
7. Turn on the rest of your computers. After your computers boot up, a LAN link light (on the front of the Router) will be on for each port to which a wired computer is connected. These lights are your means to verify that your computers are connected.

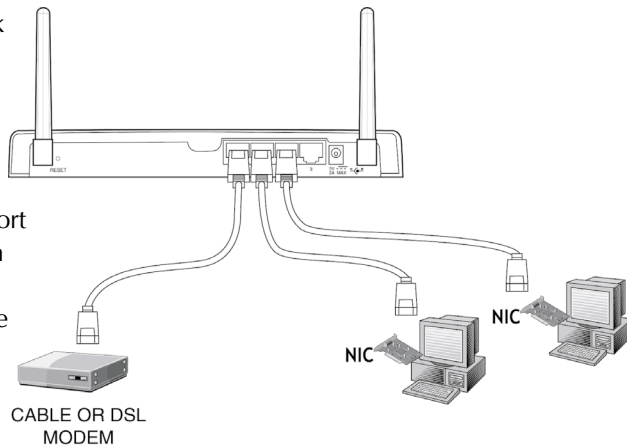

Quick Set up—Configure your computers' networking settings

1. Configure the TCP/IP settings on your computers to obtain an IP address automatically. The Router will use DHCP to assign each computer an IP address in the range of 192.168.2.x.
2. Restart each computer and verify the network connection. Using the “Network Neighborhood” or “My Network Places”, be sure that you can view each connected machine.

Quick Set up—Configure the Router to your ISP's settings

1. Using the computer that was originally connected directly to the cable or DSL modem, launch your browser. Note: You can access the setup utility from any computer on the network, however, use the original computer for this procedure at this time.
2. In the address bar, type the following address: 192.168.2.1. The Router login screen will appear.

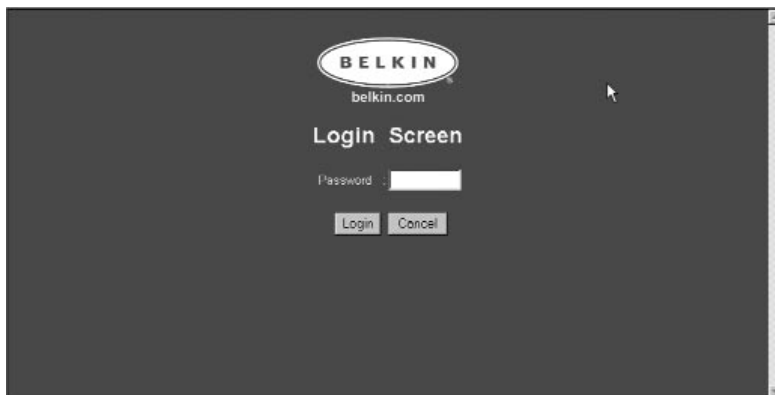

If this is the first time you are accessing the Router, or you have not set a password for the Router, there is no need to enter a password. Click "Login".

Quick Set up—Configure the Router to your ISP's settings

3. The Router's status page will appear.
4. Click on "Initial Setup" in the top left-hand corner. The following page will appear.

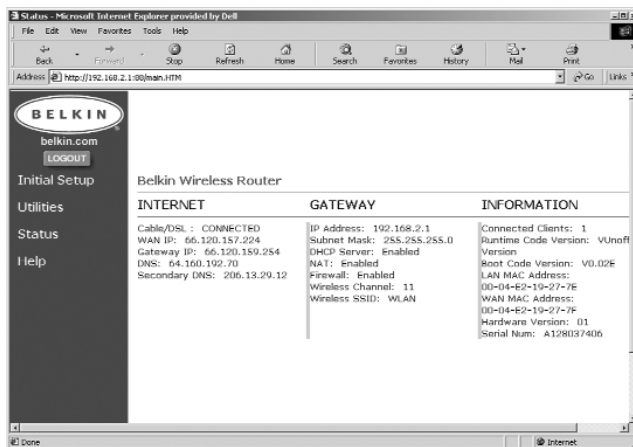

5. Select your connection type (this information is provided by your ISP) and click "Select". Depending on your selection you will see the "Static IP Address" page or the "PPPoE" page. Enter the required values provided by your ISP and click "Enter".

Quick Set up—Configure the Router to your ISP's settings

- The MAC Cloning/Entry screen will appear. If your ISP binds your connection to the MAC address of your network adapter, click “Clone MAC Address” or enter the MAC address here. Press Enter.

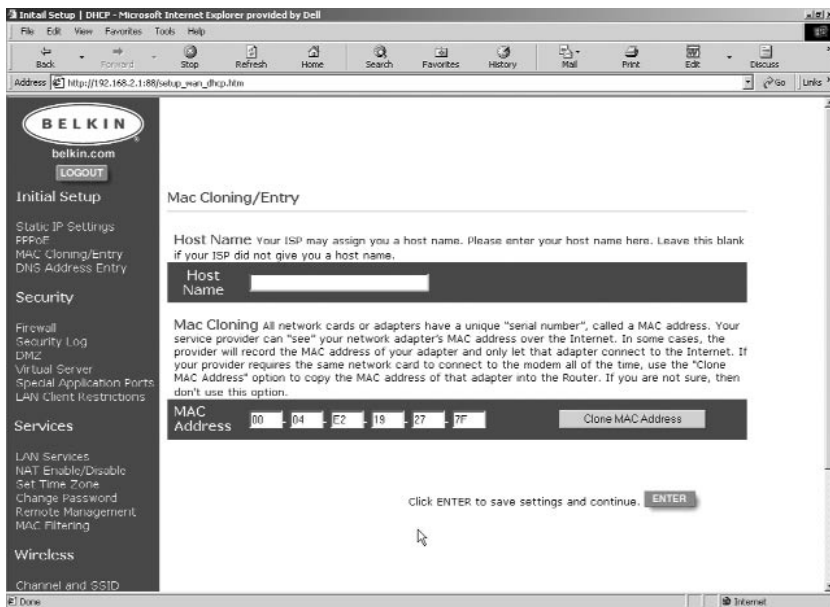

Your Router has been set up to communicate with your ISP. You should have Internet access at this point. If you are having trouble, see the troubleshooting section at the end of this manual.

General Setup

Getting Started

Your Router can connect a combination of wired and wireless computers to the Internet while allowing for file and peripheral sharing. Setting up wired and wireless connections to the Router is very easy to do. The following steps will show you how to connect your computers to the Router for networking and Internet sharing.

Sharing your Internet connection is done in 4 easy steps

- Step 1:** Obtain information about your Internet Service Provider (ISP) and your network
- Step 2:** Connect your wired computers to the Router
- Step 3a:** Set up your computers for networking
- Step 3b:** Set up your wireless computers to connect to the Router
- Step 4:** Configure the Router to connect to the Internet

STEP 1: Obtain information about your Internet Service Provider (ISP) and your network

Setting up your Router is a simple procedure, even if you are not familiar with networking. This guide will take you step by step through to the setup process for successfully sharing your Internet connection. There are a few pieces of information that you will need to obtain about your Cable or DSL provider as well as about your network. Most of the time, information is available online from your provider. You may have to call your provider.

Answer the following questions either by checking with your ISP's online technical support or by calling your ISP's technical support hotline. A worksheet has been provided in this manual to record your information for use later.

Is my IP address Static or Dynamic?

Your IP address is either static or dynamic. You will need to determine whether your provider assigns you a new IP address every time you log on (dynamic) or they assign you an IP address that never changes (static). For more about what an IP address is, see the Glossary of Networking Terms in the appendix of this manual.

Does my Internet service provider use PPPoE?

It either does or does not. If you have a DSL modem, your service provider may use PPPoE (for Point to Point Protocol over Ethernet) as the communication language between your DSL modem and the provider's network. If your DSL provider gave you software that you use to connect to your Internet account, such as WinPOET, Enternet300 or any other software that you need to run to connect to the Internet, then your service provider uses a PPPoE connection. Follow the directions in this manual to configure your router for PPPoE. For more about PPPoE, see the Glossary of Networking Terms in the appendix of this manual.

STEP 1: Obtain information about your Internet Service Provider (ISP) and your network

Is my connection bound to a MAC address?

It either is or is not. All network cards or adapters have a unique “serial number”, called a MAC address. Your service provider can “see” your network adapter's MAC address over the internet. In some cases, the provider will record the MAC address of your network adapter and only let that adapter connect to the Internet. This is done for several reasons, one of which is security. It also enables your provider to keep track of how many computers you have connected to your modem. You will need to find out whether your provider requires the same network card to connect to the modem all of the time. In the event that your provider does bind your MAC address, your Router has a feature that will copy the MAC address of your card. This will be covered later in the setup procedure. For more about what a MAC address is, see the Glossary of Networking Terms in the appendix of this manual.

Does my connection have an assigned Host Name?

It either does or does not. You will need to know if your provider assigns you host name that is required for connection. If it does, then you will need to know the Host name. If your computer was assigned a host name by your provider, the next section describes how you can obtain your host name.

STEP 1: Obtain information about your Internet Service Provider (ISP) and your network

Setup Worksheet

My IP Address is:	Static	Dynamic
If your IP address is static, you need the following information:		
Static IP address: Assigned by your provider		
Subnet Mask: Assigned by your provider		
Gateway: Assigned by your provider		
My provider binds my connection to a MAC address	Yes	No
My provider has assigned me a Host Name	Yes	No
If Yes, My Host Name is:		
My provider uses PPPoE	Yes	No
If your provider uses PPPoE, you need the following information:		
User Name: Assigned by your ISP	username@myisp.com	
Password: Assigned by your ISP		
Service Name: Assigned by your ISP	not always necessary	

STEP 1: Obtain information about your Internet Service Provider (ISP) and your network

IMPORTANT:

IF YOU HAVE A CABLE OR DSL MODEM CONNECTED TO A PC AND ARE NOW ADDING THE ROUTER TO YOUR NETWORK, FOLLOW THESE STEPS TO OBTAIN INFORMATION YOU WILL NEED LATER.

If you are not connecting the Router to an existing cable or DSL modem, skip to the next section called "Connecting the Belkin Wireless Router".

Users of Windows 98 or Me can get the configuration information by performing the following steps.

1. Turn on your computer and connect to the Internet through your cable or DSL Modem.
2. In Windows 95, 98 and Me, Click "Start" then click on "Run".
3. In the Run dialog box, type "winipcfg" then click "OK".
4. The IP Configuration window will appear.
5. In the drop-down menu, select your current Ethernet adapter by clicking once on the down-facing arrow and highlighting your adapter's name by clicking on it once.

STEP 1: Obtain information about your Internet Service Provider (ISP) and your network

- The IP configuration window will appear. Click on "More Info".

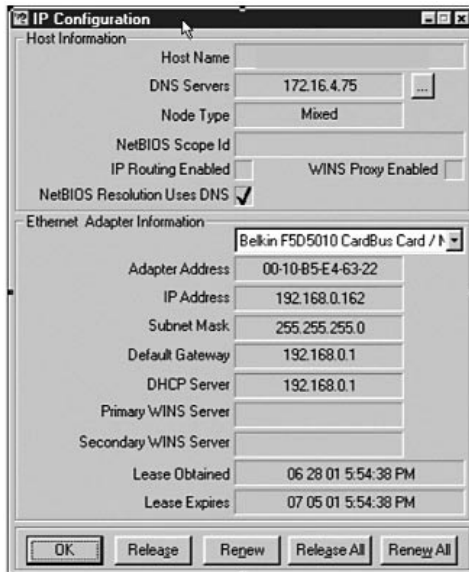

- This window will provide you with the Adapter Address (also known as the MAC address), the IP Address, Host name (if any) and other network settings. Carefully write this information in the table below, as you may need it later for setting up the Router. For further explanation of what these settings are, see the Glossary of Network Terms in the Appendix of this manual.

STEP 1: Obtain information about your Internet Service Provider (ISP) and your network

Users of Windows NT or Windows 2000 can get the configuration information by performing the following steps.

1. Click "Start" then "Run" in the Run dialog box, type "CMD".

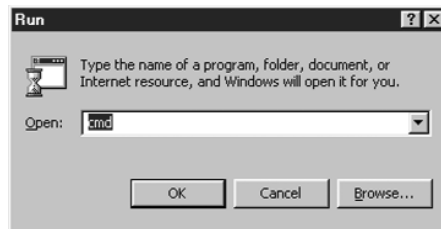

2. In the "Command Window", type "ipconfig /all".

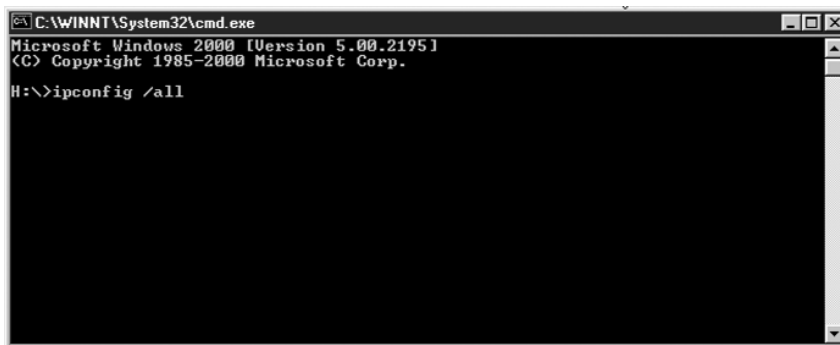

STEP 1: Obtain information about your Internet Service Provider (ISP) and your network

3. The information pictured below should appear.

```

C:\WINNT\System32\cmd.exe
H:\>ipconfig /all

Windows 2000 IP Configuration

    Host Name . . . . . : ericd-2k
    Primary DNS Suffix . . . . . :
    Node Type . . . . . : Hybrid
    IP Routing Enabled. . . . . : No
    WINS Proxy Enabled. . . . . : No
    DNS Suffix Search List. . . . . : belkin.com

Ethernet adapter Local Area Connection:

    Connection-specific DNS Suffix . : belkin.com
    Description . . . . . : 3Com EtherLink XL 10/100 PCI TX NIC
    (3C905B-TX)
    Physical Address. . . . . : 00-50-DA-05-D1-C7
    DHCP Enabled. . . . . : Yes
    Autoconfiguration Enabled . . . . : Yes
    IP Address. . . . . : 172.16.4.202
    Subnet Mask . . . . . : 255.255.252.0
    Default Gateway . . . . . : 172.16.4.1
    DHCP Server . . . . . : 172.16.4.63
    DNS Servers . . . . . : 172.16.4.75
                           172.16.4.86
    Primary WINS Server . . . . . : 172.16.4.75
    Secondary WINS Server . . . . . : 172.16.4.86
    Lease Obtained. . . . . : Monday, September 10, 2001 8:34:17 AM
    Lease Expires . . . . . : Tuesday, September 11, 2001 8:34:17 AM
H:\>

```

Please record your information in the chart below. It is important to make sure you have it, in case something goes wrong.

Write your IP Configuration settings here:	
Host name (If any):	
Adapter Address:	
IP Address:	
Subnet Mask:	
Default Gateway:	

STEP 2: Connect your computers to Router

Connecting Wired Computers to the Router

Up to three wired computers can be connected directly to the Router. In order for you to be able to connect your wired computers to the Router, each must be equipped with a network interface card (NIC) such as an internal PCI card (for desktop computers), a PC card (for laptop computers) or a USB Ethernet adapter (an alternative for USB-equipped computers only). Each computer connects to the Router via a network cable. You will need one network cable for each PC. The Router also connects to your cable or DSL modem via a network cable. Be sure you have the proper parts before starting. NOTE: Some cable or DSL modems connect to your computer using USB. Your cable or DSL modem must have an Ethernet connector on it to connect the Router. If your modem does not have an Ethernet connection, you must use a Belkin 5- or 8-Port Network Switch rather than the Router.

Connecting Wireless Computers to the Router

Wireless computers can directly access the router once the Router and your computers have been properly configured to do so. First, follow the steps to connect your modem to the Router, then skip to section “Step 3b: Setting up Wireless Computers for Connection to the Router”, on page 32, following.

Connect Your Equipment

Refer to the diagram below to aid in the connection process. Before beginning, please note that the connection process involves powering down your equipment and then powering it back up in correct sequence. **It is important that the equipment is powered on in the following order: modem first, Router second, computers last. Failure to follow this sequence may cause the network to fail to work properly.**

1. Power down your equipment.
Make sure that you have followed the steps to find your network configuration settings before you begin connecting your equipment. Be sure that the power to the Router, your modem, and all of your computers has been turned OFF.

STEP 2: Connect your computers to Router

2. Connect a Belkin CAT5 Network Cable between each of your wired computers and the Router.

Plug in a CAT5 network cable to the Ethernet port on each of the other PCs and then to one of the ports labeled "LAN" on the rear of the Router.

Note: It does not matter which LAN ports you connect your other computers to, but be sure that you are not connecting any of the computers to the port labeled "WAN".

3. Connect a Belkin CAT5 Network Cable between the Router and your cable or DSL modem.

Plug in another cable to the port labeled "WAN" on the Router and connect the other end of the cable to the cable or DSL modem's Ethernet port.

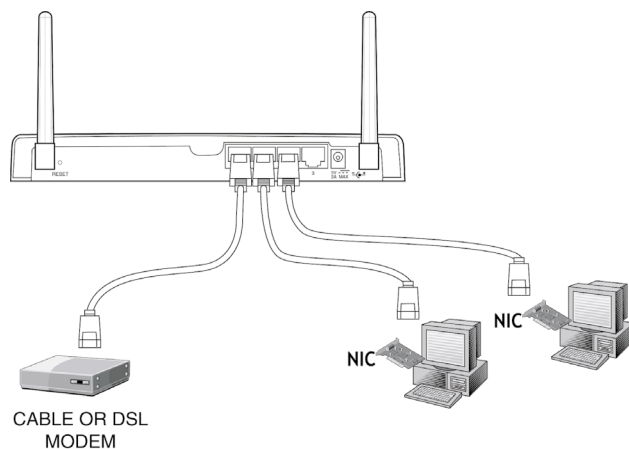

STEP 2: Connect your computers to Router

4. Power on the cable or DSL modem.
Depending on your modem, it may have a power switch or you may have to plug the power supply into it. **Be sure that the modem is turned on before the Router is turned on.**
5. Connect the power adapter to the Router.
Connect the power supply to the router to turn the router on. Again, be sure the modem is powered on before powering on the Router.
6. After the cable or DSL modem and the Router are turned on, the Router's WAN link light should be on. This indicates that the modem and the Router are connected together.
7. Turn on the rest of your computers and let them boot up. After your computers boot up, the LAN link lights on the front of the Router should be on for each port to which a computer is attached. Verify that your computers are connected by checking these lights.

Connection of your Router is now complete. The next step is to set up each of your computers to be able to communicate with your Router.

Go to Step 3.

STEP 3a: Set up your computers for networking

If you are familiar with setting up TCP/IP and file sharing on your computers, it is not necessary to use the Belkin SOHO Networking software. Each computer should be set up to "Obtain IP address Automatically (PC)" or use "DHCP (Mac)". Enable printer and file sharing on each computer if you wish to share resources.

Mac users, skip to the portion of this section that covers Mac computers. (see page 31)

If you are not familiar with setting up TCP/IP and file sharing on your PC, Belkin has simplified the process by providing you with the Belkin SOHO Networking software to configure your Windows 98 or Me computers. Follow the steps below to install this software on your computers. Windows 2000 users, follow the step called [Configuring Network Settings for Windows 2000](#).

Installing the Belkin SOHO Networking Software on your PC on your Windows 98/Me PC (Optional)

The SOHO networking software can be used to set up the networking setting on both wired and wireless-equipped computers. This software will allow you to configure network setting under Windows 98 and Me. If you are using Windows 2000 or XP, the SOHO networking will prompt you to launch the Network Control Panel. Use of the Belkin SOHO Networking Software is not necessary to configure your computers.

1. Insert the CD-ROM that came with the Belkin Wireless Cable/DSL Gateway Router into your CD-ROM drive of your computer connected to LAN Port-1.
2. Click "Start" then click "Run". Type "D:\NetSetup", where D:\ is the drive letter of your CD-ROM drive.
3. Click "OK". Windows will install the software onto your PC. Follow the directions on the screen to complete the installation. After the Belkin SOHO Networking Software is installed, Windows may ask you to restart your computer. If it does, please do.

STEP 3a: Set up your computers for networking

4. Repeat these steps for each computer you are connecting to your network.
5. Once you have installed the Belkin SOHO Networking Software on all of your computers, continue on to the next section.

Configuring Your PCs Using Belkin NetSetup (Win 98/Me)

1. Once your computer has restarted, click "Start", "Programs", "Belkin SOHO Networking" then "Belkin NetSetup" to launch this easy-to-use computer configurator. The following screen will appear: Select "I am setting up the Belkin Gateway Router" and click "Next".

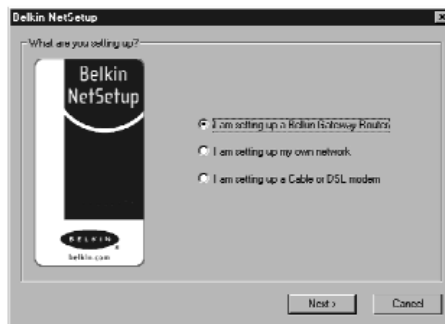

2. The following screen will appear: Select "I am setting up the first computer in my network" and click "Next".



STEP 3a: Set up your computers for networking

3. The following screen will appear:



4. In the "Computer Name" field type a name for the computer such as "Computer 1". The name must be different for each computer on the network.
5. In the "Workgroup" field, type a workgroup name such as "My Network". The workgroup name must be the same for each computer on the network.
6. The description field helps to identify the computer further. Type in a description such as "Windows 98". This description can be anything you want. It is not necessary for it to either match or be different from the description of any other computer on the network. You may also leave this field blank.

STEP 3a: Set up your computers for networking

7. After entering the information in the three fields, click “Next”. The following screen will appear:



8. If you want to share files and printers on this computer, select “I want to share files and printers on my computer” and click “Finish”. The following screen will appear:

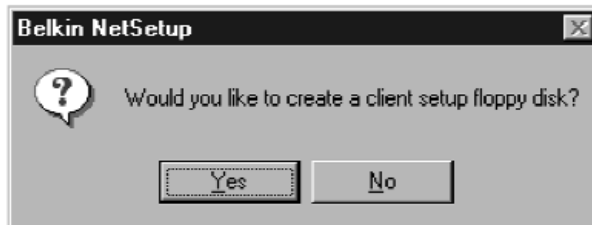

STEP 3a: Set up your computers for networking

9. NetSetup now needs to know if you want to create a client setup floppy disk. If you have more computers than you need to setup to work with the Router, click "Yes". This will save some files to the disk that your other computers can use to make setup easier. If you are not going to setup any more computers, click "No" and skip to step 11.
10. If you clicked "Yes", you will be prompted to insert a floppy disk into the PC's floppy disk drive. Label a floppy disk "Belkin Networking client setup disk" or something else that you will remember easily and insert it into the floppy disk drive. Click "OK."
11. After the client setup disk has been created, you will be prompted to restart your computer. Please restart your computer.

Configuring Additional Computers Using Belkin NetSetup Software (Win 98/Me)

Now that the first computer has been configured you are ready to configure the other PCs on your network.

1. You should now be working with the next computer. Click "Start", "Programs", "Belkin SOHO Networking" then "Belkin NetSetup" to launch the easy-to-use computer configurator. The following screen will appear:



STEP 3a: Set up your computers for networking

2. Select "I am adding this computer to my network". Click "Next".
3. Windows will now prompt you to insert the newly created client disk into the PC's floppy drive. Insert the disk you labeled "Belkin Networking" into the floppy drive and click "OK". The following screen will appear:



4. In the "Computer Name" field type a name for the computer such as "Computer 2". Remember, the name must be different from the other computers on the network.
5. The workgroup name should be filled in with the name you entered on the previous computer. Do not change this setting.
6. Type in a description such as "Windows 98". This can be anything you want and does not have to be different or the same as any other computer on the network. You may also leave this field blank.

STEP 3a: Set up your computers for networking

7. When finished filling in the fields, click "Next". The following screen will appear:



8. If you want to share files and printers on this computer, select "I want to share files and printers on my computer" and click "Finish". If not, select "I do not want to share files and printers on my computer". Click "Finish".
9. Now, please restart the computer.
10. Your PC is now configured. Repeat these steps for the rest of the computers on your network.

STEP 3a: Set up your computers for networking

Configuring Network Settings for Windows 2000

1. Right-click on “My Network Places” and select “Properties”.
2. In the “Network and Dial-up Connections” window, your “Local Area Connection” should be available.

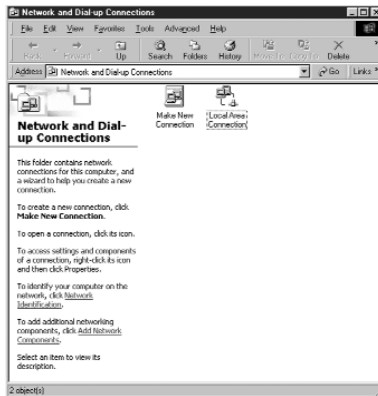

3. Right-click on “Local Area Connection” and select “Properties”.
4. Highlight “Internet Protocol (TCP/IP)” and click on “Properties”.



STEP 3a: Set up your computers for networking

5. Select “Obtain IP address automatically” and “Obtain DNS server address automatically”. Click “OK”. Windows may ask you to restart the computer. Do so to finish configuring your network settings.

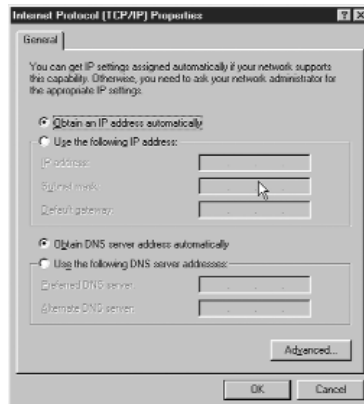

Configuring Network Settings on your Mac

1. Pull down the Apple Menu. Select “Control Panels” and select “TCP/IP”.
2. At “Connect Via:” choose either “Ethernet Built In” or “Ethernet” based on your Mac’s interface.

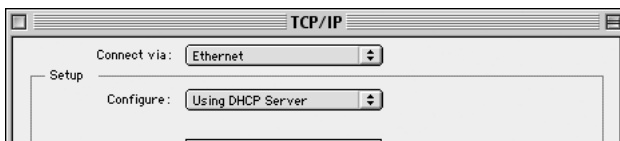

3. At “Configure”: choose “Using DHCP Server”. This will tell the computer to obtain an IP address from the Router.

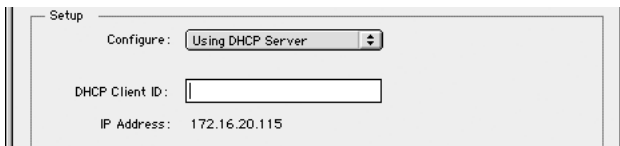

STEP 3a: Set up your computers for networking

Mac Continued

4. Close the window. The following window will appear. Click "Save".
5. Restart the Computer.

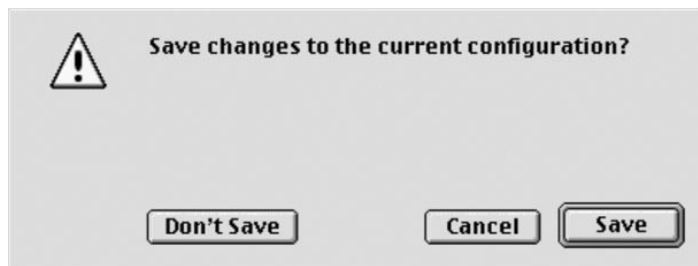

The last thing you need to do is set up the Belkin Wireless Cable/DSL Gateway Router to work with the Internet. To learn how to do this, go to Step 4.

STEP 3b: Setting up wireless computers for connection to the Router

This step assumes that you already have a wireless adapter installed on the computer(s) that you wish to connect wirelessly to the Router.

To connect to the Router wirelessly, you must set your computer's wireless settings to the same settings as those on the Router. Your Router ships from the factory with default settings for the SSID (ESSID), the Channel, and the Encryption.

1. Set the wireless computer's wireless configuration to match the Router's default settings. For information about changing these settings, refer to the documentation of your wireless network adapter. Change the settings to match the settings below:

Mode	Infrastructure
SSID	WLAN
Channel	11
Encryption	Disabled

2. If you have already set up your computer's networking settings using the Belkin SOHO Networking Software, skip this step. If not, either follow the directions in Step 3a, or if you are familiar with TCP/IP and file and peripheral sharing, configure the TCP/IP settings of the wireless adapter to "Obtain IP Address Automatically" (PC) or "Use DHCP" (Mac).

Verify That Your Computers are Networked

Windows

Once you have set up all of your computers, you can check to see if they are all "networked" together.

1. Starting with any computer, double-click on the "Network Neighborhood" icon on your desktop.
2. You should see an icon in the Network Neighborhood window with the name that you provided for your workgroup. Double-click this icon.

STEP 3b: Setting up wireless computers for connection to the Router

3. You should now see an icon for each computer you set up for the network. Please note, if the computers have just finished re-booting, it may take a few seconds for the computers to appear in the window.
4. If all of the computers appear in the window, then you have successfully networked your computers.

The last thing you need to do is set up the Belkin Wireless Cable/DSL Gateway Router to work with the Internet. To learn how to do this, go to Step 4.

Step 4: Configuring your Belkin Wireless Cable/DSL Router (the Router) for connection to the Internet

Now that you have your computers “networked” together, you now can set up the Router to share the Internet connection.

Configure the web browser

If you use Internet Explorer 4.0 or higher.

1. Start your web browser. Select “Tools” then “Internet Options”



2. In the “Internet Options” screen, there are three selections called “Never dial a connection”, “Dial whenever a network connection is not present” and “Always dial my default connection”. If you can make a selection, select “Never dial a connection”. If you cannot make a selection, go to the next step.



Step 4: Configuring your Belkin Wireless Cable/DSL Router (the Router) for connection to the Internet

3. Under the "Internet Options" screen, click on "Connections" and select "LAN Settings...".
4. Make sure there are no checkmarks next to any of the displayed options; "Automatically detect settings", "Use automatic configuration script" and "Use a proxy server". Click "OK". Then click "OK" again in the "Internet Options" page.

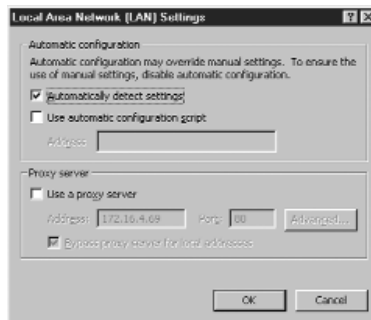

Your browser is now setup. Go to the **Accessing the Web Based Setup Utility**.
If you use Netscape Navigator 4.0 or higher.

1. Start Netscape. Click on "Edit" then "Preferences".
2. In the "Preferences" window, click on "Advanced" then select "Proxies". In the "Proxies" window, select "Direct connection to the Internet".

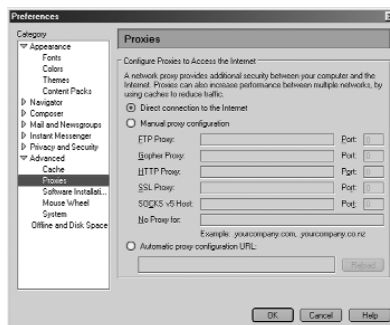

Your browser is now setup with the Router. Go to the **Accessing the Web Based Setup Utility**.

Step 4: Configuring your Belkin Wireless Cable/DSL Router (the Router) for connection to the Internet

Accessing the Web Based Setup Utility

By now, you should have the information about your Internet Service Provider written on the worksheet at the beginning of this manual. Please have it handy as you go through this procedure. Your Router is equipped with a setup utility that is 'web-based', which means that you will use your Internet browser to do the setup. To access the Router's setup utility use your web browser (either Internet Explorer or Netscape Navigator).

1. Using the computer that was originally connected directly to the Cable/DSL modem, launch your browser. When your browser launches, it will attempt to find your home page. In some cases, the router will be able to connect to the Internet without any further setup. If your home page is displayed in the browser, then no further setup is needed. You can begin surfing the net, or continue on to learn how to configure the router.

If a message pops up in the browser stating that the page could not be found, this is normal. Please go to the next step. Note: You can access the setup utility from any computer on the network, however, use the original computer for this procedure at this time.

2. In the address bar, type the following address: **192.168.2.1**.



Step 4: Configuring your Belkin Wireless Cable/DSL Router (the Router) for connection to the Internet

3. The Router login screen will appear.

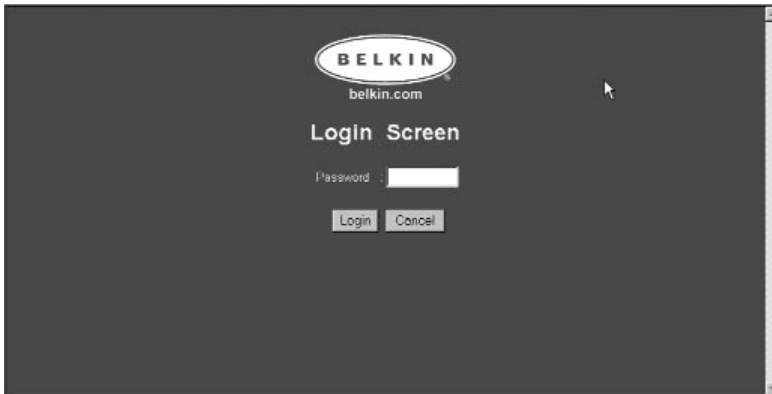

If this is the first time you are accessing the Router or you have not set a password for the Wireless Gateway Router, there is no need to enter a password. Click "Login".

4. The Router's initial setup page will appear.

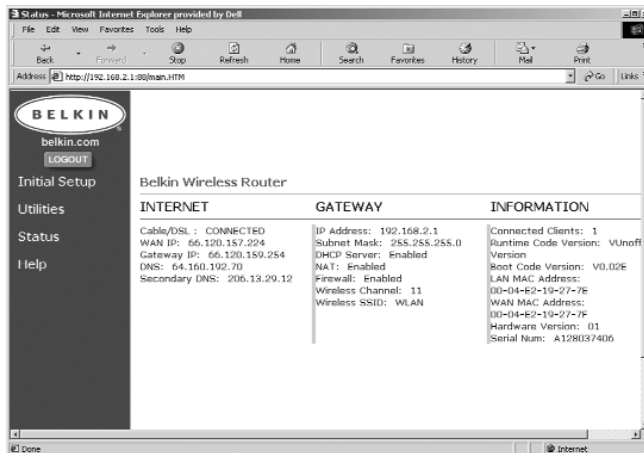

Step 4: Configuring your Belkin Wireless Cable/DSL Router (the Router) for connection to the Internet

Dynamic Setup

Configuring Your Router if your Provider uses Dynamic IP Addressing

Follow this procedure if your ISP uses dynamic IP addressing. The Router's default (factory) setting is set to dynamic. If your ISP has provided you with a Static IP address or your provider uses PPPoE for you to connect skip to the next section.

1. Click on "Initial Setup". The following screen will appear:

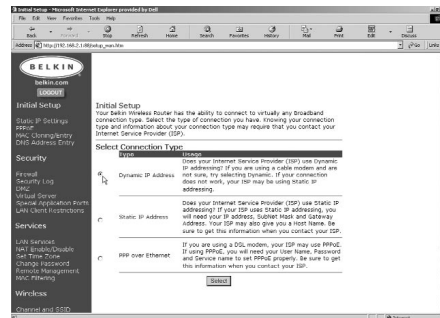

2. Select "Dynamic IP Address" and click "Select". This will tell the Router that the ISP provides a dynamic IP address.
3. Click "MAC Cloning/Entry" on the left-hand side of the screen. The following screen will appear.

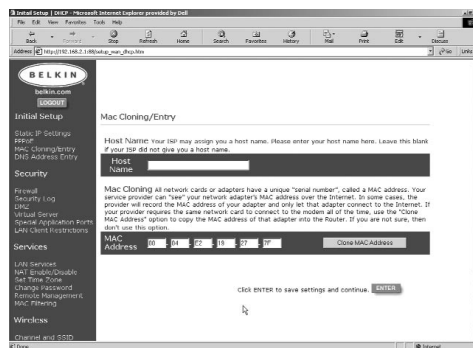

Step 4: Configuring your Belkin Wireless Cable/DSL Router (the Router) for connection to the Internet

4. If your ISP assigned you a host name, enter the host name here. If not, leave this field blank.
5. If your ISP binds the connection to a MAC address, you will need the Router to copy that MAC address. If your ISP does bind your MAC address, or you are not sure, follow this step. Click "Clone MAC Address". This will clone (copy) the MAC address of the first PC connected to the Router. This will also ensure that the ISP, if it binds your connection to that MAC address, that it will remain active. Click "Enter" to save the settings.

Finishing Dynamic Setup

At this point, initial setup of the Router is now complete for a dynamic configuration. To verify that your Router is connected to the modem, click on "Status" in the lower left hand corner of the router setup page. The status page shows you a variety of information about the Router's current state. Under the heading "INTERNET", the connection status is displayed as "Cable/DSL:" The word "Connected" will appear if the Router is connected to the Internet, this indicates that initial setup was successful.

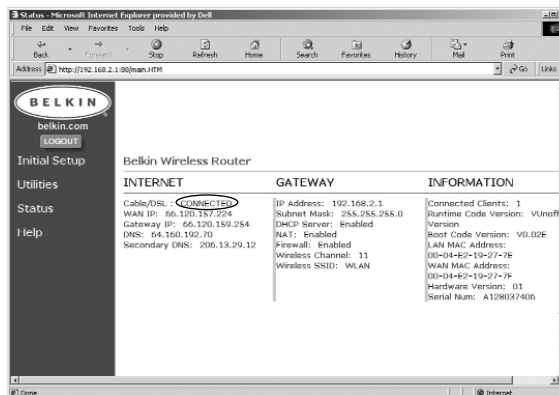

To begin browsing the Internet, log out of the setup utility by clicking on the "Logout" button. Once you have logged out, type a web address such as **www.belkin.com** into the browser's address bar. The browser should take you to the web address you entered. Other computers you have connected to the router should also have access to the Web. If you are having problems, see the troubleshooting section of this manual.

Step 4: Configuring your Belkin Wireless Cable/DSL Router (the Router) for connection to the Internet

Static IP Setup

Configuring Your Router if your Provider uses Static IP Addressing

If your ISP uses Static IP Addressing, follow this procedure. If your provider uses PPPoE, then skip to the next section.

1. Click on "Initial Setup". The following screen will appear:

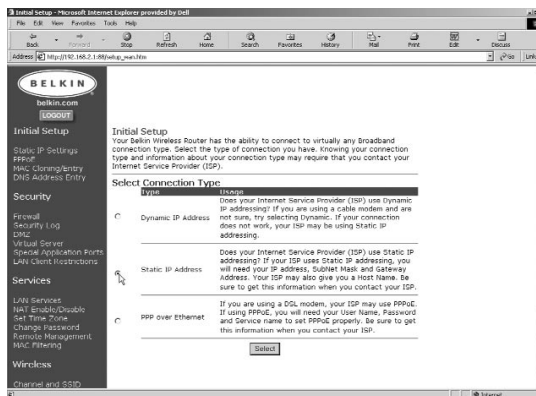

2. Select "Static IP Address" and click "Select". The following screen will appear:

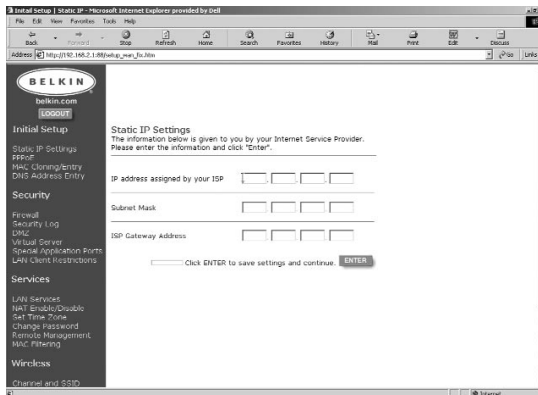

3. Enter your static IP address.
4. Enter your Subnet mask.
5. Enter the Router address.
6. Once you have filled in all of this information, click "Enter".

Step 4: Configuring your Belkin Wireless Cable/DSL Router (the Router) for connection to the Internet

7. The “MAC Cloning/Entry” screen will now appear.



8. If your ISP assigned you a host name, enter the host name here. If not, leave this field blank.
9. If your ISP binds the connection to a MAC address, you will need the Router to copy that MAC address. If your ISP does bind your MAC address, or you are not sure, click “Clone MAC Address”. This will clone (copy) the MAC address of the first PC connected to the Router. This will also ensure that the ISP, if it binds your connection to that MAC address, will remain active. Click “Enter” to save the setting.

Finishing Static Address Setup

At this point, initial setup of the Router is now complete for a static configuration. To verify that your Router is connected to the modem, click on “Status” in the lower left hand corner of the router setup page. The status page shows you a variety of information about the Router’s current state. Under the heading “INTERNET”, the connection status is displayed as “Cable/DSL:” The word “Connected” will appear if the Router is connected to the Internet, this indicates that initial setup was successful.

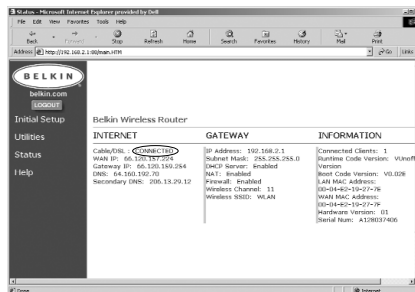

Step 4: Configuring your Belkin Wireless Cable/DSL Router (the Router) for connection to the Internet

To begin browsing the Internet, log out of the setup utility by clicking on the “Logout” button. Once you have logged out, type a web address such as **www.belkin.com** into the browser’s address bar. The browser should take you to the web address you entered. Other computers you have connected to the router should also have access to the Web. If you are having problems, see the troubleshooting section of this manual.

PPPoE

If you have a DSL modem and your Internet Service Provider gave you software such as WinPOET or Eternet300 that you use to connect to the Internet, follow these steps to set up your Router for PPPoE.

1. It is recommended that you uninstall the software that your ISP provided to you for connecting to the Internet. Before uninstalling the software from your computer, be sure you have a copy of the software in the event you want to re-install it at some point. If you do not uninstall the PPPoE software provided to you by your ISP, your connection may not work properly. To uninstall the software, Click on “Start” then “Settings” then “Control Panel”.

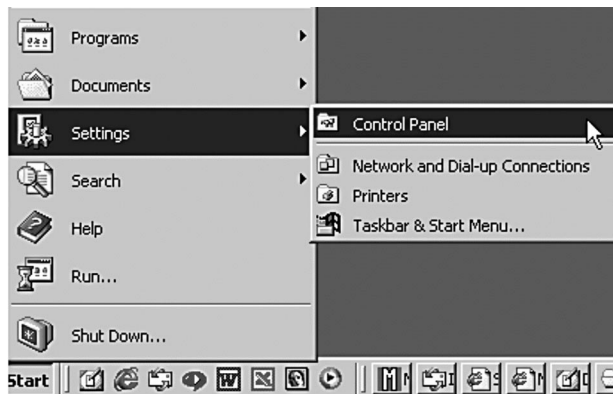

Step 4: Configuring your Belkin Wireless Cable/DSL Router (the Router) for connection to the Internet

2. The Control panel window will open. Double-click on "Add/Remove Programs"

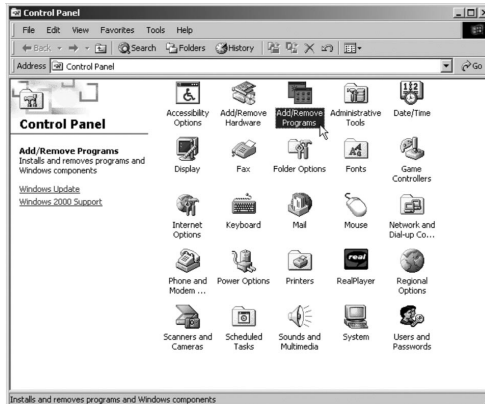

3. A list of programs installed on your computer will be displayed in the window. Locate the PPPoE software that was provided to you by your ISP and highlight it by clicking on it one time. Click the "Add/Remove" button and follow the steps to complete the removal of the software.
4. Once you have removed the PPPoE software, go back to your browser. Click on "Initial Setup" in the Router's user interface. The following screen will appear:

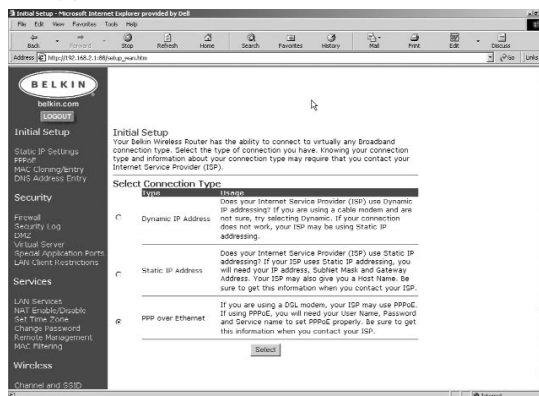

Step 4: Configuring your Belkin Wireless Cable/DSL Router (the Router) for connection to the Internet

5. Select "PPPoE" and click "Select". The following screen will appear:

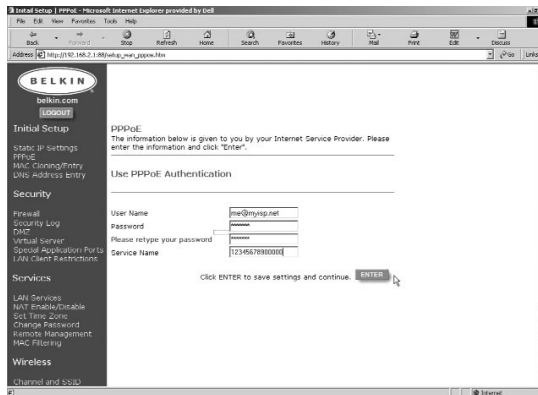

6. Enter your User Name. Your user name is the name that you use to log on such as "myaccount@dsl.com"

7. Enter your Password.

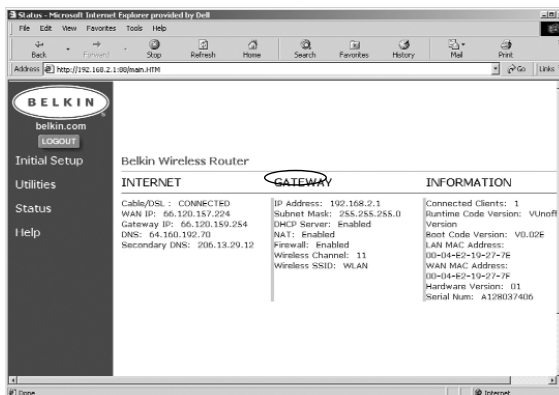

8. Type your password one more time to confirm your password was entered correctly.

9. Enter your Service Name. The service name is not always required. If you are not sure or you do not have a service name, then leave this blank.

10. Once you have filled in all of this information, click "Enter".

11. Pressing "Enter" will take you to the MAC/Cloning Entry page". Your setup is complete. Go to the next section called Finishing PPPoE Setup.

Step 4: Configuring your Belkin Wireless Cable/DSL Router (the Router) for connection to the Internet

Finishing PPPoE Setup

At this point, initial setup of the Router is now complete for a PPPoE configuration. To verify that your Router is connected to the modem, Click on "Status" in the lower left hand corner of the router setup page. The status page shows you a variety of information about the Router's current state. Under the heading "INTERNET", the connection status is displayed as "Cable/DSL :". The word "Connected" will appear if the Router is connected to the Internet, this indicates that initial setup was successful. To

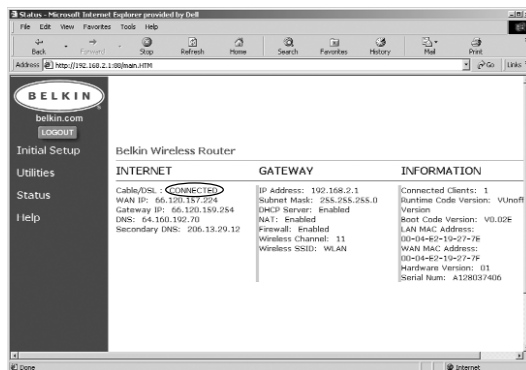

Browse the Internet

To begin browsing the Internet, log out of the setup utility by clicking on the "Logout" button. Typically, to connect to your Internet Service you would use the software that is provided by your ISP. With the Router now in place, you do not need to use this software to connect to the Internet. Simply type a web address such as **www.belkin.com** into the browser's address bar. If the Router is set up properly, the browser should take you to the web address you entered. Other computers you have connected to the router should also have access to the Web. If you are having problems connecting, you may need to uninstall the software that was provided to you by your ISP. If problems persist, see the troubleshooting section of this manual or contact Belkin's technical support hotline.

Wireless Configuration

Congratulations! You have successfully installed your Router. The further sections in this manual explain more about the advanced features of your Router. Please read through them to learn more about your Router.

Channel and SSID

From the Initial Setup page, click on “Channel and SSID”, under Wireless, in the right side of the screen, to access the Channel and SSID page.

Channel

The 802.11b wireless standard supports up to 14 channels. The number of available channels are limited to local regulations which determine which channels are available. FCC/IC: Channels 1-11. ETSI: Channels 1-13, France: Channels 10-13, Spain: Channels 10-11, MKK: Channels 1-14. The default channel is 11. To change the channel, click the DOWN arrow next to the channel field and select the channel number. When finished making changes, click “Enter” for the changes to take effect.

SSID

The Service Set Identifier (SSID) is like a name for the wireless network and is sometimes called the “Network Name”. The wireless-equipped computers in the wireless network should be set to the same SSID to gain access to the network. The default setting is “WLAN” (Wireless Local Area Network (WLAN)). To change the SSID, simply click in the SSID field and enter a new SSID.

When finished making changes, click “Enter” for the changes to take effect.

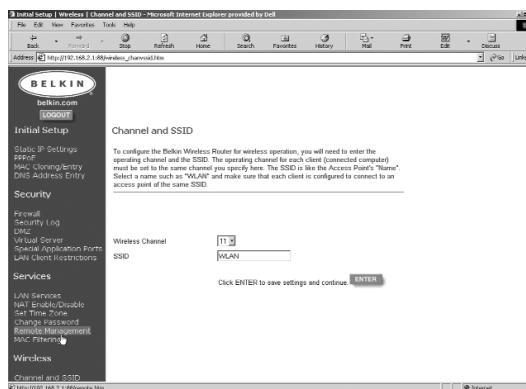

Wireless Configuration

Using WEP Encryption

From the Initial Setup page, click on “Encryption” under Wireless in the right side of the screen to access the Encryption page. The default setting for Encryption is “Disabled”.

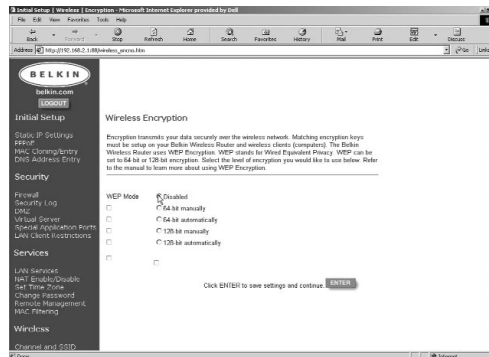

Setting Encryption

Encryption requires a key on both the Router and the wireless-equipped computer to match. Keys can be entered manually or automatically by typing a passphrase. The easiest method is the use of a passphrase. To Enable 64-bit manual encryption, select 64-bit manually from the menu. You will notice when using 64-bit manual encryption there are 4 keys labeled “Key 1” through “Key 4”. Only one key can be used at a time. In manual mode, keys can be entered manually, but for ease of use, the software can generate keys using a “Passphrase” that you enter. Select “64-bit automatically” and enter a passphrase. This passphrase can be easily distributed to wireless equipped computer users in your network. For instance, creating a key using the passphrase “Passphrase” generates 4 keys in 64-bit encryption mode. 128-bit encryption mode uses only one key. Keys can be manually entered or created with a passphrase. A user of a laptop needs only to enter the passphrase and the key number (key number for 64-bit only) into their computer’s wireless management software to be able to communicate while using encryption. All computers on the network must use the same encryption rate and passphrase. The passphrase can be changed as often as desired.

Other Features

MAC Address Cloning

If your ISP binds the connection to a MAC address, you will need the Router to copy that MAC address. If your ISP does bind your MAC address, or you are not sure, follow this step.

1. Click “MAC Cloning/Entry”. The following screen will appear:



2. Click “Clone MAC Address”. This will clone (copy) the MAC address of the first PC connected to the Router. This will also ensure that the ISP, if it binds your connection to that MAC address, that it will remain active. Click “Enter” to save the settings
3. Your Router is now set up and you will be able to access the Internet from any PC on your network.

Other Features

MAC Filtering

MAC filtering lets you control access to the network by allowing or disallowing specific MAC addresses to connect to the router. You can enter a list of up to twenty MAC addresses into the Router. This list is known as the Control List. By enabling MAC address control, then setting connection control settings and association control settings, you can keep your network more secure.

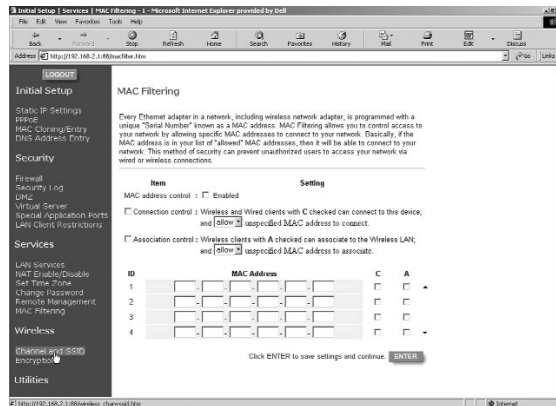

Connection control

Connection control lets you allow or deny connection to wired or wireless computers trying to access the Router. Enable Connection control by placing a checkmark in the box. Once you have entered a MAC address into the control table, putting a checkmark in the box under “C” will grant that computer full access to the network. Leaving the box unchecked will let the computer access the network to communicate with other wired computers, but that computer will not have Internet access or be able to communicate with wireless computers on the network. The “allow/deny” box lets you determine if computers with MAC addresses NOT in the control table are allowed access to the network and all of the resources such as Internet. Selecting “deny” will not let a computer connect unless the MAC address is in the control table.

Other Features

Association control

Association control works much like connection control. It lets you allow or deny connection to wireless computers trying to access the Router. Enable Access control by placing a checkmark in the box. Once you have entered a MAC address into the Control Table, putting a checkmark in the box under "A" will grant that wireless computer full access to the network. Leaving the box unchecked will let the computer access the network to communicate with other wireless computers, but that computer will not have Internet access or be able to communicate with wired computers on the network. The "allow/deny" box lets you determine if computers with MAC addresses NOT in the control table are allowed access to the network and all of the resources such as Internet. Selecting "deny" will not let a computer connect unless the MAC address is in the control table.

Association control has no effect on wired clients.

Security

Intrusion Detection On/Off

To access this feature, click on "Firewall" on the left side of the screen. The Router can monitor any attempts to access your network and alert you when it happens. If you want this feature to work, select "Enable".

Security Log

To access this log, click on "Security Log" on the left side of the screen. The Router will record any unauthorized attempts that have been made to gain access to your network. This screen will let you view a log of these attempts.

Other Features

DMZ Settings

To access this feature, click on “DMZ” on the left side of the screen. Demilitarized Zone (DMZ) is a feature that allows a computer to be exposed to the Internet by “placing” it outside of the firewall. This feature comes in handy when playing Internet games that don’t work well with a firewall. Also, streaming video applications can benefit from bypassing the NAT firewall security. To place a computer in the DMZ, enter the IP address of the computer here. The Router supports one computer in the DMZ. Please note that when a computer is not protected by the firewall it is open to hacker attacks. Use this feature only when needed.

Virtual Server Settings

The Router can be configured as a virtual server. Your WAN interface must use a fixed IP address to utilize the virtual server function. Using the virtual server function will allow clients accessing services such as Web or FTP at your local site via public IP addresses to be automatically redirected to

local servers configured with private IP addresses. In other words, depending on the requested service (TCP/UDP port number), the Router redirects the external service request to the appropriate server (located at another internal IP address). For example, if you set Type/Public Port to TCP/80 (HTTP or Web) and the Private IP/Port to 192.168.2.2, port 80, then all HTTP request from clients will be transferred to 192.168.2.2. Therefore, by just entering the IP Address provided by the ISP, Internet users can access the service they need at the local address to which you redirect them. Some of the more common TCP service ports include: HTTP: 80, FTP: 21, Telnet: 23 and POP3: 110.

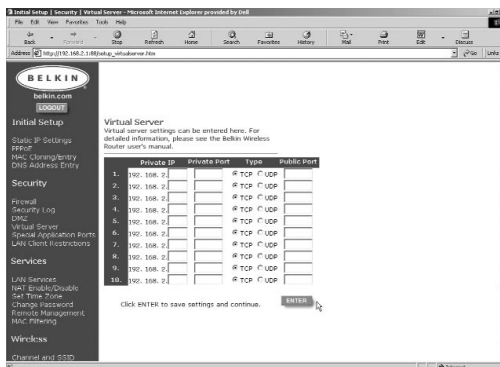

Other Features

Special Application Settings

Some applications require multiple connections, such as Internet gaming, videoconferencing, Internet telephony and others. These applications may not work when Network Address Translation (NAT) is enabled. If you need to run applications that require multiple connections, use the following screen to specify the additional public ports to be opened for each application. Specify the port normally associated with an application in the "Trigger Port" field, select the protocol type as TCP or UDP, then enter the public ports associated with the trigger port to open them for inbound traffic.

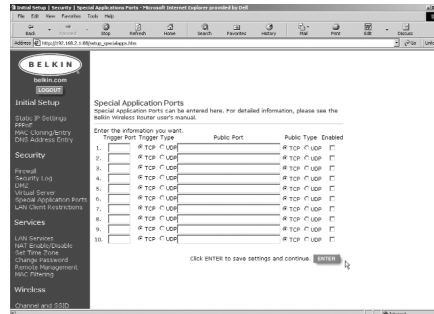

Note: If an application still cannot function correctly after enabling multiple ports via the Special Application screen, you may have to open the client PC for full Internet access using the DMZ Host option.

Client Filter Settings

Click on "LAN Client Restrictions". The Router can be configured to restrict Internet access to computers at specific days and times. For example, to restrict web access to the client at IP address 192.168.2.15 enter "15" and "15" in the IP field. Enter 80 (HTTP and Web) in the Port field. Select TCP. Select Block. Then select "Monday" and "Friday" then select "8:00AM" to "5:00PM". Lastly, click "Enable" and then click enter. Now the client at IP address 192.168.2.15 will not have Internet access from 8:00AM to 5:00PM.

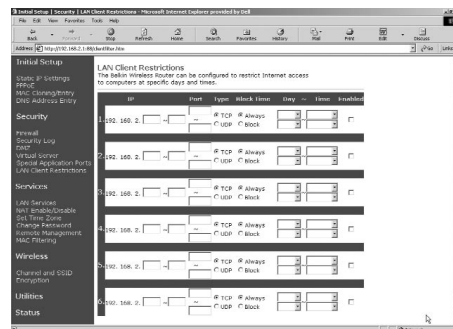

Other Features

Services

LAN DHCP Settings

Click on "LAN Services" to access this screen. Your Router allows you to specify an internal IP address. You may also turn the DHCP service on and off. We recommend using DHCP service for the easiest setup of your network. Making changes to this screen will require you to re-configure your networked PC's.

NAT Enable/Disable

Network Address Translation (NAT) is used for security by making your internal network invisible to the Internet. We recommend that you leave NAT enabled for security reasons.

Set Time Zone

If you are using any of the time-based functions of the Router such as Client Filtering, you will need to set the time zone you reside in for the function to work properly. Your Router automatically obtains the correct time from the Internet by using SNTP (Simple Network Time Protocol). There are many servers on the Internet which get the time from the atomic clock. The time is then broadcast over the Internet from these servers and then is received by your Router. You do not need to set the clock.

Change Password

The Router ships without a set password. It is not necessary to enter a password. If you choose not to use a password, leave the space blank. If you do choose to enter a password, be sure to write it down in a safe place. To set a password, enter it into the "New Password" field and confirm it in the next field. To change your password, enter your existing password and then enter the new password twice. If you forget your password, you can perform a manual reset of the router by pressing and holding the reset button for 5 seconds. When you release the button, the power light will begin flashing. Reset is done on the back of the Router.

Other Features

Remote Management

Any computer on your network can access the Router's built-in setup utility. The Remote Management feature allows a computer outside of the network to access the setup utility. When enabled, only the computer at the specified IP address can access the setup utility. Entering 0.0.0.0 will allow access by any computer.

Utilities

Access the Utilities screen by clicking on "Utilities".

Reset

If the Router stops functioning properly, you can reset or reboot the Router via the browser based software. Your settings will not be lost when performing a software reset. To perform a reset, click on the RESET button. You will be asked to confirm that you want to reset the Router. The power light will begin blinking and the port lights may blink. When the lights stop blinking, the Router has been reset.

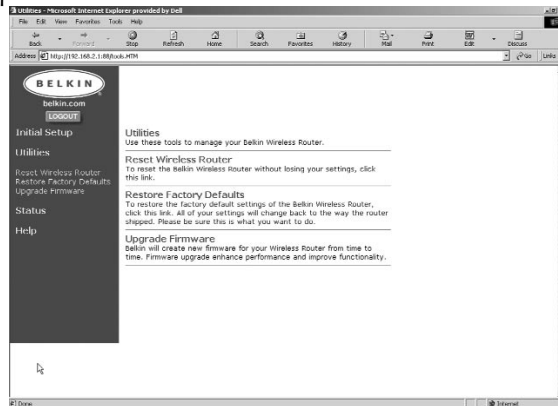

Restore Defaults

To restore the factory default settings of the Router, click this link. All of your settings will change back to the state they were in when the Router initially shipped. Please be sure this is what you want to do before clicking the Restore Defaults link.

Update Firmware

Belkin will create new firmware for your Router. Firmware updates enhance performance and improve functionality.

Wireless Networking Using 802.11b

To form a wireless network, two basic components are used. The first is a wireless adapter for a PC. This can be either a USB wireless adapter or a PCMCIA adapter. The adapter gives the PC wireless Ethernet capabilities. The second is a Wireless Access Point, which can connect to a wired LAN and allow the wireless PC's to be able to access the wired LAN. A Wireless Access Point can be a stand alone component or it can be embedded into a Cable/DSL router, thus forming a wireless Gateway/Router. The uses of each of these types of products is outlined later in this article.

Wireless networking is very similar to wired networking, except for a few basic concepts that one must grasp. There are two different ways to network computers using 802.11b. The first, and least used method is the Ad-Hoc method, also known as Peer-to-Peer. The more commonly used method is called Infrastructure Mode.

Ad-Hoc (Peer-to-Peer) Network

Ad-Hoc or Peer-to-Peer refers to a wireless configuration in which each computer communicates directly with another. An Ad-Hoc wireless LAN consists of a group of computers, each equipped with a wireless adapter, connected directly via radio signals to form an independent wireless LAN. Computers in a specific Ad-Hoc wireless LAN must be configured to the same radio channel to communicate with one another. More than one Ad-Hoc network can exist in the same space if it is configured to operate on a different channel. There are a varying number of channels depending on which part of the world you are operating in. The US has 11 channels, Europe has 13 channels and Japan has 14 channels. The following diagram shows a typical Ad-Hoc wireless LAN configuration.

Wireless Networking Using 802.11b

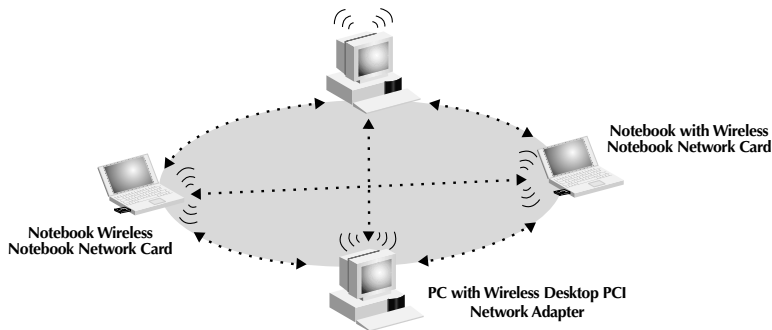

Infrastructure Mode

The use of a Wireless Access Point(WAP) to connect a wireless LAN to a wired LAN is called the Infrastructure Mode. A WAP serves as a bridge between the wired and wireless network. Connecting the Access Point to any port on the wired network will give wireless access to all wireless-equipped computers within its coverage area. An access point is configured with a Service Set Identifier, a “name” given to the wireless network and used by the wireless-equipped computers to access the wireless network. Access points can also be configured to use encryption or they can grant access to computers with specific MAC addresses. They effectively double the distance that computers in the wireless LAN can be located from one another. This is because the unit serves as a central point for routing of all the wireless network traffic between the wireless-equipped computers. Wireless-equipped computers networked together in Infrastructure Mode form a group called a Basic Service Set (BSS). Up to 64 individual computers can exist at a single time in a BSS. This is due to the ability of the WAP to handle no more than 64 clients. The diagram below illustrates how the WAP works to increase the covered area range of your wireless network.

Wireless Networking Using 802.11b

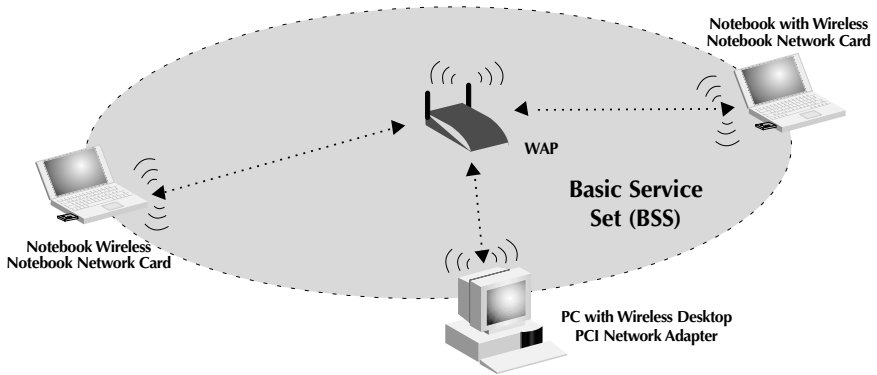

The diagram below illustrates how an WAP acts as a bridge between the wireless BSS and the wired network.

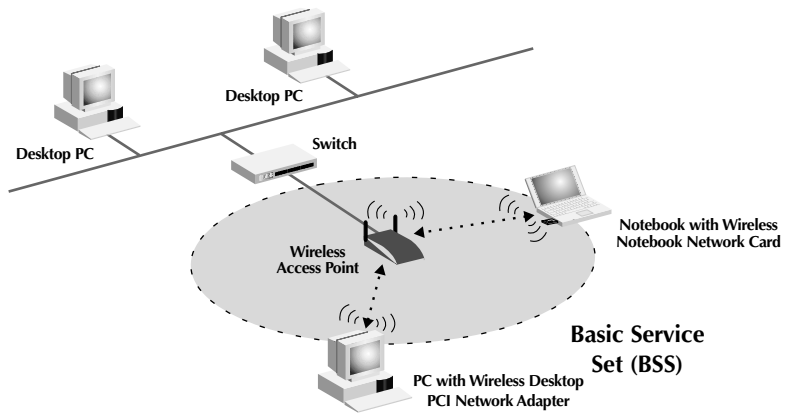

Wireless Networking Using 802.11b

Roaming

More than one WAP can be used to increase the wireless coverage in a wireless LAN. The diagram below shows two WAPs configured to extend coverage beyond that of a single unit. The overlapping area of each BSS is called Extended Service Set (ESS). When a wireless computer enters the ESS, the computer evaluates the signal strength and link quality, then chooses the WAP with the best quality signal and link. This activity is known as roaming. To configure your WAPs to allow roaming inside of the wireless network, each unit will be assigned the same Service Set Identifier (SSID). Strategically placing multiple units around an office or inside of the home can extend the wireless coverage to the entire premise. The illustration below shows two Basic Service Sets overlapping to form an Extended Service Set.

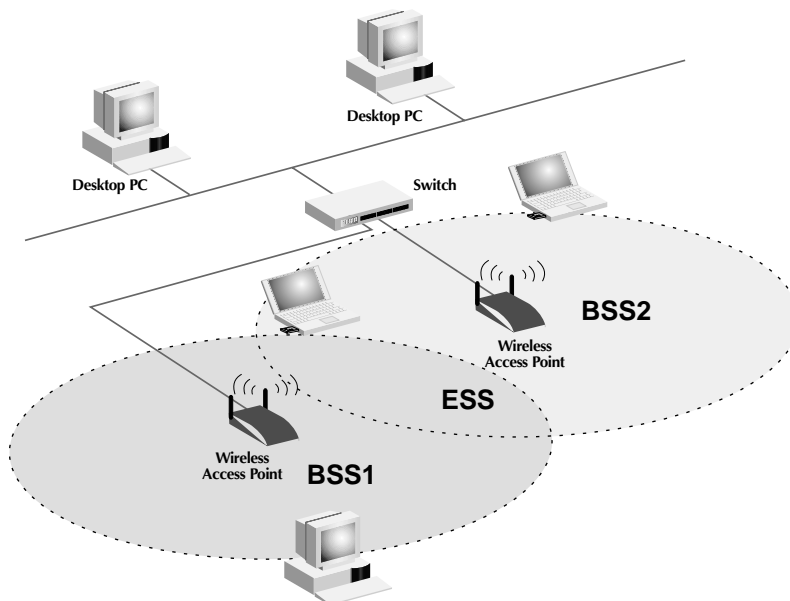

Glossary of Wireless Networking Terms

Access Point- An internetworking device that seamlessly connects wired and wireless networks.

Ad-Hoc - An Ad-Hoc wireless LAN is a group of computers each with LAN adapters, connected as an independent wireless LAN.

Backbone - The core infrastructure of a network. The portion of the network that transports information from one central location to another, where it is unloaded onto a local system.

Base Station - In mobile telecommunications, a base station is the central radio transmitter/receiver that maintains communications with the mobile radiotelephone sets within its range. In cellular and personal communications applications, each cell or micro-cell has its own base station; each base station in turn is interconnected with other cells or bases.

BSS - BSS stands for Basic Service Set. It is comprised of an Access Point and all the LAN PCs that are associated with it.

ESS - ESS (ESS-ID, SSID) stands for Extended Service Set. More than one BSS is configured to become an Extended Service Set. LAN mobile users can roam between different BSSes in an ESS (ESS-ID, SSID).

Ethernet - A popular local area data communications network, which accepts transmission from computers and terminals. Ethernet operates on a 10 or 100Mbps base band transmission rate, using a unshielded twisted pair cable.

Infrastructure - An integrated wireless and wired LAN is called an Infrastructure configuration.

Glossary of Wireless Networking Terms

Roaming - A wireless LAN mobile user moves around an ESS and maintains a continuous connection to the Infrastructure network.

RTS Threshold - Transmitters contending for the medium may not be aware of each other. RTS/CTS mechanism can solve this "Hidden Node Problem". If the packet size is smaller than the preset RTS Threshold size, the RTS/CTS mechanism will NOT be enabled.

WEP - Wired Equivalent Privacy is based on the use of 64-bit or 28-bit keys and the popular RC4 encryption algorithm. Wireless devices without a valid WEP key will be excluded from network traffic.

Glossary of Wired Networking Terms

DHCP - Dynamic Host Configuration Protocol. This protocol automatically configures the TCP/IP settings of every computer on your home network.

DNS Server Address - DNS stands for Domain Name System, which allows Internet host computers to have a domain name (such as belkin.com) and one or more IP addresses (such as 192.34.45.8). A DNS server keeps a database of host computers and their respective domain names and IP addresses, so that when a domain name is requested (as in typing "belkin.com" into your Internet browser), the user is sent to the proper IP address. The DNS server address used by the computers on your home network is the location of the DNS server your ISP has assigned.

Ethernet - A standard for computer networks. Ethernet networks are connected by special cables and switches, and move data around at up to 100 million bits per second [? or, megabits per second] (Mbps).

IP Address - IP stands for Internet Protocol. An IP address consists of a series of four numbers separated by periods, that identifies a single, unique Internet computer host. Example: 192.34.45.8.

ISP - Internet Service Provider. An ISP is a business that provides connectivity to the Internet for individuals and other businesses or organizations.

ISP Gateway Address - (see ISP for definition). The ISP Gateway Address is an IP address for the Internet router located at the ISP's office. This address is required only when using a cable or DSL modem.

LAN - Local Area Network. A LAN is a group of computers and devices connected together in a relatively small area (such as a house or an office). Your home network is considered a LAN.

MAC Address - MAC stands for Media Access Control. A MAC address is the hardware address of a device connected to a network. A MAC address is unique (different) for every device.

Glossary of Wired Networking Terms

NAT - Network Address Translation. This process allows all of the computers on your home network to use one IP address. Using the NAT capability of the Belkin 4-Port Cable/DSL Gateway Router, you can access the Internet from any computer on your home network without having to purchase more IP addresses from your ISP.

PPPoE - Point-to-Point Protocol over Ethernet. Point-to-Point Protocol is a method of secure data transmission originally created for dial-up connections; PPPoE is for Ethernet connections.

SPI - Stateful Packet Inspection. SPI is the type of corporate-grade Internet security provided by your Belkin 4-Port Cable/DSL Gateway Router. Using SPI, the gateway acts as a "firewall," protecting your network from computer hackers.

Subnet Mask - A subnet mask, which may be a part of the TCP/IP information provided by your ISP, is a set of four numbers configured like an IP address. It is used to create IP address numbers used only within a particular network (as opposed to valid IP address numbers recognized by the Internet, which must be assigned by InterNIC).

TCP/IP - Transmission Control Protocol/Internet Protocol. This is the standard protocol for data transmission over the Internet.

WAN - Wide Area Network. A network that connects computers located in geographically separate areas, (i.e., different).

Troubleshooting

<p>The WAN link LED is not on or I cannot connect to the cable or DSL modem.</p>	<p>1. Check the connection between the Router and the cable or DSL modem. Make sure the network cable from the cable or DSL modem is connected to the port on the Router labeled "WAN".</p>
	<p>2. Make sure the cable or DSL modem is powered and switched on.</p>
	<p>3. Make sure the Router has power. The Amber LED on the bottom of the front panel should be illuminated.</p>
	<p>4. Some cable or DSL modems require a crossover cable. Check with the manufacturer of your Cable/DSL modem for specifics about this.</p>
<p>My connection type is Static IP Address. I cannot connect to the Internet.</p>	<p>1. Since your connection type is Static IP Address, your ISP must assign you the IP address, subnet mask, and gateway address. Make sure that the Router's connection type is configured as "Static IP Address" and verify your settings.</p>
	<p>2. Your ISP may bind your connection to the MAC address of your computer's NIC. Clone your MAC address.</p>
<p>My connection type is Dynamic IP Address. I cannot connect to the Internet.</p>	<p>1. Make sure your computers are correctly configured and all network cables are properly connected.</p>

Troubleshooting

<p>My connection type is Dynamic IP Address. I cannot connect to the Internet.</p>	<p>2. Make sure the cable or DSL line is properly attached on your cable or DSL modem. Refer the manual of your modem to verify that it works normally.</p>
	<p>3. Make sure the network cable between the modem and the router is well connected. Power off the modem; wait a few seconds and then power it on again.</p>
	<p>4. Your ISP may bind your connection to the MAC address of your computer's NIC. Clone your MAC address.</p>
<p>My connection type is PPPoE. I cannot connect to the Internet.</p>	<p>1. Since your connection type is PPPoE, your ISP will assign you an account name and password and service name. Make sure the Router connection type is configured as PPPoE and fill these settings are entered properly.</p>
	<p>2. Make sure your computers are correctly configured and all network cables are properly connected.</p>
	<p>3. Make sure the coaxial cable or DSL line is properly attached on your cable or DSL modem. Refer the manual of your modem to verify it works normally.</p>

Troubleshooting

My connection type is PPPoE. I cannot connect to the Internet.	4. Make sure the network cable between modem and the Router is well connected. Power off the modem for a few seconds and power on it again.
	5. Your ISP may bind your connection to the MAC address of your computer's NIC. Clone your MAC address.

Information

FCC Statement

DECLARATION OF CONFORMITY WITH FCC RULES FOR ELECTROMAGNETIC COMPATIBILITY

We, Belkin Components, of 501 West Walnut Street, Compton, CA 90220, declare under our sole responsibility that the product,

F5D6230-3

to which this declaration relates, complies with Part 15 of the FCC Rules. Operation is subject to the following two conditions: (1) this device may not cause harmful interference, and (2) this device must accept any interference received, including interference that may cause undesired operation.

Caution: Exposure to Radio Frequency Radiation.

The radiated output power of this device is far below the FCC radio frequency exposure limits. Nevertheless, the device shall be used in such manner that the potential for human contact normal operation is minimized.

When connecting an external antenna to the device, the antenna shall be placed in such a manner to minimize the potential for human contact during normal operation. In order to avoid the possibility of exceeding the FCC radio frequency exposure limits, human proximity to the antenna shall not be less than 20cm (8inches) during normal operation.

Federal Communications Commission Notice

This equipment has been tested and found to comply with the limits for a Class B digital device, pursuant to Part 15 of the FCC Rules. These limits are designed to provide reasonable protection against harmful interference in a residential installation.

This equipment generates, uses, and can radiate radio frequency energy. If not installed and used in accordance with the instructions, it may cause harmful interference to radio or television reception, which can be determined by turning the equipment off and on, the user is encouraged to try and correct the interference by one or more of the following measures:

- Reorient or relocate the receiving antenna.
- Increase the distance between the equipment and the receiver.
- Connect the equipment to an outlet on a circuit different from that to which the receiver is connected.
- Consult the dealer or an experienced radio/TV technician for help.

Modifications

The FCC requires the user to be notified that any changes or modifications to this device that are not expressly approved by Belkin Components may void the users authority to operate the equipment.

Information

Canada- Industry Canada (IC)

The wireless radio of this device complies with RSS 139 & RSS 210 Industry Canada. This Class B digital complies with Canadian ICES-003.

Cet appareil numérique de la classe B conforme á la norme NMB-003 du Canada.

Europe-European Union Notice

Radio products with the CE 0678 or CE alert marking comply with the R&TTE Directive (1995/5/EC) issued by the Commission of the European Community.

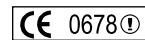

Compliance with this directive implies conformity to the following European Norms (in brackets are the equivalent international standards).



- EN 60950 (IEC60950) – Product Safety
- EN 300 328 Technical requirement for radio equipment
- ETS 300 826 General EMC requirements for radio equipment.

To determine the type of transmitter, check the identification label on your Belkin product.

Products with the CE marking comply with the EMC Directive (89/336/EEC) and the Low Voltage Directive (72/23/EEC) issued by the Commission of the European Community. Compliance with these directives implies conformity to the following European Norms (in brackets are the equivalent international standards).



- EN 55022 (CISPR 22) – Electromagnetic Interference
- EN 55024 (IEC61000-4-2,3,4,5,6,8,11)- Electromagnetic Immunity
- EN 61000-3-2 (IEC610000-3-2) - Power Line Harmonics
- EN 61000-3-3 (IEC610000) – Power Line Flicker
- EN 60950 (IEC60950) – Product Safety

Products that contain the radio transmitter are labeled with CE 0678 or CE alert marking and may also carry the CE logo.

Information

Belkin Components Limited Lifetime Product Warranty

Belkin Components warrants this product against defects in materials and workmanship for its lifetime. If a defect is discovered, Belkin will, at its option, repair or replace the product at no charge provided it is returned during the warranty period, with transportation charges prepaid, to the authorized Belkin dealer from whom you purchased the product. Proof of purchase may be required.

This warranty does not apply if the product has been damaged by accident, abuse, misuse, or misapplication; if the product has been modified without the written permission of Belkin; or if any Belkin serial number has been removed or defaced.

THE WARRANTY AND REMEDIES SET FORTH ABOVE ARE EXCLUSIVE IN LIEU OF ALL OTHERS, WHETHER ORAL OR WRITTEN, EXPRESSED OR IMPLIED. BELKIN SPECIFICALLY DISCLAIMS ANY AND ALL IMPLIED WARRANTIES, INCLUDING, WITHOUT LIMITATION, WARRANTIES OF MERCHANTABILITY AND FITNESS FOR A PARTICULAR PURPOSE.

No Belkin dealer, agent, or employee is authorized to make any modification, extension, or addition to this warranty.

BELKIN IS NOT RESPONSIBLE FOR SPECIAL, INCIDENTAL, OR CONSEQUENTIAL DAMAGES RESULTING FROM ANY BREACH OF WARRANTY, OR UNDER ANY OTHER LEGAL THEORY, INCLUDING BUT NOT LIMITED TO, LOST PROFITS, DOWNTIME, GOODWILL, DAMAGE TO OR REPROGRAMMING, OR REPRODUCING ANY PROGRAM OR DATA STORED IN, OR USED WITH, BELKIN PRODUCTS.

Some states do not allow the exclusion or limitation of incidental or consequential damages or exclusions of implied warranties, so the above limitations of exclusions may not apply to you. This warranty gives you specific legal rights, and you may also have other rights that vary from state to state.



Belkin Components

501 West Walnut Street
Compton • CA • 90220 • USA
Tel: 310.898.1100
Fax: 310.898.1111

Belkin Components, Ltd.

Unit 13 • Gatelodge Close • Round Spinney
Northampton • Northants • NN3 8RX • United Kingdom
Tel: +44 (0) 1604678300
Fax: +44 (0) 1604678330

Belkin Components B.V.

Starparc Building • Boeing Avenue 333
1119 PH Schiphol-Rijk • The Netherlands
Tel: +31 (0) 20 654 7300
Fax: +31 (0) 20 654 7349

Belkin Components, Ltd.

7 Bowen Crescent • West Gosford
NSW 2250 • Australia
Tel: +61 (2) 4372 8600
Fax: +61 (2) 4325 4277

P73830-B

© 2002 Belkin Components. All rights reserved. All trade names are registered trademarks of respective manufacturers listed.

Free Manuals Download Website

<http://myh66.com>

<http://usermanuals.us>

<http://www.somanuals.com>

<http://www.4manuals.cc>

<http://www.manual-lib.com>

<http://www.404manual.com>

<http://www.luxmanual.com>

<http://aubethermostatmanual.com>

Golf course search by state

<http://golfingnear.com>

Email search by domain

<http://emailbydomain.com>

Auto manuals search

<http://auto.somanuals.com>

TV manuals search

<http://tv.somanuals.com>