



Features

- 3-axis magnetoresistive-based technology; senses 3-dimensional changes to the Earth's magnetic field caused by the presence of ferrous objects
- Easy sensor installation (see page 4); above- or below-ground mounting options
- Compact, robust one-piece, self-contained sensor package replaces inductive-loop sensing technology; no external controller needed
- Designed to minimize the effects of temperature swings and destabilizing magnetic fields
- Sensor learns ambient background and stores settings in non-volatile memory
- Patented technologies†



Caution . . . For Factory-Approved Applications Only

This sensor is to be used only in factory-approved applications. See warning on page 2, and list of approved applications on page 3.

Models

Model	Cable*	Supply Voltage	Output Type	Range
S18MB	2 m (6.5') 5-conductor cable	10 to 30V dc	Bipolar NPN/PNP**	Range varies, depending on application and target being sensed. See Figures 5 and 6.
S18MBQ	5-pin Euro-style QD fitting			

* 9 m cables are available by adding suffix "W/30" to the model number of any cabled sensor (e.g., **S18MB W/30**). A model with a QD connector requires a mating cable; see page 8.

** Consult factory for other output options.

Approved Applications

See page 3 for more details on factory-approved applications

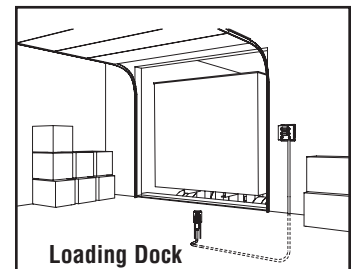
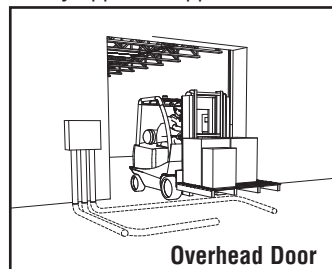
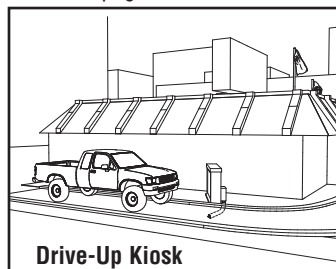
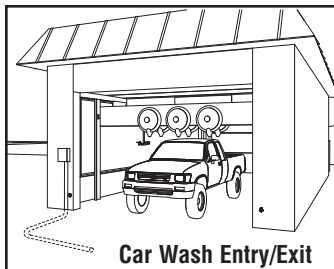

WARNING . . . Not To Be Used for Personnel Protection

Never use this product as a sensing device for personnel protection. Doing so could lead to serious injury or death.

This product does NOT include the self-checking redundant circuitry necessary to allow its use in personnel safety applications. A sensor failure or malfunction can cause either an energized or de-energized sensor output condition. Consult your current Banner Safety Products catalog for safety products which meet OSHA, ANSI and IEC standards for personnel protection.

M-GAGE[®] S18M — Vehicle Detection Sensor

Overview

The M-GAGE S18M sensor implements a passive sensing technology to detect large ferrous objects. The sensor measures the change in the Earth's natural magnetic field (the ambient magnetic field) caused by the introduction of a ferromagnetic object.

This easy-to-use sensor is extremely robust and is unaffected by dirt and moisture, making it ideal for demanding outdoor environments. Simple programming procedures provide flexibility for a variety of applications (see page 5).

Theory of Operation

The sensor uses three mutually perpendicular magnetoresistive transducers. Each transducer detects magnetic field changes along one axis. By incorporating three sensing elements, maximum sensor sensitivity is achieved.

A ferrous object will alter the local (ambient) magnetic field surrounding the object, as shown in Figure 1. The magnitude of this magnetic field change is dependent both on the object (its size, shape, orientation, and composition) and on the ambient magnetic field (its strength and orientation).

During a simple programming procedure, the S18M sensor measures the ambient magnetic field. When a large ferrous object (for example, a truck, automobile, or rail car) alters that magnetic field, the sensor detects the magnetic field changes (anomalies). When the degree of magnetic field change reaches the sensor's threshold, the sensor's discrete outputs switch.

Sensor Field of View and Range

The sensor range depends on three variables:

1. The local magnetic environment (including nearby ferrous material)
2. The magnetic properties of the object to be sensed
3. Sensor settings

The S18M can detect changes in the ambient magnetic field in all directions. As with other sensors, the range will depend on the target. The strong disturbance of a large ferrous object decreases as distance from the sensor increases, and the magnitude and shape of the disturbance is dependent on the object's shape and content.

The sensor can be programmed to react to magnetic field disturbances of greater or lesser intensity, using two adjustments: background condition and sensitivity level.

Once background condition and sensitivity level are set, and both settings are stored in non-volatile memory, the sensor is ready to detect the target object.

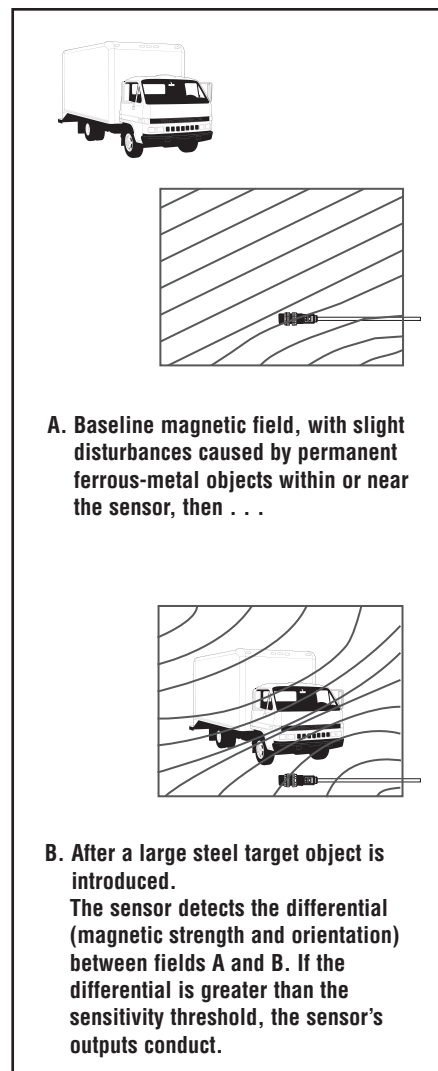

Figure 1. Magnetic detection overview



WARNING . . . Appropriate Use

The mechanical opening, braking, and reversing systems of the door will not respond in sufficient time to prevent moving trucks, cars, or material handling vehicles, even those traveling at low speeds, from coming in contact with the door. In addition, the detection zone of the product may fluctuate due to changes in the local magnetic environment. All vehicles should approach doors at speeds that allow the operator to ensure the door is operating properly and in an open position. **Failure to follow these procedures may result in serious injury or death.**

M-GAGE® S18M — Vehicle Detection Sensor

Approved Applications

The M-GAGE sensor provides a direct replacement for inductive loop systems, and needs no external frequency controller box. Unique mounting solutions allow an M-GAGE sensor to be replaced easily without disrupting or re-cutting the pavement.

Car Wash Entry/Exit

The Banner M-GAGE vehicle detection sensor will reliably detect vehicles in and around car wash bays. It will reliably detect the presence or absence of a vehicle to provide collision avoidance at the exit of a conveyORIZED tunnel, provide an entry or exit-door trigger, or trigger an undercarriage wash.

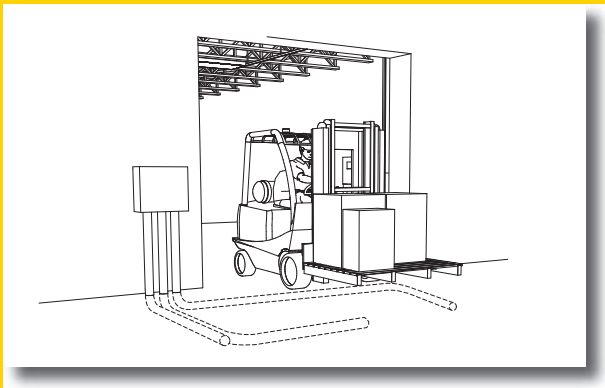
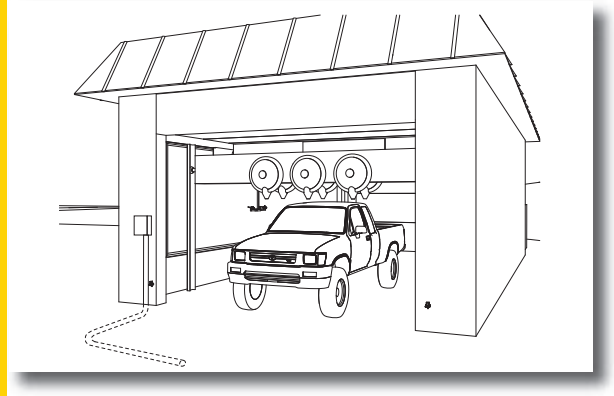

Overhead Door

The Banner M-GAGE sensor can be used to trigger the opening and closing of high-traffic internal overhead doors. Mounted in the floor, it will reliably detect forklifts or trucks as they approach the doors. Banner's applications engineers are available to help determine proper sensor placement for specific door-trigger applications.

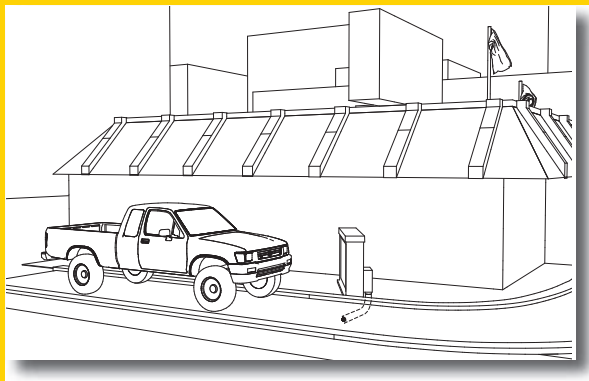

Drive-Up Kiosk

The Banner M-GAGE sensor reliably detects vehicles at drive-through systems or other drive-up kiosks. It will reliably detect a vehicle to trigger personnel that a vehicle is present, and to initiate a timing system.

Loading Dock

The Banner M-GAGE sensor provides multiple advantages for loading docks. It will reliably detect the presence of a vehicle as it backs into a dock, triggering a light on the interior of the building to notify the dock attendant that a vehicle is in position for loading/unloading. The M-GAGE can also be used to trigger dock/ramp leveling systems.

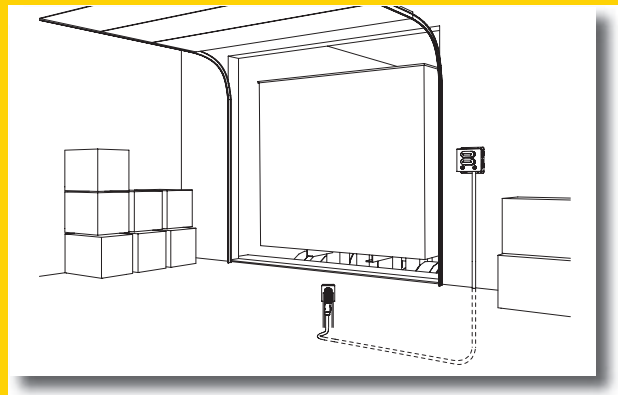

M-GAGE[®] S18M — Vehicle Detection Sensor

Below-Grade Installation

Materials

- M-GAGE S18M Sensor
- SMP1 Conduit Plug
- 2" Schedule 80 rigid PVC conduit (1.5" may be used if there is only one 90° bend); total length and number of elbows depend on installation layout
- 2" (or 1.5") rigid PVC end cap (1 per installation)
- 3/4" I.D. flexible, liquid-tight, non-metallic conduit (same length as PVC conduit used for application)
- DPB1 Portable Programming Box

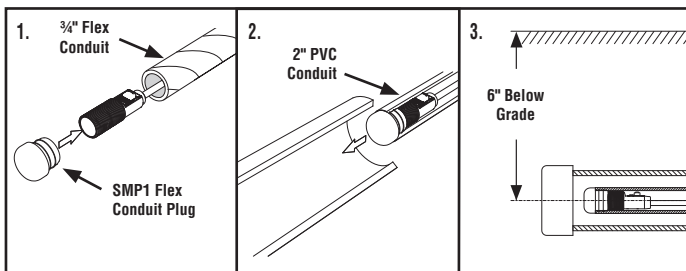

Figure 2. Below-grade installation

Procedure

- 1) Lay out 2" (or 1.5") PVC in the desired configuration. For the best sensor performance, the sensing location (located at the end of the conduit run) should be 6" below the final surface. Provide an access point where the PVC comes above grade (where the sensor and flex conduit can be fed in or pulled out, as required).
- 2) Secure the end cap to the PVC, at the sensing location.
- 3) Measure the overall length of the PVC run, from the sensing location to the control panel.
- 4) Cut a section of 3/4" flex conduit to span the total distance from the control panel to the sensing location.
- 5) Thread the sensor into the SMP1 conduit plug. Feed the sensor cable into the flex conduit, until the sensor and plug are snugly seated in the end of the flex conduit.
- 6) Feed the flex conduit by hand, sensor-end first, into the PVC access point until the sensor reaches the PVC end cap.
- 7) Secure the remaining flex conduit from the access point to the control cabinet.
- 8) After the sensor is configured (see following sections), wire the sensor into the control device and power supply per the wiring diagram on page 8.

Above-Grade Installation

Materials

- M-GAGE S18M Sensor
- SMP2 Conduit Plug
- 3/4" Schedule 40 PVC electrical conduit; total length and number of elbows depend on installation layout
- Electrician's fishtape
- Silicone adhesive
- DPB1 Portable Programming Box

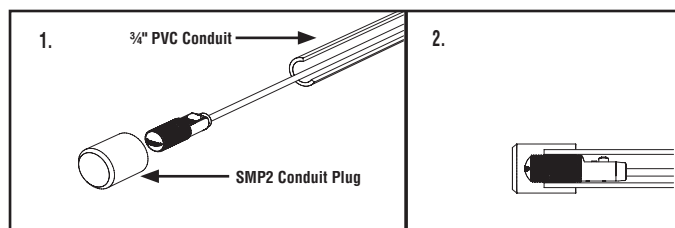

Figure 3. Above-grade installation

Procedure

- 1) Mount the PVC electrical conduit from the sensing point to the control panel. Plastic conduit should be used for at least the first 6.1 m (20') from the sensing point; metal or flexible conduit may be used the remainder of the distance.
- 2) Thread the S18M sensor into the threads of the SMP2 conduit plug.
- 3) Feed the fishtape into the conduit, from the control panel towards the sensing point.
- 4) Pull the sensor cable back through the conduit, until the sensor *almost* reaches the end of the plastic conduit. Do NOT pull sensor into conduit.
- 5) Apply a small amount of silicone adhesive to the outside of the conduit at the sensing point end.
- 6) Press the conduit plug into the end of the conduit.
- 7) After the sensor is configured (see following section), wire the sensor into the control device and power supply per the wiring diagram on page 8.

M-GAGE® S18M — Vehicle Detection Sensor

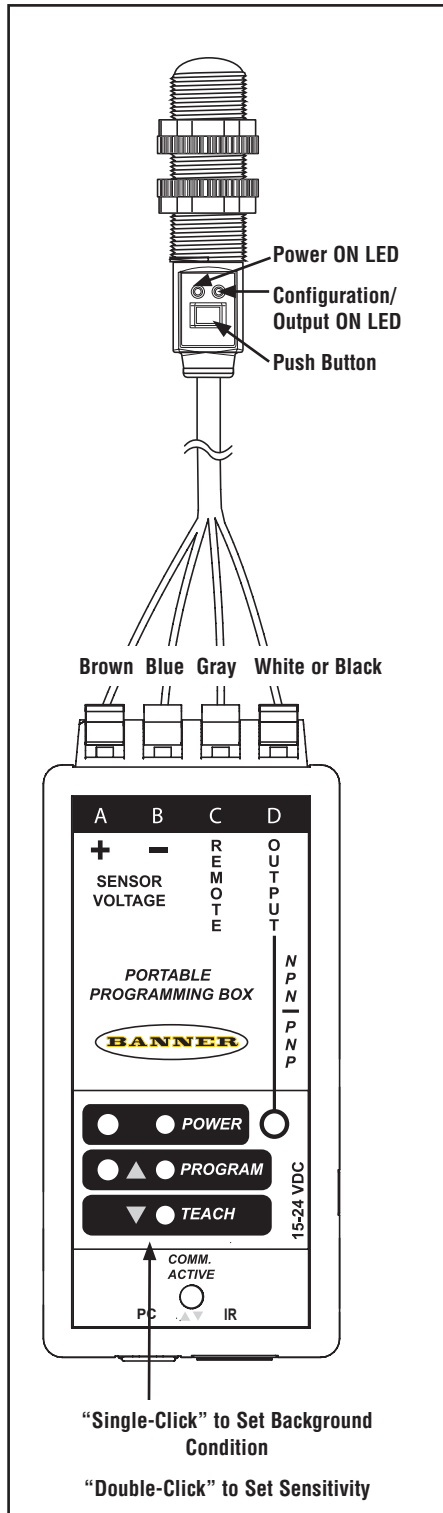

Figure 4. Using the model DPB1 portable programming box

Sensor Configuration

For most applications, configure the M-GAGE sensor remotely, via the DPB1 Portable Programming Box, which provides programming access to an underground or otherwise inaccessible sensor. For optimum performance, the sensor must be fixtured so that it will not move either during or following configuration.

Configuration using the sensor's built-in push button is useful primarily for demonstration and troubleshooting purposes.

Configuration via the DPB1 Portable Programming Box

Set Background Condition (No Vehicle Present)		
Wired the M-GAGE sensor to the DPB1 as shown in Figure 4. Remove all vehicles and all other metal objects temporarily in the sensing area, before setting the background condition.		
Configuration		Result
Set Background	<ul style="list-style-type: none"> “Click” the DPB1 TEACH push button once. 	<ul style="list-style-type: none"> Sensor learns background. Output indicator LED flashes approximately 12 times, while background is taught. Sensor returns to RUN mode.
Set Sensitivity Level (6 sensitivity levels; level 1 least sensitive, level 6 most sensitive)		
Configuration		Result
Sensitivity Mode	<ul style="list-style-type: none"> “Double-click” the DPB1 TEACH push button. 	<ul style="list-style-type: none"> Output LED flashes every 2 seconds; sensor is at sensitivity level 1. (When using the DPB1, the sensor always reverts to sensitivity level 1.)
Adjust Sensitivity	<ul style="list-style-type: none"> To increase the sensitivity in increments, “click” the push button again; continue until desired sensitivity level is reached. 	<ul style="list-style-type: none"> Output LED will flash from 1 to 6 times every 2 seconds to indicate sensor's sensitivity level (e.g., twice to indicate level 2).
	<ul style="list-style-type: none"> “Double-click” push button to save setting. 	<ul style="list-style-type: none"> Sensor returns to RUN mode
Test Operation	<ul style="list-style-type: none"> Drive a vehicle past/over sensor to trip the output; verify Output LED comes ON as expected. Use a small/light vehicle to ensure larger vehicles will be detected later. Adjust the sensitivity as needed. 	
Prepare for Operation	<ul style="list-style-type: none"> Disconnect DPB1 and hardwire sensor to permanent power supply/output device (user-supplied). See page 8. 	

Configuration via the Sensor Push Button (For demonstration and troubleshooting only.) Follow the instructions in the table above, with the following exceptions.

Set Background Condition (No Vehicle Present):

- Press and hold the push button for 2 seconds, until the Output LED turns red.
- Release, and then “click” the push button once.

Set Sensitivity Level:

- Press and hold the push button for 2 seconds, until the Output LED turns red.
- Release, and then quickly “double-click” the push button. Increase the sensitivity by increments as described above.
- When the sensor is set to desired sensitivity level, double-click push button to return sensor to RUN mode.

M-GAGE[®] S18M — Vehicle Detection Sensor

Excess Gain

Typical Target Excess Gain Curves

Once the sensor has been securely mounted and is configured, it is ready to operate. The following two example applications show typical responses for the M-GAGE sensor.

Example 1 describes mounting the M-GAGE 1 meter above the ground to sense an automobile; see Figure 5. The graph in Figure 5 shows the excess gain for a typical car. Excess gain is a measure of the amount of “extra” signal detected by the sensor over and above the level needed to detect the target. This example assumes a level 5 sensitivity threshold. The table at right compares the change in excess gain if the sensitivity level changes.

Excess Gain vs Sensitivity Level (Assumes Level 5)	
Level	Excess Gain Multiplier
1	0.33
2	0.4
3	0.5
4	0.66
5*	1.0
6	1.3

*Factory default setting

If the sensitivity is at level 6, then the excess gain at a given distance would be 1.3 times larger than for a level 5 sensitivity. Conversely, if the sensitivity threshold is level 1, then the excess gain would be one third as big as for level 5.

Example 2 (see Figure 6) illustrates a typical vehicle passing over a sensor mounted underground. Note that excess gain is greatest when the bulk of the vehicle (the rear axle) is positioned directly over the sensor.

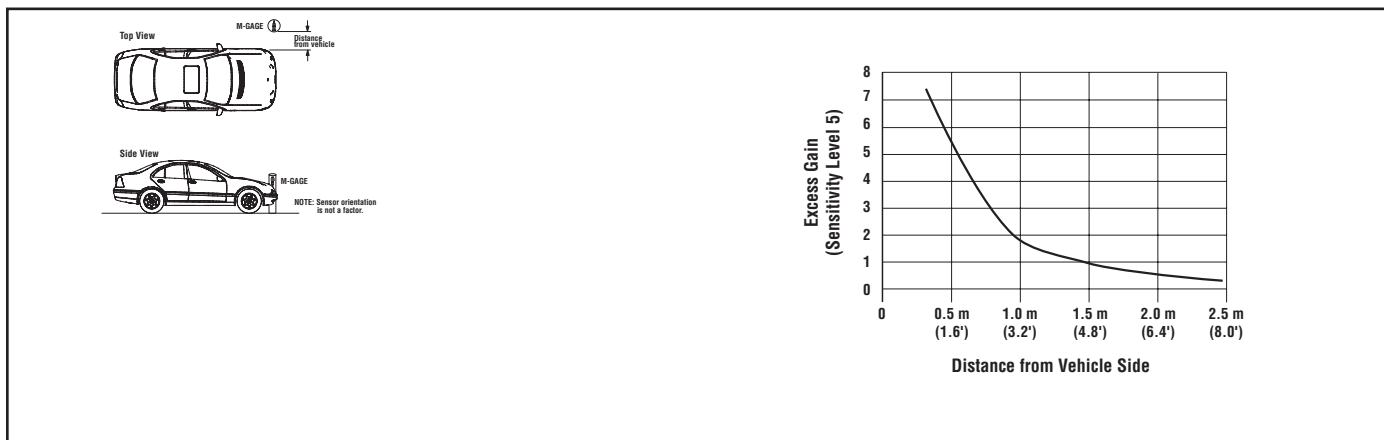

Figure 5. Application example 1: sensor mounted 1 meter (3.2') above ground

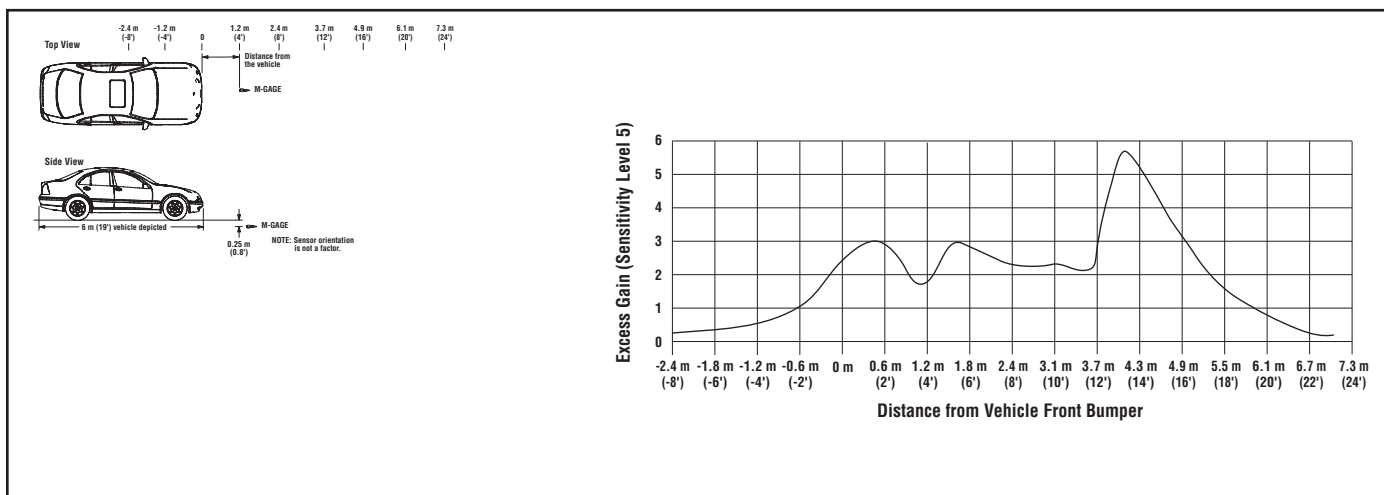

Figure 6. Application example 2: sensor mounted 0.25 meters (0.8') below ground

M-GAGE® S18M — Vehicle Detection Sensor

Specifications

Supply Voltage	10 to 30V dc (10% max. ripple) at 43 mA, exclusive of load Above +50°C, supply voltage is 10 to 24V dc (10% max. ripple)
Sensing Range	See Figures 5 and 6.
Sensing Technology	Passive 3-axis magnetoresistive transducer
Supply Protection Circuitry	Protected against reverse polarity and transient voltages
Output Configuration	Two SPST solid-state outputs conduct when object is sensed; one NPN (current sinking) and one PNP (current sourcing)
Output Protection	Protected against short-circuit conditions
Output Ratings	10 mA maximum (each output) NPN saturation: < 200 mV @ 10 mA and < 600 mV @100 mA; OFF-state leakage current: < 200 microamps PNP saturation: < 1.2V @ 10 mA and < 1.6V @100 mA; OFF-state leakage current: < 5 microamps
Output Response Time	20 milliseconds
Delay at Power-Up	0.5 seconds
Temperature Effect	< 0.5 milligauss/°C
Adjustments	Configuration of Background Condition and Sensitivity Level may be set using the sensor's push button or remotely via the portable programming box (see page 5)
Indicators	Two indicators (see Figure 4 and instructions on page 5): Power Indicator (Green) Configuration/Output Indicator (Red/Yellow)
Remote TEACH Input	Impedance 12K ohms
Construction	Threaded Barrel: Thermoplastic polyester Push Button Housing: ABS/PC Push Button: Santoprene Lightpipes: Acrylic
Operating Conditions	-40° to +70° C (-40° to +158° F); 100% max. rel. humidity
Connections	2 m or 9 m shielded 5-conductor (with drain) PVC jacketed attached cable or 5-pin Euro-style quick-disconnect (see page 8 for quick-disconnect cable options)
Environmental rating	Leak proof design is rated IEC IP67; NEMA 6P
Vibration and Mechanical Shock	All models meet Mil. Std. 202F requirements method 201A (vibration: 10 to 60Hz max., double amplitude 0.06", maximum acceleration 10G). Also meets IEC 947-5-2: 30G 11 ms duration, half sine wave.

Dimensions

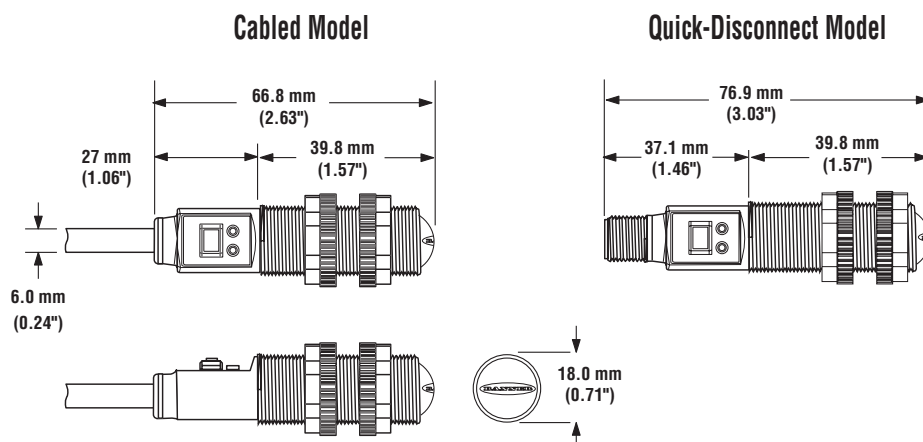

M-GAGE[®] S18M — Vehicle Detection Sensor

Hookups

Cabled Model

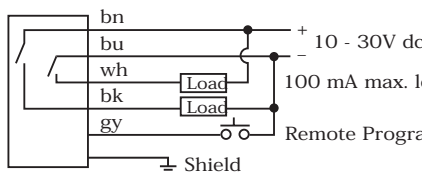

Quick-Disconnect Model

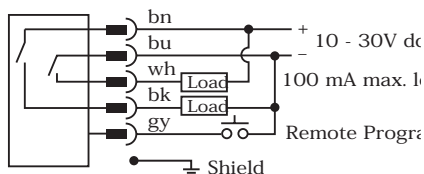

Pin-Out

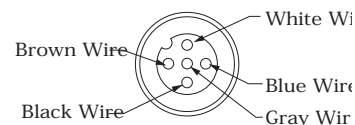

Accessories

Model	Description	
SMP1	Conduit Plug for 3/4" flexible conduit, used for below-grade installations	
SMP2	Conduit Plug for 3/4" rigid conduit, used for above-grade installations	
DPB1	Handheld Portable Programming Box, used for configuring sensor when push button is not accessible	

Quick-Disconnect Cables

Style	Model	Length	Connector	Style	Model	Length	Connector
5-Pin Euro, Straight with shield	MQDEC2-506 MQDEC2-515 MQDEC2-530	2 m (6.5') 5 m (15') 9 m (30')		5-Pin Euro, Right-angle with shield	MQDEC2-506RA MQDEC2-515RA MQDEC2-530RA	2 m (6.5') 5 m (15') 9 m (30')	



WARRANTY: Banner Engineering Corp. warrants its products to be free from defects for one year. Banner Engineering Corp. will repair or replace, free of charge, any product of its manufacture found to be defective at the time it is returned to the factory during the warranty period. This warranty does not cover damage or liability for the improper application of Banner products. This warranty is in lieu of any other warranty either expressed or implied.

Free Manuals Download Website

<http://myh66.com>

<http://usermanuals.us>

<http://www.somanuals.com>

<http://www.4manuals.cc>

<http://www.manual-lib.com>

<http://www.404manual.com>

<http://www.luxmanual.com>

<http://aubethermostatmanual.com>

Golf course search by state

<http://golfingnear.com>

Email search by domain

<http://emailbydomain.com>

Auto manuals search

<http://auto.somanuals.com>

TV manuals search

<http://tv.somanuals.com>