

**AXIS 231D+/232D+**  
**Network Dome Camera**

**User's Manual**

## 2 About This Document

This manual is intended for administrators and users of the AXIS 231D+/232D+ Network Dome Camera, and is applicable for software release 4.47. It includes instructions for using and managing the AXIS 231D+/232D+ on your network. Previous experience of networking will be of use when installing and using this product. Some knowledge of UNIX or Linux-based systems would also be beneficial, for developing shell scripts and applications. Later versions of this document will be posted to the Axis Website, as required. See also the product's online help, available via the Web-based interface.

### Intellectual Property Rights

Axis AB has intellectual property rights relating to technology embodied in the product described in this document. In particular, and without limitation, these intellectual property rights may include one or more of the patents listed at <http://www.axis.com/patent.htm> and one or more additional patents or pending patent applications in the US and other countries. This product includes software developed by the OpenSSL Project for use in the OpenSSL Toolkit: <http://www.openssl.org/>

### Legal Considerations

Camera surveillance can be prohibited by laws that vary from country to country. Check the laws in your local region before using this product for surveillance purposes. This product includes one (1) MPEG-4 decoder license. To purchase further licenses, contact your reseller.

### Electromagnetic Compatibility (EMC)

This equipment generates, uses and can radiate radio frequency energy and, if not installed and used in accordance with the instructions, may cause harmful interference to radio communications. However, there is no guarantee that interference will not occur in a particular installation. If this equipment does cause harmful interference to radio or television reception, which can be determined by turning the equipment off and on, the user is encouraged to try to correct the interference by one or more of the following measures: Re-orient or relocate the receiving antenna. Increase the separation between the equipment and receiver. Connect the equipment to an outlet on a different circuit to the receiver. Consult your dealer or an experienced radio/TV technician for help. Shielded (STP) network cables must be used with this unit to ensure compliance with EMC standards.

**USA** – This equipment has been tested and found to comply with the limits for a Class A computing device pursuant to Subpart B of Part 15 of FCC rules, which are designed to provide reasonable protection against such interference when operated in a commercial environment. Operation of this equipment in a residential area is likely to cause interference, in which case the user at his/her own expense will be required to take whatever measures may be required to correct the interference.

**Canada** – This Class A digital apparatus complies with Canadian ICES-003.

**Europe** – **CE** This digital equipment fulfills the requirements for radiated emission according to limit A of EN55022/1998, and the requirements for immunity according to EN55024/1998 residential, commercial, and light industry. **Warning!** This is a Class A product. In a domestic environment this product may cause radio interference, in which case the user may be required to take adequate measures.

**Japan** – This is a class A product based on the standard of the Voluntary Control Council for Interference from Information Technology Equipment (VCCI). If this is used near a radio or television receiver in a domestic environment, it may cause radio interference. Install and use the equipment according to the instruction manual.

**Australia** – This electronic device meets the requirements of the Radio communications (Electromagnetic Compatibility) Standard 1998 AS/NZS 3548. **Warning!** This is a Class A product. In a domestic environment this product may cause radio interference, in which case the user may be required to take adequate measures.

### Liability

Every care has been taken in the preparation of this manual; Please

inform your local Axis office of any inaccuracies or omissions. Axis Communications AB cannot be held responsible for any technical or typographical errors and reserves the right to make changes to the product and manuals without prior notice. Axis Communications AB makes no warranty of any kind with regard to the material contained within this document, including, but not limited to, the implied warranties of merchantability and fitness for a particular purpose. Axis Communications AB shall not be liable nor responsible for incidental or consequential damages in connection with the furnishing, performance or use of this material.

### Trademark Acknowledgments

Acrobat, Adobe, Boa, Ethernet, IBM, Internet Explorer, Linux, Macintosh, Microsoft, Mozilla, Netscape Navigator, UNIX, Windows, WWW are registered trademarks of the respective holders. Java and all Java-based trademarks and logos are trademarks or registered trademarks of Sun Microsystems, Inc. in the United States and other countries. UPnP is a certification mark of the UPnP™ Implementers Corporation. Axis Communications AB is independent of Sun Microsystems Inc.

### RoHS

This product complies with both the European RoHS directive, 2002/95/EC, and the Chinese RoHS regulations, ACPEIP.



### WEEE Directive

The European Union has enacted a Directive 2002/96/EC on Waste Electrical and Electronic Equipment (WEEE Directive). This directive is applicable in the European Union member states.



The WEEE marking on this product (see right) or its documentation indicates that the product must not be disposed of together with household waste. To prevent possible harm to human health and/or the environment, the product must be disposed of in an approved and environmentally safe recycling process. For further information on how to dispose of this product correctly, contact the product supplier, or the local authority responsible for waste disposal in your area.

Business users should contact the product supplier for information on how to dispose of this product correctly. This product should not be mixed with other commercial waste.

### Axis Customer Services

Should you require any technical assistance, please contact your Axis reseller. If your questions cannot be answered immediately, your reseller will forward your queries through the appropriate channels to ensure a rapid response. If you are connected to the Internet, you can:

- download user documentation and firmware updates

find answers to resolved problems in the FAQ database. Search by product, category, or phrases

report problems to Axis support staff by logging in to your private support area

visit the Axis Support Web at [www.axis.com/techsup/](http://www.axis.com/techsup/)

### Safety Notice - Battery Replacement

The AXIS 231D+/232D+ uses a 3.0V CR2032 Lithium battery as the power supply for its internal real-time clock (RTC). This battery will, under normal conditions, last for a minimum of 5 years. Low battery power affects the operation of the RTC, causing it to reset at every power-up. A log message will appear when battery replacement is required.

The battery should not be replaced unless required!  
If the battery does need replacing, please observe the following points: **Caution!**

- Danger of Explosion if battery is incorrectly replaced
- Replace only with the same or equivalent battery, as recommended by the manufacturer.
- Dispose of used batteries according to the manufacturer's instructions.

AXIS 231D+/232D+ Network Dome Camera User's Manual,  
Revision 4.0  
Date: April 2009  
Part No: 35006  
Copyright© Axis Communications AB, 2007 - 2009

# Table of contents

---

- AXIS 231D+/232D+ ..... 5
  - AXIS 232D+..... 5
  - Hardware Description ..... 6
- Using the Network Dome Camera..... 7
  - Accessing the AXIS 231D+/232D+ ..... 7
  - Setting the root password ..... 8
- Video Streams ..... 11
  - Stream Types..... 11
  - How to stream MPEG-4..... 12
  - Other methods of accessing the video stream..... 13
  - Other MPEG-4 clients ..... 13
- Configuring the Network Dome Camera..... 14
  - Overview of the configuration menu ..... 14
  - Video & Image Settings ..... 15
  - Overlay Image Settings ..... 17
  - Advanced Camera Settings ..... 17
  - MPEG-4 Settings ..... 18
  - MJPEG ..... 18
- Live View Config ..... 20
  - Layout ..... 20
  - HTML Examples..... 24
  - External Video..... 24
  - Sequence Mode ..... 24
  - Pan Tilt Zoom Controls..... 25
- Dome Configuration ..... 27
  - Preset Positions..... 27
  - Guard Tour ..... 27
  - Advanced..... 28
  - Control Queue..... 28
- Event Configuration ..... 29
  - Event Servers..... 29
  - Event Types ..... 30
  - Motion detection ..... 33
  - Port Status ..... 34

System Options .....	35
Security .....	35
Date & Time .....	37
Network - Basic TCP/IP Settings .....	39
SOCKS .....	42
QoS (Quality of service) .....	43
SMTP (email) .....	43
SNMP .....	44
UPnP™ .....	44
RTP (Multicast)/ MPEG-4 .....	44
Bonjour .....	44
Ports & devices - I/O Ports .....	44
Maintenance .....	45
Support .....	45
Advanced .....	46
About .....	47
Resetting to Factory Default Settings .....	47
Connection Module .....	48
Troubleshooting .....	50
Checking the Firmware .....	50
Updating the Firmware .....	50
Emergency Recovery Procedure .....	51
Support .....	51
Symptoms, Possible Causes and Remedial Actions .....	52
Technical Specifications .....	54
General performance considerations .....	56
Optimizing your system .....	57
Frame rates - Motion JPEG .....	57
Frame rates - MPEG-4 .....	58
Bandwidth .....	58
Glossary of Terms .....	60
Index .....	67

## AXIS 231D+/232D+

---

Ideal for demanding surveillance and remote monitoring applications, the AXIS 231D+/232D+ Network Dome Camera features precise pan/tilt/zoom control, superior quality Motion JPEG and MPEG-4 video, advanced event management functionality, 4 alarm inputs/4 alarm outputs (for door sensors, alarm bells), 50 preset positions, sequence modes, guard tours, and Wide Dynamic Range. With security features such as HTTPS and IP address filtering, the AXIS 231D+/232D+ is perfect for professional security installations.

Up to 20 viewers can access the camera simultaneously when using Motion JPEG and MPEG-4 unicast. Video can be viewed in five resolutions (up to 4CIF); image compression is configurable.

The AXIS 231D+/232D+ has a built-in Web server, providing full access to all features through the use of a standard web browser. The built-in scripting tool allows basic applications to be created, providing basic surveillance solutions. For advanced functionality, the Network Dome Camera can be integrated via the use of AXIS HTTP API. For more information, refer to <http://www.axis.com/developer>

Axis products are supported by the industry's largest base of application software for managing and recording video, and integrating alarm and access control systems.

### AXIS 232D+

The AXIS 232D+ Network Dome Camera is a day and night camera with an IR cut filter which enables the camera to capture color video in light conditions down to 0.3 lux, and black and white video in conditions down to 0.005 lux. The IR-cut filter can be automatically enabled/disabled according to the current light conditions or manually enabled/disabled from the internal web pages.

## Hardware Description



**Network Connector-** After the start-up and self test routines, the Network and Power Indicators on the network connector flash as follows:

Indicator	Color	Description
Network	Green	Flashes for network activity
Power	Green	Normal operation
	Amber	Flashes green/amber during upgrade and when connecting to AXIS Internet Dynamic DNS Service

*Detail - network connector:*

Power Indicator

Network Indicator

**Control Button** - Press this button to restore the factory default settings, as described in *Resetting to Factory Default Settings, on page 47*. The Serial Number (S/N) is located on the label on the unit.

**Network Connector** - The AXIS 231D+/232D+ connects to the network via a standard RJ45 connector. Supporting NWAY, the AXIS 231D+/232D+ detects the speed of the local network segment (10BaseT/100BaseTX Ethernet).

**Connection Module** - The connection module provides the physical interface to 4 transistor outputs, 4 digital inputs and is the connection point for AC power. See *Connection Module, on page 48*.

For instructions on how to install the AXIS 231D+/232D+, refer to the Installation Guide which is supplied with the product in printed format, or in PDF format from the Axis Web site at <http://www.axis.com>

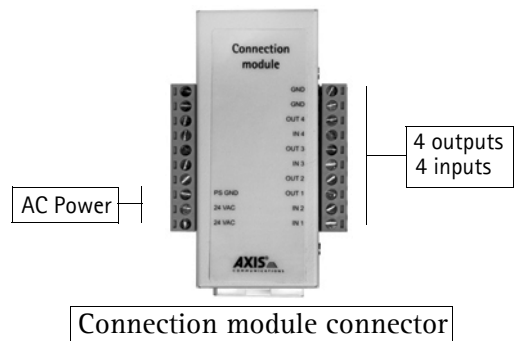



# Using the Network Dome Camera

This document includes instructions for using and managing the AXIS 231D+/232D+. Instructions on how to install the AXIS 231D+/232D+ on your network are provided in the AXIS 231D+/232D+ Installation guide which is available from the Axis Web site. The AXIS 231D+/232D+ can be used with most standard operating systems and supports Microsoft Internet Explorer 6.x or later, Netscape 7.x or later and Firefox 1.4 or later.

## Accessing the AXIS 231D+/232D+

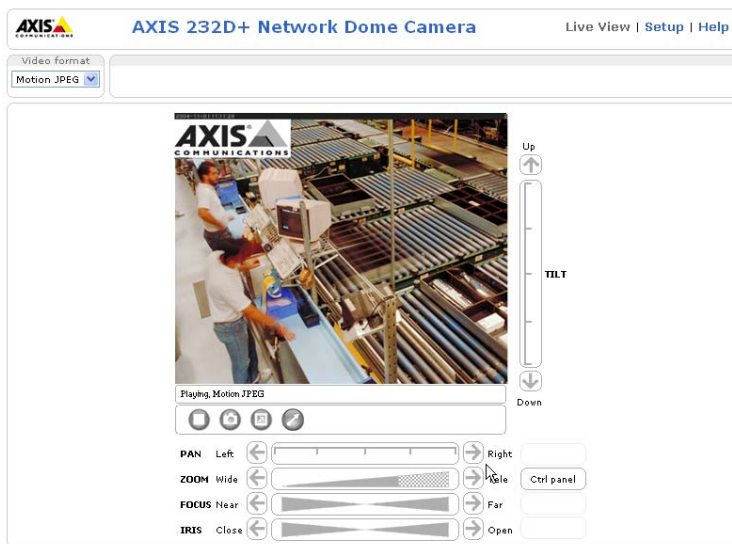
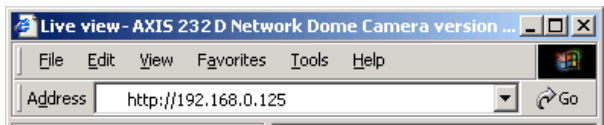
1. Start a Web browser.
2. Enter the IP address or host name of the AXIS 231D+/232D+ in the Location/Address field of your Web browser.
3. If this is the first time the camera is accessed, see *Setting the root password*, on page 8. Otherwise enter the user name and password set by the administrator.
4. A video image is displayed in your Web browser.



- Note:**
- To be able to view streaming video in Microsoft Internet Explorer, you must set your Web browser to allow ActiveX controls. If your working environment restricts the use of additional software components, you can configure the AXIS 231D+/232D+ to use a Java applet for updating images. Please refer to the online help files  for more information.
  - User functions in the AXIS 231D+/232D+ may have been customized to meet the specific requirements of the application. Consequently, many of the examples and functions in this section may differ from those displayed in your Live View page.

## Setting the root password

1. When accessing the video server for the first time, the Configure Root Password dialog appears.

**Note:** Before you enter your password at this point, you can secure configuration of the root password via HTTPS by creating a self-signed certificate. To do so, click the **Create self-signed certificate...** button in the **Create Certificate** window, and then proceed as follows.

2. Enter a password and re-enter, to confirm the spelling. Click OK.
3. The **Enter Network Password** dialog appears. Enter the User name: root.



**Note:** The default administrator user name root is permanent and cannot be deleted or altered.

4. Enter the password as set in step 2 above, and click OK. If the password is lost, the camera must be reset to the factory default settings. See *Resetting to Factory Default Settings*, on page 47.
5. If required, click Yes to install the AXIS Media Control (AMC). You will need administrator rights on the computer to do this.

If the AXIS 231D+/232D+ has been suitably customized, the buttons and other items described below will be displayed accordingly on the Live View page. The following provides an overview of each button:

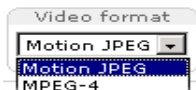

The Video Format drop-down list allows the video format on the Live View page to be temporarily changed.



The **Output** buttons control an output directly from the Live View page. These buttons are configured under **Setup > Live View Config > Layout**.

**Pulse** - click this button to activate the port for a defined period of time, such as to switch on a light for 20 seconds.



**Active/Inactive** - click these buttons to manually start and stop a connected device, such as to switch a light on/off.



These buttons start/stop the **Sequence Mode**. This mode is created in **Setup > Live View Config > Sequence mode** and automatically displays the view from preset positions at set intervals.



The **Action** buttons trigger an action directly from the Live View page. These buttons are configured under **Setup > Live View Config > Layout**. Click these buttons to manually start and stop events.





Use the **Snapshot** button to capture a snapshot of the image currently displayed in the window. Right-click on the image to save it in JPEG format on your computer.

Ctrl panel

Click the **Ctrl panel** button to access the following buttons:

- **Auto focus:** Automatically adjusts the image focus.
- **Auto iris:** Automatically adjusts the amount of light reaching the image sensor for best image results.
- **Backlight comp:** Enabling backlight compensation makes the subject clearer if the image background is too bright, or if the subject is too dark.
- **IR cut filter (AXIS 232D+ only)** - when set to off, the camera will be able to “see” infrared light, such as, at night, making the image clearer. The image is shown in black & white when the IR cut filter is off. Set to **Auto** to automatically turn the filter off when the available visible light falls below the minimum requirement.



**Note:** There are different buttons in the Control Panel depending on the web browser you are using, but the descriptions and functionality are the same.

The **AMC viewer toolbar (AXIS Media Control)** is available from **Microsoft Internet Explorer only** and displays the following buttons:



The **Play/Stop** buttons start and stop the live video stream.



The **Snapshot** button takes a snapshot of the displayed image. The Snapshot function and the target directory for saving snapshots can be configured from AMC (AXIS Media Control), which is available from the Windows Control Panel (Internet Explorer only).



Click the **View Full Screen** button, and the video image will fill the entire screen area. No other windows will be visible. Press Esc (Escape) on the computer keyboard to cancel full screen view.



The record button is used to record the current video stream. The location where the image file is saved can be specified using the AMC control panel. To enable recording, Select **Live View Config > Viewer Settings > Enable recording button**.



Click the **Set emulated joystick mode** button and click in the image to move the camera in the desired direction



Click the **Center** button and the camera view will center on the position that was clicked. The location to move to has a definite position, such as, 'position x,y.

## Area Zoom

This allows you to draw a box over a desired area to zoom into. To activate, click the Center button described in the AMC viewer toolbar or in other Internet browsers choose **PTZ > Center**. Using your mouse click in the image and while holding down the left mouse button draw a square over the area you would like to zoom into.

## Pan/Tilt/Zoom Controls

The Live View page also displays the Pan/Tilt/Zoom controls. The administrator can enable/disable the control for specified users under **System Options > Security > Users > User List**.

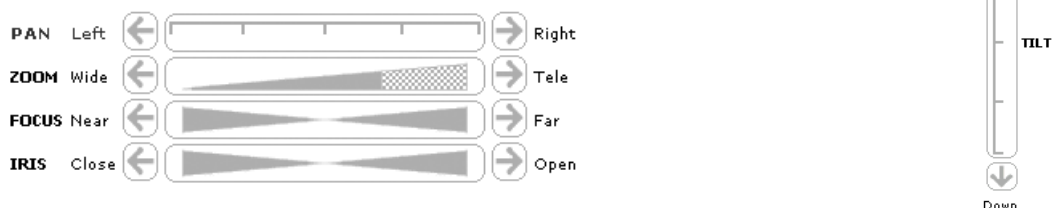

## Pan/Tilt/Zoom Control Queue

The time the user is in control of the PTZ settings is limited and a queue of users has been set up. Use the buttons to request or release control of the Pan/Tilt/Zoom controllers.

PTZ Control Queue	
Status in queue:	You are possessing the control.
Position in queue:	1
Time remaining:	37 seconds
<input type="button" value="Release control"/>	

The Pan/Tilt/Zoom Control Queue is set up by the administrator under: **Dome Configuration > Advanced > PTZ Control Queue**. For more information on using Pan/Tilt/Zoom controls, please see page 25.

## AXIS 295 Video Surveillance Joystick

The AXIS 295 is a USB device that gives responsive and accurate control of the pan, tilt, zoom functionality. On installation, the joystick is automatically detected by AXIS Media Control where the 12 buttons can be programmed for a customized video surveillance system. For more information, please visit the Axis Website at <http://www.axis.com>

# Video Streams

---

The AXIS 231D+/232D+ provides several different image and video stream formats. The type you want to use depends on your requirements and on the properties of your network.

Unicasting is communication between a single sender and a single receiver over a network. This means that the video stream goes independently to each user, and each user gets their own stream.

Multicast is bandwidth-conserving technology that reduces bandwidth usage by simultaneously delivering a single stream of information to multiple network recipients.

The Live View page in the AXIS 231D+/232D+ provides access to Motion JPEG and MPEG-4 video streams, as well as to single JPEG images. Other applications and clients can also access these video streams/images directly, without going via the Live View page.

## Stream Types

### Motion JPEG

This format uses standard JPEG still images in the video stream. These images are then displayed and updated at a rate sufficient to create a stream that shows constantly updated motion.

The Motion JPEG stream uses considerable amounts of bandwidth, but also provides excellent image quality and access to every image contained in the stream.

Note also that multiple clients accessing Motion JPEG streams can use different image settings.

### MPEG-4

This is a video compression standard that makes good use of bandwidth, and which can provide high quality video streams at less than 1 Mbit/s.

- Notes:**
- MPEG-4 is licensed technology. The AXIS 231D+/232D+ includes one viewing client license. Installing additional unlicensed copies of the viewing client is prohibited. To purchase additional licenses, contact your Axis reseller.
  - All clients viewing the MPEG-4 stream must use the same image settings.

The MPEG-4 standard provides scope for a large range of different coding tools for use by various applications in different situations, and the AXIS 231D+/232D+ provides certain subsets of these tools. These are represented as **Video object types**, which are selected for use with different viewing clients. The supported video object types are:

- **Simple** - sets the coding type to H.263, as used by QuickTime™, for example.
- **Advanced Simple** - sets the coding type to MPEG-4 Part 2, as used by AMC (AXIS Media Control).

When using MPEG-4 it is also possible to control the bit rate, which in turn allows control of bandwidth usage. CBR (constant bit rate) is used to achieve a specific bit rate by varying the quality of the MPEG-4 stream. When using VBR (variable bit rate), the quality of the video stream is kept as constant as possible, at the cost of a varying bit rate.

## How to stream MPEG-4

Deciding the combination of protocols and methods to use depends on your viewing requirements, and on the properties of your network. The available options in AMC are:

Unicast RTP	This unicast method (RTP over UDP) should be your first consideration for live unicast video, especially when it is important to always have an up-to-date video stream, even if some images are dropped.	Unicasting is used for video streaming, so that there is no video traffic on the network until a client connects and requests the stream.  Note that there are a maximum of 20 simultaneous unicast connections.
RTP over RTSP	This unicast method (RTP tunneled over RTSP) is useful as it is relatively simple to configure firewalls to allow RTSP traffic.	
RTP over RTSP over HTTP	This unicast method can be used to traverse firewalls. Firewalls are commonly configured to allow the HTTP protocol, thus allowing RTP to be tunneled.	
Multicast RTP	<p>This method (RTP over UDP) should be used for live multicast video. The video stream is always up-to-date, even if some images are dropped.</p> <p>Multicasting provides the most efficient usage of bandwidth when there are large numbers of clients viewing simultaneously. A multicast broadcast cannot however, pass a network router unless the router is configured to allow this. It is not possible to multicast over the Internet, for example.</p> <p>Note also that all multicast viewers count as one unicast viewer in the maximum total of 10 simultaneous connections.</p>	

AMC negotiates with the camera to determine the transport protocol to use in the order listed above. This order can be changed and the options disabled, to suit specific requirements.

## The AXIS Media Control

The recommended method of accessing live video (MPEG-4 and/or Motion JPEG) from the AXIS 231D+/232D+ is to use the AXIS Media Control (AMC) in Microsoft Internet Explorer in Windows. This ActiveX component is automatically installed on first use, after which it can be configured by opening the AMC Control Panel applet from the Windows Control Panel. Alternatively, right-click the video image in Internet Explorer.

## Other methods of accessing the video stream

Video/images from the AXIS 231D+/232D+ can also be accessed in the following ways:

- If supported by the client, the AXIS 231D+/232D+ can use Motion JPEG server push to display video. This option maintains an open HTTP connection to the browser and sends data as and when and for as long as required.
- As single JPEG images in a browser. Enter the path. For example:  
<http://<ip>/axis-cgi/jpg/image.cgi?resolution=CIF>
- Windows Media Player. This requires installation of AMC and the MPEG-4 decoder. The paths that can be used are listed below, in the order of preference.
  - Unicast via RTP: <axrtpu://<ip>/mpeg4/media.amp>
  - Unicast via RTSP: <axrtsp://<ip>/mpeg4/media.amp>
  - Unicast via RTSP, tunneled via HTTP: <axrtsphhttp://<ip>/mpeg4/media.amp>
  - Unicast via RTSP, tunneled via HTTPS: <axrtsphhttps://<ip>/mpeg4/media.amp>
  - Multicast: <axrtpm://<ip>/mpeg4/media.amp>

## Other MPEG-4 clients

Although it may be possible to use other clients to view the MPEG-4 stream, this is not guaranteed by Axis. For some other clients, such as QuickTime™ the Video Object Type must be set to *Simple*. It may also be necessary to adjust the advanced MPEG-4 settings. To assess the video stream from QuickTime™ the following path can be used:

<rtsp://<ip>/mpeg4/1/media.amp>

This path is for all supported methods, and the client negotiates with the network camera to determine exactly which transport protocol to use.

**Notes:** <ip> = IP address

## Configuring the Network Dome Camera

This section describes how to configure the AXIS 231D+/232D+ and is intended for the product administrator who has unrestricted access to all Setup tools and the **Operator** who has access to Video & Image, Live View Config and Event Configuration. See the section on *Security*, on page 35 for more information on user access control.

The AXIS 231D+/232D+ is configured through the **Setup** link from a standard browser.

Follow the instructions below to access the Setup link from a Web browser.

1. Start the Web browser and enter the IP address or domain name of the AXIS 231D+/232D+ in the location/address field.

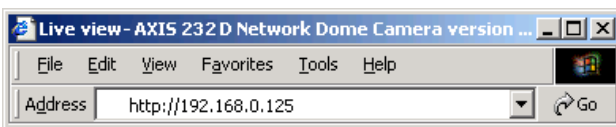

2. The Live View page is now displayed. Click **Setup** to display further links where you can configure your network camera.

### Overview of the configuration menu

	<b>AXIS 231D+ Network Dome Camera</b>	<a href="#">Live View</a>   <a href="#">Setup</a>   <a href="#">Help</a>
<ul style="list-style-type: none"> <li>▾ <b>Basic Configuration</b></li> <li style="padding-left: 20px;">Instructions</li> <li style="padding-left: 40px;">1. Users</li> <li style="padding-left: 40px;">2. TCP/IP</li> <li style="padding-left: 40px;">3. Date &amp; Time</li> <li style="padding-left: 40px;">4. Video &amp; Image</li> <li>▸ <b>Video &amp; Image</b></li> <li>▸ <b>Live View Config</b></li> <li>▸ <b>Dome Configuration</b></li> <li>▸ <b>Event Config</b></li> <li>▸ <b>System Options</b></li> <li><b>About</b></li> </ul>	<h3 style="margin: 0;">Basic Configuration</h3> <p>Before using the AXIS 231D+ Network Dome Camera, there are certain settings that should be made, most of which require Administrator access privileges. To quickly access these settings, use the numbered shortcuts to the left. All the settings are also available from the standard setup links in the menu.</p> <p>Note that the only required setting is the IP address, which is set on the TCP/IP page. All other settings are optional. Please see the online help for more information.</p> <p><b>Firmware version:</b> 4.47  <b>MAC address:</b> 00:40:8C:7D:11:04</p>	

## Video & Image Settings

The screenshot displays the configuration web interface for an AXIS 231D+ Network Dome Camera. The page title is "AXIS 231D+ Network Dome Camera" with sub-links for "Live View", "Setup", and "Help". A navigation menu on the left includes: Basic Configuration, Video & Image (Image, Overlay Image, Advanced), Live View Config, Dome Configuration, Event Config, System Options, and About. The main content area is titled "Image Settings" and contains the following sections:

- Image Appearance:**
  - Resolution:  Aspect ratio correction,  4CIF de-interlacing, 4CIF (704 x 480)
  - Compression: 30 [0..100]
  - Rotate image: 0 degrees
  - Mirror image
  - Color setting: Color
  - White balance: Auto
- Overlay Settings:**
  - Include overlay image at the coordinates: X 0 Y 0
  - Include date  Include time
  - Include text: [text input]
  - Text color: white Text background color: black
  - Place text/date/time at top of image
- Video Stream:**
  - Maximum video stream time:
    - Unlimited
    - Limited to [ ] [1..] seconds per session
  - Maximum frame rate:
    - Unlimited
    - Limited to [ ] [1..30] fps per viewer
- Test:**
  - Test settings (using Motion JPEG) before saving. [Test]
  - [Save] [Reset]

### Image Settings

To optimize the video images to suit your requirements, modify the settings under **Image Appearance**. Each setting is described in the online help files [?](#).

All configuration of images and overlays affects the performance of the network camera, depending on the usage and the available bandwidth.

- High resolution generates larger files
- Lower compression improves image quality, but generates larger files
- Black & White uses less bandwidth than Color
- Rotating the image 90 or 270 degrees will lower the maximum frame rate

### Mirroring

Mirroring is the horizontal flipping of an image, that gives you another image perspective. This is a useful function when you need a direct view of the image, for example, in ATMs and door phones. The mirroring settings should be defined before you define the parameters for privacy masks and motion detection.

See also the specifications for frame rates and bandwidth in *General performance considerations*, on page 56.

## Overlay Settings

Use these settings to include an image as an overlay, and the date and time, along with text of your own.

Text overlays are included in one line at the top or bottom of the video image. Image overlays can be placed anywhere in the video image.

**Example:** If there is information in a monitored area that you do not wish to disclose, you can mask it out by placing an overlay image on top. Setting the overlay image anywhere in the video image using coordinates allows precision detail masking.

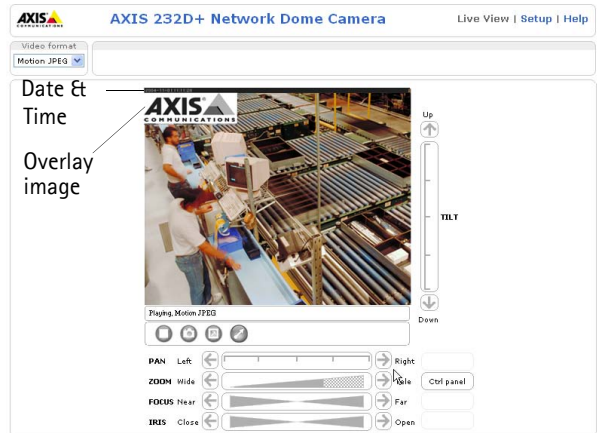

## Video Stream

The **Maximum video stream time** can be set as *Unlimited*, or a **maximum stream time** per session in seconds, minutes or hours can be defined. When the set time has expired, a new stream can be started by refreshing the page in the Web browser. Note that the maximum video stream time does not apply to clients connecting via multicast.

To avoid bandwidth problems on the network, the **frame rate** allowed to each viewer can also be limited. Select either *Unlimited* or define a maximum frame rate per viewer.

For a preview of the image and overlay settings before saving, click **Test**. When you are satisfied with the settings, click **Save**.

Please use the online help files  for more information.



## Overlay Image Settings

An overlay image is an image included in the video image. An overlay image might be your own company logo. To upload an overlay image:

1. Go to **Setup > Video & Image > Overlay Image**.
2. To upload the file to the AXIS 231D+/232D+, click the **Browse** button and locate it on your computer or server.
3. Click the **Upload** button and follow the on-screen instructions.
4. The image is now available in the **Use overlay image** drop-down list.
5. Click **Save**.
6. Go to **Setup > Video & Image** and modify the parameters under **Overlay Settings**.

Overlay image requirements		Overlay image limitations
Image Formats	Image Size	
<ul style="list-style-type: none"> <li>• Windows 24-bit BMP (full color)</li> <li>• Windows 4-bit BMP (16 colors)</li> </ul>	The height and width of the overlay image in pixels must be exactly divisible by 4.	<ul style="list-style-type: none"> <li>• If the image overlay and text overlay are larger than the video image, no overlay is displayed. When also using a text overlay, this occupies 16 pixels in height and as many in width as the video image.</li> <li>• If the overlay is initially positioned so that part of it is outside the video image, it will be relocated so that it appears over the video image, i.e. the entire image is always displayed.</li> <li>• The maximum overlay image size supported by the AXIS 231D+/232D+ is the same as the maximum image resolution. See Technical Specifications, on page 46.</li> </ul>

## Advanced Camera Settings

To optimize the lighting settings according to your requirements, modify the following settings under **Lighting Conditions**:

- **White balance** - the white balancing system in the AXIS 231D+/232D+ can automatically detect white in the image and intelligently use this as a reference for other colors.
- **Exposure control** - this setting is used to adapt to the amount/type of light being used.
- **IR cut filter (AXIS 232D+ only)** - when the IR cut filter is set to OFF, the camera will be able to 'see' infrared light, for example at night, thus making the image clearer. The image is shown in black & white when the IR cut filter is off.

Note that if the AXIS 232D+ is set to Auto, it will automatically switch between

IR cut filter ON and OFF, according to the current lighting conditions. This is only possible when the iris is set to Auto Iris, and the exposure control is set to Automatic.

- Wide dynamic range - Corrects the exposure when the contrast is extreme between light and dark in an image. Test the different levels to find the one that works best of your light conditions.
- Backlight compensation - this setting is used to make the subject appear clearer, for example, against a bright background.

## Image Settings

- Auto focus enabled (default setting).
- Sensitivity - sets the speed of the auto focus. **High** is used when focusing on objects that move frequently. **Low** improves the stability of the focus.

**Note:** In certain situations, the white balancing system will not operate effectively. Problems may occur if the image contains no white color at all, or if the dominant color is not white. In these circumstances, the white balance may incorrectly be based on another visible color in the image, and colors may become distorted. A pale background picture with reddish or blue foreground objects is very symptomatic of this condition. In such cases it is recommended that a fixed white balance setting is selected.

Please use the online help files  for more information.

## MPEG-4 Settings

Here you can adjust the MPEG-4 settings and for controlling the video bit rate. The MPEG-4 standard provides many different coding tools for various applications in different situations. As most MPEG-4 clients do not support all of these tools, it is usual to instead define and use subsets for different clients or groups of clients. These settings allow you to define the type of viewing client to use.

Adjusting the maximum bit rate and setting it to variable or constant is a good way of controlling the bandwidth used by the MPEG-4 video stream.

For more information on these advanced settings, please see the online help files .

## MJPEG

In some situations the image size may get quite large due to low light or complex scenery. Adjusting the maximum frame size is a good way of controlling the bandwidth and storage used by the MJPEG video stream in these situations. Leaving the frame size at Unlimited will provide consistently good image quality at the expense of increased bandwidth and storage usage during low light. Limiting the frame size will prevent excessive bandwidth and storage usage, but image quality will suffer. To prevent increase in bandwidth and storage usage, the maximum frame size should be set to an optimal amount.

For more information on these advanced settings, please see the online help files  .

# Live View Config

## Layout

The screenshot shows the 'Live View Layout' configuration page for an AXIS 231D+ Network Dome Camera. The page is divided into a left sidebar with navigation options and a main configuration area. The sidebar includes: Basic Configuration, Video & Image, Live View Config (Layout, HTML Examples, External Video, Sequence Mode), Dome Configuration, Event Config, System Options, and About. The main configuration area is titled 'Live View Layout' and contains several sections:

- Layout Selection:** Radio buttons for 'Use Axis look' (selected) and 'Use custom settings' (with a 'Configure...' button).
- Default Video Format:** A dropdown menu set to 'Motion JPEG'.
- Default Viewer:** Checkboxes for 'Show video format selection' and 'Default Viewer'. Below are dropdowns for 'Windows Internet Explorer' (set to 'AMC (ActiveX)') and 'Other Browsers' (set to 'Server push').
- Viewer Settings:** Checkboxes for 'Show viewer toolbar', 'Enable MPEG-4 decoder installation', 'Show crosshair in PTZ joystick mode\*', 'Use PTZ joystick mode as default\*', and 'Enable recording button'. A note states: '\*Not applicable to AMC (ActiveX)'.
- Action Buttons:** Checkboxes for 'Show manual trigger button' and 'Show snapshot button'.
- User Defined Links:** Four entries, each with a checkbox, a 'Name' field (all set to 'Custom link X'), and a 'URL' field (all set to 'http://'). Each entry has radio buttons for 'Use as: cgi link' (selected) and 'web link'.
- Output Buttons:** Four dropdown menus labeled 'Output 1' through 'Output 4', all set to '-----'.

At the bottom of the configuration area are 'Save' and 'Reset' buttons.

These are the tools for deciding the layout of the Live View page.

The layout can be set in two ways:

- Use Axis look - the layout is unchanged.
- Use custom settings - modify the default page with your own colors, or images. Click the **Configure** button and see the following page.

Click the **Configure...** button to define custom settings in the **Custom Settings** window that appears.

## Customizing the default page

The appearance of the default AXIS 231D+/232D+ Live View page can be customized to suit your requirements, or you can upload and use your own home page. To upload your own files, click the **Upload/Remove** button and see the description below.

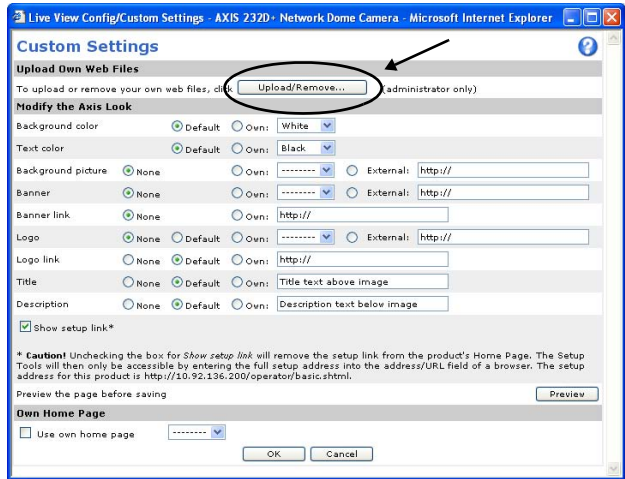

### Upload Own Web Files

Your own web files, background picture, color must first be uploaded to the AXIS 231D+/232D+ in order to be available for selection in the **Custom Settings** window. Once uploaded, the files appear in the drop-down list.

1. Enter the path to the file, or click the **Browse** button.
2. Select the user level for the uploaded file. Setting the user access level means that you decide who gets to view the pages.
3. When the path is shown correctly in the text field, click the **Upload** button.

All uploaded files are shown in the list in the lower section of the page. To remove a file, check the box provided next to it and then click the **Remove** button.

- To use your uploaded file, in the **Custom Settings** window, click the **Own** radio button and select the file from the drop-down list:
- To use an external file located somewhere other than in the AXIS 231D+/232D+, click the **External** radio button and enter the URL:

Note that the setup address is:

```
http://<ip address>/operator/basic.shtml
```

### Own Home Page

To use a web page, already uploaded as the default page, check the box, select the page from the drop-down list and click **OK**.

### Default Video Format

Select the default video format to use on the Live View page. Check the **Show video format** selection option. This displays a drop-down list on the Live View page allowing you to temporarily change the format. When using MPEG-4 as the video format, the default viewer is AXIS Media Control with Internet Explorer.

**Note:** It is also possible to view Motion JPEG when MPEG-4 is chosen as default and vice versa.

### Default Viewer

From the drop-down lists, select the default method for viewing video images in your browser. The camera attempts to show the video images in the selected video format and viewer. If this is not possible, the camera overrides the settings and selects the best available combination.

Browser	Viewer	Description
Windows Internet Explorer	AMC	Recommended viewer in Windows Internet Explorer (MPEG-4 /Motion JPEG).
	QuickTime	MPEG-4 only.
	Java applet	A slower imaging alternative to AMC. Requires one of the following installed on the client: <ul style="list-style-type: none"> <li>• JVM (J2SE) 1.4.2 or higher</li> <li>• JRE (J2SE) 5.0 or higher</li> </ul>
	Still image	Displays still images only. Hit the Refresh button in your browser to view a new image.
Other browsers	Server Push	Recommended viewer for other browsers (Motion JPEG).
	QuickTime	MPEG-4 only.
	Java applet	A slower imaging alternative to Server Push (Motion JPEG only).
	Still image	Displays still images only. Hit the Refresh button in your browser to view a new image.

### Viewer Settings

The **Show viewer toolbar** option displays the AMC toolbar under the video stream.

The **Enable MPEG-4 decoder installation** option allows the Administrator to enable or disable the installation of the MPEG-4 decoder. This is used to prevent the installation of unlicensed copies. Further decoder licenses can be purchased from your Axis dealer.

The **Show crosshair in PTZ joystick mode** option indicates the center of the image when viewing the video stream in PTZ joystick mode.

The **Use PTZ joystick mode as default** option allows you to set the PTZ mode to joystick.

The **Enable recording button** option will start an MPEG-4 recording directly from the Live View page.

### Action Buttons

These buttons can be used to manually trigger and stop an event from the Live View page. The snapshot button allows you to take a snapshot of the video stream and save it to a computer.

## User Defined Links

User defined links can be CGI links or web links. Once configured, the link(s) appear in the Live View page.

To set up a **web link**, select the **Use as web link** radio button, enter a descriptive name, and enter the URL in the provided field. Click **Save** and the link will appear in the **Live View** page.

User defined **CGI links** can be used to issue HTTP API requests, such as PTZ commands.

Example:

1. Check **Show Custom Link 1**.
2. Enter a descriptive name, such as **CAM START**.
3. Select the **Use as cgi link** radio button and enter the cgi link in the field:  
`http://192.168.0.125/axis-cgi/com/ptz.cgi?continuouspaniltmove=30,-30`
4. Check **Show Custom Link 2**.
5. Enter a descriptive name, such as **CAM STOP**.
6. Select the **Use as cgi link** radio button and enter the cgi link in the field:  
`http://192.168.0.125/axis-cgi/com/ptz.cgi?continuouspaniltmove=0,0`
7. These links appear in the web interface and can be used to control the AXIS 231D+/232D+.



User Defined Links

For more information on the Axis HTTP API, see the **Support / Developer** pages on the Axis Web site at <http://www.axis.com>

Please use the online help files  for more information.

For more information on the Axis HTTP API, see the **Support / Developer** pages on the Axis Web site at <http://www.axis.com> See also the section on PTZ, on page 25.

## Output Buttons

These buttons are used to control the outputs on the AXIS 231D+/232D+ and thus the equipment connected to them, such as to switch a light on or off:

- The **Pulse** button activates the port for a defined period
- **Active/Inactive** displays two buttons, one for each action (on/off)

## HTML Examples

You can add live video from your AXIS 231D+/232D+ to your own web site. The video server can send Motion-JPEG or MPEG-4 images to up to 20 simultaneous connections, although an administrator can restrict this to fewer. This does not affect or include the number of multicast viewers.

Enter the **Image Type**, **Image size** and other settings to suit your web page and click **Update**.

## External Video

An external video source is a source originating from some other Axis device on the network. The images from these sources can be displayed just as if they were produced by the AXIS 231D+/232D+.

The External Video Source list shows all of the external video sources currently configured. The information displayed is the source's name and the path to the video stream. Up to 20 external video sources can be configured.

### Working with External Video Sources

1. To add a new video source, click the **Add** button. This opens the External Video Source Setup dialog, where you make all the necessary settings.
2. To modify an existing video source, select it and click the **Modify** button.
3. To delete an external video source, select it and click the **Remove** button.

## Sequence Mode

Sequence Mode is a configuration that automatically displays the view from multiple, previously defined Preset Positions (see *Dome Configuration*, on page 27 and the online help  ).

This is useful for security personnel viewing a surveillance system that constantly rotates through the selected preset positions, in the listed order, or at random.

To set up sequence mode, simply select the desired preset positions and enter the number of seconds or minutes to display each position for. Each position can be displayed for up to 59 minutes.

**Note:** The Sequence mode is only active as long the browser is open.



## Pan Tilt Zoom Controls

The controls available for Pan Tilt Zoom (PTZ) are displayed on the Live View page by default. The administrator can enable/disable the controls for specified users.

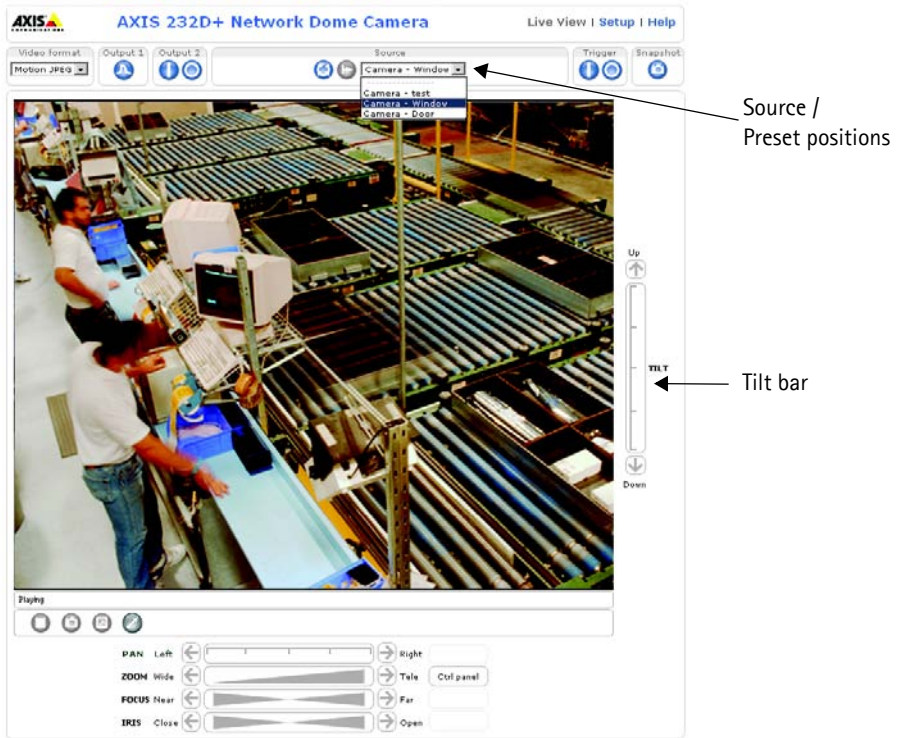

### PTZ controls

- the Pan bar - moves the camera to the right and left
- the Tilt bar - tips the camera up and down
- the Zoom bar - zooms the view in and out
- the Focus bar - adjusts the focus
- the Iris bar - adjusts the brightness of the image

Clicking on the bars themselves or on the arrows at the end of the bars will move the camera to a new position.

Each position on the bar (see right) represents a defined position in the camera's range of movement, with the center of the bar representing the point midway between the two extremes at either end.



Clicking a position directly on the bar moves the camera directly to the new position in one smooth movement. Clicking on the arrows at the ends of a bar causes a stepped, incremental change.

### Click-in-image

The PTZ device can also be controlled using **click-in-image** movement, which can also be of relative or absolute type.

Absolute click-in-image movement means that the camera view will center on the absolute position that was clicked.

Relative click-in-image movement means that by clicking and holding the mouse button down in the image, the PTZ device moves the camera in that direction, relative to the center of the image. The further from the center the image is clicked, the greater the movement.

You can also use Area Zoom to draw a box over a desired area to zoom in on. Using your mouse click in the image where you want the center of the area you are going to zoom in on, and while holding down the left mouse button draw a square over the size of area you would like to zoom in on.

### Focus and Iris Controls

The Focus and Iris (image brightness) can be adjusted manually by using the control bars, or they can be set for automatic adjustment, by clicking the **Auto Iris** and **Auto Focus** buttons.

### Preset Positions

These presets are selected from the **Source** drop-down list in the Live View page and will move and zoom the camera to a pre-defined position, i.e. to cover an area of particular interest. Events can also be configured to go to preset positions when triggered. For information on setting up preset positions, please see *Dome Configuration*, on page 27 and the online help.

### PTZ Control Queue

This indicates that PTZ queueing has been enabled. This means that the time the user is in control of the PTZ device is limited and that a user queue has been set up. Use the buttons to request or release control of the PTZ controls. For information on how to set up the control queue, please see *PTZ Control Queue* on page 28 and the online help.

### Using CGI links to control PTZ devices

User-defined CGI links on the Live View page can be used to issue HTTP API requests, such as PTZ commands. These links are configured in the Live View Layout settings, see page 23.

# Dome Configuration

## Preset Positions

A preset position is a pre-defined camera view than can be used to quickly move the camera to a specific location.

From **Preset Position Setup**, use the Pan, Tilt and Zoom (PTZ) controls to steer the camera to the required position. When satisfied with the camera's position, enter a descriptive name. The camera position, iris and focus settings are then saved as a preset position.

The position can be assumed at any time, by selecting the preset's name from the **Available positions** drop-down list. Preset positions can be selected in **Live View**, from events, in **Sequence mode** and in the **Guard Tour**.

One position can be set as the **Home** position, which is readily accessible by clicking on the **Home** button in the **Preset Position Setup** window. The position's name then displays **Home (H)** after it, such as **Office Entrance Home (H)**.

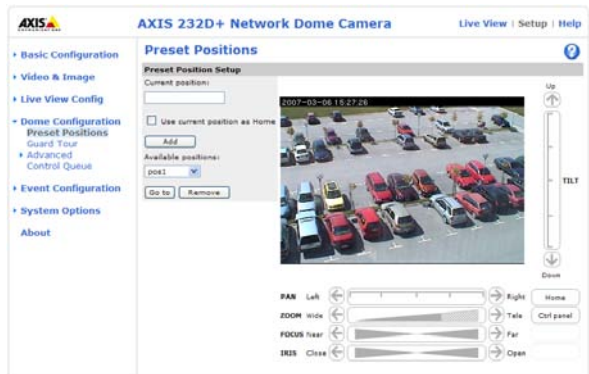

## Guard Tour

A guard tour moves between chosen Preset Positions, one-by-one, in a pre-determined order or at random, and for configurable time periods. Unlike the Sequence Mode, which is a viewing application under Live View Config (see *Live View Config*, on page 20), the guard tour sequence keeps running after the user has logged off or closed the browser.

Once the preset position has been set, and added to the guard tour, the following settings can be made:

- Set a pause between runs
- Add and remove positions
- View Time in seconds or minutes
- Move Speed - sets the speed of the Pan/Tilt movements to the preset position
- View Order (or Random)

## Advanced

### Limits

Define the **pan**, **tilt**, **zoom** and **focus** limits for the AXIS 231D+/232D+. Movements to the left and right, up and down can be restricted to narrow the area under surveillance. The near focus limit can be set to avoid focusing on objects too close to the camera.

**Notes:** Once a limit has been saved, this position cannot be exceeded by the AXIS 231D+/232D+ unless the values have been reset and saved to a greater value first (i.e. reset the default values of the mechanical restrictions).

Continuous zoom or focus movements may not always honour the limits.

**Move speed** sets the speed of the camera's Pan/Tilt movements. The default setting is maximum speed.

### Controls

In the **Control** settings, use the Ctrl Panel to configure shortcut command buttons.

### Calibration

The calibration page gives instructions for calibration of the AXIS 231D+/232D+.

## Control Queue

The administrator can set up a queue for the PTZ controllers. Once set up, the PTZ Control Queue buttons appear on the Live View page offering one viewer exclusive control for a limited amount of time. Other users are placed in the queue. For an overview of Pan Tilt Zoom controls, see page 25.



PTZ Control Queue	
Status in queue:	You are possessing the control.
Position in queue:	1
Time remaining:	37 seconds
<a href="#">Release control</a>	

PTZ Control Queue on Live View page

Please use the online help files [?](#) for more information.

# Event Configuration

This section describes how to configure the AXIS 231D+/232D+ for event handling.

Pre-defined parameters, known as an Event or Event Type can trigger certain actions in the camera. A common event type is an alarm that prompts the camera to upload images. Many event types use an Event Server, to receive uploaded images.

An event that is triggered by a signal, such as a door switch, motion detection, or system event, is called a triggered event, see page 19.

A scheduled event runs at pre-programmed times.

An Action refers to what happens when the event occurs.

## Event Servers

Event Servers can be used for receiving uploaded image files and/or notification messages. To set up Event server connections in your AXIS 231D+/232D+, go to **Setup > Event Configuration > Event Servers** and enter the required information according to the selected server type.

Server type	Purpose	Requires information
FTP Server	<ul style="list-style-type: none"> <li>used for uploading saved images</li> </ul>	<ul style="list-style-type: none"> <li>IP/Hostname</li> <li>Descriptive name of your choice</li> <li>User Name and Password (to FTP server)</li> </ul>
HTTP Server	<ul style="list-style-type: none"> <li>used for notification messages</li> <li>used for uploading saved images</li> </ul>	<ul style="list-style-type: none"> <li>Descriptive name of your choice</li> <li>URL</li> <li>User Name and Password (to HTTP server)</li> </ul>
TCP Server	<ul style="list-style-type: none"> <li>used for notification messages</li> </ul>	<ul style="list-style-type: none"> <li>IP/Hostname</li> <li>Descriptive name of your choice</li> <li>Port number e.g. port 80</li> </ul>

For details on each setting, refer to the online help files  available from each web page.

When the setup is complete, the connection can be tested by clicking the Test button (the connection test will take approximately 10 seconds).

## Event Types

An Event Type is a set of parameters describing how and when the Network Dome Camera is to perform certain actions.

**Example:** If a door is opened, and the network camera has been configured to act on this, it can record and save video images to an FTP server or send a notification email to a pre-configured email address with a pre-configured message. Video images can be sent as an attachment with the email.



## Triggered Event

A Triggered event can be activated from the following examples:

- a switch (doorbell) connected to an input port on the Network Dome Camera
- PTZ preset position
- built-in motion detection
- a manually activated action from a manual trigger button in the web interface
- on restart (reboot) after power loss

## How to set up a triggered event

This example describes how to set the Network Dome Camera to upload images when the main door is opened:

1. Click **Add triggered** on the Event types page.
2. Enter a descriptive **name** for the event, such as, Main door.
3. Set the **priority** - High, Normal or Low (see online help files).
4. Set the **Respond to Trigger...** parameters when the event is to be active, such as, only after office hours.
5. Select the trigger alternative from the **Triggered by...** drop-down list, such as an Input port with a connected sensor if the door is opened.
6. Set the **When Triggered...** parameters. This indicates what the Network Dome Camera is to do if the main door is opened, for example, upload images to an FTP server.
7. Click **OK** to save the Event in the Event Types list.

Please use the online help files  for descriptions of each available option.

### Pre-trigger and Post-trigger buffers

This function is useful for checking what happened immediately before and after a trigger - for example, 10 seconds before and after a door has been opened.

Go to Event Types > Add Triggered... > When Triggered... and check the Upload images checkbox to view more options.

Select upload type - Select if you want the images to be uploaded by FTP, HTTP, or to be sent via email.

Include pre-trigger buffer - images stored internally in the server from the time immediately preceding the trigger. Check the box to enable the pre-trigger buffer, enter the desired length of time and specify the required image frequency.

Include post-trigger buffer - contains images from the time immediately after the trigger. Configure as for pre-trigger.

- Notes:**
- Pre-trigger and Post-trigger buffers will be lost if the connection to the event server fails.
  - Maximum length of the pre-/post-buffer depends on the video image size and selected frame rate.
  - If the pre- or post-buffer is too large for the AXIS 282/AXIS 282A's internal memory, the frame rate is reduced and no images will be uploaded. If this occurs, an entry will be created in the unit's log file.

**Continue image upload (unbuffered)** - enable the upload of images for a fixed length of time. Specify the length of time for the uploaded recording, in seconds, minutes or hours, or for as long as the trigger is active. Finally, set the desired image frequency to the maximum (the maximum available) or to a specified frame rate. The frame rate will be the best possible, but might not be as high as specified, especially if uploading via a slow connection.

## Scheduled Event

A Scheduled event can be activated at pre-set times, in a repeating pattern on selected weekdays.

### How to set up a scheduled event

This example describes how to set the Network Dome Camera to send an email notification with saved images at a set time:

1. Click **Add scheduled** on the **Event types** page.
2. Enter a descriptive **name** for the event, such as **Scheduled email**.
3. Set the **priority** (High, Normal or Low).
4. Set the **Activation Time** parameters (24h clock) when the event is to be active, such as start on **Fridays** at 18.00 with a duration of 62 hours.
5. Set the **When Activated...** parameters, that is, specify an action at a certain time - for example send uploaded images to an email address.
6. Click **OK** to save the Event in the Event Types list.

Please use the online help files  for descriptions of each available option.



## Motion detection

In the Motion Detection menu, you can configure the video source(s) for motion detection. The motion detection feature is used to generate an alarm whenever movement occurs (or stops) in the image. The AXIS 231D+/232D+ can use a maximum of 10 windows (Include/Exclude).

- **Include** windows target specific areas within the image
- **Exclude** windows are areas to be ignored within the Include window

Once configured, the motion detection windows appear in a list when motion detection is selected to trigger an event. See *How to set up a triggered event* above.

**Note:** Using the motion detection feature may decrease overall performance in the video server.



### How to configure Motion Detection

This example describes how to configure motion detection:

1. Click **Motion Detection** in the **Event Configuration** menu.
2. Click the **Configure Included Windows** radio button.
3. Click **New**.
4. Enter a descriptive name of your choice under **Windows name**.
5. Adjust the size (drag the bottom right-hand corner) and position (click on the text at the top and drag to the desired position).
6. Adjust the **Object size**, **History** and **Sensitivity** profile sliders (see table below for details). Any detected motion within an active window is then indicated by red peaks in the **Activity** window (the active window has a red frame).

## 7. Click Save.

If there are parts of the Include window that you wish to exclude, click the **Configure Excluded Windows** radio button and perform steps 1-6 above. Click **Save**.

Please use the online help  for descriptions of each available option.

Parameter	Object Size	History	Sensitivity
High	Only very large objects trigger motion detection	An object that appears in the region will trigger the motion detection for a long period	Ordinary colored objects against ordinary backgrounds will trigger the motion detection
Low	Even very small objects trigger motion detection	An object that appears in the region will trigger motion detection for only a very short period	Only very bright objects against a dark background will trigger motion detection
Default values	Low	Medium to High	Medium to High

### Examples:

- Avoid triggering on small objects in the image by selecting a high size level.
- To trigger motion detection as long as there is activity in the area, select a high history level.
- To only detect flashing light, low sensitivity can be selected. In other cases, a high sensitivity level is recommended.

## Port Status

Under **Event Configuration > Port Status** there is a list that shows the status for the connected inputs and outputs of the AXIS 231D+/232D+ for the benefit of the Operator who cannot access the System Options section.

**Example:** If the Normal state for a push button (doorbell, for example) connected to an input is set to **Open circuit** – as long as the button is not pushed, the state is **inactive**. If the push button is pushed, the state of the input changes to **active**.

# System Options

---

## Security

User access control is enabled by default; the administrator sets the root password on first access. Other users are authorized with user names and passwords, or the administrator can choose to allow anonymous viewer login to the Live View page, as described below:

### Users

The user list displays the authorized users and access levels:

User	Description
Viewer	Provides the lowest level of access, which only allows the user access to the Live View page.
Operator	An Operator can view the Live View page, create and modify event types and adjust certain other settings. The Operator does not have access to the Systems Options configuration pages.
Administrator	An administrator has unrestricted access to the Setup Tools and can determine the registration of all other users.

To prevent unauthorized use of the product, the AXIS 231D+/232D+ network camera supports multi-user password protection, where access can be restricted to a defined number of users only (maximum of 20).

The AXIS 231D+/232D+ supports several methods of user authentication. These are:

- HTTP Basic Authentication - This authenticates the user by requesting a user name and a password. The exchange of network credentials is in simple base64 coding and is not encrypted.
- HTTP Digest Authentication - This method also requests a user name and password, but the exchange of credentials is encrypted, which better secures it against eavesdropping.

**User Settings** – check the corresponding checkboxes to enable:

- **Anonymous viewer login** - allows any viewer direct access to the Live View page.
- **Anonymous PTZ control login** - allows any viewer access to the Pan/Tilt/Zoom controllers on the Live View page.

### IP Address Filter

Enable IP Address Filtering - to allow or deny access to the AXIS 231D+/232D+ Network Camera check the box **Enable IP address filtering**. Once enabled, the IP addresses in the list are allowed or denied access according to the choice made in the drop-down list Allow/Deny the following IP addresses.

The administrator can add up to 256 IP address entries to the list (a single entry can contain multiple IP addresses). The users from these IP addresses need to be specified in the user list with the appropriate access rights. This is done from **Setup > System Options > Security > Users**.

**Referrals** - To prevent unauthorized sources from including the video stream from the AXIS 231D+/232D+ into external Web pages, check the **Referrals** checkbox and enter the IP address or Host name of the computer that hosts the Web pages with the included video stream. Several IP addresses/host names can be defined and are separated by semicolons(;).

**Notes:**

- If the referrals feature is enabled and to also allow normal access to the Live View page, the product's own IP address or host name must be added to the list of allowed referrers.
- Restricting referrers has no effect on an MPEG-4 video stream. To restrict an MPEG-4 stream, IP address filtering must be enabled.
- Restricting referrers is of greatest value when not using IP address filtering. If IP address filtering is used, then the allowed referrers are automatically restricted to those allowed IP addresses.

## HTTPS

For greater security, the AXIS 231D+/232D+ can be configured to use HTTPS (Hypertext Transfer Protocol over SSL (Secure Socket Layer)). That is, all communication that would otherwise go via HTTP will instead go via an encrypted HTTPS connection.

**Certificate** - to use HTTPS for communication with the AXIS 231D+/232D+, a **Certificate** must be created using one of the following methods:

- A self-signed certificate can be created in the network camera, but this does not guarantee the same level of security as an official certificate.
  - An official certificate issued by a CA (Certificate Authority). A CA issues and manages security credentials and public keys for message encryption.
1. Click either **Create self-signed certificate** or **Create Certificate Request** and enter the required information in the provided fields.
  2. Click **OK**.
  3. **Create self-signed certificate** generates and installs a certificate displayed under **Installed Certificate**.  
**Create Certificate Request** generates a PEM formatted request which you copy and send to a CA for signing. When the signed certificate is returned, click **Install signed certificate...** to install the certificate in the AXIS 231D+/232D+.
  4. Set the **HTTPS Connection Policy** for the administrator, Operator and Viewer to enable HTTPS connection (set to HTTP by default).

Please refer to the home page of your preferred CA for information on where to send the request. For more information, please refer to the online help files .

## 802.1X – Network Admission Control

IEEE 802.1X is an IEEE standard for port-based Network Admission Control. It provides authentication to devices attached to a network port (wired or wireless), establishing a point-to-point connection, or, if authentication fails, preventing access on that port. 802.1X is based on EAP (Extensible Authentication Protocol).

In a 802.1X enabled network switch, clients equipped with the correct software can be authenticated and allowed or denied network access at the Ethernet level.

Clients and servers in an 802.1X network may need to authenticate each other by some means. This is done with the help of digital certificates provided by a **Certification Authority**. These are then validated by a third-party entity, such as a **RADIUS server**, examples of which are Free Radius and Microsoft Internet Authentication Service.

To perform the authentication, the RADIUS server uses various EAP methods/protocols, of which there are many. The one used in the Axis implementation is EAP-TLS (EAP-Transport Layer Security).

The AXIS network video device presents its certificate to the network switch, which in turn forwards this to the RADIUS server. The RADIUS server validates or rejects the certificate and responds to the switch, and sends its own certificate to the client for validation. The switch then allows or denies network access accordingly, on a preconfigured port.

### The authentication process

#### RADIUS

RADIUS (Remote Authentication Dial In User Service) is an AAA (Authentication, Authorization and Accounting) protocol for applications such as network access or IP mobility. It is intended to work in both local and roaming situations.

#### CA servers

In cryptography, a Certification Authority (CA) is an entity that provides signed digital certificates for use by other parties, and thus acts a trusted third party.

There are many commercial CAs that charge for their services. Institutions and governments may have their own CA, and there are free CAs available.

## Date & Time

**Current Server Time** - displays the current date and time (24h clock). The time can be displayed in 12h clock format in the Overlay Images (see below).

**New Server Time** - Select your time zone from the drop-down list and check the daylight saving time changes, if desired.

From the **Time Mode** section, select the preferred method to use for setting the time:

- **Synchronize with computer time** - sets the time from the clock on your computer.
- **Synchronize with NTP Server** - the network camera will obtain the time from an NTP server every 60 minutes. Specify the NTP server's IP address or host name.

**Note:** Note that if using a host name for the NTP server, a DNS server must be configured under **TCP/IP** settings. See **Network > Advanced TCP/IP Settings** on page 40.

- **Set manually** - this option allows you to manually set the time and date.

**Date & Time Format Used in Images** - specify the formats for the date and time (12h or 24h) displayed in the Live View video streams.

Use the predefined formats or use your own custom date and time formats. See **Advanced File Naming & Date/Time Formats** in the help files  for information on how to create your own file formats.

## Network - Basic TCP/IP Settings

### IP Address Configuration

Your Axis network camera supports both IP version 4 and IP version 6. Both versions may be enabled simultaneously, and at least one version must always be enabled.

When using IPv4, the IP address can be set automatically via DHCP, or a static IP address can be set manually.

If IPv6 is enabled, your camera will receive an IP address according to the configuration in the network router.

There are also options for setting up notification of changes in the IP address, and for using the AXIS Internet Dynamic DNS Service. For more information on setting the IP address, please see the online help.

### Notes:

- DHCP is a protocol for automatic IP address assignment on a network. IP address assignment via DHCP may lead to the situation where the IP address changes and you lose contact with the camera. Configure the options for notification of IP address change (under Services) to receive notification from the camera when the IP address changes.
- Alternatively, if your DHCP server can update a DNS server, you can access the AXIS 231D+/232D+ by host name which is always the same, regardless of the IP address.

## Services

**Enable ARP/Ping setting of IP Address** - the IP address for the AXIS 231D+/232D+ can be set using the ARP/Ping method, which associates the unit's MAC address with an IP address.

**Options for notification of IP address change** - if the IP address for the video server changes, for example, automatically by DHCP, you can choose to be notified of the change. Click Settings... and enter the required information.

**AXIS Internet Dynamic DNS Service** - The AXIS Internet Dynamic DNS Service can provide your Axis product with its own URL (web address), which can then be used to access it over the Internet. The product can be unregistered from the service at any time. To do this click Settings... and follow the instructions. For more information, please refer to the online help.

## Network - Advanced TCP/IP Settings

### DNS Configuration

DNS (Domain Name Service) provides the translation of host names to IP addresses on your network.

**Obtain DNS server address via DHCP** - automatically use the DNS server settings provided by the DHCP server. Click the View button to see the current settings.

**Use the following DNS server address** - enter the desired DNS server by specifying the following:

**Domain name** - enter the domain(s) to search for the host name used by the AXIS 231D+/232D+. Multiple domains can be separated by semicolons (;). The host name is always the first part of a Fully Qualified Domain Name, for example, **myserver** is the host name in the Fully Qualified Domain Name **myserver.mycompany.com** where **mycompany.com** is the Domain name.

**DNS servers** - enter the IP addresses of the primary and secondary DNS servers.

### NTP Configuration

The AXIS 231D+/232D+ can obtain the correct AXIS time from an NTP server. The address for the NTP server can either be obtained via the DHCP server, or it can be entered manually.

### Host Name Configuration

The AXIS 231D+/232D+ can be accessed using a host name, instead of an IP address. The host name is usually the same as the assigned DNS Name. It is always the first part of a Fully Qualified Domain Name and is always one word, with no period. For example, **myserver** is the host name in the Fully Qualified Domain Name **myserver.mycompany.com**.

The **enable dynamic DNS updates** allows you to alias a dynamic IP address to a static host name, allowing your computer easier access from various locations on the Internet. Outside users can always access your server using the associated DNS name regardless of the WAN IP. The DNS server used by the user and/or the DNS server responsible for the domain in use must support RFC2136 and allow updates from the AXIS 231D+/232D+.

The **TTL (Time To Live)** value determines how long (in seconds) the reply from the DNS server should be remembered when checking that the domain name for the registered IP address is still valid. For more information, please see the online help .

### Link-Local Address

This is enabled by default and assigns the AXIS 231D+/232D+ an additional IP address for use with UPnP™. The AXIS 231D+/232D+ can have both a Link-Local IP and a static/DHCP-supplied IP address at the same time - these will not affect each other.

### HTTP

The default HTTP port number (80) can be changed to any port within the range 1024-65535. This is useful for simple port mapping, for example.



## HTTPS

The default HTTPS port number (443) can be changed to any port within the range 1024-65535. HTTPS is used to provide encrypted web browsing.

## NAT Traversal

A broadband router allows devices on a private network (LAN) to share a single connection to the Internet. This is done by forwarding network traffic from the private network to the "outside" i.e. the Internet. Security on the private network (LAN) is increased since most broadband routers are pre-configured to stop any attempts to access the private network (LAN) from the public network/Internet.

Use NAT traversal when your AXIS 231D+/232D+ is located on an intranet (LAN) and you wish to make it available from the other (WAN) side of a NAT router. With NAT traversal properly configured, all HTTP traffic to an external HTTP port in the NAT router will be forwarded to the camera.

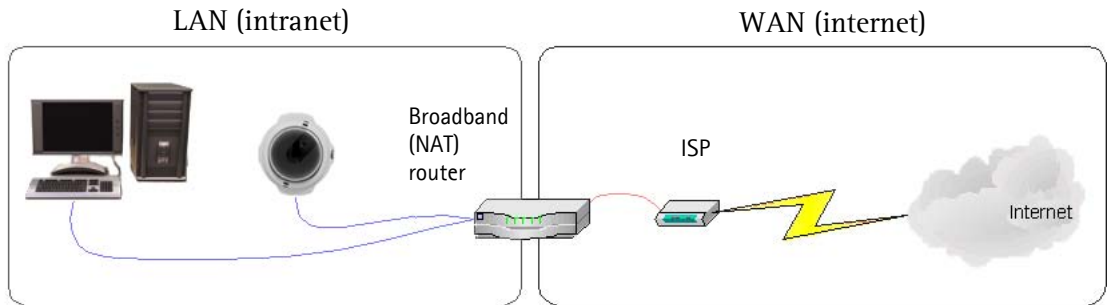

- Notes:**
- For NAT traversal to work, this must also be supported by the broadband router.
  - The broadband router has many different names: "NAT router", "Network router", "Internet Gateway", "Broadband sharing device" or "Home firewall" but the essential purpose of the device is the same.

**Enable/Disable** - When enabled, the AXIS 231D+/232D+ will attempt to configure port mapping in a NAT router on your network, using UPnP™. Note that UPnP™ must be enabled in the camera (see **System Options > Network > UPnP**).

**Use manually selected NAT router** - Select this option to manually select a NAT router and enter the IP address for the router in the field provided.

If a router is not manually specified, the AXIS 231D+/232D+ automatically searches for NAT routers on your network. If more than one router is found, the default router will be selected.

**Alternative HTTP port** - Select this option to manually define an external HTTP port. Enter the port number in the field provided. If no port is entered here a port number will automatically be selected when NAT traversal is enabled.

- Notes:**
- An alternative HTTP port can be used/be active even if NAT traversal is disabled. This is useful if for example, your NAT router does not support UPnP and you need to manually configure port forwarding in the NAT router.
  - If you attempt to manually enter a port that is already in use, another available port is automatically selected.
  - When the port is selected automatically it is displayed in this field. This can be changed by entering a new port number and clicking Save.

## FTP

The FTP server running in the AXIS 231D+/232D+ enables the upload of new firmware, and user applications. Check the box to enable the service.

## RTSP

The RTSP protocol allows a connecting client to start an MPEG-4 stream. Enter the RTSP port number to use. The default setting is 554.

## Network Traffic

The default setting is **Auto-negotiate** which means that the correct speed is automatically selected. If necessary, you can set the connection speed by selecting it from the drop-down list.

**Maximum bandwidth** - Specify, in Mbit/s or kbit/s, the maximum bandwidth that the network camera is allowed to use on your network. This is a useful function when connecting your network camera to busy or heavily loaded networks. The default setting is **Unlimited**.

**Note:** When using MPEG-4 as the video format, remember that setting a maximum bandwidth value here may create problems for individual video streams if the maximum value is less than the sum of the bit rates set for the video streams.

For more information, please see the online help 

## SOCKS

SOCKS is a networking proxy protocol. The AXIS 231D+/232D+ can be configured to use a SOCKS server to reach networks on the other side of a firewall/proxy server. This functionality is useful if the AXIS 231D+/232D+ is located on a local network behind a firewall, but notifications, uploads, alarms, need to be sent to a destination outside the local network (for example, the Internet).

## QoS (Quality of service)

Quality of Service (QoS) provides the means to guarantee a certain level of a specified resource to selected traffic on a network. Quality can be defined as a maintained level of bandwidth, low latency, and no packet losses. The main benefits of a QoS-aware network can be summarized as:

- The ability to prioritize traffic and thus allow critical flows to be served before flows with lesser priority.
- Greater reliability in the network, thanks to the control of the amount of bandwidth an application may use, and thus control over bandwidth races between applications.

The QoS in Axis network video products marks the data packets for various types of network traffic originating from the product. This makes it possible for network routers and switches to reserve a fixed amount of bandwidth for these types of traffic. The following types of traffic are marked:

- live video
- live audio
- event/alarm traffic
- management network traffic.

### QoS Settings

For each type of network traffic supported by your Axis network video product, enter a DSCP (Differentiated Services Codepoint) value. This value is used to mark the traffic's IP header. When the marked traffic reaches a network router or switch, the DSCP value in the IP header tells the router or switch which type of treatment to apply to this type of traffic, for example, how much bandwidth to reserve for it.

Note that DSCP values can be entered in decimal or hex form, but saved values are always shown in decimal.

For more information on Quality of Service, please see the Axis support web at [www.axis.com/techsup](http://www.axis.com/techsup)

## SMTP (email)

(Simple Mail Transfer Protocol) Enter the host names or addresses for your primary and secondary mail servers in the fields provided to enable event and error email messages from the AXIS 231D+/232D+ to predefined addresses, via SMTP.

## SNMP

The Simple Network Management Protocol (SNMP) allows remote management of network devices. Depending on the level of security required, select the version of SNMP to use. The three levels of security are:

- SNMP V1 - includes no security.
- SNMP V2c - uses very simple security. The community name can be specified as a password for read or read/write access to all supported SNMP objects. The community is the the group of network devices using SNMP.
- SNMP V3 - provides encryption and secure passwords. HTTPS must be enabled.

## UPnP™

(Universal Plug and Play) The AXIS 231D+/232D+ includes support for UPnP™ in Windows ME and Windows XP. UPnP™ is enabled by default.

**Note:** UPnP must be installed on your workstation. To do this, open the Control Panel from the **Start Menu** and select **Add/Remove Programs**. Select **Add/Remove Windows Components** and open the **Networking Services** section. Click **Details** and then select **UPnP** as the service to add. Refer to the Windows help files for more information.

## RTP (Multicast)/ MPEG-4

These settings are for the IP addresses, port numbers, and Time-To-Live values to use for media streams in the MPEG-4 format.

**Port Range** - the RTP Port range defines the range of ports from which the video/audio ports are automatically selected. This feature is useful if the AXIS 231D+/232D+ is connected to a NAT router with manually configured port mapping.

**Multicast** - only IP addresses within certain ranges can be used for multicasting. The AXIS 231D+/232D+ has been pre-configured with addresses from these ranges, and does not normally need to be reconfigured.

For more information, please see the online help. 

## Bonjour

Your Axis network camera includes support for Bonjour. When enabled, the camera is automatically detected by operating systems and clients that support this protocol.

## Ports & devices - I/O Ports

The pinout, interface support and the control and monitoring functions are described in the section on the *Connection Module*, on page 48.

## Maintenance

- **Restart** - the unit is restarted without changing any setting. Use this method if the unit is not behaving as expected.
- **Restore** - the unit is restarted and most current settings are reset to factory default values. The settings that will not be reset are as follows:
  - the boot protocol (DHCP or static)
  - the static IP address
  - the default router
  - the subnet mask
  - the system time
- **Default** - the default button should be used with caution. Pressing this will return all of the network camera's settings to the factory default values (including the IP address).

**Dome Status** - click the Test button to check the camera and dome mechanics for errors. Contact Axis Customer Services if you receive an error message as the result of this test.

**Upgrade Server** - See *Support*, on page 45.

**Backup** - to take a backup of all of the parameters, and any user-defined scripts, click this button. If necessary, it is then possible to return to a previous configuration if settings are changed and there is unexpected behavior.

**Restore** - click the **Browse** button to locate the saved backup file (see above) and then click the **Restore** button. The settings are restored to the previous configuration.

**Note:** Backup and Restore can only be used on the same unit running the same firmware. This feature is not intended for multi-configurations or for firmware upgrades.

## Support

### Support Overview

The **support overview** page provides valuable information on troubleshooting and contact information, should you require technical assistance.

### System Overview

The **System Overview** page gives a quick look over the camera's status and settings. Information that can be found here includes the camera's Firmware version, IP address, Security, Optional Network Services, Event Settings, Image settings and Recent log items. Many of the captions are also links to the proper **Setup** page to conveniently make adjustments in the camera's settings.

### Logs & Reports

When contacting Axis support, please be sure to provide a valid Server Report with your query. The Access Log is automatically included in the server report.

This page gives you access to the following log files and reports that may prove useful when troubleshooting a problem or when contacting the Axis support web.

**System Log** - - Provides information about system events.

**Access Log** - - The Access Log may be used for various purposes:

- Security - Tracking all access to your camera. The access log lists the IP addresses, users and networking protocols used to access the camera.
- Simple web attraction tracker.
- System analysis and trouble shooting.

**Server Report** - - Provides information about the server status and should always be included when requesting support.

**Parameter List** - - Shows the unit's parameters and their current settings.

**Connection List** - - Lists all clients that are currently accessing video and audio. It is also used for system analysis and trouble shooting.

### Configuration:

**Log Level for Log Files** - from the drop-down list, select the level of information to be added to the Log file

**Log Level for Email** - from the drop-down list, select the level of information to send as email and enter the destination email address.

## Advanced

Scripting is an advanced function that provides the possibility to customize and use scripts. This function is a very powerful tool.

### Caution!

Improper use may cause unexpected behavior or even cause loss of contact with the unit. If a script does cause problems, reset the unit to its factory default settings. A backup file may be of use to return the unit to its latest configuration).

**Axis strongly recommends that you do not use this function unless you fully understand the consequences.** Note that Axis support does not provide assistance for problems with customized scripts.

For more information, please visit the Developer pages at [www.axis.com/developer](http://www.axis.com/developer)

**Plain Config** - this function is for the advanced user with experience of Axis network camera configuration. All parameters can be set and modified from this page. Help is available from the standard help pages.

## About

Third Party Software Licenses - click View licenses for a list of the licensed software used in the AXIS 231D+/232D+ Network Dome Camera.

## Resetting to Factory Default Settings

To reset the AXIS 231D+/232D+ to the original default settings, go to the **System Options > Maintenance** web page (described in *Maintenance*, on page 45) or use the control button on the AXIS 231D+/232D+ as described below:

### Using the Control Button

Follow the instructions below to reset the AXIS 231D+/232D+ to factory default settings using the Control Button.

1. Switch off the AXIS 231D+/232D+ by disconnecting the power.
2. Press and hold the Control button while you reconnect the power.
3. Keep the Control button pressed until the **Power Indicator** flashes amber (this may take up to 15 seconds).
4. Release the Control button.
5. When the Power Indicator changes to green (may take up to 1 minute), the process is complete and the AXIS 231D+/232D+ has been reset.

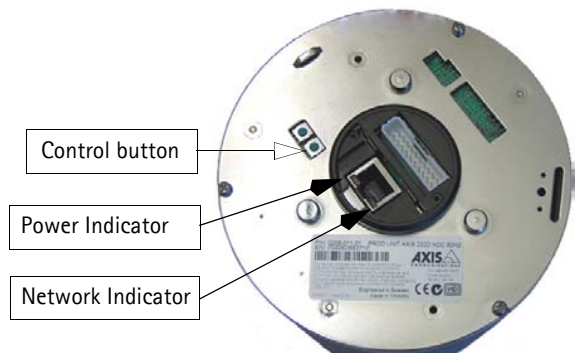

## Connection Module

This section describes the pinout provided by the Connection module consisting of:

- 4 transistor outputs
- 4 digital inputs
- power and GND (ground)

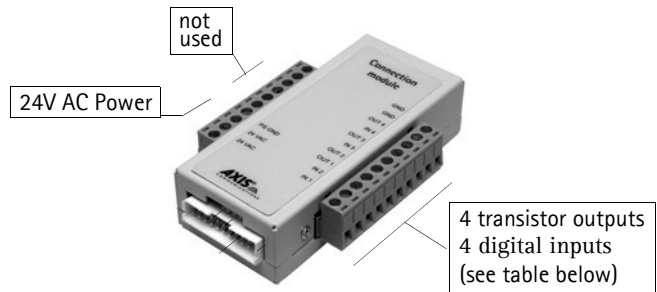

The inputs/outputs are used in applications for event triggering, time lapse recording, alarm notification via email, and picture storage to FTP locations, among others.

- **Input** - for example a doorbell. If the doorbell is pressed, the state changes, and the input is active (shown under Event Configuration > Port Status).
- **Output** - for example, an alarm device that can be activated from Output buttons from the Live View page or as an action to an Event Type. The output shows as active (under Event Configuration > Port Status), if the alarm device is activated.

### Connection Module Pinout

Function	Description	Function	Description
n/a	not used	GND	ground
n/a	not used	GND	ground
n/a	not used	Transistor Output 4	See below
n/a	not used	Digital Input 4	See below
n/a	not used	Transistor Output 3	See below
n/a	not used	Digital Input 3	See below
n/a	not used	Transistor Output 2	See below
PS GND	ground	Transistor Output 1	See below
24 VAC	24 VAC	Digital Input 2	See below
24 VAC	24 VAC	Digital Input 1	See below

Digital Input (1-4)- connect to GND to activate or leave floating (unconnected) to deactivate

Transistor Output (1-4)- Max. load 100mA, max. voltage 24V DC. An open-collector NPN transistor with the emitter connected to pin 2 (GND). If used with an external relay, a diode must be connected in parallel with the load for protection against any voltage transients.

1. Loosen the corresponding screw on top of the pin (see the table above to determine which pin to use).



2. Push the cable into the connector and secure it by fastening the screw.

Schematic Diagram - AXIS 231D+/232D+ I/O connectors and power

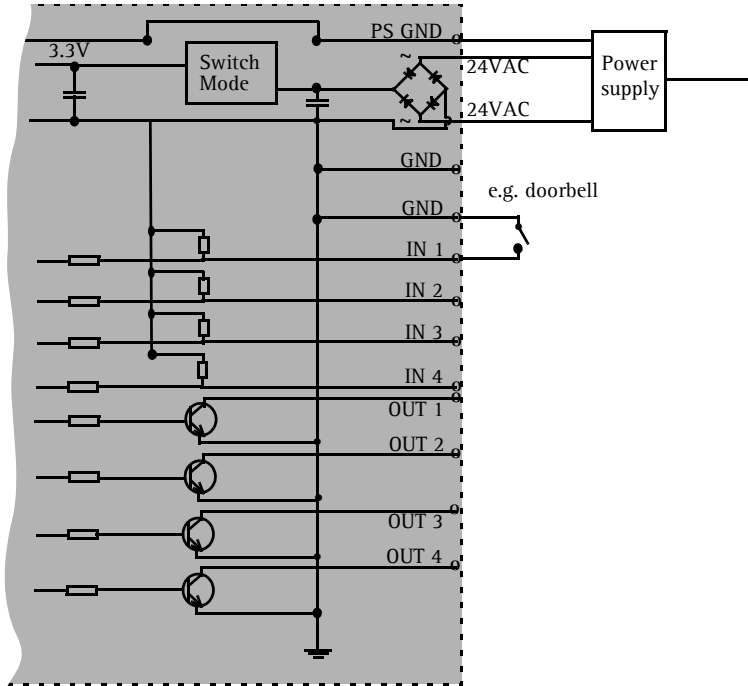

**Note:** Unmarked I/O connectors on the connection module can not be used.

# Troubleshooting

---

## Checking the Firmware

One of your first actions when troubleshooting a problem should be to check the firmware version. The latest version may contain a correction that fixes your particular problem. See the support section at <http://www.axis.com/techsup> for information on the latest available firmware version. The current software version in your AXIS 231D+/232D+ is available from the product Web pages under **Setup > Basic Configuration**.

## Updating the Firmware

The firmware is software that determines the functionality of the AXIS 231D+/232D+. When you upgrade to the latest available firmware from the Axis Web site, your Axis product will receive the latest functionality. Always read the upgrade instructions and release notes available with each new release, before upgrading the firmware.

New firmware can be uploaded to the AXIS 231D+/232D+ over the network.

**Note:** Preconfigured and customized settings are retained for use when the new firmware is running (providing that the features are available in the new firmware) although this is not guaranteed by Axis Communications.

1. Save the firmware file to your computer. The latest version of the AXIS 231D+/232D+ firmware is available free of charge from the Axis Web site at <http://www.axis.com/techsup> or from your local distributor.
2. Go to **Setup > System Options > Maintenance** in the AXIS 231D+/232D+ Web pages.
3. In the **Upgrade Server** section browse to the desired firmware file on your computer. Click **Upgrade**.

**Notes:** After starting the process, wait at least 20 minutes before restarting the AXIS 231D+/232D+, even if you suspect the procedure has failed.

Your dealer reserves the right to charge for any repair attributable to faulty updating by the user.

## Emergency Recovery Procedure

If power or the network connection to the AXIS 231D+/232D+ is lost during the upgrade, the process will fail and the unit become unresponsive. A flashing red Network LED indicates a failed upgrade. To recover the unit, follow the steps below. The serial number is found on the label on the product casing.

1. **Unix/Linux** - From the command line, type the following:  
arp -s <IP address of AXIS 231D+/232D+> <Serial number> temp  
ping -s 408 <IP address of AXIS 231D+/232D+>

**Windows** - From a command/DOS prompt, type the following:  
arp -s <IP address of AXIS 231D+/232D+> <Serial number>  
ping -l 408 -t <IP address of AXIS 231D+/232D+>

**Note:** the ping -l command is the lower-case letter (l)

2. If the unit does not reply within a few seconds, restart and wait for a reply. Press CTRL+C to stop Ping.
3. Open a browser and type in the AXIS 231D+/232D+'s IP address. In the page that appears, use the **Browse** button to select the upgrade file to use, for example axis231d.bin or axis232d.bin. Then click the **Load** button to restart the upgrade process.
4. After the upgrade complete (1-10 minutes), the unit automatically restarts and shows a steady green on the Power LED and flashing green or amber on the Network LED.
5. Reinstall the AXIS 231D+/232D+.

If the emergency recovery procedure does not get the AXIS 231D+/232D+ up and running again, contact Axis support at [www.axis.com/techsup/](http://www.axis.com/techsup/).

## Support

If you contact Axis Customer Services, please help us help you resolve your problems expediently by providing a server report, log file and a brief description of the problem.

**Server Report** - go to **Setup > System Options > Support Overview**. The server report contains important information about the server and its software, as well as a list of the current parameters.

**Log file** - go to **Setup > System Options > Logs & Reports**. The Log file records events within the unit since the last restart of the system and can prove a useful diagnostic tool for troubleshooting.

## Symptoms, Possible Causes and Remedial Actions

### Problems setting the IP address

Using ARP Ping	The IP address must be set within two minutes after the power has been applied to the AXIS 231D+/232D+; restart the server and try again. Also, make sure the ping length is set to 408. See the ARP ping description in the Installation Guide.
The AXIS 231D+/232D+ is located on a different subnet.	If the IP address intended for the AXIS 231D+/232D+ and the IP address of your computer are located on different subnets, you will not be able to set the IP address. Contact your network administrator for an IP address on the same subnet as the computer you are performing the installation from.
The IP address is being used by another device	<b>Disconnect the power from the AXIS 231D+/232D+.</b> Run the Ping command (in a Command/DOS window, type <b>ping</b> and the <b>IP address</b> of the unit).  If you receive: <b>Reply from &lt;IP address&gt;: bytes = 32; time = 10 ms....</b> - this means that the IP address may already be in use by another device on your network. You must obtain a new IP address and reinstall the unit.  If you receive: <b>Request timed out</b> - this means that the IP address is available for use with your AXIS 231D+/232D+. In this case, check all cabling and reinstall the unit.

### The AXIS 231D+/232D+ cannot be accessed from a Web browser

Cannot log in.	If the AXIS 231D+/232D+ has been configured to use HTTPS, check that the protocol in the URL used to access the unit is correct. You may need to type this in manually (i.e. http or https) in the browser's address field.
The IP address has been changed by DHCP	1) Move the AXIS 231D+/232D+ to an isolated network or to one with no DHCP or BOOTP server. Set the IP address again, using AXIS IP Utility or the ARP Ping command. 2) Access the unit and disable BOOTP and DHCP in the TCP/IP settings. Return the unit to the main network. The unit now has a fixed IP address that will not change. 3) As an alternative to 2), if dynamic IP address via DHCP or BOOTP is required, select the required service and then configure IP address change notification from the network settings. Return the unit to the main network. The unit will now have a dynamic IP address, but will notify you if the address changes.
Cannot access web page	Empty the temporary cache of your web browser.
Other networking problems	Test the network cable by connecting it to another network device, then Ping that device from your workstation. See instructions above.

### Cannot send notifications, uploads, alarms to a destination outside the local network

Firewall protection	The AXIS 231D+/232D+ can be configured to use a SOCKS server to reach networks on the other side of a firewall/proxy server. See <i>SOCKS</i> , on page 42 for more information.
---------------------	--

### Your AXIS 231D+/232D+ is accessible locally, but not externally

Firewall protection	Check the Internet firewall with your system administrator.
Default routers required	Check if you need to configure the default router settings, and check the subnet mask.
The Internet site is too heavily loaded	Use a script running on your web server to relay images from the AXIS 231D+/232D+ to the Internet.

### The Power indicator is not constantly lit

Faulty power supply	Verify that you are using the correct power supply.
A firmware upgrade has been interrupted or the firmware has in some other way been damaged.	A rescue firmware is running in the product. First, set the IP address using AXIS IP utility or ARP and Ping,  Then, from a Web browser, access the unit and upgrade the latest firmware to the product, see <i>Updating the Firmware</i> , on page 50.

### No images are displayed in the Web interface

Problem with AMC ( <i>Internet Explorer only</i> )	To enable the updating of images in Microsoft Internet Explorer, set your Web browser to allow ActiveX controls. Also, make sure that AXIS Media Control (AMC) component is installed on your workstation.
--	--

Installation of additional ActiveX component restricted or prohibited	Configure your AXIS 231D+/232D+ to use a Java applet for updating the images under <b>Live View Config &gt; Layout &gt; Default Viewer</b> for Internet Explorer. See help files for more information.
---	--

**Video Image Problems**

Image too dark or too light.	See the help files on Video Et Image Settings
Problems uploading own files	There is only limited space available for the upload of your own files. Try deleting one or more existing files, to free up space.
Missing images in uploads	This can occur when trying to use a larger image buffer than is actually available. Try lowering the frame rate or the upload period.
Slow image update	Configuring, e.g. pre-buffers, hi-res images, high frame rate will reduce the performance of the AXIS 231D+/232D+.
Slow performance	Slow performance may be caused by e.g. heavy network traffic, many users with access to unit, low performing client, use of features such as Event handling., Image rotation, and applications such as an antivirus program.

**Bad snapshot images**

Display incorrectly configured on your workstation	In Display Properties, configure your display to show at least 65000 colors, i.e. at least 16-bit. Using only 16 or 256 colors on your display will produce dithering artifacts in the image.
--	---

**Problems with the MPEG-4 format**

Lower frame rate than expected.	<p>Check with the administrator that there is enough bandwidth available. Check also the settings for bit rate control, in the <b>Video Et Image &gt; Advanced &gt; MPEG-4</b> settings. Using an inappropriate video object type can also affect the frame rate. See the online help for more information.</p> <p>Check in the AMC control panel applet (MPEG-4 tab) that video processing is not set to <b>Decode only I frames</b>.</p> <p>Lower the image resolution.</p> <p>Reduce the number of applications running on the client computer.</p>
No MPEG-4 displayed in the client.	<p>Check that the correct network interface is selected in the AMC control panel applet (network tab).</p> <p>Check that the relevant MPEG-4 connection methods are enabled in the AMC control panel applet (network tab).</p> <p>In the AMC control applet, select the MPEG-4 tab and click the button Set to default MPEG-4 decoder.</p>
No multicast MPEG-4 displayed in the client.	<p>Check with your network administrator that the multicast addresses used by the AXIS 231D+/232D+ are valid for your network.</p> <p>Check with your network administrator to see if there is a firewall preventing viewing.</p>
Multicast MPEG-4 only accessible by local clients.	Check if your ISP and router support multicasting, or if the router settings between the client and the server need to be configured. The TTL (Time To Live) value may need to be increased.
Poor rendering of MPEG-4 images.	Color depth set incorrectly on clients. Set to 16-bit or 32-bit color.

**Unexpected PTZ behavior**

Problem with hardware	Go to <b>System Options &gt; Maintenance &gt; Dome Status</b> and click <b>Test</b> to test the camera and dome mechanics for errors. Contact Axis Customer Services if you receive an error message as the result of this test.
-----------------------	--

For additional assistance, please contact your reseller or check the product's support pages on the Axis Website at <http://www.axis.com/techsup>.

## Technical Specifications

Item	Specification
Models	<ul style="list-style-type: none"> <li>• AXIS 231D+ 50 Hz/PAL</li> <li>• AXIS 231D+ 60 Hz/NTSC</li> <li>• AXIS 232D+ 50 Hz/PAL (Automatic day/night)</li> <li>• AXIS 232D+ 60 Hz/NTSC (Automatic day/night)</li> </ul>
Image sensor	<ul style="list-style-type: none"> <li>• 1/4" Sony EXview HAD CCD</li> </ul>
Lens	<ul style="list-style-type: none"> <li>• F1.4-3.0</li> <li>• f=4.1 mm wide to 73.8 mm tele</li> <li>• autofocus</li> <li>• Focus range: 35 mm (wide) or 800 mm (tele) to infinity</li> </ul>
Angle of view	<ul style="list-style-type: none"> <li>• 2.8° - 48° Horizontal</li> </ul>
Zoom	<ul style="list-style-type: none"> <li>• 18x optical, 12x digital</li> </ul>
Minimum illumination	<ul style="list-style-type: none"> <li>• Color: 0.3 lux at 30IRE</li> <li>• B/W: 0.005 lux at 30IRE (Only AXIS 232D+)</li> </ul>
Pan Range	<ul style="list-style-type: none"> <li>• 360° endless</li> </ul>
Tilt Range	<ul style="list-style-type: none"> <li>• 0° - 90°</li> </ul>
Max speed	<ul style="list-style-type: none"> <li>• Pan 360°/s</li> <li>• Tilt 360°/s</li> </ul>
Video compression	<ul style="list-style-type: none"> <li>• Motion JPEG</li> <li>• MPEG-4 Part 2 (ISO/IEC 14496-2), Profiles: ASP and SP</li> </ul>
Resolutions	<ul style="list-style-type: none"> <li>• 4CIF, 2CIF Expanded, 2CIF, CIF, QCIF</li> <li>• Maximum 704x480 (NTSC) 704x576 (PAL)</li> <li>• Minimum 176x120 (NTSC) 176x144 (PAL)</li> </ul>
Frame rate (NTSC/PAL)	<ul style="list-style-type: none"> <li>• Motion JPEG: Up to 30/25 fps in all resolutions</li> <li>• MPEG-4: Up to 25/21 fps at 4CIF/2CIFExp Up to 30/25 fps at 2CIF/CIF/QCIF</li> </ul>
Video streaming	<ul style="list-style-type: none"> <li>• Simultaneous Motion JPEG and MPEG-4</li> <li>• Controllable frame rate and bandwidth</li> <li>• Constant and variable bit rate (MPEG-4)</li> </ul>
Image settings	<ul style="list-style-type: none"> <li>• Wide Dynamic Range (WDR)</li> <li>• Compression levels: 11 (Motion JPEG)/23 (MPEG-4)</li> <li>• Configurable brightness, sharpness, white balance, exposure control, and backlight compensation</li> <li>• Overlay capabilities: time, date, text, custom logo or image</li> <li>• Mirroring</li> <li>• De-interlacing (4CIF resolution)</li> </ul>
PTZ control	<ul style="list-style-type: none"> <li>• 50 preset positions</li> <li>• Guard tour</li> <li>• Control queue</li> <li>• Supports Windows compatible joysticks</li> </ul>
Shutter time	<ul style="list-style-type: none"> <li>• 1 sec to 1/10.000 sec</li> </ul>

Item	Specification
Security	<ul style="list-style-type: none"> <li>• Multiple user access levels with password protection</li> <li>• IP address filtering</li> <li>• HTTPS encryption</li> <li>• IEEE 802.1X authentication</li> </ul>
Alarm and event management	<ul style="list-style-type: none"> <li>• Events triggered by video motion detection, PTZ preset position, external inputs, or according to a schedule</li> <li>• Image upload over FTP, email and HTTP</li> <li>• Notification over TCP, email, HTTP, and external outputs</li> <li>• Pre- and post alarm buffer of 9 MB per channel</li> </ul>
Connectors	<ul style="list-style-type: none"> <li>• Ethernet 10BaseT/100BaseTX, RJ-45</li> <li>• 4 alarm inputs</li> <li>• 4 outputs</li> </ul>
Processors and memory	<ul style="list-style-type: none"> <li>• CPU: ETRAX 100LX 32bit</li> <li>• Video processing and compression: ARTPEC-2</li> <li>• Memory: 32 MB RAM, 8 MB Flash</li> <li>• Battery backed up real-time clock</li> </ul>
Power	<ul style="list-style-type: none"> <li>• 19 - 28 VAC, max 25 VA</li> <li>• 24 - 40 VDC, max 20 W</li> </ul>
Operating conditions	<ul style="list-style-type: none"> <li>• 5 - 50 °C (41 - 122 °F)</li> <li>• Humidity 20 - 80% RH (non-condensing)</li> </ul>
Installation, management and maintenance	<ul style="list-style-type: none"> <li>• AXIS Camera Management tool on CD and web-based configuration</li> <li>• Configuration of backup and restore</li> <li>• Firmware upgrades over HTTP or FTP, firmware available at <a href="http://www.axis.com">www.axis.com</a></li> </ul>
Video access from Web browser	<ul style="list-style-type: none"> <li>• Camera live view</li> <li>• Video recording to file (ASF)</li> <li>• Sequence tour for up to 20 PTZ presets or Axis video sources</li> <li>• Customizable HTML pages</li> </ul>
Minimum requirements	<ul style="list-style-type: none"> <li>• Pentium III CPU 500 MHz or higher, or equivalent AMD, 128 MB RAM, AGP graphics card 32 MB RAM, Direct Draw</li> <li>• Windows XP, 2000, DirectX 9.0 or later Internet Explorer 6.x or later</li> <li>• For other operating systems and browsers see <a href="http://www.axis.com/techsup">www.axis.com/techsup</a></li> </ul>
System integration support	<ul style="list-style-type: none"> <li>• Open API for software integration available at <a href="http://www.axis.com">www.axis.com</a></li> <li>• including AXIS VAPIX API</li> <li>• AXIS Media Control SDK</li> <li>• event trigger data in video stream</li> <li>• PTZ control with Windows compatible Joystick</li> <li>• Quality of Service (QoS) Layer 3, DiffServ Model</li> <li>• Embedded operating system: Linux</li> </ul>
Supported protocols	<p>IPv4/v6, HTTP, HTTPS, SSL/TLS*, TCP, SNMPv1/v2c/v3 (MIB-II), RTSP, RTP, UDP, IGMP, RTCP, SMTP, FTP, ICMP DHCP, UPnP, Bonjour, ARP, DNS, DynDNS, SOCKS, IEEE802.1X. More information on protocol usage available at <a href="http://www.axis.com">www.axis.com</a></p> <p>*This product includes software developed by the Open SSL Project for use in the Open SSL Tool kit (<a href="http://www.openssl.org">www.openssl.org</a>)</p>

Item	Specification
Included accessories	<ul style="list-style-type: none"> <li>• Power supply: 24 V AC, 1.5 A</li> <li>• Hard ceiling mounting bracket</li> <li>• Drop ceiling mounting bracket</li> <li>• Transparent bubble</li> <li>• CD with installation tool, software,</li> <li>• User manual, MPEG-4 licenses (1 encoder, 1 decoder)</li> <li>• MPEG-4 decoder (Windows)</li> <li>• Quick installation guide</li> <li>• Connection module for power and alarm in/out</li> </ul>
Video management software (not incl.)	<ul style="list-style-type: none"> <li>• AXIS Camera Station - Surveillance application for viewing, recording and archiving up to 25 cameras</li> <li>• See <a href="http://www.axis.com/partner/adp_partners.htm">www.axis.com/partner/adp_partners.htm</a> for more software applications via partners</li> </ul>
Accessories (not incl.)	<ul style="list-style-type: none"> <li>• Housings for adverse indoor/outdoor environments</li> <li>• Smoked bubble</li> <li>• Outdoor IP66 rated power supply AXIS PS24</li> <li>• IR Illumination (Only AXIS 232D+)</li> <li>• AXIS 295 Video Surveillance Joystick</li> <li>• AXIS 292 Network Video Decoder</li> <li>• MPEG-4 Decoder multi-user license pack</li> </ul>
Approvals	<ul style="list-style-type: none"> <li>• EN 55022 Class A,</li> <li>• EN 61000-3-2,</li> <li>• EN 61000-3-3,</li> <li>• EN 55024,</li> <li>• FCC Part 15 Subpart B Class A,</li> <li>• ICES-003 Class A,</li> <li>• VCCI Class A,</li> <li>• C-tick AS/NZS CISPR 22 Class A,</li> <li>• EN 60065</li> <li>• Power supply: EN 60950, UL, CSA</li> </ul>
Dimensions and weight	<ul style="list-style-type: none"> <li>• 225 x 144 x 144 mm (8.9" x 5.7" x 5.7")</li> <li>• 1.8 kg (4.0 lbs) excluding power supply</li> </ul>

## General performance considerations

When setting up your system, it is important to consider how various settings and situations will affect performance. Some factors affect the bandwidth (the bit rate) required, others can affect the frame rate, and some affect both. If the load on the CPU reaches its maximum, this also affects the frame rate.



The following factors are among the most important to consider:

- High image resolutions and/or lower compression levels result in larger images. Bandwidth affected.
- Access by large numbers of Motion JPEG and/or unicast MPEG-4 clients. Bandwidth affected.
- Simultaneous viewing of different streams (resolution, compression.) by different clients. Frame rate and bandwidth affected.
- Accessing both Motion JPEG and MPEG-4 video streams simultaneously. Frame rate and bandwidth affected.
- Heavy usage of event settings affects the CPU load. Frame rate affected.
- Heavy network utilization due to poor infrastructure. Bandwidth affected.
- Viewing on poorly performing client PC's lowers perceived performance. Frame rate affected.

## Optimizing your system

To see the bandwidth and frame rate currently required by the video stream, the AXIS 231D+/232D+ provides a tool that can be used to display these values directly in the video image.

To do this, special format strings are added as part of a text overlay. Simply add **#r** (average frame rate in fps) and/or **#b** (average bandwidth in Kbps) bandwidth in Kbps) to the overlay.

For detailed instructions, please see the online help for **Video & Image > Overlay Settings**, and the help for **File Naming & Date/Time Formats**.



### Important!

- The figures displayed here are the values as delivered by the server. If other restrictions are currently in force, (e.g. bandwidth limitation) these values might not correspond to those actually received by the client.
- For Motion JPEG, these values will only be accurate as long as no frame rate limit has been specified.

## Frame rates - Motion JPEG

The following test results show the frame rates in frames/second (fps) for Motion JPEG streams from the AXIS 231D+/232D+, using a compression level of 50%. Note that these values are guidelines only - actual values may vary.

	fps (NTSC/PAL)
4CIF	30/25

2CIF expanded	30/25
2CIF	30/25
CIF	30/25
QCIF	30/25

## Frame rates - MPEG-4

The following test results show the frame rates in frames/second (fps) for MPEG-4 streams from the AXIS 231D+/232D+. Note that these values are guidelines only - actual values may vary.

The MPEG-4 test conditions:

- Compression level = 50%
- Video Object Type = Advanced Simple
- GOV structure = IP\*

	fps (NTSC)	fps (PAL)
4CIF	25	21
2CIF expanded	25	21
2CIF	30	25
CIF	30	25
QCIF	30	25

\*Note that setting the GOV structure to use "I-frames only" will increase the frame rate.

## Bandwidth

As there are many factors affecting bandwidth, it is very difficult to predict the required amounts. The settings that affect bandwidth are:

- the image resolution
- the image compression
- the frame rate
- the MPEG-4 object type
- the MPEG-4 GOV structure

There are also factors in the monitored scene that will affect the bandwidth. These are:

- the amount of motion
- the image's complexity
- the lighting conditions.

For MPEG-4, if there is only limited bandwidth available, and if this is more important than the image quality, using a constant bit rate (CBR) is recommended. Use a variable bit rate (VBR) if the image quality needs to be maintained at a higher level. If supported on the network, consider also using MPEG-4 multicasting, as the bandwidth consumption will be much lower.

## Glossary of Terms

**ActiveX** - A standard that enables software components to interact with one another in a networked environment, regardless of the language(s) used to create them. Web browsers may come into contact with ActiveX controls, ActiveX documents, and ActiveX scripts. ActiveX controls are often downloaded and installed automatically as required.

**AF (Autofocus)** - A system by which the camera lens automatically focuses on a selected part of the subject.

**Angle** - The field of view, relative to a standard lens in a 35mm still camera, expressed in degrees, e.g. 30°. For practical purposes, this is the area that a lens can cover, where the angle of view is determined by the focal length of the lens. A wide-angle lens has a short focal length and covers a wider angle of view than standard or telephoto lenses, which have longer focal lengths.

**ARP (Address Resolution Protocol)** - This protocol is used to associate an IP address to a hardware MAC address. A request is broadcast on the local network to discover the MAC address for an IP address.

**ARTPEC (Axis Real Time Picture Encoder)** - A chip designed by Axis for image compression. ARTPEC supports a range of CCD and CMOS sensors, built-in functionality for sharpening, backlight compensation, noise reduction and white balance, support for multiple Motion-JPEG streams, support for MPEG-4 part 2, up to 30 frames/second from 4 simultaneous video sources and real-time compression of up to 45 Megapixels/second.

**ASIC (Application Specific Integrated Circuit)** - A circuit designed for a specific application, as opposed to a general purpose circuit, such as a microprocessor.

**Aspect ratio** - A ratio of width to height in images. A common aspect ratio used for television screens and computer monitors is 4:3. High-definition television (HDTV) uses an aspect ratio of 9:16.

**Autoiris (or DC-Iris)** - This special type of iris is electrically controlled by the camera, to automatically regulate the amount of light allowed to enter.

**AVI (Audio Video Interleave)** - A video format that supports simultaneous playback of audio and video.

**Bitmap** - A bitmap is a data file representing a rectangular grid of pixels. It defines a display space and color for each pixel (or "bit") in the display space. This type of image is known as a "raster graphic". GIFs and JPEGs are examples of image file types that contain bitmaps.

Because a bitmap uses this fixed raster method, it cannot easily be rescaled without losing definition. Conversely, a vector graphic image uses geometrical shapes to represent the image, and can thus be quickly rescaled.

**Bit rate** - The bit rate (in kbit/s or Mbit/s) is often referred

to as speed, but actually defines the number of bits/time unit and not distance/time unit.

**Bluetooth** - Bluetooth is an open standard for wireless transmission of voice and data between mobile devices (PCs, handheld computers, telephones and printers).

**Bonjour** - Also known as zero-configuration networking, Bonjour enables devices to automatically discover each other on a network, without having to enter IP addresses or configure DNS servers. Bonjour is a trademark of Apple Computer, Inc.

**Broadband** - In network engineering terms, this describes transmission methods where two or more signals share the same carrier. In more popular terminology, broadband is taken to mean high-speed data transmission.

**CCD (Charged Coupled Device)** - This light-sensitive image device used in many digital cameras is a large integrated circuit that contains hundreds of thousands of photo-sites (pixels) that convert light energy into electronic signals. Its size is measured diagonally and can be 1/4", 1/3", 1/2" or 2/3".

**CGI (Common Gateway Interface)** - A specification for communication between a web server and other (CGI) programs. For example, a HTML page that contains a form might use a CGI program to process the form data once it is submitted.

**CIF (Common Intermediate Format)** - CIF refers to the analog video resolutions 352x288 pixels (PAL) and 352x240 pixels (NTSC). See also *Resolution*.

**Client/Server** - Client/server describes the relationship between two computer programs in which one program, the client, makes a service request from another program, the server, which fulfils the request. Typically, multiple client programs share the services of a common server program. A web browser is a client program that requests services (the sending of web pages or files) from a web server.

**CMOS (Complementary Metal Oxide Semiconductor)** - A CMOS is a widely used type of semiconductor that uses both negative and positive circuits. Since only one of the circuit types is on at any given time, CMOS chips require less power than chips using just one type of transistor. CMOS image sensors also allow processing circuits to be included on the same chip, an advantage not possible with CCD sensors, which are also much more expensive to produce.

**Codec** - In communications engineering, a codec is usually a coder/decoder. Codecs are used in integrated circuits or chips that convert e.g. analog video and audio signals into a digital format for transmission. The codec also converts received digital signals back into analog format. A codec uses analog-to-digital conversion and digital-to-analog conversion in the same chip.

Codec can also mean compression/decompression, in which case it is generally taken to mean an algorithm or computer program for reducing the size of large files and programs.

**Compression** - See *Image Compression*.

**Contrast** - Defines the degree of difference between the lightest and darkest parts of an image or video stream.

**DC-Iris** - This special type of iris is electrically controlled by the camera, to automatically regulate the amount of light allowed to enter.

**DHCP (Dynamic Host Configuration Protocol)** - DHCP is a protocol that lets network administrators automate and centrally manage the assignment of Internet Protocol (IP) addresses to network devices in a network.

DHCP uses the concept of a "lease" or amount of time that a given IP address will be valid for a computer. The lease time can vary, depending on how long a user is likely to require the network connection at a particular location.

DHCP also supports static addresses for e.g. computers running web servers, which need a permanent IP address.

**DNS (Domain Name System)** - DNS is used to locate and translate Internet domain names into IP (Internet Protocol) addresses. A domain name is a meaningful and easy-to-remember name for an Internet address. For example the domain name www.example.com is much easier to remember than 192.0.34.166. The translation tables for domain names are contained in Domain name servers.

**Domain Server** - Domains can also be used by organizations who wish to centralize the management of their (Windows) computers. Each user within a domain has an account that usually allows them to log in to and use any computer in the domain, although restrictions may also apply. The domain server is the server that authenticates the users on the network.

**Duplex** - See *Full-duplex*.

**Ethernet** - Ethernet is the most widely installed local area network technology. An Ethernet LAN typically uses special grades of twisted pair wires. The most commonly installed Ethernet systems are 10BASE-T and 100BASE-T10, which provide transmission speeds up to 10 Mbps and 100 Mbps respectively.

**ETRAX (Ethernet Token Ring AXIS)** - Axis' own microprocessor.

**Factory default settings** - These are the settings that originally applied for a device when it was first delivered from the factory. If it should become necessary to reset a device to its factory default settings, this will, for many devices, completely reset any settings that were changed by the user.

**Firewall** - A firewall works as a barrier between networks, e.g. between a Local Area Network and the Internet. The firewall ensures that only authorized users are allowed to access the one network from the other. A firewall can be software running on a computer, or it can be a standalone hardware device.

**Focal length** - Measured in millimeters, the focal length of

a camera lens determines the width of the horizontal field of view, which in turn is measured in degrees.

**FTP (File Transfer Protocol)** - An application protocol that uses the TCP/IP protocols. It is used to exchange files between computers/devices on networks.

**Frame** - A frame is a complete video image. In the 2:1 interlaced scanning format of the RS-170 and CCIR formats, a frame is made up of two separate fields of 262.5 or 312.5 lines interlaced at 60 or 50 Hz to form a complete frame, which appears at 30 or 25 Hz. In video cameras with a progressive scan, each frame is scanned line-by-line and not interlaced; most are also displayed at 30 and 25 Hz.

**Frame rate** - The frame rate used to describe the frequency at which a video stream is updated is measured in frames per second (fps). A higher frame rate is advantageous when there is movement in the video stream, as it maintains image quality throughout.

**Full-duplex** - Transmission of data in two directions simultaneously. In an audio system this would describe e.g. a telephone systems. Half-duplex also provides bi-directional communication, but only in one direction at a time, as in a walkie-talkie system. See also *Simplex*.

**Gain** - Gain is the amplification factor and the extent to which an analog amplifier boosts the strength of a signal. Amplification factors are usually expressed in terms of power. The decibel (dB) is the most common way of quantifying the gain of an amplifier.

**Gateway** - A gateway is a point in a network that acts as an entry point to another network. In a corporate network for example, a computer server acting as a gateway often also acts as a proxy server and a firewall server. A gateway is often associated with both a router, which knows where to direct a given packet of data that arrives at the gateway, and a switch, which furnishes the actual path in and out of the gateway for a given packet.

**GIF (Graphics Interchange Format)** - GIF is one of the most common file formats used for images in web pages. There are two versions of the format, 87a and 89a. Version 89a supports animations, i.e. a short sequence of images within a single GIF file. A GIF89a can also be specified for interlaced presentation.

**GOV (Group Of VOPs)** - A group of VOPs is the basic unit of an MPEG-4 video stream. The GOV contains different types and numbers of VOPs (I-VOPs, P-VOPs) as determined by the GOV length and GOV structure. See also *VOP*.

**GOV length** - The GOV length determines the number of images (VOPs) in the GOV structure. See also *GOV* and *VOP*.

**GOV structure** - The GOV structure describes the composition of an MPEG-4 video stream, as regards the type of images (I-VOPs or P-VOPs) included in the stream, and their internal order. See also *GOV* and *VOP*.

**Half-duplex** - See *Full-duplex*.

**HTML (Hypertext Markup Language)** - HTML is the set of "markup" symbols or codes inserted in a file intended for display in web browser. The markup tells the browser how to display the page's words and images for the user.

**HTTP (Hypertext Transfer Protocol)** - HTTP is the set of rules for exchanging files (text, graphic images, sound, video, and other multimedia files) on the web. The HTTP protocol runs on top of the TCP/IP suite of protocols.

**Hub** - A (network) hub is used to connect multiple devices to the network. The hub transmits all data to all devices connected to it, whereas a switch will only transmit the data to the device it is specifically intended for.

**IEEE 802.11** - A family of standards for wireless LANs. The 802.11 standard supports 1 or 2 Mbit/s transmission on the 2.4 GHz band. IEEE 802.11b specifies an 11 Mbit/s data rate on the 2.4 GHz band, while 802.11a allows up to 54 Mbit/s on the 5 GHz band.

**Image compression** - Image compression minimizes the file size (in bytes) of an image. Two of the most common compressed image formats are JPEG and GIF.

**Interlacing** - Interlaced video is video captured at 50 pictures (known as fields) per second, of which every 2 consecutive fields (at half height) are then combined into 1 frame. Interlacing was developed many years ago for the analog TV world and is still used widely today. It provides good results when viewing motion in standard TV pictures, although there is always some degree of distortion in the image.

To view interlaced video on e.g. a computer monitor, the video must first be de-interlaced, to produce progressive video, which consists of complete images, one after the other, at 25 frames per second. See also *Progressive scan*.

**IP (Internet Protocol)** - The Internet Protocol is a method transmitting data over a network. Data to be sent is divided into individual and completely independent "packets". Each computer (or host) on the Internet has at least one address that uniquely identifies it from all others, and each data packet contains both the sender's address and the receiver's address.

The Internet Protocol ensures that the data packets all arrive at the intended address. As IP is a connectionless protocol, which means that there is no established connection between the communication end-points, packets can be sent via different routes and do not need to arrive at the destination in the correct order.

Once the data packets have arrived at the correct destination, another protocol - Transmission Control Protocol (TCP) - puts them in the right order. See also *TCP*.

**IP Address** - An IP address is simply an address on an IP network used by a computer/device connected to that network. IP addresses allow all the connected computers/devices to find each other and to pass data back and forth.

To avoid conflicts, each IP address on any given network must be unique. An IP address can be assigned as fixed, so that it does not change, or it can be assigned dynamically (and automatically) by DHCP.

An IP address consists of four groups (or quads) of decimal digits separated by periods, e.g. 130.5.5.25. Different parts of the address represent different things. Some part will represent the network number or address, and some other part will represent the local machine address.

See also *IP (Internet Protocol)*.

**Infrared (IR)** - Infrared radiation is radiation at a longer wavelength than visible light, which means it cannot be seen by the naked human eye. As infrared radiation can be detected as heat, this can be shown on a screen or captured by a digital camera, with hotter objects showing up brighter against colder surroundings (e.g. a human body against a colder background).

As color cameras can "see" infrared radiation as well as visible light, these cameras are equipped with an IR-cut filter, to prevent distortion of the colors the human eye can see. To use the camera in very dark locations or at night, this filter can be removed, to allow infrared radiation to hit the image sensor and thus produce images.

An infrared lamp can be used for improved illumination for night surveillance, whilst not producing any extra visible light.

**Inputs/Outputs (I/Os)** - The digital I/Os on, for example, a network camera can be used to connect any device that can toggle between an open and a closed circuit.

If, for example, a door switch is used as an input device, opening the door could trigger the upload of video images and the sending of notification messages.

An output might, for example, be used to automatically start a siren when there is a motion detection trigger.

**I-VOP** - See *VOP*.

**JPEG (Joint Photographic Experts Group)** - Together with the GIF file format, JPEG is an image file type commonly used on the web. A JPEG image is a bitmap, and usually has the file suffix '.jpg' or '.jpeg.' When creating a JPEG image, it is possible to configure the level of compression to use. As the lowest compression (i.e. the highest quality) results in the largest file, there is a trade-off between image quality and file size.

**kbit/s (kilobits per second)** - A measure of the bit rate, i.e. the rate at which bits are passing a given point. See also *Bit rate*.

**LAN (Local Area Network)** - A LAN is a group of computers and associated devices that typically share common resources within a limited geographical area.

**Linux** - Linux is an open source operating system within the Unix family. Because of its robustness and availability, Linux has won popularity in the open source community

and among commercial application developers.

**MAC address (Media Access Control address)** - A MAC address is a unique identifier associated with a piece of networking equipment, or more specifically, its interface with the network. For example, the network card in a computer has its own MAC address.

**Manual iris** - This is the opposite to an autoiris, i.e. the camera iris must be adjusted manually to regulate the amount of light allowed to reach the image sensor.

**Mbit/s (Megabits per second)** - A measure of the bit rate, i.e. the rate at which bits are passing a given point. Commonly used to give the "speed" of a network. A LAN might run at 10 or 100 Mbit/s. See also *Bit rate*.

**Monitor** - A monitor is very similar to a standard television set, but lacks the electronics to pick up regular television signals.

**Motion JPEG** - Motion JPEG is a simple compression/decompression technique for networked video. Latency is low and image quality is guaranteed, regardless of movement or complexity of the image. Image quality is controlled by adjusting the compression level, which in turn provides control over the file size, and thereby the bit rate.

High-quality individual images from the Motion JPEG stream are easily extracted. See also JPEG.

**Megapixel** - See *Pixel*.

**MPEG (Moving Picture Experts Group)** - The Moving Picture Experts Group develops standards for digital video and audio compression. It operates under the auspices of the International Organization for Standardization (ISO). The MPEG standards are an evolving series, each designed for a different purpose.

**MPEG-2** - MPEG-2 is the designation for a group of audio and video coding standards, and is typically used to encode audio and video for broadcast signals, including digital satellite and Cable TV. MPEG-2, with some modifications, is also the coding format used by standard commercial DVD movies.

**MPEG-4** - MPEG-4 is a group of audio and video coding standards and related technology. The primary uses for the MPEG-4 standard are web (streaming media) and CD distribution, conversational (videophone), and broadcast television.

Most of the features included in MPEG-4 are left to individual developers to decide whether to implement them or not. This means that there are probably no complete implementations of the entire MPEG-4 set of standards. To deal with this, the standard includes the concept of "profiles" and "levels", allowing a specific set of capabilities to be defined in a manner appropriate for a subset of applications.

**Multicast** - Bandwidth-conserving technology that reduces bandwidth usage by simultaneously delivering a single

stream of information to multiple network recipients.

**Multiplexer** - A multiplexer is a high-speed switch that provides full-screen images from up to 16 analog cameras. Multiplexers can playback everything that happened on any one camera with no interference from the other cameras on the system.

**Network connectivity** - The physical (wired or wireless) and logical (protocol) connection of a computer network or an individual device to a network, such as the Internet or a LAN.

**NWay** - NWay is a telecommunications protocol used with Ethernet networking devices (such as router and switch) to automatically negotiate the highest possible common transmission speed between two devices.

**NTSC (National Television System Committee)** - NTSC is the television and video standard in the United States. NTSC delivers 525 lines at 60 half-frames/second.

**OEM (Original Equipment Manufacturer)** - This is a designation for companies that manufacture equipment which is then marketed and sold to other companies under their own names.

**PAL (Phase Alternating Line)** - PAL is the dominant television standard in Europe. PAL delivers 625 lines at 50 half-frames/second.

**PEM (Privacy Enhanced Mail)** - An early standard for securing electronic mail. The PEM-format is often used for representing an HTTPS certificate or certificate request.

**Ping** - Ping is a basic network program used diagnostically to check the status of a network host or device. Ping can be used to see if a particular network address (IP address or host name) is occupied or not, or if the host at that address is responding normally. Ping can be run from e.g. the Windows Command prompt or the command line in Unix.

**Pixel (Picture element)** - A pixel is one of the many tiny dots that make up a digital image. The color and intensity of each pixel represents a tiny area of the complete image.

**PoE (Power over Ethernet)** - Power over Ethernet provides power to a network device via the same cable as used for the network connection. This is very useful for IP-Surveillance and remote monitoring applications in places where it may be too impractical or expensive to power the device from a power outlet.

**PPP (Point-to-Point Protocol)** - A protocol that uses a serial interface for communication between two network devices. For example, a PC connected by a phone line to a server.

**PPTP (Point-to-Point Tunnelling Protocol)** - A protocol (set of communication rules) that allows corporations to extend their own corporate network through private "tunnels" over the public Internet. In this way a corporation can effectively use a WAN (Wide Area Network) as a large single LAN (Local Area Network). This kind of



interconnection is known as a virtual private network (VPN).

**Pre/post alarm images** - The images from immediately before and after an alarm. These images are stored in a buffer for later retrieval.

**Progressive scan** - Progressive scan, as opposed to interlaced video, scans the entire picture, line by line every sixteenth of a second. In other words, captured images are not split into separate fields as in interlaced scanning.

Computer monitors do not need interlace to show the picture on the screen, but instead show them progressively, on one line at a time in perfect order, i.e. 1, 2, 3, 4, 5, 6, 7 and so on; so there is virtually no "flickering" effect. In a surveillance application, this can be critical when viewing detail within a moving image, such as a person running. A high-quality monitor is required to get the best from progressive scan. See also *Interlacing*.

**Protocol** - A special set of rules governing how two entities will communicate. Protocols are found at many levels of communication, and there are hardware protocols and software protocols.

**Proxy server** - In an organization that uses the Internet, a proxy server acts as an intermediary between a workstation user and the Internet. This provides security, administrative control, and a caching service. Any proxy server associated with a gateway server, or part of a gateway server, effectively separates the organization's network from the outside network and the local firewall. It is the firewall server that protects the network against outside intrusion.

A proxy server receives requests for Internet services (such as web page requests) from many users. If the proxy server is also a cache server, it looks in its local cache of previously downloaded web pages. If it finds the page, it is returned to the user without forwarding the request to the Internet. If the page is not in the cache, the proxy server, acting as a client on behalf of the user, uses one of its own IP addresses to request the page from another server over the Internet. When the requested page is returned, the proxy server forwards it to the user that originally requested it.

**P-VOP** - See *VOP*.

**Resolution** - Image resolution is a measure of how much detail a digital image can hold: the greater the resolution, the greater the level of detail. Resolution can be specified as the number of pixel-columns (width) by the number of pixel-rows (height), e.g. 320x240.

Alternatively, the total number of pixels (usually in megapixels) in the image can be used. In analog systems it is also common to use other format designations, such as CIF, QCIF, and 4CIF.

**RTCP (Real-Time Control Protocol)** - RTCP provides support for real-time conferencing of groups of any size within an intranet. This support includes source identification and support for gateways like audio and video

bridges as well as multicast-to-unicast translators.

RTCP offers quality-of-service feedback from receivers to the multicast group as well as support for the synchronization of different media streams.

**RTP (Real-Time Transport Protocol)** - RTP is an Internet protocol for the transport of real-time data, e.g. audio and video. It can be used for media-on-demand as well as interactive services such as Internet telephony.

**RTSP (Real Time Streaming Protocol)** - RTSP is a control protocol, and a starting point for negotiating transports such as RTP, multicast and Unicast, and for negotiating codecs.

RTSP can be considered a "remote control" for controlling the media stream delivered by a media server. RTSP servers typically use RTP as the protocol for the actual transport of audio/video data.

**Router** - A device that determines the next network point to which a packet should be forwarded on its way to its final destination. A router creates and/or maintains a special routing table that stores information on how best to reach certain destinations. A router is sometimes included as part of a network switch. See also *switch*.

**Server** - In general, a server is a computer program that provides services to other computer programs in the same or other computers. A computer running a server program is also frequently referred to as a server. In practice, the server may contain any number of server and client programs. A web server is the computer program that supplies the requested HTML pages or files to the client (browser).

**Sharpness** - This is the control of fine detail within a picture. This feature was originally introduced into color TV sets that used notch filter decoders. This filter took away all high frequency detail in the black and white region of the picture. The sharpness control attempted to put some of that detail back in the picture. Sharpness controls are mostly superfluous in today's high-end TVs. The only logical requirement for it nowadays is on a VHS machine.

**Simplex** - In simplex operation, a network cable or communications channel can only send information in one direction.

**SMTP (Simple Mail Transfer Protocol)** - SMTP is used for sending and receiving e-mail. However, as it is "simple," it is limited in its ability to queue messages at the receiving end, and is usually used with one of two other protocols, POP3 or IMAP. These other protocols allow the user to save messages in a server mailbox and download them periodically from the server.

SMTP authentication is an extension of SMTP, whereby the client is required to log into the mail server before or during the sending of email. It can be used to allow legitimate users to send email while denying the service to unauthorized users, such as spammers.

**SNMP (Simple Network Management Protocol)** - SNMP



forms part of the Internet Protocol suite, as defined by the Internet Engineering Task Force. The protocol can support monitoring of network-attached devices for any conditions that warrant administrative attention.

**Sockets** - Sockets are a method for communication between a client program and a server program over a network. A socket is defined as "the endpoint in a connection." Sockets are created and used with a set of programming requests or "function calls" sometimes called the sockets application programming interface (API).

**SSL/TSL (Secure Socket Layer/Transport Layer Security)**

These two protocols (SSL is succeeded by TSL) are cryptographic protocols that provide secure communication on a network. SSL is commonly used over HTTP to form HTTPS, as used e.g. on the Internet for electronic financial transactions. SSL uses public key certificates to verify the identity of the server.

**Subnet & subnet mask** - A subnet is an identifiably separate part of an organization's network. Typically, a subnet may represent all the machines at one geographic location, in one building, or on the same local area network (LAN). Having an organization's network divided into subnets allows it to be connected to the Internet with a single shared network address.

The subnet mask is the part of the IP address that tells a network router how to find the subnet that the data packet should be delivered to. Using a subnet mask saves the router having to handle the entire 32-bit IP address; it simply looks at the bits selected by the mask.

**Switch** - A switch is a network device that connects network segments together, and which selects a path for sending a unit of data to its next destination. In general, a switch is a simpler and faster mechanism than a router, which requires knowledge about the network and how to determine the route. Some switches include the router function. See also *Router*.

**TCP (Transmission Control Protocol)** - TCP is used along with the Internet Protocol (IP) to transmit data as packets between computers over the network. While IP takes care of the actual packet delivery, TCP keeps track of the individual packets that the communication (e.g. requested a web page file) is divided into, and, when all packets have arrived at their destination, it reassembles them to re-form the complete file.

TCP is a connection-oriented protocol, which means that a connection is established between the two end-points and is maintained until the data has been successfully exchanged between the communicating applications.

**Telnet** - Telnet is a simple method with which to access another network device, e.g. a computer. The HTTP protocol and the FTP protocols allow you to request specific files from remote computers, but do not allow you logon as a user of that computer. With Telnet, you log on as a regular

user with whatever privileges you may have been granted for specific applications and data residing on that computer.

**TVL (TV Lines)** - A method of defining resolutions in analog video.

**UDP (User Datagram Protocol)** - UDP is a communications protocol that offers limited service for exchanging data in a network that uses the Internet Protocol (IP). UDP is an alternative to the Transmission Control Protocol (TCP). The advantage of UDP is that it is not required to deliver all data and may drop network packets when there is e.g. network congestion. This is suitable for live video, as there is no point in re-transmitting old information that will not be displayed anyway.

**Unicast** - Communication between a single sender and a single receiver over a network. A new connection is established for each new user.

**UPnP™** - A set of computer network protocols that allows the automatic peer-to-peer detection of devices on the network. UPnP is promoted by the UPnP Forum.

**URL (Uniform Resource Locator)** - An "address" on the network.

**USB - (Universal Serial Bus)** A plug-and-play interface between a computer and peripheral devices, e.g. scanners, printers.

**Varifocal lens** - A varifocal lens provides a wide range of focal lengths, as opposed to a lens with a fixed focal length, which only provides one.

**VPN (Virtual Private Network)** - This creates a secure "tunnel" between the points within the VPN. Only devices with the correct "key" will be able to work within the VPN. The VPN network can be within a company LAN (Local Area Network), but different sites can also be connected over the Internet in a secure way. One common use for VPN is for connecting a remote computer to the corporate network, via e.g. a direct phone line or via the Internet.

**VOP (Video Object Plane)** - A VOP is an image frame in an MPEG-4 video stream. There are several types of VOP:

- An I-VOP is complete image frame.

- A P-VOP codes the differences between images, as long as it is more efficient to do so. Otherwise it codes the whole image, which may also be a completely new image.

**WAN (Wide-Area-Network)** - Similar to a LAN, but on a larger geographical scale.

**W-LAN (Wireless LAN)** - A wireless LAN is a wireless local area network that uses radio waves as its carrier: where the network connections for end-users are wireless. The main network structure usually uses cables.

**Web server** - A Web server is a program, which allows Web browsers to retrieve files from computers connected to the Internet. The Web server listens for requests from Web browsers and upon receiving a request for a file sends it

back to the browser.

The primary function of a Web server is to serve pages to other remote computers; consequently, it needs to be installed on a computer that is permanently connected to the Internet. It also controls access to the server whilst monitoring and logging server access statistics.

**WEP (Wireless Equivalent Privacy)** - A wireless security protocol, specified in the IEEE 802.11 standard, which is designed to provide a wireless local area network (WLAN) with a level of security and privacy comparable to that usually expected of a wired LAN. Security is at two different levels; 40-bit and 128-bit encryption. The higher the bit number, the more secure the encryption.

**WINS (Windows Internet Naming Service)** - Part of the Microsoft Windows NT Server, WINS manages the association of workstation names and locations with IP addresses, without the user or administrator having to be involved in each configuration change.

**WPA-PSK (Wi-Fi Protected Access - Pre-Shared Key)** - This wireless encryption method uses a pre-shared key (PSK) for key management. Keys can usually be entered as manual hex values, as hexadecimal characters, or as a Passphrase. WPA-PSK provides a greater degree of security than WEP.

**Zoom lens** - A zoom lens can be moved (zoomed) to enlarge the view of an object to show more detail.

# Index

---

## A

Accessing the video stream 13  
 Action buttons 8, 22  
 Active/Inactive 8, 23  
 ActiveX controls 7  
 Administrator 14  
 Advanced TCP/IP settings 40  
 Alarm 33, 48  
 AMC 9, 13

## B

Backlight compensation 18  
 Backup 45  
 Bandwidth 12, 58  
 Buffer Size 31  
 Buffers 31

## C

CGI links 23, 26  
 Click-in-image 26  
 Connection Module 48  
 Constant bit rate 12  
 Control Button 6, 47  
 Customize 21

## D

Date & Time 37  
 Default viewer 24  
 DNS configuration 40

## E

Emergency recovery 51  
 Event 29  
 Event Servers 29  
 Event Types 30

## F

Factory Default 47  
 Frame rates 16, 57  
 FTP Server 29

## G

Guard Tour 27

## H

Host name 40  
 HTML examples 24  
 HTTP API 23, 26  
 HTTP port number 40  
 HTTPS 36, 41

## I

Include windows 33  
 IP address filtering 35  
 IR cut filter 17  
 IR light 9

## L

Live View 14

## M

Maximum bandwidth 42  
 Motion JPEG 11  
 MPEG-4 11  
 MPEG-4 clients 13  
 MPEG-4 protocols 12

## N

NAT Traversal 41  
 Network 39  
 Network Connector 6  
 New Server Time 37  
 Night vision 17

## O

Output buttons 8, 23  
 Overlay image 17  
 Overlay settings 16  
 Own home page 21  
 Own web files 21

## P

Pan/Tilt/Zoom 25  
 Pan/Tilt/Zoom Control Queue 10

Pan/Tilt/Zoom Controls 10  
Pinout 44  
Pinout - I/O connectors 48  
Port Status 34  
Ports & Devices 44  
Post-trigger Buffer 31  
Preset positions 26  
Pre-trigger Buffer 31  
PTZ commands 23, 26  
PTZ control queue 26  
PTZ controls 25  
Pulse 8, 23

**Q**  
QuickTime 22

**R**  
Recovery 51  
Referrals 36  
Restart 45  
Restore 45  
RTP 44  
RTSP 42

**S**  
Scheduled Event 32  
Security 35  
Sequence mode 8  
Serial Number 6  
Services 39  
Setup Tools 14  
SMTP 43  
Snapshot 9  
SNMP 44  
SOCKS 42  
Specifications 54  
Support 45  
System options 35

**T**  
TCP Server 29  
Time mode 38  
Triggered Event 30

Troubleshooting 50

**U**  
Upgrade Server 45  
UPnP 44  
User defined links 23

**V**  
Variable bit rate 12  
Video format 8  
Video stream 16

**W**  
White balance 17  
Wide dynamic range 18

## Free Manuals Download Website

<http://myh66.com>

<http://usermanuals.us>

<http://www.somanuals.com>

<http://www.4manuals.cc>

<http://www.manual-lib.com>

<http://www.404manual.com>

<http://www.luxmanual.com>

<http://aubethermostatmanual.com>

Golf course search by state

<http://golfingnear.com>

Email search by domain

<http://emailbydomain.com>

Auto manuals search

<http://auto.somanuals.com>

TV manuals search

<http://tv.somanuals.com>