

# AVerMedia LX5000

## Digital Video Recorder & Remote Surveillance System

### User's Manual

300AAABX / V3.0 / 0612

#### FCC NOTICE

This device has been tested and found to comply with the limits for a Class a digital device, pursuant to Part 15 of the FCC Rules. These limits are designed to provide reasonable protection against harmful interference in a commercial, industrial or business environment. This equipment can generate, use and radiate radio frequency energy and, if not installed and used in accordance with the instruction, may cause harmful interference to radio communications. However, there is no guarantee that interference will not occur in a particular installation. If this equipment does cause harmful interference to radio or television reception, which can be determined by turning the equipment off and on, the user is encouraged to try to correct the interference by one or more of the following measures:

- Reorient or relocate the receiving antenna.
- Increase the separation between the equipment and receiver.
- Connect the equipment into an outlet on a circuit different from that to which the receiver is connected.
- Consult the dealer or an experienced radio/TV technician for help.

This device complies with Part 15 of the FCC Rules. Operation is subject to the following two conditions: (1) this device may not cause harmful interference, and (2) this device must accept any interference received, including interference that may cause undesired operation.

#### CAUTION ON MODIFICATIONS

To comply with the limits for the Class A digital device, pursuant to Part 15 of the FCC Rules, this device must be installed in computer equipment certified to comply with the Class A limits. All cables used to connect the computer and peripherals must be shielded and grounded. Operation with non-certified computers or non-shielded cables may result in interference to radio or television reception.

Any changes or modifications not expressly approved by the grantee of this device could void the user's authority to operate the equipment.

#### CE NOTICE

This is a Class A product.

**ENG 01**

**DISCLAIMER**

No warranty or representation, either expressed or implied, is made with respect to the contents of this documentation, its quality, performance, merchantability, or fitness for a particular purpose. Information presented in this documentation has been carefully checked for reliability; however, no responsibility is assumed for inaccuracies. The information contained in this documentation is subject to change without notice.

In no event will AVerMedia be liable for direct, indirect, special, incidental, or consequential damages arising out of the use or inability to use this product or documentation, even if advised of the possibility of such damages.

**TRADEMARKS**

**AVerMedia** is a trademark of **AVerMedia® TECHNOLOGY, Inc.** IBM PC is a registered trademark of International Business Machines Corporation. Microsoft is a registered trademark and Windows is a trademark of Microsoft Corporation. All other products or corporate names mentioned in this documentation are for identification and explanation purposes only, and may be trademarks or registered trademarks of their respective owners.

**COPYRIGHT**

© 2002-2003 by **AVerMedia® TECHNOLOGY, Inc.** All rights reserved. No part of this publication may be reproduced, transmitted, transcribed, stored in a retrieval system, or translated into any language in any form by any means without the written permission of **AVerMedia® TECHNOLOGY, Inc.**

**TABLE OF CONTENTS**

**CHAPTER 1 INTRODUCTION.....6**

1.1 AVERMEDIA LX5000 HIGHLIGHTS ..... 6

1.2 PACKAGE CONTENTS..... 7

1.3 MANUAL CONVENTIONS ..... 7

**CHAPTER 2 HARDWARE INSTALLATION .....8**

2.1 HARDWARE RECOMMENDATIONS..... 8

2.2 INSTALLING THE AVERMEDIA LX5000 VIDEO CARDS ..... 11

2.3 ATTACHING CAMERAS..... 12

2.4 CONNECTING EXTERNAL INPUTS/OUTPUTS CONTROL DEVICES ..... 13

**CHAPTER 3 SOFTWARE INSTALLATION ..... 17**

3.1 INSTALLING FROM THE SOFTWARE CD ..... 17

**CHAPTER 4 SYSTEM CONFIGURATION AND OPERATION..... 19**

4.1 ENTERING THE SYSTEM ..... 19

4.2 SYSTEM CONFIGURATION ..... 21

4.3.1  Start / Stop Recording..... 57

4.3.2  Playback ..... 58

4.3.3  Show / Hide E-MAP ..... 70

**CHAPTER 5 USING THE WEBCAM ..... 78**

5.1 ENABLE WEBCAM ..... 78



5.2 USE THE WEBCAM..... 80

**CHAPTER 6 REMOTEMANAGER.....83**

6.1 ACCESSING REMOTEMANAGER ..... 83

6.2  SETUP..... 86

6.3 OPERATING REMOTEMANAGER ..... 93

6.4	 START RECORDING .....	100
6.5	 EXIT REMOTE MANAGER .....	100
<b>CHAPTER 7 AVERMEDIA FAQs .....</b>		<b>102</b>
<b>APPENDIX A REGISTERING DOMAIN NAME ON DDNS SERVER...</b>		<b>104</b>
<b>APPENDIX B IMAGE VERIFICATION .....</b>		<b>106</b>
<b>APPENDIX C REMOTE LOGIN WITH AN MODEM-TO-MODEM CONNECTION .....</b>		<b>112</b>
A. WINDOWS 98SE / WINDOWS ME.....		112
B. WINDOWS 2000.....		113
C. WINDOWS XP.....		116
<b>LIMITED WARRANTY .....</b>		<b>119</b>

## Chapter 1 Introduction

### 1.1 AVerMedia LX5000 Highlights

The AVerMedia LX5000 is the first remote digital surveillance system that operates under the Linux environment. It integrates the latest in image processing, digital management, and communication technology. The AVerMedia LX5000 also employs an auto-integrated interface with remote control software and uses Intelligent Digital Recording to produce ultra-high quality images. Advanced motion detection technology enables the system to use sensing devices to detect motion, which triggers video recording and external alarm devices.

The AVerMedia LX5000 is adaptable and flexible allowing the administrator to customize the system based on various trigger events. These events trigger a variety of action responses necessary to record information and notify the responsible personnel. The AVerMedia LX5000 employs a user-friendly operating interface and requires minimal maintenance. Intelligent programming reduces the need for manual operation and therefore minimizes the human error factor.

The AVerMedia LX5000 system has been especially designed to allow for future enhancements in addition to maintaining interfaces necessary to integrate with legacy surveillance equipment. Taking advantage of today's sophisticated communication technology, the AVerMedia LX5000 puts you in control of all of your surveillance activities from anywhere in the world.

## 1.2 Package Contents

### AVerMedia LX5000

- LX5000: 1/2 x AVerMedia Video Capture Card
- 1 x LAN Card (REALTEK RTL8139)
- 1 x CD (includes LX5000 software, Linux Operating System, RemoteManager S/W, and User's Manual)
- Optional: I/O Box, and I/O Cable

## 1.3 Manual Conventions

The following conventions are used throughout this manual.

Type	Stands for	Example
[paren.]	Keys on the keyboard	[Enter]
"Quotes"	Words to be typed in	"AVerMedia"
Italic	User in each authorization level	<i>Administrator</i>
Bold	Name of a dialog box, Sections/Option title in the dialog box/Field names/Buttons	<b>Operation</b>
Underlined	Table columns	<u>Time</u>



**Caution Message:** These messages are to advise you to proceed carefully. Failure to pay attention could result in damage to the system and may put personnel and environment at risk.



**Informational Message:** These messages are intended to provide additional information for the purpose of clarification.

## Chapter 2 Hardware Installation

### 2.1 Hardware Recommendations

CPU	Intel Celeron 800 (Pentium III 800 MHz or above is recommended) <b>(AMD K6, K7 temporarily not supported)</b>
Operating System	Linux RedHat, included with the AVerMedia LX5000 CD
VGA Card	Capable of 1024 x 768 resolution or greater <ol style="list-style-type: none"> <li>1. nVidia GeForce 2 / 3 MX series</li> <li>2. nVidia GeForce 4 Ti4200 / 4600 / 4800 series</li> <li>3. Ati Radeon 8500 / 9000 / 9700 Pro</li> </ol>
Motherboard	Intel Chipset with 6 PCI slots recommended List of motherboards tested: <ul style="list-style-type: none"> <li>• ASUS P4B533</li> <li>• ASUS P4B533E</li> <li>• MSI 854E MAX2</li> <li>• ABIT-SA6R (PIII/Celeron)</li> </ul>
Hard Disk Space	80GB or higher
System RAM	128 MB (more recommended)
Video Frame Size	320 x 240, 640 x 480
Video	NTSC or PAL
Video Input	Standard analog video signal

Modem	<p>List of modems supported:</p> <ul style="list-style-type: none"> <li>• Lucent Venus Serial Voice Modem</li> <li>• Rockwell (Connexant) chipset Voice Modem</li> <li>• Topic chipset Voice Modem</li> <li>• Zyxel Omni56K Voice Modem</li> </ul> <p><b>(if a modem is to be used with in the AVerMedia LX5000 server, it needs to be an external modem)</b></p>
SCSI Card	AHA
Monitor	1024 x 768 (or higher) with horizontal frequency of 60 Hz
Mouse	3-button mouse
PTZ Camera	<p>List of PTZ cameras tested:</p> <ul style="list-style-type: none"> <li>• Lilin PIH-717/7000/7600</li> <li>• Dynacolor D7700</li> <li>• Kampro KC-7720</li> <li>• Pelco SD5TAC Series</li> </ul>



**i** Most PTZ cameras use RS-485 as the communications protocol but most motherboards use RS-232 serial ports. If this is the case, you need to purchase an RS-232 to RS-485 converter.

**i** If you purchase the AVerMedia LX5000 kit, and you run out of external COM ports for the speed dome camera, you can use a 10-pin to DB-9 ribbon cable (included with package) with the internal COM header on the motherboard. First, plug the 10-pin connector into the internal COM header. Then screw the DB-9 connector into the I/O bracket (also included in the packaging). Finally use the screws to attach the I/O bracket to your chassis. You can now connect your speed dome cameras. See the following figure.

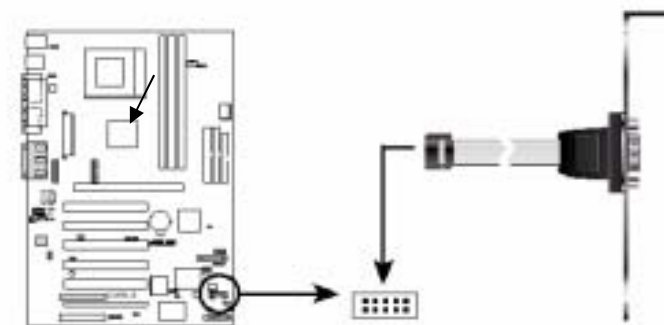

**i** If you want to add an additional hard disk, please first partition it manually following the rule of LINUX system operation. On the other hand, note that only the CD-R with IDE interface can be connected to IDE 1 slave.

## 2.2 Installing the AVerMedia LX5000 Video Cards

The following instructions are for installing video cards into the AVerMedia LX5000.



Before installing the video card, turn off the computer's power, unplug the power cable and disconnect all other cables attached to the back of the computer.

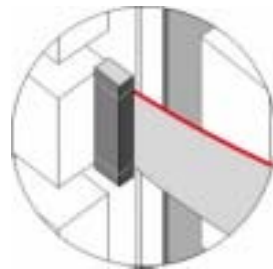
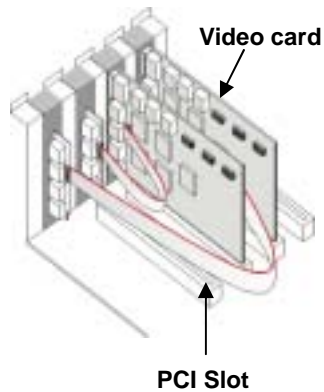

**NOTE:** Orient the red mark upward.

Remove the computer cover.

Remove the I/O brackets for the four PCI expansion slots. Save the screws.

Insert the AVerMedia video cards into the available PCI expansion slots.

Replace the computer cover and reconnect all cables.

## Connecting the AVerMedia LX5000 Video Cards

Up to four cameras can be connected to each LX5000 video card - one camera per BNC terminal.

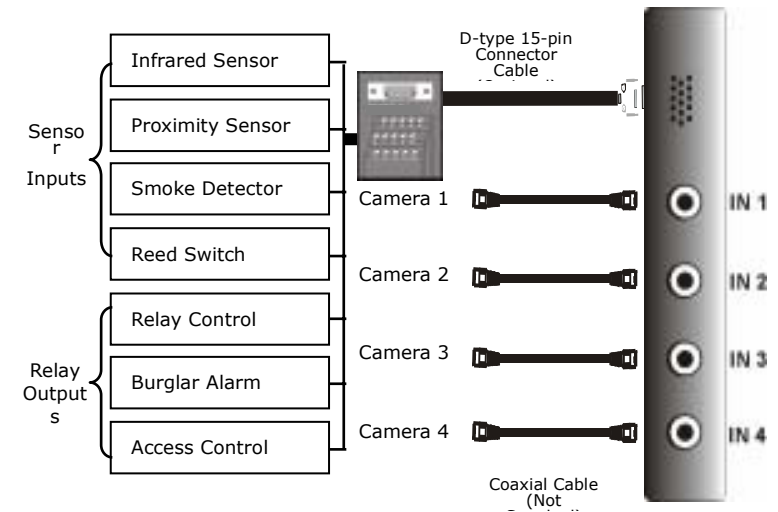

## 2.3 Attaching Cameras

Cameras must be attached to the BNC connectors of the server video cards in a specific order to avoid transmission problems. Depending on whether you have the LX5000 will determine how to

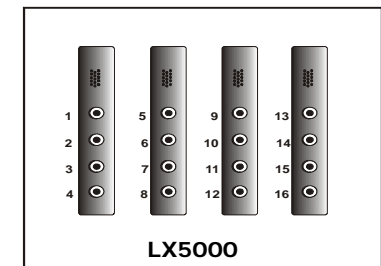

install your cameras. Video cards are stacked vertically into the chassis. If all four video cards are installed, the rear panel of the server will appear as shown in the diagrams below.

Cameras need to be installed according to the numerical order displayed on the diagrams above for each model. **With the LX5000, cameras will be installed from top to bottom beginning with the left-most column.**

### 2.4 Connecting External Inputs/Outputs Control Devices

Each system and kit comes with four External I/O Boxes and D-type 15-pin connector cables enabling you to connect sensor inputs and relay outputs. The pin signals and specifications for the external I/O Box and the D-type 15-pin connectors are described below.



Video Card



D-type 15-pin Connector Cable



External I/O Box

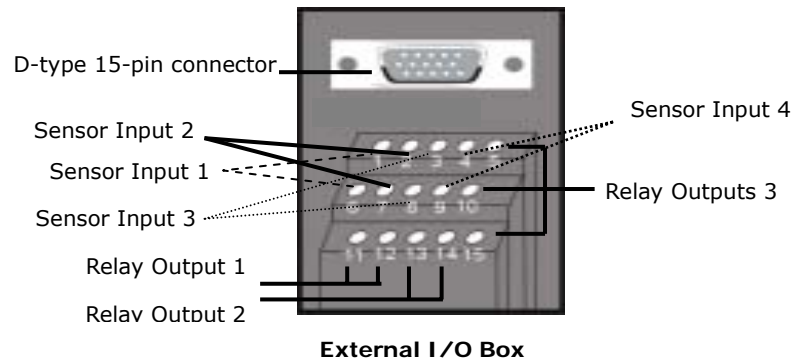

### Sensor Input Specification

#### Absolute Maximum Ratings (Ta=25°C)

Parameter		Symbol	Rating	Unit
Input	Forward Current	I <sub>F</sub>	50	mA
	Reverse Voltage	V <sub>R</sub>	5	V
	Power Dissipation	P	70	mW

#### Electrical/Optical Characteristics (Ta=25°C)

Parameter	Symbol	Min.	Typ.	Max.	Unit	Conditions	
Input	Forward Voltage	V <sub>F</sub>	—	1.2	1.4	V	I <sub>F</sub> =25mA
	Reverse Current	I <sub>R</sub>	—	—	10	μA	V <sub>R</sub> =5V
	Terminal Capacitance	C <sub>T</sub>	—	30	250	pF	V <sub>F</sub> =0, f=1kHz
Output	Collector-Emmitter Current	I <sub>CE</sub>	—	—	100	mA	V <sub>CE</sub> =20V
	Collector-Emmitter Breakdown Voltage	BV <sub>CEO</sub>	35	—	—	V	I <sub>C</sub> =0 mA
	Emmitter-Collector Breakdown Voltage	BV <sub>EC</sub>	5	—	—	V	I <sub>E</sub> =15 mA
Transfer Characteristics	*Current Transfer Ratio	CTR	30	—	600	%	I <sub>C</sub> =5mA, V <sub>CE</sub> =5V, R <sub>TH</sub> =
	Collector Current	I <sub>C</sub>	2.5	—	30	mA	
	Collector-emitter Saturation Voltage	V <sub>CE(sat)</sub>	—	0.1	0.2	V	I <sub>C</sub> =25mA, I <sub>E</sub> =1mA
	Isolation Resistance	R <sub>iso</sub>	5 x 10 <sup>7</sup>	10 <sup>7</sup>	—	Ω	DC/30V, 40-60% R.H.
	Floating Capacitance	C <sub>F</sub>	—	0.8	1.0	pF	V <sub>F</sub> =0, f=1MHz
	Cut-off Frequency	f <sub>c</sub>	—	60	—	kHz	V <sub>F</sub> =5V, I <sub>C</sub> =2mA, R <sub>L</sub> =100 Ω, 3dB
	Response Time (Fall)	t <sub>F</sub>	—	4	18	μs	V <sub>F</sub> =2V, I <sub>C</sub> =2mA, R <sub>L</sub> =100 Ω
Response Time (Rise)	t <sub>R</sub>	—	3	18	μs	R <sub>L</sub> =100 Ω	

\*CTR= 100%

### Relay Output Specification

Surge strength: 1500 VAC

Nominal power: 200mw ~ 360mw

Operating power: 110mw ~ 200mw

### COIL RATINGS (at 20°C)

Coil Nominal Voltage (VDC)	Coil Resistance (±10%)	Pick-up Voltage (VDC)	Drop-Out Voltage (VDC)	Nominal Current (mA)
5	125	3.75	0.5	40
* Max Continuous Voltage at 20°C : 110% of Coil Nominal Voltage				

**CONTACT RATINGS**

Contact Arrangement	1 Form C (SPDT)
max. Switch Power	125VA 60W
max. Switch voltage	125VAC 30VDC
max. Switch current	2A
Contact Resistance	≤100m Ω
Resistive Load	1A/125VAC 2A/30VDC
Contact Material	AgNi10

**External I/O Box pin signals**

Pin #	Definition
1	INPUT SIGNAL 1+
2	INPUT SIGNAL 2+
3	INPUT SIGNAL 3+
4	INPUT SIGNAL 4+
5	OUTPUT 3 - Normally Closed
6	INPUT SIGNAL 1-(GND)
7	INPUT SIGNAL 2-(GND)
8	INPUT SIGNAL 3-(GND)
9	INPUT SIGNAL 4-(GND)
10	OUTPUT 3 - Common
11	OUTPUT 1 - Normally Open

12	OUTPUT 1 - Common
13	OUTPUT 2 - Normally Open
14	OUTPUT 2 - Common
15	OUTPUT 3 - Normally Open

**Sensor Inputs**

External sensors such as infrared sensors, smoke detectors, proximity sensors, door sensors, etc., can be attached to the AVerMedia LX5000's input-signal connectors on the External I/O Box. These devices trigger the system to respond with a predefined action (e.g. record video)

**Relay Outputs**

The AVerMedia LX5000's output connectors (relay output) can be attached to external output control devices such as alarms. The system can be configured to activate or deactivate these devices. Each AVerMedia video card supports three relay outputs. Two of them are normally open relays with one being a toggle switch.



## Chapter 3 Software Installation

### 3.1 Installing From the Software CD

This section describes the instructions for installing the OS and system software from the AVerMedia LX5000 system CD.



Before you starting to install the system, please confirm that the time in the system is met to the current time.

1. Go into the BIOS Setup and configure the **First Boot Device** to be the CD-ROM in order to boot from the AVerMedia LX5000 system CD. Note that when you use this CD to boot the system, the CD-ROM drive can either be the master or slave of any IDE channel.
2. After boot-up, you will need to choose one of the options from the menu below.

```

***** Option Menu *****
(1) Make Hard Disk and Install. .
(0) Exit & Shutdown.
      Which you want:
    
```

- (1) Make Hard Disk and Install:** This option installs the Linux OS and AVerMedia LX5000 software onto the hard disk. Before running this option, make sure that you have installed the hard disk as IDE 0 master.

The system will display a warning message to remind you to install the hard disk as IDE 0 master:

- (0) Exit & Shutdown:** This option exits the setup mode and then proceeds to shutdown.
3. Reboot the computer to run the system.

## Chapter 4 System Configuration and Operation

### 4.1 Entering the System

Before you start running LX5000 system, the system will perform a routine hardware check-up and scan all hard disks. In general, the hard disk scan takes only a few seconds. But if the hard disk was abnormally shutdown or had been damaged, the system will do a complete scan. The scan time is dependent on the hard disk size. (with a complete scan, it takes about 1 minute to scan 30GB).

 If you re-installed your LX5000 system and forgot your previous password, you can choose to remove the previous password setting when the first time you enter the system after the re-installation.

Remove password setting (y/n)?

After the hardware check-up is finished, a dialogue box will display prompting you to set some basic configurations. **You only have 15 seconds to finish all the selections on this screen.**

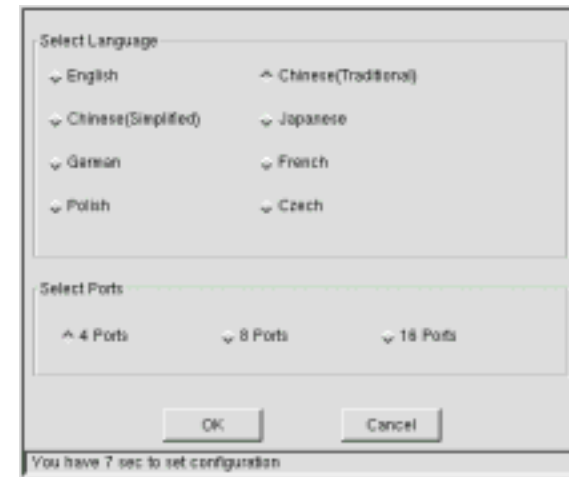

For **Select Language**, you can select from English, Traditional Chinese, Simplified Chinese, Japanese, German, French, Polish, and Czech.

After your selection, a pop-up window besides will allow you to utilize the system application.

Enter user serial number in Serial Number field to further use AVerMedia LX5000



## 4.2 System Configuration

### Main Screen

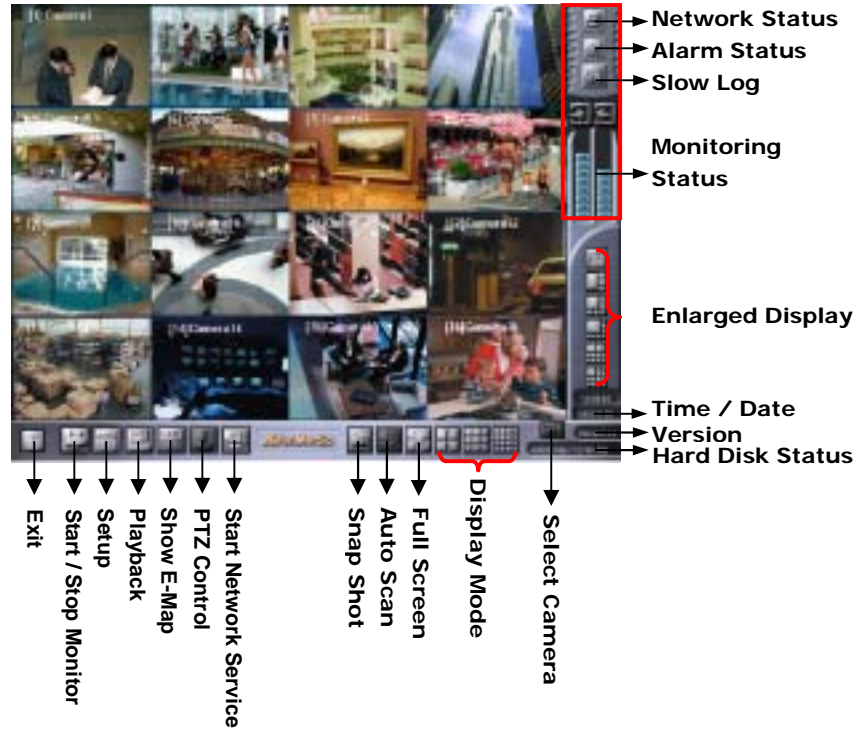

#### Network Status

Click this button to show the current network status where you can see every client connecting to the server. Click 'clear all' to delete the record; click 'save to disk' to save the record.



#### Alarm Report

The image will turn into red and be flashing once an alarm is triggered. An alarm message with the detailed alarm status will be seen after you click on it. It will help you control the situation of surveillance. Click 'clear all' to delete the record; click 'save to disk' to save the record.



#### Show Log

To display record, click this button so that you can replay the record and save for further process.



#### Monitoring Status



#### Sensor / Relay Status

The panel provides the real time monitoring control on the sensor and relay surveillance system. The numbers of the grids on the status bar present as follow as the rule of 4 sensor inputs and 3 relay outputs supported by each video card. Once a relay is triggered, one of



the grids will turn yellow on which the further information will be shown. With the information go to **System setup Alarm setup Relay alarm** to find out the generated sensor.



**Time/Date**

This field contains the current time (hour:minute:second) and date (year/month/date). You can double-click here to reset the time and date in the displayed dialog box besides.



**Software Version**

It displays the software version of the AVerMedia LX5000 system



**Hard Disk Status**

This information shows the total disk capacity and available disk space of all the hard disks in the system.



**Enlarging Display**

Click "1-Camera Display" this button to view image from a single camera and switch any camera into a specific camera. Double clicking on any of the images will enlarge that image and move it into a corner.

Since that one image was enlarged the total number of remaining images will be reduced. In the example below, the 16-image display (figure 1) is reduced to a 13-image display after one of the images was enlarged. You can repeat this process until you are left with 7 images (3 large and 4 small – figure 8). If you further click on any image, the screen will remain as 7-camera display placing the last double-clicked image in the upper left corner. You can also do this with the 9-Camera Display mode, but the initial double-click will turn the 9-screen display into a 16-screen display.

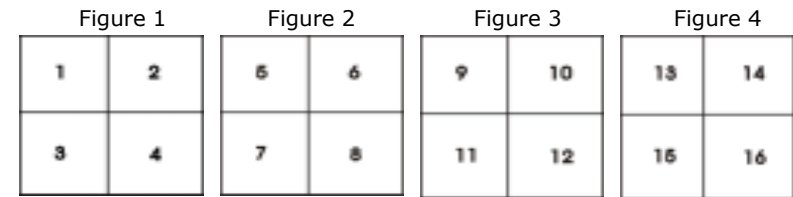

**Display mode**

The following grid shows how camera images are positioned on the monitor when in the different split screen modes. The numbers in the squares correspond to the camera numbers.

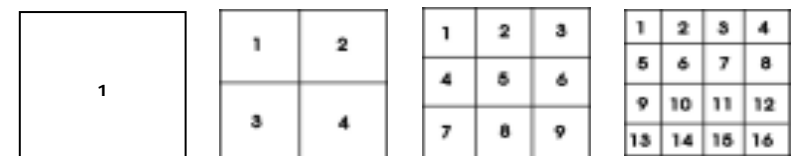



**4-Camera Display**

The first click of this button displays cameras 1 through 4 on the screen. Continue to click to view cameras 5 through 8, 9 through 12, 13 through 16, and finally returning to cameras 1 through 4. The cycle goes on as illustrated in Figures 5 through 4. Double-clicking any camera image under the 4-Camera display will take you to the full-screen display and begin the Auto Scan function

Figure 5

1	2	3	4
5	6	7	8
9	10	11	12
13	14	15	16

Figure 6

5	1	2
3	4	
6	7	9
10	11	13

Figure 7

1	8		
2	3	4	5
6	7	9	10

Figure 8

3	1	
8	2	4
5	6	



**9-Camera Display**

Clicking this button displays cameras 1 through 9 concurrently.

1	2	3
4	5	6
7	8	9



**16-Camera Display**

Clicking this button displays all sixteen cameras concurrently.

1	2	3	4
5	6	7	8
9	10	11	12
13	14	15	16



**Full Screen**

Click this button displays, you can switch the current audit mode to full screen. If you wish to switch back to audit mode, right click on mouse button so that you can exit full screen mode.



**Auto Screen**

In screen splitting mode, click this button to enable auto scanning function. It will enable camera to repeat scanning according to camera setting. Click on this button again will stop scanning function.



**Camera option button**

During scanning, click option button to select one camera from the list, and screen will switch for designated camera, then go back to original loop to continue scanning function; click drop down menu  and disable the selected camera.



**Screen capture**

Click this button to save the current auditing screen to a jpg file, and the saved time will be used as the file name. During the file saving, click on the button and its color would change to  red color. After file saving is done and its color will go back to normal.

### 4.2.1 System Setup



#### System configuration

Enter system setting screen, user can do the following: system setting, change password, camera setting, record setting, e-map setting, network setting, alarm setting, schedule setting and printer setting



#### System Setup

##### 1. Video signal warning:

If it is selected, system will beep warning when system detect camera has video loss.

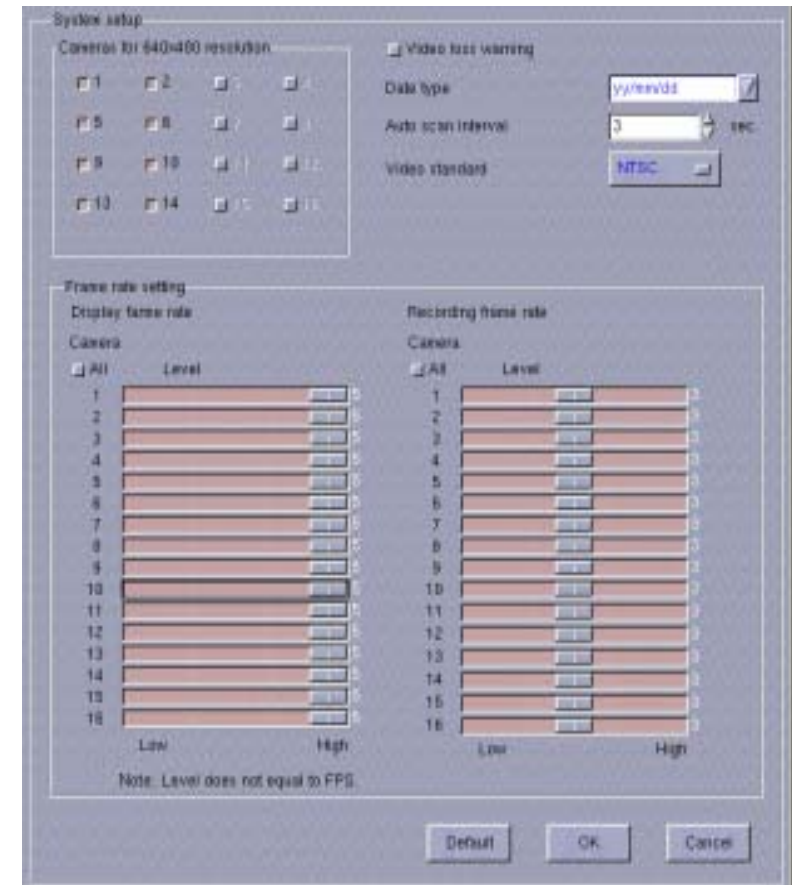

2. **Date format:**

System provide two different date format:

yy/mm/dd(year/month/day) and mm/dd/yy (month/day/year)

3. **Repeating scanning interval:**

After selecting the camera, enter the number of seconds for all cameras staying during repeat scanning.

4. **Video format:**

Please setup your camera video format: NTSC , PAL , SECAM

5. **Screen resolution 640x480**

System default resolution is 320x240. For those who wish to use 640x480 resolutions, you can switch the setting in this dialog box. If the resolution is higher, you need more hard drive space as well. And if you select more than one camera, the system performance would be degraded.

Product	Camera Sets
LX5004	1、 2、 3、 4
LX5008	1、 2、 3、 4、 5、 6、 7、 8
LX5016	(1、 9) (2、 10) (3、 11) (4、 12) (5、 13) (6、 14) (7、 15) (8、 16)

6. **For 16 splitting screen setting**, system will distribute the resource for two cameras as one team. Therefore, if you set frame number or

screen resolution for one camera, the other camera in the same team will have the identical setting.

7. **Display recording frame number**

According to audit environment, you can set camera display frame number and record frame number. Frame number setting has five different levels. Higher level will cause faster display and record, but it requires more hard drive space.



**Password Setup**

Password Setup enables/disables the three user levels and sets the password for each level.

LX5000 provides three users Levels: *root*, *administrator*, and *operator*.



**Obtaining Authorization**

Click **Password Setup**,

Which will display a dialog box as shown in the figure below to login: The system will ask for User ID and Password before accessing certain configuration screens when either *administrator* and or *operator* authorization has enabled.





Key in "123456" (default root password) the on password field for the initial login from root. Click **OK** to bring the next dialog as follows to change password:













In the Change password field of the root's configuring area, type the new password and retype it to confirm the password. Follow the same steps to change administrator's and operator's passwords. After initial configurations you can enable *administrator* and *operator* authorization levels by clicking the **enable administrator** and **enable operator** buttons. Click **OK** to save the setup or **Cancel** to back to the menu of System setup without saving.

**If you do not set the passwords and enable the *administrator* and *operator*, there is no password security and users will have unrestricted access to system configurations.** However, it is recommended to do it only after the initial configurations. This is done to avoid having to always enter passwords when entering and exiting configuration screens.









 Higher-level users can set/change passwords for lower level users. For example, the *root* can set/change the passwords for the *administrator* and *operator*, and the *administrator* can set/change the password for the *operator*. The authorization order is : *root* > *administrator* > *operator*.

See tables below for more clarification about the authorization.

1. When both the **enable administrator** and the **enable operator** buttons are activated, access to the following configurations are restricted as follows.

Functional Item	Root	Administrator	Operator
 Start/stop record			
 Setup	√	√	√
 System setup			
 Password Setup			
 Camera Setup			
 Recording Setup			
 Setup E-Map			
 Network Setup			
 Alarm Setup			
 Schedule Setup			
 Printer Setup	√	√	√
 Playback	√	√	√
 Event search	√	√	√





 Intelligent search	√	√	√
 Change split	√	√	√
 Printer Setup	√	√	√
 Backup			
 Save to floppy	√	√	√
 Show E-Map	√	√	√
 PTZ Control			
 Start Network Service			
 Exit			













√ : No password needed



: Needs password

: Not authorize

2. When only the **enable administrator** button is activated, accesses to the following configurations are restricted as follows.

Functional Item	Root	Administrator	Operator
 Start/stop record	√	√	√
 setup	√	√	√

 System setup			
 Password Setup			
 Camera Setup			
 Recording Setup			
 E-Map Setup			
 Network Setup			
 Alarm Setup			
 Schedule Setup			
 Printer Setup	√	√	√
 Playback	√	√	√
 Event search	√	√	√
 Intelligent search	√	√	√
 Change split	√	√	√
 Printer	√	√	√
 Backup			
 Save to floppy	√	√	√
 Show E-Map	√	√	√









 PTZ Control			
 Start Network Service			
 Exit	√	√	√







√ : No password needed

: Needs password

: Not authorize

3. When only the **enable operator** button is activated, accesses to the following configurations are restricted as follows.

Functional Item	Root	Administrator	Operator
 Start/stop record			
 Setup	√	√	√
 System Setup			
 Password Setup			
 Camera Setup			
 E-Map Setup			
 Recording Setup			
 Network Setup			













 Alarm Setup			
 Schedule Setup			
 Printer Setup	√	√	√
 Playback	√	√	√
 Event search	√	√	√
 Intelligent search	√	√	√
 Change split	√	√	√
 Printer	√	√	√
 Backup			
 Save to floppy	√	√	√
 Show E-Map	√	√	√
 PTZ Control			
 Start Network Service			
 Exit			









√: No password needed

: Needs password

: Not authorized

4. When neither the **enable administrator** nor the **enable operator** buttons are activated, restrictions are as follows.

Functional Item	Root	Administrator	Operator
 Start/stop record	√	√	√
 setup	√	√	√
 System setup	√	√	√
 Password Setup			
 Camera Setup	√	√	√
 E-Map Setup	√	√	√
 Recording Setup	√	√	√
 Network Setup	√	√	√
 Alarm Setup	√	√	√
 Schedule Setup			
 Printer Setup	√	√	√
 Playback	√	√	√
 Event search	√	√	√
 Intelligent search	√	√	√

 Change split	√	√	√
 Printer	√	√	√
 Backup			
 Save to floppy	√	√	√
 Show E-Map	√	√	√
 PTZ Control	√	√	√
 Start Network Service	√	√	√
 Exit	√	√	√

√ : No password needed  
 : Needs password  
 : Not authorized.



**Camera Setup**

This section provides you to place the arguments of camera setting.

Click **Camera Setup**. It will show a window like the following:



You can select the Camera based on the serial number, and do the proper adjustment for each camera: The adjustment includes turning off the camera signal, display the camera, camera name, picture adjustment, and PTZ camera setting.



#### 1. Camera no

Click on the desired camera button to configure the further setup. Check **Disable** to disable the camera if it isn't desired to be shown on the screen or has no signal.

#### 2. Camera name

Name a specified camera in **Camera name** field

#### 3. Disable camera

Turn off Signal: To decide you want to monitor the camera or not is fully depended on this camera is selected or not. Because the system will set all the cameras at the display status automatically. Therefore, when you did not use the entire camera, please turn off those un-used cameras. This can avoid the picture quality to be affected. This can also reduce the numbers of display and recording. After you select it, the camera will show gray level condition in the monitor screen.

4. **Display** Check this item to allow camera screen to work.

#### 5. Image Properties

You may set the following properties for the image of this camera: brightness, saturation, hue, contrast

Settings for the image properties are configured for the designated card, which may also connect to other cameras. That means, the settings you make for this camera will apply to other cameras that connect to the same card.



The adjustment of image properties will result in inefficiency as the video format is set to be PAL for the unsupported hardware temporarily

## 6. PTZ camera

After you finish PTZ camera installation, enter manufacture name, COM port and address for PTZ camera setting in camera option, and click save button to finalize the system and camera communication setting.



If you haven't done setting in PTZ camera,  the button won't be used.

default setting restore the manufacture default setting

Restore reload the previous setting

Save save all the changes

Quit exit the setting dialog box.



### Recording Setup

This section allows you to setup the recording arguments.



### Camera no

Click on the desired camera button to configure the further setup.

### Recording Type

#### 1. Cont. recording:

The system records images from the selected cameras 24 hours a day.

#### 2. Motion detection recording:

The system will start recording while any movement is detected.

#### Sensitivity

Select the camera's sensitivity (default 70%) to motion detection by dragging the scroll bar. Larger values represent higher sensitivity

#### 3. Display only: The system only monitors and does not record.

### Recording

#### Pre-recording frame number:

This value is the number of frames to be recorded before the system commence recording. These pre-recording frames are buffered in the system.

**Quality**

Adjust the recording quality by dragging the scroll bar. Keep in mind that the more precise the recording quality, the more space is taken up on the hard disk.

**High speed recording**

The compressed ratio is lower, and recording speed is higher. But the recording files need bigger memory space.

**High pressure recording**

The compressed ratio is higher, but the recording file needs smaller memory space. It can save the memory space.

**Mask/ Shield**

Mask a specific area to leave the rest area for the motion detection. And, to enable **Shield** that provides you to protect some private areas from the entire surveillance control into a black shield, ex: a fitting room in a department store.

**To set Mask /shield**

1. To add any Mask/Shield areas, simply click **Add**, and then draw the area you want to add to the Mask/Shield area. On the camera's image, click and hold the middle button of the mouse and drag the area you want to mask. To clear all masked areas by clicking **Clear**.
2. Check **Mask/ Shield** to enable this function.

**default setting** restore the manufacture default setting

**Restore** reload the previous setting

**Save** Save all changes.

**Exit** Exit the setup screen. Note that this does not save your changes.



**E-Map (Electronics Map) Setup:** Push this bottom, and get into the manual of electronics map setting. You can get the information of those electronics map which has been set (electronics map serial number, name, and instruction). Further more, you can add, delete or modify the setting of the electronics map:

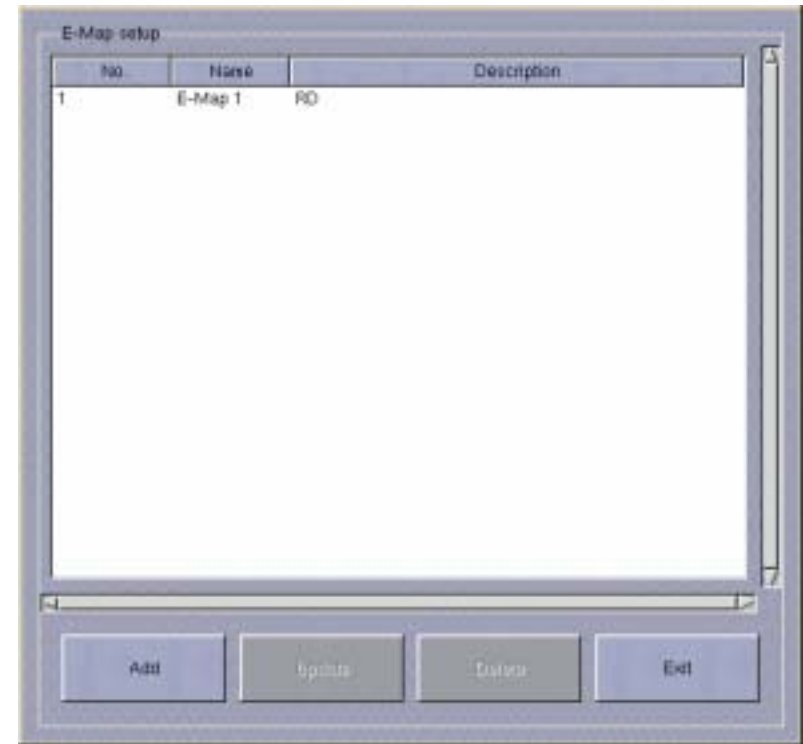

Press the "Add", "Delete", " Renew" bottom to get into the setting Interface of electronics map. Then, you can add, delete, or modify the information of electronics map.

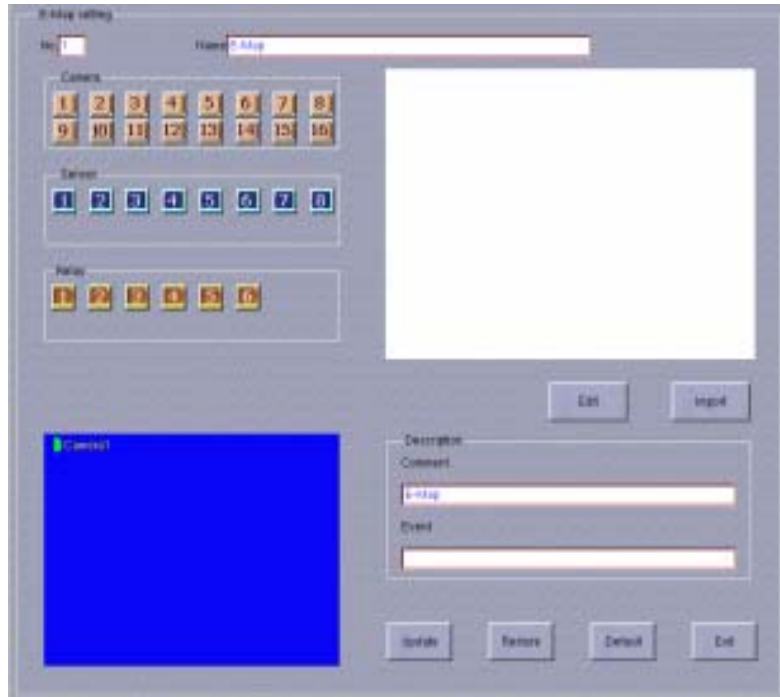

Please follow the following steps to set the electronics map:

1. **Input the background map:** Press "Edit" button and get into BMP, JPEG edit program to modify and edit the background map. Or press the "input" button to input the existing map directly.
2. **Camera, sensor, transformer:** Depends on the install condition to click and pull out the camera, input sensor and output transformer from each column to the background map. If you want to delete them, you can just simply pull them back to the original columns directly.

3. **Instruction:** You can input the related exploitation and information of electronics map from the instruction column. The map name and instruction the status rows of electronics map

**Default Value:** Set the camera at the default value.

**Refresh:** Set all the values back to the previous values.

**Save:** Save the modified values and parameters.

**Quit:** Quit the recording setting screen.



### Network Setup

#### Network Service

You can start the Remote Management and Web Cam, then set the TCP/IP server port (Default value is 9090), and HTTP server port (default value is 80) information. Please select the camera that you want to open the connection.

#### IP Configuration:

##### Enable DHCP

Please select this column, then you can get the dynamic IP address.

If your LSS digital monitor system is at the dynamic IP condition, you can log on [ddns.avers.com.tw](http://ddns.avers.com.tw) to use the DDNS registration web page to register your domain name and password. Then, you can input your domain name and password from this column.

Regarding the registration of DDNS domain registration, please refer to the attached file 1.

Input the IP address, net mask, gateway, and hostname.

#### Dynamic DNS

In case a dynamic server is severed, please register a domain name with the IP address: [ddn.avers.com.tw](http://ddn.avers.com.tw) on line. Refer to **Appendix B** for

the further information.

**Domain Name & Password**

Enter the domain name and password given in the process of registering a domain name or obtain them by asking network administrator.

**Modem Connecting Port:** Please swat the modem connecting port in this column.

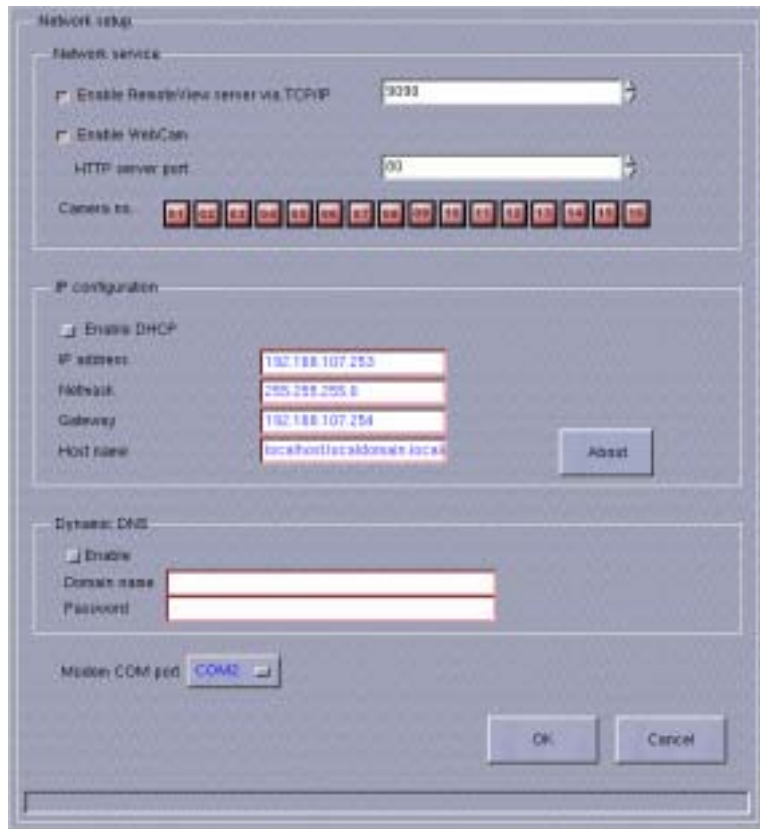

**i** When you install the fire wall, please enable the fire wall NAT function (network address translation) for the connection of image transmission. On the server side, the server port must be set as default value: 9090(can be changed), and the server port of image transmission must be set as 9191; For the Client side, the server port of image transmission must be set as default value 9190.

**i** When you set the LX5000 server in the LAN, if you want to connect to the server through the internet, please specify the server port (between 150 and 1023) at the HTTP server port.

**Enter Save** the modified values and parameters.  
**Cancel Quit** the recording setting screen.

**Alarm Setup**

This button allows you to configure alarm setup in the following window.





Click **Add** to create an alarm and the detailed configuration window will pop up:

This window contains **Condition** and **Action** configurations. Actions will be performed according to the setup of conditions.

To add an alarm following the steps below:

1. Identify alarm name and alarm description.
2. **Configure Condition**

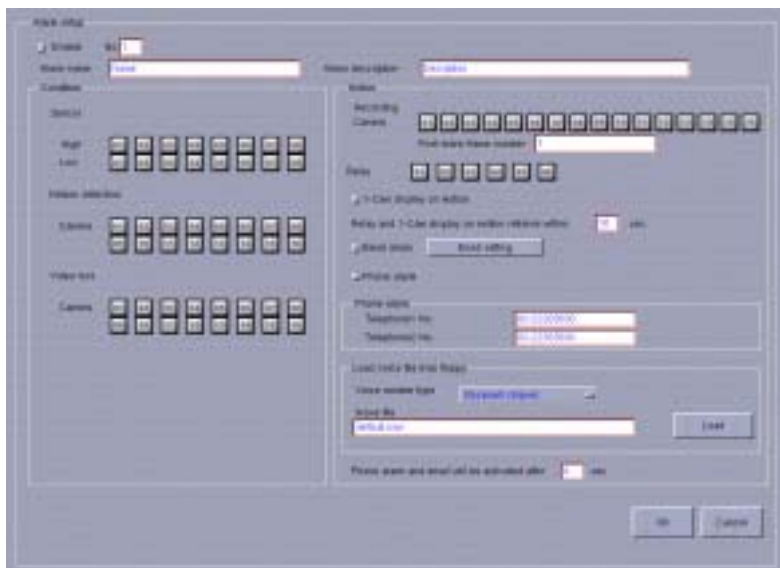

### Sensor

Select the cameras for the trigger according to sensor device, high electricity input (high to low), and ex: a light is being turned off, and low electricity input (low to high), ex: a door is being opened, camera

motion detection, and camera video loss.

### Motion Detection

Select the cameras for the trigger according to motion detection configuration in **Recording Setup**.

### Video Loss

Select the camera number whose video is lost during monitoring.

### Configure Action

#### Recording

Select the cameras to behave recording once any of the conditions is triggered.

#### Post-alarm frame number

Set the frame number according to which the system will last recording once any of the conditions is triggered.

#### Relay

Select the cameras to act relay while any of the conditions is met.

#### Full Screen on Motion

During surveillance, you can have the system to instantly pop up the image (1-camera display mode) that has motion detected for a user-defined length of time.

#### Relay and Full Screen on Motion retrieve

After an input is triggered, the output of relay and full screen on motion will revert to normal status after the time you set.

#### Email alarm

You can email alarm messages once an alarm is triggered. Follow the instructions below.

- A. Check **Email** setting to enable this function.
- B. Click **Email setting** to bring up the dialog box below to set up the email information.

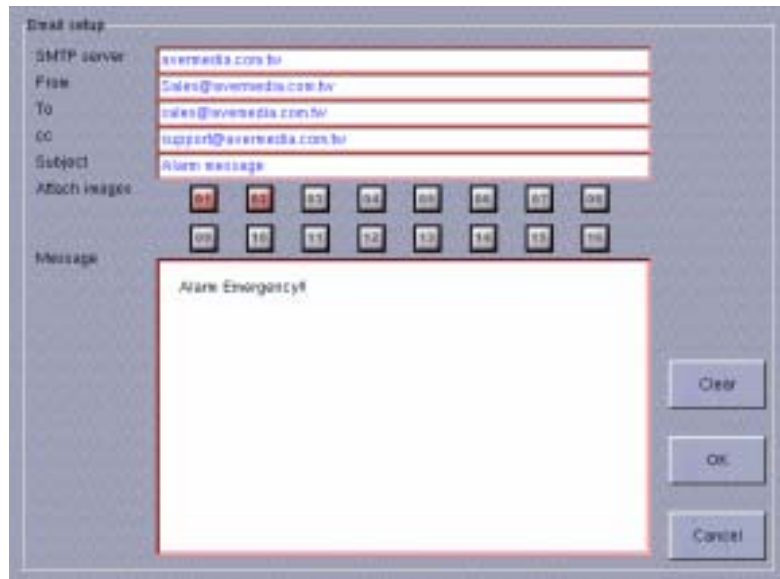

**Provide information for each field.**

- SMTP Server: The domain name of your mail server or IP address.  
(eg. AVerMedia.com.tw)
  - From: The sender's email address.
  - To: The receiver's email address. Use ";" (semicolon) to separate each email address.
  - Cc: The email address to which you want to send a copy.
  - Subject: The subject of this alarm message.
  - Attach images: Select cameras to attach the first image of which once the alarm is triggered.
  - Alarm Message: The content of this email message.
- C. You can click  to clear all the inputs. Click  to save the Email settings or click  to exit the dialog box without saving.

**Phone Alarm**

You have to Key in two sets of phone numbers for the system to dial when the alarm goes off. If the first number is busy or invalid, the system will switch to the second number.

**Load voice file from floppy**

You can record your voice message as a sound file on a floppy disk then download it from the floppy. This voice message will be sent to the phone numbers you entered.

**Voice modem type**

First, select the chipset your modem uses and then load the sound file by clicking . The dialog box, besides will display. Browse, to the alarm message file you want to install and click the **OK** button.

**Sound, call out and email will be activated**

The output ways you designate after an alarm is generated offer you to decide the deferment once an alarm is triggered. Click **OK** to save the settings, or **Cancel** to quit this window without saving.



### Schedule Recording Setup

To setup a recording session click the **Schedule Recording** button and then click **Schedule Setup**. Use the diagram below and follow the instructions to set up a recording session.



Click **Add** to create an alarm and the detailed configuration window will pop up:

1. Identify alarm name and alarm description.
2. **Schedule Task**

Here you can select the tasks you're scheduling for.

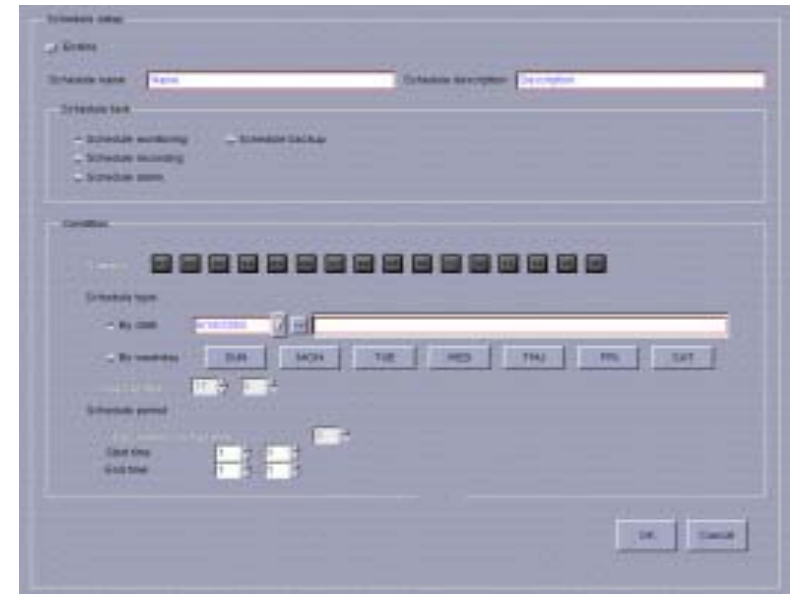

### Schedule Monitoring

If you select **Schedule Monitoring**, the system will activate this button



on the main menu when the scheduled time is due. The system will act according to the recording mode set in the  **Recording Setup**.

### Schedule Recording

If you select **Schedule Recording** as the task, the system will have the chosen cameras to start full recording at the scheduled time. The task you set here enjoys higher priority than the recording mode you set for each camera in **Recording Setup**.

### Schedule Alarm

If Alarm box is checked, the Alarm will execute according to the **Alarm**

section you plan as long as the **Time** is due. To exercise the prior privilege of **Scheduler**, the **Alarm** will perform by the scheduled time even though it is not enabled in **Alarm** section of System Configuration.

**Schedule Backup**

Check **Schedule Backup** to start "Backup" while the set time is due.

**Condition**

**Camera**

Choose the camera you would like to execute the task. The selected cameras turn from gray to red.

**Backup Time**

Here allow you to arrange schedule time to backup.

Select one of two scheduling types to arrange the time to start

"Backup":

**Record by date**

You can key in the date directly in the **By Date** field or click the **down arrow** button to choose a date from a drop-down calendar menu and then click  to add that date to the date box on the right. Make sure that you click the diamond next to the label **Record by date**.

**Record by weekday**

Click on the weekday button you would like to record. Make sure that you click the diamond next to the label **Record by weekday**.

**Start time**

Set the backup time in which you would like to start recording.

Furthermore, the backup time will end according to the length of the schedule period.

**Schedule period**

Put a date number in **days before backup date** field to determine which days' files you desire to backup. Set **Start time** and **End time** to

perform the scheduled task on the period.

Click **OK** to add a new schedule or **Cancel** to exit the window without saving. Consequently, the schedule status will list on the schedule status window.



**Printer Setup**

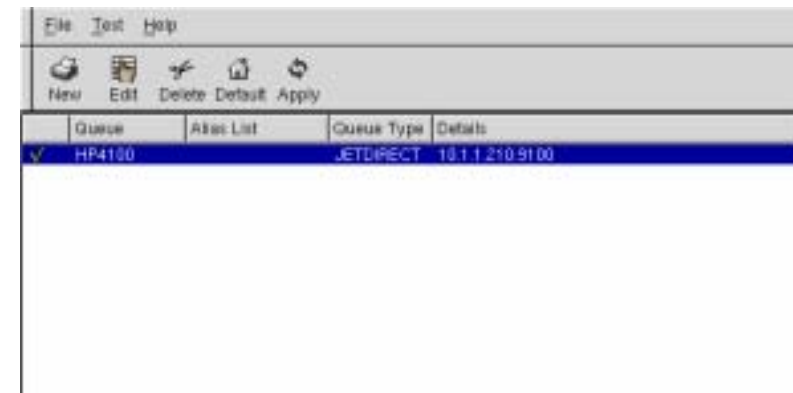

Click **Printer Setup** button to establish the connection between the printer and the system.



### 4.3 System Operation



#### 4.3.1 Start / Stop Recording

Clicking the **Start/Stop Recording** button in the main menu will activate surveillance according to the configurations in the  **Recording Setup** page and  **Alarm Setup** and **Schedule Recording Setup**  page. The center of this button will turn red to indicate surveillance is activated and turns white when deactivated. Click this button again to halt surveillance activity. **Note that while the surveillance is active, you cannot concurrently configure any of the cameras. You are, however, permitted to adjust the controls of the PTZ cameras.**

 You must click the **Start/Stop Recording** button after you finish configuring the LX5000 system to activate surveillance. The system is inactive until you click this button.

#### 4.3.2 Playback

Click **Playback** button to reveal the following window:

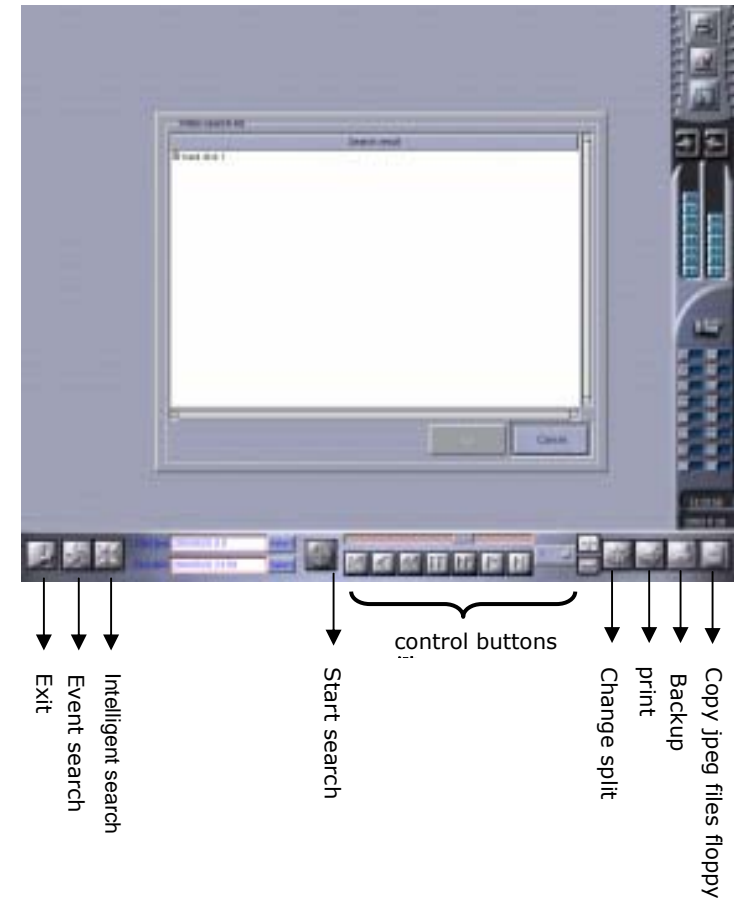

1. Use the searching chart, follow the hard disk-> year, month, day -> camera-> display all the file names of the saved recorded files based on hour, minute, and second time period. Press "Enter" to quit the searching chart, and prepare to play the recorded file. Or press the "Cancel" button to select the recorded file which you want to play by using the two quick searching method that provided by the system.

**Event Search:** Based on the conditions of alarm activation and the alarm actions: Dynamic detection, signal interrupt, transformer output, sensor activation, sound detection, telephone alarm or all of the above events happened as the condition to search the recorded files that matched the conditions required to do the search during the specific period of time.

**Intelligent search:** use the covered area, searching period as the searching conditions. Use dynamic detecting technology to do the comparison between some specific periods of time to find out the time of recording file which has the change within the covered area.

2. Select the file that you want to play. Please wait until the prepared recording file showed up. Then, press the "Play" button to play to the recorded file.



"Play" Button. During the file playing process, you can use the following functional button.

The playback control buttons are defined as follows:

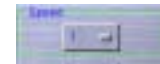
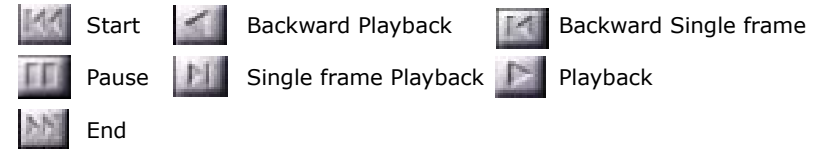

There are 7 levels 8, 4, 2, 1, 1/2, 1/4, 1/8 to select the speed while playing files. The default value is 1 for the normal speed; 2, 4, 8 for the double speed-up increasingly; and 1/2, 1/4, 1/8 for the double deceleration decreasingly. Simply click the button to pick out one speed for display.

3. Press  the "Start" button. You can call and display the previous searching results.

 **Event Search**

Click this button to bring up the **Event Search** dialogue box. You will be able to view log files that meet specific time and event criteria.



To enable this function, complete the following tasks:

1. **Select event**

First pick out one event from Motion detection, Video loss, Recording, Relay output, Sensor input, Phone alarm, Alarm, and All.

2. **Set the search begin/end date and time**

Click **Select** to define the specific time for the files you want to display in **Start time/ End time** field in beside the window.



3. **Search**

After you finish entering in the above criteria, click  button to list all files that satisfy your requirements in the following window. This Event list displays the results of your search.

4. **Search List**

There are seven columns of information: file time, alarm operation, number of relay/recording, trigger/clear alarm, alarm condition, sensor/camera number and hard disk number. Clicking on the column headers will sort the rows in the order of the column information, alternating between ascending and descending with every click.

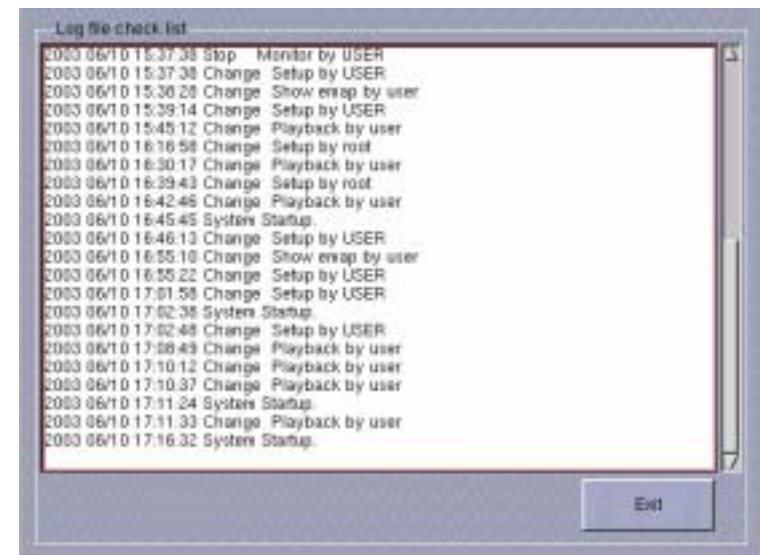

5. Then highlight the desired frame to playback and click **OK** to confirm the choosing or **Cancel** to quit the window without saving.

6. **Playback**

You can click "OK" button to back to playback main menu. Use playback control panel to display the file that will start at the time of the chosen frame in search list.



7. **Search Result**

Click **Search Result**  to recall the previously searched list if you have exited **Video search list**.

8. **Exit**

Simply click **Exit**  to back to Playback main menu.



**Intelligent Search**

The Intelligent Search button will bring up a dialogue box that will assist you in searching for any motion detection in the specified area of a camera's log files. Whenever the search finds files with motion detection in the specified masked area, it lists them in the table.



1. **Search interval**

During searching, the system will search the files with the period of the time value (sec.) you set whenever a movement is detected.

2. **Search Detection Sensitivity**

You can move this scroll bar to adjust the search sensitivity. Less search detection sensitivity decreases the number of files found.

3. **Setting the Mask**

Setting a mask refers to identifying an area on a screen used to detect movement. First click **Show** and then press and hold down the middle button of the mouse and drag in a downward diagonal motion. This will create a motion detection grid on the screen.

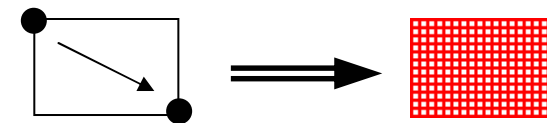

**Show Mask**

The system defaults to show mask. You may choose to show or hide the mask by clicking the **Show Mask** button.

**Show Change Only**

By clicking this button, the system only shows the image files that have motion detected in the mask area.

4. **Set the search begin/end date and time**

Click **Select** to define the specific time for the files you want to display in **Start time/ End time** field in the beside window.



5. **Search**

After you finish entering in the above criteria, click this button to list all files that satisfy your requirements in the following window. This Event list displays the results of your search.

6. **Search List**

There are seven columns of information: file time, alarm operation,



number of relay/recording, trigger/clear alarm, alarm condition, sensor/camera number and hard disk number. Clicking on the column headers will sort the rows in the order of the column information, alternating between ascending and descending with every click.



7. Then highlight the desired frame to playback and click **OK** to confirm the choosing or **Cancel** to quit the window without saving.

**8. Playback**

Clicking "**OK**" button to back to playback main menu. Use playback control panel to display the file that will start at the time of the chosen frame in search list.

**9. Search Result**

Click **Search Result**  to recall the previously searched list if you have exited **Video search list**.

**10. Exit**

Simply click **Exit**  to back to Playback main menu.

 **Change Split**

This button allows you to change the number of camera displays (max. 16). Continuously clicking the **Change Split** button, will reduce the number of camera images from 16 to 9 to 4 and finally to 1 screen after which it will return to 16 images.

 **Print**

Before you use the print function, please switch the divided mode to only one divided view. Then select the camera that you want and get into the print screen. Set the numbers of page you want to print. Then, press the "Print" button and start to print.

 **Backup**

In case a backup is needed, click **Backup**  to save the particular files in the configuring window.

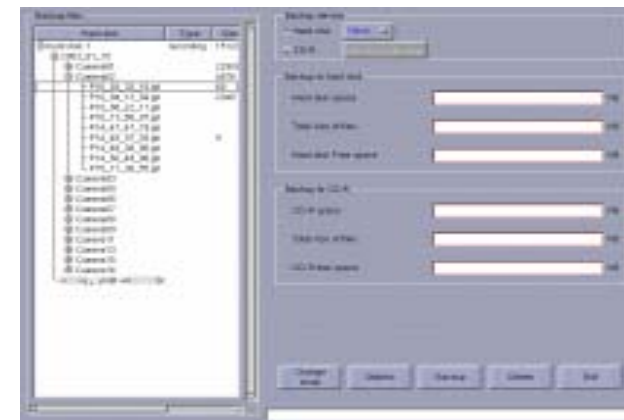

**Backup files**

There are hard disk, type, size (KB), use%, total (KB) lists to view all of the files in every hard disk.

- a. Determine working type of hard disk by clicking **Change mode**. It is allowed to have the hard disk run either recording or backup.
- b. Highlight the wanted files to backup and decide the **Backup device** from hard disk or CD-R. If CD-R backup device is chosen, it will appear the following window to configure a CD-R device.

 Note that only the CD-R with IDE interface can be connected to IDE 1 slave.

If CD-R backup device is chosen, it will appear the following window to configure a CD-R device after clicking **Backup** button.



Click **Create CD** to configure the CD-R program.

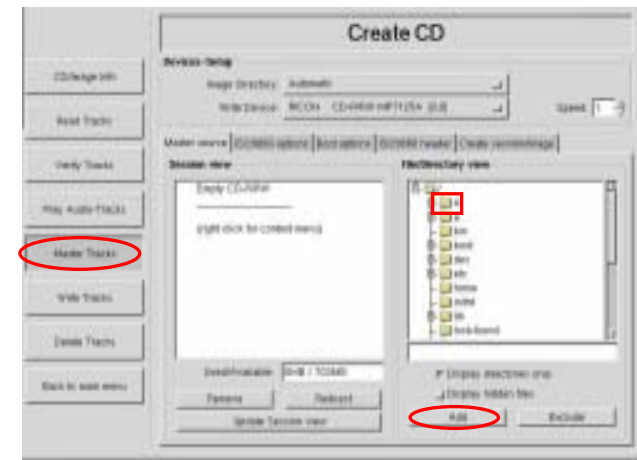

Click **Master Tracks** button, selecting **Directory A**, and clicking **Add**. Click **OK** in the consequently shown dialog. The **Session View** dialog will show the information about **directory A**.

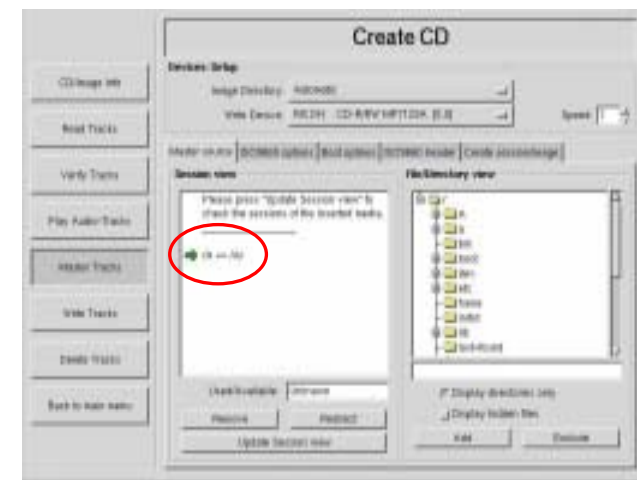

Click the page **Creation session/image** to view the working and free space. Eventually, burn the CD by clicking **Master and write on-the-fly**.

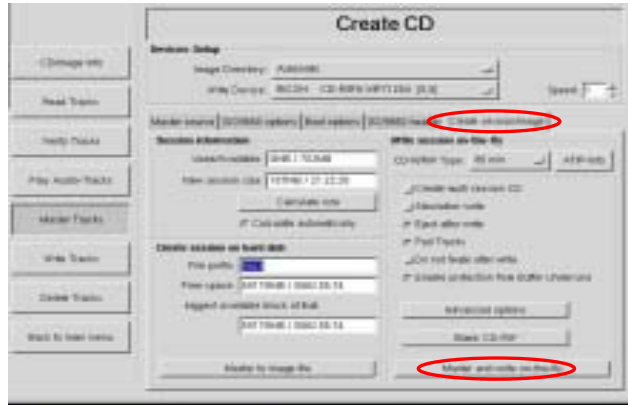

- a. Click **Statistics** to calculate the free space of backup device according to the backup setting you build up previously. It is observed that the space sizes of backup device shown in **Backup to hard disk/ CD-R** field, which will assist you to arrange your backup stuff.
  - b. Execute backup by clicking **Backup**.
6. **Delete**  
 If you would like to remove any files, highlight the file in **Backup files** field and click **Delete**. **Note that the deleted files will never to be recovered.**

 These backup files can be played back with playback program in the CD-R under Windows OS and also can be played back with LX5000 playback program under Linux OS.



**Copy jpeg file to floppy**

The system will detect the numbers of divided view in the screen to the soft disk. For example, if the screen was divided into 9 views, when you press this button the system will copy the screen view of camera 1 to camera 9 and save to the soft disk. When you press this button, please select the format of the file as \*.jpg or \*.bmp. Then, the system will name the files based on the recording time automatically.



AVerMedia digital monitor system provides the WaterMark function. When you use the save function to save the .bmp file, you can use the Image Verification program which provided by the system(Please refer to the attached file 2) to judge the file is real or fake. It can also verify the saved bmp file was modified or faked or not.



**4.3.3 Show / Hide E-MAP**

After the configuring in the **E-Map** section of System Configuration, click this button to view the e-maps.

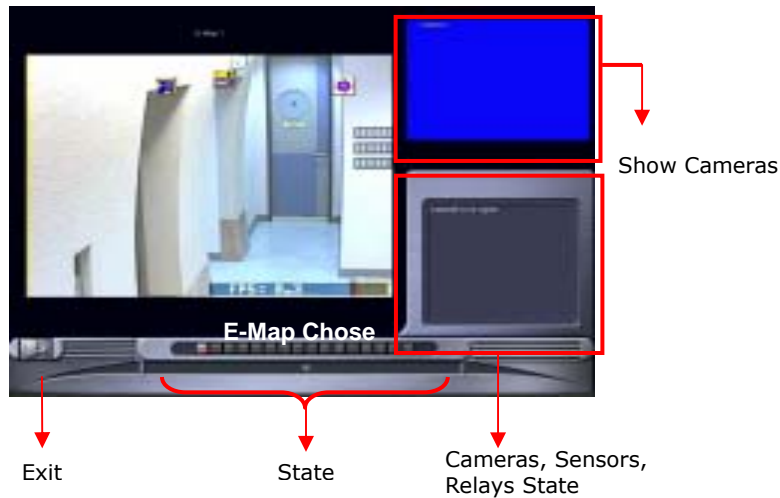

1. Chose a map to view by clicking the map button
2. **Check out Cameras, Sensors, Relays on the map**  
Focus on the desired event by clicking on the event button on the map.
3. **Monitoring Cameras, Sensors, and Relays**  
If any event is focused, the relative information will present in the information field; otherwise, you can monitor the status of the camera in the right upper window. The different colors of the icons on the map window will turn to different flashing colors accounting for as follows:

Icon	Color	Status	Icon	Color	Status
	Yellow	Normal		Yellow	Normal

	Blue	Video Loss		Red	Activated
	Green	Motion Detection		Yellow	Normal
				Red	Activated

4. Click **Exit** to leave for main menu.

#### 4.3.4 PTZ control (Pan-Tilt-Zoom Camera)

After the PTZ cameras are connected to the system, you may click to access the following interface to configure the PTZ camera.

##### 1. PTZ Camera Menu

After you install the PTZ camera, remember to enter the **Vendor and Address (Decimal)** of the PTZ camera in the **Recording Setup** page, and then click **Save** button to update the information. If you haven't configured the PTZ camera in the **Recording Setup** page, the button cannot be used.



 **Auto Pan**

Click this button to instruct the PTZ camera to begin AutoPan based on the AutoPan configurations: **preset positions**, **speed**, and **time to stay**. Preset positions are the different views that the camera will pan to. Speed is the speed that the camera moves between preset positions (e.g. 30°/ second). Finally, time to stay is the amount of time the camera stays fixed before or after, depending on your PTZ model, moving to the next preset position.

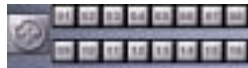

**Preset Positions**

Once Preset Positions are configured (see Setup below) you can, at any time during surveillance turn the camera to any of the preset positions by clicking on buttons 1~16.

 **Setup**

Click this button to enter the PTZ Setup Menu to set the desired preset positions. The **PTZ Setup Menu** dialog box is explained towards the end of this section.

 **Focus in**

Use this button during surveillance to decrease the focal length for a clearer picture.

 **Focus out**

Use this button during surveillance to increase the focal length for a clearer image.

 **Zoom in**

Use this button during surveillance to zoom in and enlarge the size of the image.

 **Zoom out**

Use this button during surveillance to zoom out and reduce the size of the image.



Select one of the 16 preset positions from the **Preset Position Number** buttons, then select the speed from one of the 4 **Speed** buttons (the higher the level, the faster the speed), and then use the **Up/Down/Left/Right** buttons to adjust the position of the camera.



**Direction buttons**

Use these buttons to navigate the camera's directional focus during surveillance.



**PTZ Camera Number**

You may view the status of each PTZ camera by clicking on the corresponding **PTZ Camera Number** buttons. Highlighted cameras indicate that the PTZ cameras are connected. The gray (disabled) squares indicate that no PTZ cameras are operational or no cameras are installed.



**2. PTZ Setup Menu**

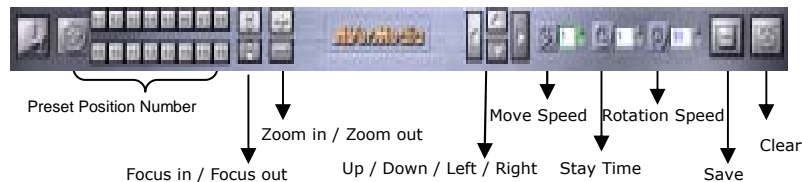

Select one of the 16 preset positions from the **Preset Position Number** buttons, then select the speed from one of the 4 **Speed** buttons (the higher the level, the faster the speed), and then use the **Up/Down/Left/Right** buttons to adjust the position of the camera.



**Focus in / Focus out:** Click these buttons to adjust the image focus.



**Zoom in / Zoom out:** Click these buttons to zoom in and zoom out, enlarging and reducing the image respectively.



**Stay Time:** Use this setting to configure the stay-time in seconds (1~8 seconds), which defines the time the camera stays fixed at its previous or next preset position, depending on your PTZ model, during Auto Pan.



**Rotation Speed:** This parameter defines the speed the camera rotates from the current position to its next preset position. The rotation speed (degree/second) ranges from 30°per second to 240°per second in increments of 30°per second.



**Save:** After completing the steps above, click this button to save the current preset position settings. Choose the next preset position and follow the same steps until all desired positions are set. If you want to continue with another camera, click  to go back to the main menu of the PTZ Camera and select the new camera.



**Clear:** Click this button to clear the previous settings for all preset positions for the current PTZ camera. If you only want to delete some of the preset positions, you need to click into each preset position, delete and/or reset new parameters before you click the **Save** button.



**4.3.5 Start Network Service**

**Press this button:** start or stop the internet service. Then, it can accept the Client to do the remote management through the web viewer and remote management program. When you press the button one more time, you can stop the internet faction. The system will ask you to input the password when you log on or log off. When the system

confirms the password is valid, then you can start or stop the internet function.

**Internet Setting Function:**

Please get into the system setting, and do the setting in the internet setting. Please pay attention, you have to select "Remote Manager (through TCP/IP)" or "WebCam", then it can start to do the Remote Manager.

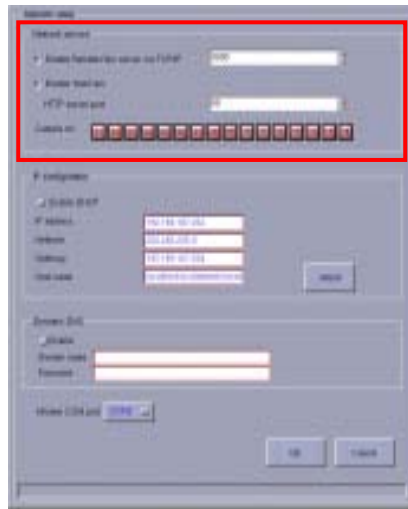

**4.3.6. Quit System**

**Press this button:** then you can quit the AVerMedia LX5000 digital monitor system.

**Chapter 5 Using the WebCam**

You can monitor images from the AVerMedia LX5000 server using Internet browsers (Internet Explorer). The AVerMedia LX5000 system has built in HTTP protocol and web server services.



Note that WebCam function must be running in Internet Explorer with version 5.5 or above.

**5.1 Enable WebCam**

Before you start monitoring from the remote browser, verify that the AVerMedia LX5000 server has finished the following settings.

**IE setting: Access Internet Options setting from Control Panel as the following dialog.**





Select Security page to configure Internet and Local internet sectors respectively.

Click Custom Level button to pop up the following dialog. Check Enable or Prompt radio button both in Download signed ActiveX controls and Download unsigned ActiveX controls.

Before you start monitoring from the remote browser, verify that the AVerMedia LX5000 server has finished the following settings.



Enable Web Cam (see Network Status)

- Check **Enable WebCam**.
- Select cameras to perform remote transmission.
- Verify IP address.
- Click the **OK** button and exit the dialog box.



## 5.2 Use the WebCam



You can browse the home page of WebCam with Microsoft Internet Explorer.

When you enter the home page, you can see the system defaults to 1-Camera display. You can click these buttons to change different numbers of split display:

-  1-Camera Display (640x480)
-  4-Camera Display (320x240)
-  6-Camera Display (320x240)
-  8-Camera Display (Enlarged: 480x360, Small: 160x120)
-  9-Camera Display (320x240)
-  10-Camera Display (Enlarged: 320x240, Small: 160x120)
-  16-Camera Display (160x120)



When the remote transmitting cameras are more than the split display number, you can click **NEXT** to switch the screen to display the following cameras. For example, the server has assigned camera 1, 2, 3, 5, 7, 10, 13, and 16, in total 8 cameras for remote transmission.

**If you select 4-Camera Display,**

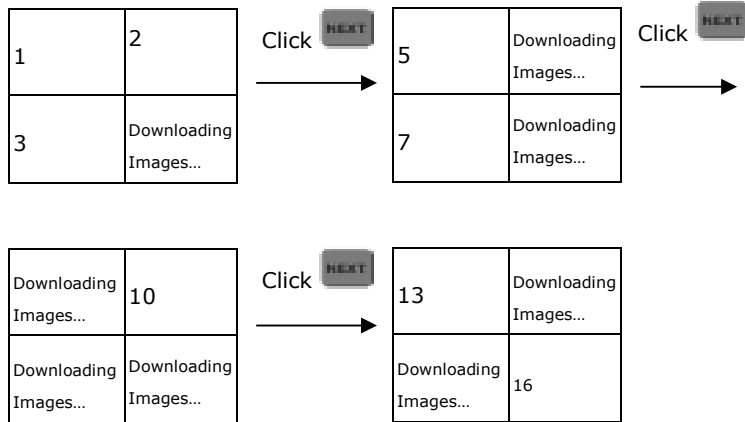

**If you select 6-Camera Display,**

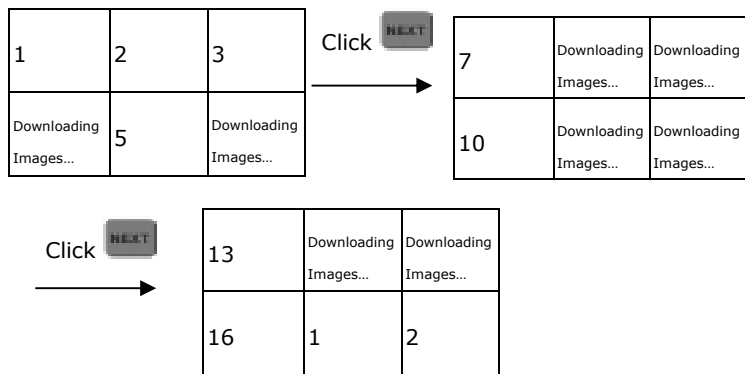

You can also change the display sequence by assigning different cameras to different channels. Select a channel from the drop-down menu **Channel 1**, and from **Camera 1** select a camera you want to assign to the channel you just selected. Finally click **SET** to confirm the setting. You can also assign the same cameras to different channels. If the selected cameras are not remote viewable, then the image on the screen will not change.



## Chapter 6 RemoteManager

### 6.1 Accessing RemoteManager

You need to install the remote surveillance program RemoteManager from the CD-ROM (See Chapter 3 - Software Installation.)

The RemoteManager program allows you to manage the server from a workstation almost as if you were working from the server console. This will allow you to be able to configure the server from a remote location.

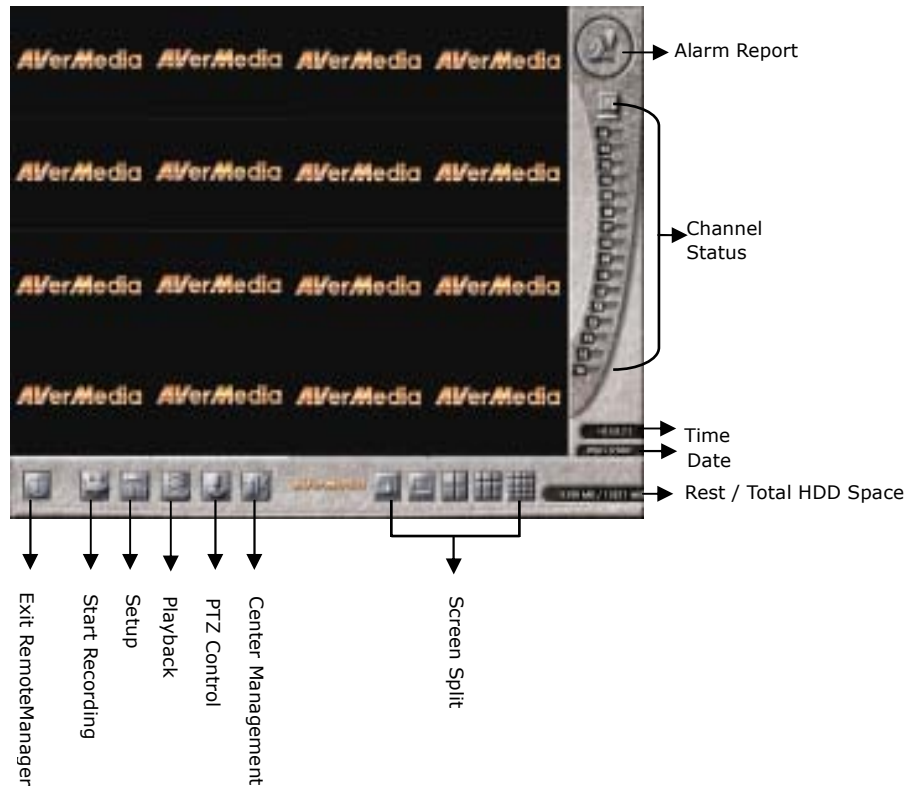

### Login

Once you first start the program by clicking the shortcut of Remote Manager on your desktop, a Login dialog right side will prompt you to enter the user ID and password to access to the program. Note that only "root" is the acceptable user ID for the initial access. And a **User Management** window for permitting the beginning into the system will be seen. To set the setting of the permission, refer to the **6.3.1 Center Management** for the detailed description.



### Alarm Report

The image will turn into red and be flashing once an alarm is triggered. An alarm message with the detailed alarm status will be seen after you click on it. It will help you control the situation of surveillance.



### Channel Status

An area where the status of all the channels will be shown as the following description and is with a tip of channel's, server's, camera's names while your cursor points the button:

	Dark Gray	All Disabled
	Flashing Pale Gray	Video loss
	Azure	Normal and the image is displayed on the screen
	Dull Blue	Normal but the image had been disabled to display
	Pink Red	Recording and the image is displayed on the screen
	Dark Red	Recording but the image had been disabled to display



If a camera is not enabled, the image from this camera will show as the image above (gray scale) on the screen.



If a camera is disconnected to the server or the signal from the server is disconnected to the local camera, the image will show as above on the screen. The signal will be picked up at an interval of one minute until it is

### Display Mode

Select a display mode to arrange the presentation of the screen.



Full Screen



1 Channel



4 Channels



9 Channels



16 Channels

No matter what channel mode you choose, you can assemble the channels as you wish by clicking **Channel Status**  to meet the amount of the mode. For example, if you choose 4 channels mode, you can click 4 channels (1,4, 8, 13), (3, 5, 7, 8), or other groups of the channels to meet the quantity of 4 channels mode.

## 6.2 Setup



### 6.2.1 User Management

User Management provides the easy management to safeguard the system from the unidentified users. Only the root is authorized to configure this section.

To achieve the setting, complete the following steps:



1. Click **User Management**. The following window will appear:
2. Use **Add/Delete/Rename** button to arrange **User** field.
3. Determine a password and make a confirmation.
4. Click **Save** to save the setup of password.
5. Click **OK** to save or **Cancel** to delete the previous arrangement.
6. Back to main menu by clicking **exit**.



6.2.2 Storage Configuration



**Assign Recording Disks**

First you need to assign the recording disks. Click  to browse for the folder to save the recorded videos and click the **Add** button. You can click the **Delete** button to remove any of the recording disks, as long as there is at least 1 disk left to save the recording data.

**Minimum Space & Safety Quota**

Next you need to provide the minimum space and safety quota for hard disk recycling. During hard disk recycling, the newly recorded files will overwrite the old ones. This way the system will not run out of hard disk space to save the recorded videos.

**Minimum Space:**

The system will start hard disk recycling when the hard disk free space is less than a user-defined number. The user-defined number has to be greater than 450MB, the system defaults to 450MB.

**Safety Quota:**

Once the hard disk starts recycling, the system won't stop until the hard disk free space becomes more than a user-defined number, say 6000MB (default value). **Safety quota should be at least 5550MB more than the minimum space you assigned.**



6.2.3 Camera Setup

The setting is placed according to the privilege of every server for the cameras corresponding to the 16 channels respectively.

Follow the tasks below to finish this section:

1. Click **Camera Setup**. It will show a window like the following:



2. Change channel's names by directly click on **Channel 1**.
3. Arrow down the list to select the **Server's** and **Camera's** names for each channel.
4. Check **Display** to show the images on the screen and **Recording** to enable the recording function for each channel.
5. Click **OK** to save or **Cancel** to delete the previous arrangement.

**i** The listed servers and cameras in the pull-down menu are decided by the settings of the each of the servers.

#### 6.2.4 Schedule Recording

The function allows you to plan the recording schedule by date or weekday for all the channels.

Do the steps following:

1. Click **Schedule Recording** to get the window below:



2. Check the recording by date or by weekday and choose the time by clicking the arrow of the box **2002/10/1**. The following window will show as:



3. Click on the yy/mm position directly and use the upper left and upper right arrows and the red circle in the bottom left corner window to specify a date to be an operating time.
4. Click **>** to confirm the time setting. A settled time will appear on the right blank box. Click **Delete** to delete the previous time setting.
5. Set the **Start** and **End** time by the up and down arrows **↑ ↓** in **Time** field.
6. Check the desired cameras to be involved into the schedule in **Camera** field.
7. Mentioned comment is allowed by using **Add/ Delete/ Update/ Restore** buttons for the further information while recording.
8. Click **Ok** to save or **Cancel** to delete the previous arrangement. Once the recording has been generated as the schedule, the recording status is observed in **Channel Status** field.

#### 6.2.5 Network Setup

If you want to transmit images for remote surveillance via TCP/IP, first click this button to pop up the following dialogue.



1. First determine a **UDP port** (Default 9190) to receive the images from server.
2. Select **TCP port** connecting to server via **Auto assignment** or specify at least 32 ports at a range from 1025 to 65535 for transferring image and receiving commands.
3. Click **OK** to save the setting or **Cancel** to quit the dialogue without saving.

**i** Make sure leave a free port (9091 recommended) in server for connecting. Besides, establish another fixed UDP port (9191) for transmitting images from server to client. In addition, a firewall NAT function should be configured to enable the mutual transmission.

The following is the detailed illustration to configure the connection:

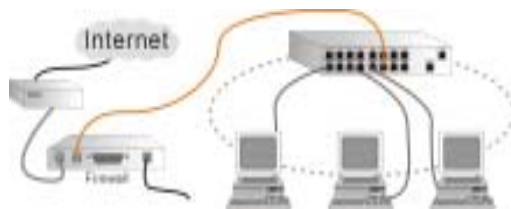

### 6.2.6 Sensor Status

The sensor status is viewed on the consequent window by clicking this button.



### 6.2.7 Relay Status

The relay status is viewed on the consequent window by clicking this button. Otherwise, you can set the duration of the relay output after a relay triggered. Note that the duration value "0" denotes the incessant relay output.



### 6.2.8 Alarm Control

It is available to choose the server and decide to enable or disable the corresponding alarms.

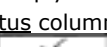
1. Click **Alarm Control** to see the window for alarm status.
2. To enable an alarm, simply click on  in the **Status** column and change the status to .

Click the **OK** button to save the setting.



### 6.2.9 Back to Main Menu

Back to the main menu be clicking this button.

### 6.3 Operating RemoteManager



#### 6.3.1 Center Management

Users can take advantage of this section to manage the connectable servers' detailed information.



The setting should be placed before you commence configuring the system at the first time. There are two ways to connect server:



Connection via Modem to Modem (refer to Appendix A for the connection):

First you should connect to the server manually via modem before accessing **Remote Manager**. Then, it is allowed to add a new server as a dial-up server is installed by server and a dial-up networking established by client.



Connection via TCP/IP

Once the function "**Enable Remote View server via TCP/IP**" in the setting of **Networking** section has been checked, you are allowed to add a new server via TCP/IP.

To offer the complete information, finish the steps below:

1. Click **Center Manager** button and the following window appears.
2. Click **Add** to include an available server into server list. The **Add Server** window will show as follows or click **Delete** or **Update** to modify the setting.

3. Enter the **IP Address** of the desired server and the same port number as the setting in Networking section of the server (default 9090). Click **OK** to start connecting or **Cancel** to quit the setting.



4. The pop-up window of **Add Server** will show the **Server Name** automatically if the IP Address is correct and has been connected. Finish the user's information given by the specified server. Click **OK** to save to add the new server in center management or **Cancel** to quit the setting.







If the port number has been changed in server end, please delete the server and set a new one.



- You will be prompted to click **OK** in the following window to into the **Camera Setup** window once one of the users of server has been deleted. About the instruction of the **Camera Setup**, please refer to **6.2.3 Camera Setup** section.

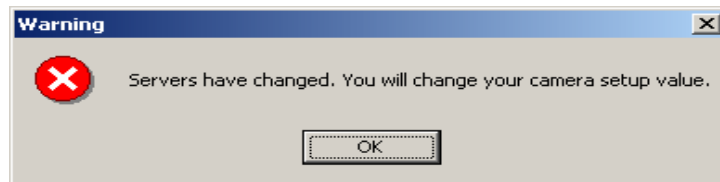

- Repeat the steps above to add a new server. The maximum numbers of server are limited in 16 for the 16 channels.



### 6.3.2 Playback

Once in the playback mode, users can view log files recorded in the local hard disks to show the following windows:

- Click **Playback** to display the screen below.
- From the cameras' list shown in time diagram, choose the desired camera folder first and the time folder by yy/mm/dd then.

Consequently, the files ranged within the selected time will be listed in time sequence in the file directory.



The files are located on the local computer so that only the enabled cameras by local user will be found in the file list.

- Highlight the file you want to review and use the buttons below to control the video playback.



**Playback**

Click this button to playback the selected file.



**Reverse Playback.**



**Pause**



**Move to Start**



**Move to End**



**Previous Frame**



**Next Frame**





**Slide Bar**

You can drag the slide bar directly to the frame you want to play.



**Zoom In/Out**

Click the buttons to zoom in or out the images.



**Image Quality**

You can adjust the brightness, contrast, hue and saturation.



**Print**

Click the button to print the current image.



**Save**

Use the playback panel to choose a desired frame and then click **Save** button.



**Delete**

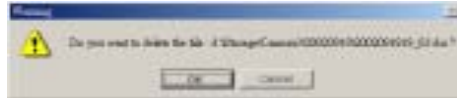

Click the button to delete the current file and make sure by clicking **Ok** button on the pop-up window.



**Backup**

When you review the log files, you can click this button to save the files onto your local disk.



### 6.3.3 PTZ Control

Once you have installed a PTZ camera, the functional utility will help you to exert the control on the surveillance.

To enable the function, follow with the steps below:

1. Click **PTZ Control** to show the following window:



2. Designate a channel **01** **02** ... **16** connected with PTZ camera for the further setting.



**Preset Position Setup**

Each PTZ camera can set 16 preset positions. You can move the camera to a desired preset position simply by clicking on the number of the preset position. To set a preset position, first select the number of the preset position and set the direction speed. Then configure the camera's position with the directional control buttons, focus in/focus out buttons, and zoom in/zoom out buttons. Finally set the stay time, rotation speed, and click the **Save** button.



**Direction Control**

Adjust the camera's direction with the following eight buttons; Up / Down / Left / Right / Upper Left / Bottom Left / Upper Right / Bottom Right.



### Direction Speed

There are four speeds to decide the moving speed of the PTZ camera during adjusting **Direction Control**



### Focus in

Decrease the focal length of the camera to focus on the image.



### Focus out

Increase the focal length of the camera to focus on the image.



### Zoom in

Zoom in to enlarge the image of the object.



### Zoom out

Zoom out to reduce the image of the object.



### Dwell (Sec)

During AutoPan, this button determines the time for the camera to stay (1~60 seconds) at one position before rotating to the next position.



### Rotation Speed (deg/s)

You can set the speed (5~255 deg/s) by the left and right arrows at which the camera rotates from its current position to the next preset position.



### Save

After you finish setting a preset position, you need to click this button to save it and go on to set the next preset position.



### Clear

Click this button to clear the setting for the current preset position.



### Group

Each PTZ camera has 4 groups to comply with the position sequences as follows:

Group 1: 1~4 positions

Group 2: 5~8 positions

Group 3: 9~12 positions

Group 4: 13~16 positions



### AutoPan

Choose a group number first, and click this button to enable this function.



### Back to Main Menu

Click here to back to main menu.



### 6.4 Start Recording

Manually enable the recording setting arranged in the **Schedule Recording** section by clicking this button. Meanwhile, the recording status is visible in the **Channel Status** field and **Start Recording** button will turn into transparent red.



### 6.5 Exit RemoteManager

Click this button to exit **RemoteManager**. First a password control window will prompt you to enter the password to make sure your authorization. Then a window below will appear to confirm your quit. Click **OK** to exit or **Cancel** to back to the system

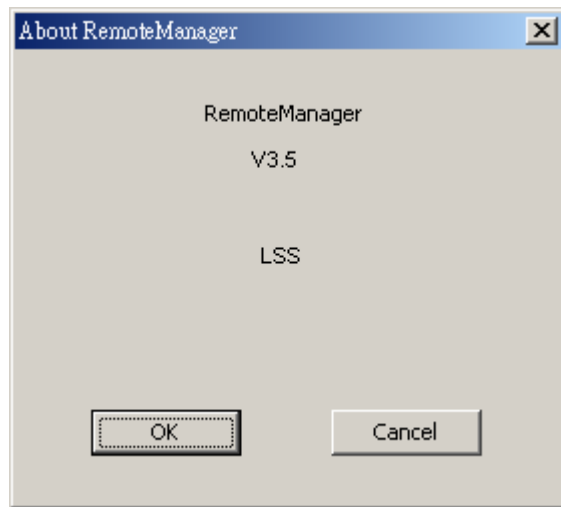

## Chapter 7 AVerMedia FAQs

1. Q: What is the limit for the length of the camera cable that is used to connect the camera to the LX5000 system?  
A: The maximum length is 150m for 5C coaxial cables. If a longer cable is needed, a repeater is required.
2. Q: What is the file size for each recorded image?  
A: The LX5000 system takes advantage of the most recent JPEG compression technology that reduces the size of a 320x240 image to 6~16K, depending on the image quality.
3. Q: What should I do when the hard disk runs out of space?  
A: LX5000 system uses auto-recycle processing which allows the system to continue in the event of a full disk by overwriting the older data.
4. Q: Can I use B/W cameras and color cameras together?  
A: Yes, you are allowed to concurrently use both on the LX5000 system as long as they are NTSC or PAL compliant.
5. Q: Apart from recording, what else can the LX5000 system do when an unauthorized person enters an office after hours? How can I take immediate action?  
A: The LX5000 system can be configured to call you via the phone system sending you pre-recorded voice messages. If you want to investigate the premises, you can easily remotely log into the LX5000 system through the Internet and retrieve synchronous images from the LX5000 system. You will be asked to identify yourself with your ID and password.
6. Q: What is the display rate when remotely viewing images?  
A: It really depends on the bandwidth of your Internet connection. Normally the frame rate is 1~5 fps with a LAN, 1~3 fps with ADSL, and less than 1 fps with a modem.

7. Q: Why can't I add a new mask?  
A: You cannot add a new mask when previous masks are hidden.
8. Q: Do you offer a development kit for the LX5000 system?  
A: We will provide Center SDK in the near future.
9. Q: Does LX5000 system record audio?  
A: Not for the moment, but the audio functionality is in development.
10. Q: How can I back up files?  
A: You can mount the backup hard disk or RAID disk array through Adaptec's SCSI card.
11. Q: Why it does it always record when I use a B/W camera configured with motion detection mode?  
A: The motion detection sensitivity in the Recording Setup page defaults to a color camera. You need to change the camera type to be a B/W camera.
12. Q: Why does the camera name disappear from the screen?  
A: Simply click on the camera name (upper left corner) again and it will show up.
13. Q: Are there any special considerations when using RAID to back up my files?  
A: Remember to terminate the SCSI chain with a terminator. Also when you change the number of the hard disks, or when you swap them, you need to reset the system configuration or format the hard disk.

## Appendix A Registering Domain Name on DDNS Server

DDNS (Dynamic Domain Name Service), a data query service chiefly used on Internet for translating domain names into Internet addresses. It is allowed the remote clients intelligently search dynamic servers without any previous enquiring for servers' Internet addresses.

In order to take advantage of the intelligent service, please first register your domain name on the website: [ddns.avers.com.tw](http://ddns.avers.com.tw)

### 1. User Login

Browse the website [ddns.avers.com.tw](http://ddns.avers.com.tw) with Microsoft IE or Netscape Navigator to access the following dialogue.



First input the serial number of your product and select the product name. Then click **OK** to login or **Reset** to clear the previous input.

### 2. Password

set a password to secure your identification.



3. **User Information**

Please provide the following user information, **Host Name**, **Password**, **E-mail**, **Company**, and **Country** to complete the registration procedures.

**i** Note that Host Name and Domain Name (AVerMedia.avers.com.tw) are the replacement for Internet address while a remote client tends to search a dynamic server.



## Appendix B Image Verification

System already includes ImageVerify program in the system CD. After installation or copying ImageVerify program file, **follow these steps to install and run ImageVerify program:**

1. Open the "tools" folder in Digital video surveillance system CD.
2. Copy ImageVerify.tar.gz to hard drive.
3. Un-zip the file.
4. Execute the ImageVerify program.

### Using Image Verification program for Linux

Follow the steps to verify image file

#### a. setup/start program



#### b. Load the image file. Click "open" button to start verifying file

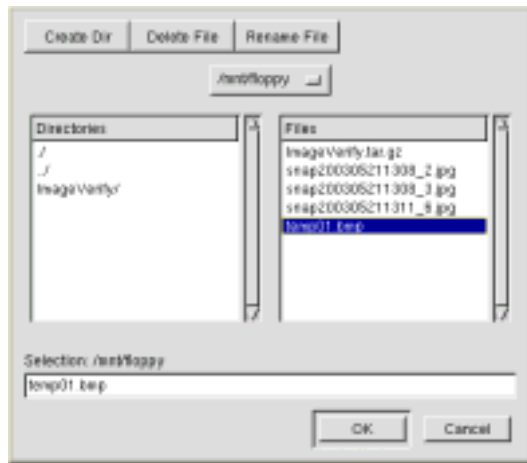

This program can only verify un-compressed bmp image file

**C. verify image file. Click 'verify' button to begin the process**



**D. result**

(1) If file is not modified, same picture will show in the right side result picture box



(2) If the file is modified, it will display a warning dialog box. In result box, it will highlight the area which is been changed.

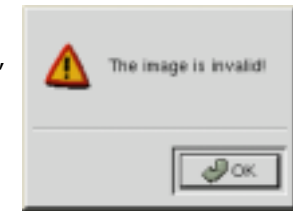

**Using ImageVerify program in Window 98SE / ME / 2000 Pro / XP Pro**

environment

If you are using Windows 98SE / Me / 2000 Pro / XP Pro system, please open 'tools' folder in Digital video surveillance system CD and execute 'ImageVerification.exe' to start the program.

**a. setup/start program**

Installation / Run After install digital video surveillance system in Windows 98SE / ME / 2000 Pro / XP Pro, click start->program files->digital video surveillance system ->Image Verification to execute the program.

After the installation, you can open installed folder, copy this file 'ImageVerification.exe' and run on other computer.

**b. Load the image file to start verifying file**

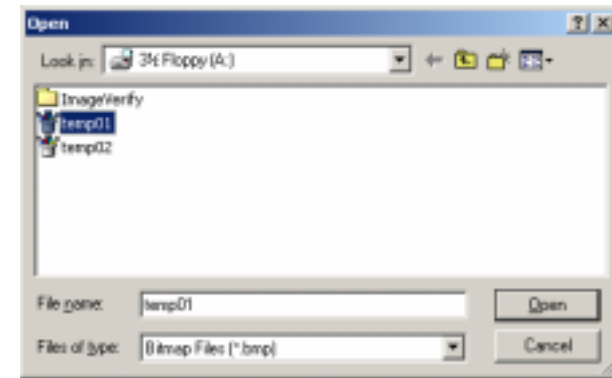
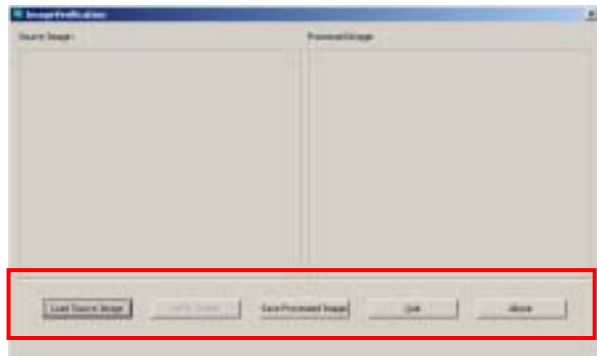

This program can only verify un-compressed bmp image file

**c. verify image file. Click 'verify' button to begin the process**



**D. result**

- (1) If file is not modified, same picture will show in the right side result picture box



- (2) If the file is modified, it will display a warning dialog box. In result box, it will highlight the area which is been changed.

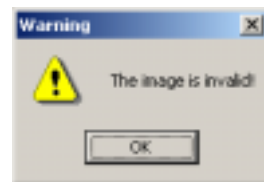

## Appendix C Remote Login with an Modem-to-Modem Connection

To run RemoteManager over a direct Modem-to-Modem connection between the Linux server and the remote client, follow the instructions in the section of the operating system you are using.

### A. Windows 98SE / Windows Me

- Go to **Start** → **Programs** → **Accessories** → **Communications** and click **Dial-up Networking**. Double-click **Make New Connection** to bring up the **Make New Connection** wizard. Enter the server's name and select the ISDN device you are using. Click the **Next** button to continue.

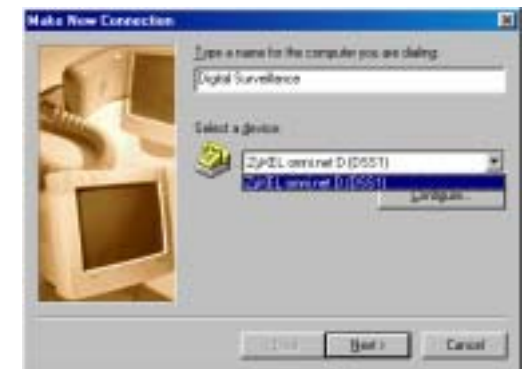

- Provide the server's telephone number, including the area code, and click the **Next** button to finish creating the new connection.





- Go back to the **Dial-up Networking** window and double-click the connection you just created. In the **Connect to** dialog box, enter any User name and the Password set in step F of the server's ISDN setup procedure.

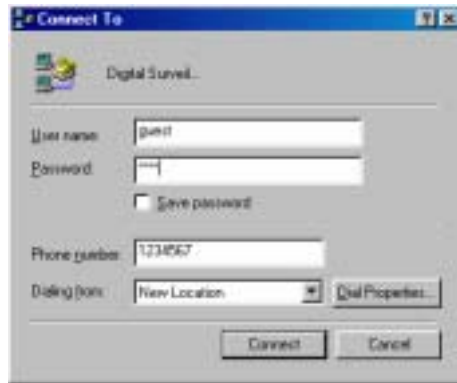

Click **Connect** to

start connecting to the LX5000 server.

- After you get connected, access **Start → Programs → Digital Video Surveillance System → RemoteManager** to launch RemoteManager. Refer to Chapter 6 RemoteManager to login. (Default IP address: 192.168.55.1)

## B. Windows 2000

- Go to **Start → Programs → Accessories → Communications** and click **Network and Dial-up Connections**. In the **Network and Dial-up Connections** window, double-click **Make New Connection** to



bring up the **Network Connection Wizard**. Click the **Next** button.

- Select **Dial-up to private network** and click the **Next** button.



- Provide the server's telephone number, including the area code, and click the **Next** button.



- Select **For all users** and click the **Next** button.



- Click the Finish button to complete the connection setup.



- Go back to the Network and Dial-up Connections window and double-click the connection you just created. In the dialog box, enter any User name and the Password set in step E of the server's ISDN setup procedure. Click **Dial** to start connecting to the LX5000 server.



- After you get connected, access Start → Programs → Digital Video Surveillance System → RemoteManager to launch RemoteManager. Refer to Chapter 6 RemoteManager to login.

### C. Windows XP

- Go to Start → Programs → Accessories → Communications and click New Connection Wizard. Click the Next button.



- Select Connect to the Internet and click the Next button.



- Select Set up my connection manually and click the Next button.

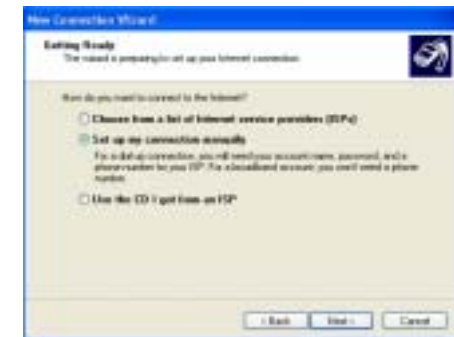

- Select Connect using a dial-up modem and click the Next button.



- Enter the name of this connection and click the Next button.

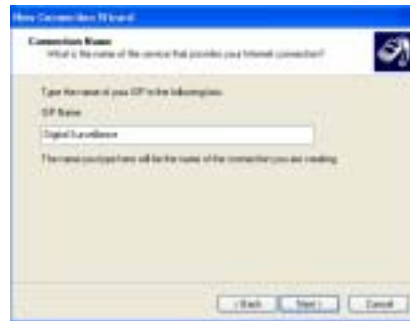

- Provide the server's telephone number, including the area code, and click the Next button.



- Enter any User name and the Password set in step F of the server's ISDN setup procedure. Click the Next button to continue.

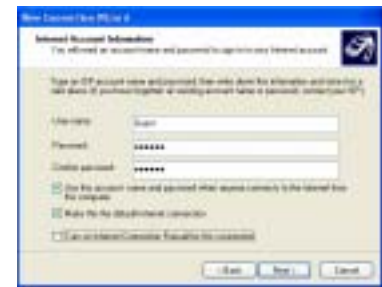

- Click the Finish button to complete the connection setup.

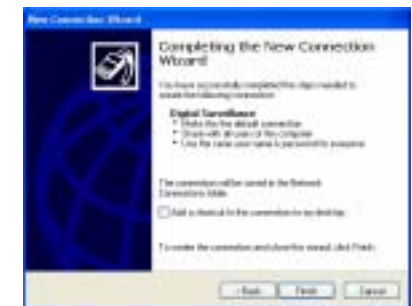

- Go to Start → Programs → Accessories → Communications and click Network Connections. Double-click the connection you just created. In the dialog box, enter any User name and the Password set in step F of the server's ISDN setup procedure. Click  to start connecting to the LX5000 server.



After you get connected, access Start → Programs → Digital Video Surveillance System → RemoteManager to launch RemoteManager. Refer to Chapter 6 RemoteManager to I

## Limited Warranty

**AVerMedia TECHNOLOGY, Inc.** warrants that this product to be free of defects resulting from faulty manufacturing or components under the following terms:

### WARRANTY LENGTH

Labor is warranted for 15 months from the date of purchase. Replacement products will be warranted for the remainder of the 15-month warranty period or 30 days, whichever is longer.

### WHO IS PROTECTED

This warranty is enforceable only by the first consumer purchaser.

### WHAT IS AND IS NOT COVERED

Except as specified below, this warranty covers all defects resulting from faulty manufacturing of this product. The following are not covered by the warranty.

1. Any product on which the serial number has been defaced, modified, or removed.
2. Damage, deterioration, or malfunction resulting from:
  - A. Accident, abuse, misuse, neglect, fire, water, lightning, or other acts of nature, commercial or industrial use, unauthorized product modification, or failure to follow instructions included with the product.
  - B. Misapplication of service by someone other than the manufacturer's representative.
  - C. Any shipment damages. (Claims must be made with carriers.)
  - D. Any other cause that does not relate to a product defect.
3. Cartons, cases, batteries, cabinets, tapes, or accessories used with the product.
4. **AVerMedia TECHNOLOGY, Inc.** does not warrant that this product will meet your requirements; it is your responsibility to determine the suitability of this product for your purpose.

### WHAT WE WILL AND WILL NOT PAY FOR

We will pay labor and material expenses for covered items. However, we will not pay for the following:

1. Removal or installation charges.
2. Shipping charges.
3. Any incidental charges.

### EXCLUSION OF DAMAGES

THE MANUFACTURER'S SOLE OBLIGATION AND LIABILITY UNDER THIS WARRANTY IS LIMITED TO THE REPAIR OR REPLACEMENT OF A

DEFECTIVE PRODUCT AT OUR OPTION. THE MANUFACTURER SHALL NOT, IN ANY EVENT, BE LIABLE TO THE PURCHASER OR ANY THIRD PARTY FOR ANY INCIDENTAL OR CONSEQUENTIAL DAMAGE (INCLUDING, BUT NOT LIMITED TO, DAMAGES RESULTING FROM INTERRUPTION OF SERVICE AND LOSS OF BUSINESS) OR LIABILITY LIMITATIONS OF IMPLIED WARRANTIES.

There are no other oral or written warranties, expressed or implied, including but not limited to those of merchantability or fitness for a particular purpose. Any implied warranties are limited in duration to 15 months from the date of purchase.

### STATE LAW AND YOUR WARRANTY

This warranty gives you specific legal rights, and you may also have other rights granted under state law. These rights vary from state to state.

### CONTACT INFORMATION

Taiwan & International  
 No. 135, Jian Yi Rd., Chung Ho, Taipei, Taiwan, R.O.C.  
 Tel: 886-2-22263630  
 Fax: 886-2-32344842  
 Web Site: [www.AVerMedia.com.tw](http://www.AVerMedia.com.tw)

## Free Manuals Download Website

<http://myh66.com>

<http://usermanuals.us>

<http://www.somanuals.com>

<http://www.4manuals.cc>

<http://www.manual-lib.com>

<http://www.404manual.com>

<http://www.luxmanual.com>

<http://aubethermostatmanual.com>

Golf course search by state

<http://golfingnear.com>

Email search by domain

<http://emailbydomain.com>

Auto manuals search

<http://auto.somanuals.com>

TV manuals search

<http://tv.somanuals.com>