



Model: DV7300

HOME THEATER

350 Watt 1-2-3 2.1 Channel Home Theater System



OPERATING INSTRUCTIONS

FOR ASSISTANCE CALL CUSTOMER SERVICE AT 1-800-645-4994
OR VISIT US AT WWW.AUDIOVOX.COM

128-8108

SAFETY PRECAUTIONS

The following marks and symbols are located on back of the unit.

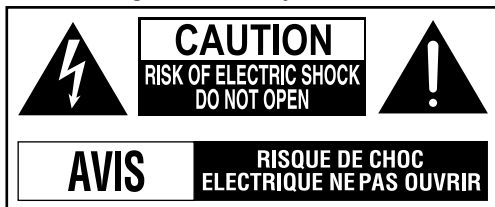

 The lightning flash with an arrowhead symbol, within the equilateral triangle, is intended to alert the user to the presence of uninsulated "dangerous voltage" within the product's enclosure that may be of sufficient magnitude to constitute a risk of electric shock to persons.

 The exclamation point within the equilateral triangle is intended to alert the user to the presence of important operating and maintenance (servicing) instructions in this owner's manual.

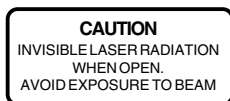



 **WARNING:**

- TO REDUCE THE RISK OF FIRE OR ELECTRIC SHOCK, DO NOT REMOVE COVER (OR BACK). NO USER-SERVICEABLE PARTS INSIDE. REFER SERVICING TO QUALIFIED SERVICE PERSONNEL.
- TO PREVENT FIRE OR SHOCK HAZARD, DO NOT EXPOSE THIS APPLIANCE TO RAIN OR MOISTURE.

CAUTIONS:

- USE OF CONTROLS OR ADJUSTMENTS OR PERFORMANCE OF PROCEDURES OTHER THAN THOSE SPECIFIED MAY RESULT IN HAZARDOUS RADIATION EXPOSURE.
- TO PREVENT ELECTRIC SHOCK, MATCH WIDE BLADE OF PLUG TO WIDE SLOT OF AC POWER OUTLET, THEN FULLY INSERT.

 This product contains a low power laser device.

 The symbol for Class II (Double Insulation)

On Placement

- Do not use the unit in places which are extremely hot, cold, dusty, or humid.
- Do not restrict the air flow of the unit by placing it in a place with poor air flow, by covering it with a cloth, or by placing it on carpeting.

On Safety

- When connecting or disconnecting the AC cord, grip the plug and not the cord itself. Pulling the cord may damage it and create a hazard.

On Condensation

- When left in a heated room where it is warm and damp, water droplets or condensation may form inside the unit. When there is condensation inside the unit, the unit may not function normally. Let the unit stand for 1 to 2 hours before turning the power on, or gradually heat the room and allow the unit to dry before use.

FCC Information

This device complies with Part 15 of the FCC rules. Operation is subject to the following two conditions:

- (1) This device may not cause harmful interference, and
- (2) This device must accept any interference received, including interference that may cause undesired operation.

NOTE: This equipment has been tested and found to comply with the limits for a Class B digital device, pursuant to part 15 of the FCC Rules. These limits are designed to provide reasonable protection against harmful interference in a residential installation. This equipment generates, uses, and can radiate radio frequency energy and, if not installed and used in accordance with the instructions, may cause harmful interference to radio communications. However, there is no guarantee that interference will not occur in a particular installation. If this equipment does cause harmful interference to radio or television reception, which can be determined by turning the equipment off and on, the user is encouraged to try to correct the interference by one or more of the following measures:

SAFETY PRECAUTIONS

- Reorient or relocate the receiving antenna.
- Increase the separation between the equipment and receiver.
- Connect the equipment into an outlet on a circuit different from that to which the receiver is connected.
- Consult the dealer or an experienced radio/TV technician for help.

This Class B digital apparatus complies with Canadian ICES-003.

Shielded cables must be used with this unit to ensure compliance with the Class FCC limits.



WARNING: Changes or modifications to this unit not expressly approved by the party responsible for compliance could void the user authority to operate the equipment.

Notes on Copyright

It is forbidden by law to copy, broadcast, show, broadcast on cable, play in public, or rent copyrighted material without permission.

Apparatus Claims of U.S. Patent Nos. U.S. Patent Nos. 4,907,093; 5,315,448; and 6,516,132 licensed for limited viewing uses only.

This product incorporates copyright protection technology that is protected by U.S. patents and other intellectual property rights. Use of this copyright protection technology must be authorized by Macrovision, and is intended for home and other limited viewing uses only unless otherwise authorized by Macrovision. Reverse engineering or disassembly is prohibited.

IMPORTANT SAFETY INSTRUCTIONS

1. Read these instructions.
2. Keep these instructions.
3. Heed all warnings.
4. Follow all instructions.
5. Do not use this apparatus near water.
6. Clean only with a dry cloth.
7. Do not block any of the ventilation openings. Install in accordance with the manufacturer's instructions.
8. Do not install near any heat sources such as radiators, heat registers, stoves, or other apparatus (including amplifiers) that produce heat.
9. Do not defeat the safety purpose of the polarized or grounding-type plug. A polarized plug has two blades with one wider than the other. A grounding type plug has two blades and a third grounding prong. The wide blade or the third prong are provided for your safety. When the provided plug does not fit into your outlet, consult an electrician for replacement of the obsolete outlet.
10. Protect the power cord from being walked on or pinched particularly at plugs, convenience receptacles, and the point where they exit from the apparatus.
11. Only use attachments/accessories specified by the manufacturer.
12. Use only with a cart, stand, tripod, bracket, or table specified by the manufacturer, or sold with the apparatus. When a cart is used, use caution when moving the cart/apparatus combination to avoid injury from tip-over.
13. Unplug this apparatus during lightning storms or when unused for long periods of time.
14. Refer all servicing to qualified service personnel. Servicing is required when the apparatus has been damaged in any way, such as the power-supply cord or plug is damaged, liquid has spilled or objects have fallen into the apparatus, the apparatus has been exposed to rain or moisture, does not operate normally, or has been dropped.



Portable Cart Warning

TABLE OF CONTENTS

Safety Precautions	1-2	Repeat Playback	16
Important Safety Instructions	2	DVD Programmable Memory	17
Table of Contents	3	Viewing JPEG Files	17
Disc Formats	4	Play Modes for CD or JPEG Disc	18
Accessories	5	Customizing the Function Settings	19-21
Remote Control	5	LANGUAGE	19
Control Reference Guide	6-7	VIDEO	19
Display	8	AUDIO	21
Setup	9-11	DEFAULT	21
Connecting the FM Antenna Wire	9	Listening to the Radio	21
Connecting Your TV	9	Trouble Shooting Guide	22
Connecting a VCR	10	Maintenance	23
Connecting Other Equipment (Amplifier)	10	Specifications	23
Connecting the Speakers & Subwoofer	11		
Positioning the Speakers & Subwoofer	11		
Plugging in the Unit	11		
Turning on the Unit and TV	12		
Connecting External Equipment via the AUX IN Jack	12		
Sound System	12		
Playing a Disc	13-14		
Playing a Disc	13		
Pausing Playback	13		
Stopping Playback	13		
Skipping to a Different Chapter/Track	13		
Fast Forward/Fast Reverse	13		
Slow-motion Play	13		
Angle Selection	14		
Subtitle Selection	14		
Audio Selection	14		
Display Function	14		
Special Functions	15		
Locating a Specific Title/Chapter/Time	15		
Locating a Specific Track	15		
Setting Favorite Bookmark During Playback	15		

DISC FORMATS

The unit can play:



DVDs
[8cm/12cm disc]



CD-R CD-RW

Compatible



Audio CDs
[8cm/12cm disc]

Region Management Information

Region Management Information: This unit is designed and manufactured to respond to the Region Management Information that is encoded on DVDs. If the region number printed on the DVD does not correspond to the region number of this unit, this unit cannot play that disc.



The region number of this unit is 1.

Disc Function or Operation that is Not Available

When the "Ⓢ" symbol appears on the screen, it indicates that the function or operation attempted is not available at that time. This occurs because the DVD manufacturer determines the specific functions. Certain functions may not be available on some discs. Be sure to read the documentation provided with the DVD.

Icons Used on DVDs

Sample Icons

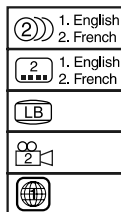

Language selections for audio

Language selections for subtitles

Screen aspect ratio

Multiple camera angles

Region code indicator

Note:

- When playing a CD-G (Graphics) or CD EXTRA disc, the audio portion will be played, but the graphic images will not be shown.

Titles, Chapters and Tracks

- DVDs are divided into "titles" and "chapters". If the disc has more than one movie on it, each movie would be a separate "title". "Chapters" are sections of titles.
- Audio CDs are divided into "tracks". A "track" is usually one song on an Audio CD.

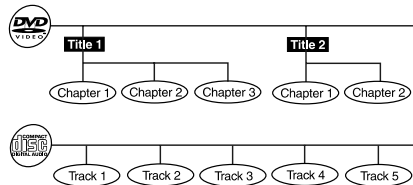

Note : Numbers identify each title, chapter, and track on a disc. Most discs have these numbers recorded on them, but some do not.

Notes on Unauthorized Discs

You may not be able to play back some DVDs on this unit if they were purchased from outside your geographic area or made for business purposes.

ACCESSORIES

Please check and identify the included accessories.

- Remote Control x 1
- AAA 1.5V Battery (for remote control) x 2
- FM Wire Antenna x 1
- AV Cable x 1
- Quick Connect Guide x 1
- Warranty Card x 1

REMOTE CONTROL

Using the Remote Control

- Point the remote control at the REMOTE SENSOR located on the unit.
- When there is a strong ambient light source, the performance of the infrared REMOTE SENSOR may be degraded, causing unreliable operation.
- The recommended effective distance for remote operation is about 16 feet (5 meters).

To Install Batteries

1. Open the battery door.

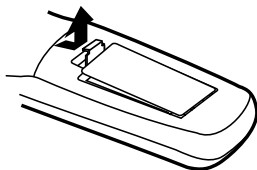

2. Insert two AAA batteries.

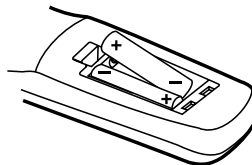

Battery Replacement

When the batteries become weak, the operating distance of the remote control is greatly reduced and you will need to replace them.

CAUTION: Danger of explosion if battery is incorrectly replaced. Replace only with the same or equivalent type.

Notes:

- If the remote control is not going to be used for a long time, remove the batteries to avoid corrosion damage caused by battery leakage.
- Do not mix old and new batteries. Do not mix ALKALINE, standard (CARBON-ZINC) or rechargeable (NICKEL-CADMIUM) batteries.
- Always remove batteries as soon as they become weak.
- Weak batteries can leak and severely damage the remote control.
- **WARNING:** Do not dispose of batteries in a fire. Batteries may explode or leak.

CONTROL REFERENCE GUIDE

Remote Control

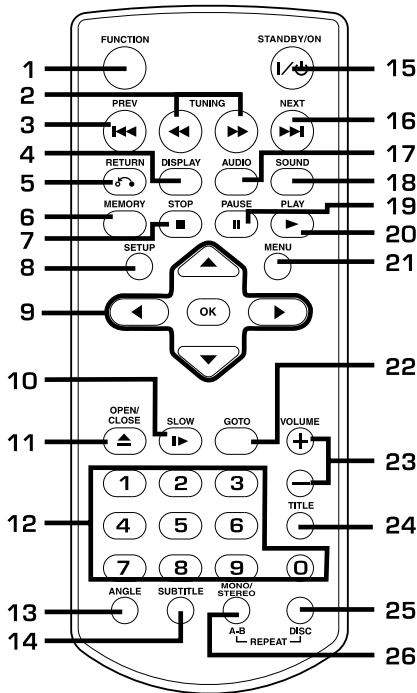

1) FUNCTION Button

Press to switch between DVD, AV IN, AUX and Radio.

2) ◀▶ TUNING Buttons

◀▶ : Fast reverse playback.

▶▶ : Fast forward playback.

◀▶TUNING▶▶ : Scan all available radio stations.

3) ◀◀ PREV Button

Press to move backwards through titles, chapters or tracks on a disc.

Tune to preset stations.

4) DISPLAY Button

Press to change disc status information displayed on the TV screen.

5) RETURN Button

Press to return to the normal operation after using the SETUP menu.

6) MEMORY Button

Press to create programs.

7) ■ STOP Button

Press to stop playback.

8) SETUP Button

Press to open and close the SETUP menu screen.

9) CURSOR (▲, ▼, ◀, ▶) Buttons

Press to highlight selections on a menu screen and adjust certain settings.

OK Button

Press to confirm selections on a menu screen.

10) ▶ SLOW Button

Press to perform slow forward playback of DVDs.

11) ▲ OPEN/CLOSE Button

Press to open or close the disc tray.

12) Number (0-9) Buttons

13) ANGLE Button

Press to switch the camera angle of the video presentation when scenes with multiple camera angles are recorded on a DVD.

14) SUBTITLE Button

Press to select one of the subtitle languages programmed on a DVD.

15) I/⏻ STANDBY/ON Button

Press to turn on the unit and put it in standby mode.

16) NEXT ▶▶ Button

Press to move forward through titles, chapters or tracks on a disc.

Tunes to preset stations.

17) AUDIO Button

Press to select one of the audio sound tracks programmed on a DVD or to select the audio output mode on an AUDIO CD.

18) SOUND Button

Press to select sound balance and tone controls for adjustment with the cursor buttons.

19) || PAUSE Button

Press to pause playback, frame advance.

20) ▶ PLAY Button

Press to start playback.

21) MENU Button

Press to open and close DVD's menu.

22) GOTO Button

Press to skip directly to a specific location on a DVD.

23) VOLUME +/- Buttons

Press to adjust the volume levels.

24) TITLE Button

Press to open the Title Menu screen in stop mode.

25) REPEAT-DISC Button

Press to repeat chapter or title of a DVD.

Press to repeat single track or whole CD.

26) MONO/STEREO Button

Press to set FM mode to MONO or STEREO sound.

REPEAT A - B Button

Press to perform point-to-point repeat playback on a DVD or CD.

CONTROL REFERENCE GUIDE

Unit (Front Panel)

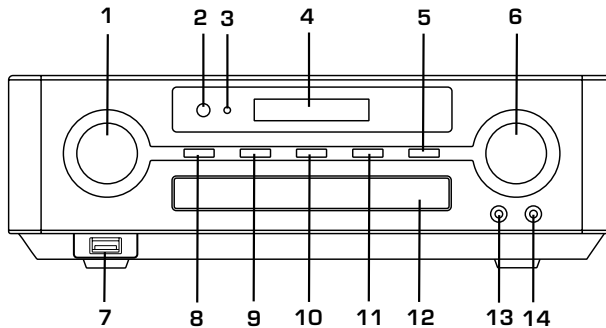

1) **◀ TUNING/SKIP ▶ Control**

DVD Mode

Press quickly to select the previous/next title, chapter or track on a disc; Press and hold for fast forward/reverse playback.

RADIO Mode

Press quickly to select preset radio stations. Press and hold to scan all available stations.

2) **Remote Sensor**

Receives the remote control unit signals.

3) **STANDBY Indicator**

Indicates whether the unit is ON or in STANDBY mode.

Indicator ON : The unit is on STANDBY.

Indicator OFF : The unit is turned ON.

4) **Display Window**

Displays system information.

5) **▲ OPEN/CLOSE Button**

Opens/closes the disc tray.

6) **VOLUME +/- Control**

Adjusts the volume level.

7) **USB Port**

Use to charge other equipment (such as a MP3 player-not included).

8) **⏻ STANDBY/ON Button**

Turns on the unit and puts it in standby mode.

9) **▶ PLAY Button**

Starts or resumes playback of a disc.

10) **■ STOP Button**

Stops playing a disc.

11) **FUNCTION Button**

Switches between DVD, AV IN, AUX and Radio.

12) **Disc Tray**

Opens or closes the tray by pressing the OPEN/CLOSE button.

13) **Earphone Jack**

14) **AUX IN Jack**

For connecting external equipment, such as a MP3 player (not included).

Unit (Rear Panel)

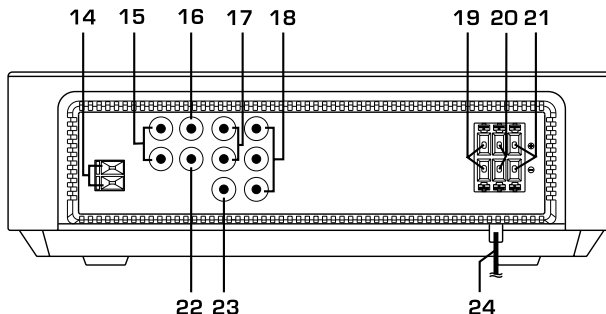

14) **FM Antenna Terminals**

15) **Left/Right AUDIO OUT Jacks**

16) **DIGITAL AUDIO OUT Jack**

17) **Left/Right AUDIO IN Jacks (AV-IN)**

18) **COMPONENT VIDEO OUT Jacks**

(Y, P_B & P_R)

19) **Right Speaker Terminals**

20) **SUBWOOFER Terminals**

21) **Left Speaker Terminals**

22) **VIDEO OUT Jack**

23) **VIDEO IN (VCR) Jack (AV-IN)**



24) **Power Cord**

DISPLAY

Display Information

The DVD displays the information shown below on the TV screen and on the unit's DVD display depending on the operation status.

Display Examples

	TV Screen	Unit Display	Remarks
If no disc is loaded when the main unit is powered on.	No Disc	<i>NO</i>	"NO" appears when the tray is closed and: 1) There is no disc in the tray. 2) The disc type is not playable in this unit. 3) The disc is not loaded correctly (upside-down, etc.)
Tray open	▲ Open	<i>OPEN</i>	
Tray closed	▲ Close	<i>CLOSE</i>	
Loading	 Loading	<i>LOAD</i>	
Stopped	■ Stop		The display changes to show other indicators (total time, etc.)
Playing	▶ Play		
Paused	 Pause		Freezes the image on the screen or pauses audio playback.
Fast forward	▶▶ x 2		The display changes to show other indicators (total time, etc.)
Fast reverse	◀◀ x 2		
Slow	▶▶ 1/2		Does not function for Audio CDs.
Repeat A - B	Rep A- Rep A - B		Repeat a specific section
			The operation is not permitted by the DVD unit or the disc.

Region (Local) Number Error Indicator

If the region (local) number of the disc that you attempt to play differs from the region number of the Unit. "Disc region incorrect" appears on the TV screen. (The disc cannot be played).

SETUP

Connecting the FM Wire Antenna

Connect the FM wire antenna to the FM antenna terminals. Fully unwind the wire antenna and position it for the best reception.

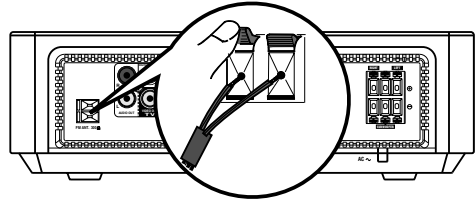

A. Connecting your TV

The unit can be connected to your TV in several different ways, depending on the design of your TV.

RCA AUDIO/VIDEO JACKS

Use the Audio/Video cable (supplied). Connect the VIDEO OUT and left/right AUDIO OUT jacks on the unit to the VIDEO IN and left/right AUDIO IN jacks on your TV.

Note: If you only want sound to come from the speakers of the main unit do not connect the left/right AUDIO OUT jacks from the main unit to your TV.

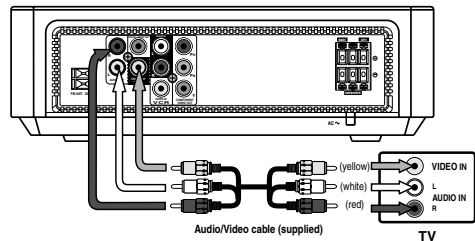

or

Use the Audio/Video cable (supplied). Connect the VIDEO OUT and left/right AUDIO IN jacks on the unit to the VIDEO IN and left/right AUDIO OUT jacks on your TV.

Note: During DVD playback, the sound only comes from the speakers of the main unit.

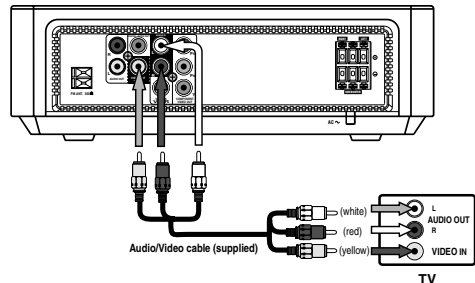

or

COMPONENT VIDEO OUTPUT (DVD)

Some TVs or monitors are equipped with component video inputs.

Using an audio cable (not supplied), connect the left/right AUDIO OUT jacks on your unit to the left/right AUDIO IN jacks on your TV. Using a component video cable (not supplied), connect the Y VIDEO OUT jack (green plug) on your unit to the Y VIDEO IN jack on your TV, the P_B VIDEO OUT jack (blue plug) on your unit to the P_B VIDEO IN jack on your TV and the P_R VIDEO OUT jack (red plug) on your unit to the P_R VIDEO IN jack on your TV to view the highest quality picture playback.

PROGRESSIVE OUTPUTS (DVD)

Some TVs or monitors are equipped with Component Video inputs that are capable of reproducing a progressively scanned video signal.

SETUP

Press the **SETUP** button and select Video Out to P-Scan (see page 20).

Attention:

- Make sure your TV can support a progressive scan component video signal.

Notes :

- Connect the unit directly to your TV. If you connect the unit through a VCR, the playback picture will be distorted because DVDs are copy protected.
- When you connect the unit to other equipment, be sure to turn off the power and unplug all of the equipment from the wall outlet before making any connections.
- Refer to the instruction manual of the connected equipment as well.

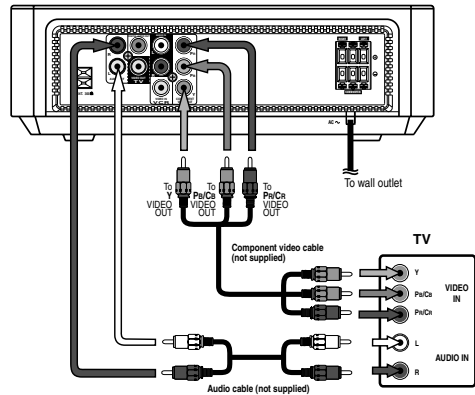

B. Connecting a VCR

1. Using the supplied Audio/Video cable, connect the yellow plug from the VIDEO OUT jack on your unit to the VIDEO IN jack on your TV. Connect the left and right AUDIO OUT jacks on your unit to the AUDIO IN jacks on your TV. If you want the sound to come from the speakers of the main unit do not connect the left and right audio cable from the main unit to your TV.
2. Using a video cable (not supplied), connect the VIDEO IN (VCR) jack on your unit to the VIDEO OUT jack on your VCR.
3. Using an audio cable (not supplied), connect the left/right AUDIO IN jacks on your unit to the AUDIO OUT jacks on your VCR.

WATCHING A VIDEOTAPE

1. Turn on the unit. Use the **FUNCTION** button on the remote control or the front panel to select "AV IN".
2. Turn on your TV and follow the instructions included with it to select the VIDEO function which corresponds to the VIDEO IN jack that is connected to the main unit.
3. Turn on the VCR and follow the instructions included with it to play the videotape.

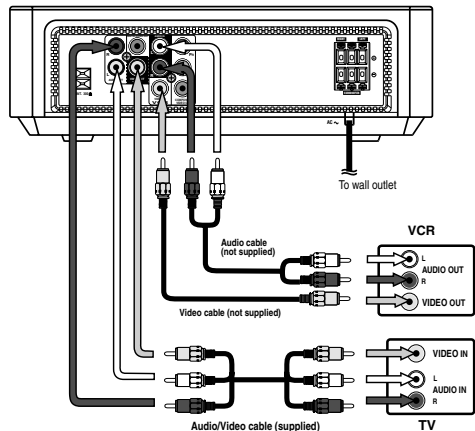

C. Connecting Other Equipment (Amplifier)

ANALOG CONNECTION

Using an audio cable (not supplied), connect the left/right AUDIO OUT jack on your unit to the AUDIO IN jack on your other source.

DIGITAL CONNECTION

Using a coaxial digital audio cable (not supplied), connect the DIGITAL AUDIO OUT jack on your unit to the DIGITAL AUDIO IN jack on your other source.

SETUP

LISTENING TO ANOTHER AUDIO EQUIPMENT

1. Turn on the unit.
2. Turn on your audio equipment and follow the instructions included with it to select the AUDIO IN or DIGITAL IN function.

Notes:

- When you connect the unit to other equipment, be sure to turn off the power and unplug all of the equipment from the wall outlet before making any connections.
- If the external equipment is a television and this audio system is close to it, you may experience interference if the tuner function is selected while the television is working.
- If you have a stereo VCR, ensure you set it to STEREO mode.
- Due to copyright protection, DVD movies cannot be copied. If you copy a DVD movie onto a videotape, the resulting copy will be unclear, with poor sound quality. This is NOT caused by a defective DVD system.
- Refer to the instruction manual of the connected equipment as well.

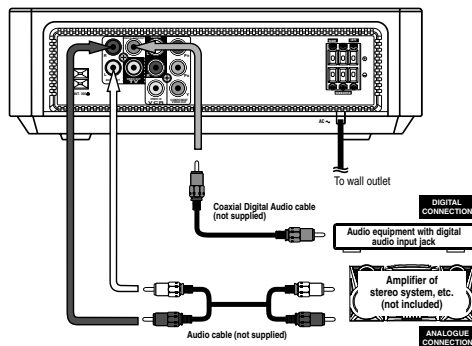

D. Connecting the Speakers & Subwoofer

Plug the POSITIVE (+) and NEGATIVE (-) ends of each speaker wire into the corresponding jacks on the rear of the Unit, matching the color tube on the end of the speaker wire to the color-coded connector.

E. Positioning the Speakers and Subwoofer

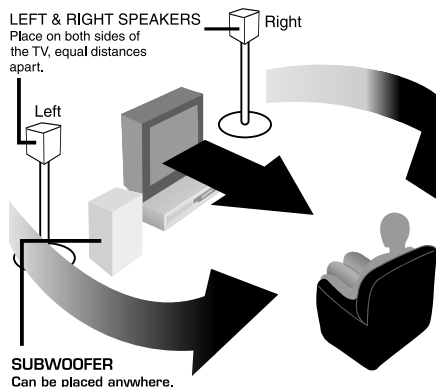
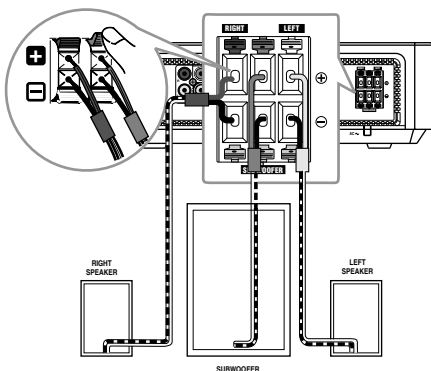

Plugging in the Unit

- Ensure all the components and speakers are connected correctly.
- TO PREVENT ELECTRICAL SHOCK, MATCH WIDE BLADE OF PLUG TO WIDE SLOT OF WALL OUTLET, THEN FULLY INSERT.
- Be sure the AC power cord is disconnected and all functions are off before making connections.
- When you are not going to use the unit for a long period of time, disconnect the power cord.

SETUP

Turning on the Unit and TV

When the unit is plugged in, it is in standby mode and the standby indicator lights up.

1. Press the **⏻ STANDBY/ON** button to turn the unit on.
 2. Turn on the TV by pressing its POWER button.
 3. Select the channel on your TV corresponding to the VIDEO IN jack that the unit is connected to. See TV User Guide for more information.
- If you have connected the unit successfully, the DVD logo (start-up picture) will appear on your TV screen.

Notes :

- Press the **⏻ STANDBY/ON** button to switch to STANDBY (OFF) mode and the standby indicator will light up.
- Whenever there is no disc in the unit or the disc has stopped playing for 60 minutes, the system will switch to STANDBY mode automatically.

Connecting External Equipment via the AUX IN jack

To listen to audio from external equipment, connect the plug to the AUX IN jack on the front panel.

LISTENING TO THE CONNECTED EQUIPMENT

1. Press the **FUNCTION** button repeatedly to select AUX.
2. Play the external source.

Charging Other Equipment

1. Press the **⏻ STANDBY/ON** button to turn the unit on.
2. Use the USB cable (not included), connect the **USB (CHARGING ONLY)** port on the unit to the USB charging port on the other equipment.
3. Follow the instructions come with your other equipment to charge it. Disconnect the USB cable when the other equipment is fully charged.

Notes:

- Make sure your other equipment can be charged by its USB port.
- The **USB (CHARGING ONLY)** port is for charging other equipment only. Do not use it for other purpose.

SOUND SYSTEM

To Adjust the Sound Balance

Use the remote control to make the following changes to speaker balance:

LEFT SPEAKER

- Press the SOUND button repeatedly to display " L ", then press the **▲** or **▼** on the remote to adjust the sound level. It will show on the display of the unit.

RIGHT SPEAKER

- Press the SOUND button repeatedly to display " R ", then press the **▲** or **▼** button on the remote to adjust the sound level. It will show on the display of the unit.

SUBWOOFER

- Press the SOUND button repeatedly to display " S ", then press the **▲** or **▼** button on the remote to adjust the sound level. It will show on the display of the unit.

Note: If no button is pressed within a few seconds, the display will return to normal.

Dolby Digital

Dolby Digital is a technology developed by Dolby Laboratories. Soundtracks encoded in Dolby Digital can reproduce from one to 5.1 discrete channels of excellent quality audio.

The unit automatically recognizes the Dolby Digital bitstream and provides a downmix suitable for two-channel listening. An additional Dolby Digital decoder is required for reproduction of the discrete multi-channel soundtracks available on many DVDs.





Manufactured under license from Dolby Laboratories.





'Dolby' and  the double-D symbol are trademarks of Dolby Laboratories.

PLAYING A DISC



This owner's manual explains the basic instructions of this unit. Some DVDs are produced in a manner that allows specific or limited operation during playback. Such as, the unit may not respond to all operating commands. This is not a defect in the unit. Refer to the instruction notes of discs.

"" may appear on the screen during operation. A "" means that the desired operation is not permitted by the unit or disc.





Playing a Disc

1. Press the  **STANDBY/ON** button turn on the unit.
2. Press the **FUNCTION** button to select DVD mode.
See **CUSTOMIZING THE FUNCTION SETTINGS** before proceeding to step 3.
3. Press the  **OPEN/CLOSE** button. The disc tray opens.
4. Place a disc onto the disc tray with the label side up.
5. Press the  **OPEN/CLOSE** button. The disc tray closes.
It takes a short while for your unit to load the disc. After loading, the unit will automatically bring you to the main menu of the DVD or start playback of the disc.
6. If the unit does not automatically start playing the DVD, press the  **PLAY** button.



Pausing Playback (Still Mode)

Press the  **PAUSE** button on the remote. To resume normal playback, press the  **PLAY** button. Each time you press the  **PAUSE** button, the picture advances one frame.







Stopping Playback

Press the  **STOP** button at the location where you want to interrupt playback. To resume playback at the position where the disc was stopped, press the  **PLAY** button. If you press the  **STOP** button twice, the unit's memory will be cleared and pressing the  **PLAY** button will reset the disc to the beginning.

Skipping to a Different Chapter/Track

- Press the  **PREV** button repeatedly to skip to the start of the current or previous chapter or track.
- Press the  **NEXT** button to skip to the next chapter or track.
- For an audio CD, use the number buttons (remote control only) to go directly to that track number.



Fast Forward/Fast Reverse

1. Press the  **TUNING**  button on the remote control when a disc is playing.
 - The disc begins fast scan at x2 speed.
 - Four speeds are available. Each time the  **TUNING**  button is pressed, the speed of fast scan changes in the following sequence:

2. Press the  **PLAY** button when you have reached the desired point to resume playback at normal speed.

Notes:

- The DVD player mutes sound during reverse and forward scan of the disc.
- The fast playback speed may differ depending on the disc.

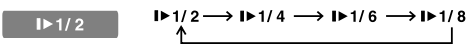
Slow-motion Play

1. Press the  **SLOW** button on the remote in play mode.
 - Four speeds are available. Each time the  **SLOW** button is pressed, the speed of slow-motion playback changes in the following sequence:

2. Press the  **PLAY** button to return to normal playback speed.

PLAYING A DISC

Angle Selection

Some DVDs contain scenes which have been shot from a number of different angles. For these discs, the same scene can be viewed from each of these different angles.

1. While you are playing a DVD with different angles recorded, press the **ANGLE** button to view the number of current angles available.
2. Press the **ANGLE** button repeatedly to change the scene to the next angle in those recorded.
 - About two seconds later, playback continues from the new angle selected.
 - If no button is pressed within 10 seconds, playback continues without changing the current angle.

Sequence of angle shots
(Example)

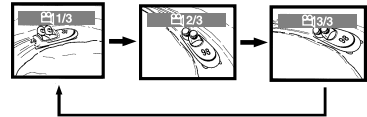

Notes:

- This function can only be used for discs on which scenes shot from multiple angles have been recorded.
- If only one angle is recorded, “ 1/1 ” is displayed.

Subtitle Selection

1. While a DVD is playing, press the **SUBTITLE** button to display the current language setting, as shown in the example below.
2. Press the **SUBTITLE** button repeatedly to select the desired subtitle language.

Notes:

- If only one language is recorded, the language does not change.
- About two seconds later, playback continues with the new subtitle selected.
- The number of languages recorded differs depending on the disc.
- If no button is pressed within a few seconds, playback continues without changing the current subtitle.
- This function can only be used for discs on which subtitles have been recorded in multiple languages.
- On some DVDs, subtitles are activated from the main menu of the DVD. Press the **MENU** button to activate the main menu.



Audio Selection

On some discs, the sound is recorded in two or more formats. Follow the directions below to select the type of playback.

1. While a disc is playing, press the **AUDIO** button to show the current audio format number.
2. Press the **AUDIO** button repeatedly to select the desired audio format.

Notes:

- If only one audio format is recorded, the number does not change.
- Some DVDs allow you to change audio selections via the disc menu only. If this is the case, press the **MENU** button and choose the appropriate language on the disc menu.



Display Function

While the disc is playing, press the **DISPLAY** button on the remote control repeatedly to display information on operation status.

Time: The elapsed time from the beginning of the title which is currently playing.

Title/Chapter: The number of the title/chapter currently playing and total titles/chapters on disc.

Audio: The type of the audio currently selected is displayed.

Subtitle: The subtitle number and language currently selected is displayed. When a disc with only one subtitle is played back, “ 1/1 Eng ” is displayed.

Angle: The current angle is displayed. When a disc with only one angle is played back, “ 1/1 ” is displayed.

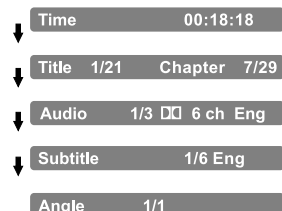

SPECIAL FUNCTION

Locating a Specific Title/Chapter/Time

If a DVD contains title/chapter/time numbers, you can locate a specific title/chapter/time by directly selecting a title/chapter/time number.

1. Press the **GOTO** button to display **Title**.
2. Press the **▲** or **▼** button to select the option (Title, Chapter or Time) then press the corresponding number button(s) for the Title/Chapter/Time you want.
3. Press the **OK** button to confirm. The unit will start playback about 3 seconds later.

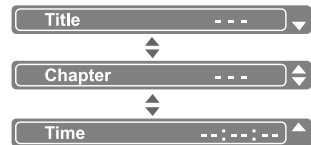

Locating a Specific Track

If a CD contains track numbers, you can locate a specific track by directly selecting track number.

1. Press the **GOTO** button.
2. Press the **▲** or **▼** button to select the option (Track, Time or Disc Time) then press the corresponding number button(s) for the Track/Time/Disc time you want.
3. Press the **OK** button to confirm. The unit will start playback about 3 seconds later.



Notes:

- If the time numbers you entered is not permitted by the DVD, after you press the **OK** button, it will restore to “- - : - - : - -”. You should re-enter correct numbers.
- Some discs may not respond to this process.
- Some scenes may not be located as precisely as you specified.
- This method for accessing specific locations is available only within the current title of the DVD.

Setting Favorite Bookmarks During Playback

While a disc is playing, you can mark the desired scene.

1. Press the **GOTO** button until **Bookmark1** appears.
2. Press the **OK** button to mark the desired scene and the time of this point will be shown in **Bookmark1**.
3. Press the **OK** button to play the favorite bookmark.

To Set Other Bookmarks

1. Press the **GOTO** button until **Bookmark1** appears, then use the **▲** or **▼** button to select **Bookmark2/Bookmark3**.
2. Press the **OK** button.

Notes:

- Some discs may not work with marking operation.
- The marking is cancelled when you open the disc tray or turn the unit off.

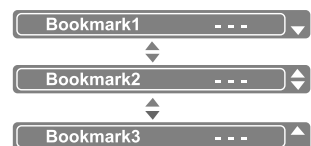

REPEAT PLAYBACK

You can play a specific title or chapter repeatedly.
(Title repeat, chapter repeat, A-B repeat)

Repeating a Chapter

You can play the same chapter repeatedly.

1. While the disc is playing, press the **REPEAT DISC** button until the “Repeat Chapter” indicator displays on the screen. The current chapter is played repeatedly.

Repeating a Title

You can play the same title repeatedly.

2. While the disc is playing, press the **REPEAT DISC** button until the “Repeat Title” indicator displays on the screen. The current title is played repeatedly.

To Resume Normal Playback

3. While the disc is playing, press the **REPEAT DISC** button until the “Repeat Off” indicator displays on the screen.

You can play a single track or whole disc repeatedly.

Repeating a Single Track

You can play the same track repeatedly.

1. While the disc is playing, press the **REPEAT DISC** button on the remote control until the “Repeat single” indicator displays on the screen. The current track is played repeatedly.

Repeating a Whole Disc

2. While the disc is playing, press the **REPEAT DISC** button on the remote control until the “Repeat all” indicator displays on the screen. The whole disc is played repeatedly.

To Resume Normal Playback

3. Press the **REPEAT DISC** button until the “Repeat off” indicator displays on the screen.

You can play a single track or the entire CD repeatedly through the Toolkit which appears on the right in the window.

While the disc is playing, use the ► and ▼ button to select “Repeat”, then press the **OK** button to select **Single/All/Off**.

Single: Repeat the current track.

All: Repeat the entire CD.

Off: Resume normal playback



Repeating a Specific Section

You can play a specific section repeatedly.

1. While the disc is playing, press the **REPEAT A-B** button at the beginning of the section (“Rep A-” is displayed) you want to play repeatedly.
2. Press the **REPEAT A-B** button again at the end of the section (“Rep A-B” is displayed).
3. The unit will immediately begin replaying your selection.

To Resume Normal Playback

4. While the disc is playing, press the **REPEAT A-B** button until the “RepAB Off” indicator displays on the screen.

Notes:

- A-B repeat can only be used within the same title. If the start and end of the section to be repeated are in different titles, A-B repeat is cancelled.
- The A-B repeat function does not operate in scenes where different camera angles are recorded.

DVD PROGRAMMABLE MEMORY

DVD Programmed Playback

You can combine your favorite titles/chapters and play them in the order you determine.

1. Press the **MEMORY** button on the remote control.
2. Use the **▲** or **▼** button to select the title you want, then press the **OK** button on the remote control to confirm.
3. Use the **▲** or **▼** button to select the chapter you want, then press the **OK** button on the remote control to confirm.
4. Use the **▲** button to move the cursor to the top of the chapter list and press the **OK** button to return to **Title** window. Then repeat steps 2 to 3 to add additional titles and chapters.
5. Press the **▶ PLAY** button to start the programmed playback.

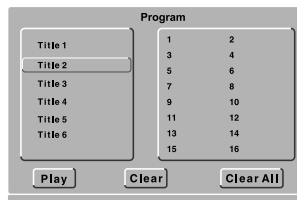

To Change the Programmed Selections

- 1). Press the **MEMORY** button.
- 2). Press the **▶** button to select "Clear", then press the **OK** button to clear them one by one.
- 3). Follow above steps 1-4 to program the new title and chapter.

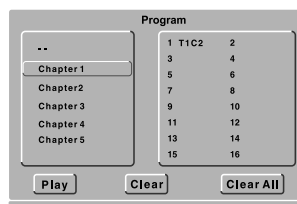

To Resume Normal Playback from Programmed Playback

- 1). Press the **MEMORY** button.
- 2). Press the **▶** button to select "Clear All", then press the **OK** button. All the programs will be cleared.
- 3). Press the **▶ PLAY** button to resume playback.

Notes:

- Some discs may not permit memory playback operation.
- To exit the Program menu, press the **MEMORY** button.
- The programmed selections will be cleared when you open the disc tray or turn off the DVD player.

VIEWING JPEG FILES

This unit can play JPEG files recorded on a CD-R/RW discs.

Viewing JPEG Files

1. Open the disc tray.
2. Place a disc onto the disc tray with the label side up.
3. Close the disc tray. A list of folders/files will appear on the screen.
4. Press the **▲** or **▼** button to select your desired file, the selected picture will appear in the lower right corner.
5. Press the **▶ PLAY** button to start playback. Press the **■ STOP** button to display a folder list.

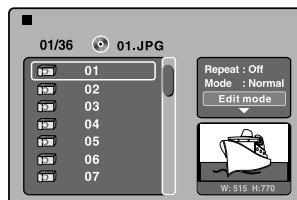

Notes:

- You can press the **⏸ PAUSE** button to freeze the picture, and press the **▶ PLAY** button to resume slide show.
- You can press the **■ STOP** button to quit playback.
- You can use the number buttons on the remote control to jump immediately to the desired picture.
- You can press the **ANGLE** button on the remote control to rotate direction of the picture by 90°.
- Some discs may not permit this operation.

PLAY MODES FOR CD OR JPEG DISC

When playing CD/JPEG discs, you can modify the Play Modes through the Toolkit which appears on the right side of the window. Press the ◀ or ▶ button on the remote control to navigate between the left/right windows and the ▲ or ▼ button on the remote control to select files/tracks or play mode items. Then press the **OK** button.

CD Track/JPEG File Programmed Playback

1. Use the ▶ and ▼ buttons to select "Edit mode" then press the **OK** button.
2. Use the cursor buttons (◀, ▶, ▲, ▼) to select tracks/files shown on the left side of the window. Then press the **OK** button. "✓" will appear in front of the selected tracks/files.
3. Use the ▶ and ▼ buttons to select "Add to program", press the **OK** button. "✓" will disappear from the screen. It means that the tracks/files you selected have been added into the "Program view".
4. Use the ▲ or ▼ button to select "Program view" and press the **OK** button to view programmed files.
5. Press the ▶ **PLAY** button to start the program playback.

Note: When programming the JPEG files, it should be in STOP mode.

Clear the Programmed Tracks/Files

- Press the ■ **STOP** button twice to stop playback.
1. Use the ▶ and ▼ buttons to select "Edit mode" then press the **OK** button.
 2. Use the ▲ or ▼ button to select "Program view" then press the **OK** button. The programmed tracks/files appear on the left side of the window.
 3. Use the cursor buttons (◀, ▶, ▲, ▼) to select the programmed tracks/files, then press the **OK** button. "✓" will appear in front of the selected tracks/files.
 4. Use the ▶ and ▼ buttons to select "Clear program" then press the **OK** button.
 5. To resume normal playback, use the ▲ or ▼ button to select "Browser view" and press the **OK** button, then press the ▶ **PLAY** button.

Note: It is disabled if the "Edit mode" item is not selected.

The Toolkit has the following play mode items:

- **Repeat (Off/Single/All):**
 - Off:** Resumes normal playback.
 - Single:** Repeats the current track/file.
 - All:** Repeats all files on the current folder or all tracks on the disc.
- **Mode (Normal/Shuffle/Music Intro):**
 - Normal:** Resumes normal playback.
 - Shuffle:** Playbacks track/file in random order.
 - Music Intro:** Only playback the first 10 seconds of all tracks on the disc.
- **Edit mode:** Program operation works only when "Edit mode" is selected.
- **Program view:** To view tracks/files in the "Program view" list. It is disabled when the "Program view" list is empty.
- **Add to program:** Add files/tracks to the "Program view" list. It is disabled if the "Edit mode" item is not selected.
- **Browser view:** To view files/tracks in the original view list.
- **Clear program:** Delete the files/tracks in the "Program view" list.

Note: The program will be deleted if disc tray is opened.

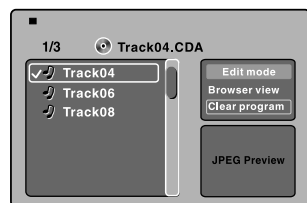
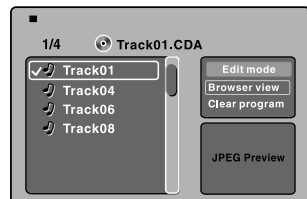
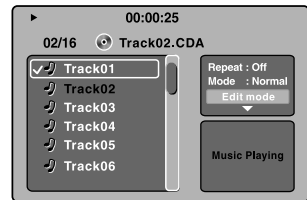

CUSTOMIZING THE FUNCTION SETTINGS

LANGUAGE

OSD Language

1. Press the **SETUP** button.
2. Press the **▶** button to select **OSD Language**.
3. Press the **▶** button. Use the **▲** or **▼** button to make adjustments, then press the **OK** button.
The screen will change to your selected language immediately.
4. Press the **RETURN** button to exit menu.

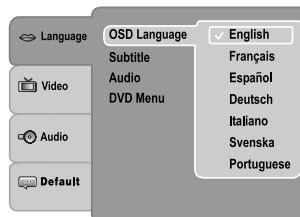

Subtitle

1. Press the **SETUP** button.
2. Press the **▶** button. Use the **▲** or **▼** button to select **Subtitle**.
3. Press the **▶** button. Use the **▲** or **▼** button to make adjustments, then press the **OK** button.
4. Press the **RETURN** button to exit menu.

Notes:

- Some DVDs may be set to display subtitles in a different language other than the ones you selected. A prior subtitle language may be programmed on the disc.
- Some DVDs allow you to change subtitle selections via the disc menu only. If this is the case, press the MENU button and choose the appropriate subtitle language from the selection on the disc menu.

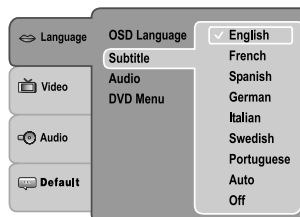

Audio

1. Press the **SETUP** button.
2. Press the **▶** button. Use the **▲** or **▼** button to select **Audio**.
3. Press the **▶** button. Use the **▲** or **▼** button to make adjustments, then press the **OK** button.
4. Press the **RETURN** button to exit menu.

Note: Some DVDs may not play in the selected language. A prior language may be programmed on the disc.

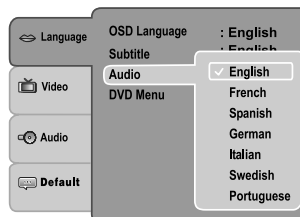

DVD Menu

1. Press the **SETUP** button.
2. Press the **▶** button. Use the **▲** or **▼** button to select **DVD Menu**.
3. Press the **▶** button. Use the **▲** or **▼** button to make adjustments, then press the **OK** button.
4. Press the **RETURN** button to exit menu.

Note: Some DVDs may not include your pre-selected language. In this case, the DVD player automatically displays disc menus consistent with the disc's initial language setting.

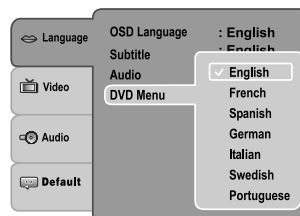

VIDEO

TV Shape

1. Press the **SETUP** button.
2. Press the **▶** or **▼** button to select **Video**.
3. Press the **▶** button. Use the **▲** or **▼** button to select **TV Shape**.
4. Press the **▶** button. Use the **▲** or **▼** button to make adjustments, then press the **OK** button.
5. Press the **RETURN** button to exit menu.

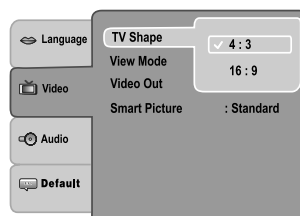

CUSTOMIZING THE FUNCTION SETTINGS

Notes:

- The displayable picture size is preset on the DVD. Therefore, the playback picture of some DVDs may not conform to the picture size you select.
- When you play DVDs recorded in the 4:3 picture size only, the playback picture always appears in the 4:3 picture size regardless of the TV Shape setting.
- Select 16:9 to conform the LCD screen on the unit. Always be sure that your TV Shape conforms to the actual TV in use if you connect the unit to a TV.

View Mode

1. Press the **SETUP** button.
2. Press the **▲** or **▼** button to select **Video**.
3. Press the **▶** button. Use the **▲** or **▼** button to select **View Mode**.
4. Press the **▶** button. Use the **▲** or **▼** button to select the option (Fill, Original, Auto Fit or Pan Scan), then press the **OK** button.
5. Press the **RETURN** button to exit menu.

Fill: Fill the screen with decoded image.

Original: Display image as it's original size.

Auto Fit: Automatically fit the decoded image on screen without distortion. Black bars will be present on top/bottom or left/right of screen.

Pan Scan: Select when a standard 4:3 TV is connected. Displays pictures cropped to fill your TV screen. Sides of the picture are cut off. Note: Depending on the DVDs, you may not be able to view the mode as selected.

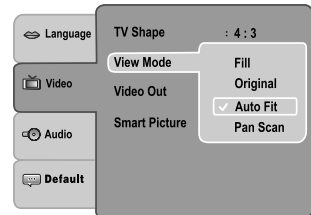

Video Out

1. Press the **SETUP** button.
2. Press the **▲** or **▼** button to select **Video**.
3. Press the **▶** button. Use the **▲** or **▼** button to select **Video Out**.
4. Press the **▶** button. Use the **▲** or **▼** button to select the option (CVBS, YUV or P-Scan), then press the **OK** button.
5. Press the **RETURN** button to exit menu.

CVBS: Select if you connect the DVD to TV via composite video input.

YUV: Corresponding to your TV which has a YUV (component video) input.

P-Scan: Select if you connect the DVD to your TV which has a YUV (component video) that supports progressive scan. If there is a distorted picture on the TV, wait 15 seconds for automatic recover.

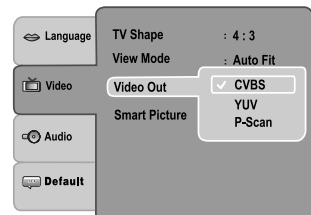

Smart Picture

1. Press the **SETUP** button.
2. Press the **▲** or **▼** button to select **Video**.
3. Press the **▶** button. Use the **▲** or **▼** button to select **Smart Picture**.
4. Press the **▶** button. Use the **▲** or **▼** button to select the option (Standard, Bright, Soft or Dynamic), then press the **OK** button.
5. Press the **RETURN** button to exit menu.

Standard: Picture is set to normal brightness.

Bright: Picture is brighter.

Soft: Softer image effect.

Dynamic: It includes 4 items (Brightness, Contrast, Tint and Color). Use the **◀** or **▶** button to make adjustments.

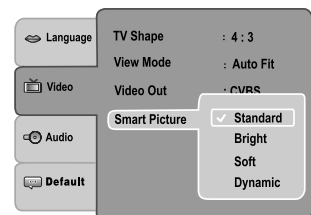

CUSTOMIZING THE FUNCTION SETTINGS

AUDIO

Digital Output

1. Press the **SETUP** button.
2. Press the **▲** or **▼** button to select **Audio**.
3. Press the **▶** button. Use the **▲** or **▼** button to select **Digital Output**.
4. Press the **▶** button. Use the **▲** or **▼** button to select the options (Off, PCM or Raw), then press the **OK** button.
5. Press the **RETURN** button to exit menu.

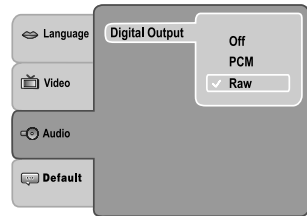

PCM: Select when connected to a 2 channel digital stereo amplifier.

The DVD video player outputs sound in the PCM 2 channel format when you play a DVD recorded on the Dolby Digital, MPEG1 or MPEG2 recording system.

Raw: Disc audio raw data will be output.

Off: To disable Digital Output.

DEFAULT

Use Default Settings

1. Press the **SETUP** button.
2. Press the **▲** or **▼** button to select **Default**.
3. Press the **▶** button, then press the **OK** button.
4. Use the **◀** or **▶** button to select "YES", then press the **OK** button.
The original setting will be restored. The unit will exit setting menu automatically and reload the disc in the disc tray.

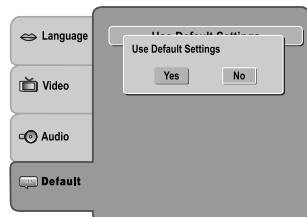

Note: It will take 3-5 seconds to reset the DVD player to the factory default.

LISTENING TO THE RADIO

Tuning in to a Station Manually

1. Press the **FUNCTION** button to select RADIO.
2. Use the **◀ TUNING/SKIP ▶** control on the front panel or the **◀ TUNING ▶** button on the remote to tune in to a desired station.

FM Stereo

Press the **MONO/STEREO** button on the remote control until "ST" appears on the front panel display.

Weak FM stations

Press the **MONO/STEREO** button on the remote control until "MONO" appears on the front panel display. Background noise will be reduced but the signal reproduced will be mono. To restore stereo reception, press the **MONO/STEREO** button on the remote control to select "ST".

Presetting Stations

The unit can store a total of 20 stations in memory. Presetting allows you to tune in to a station directly.

1. Press the **FUNCTION** button to select RADIO.
2. Tune in to a desired station.
3. Press the **MEMORY** button on the remote control.
4. Press the corresponding number buttons on the remote control for the preset station. The current station is stored in memory.
Example: To enter the preset number 2, press the "0" & "2" buttons.
To enter the preset number 15, press the "1" & "5" buttons.
5. Repeat steps 2-5 to store other stations.

Tuning in to a Preset Station

1. Press the **FUNCTION** button to select RADIO.
2. Press the **◀ PREV/▶ NEXT** button repeatedly to select the number of the preset station or use the numbered buttons to enter the number of the preset station.

TROUBLE SHOOTING GUIDE

SYMPTOM

CAUSE (AND REMEDY)

No power.	<ul style="list-style-type: none"> • Ensure the AC power cord is connected.
No picture	<ul style="list-style-type: none"> • The region number of the disc doesn't match the region number of this unit.  <ul style="list-style-type: none"> • The TV is not set to receive DVD signal output. • The video cable is not connected. • The TV is not turned on. • Clean the disc.
The picture is not clear.	<ul style="list-style-type: none"> • If video from your system has to go through your VCR to get to your TV, the copy-protection applied to some DVD programs could affect picture quality. • The disc is scratched. • The DVD unit may be set to progressive scan; moreover, TV does not support progressive scan component video signal. Set the Video Out to "CVBS" mode. • The location and orientation of the antenna are incorrect. If you use an indoor antenna, change to an outdoor antenna. • The TV antenna wire is too close to the unit. Separate the TV antenna wire from the unit.
No sound or only a very low-level sound is heard.	<ul style="list-style-type: none"> • Ensure the speakers and equipment are connected securely. • The system is in Pause mode or in Slow-motion Play mode. Press the ► PLAY button to return to normal play mode. • Fast forward or fast reverse is performed. Press the ► PLAY button to return to normal play mode. • Make sure the AUDIO output and AV IN input connections are correct. • Adjust the speaker volume.
Severe hum or noise is heard.	<ul style="list-style-type: none"> • Ensure the speakers and equipment are connected securely. • Ensure the connecting cords are away from a transformer or motor, and at least 10 feet (3 meters) away from a TV set or fluorescent light. • Move your TV away from the audio equipment. • The plugs and jacks are dirty. Wipe them with a cloth slightly moistened with alcohol. • Clean the disc. • Vibrations from the speakers are affecting the unit.
The remote does not function.	<ul style="list-style-type: none"> • Remove any obstacles between the remote and the unit. • Use the remote near the unit. • Point the remote at the remote sensor on the unit. • Replace the batteries in the remote.
The disc does not play.	<ul style="list-style-type: none"> • There is no disc inside ("No Disc" appears on the TV screen). • Insert the disc correctly with the playback side facing down on the disc tray. • Clean the disc. • A non-VALID disc has been inserted. The unit and disc region number are incompatible.
The DVD door cannot open.	<ul style="list-style-type: none"> • Condensation may have formed inside the unit due to a sudden change in temperature. Wait approximately an hour for it to clear and try again.

MAINTENANCE

Cleaning the Disc

A defective or soiled disc inserted into the unit can cause sound to drop out during playback. Handle the disc by holding its inner and outer edges.

- Do NOT touch the surface of the unlabeled side of the disc.
- Do NOT stick paper or tape on the surface.
- Do NOT expose the disc to direct sunlight or excessive heat.
- Clean the disc before playback. Wipe the disc from the center outward with a cleaning cloth.
- NEVER use solvents such as benzine or alcohol to clean the disc.
- Do NOT use irregular shaped discs (example: heart shaped, octagonal, etc.). They may cause malfunctions.

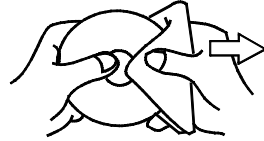

Cleaning the Unit

- Be sure to turn the unit off and disconnect the AC power cord before cleaning the unit.
- Wipe the unit with a dry soft cloth. If the surfaces are extremely dirty, wipe clean with a cloth which has been dipped in a weak soap-and-water solution and wrung out thoroughly. Then wipe with a dry cloth.
- Never use alcohol, benzine, thinner, cleaning fluid or other chemicals. Do NOT use compressed air to remove dust.

Important Note

Before transporting the unit, remove the disc from the disc compartment.

SPECIFICATIONS

Power source: AC 120V ~ 60Hz

Specifications and external appearance are subject to change without notice.

Free Manuals Download Website

<http://myh66.com>

<http://usermanuals.us>

<http://www.somanuals.com>

<http://www.4manuals.cc>

<http://www.manual-lib.com>

<http://www.404manual.com>

<http://www.luxmanual.com>

<http://aubethermostatmanual.com>

Golf course search by state

<http://golfingnear.com>

Email search by domain

<http://emailbydomain.com>

Auto manuals search

<http://auto.somanuals.com>

TV manuals search

<http://tv.somanuals.com>