



# **ASUS® Xonar D2 audio card**

## *User Manual*

E3255

First Edition V1

May 2007

**Copyright © 2007 ASUSTeK COMPUTER INC. All Rights Reserved.**

No part of this manual, including the products and software described in it, may be reproduced, transmitted, transcribed, stored in a retrieval system, or translated into any language in any form or by any means, except documentation kept by the purchaser for backup purposes, without the express written permission of ASUSTeK COMPUTER INC. ("ASUS").

Product warranty or service will not be extended if: (1) the product is repaired, modified or altered, unless such repair, modification or alteration is authorized in writing by ASUS; or (2) the serial number of the product is defaced or missing.

ASUS PROVIDES THIS MANUAL "AS IS" WITHOUT WARRANTY OF ANY KIND, EITHER EXPRESS OR IMPLIED, INCLUDING BUT NOT LIMITED TO THE IMPLIED WARRANTIES OR CONDITIONS OF MERCHANTABILITY OR FITNESS FOR A PARTICULAR PURPOSE. IN NO EVENT SHALL ASUS, ITS DIRECTORS, OFFICERS, EMPLOYEES OR AGENTS BE LIABLE FOR ANY INDIRECT, SPECIAL, INCIDENTAL, OR CONSEQUENTIAL DAMAGES (INCLUDING DAMAGES FOR LOSS OF PROFITS, LOSS OF BUSINESS, LOSS OF USE OR DATA, INTERRUPTION OF BUSINESS AND THE LIKE), EVEN IF ASUS HAS BEEN ADVISED OF THE POSSIBILITY OF SUCH DAMAGES ARISING FROM ANY DEFECT OR ERROR IN THIS MANUAL OR PRODUCT.

SPECIFICATIONS AND INFORMATION CONTAINED IN THIS MANUAL ARE FURNISHED FOR INFORMATIONAL USE ONLY, AND ARE SUBJECT TO CHANGE AT ANY TIME WITHOUT NOTICE, AND SHOULD NOT BE CONSTRUED AS A COMMITMENT BY ASUS. ASUS ASSUMES NO RESPONSIBILITY OR LIABILITY FOR ANY ERRORS OR INACCURACIES THAT MAY APPEAR IN THIS MANUAL, INCLUDING THE PRODUCTS AND SOFTWARE DESCRIBED IN IT.

Products and corporate names appearing in this manual may or may not be registered trademarks or copyrights of their respective companies, and are used only for identification or explanation and to the owners' benefit, without intent to infringe.

# Contents

<b>Contents</b> .....	<b>-iii</b>
<b>Notices</b> .....	<b>v</b>
<b>Safety information</b> .....	<b>vi</b>
<b>Trademarks</b> .....	<b>vi</b>
<b>License</b> .....	<b>vi</b>
<b>1. Introduction</b> .....	<b>1</b>
1.1 Package Contents .....	1
1.2 System Requirements .....	1
1.3 Specifications summary .....	2
<b>2. About Hardware</b> .....	<b>4</b>
2.1 Xonar D2 Audio Processing Card .....	4
2.2 MIDI Board/Cable .....	6
<b>3. Installing the Xonar Hardware</b> .....	<b>7</b>
3.1 Preparing Your Computer .....	7
3.2 Installing the Audio Processing Card .....	8
3.3 Installing the MIDI board .....	8
3.4 Connecting CD/DVD-ROM Drive (with the analog header) .....	9
3.5 Connecting TV Tuner Card .....	10
<b>4. Installing Software</b> .....	<b>11</b>
4.1 Installing the Audio Card Driver .....	11
4.2 Installing the PMP software (Portable Music Processor) .....	12
4.3 Installing the Ableton Live .....	13
4.4 Installing the Cakewalk Production Plus Pack .....	14
4.5 Uninstalling or Reinstalling Software .....	16
<b>5. Connecting Speakers and Peripherals</b> .....	<b>18</b>
5.1 Connecting Digital Speaker Systems (Home Theater) .....	18
5.2 Connecting Headphones .....	19
5.3 Connecting Analog Speaker Systems .....	21
5.5 Connecting Microphone .....	26
5.6 Connecting Line-In Audio Sources .....	26
5.7 Connecting Digital Audio Sources .....	27
<b>6. Xonar D2 Driver Guide</b> .....	<b>28</b>
6.1 Introduction to the Xonar D2 Audio Center GUI .....	28
6.2 Main Setting .....	30
6.3 Mixer/Volume .....	39

# Contents

6.4	Effects .....	42
6.5	Karaoke/Magic Voice .....	44
6.6	FlexBass .....	45
6.7	Smart Volume Normalization .....	46
6.8	DSP Modes .....	48
6.9	ASIO 2 Driver .....	49
<b>7.</b>	<b>Portable Music Processor™ Software Guide .....</b>	<b>52</b>
7.1	Introduction .....	52
7.2	Converting music in “Main Setting” Page.....	54
7.2	Find Converted Music in “PMP Music” Page .....	56
<b>8</b>	<b>Ableton Live Software Guide .....</b>	<b>57</b>
<b>9.</b>	<b>Cakewalk Production Plus Pack Software Guide .....</b>	<b>57</b>
<b>10.</b>	<b>RMAA Test Guide .....</b>	<b>58</b>
10.1	Setting Up Xonar D2 Audio Card .....	58
10.2	Configuration and Test with RMAA.....	61
10.3	RMAA Testing Results.....	66
<b>11.</b>	<b>Troubleshooting and FAQs .....</b>	<b>72</b>

# Notices

## Federal Communications Commission Statement

This device complies with Part 15 of the FCC Rules. Operation is subject to the following two conditions:

- This device may not cause harmful interference, and
- This device must accept any interference received including interference that may cause undesired operation.

This equipment has been tested and found to comply with the limits for a Class B digital device, pursuant to Part 15 of the FCC Rules. These limits are designed to provide reasonable protection against harmful interference in a residential installation. This equipment generates, uses and can radiate radio frequency energy and, if not installed and used in accordance with manufacturer's instructions, may cause harmful interference to radio communications. However, there is no guarantee that interference will not occur in a particular installation. If this equipment does cause harmful interference to radio or television reception, which can be determined by turning the equipment off and on, the user is encouraged to try to correct the interference by one or more of the following measures:

- Reorient or relocate the receiving antenna.
- Increase the separation between the equipment and receiver.
- Connect the equipment to an outlet on a circuit different from that to which the receiver is connected.
- Consult the dealer or an experienced radio/TV technician for help.

## Canadian Department of Communications Statement

This digital apparatus does not exceed the Class B limits for radio noise emissions from digital apparatus set out in the Radio Interference Regulations of the Canadian Department of Communications.

This class B digital apparatus complies with Canadian ICES-003.

## Safety information

- Before installing the device on a motherboard, carefully read all the manuals that came with the package.
- To prevent electrical shock hazard or short circuits, switch off the power supply before installing the device on a motherboard or connecting any single cables to the device.
- If the device is broken, do not try to fix it by yourself. Contact a qualified service technician or your retailer.
- Before using the product, make sure all cables are correctly connected. If you detect any damage, contact your dealer immediately.
- To avoid short circuits, keep paper clips, screws, and staples away from connectors, sockets and circuitry.
- Avoid dust, humidity, and temperature extremes. Do not place the product in any area where it may become wet.
- Place the product on a stable surface.
- If you encounter technical problems with the product, contact a qualified service technician or your retailer.



---

This symbol of the crossed out wheeled bin indicates that the product (electrical and electronic equipment) should not be placed in municipal waste. Check local regulations for disposal of electronic products.

---

## Trademarks

Xonar and ASUS logo are trademarks of ASUSTek Computer Inc. “Dolby” and “Dolby Digital Live”, “Dolby Pro Logic IIx”, “Dolby Virtual Speaker”, “Dolby Headphone” are trademarks of Dolby Laboratories. “DTS” and “DTS CONNECT”, “DTS Interactive”, “DTS Neo: PC” are trademarks of Digital Theater Systems, Inc. EAX and A3D are trademarks of Creative Technology Ltd. Microsoft, DirectSound3D, Windows are trademarks of Microsoft Corporation. Other company and product names may be trademarks of the respective companies with which they are associated. ASIO is a trademark and software of Steinberg Media Technologies GmbH.

## License

Dolby Master Studio driver is manufactured under license from Dolby Laboratories; DTS Connect driver is manufactured under license from Digital Theater Systems, Inc.

# 1. Introduction

## 1.1 Package Contents

- Xonar D2 7.1 Channel PCI Audio Card
- Driver Support CD (including Portable Music Processor™ utility)
- Ableton™ Live software CD
- Cakewalk™ Production Plus Pack CD (Sonar LE, Dimension LE, and Project5 LE)
- PowerDVD 7.0 software DVD player CD
- Additional MIDI bracket and adaptor \*1
- S/PDIF TOSLINK optical adaptors \*2
- S/PDIF TOSLINK optical cable \*1
- Four 3.5mm-to-RCA cables for 8 channel output
- Dolby Demo CD
- Quick Start Guide

## 1.2 System Requirements

- IBM compatible PC with one PCI 2.1 (or higher) compatible slot for the audio card
- Microsoft® Windows® Vista/XP(32/64bit)/MCE2005
- Intel® Pentium®4 1.4GHz or AMD K7 1400 CPU or faster CPU
- > 256 MB DRAM system memory
- > 60 MB available HDD space for driver installation package; > 200MB space available for Ableton Live and > 320MB for Cakewalk package
- CD-ROM drive (or DVD-ROM drive) for software installation
- High-quality headphones, powered analog speakers, or a Dolby Digital or DTS decoder, to enjoy the Ultra-High Fidelity sounds of the card

## 1.3 Specifications summary

Category	Item	Description
Audio Performance	Output Signal-to-Noise Ratio (A-Weighted):	118dB
	Input Signal-to-Noise Ratio (A-Weighted):	118 dB
	Output Total Harmonic Distortion + Noise at 1kHz :	0.0004% (-108dB)
	Input Total Harmonic Distortion + Noise at 1kHz :	0.0004% (-108dB)
	Frequency Response (-3dB, 24-bit/96kHz input) :	<10Hz to 46kHz
	Frequency Response (-3dB, 24-bit/192kHz input):	<10Hz to 90kHz
	Output/Input Full-Scale Voltage	2 Vrms (5.65 Vp-p)
	Sample Rate Conversion Quality	Almost lossless, high-fidelity floating-point filters, which has: -140dB (typical value for 44.1K->48KHz, 24bit) -145dB Dynamic Range (typical value for 44.1K->48KHz, 24bit)
Main Chipset	Audio Processor	ASUS AV200 High-Definition Sound Processor (Max. 192KHz/24bit)
	24-bit D-A Converter of Digital Sources:	Burr-Brown PCM1796 *4 (123dB SNR, Max. 192kHz/24bit)
	24-bit A-D Converter for Analog Inputs:	Cirrus-Logic CS5381* 1 (120dB SNR, Max. 192kHz/24bit)
Sample Rate and Resolution	Analog Playback Sample Rate and Resolution	44.1K/48K/96K/192KHz @ 16/24bit
	Analog Recording Sample Rate and Resolution	44.1K/48K/96K/192KHz @ 16/24bit
	S/PDIF Digital Output	44.1K/48K/96K/192KHz @ 16/24bit, Dolby Digital, DTS, WMA-Pro
	S/PDIF Digital Input	44.1K/48K/96K/192KHz @ 16/24bit
	ASIO 2.0 Driver Support:	44.1K/48K/96K/192KHz @ 16/24bit
I/O Ports	Analog Output Jack:	3.50mm mini jack *4 (Front/Side/Center-Subwoofer/Back)
	Analog Input Jack:	3.50mm mini jack *2 (Line-In/Mic-In)
	Other line-level analog input (for CD-IN/TV Tuner):	CD-In, Aux-In (4-pin header on the card)
	Digital S/PDIF Output	Coaxial and High-bandwidth Optical Combo Connector Supports 192KHz/24bit
	Digital S/PDIF Input	Coaxial and High-bandwidth Optical Combo Connector Supports 192KHz/24bit
	MIDI Ports	Additional MPU-401 MIDI I/O bracket and converter cable

(continued on the next page)



<b>Driver Features</b>	Operation System	Windows® Vista/XP(32/64bit)/MCE2005
	Dolby® Technologies	Dolby® Headphone, Dolby® Virtual Speaker, Dolby® Pro-Logic IIx, Dolby® Digital Live
	DTS® Technologies	DTS® Connect (DTS Interactive Encoder and DTS Neo:PC)
	Smart Volume Normalizer™	Normalizes the volume of all audio sources into a constant level
	Xear 3DTM Virtual Speaker Shifter	Virtual 7.1 speaker positioning
	Magic Voice™	Modifies the sound of your voice, for VOIP and online chat applications (Windows XP)
	Karaoke Functions	Music Key-Shifting and Microphone Echo effects (Windows XP)
	FlexBass™	Professional Bass Management/Enhancement system
	Other Effects	10-band Equalizer/27 Environment Effects
	3D Sound Engines/APIs	EAX®2.0&1.0, A3D® 1.0, DirectSound® HW & SW
DirectX	DirectX 9.0 or above required for 7.1ch output	
<b>Software Utility</b>	Portable Music Processor utility	Converts digital music content or CD audio into regular MP3/WMA files with Dolby Headphone, Dolby Virtual Speaker (w/ Pro-Logic II), and Smart Volume Normalization processing (Windows Media Player 10 or above is required)
	Professional Audio Editing Utility	Ableton Live; Cakewalk Production Plus Pack (SONAR LE, Dimension LE, and Project5 LE)
	PowerDVD 7.0	Software DVD player with Dolby Digital 5.1 decoder
<b>Accessories</b>	-3.5mm-to-RCA adaptor cable *4 (8ch) -S/PDIF optical adaptors *2 -S/PDIF optical cable *1 -Additional MIDI card, cable, and external standard MIDI adaptor Y cable *1 -Dolby Demo CD	

\*Specifications are subject to change without notice.

## 2. About Hardware

### 2.1 Xonar D2 Audio Processing Card

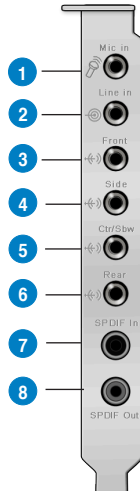
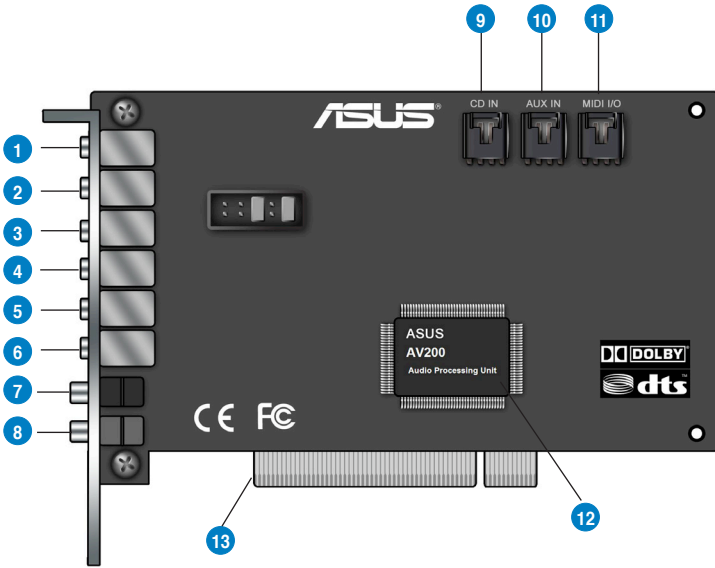

No	Item	Description
1	Microphone Jack	Connect your external PC microphone to this 3.5mm jack for voice input. Built-in high-quality Microphone pre-amplifier.
2	Line Input Jack	Connect analog devices like MP3 players, CD players, music synthesizers and other line-level sound sources to this 3.5mm jack for audio recording or processing. (Through Ultra-high fidelity 118dB SNR A-D converter)
3	Headphone/Front Output Jack	Connect your headphones or 2/2.1 channel speakers to this jack. For multi-channel speaker systems, connects to the front left/right input on the powered speakers.
4	Side Surround Output Jack	Connects to the surround channel input on 4/4.1/5.1/6.1/7.1 powered analog speakers.
5	Center/Subwoofer Output Jack	Connects to the front center/subwoofer input on 5.1/6.1/7.1 powered analog speakers.
6	Rear/Back Surround Output Jack	Connects to the Back Surround input on 6.1/7.1 powered analog speakers.
7	S/PDIF Input	Coaxial and optical TOSLINK combo digital input jack. Connects to external digital audio sources such as MD players, CD players, or DVD players, for audio recording or loopback.
8	S/PDIF Output	Coaxial and optical TOSLINK combo digital output jack. Connects to external digital decoder or digital speaker systems, Home Theater systems, AV receivers for outputting digital audio including PCM, Dolby Digital, DTS, WMA-Pro, etc.
9	CD Input Header	4-pin header. Connects to the Analog Audio output on the back panel of CD/DVD-ROM drive using an Analog CD audio cable, which is usually available with your CD/DVD-ROM drive. You can still play CD audio through the Xonar driver without connecting this. We recommend playing audio through the driver to take advantage of the Xonar's high quality D-A converter, but this header is provided in case you need it.
10	Aux Input Header	4-pin header. Usually connects to the Analog Audio output of TV tuner card or other sound source inside your PC system. (To monitor your TV tuner card's audio from this Aux-In, you must enable the "monitor" function for Aux-In in the Xonar Audio Center software's recording mixer.)
11	MIDI I/O Header	Connects to the additional MIDI board/bracket (available in the package)
12	Main Audio Processor	ASUS Xonar AV200 Audio Processing Unit (DuplexHD 192K/24bit)
13	PCI Bus Golden Fingers	Connects to the PCI slot on your motherboard

## 2.2 MIDI Board/Cable

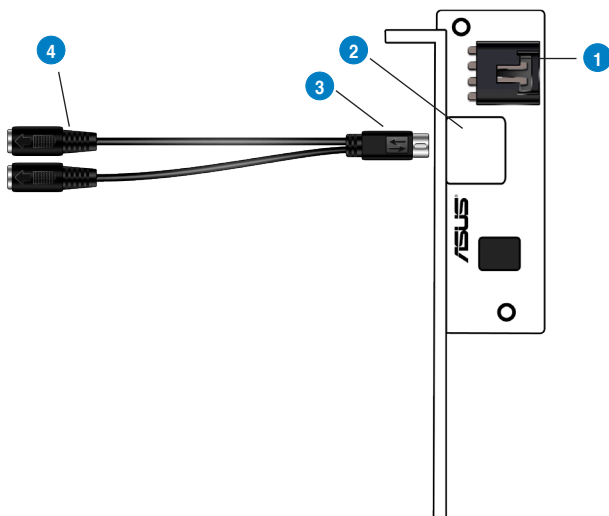

No	Item	Description
1	MIDI I/O Header	Connects to the MIDI I/O header on the main Xonar D2 audio card
2	Mini-DIN MIDI port	Connects to the 6-pin mini-DIN connector of the MIDI Y cable (adaptor to 5-pin DIN standard MIDI I/O connectors)
3	6-pin Mini-DIN MIDI connector	Connects to the #2 6-pin mini-DIN port on the MIDI board
4	5-pin DIN MIDI input/output connectors (Female)	Connects to the input and output DIN male connector of the standard MIDI instrument cable

## 3. Installing the Xonar Hardware

### 3.1 Preparing Your Computer

Before you proceed with the following installation steps, it's recommended that you disable your onboard audio device in your BIOS settings, or uninstall any other sound cards on your PC. (For BIOS setting or uninstallation of other sound cards, refer to the user manuals of your motherboard and sound card)

1. Power off your computer and disconnect the power cord.
2. Open the computer's case.
3. Remove the metal brackets from two unused PCI slots (You can just remove one if you don't need to use the MIDI board in the package).

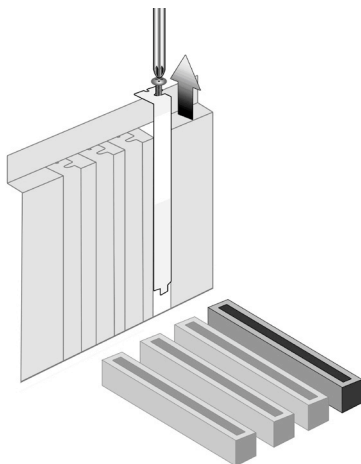

## 3.2 Installing the Audio Processing Card

1. Face the bracket of the Xonar D2 audio card toward the back panel of your computer and insert the audio card gently into an available PCI slot. Make sure it's completely inserted into the PCI slot. (Warning! Do not force the audio card into the slot. Make sure that the gold pins of the card's PCI connector are aligned with the motherboard's PCI connector before you insert the card into the PCI slot. If it does not fit properly, gently remove it and try again.)

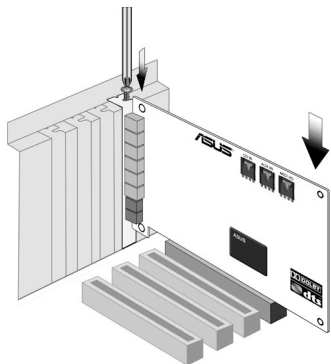

2. Secure the audio card bracket to the back of your computer with the screw that you removed. Refer to section 3.1.

## 3.3 Installing the MIDI board

1. Secure the MIDI bracket to another slot on the back of your computer case.
2. Connect the 4-pin MIDI header on the audio card to the MIDI bracket with the MIDI cable as the figure below.

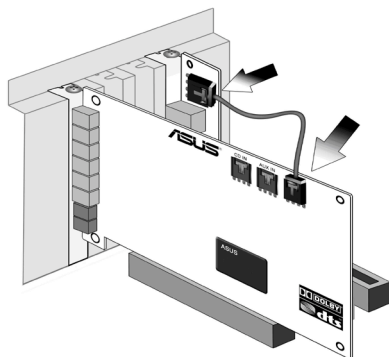

### 3.4 Connecting CD/DVD-ROM Drive (with the analog header)

1. If you would like to use the physical playback buttons on your CD-ROM drive to control audio CD playback on your PC, you need to connect the analog cable between the CD-ROM drive and the audio card. Otherwise, you can just skip this section and use ordinary digital CD playback on Windows.
2. Connect the CD-IN 4-pin header to the analog output on the back of your CD/DVD-ROM drive with the audio CD cable which is usually included with CD/DVD-ROM drive.

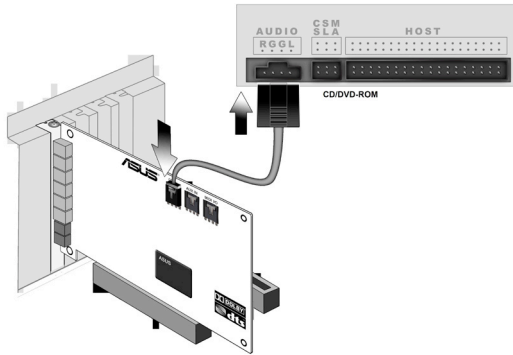

## 3.5 Connecting TV Tuner Card

1. If you have a traditional PCI TV tuner card on your PC, you may need to connect it to the audio card to send the tuner card's sound to your PC speakers.
2. Secure the PCI TV tuner card in one PCI slot and screw it into the back-panel
3. Connect the audio output header from the TV tuner card to the Aux-In header of the audio card, as shown in the figure below.



---

For optimum TV audio quality, Xonar uses ADC recording to digitize the signal and loops it back to DAC playback. Please select Aux-In as the recording source in the Xonar Audio Center's recording mixer and enable the monitoring button to pass this signal to the audio output. Using this setup, you can even turn on sound effects such as Pro-Logic IIx to expand the stereo TV audio to 5.1 or 7.1 channel surround sound. TV audio on your PC will become even better than on your TV set!

---

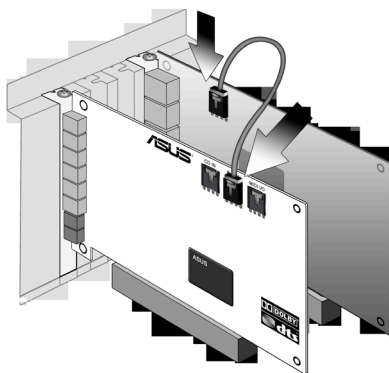



## 4. Installing Software

### 4.1 Installing the Audio Card Driver

1. After you have installed your audio card, turn on your computer. Windows automatically detects your audio card and searches for device drivers. When prompted for the audio drivers, click the “Cancel” button.
2. Insert the driver installation CD into your CD-ROM or DVD-ROM drive. If Windows AutoPlay mode is enabled for your CD-ROM drive, the CD starts running automatically. If it doesn't start the installation, double-click the setup.exe icon located on the CD-ROM.
3. Follow the instructions on the screen to complete the installation. Please read the “END USER LICENCE AGREEMENT” in the process and make sure you understand and accept it before you continue the installation. When the installation finishes, you may be prompted to restart your computer. You can choose to restart the computer later if desired.



## 4.2 Installing the PMP software (Portable Music Processor)

1. From the installation CD menu, select the option to install the PMP software.
2. Follow the instructions on the screen to complete the installation. After the installation is complete, click Finish.

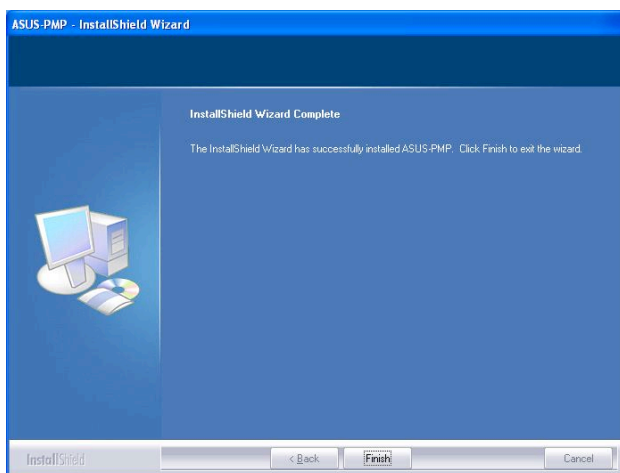

## 4.3 Installing the Ableton Live

1. Insert the Ableton Live installation CD into the CD/DVD-ROM drive.
2. The installation program will start automatically. If it does not, double click the setup program.
3. Follow the instructions on the screen to complete the installation. Please read the “END USER LICENCE AGREEMENT” and make sure you understand and accept it before you continue the installation. After the installation is complete, click Finish.



## 4.4 Installing the Cakewalk Production Plus Pack

### 4.4.1 Installing SONAR LE

1. Insert the Cakewalk Production Plus Pack installation CD into your CD/DVD-ROM drive.
2. The installation program will start automatically. If it does not, double click the setup program.
3. Follow the instructions on the screen to complete the installation. Please read the “SOFTWARE LICENCE AGREEMENT” and make sure you understand and accept it before you continue the installation.
4. You may be prompted to select the language, installed components, and associated file types, and to run the VST Adapter Configuration Wizard. After the installation is complete, click “Finish”.



## 4.4.2 Installing Dimension LE

1. Insert the Cakewalk Production Plus Pack installation CD into your CD/DVD-ROM drive.
2. Choose to install the Dimension LE program.
3. Follow the instructions on the screen to complete the installation. Please read the “SOFTWARE LICENCE AGREEMENT” and make sure you understand and accept it before you continue the installation.
4. You may be prompted to select the language and installed components. After the installation is complete, click “Finish”.

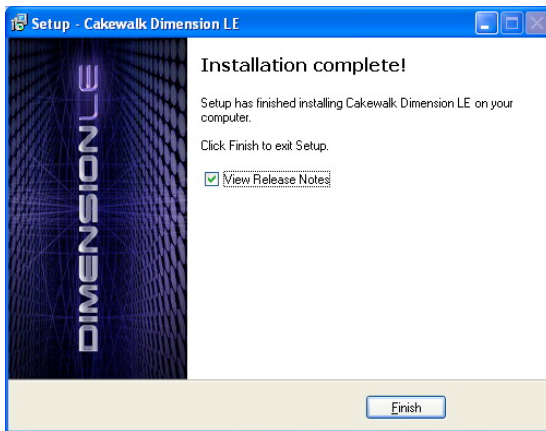

### 4.4.3 Installing Project5 LE

1. Insert the Cakewalk Production Plus Pack installation CD into your CD/DVD-ROM drive.
2. Choose to install the Project5 LE program.
3. Follow the instructions on the screen to complete the installation. Please read the “SOFTWARE LICENCE AGREEMENT” and make sure you understand and accept it before you continue the installation.
4. You may be prompted to select the language, installed components, and associated file types, and to run the VST Adapter Configuration Wizard. After the installation is complete, click “Finish”.

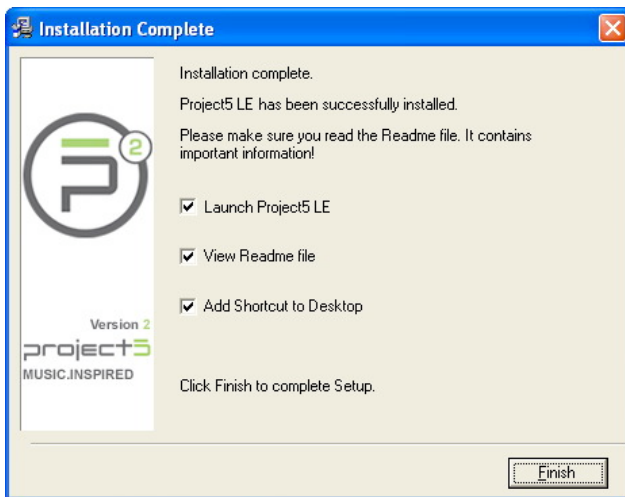

## 4.5 Uninstalling or Reinstalling Software

### 4.5.1 Uninstalling Software

1. Select the corresponding uninstallation program, under the “All Programs” section of the Start menu. Otherwise, you’ll need to use the Windows control panel for uninstallation as follows.

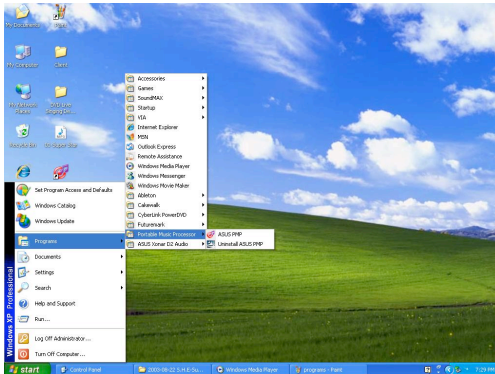

2. Click Start -> Settings -> Control Panel.
3. Double-click the "Add/Remove Programs" icon.
4. Click the "Change or Remove Programs" button.
5. Select each program you would like to remove, and then click the "Add/Remove (or Change/Remove)" button.

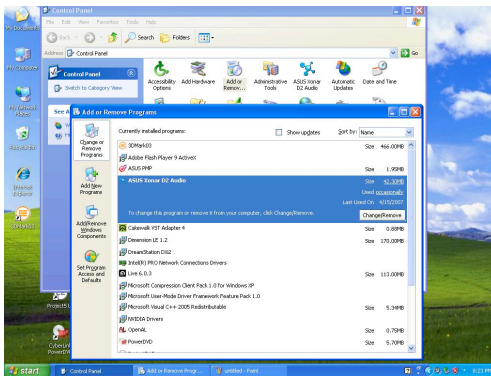

6. In the InstallShield Wizard dialog box, select the "Remove" option.
7. Restart your computer when prompted.

## 4.5.2 Reinstalling Software

1. Before you reinstall any software, it's recommended to uninstall the existing software first.
2. After you finish the uninstallation of the software, please follow the installation process again to reinstall the same or updated software.

# 5. Connecting Speakers and Peripherals

## 5.1 Connecting Digital Speaker Systems (Home Theater)

The Xonar D2 supports Dolby Digital Live and DTS Interactive technologies, which transcode any audio, including games and music, into industry-standard Dolby Digital or DTS 5.1 surround bit-streams. This makes playback through your home theater system possible, creating an immersive and impressive cinema surround sound experience. A single digital cable connection can carry high-quality Dolby Digital or DTS 5.1 digital audio from any of your PC audio sources to any digital speakers or AV Receivers with Dolby Digital or DTS 5.1 decoding capabilities.

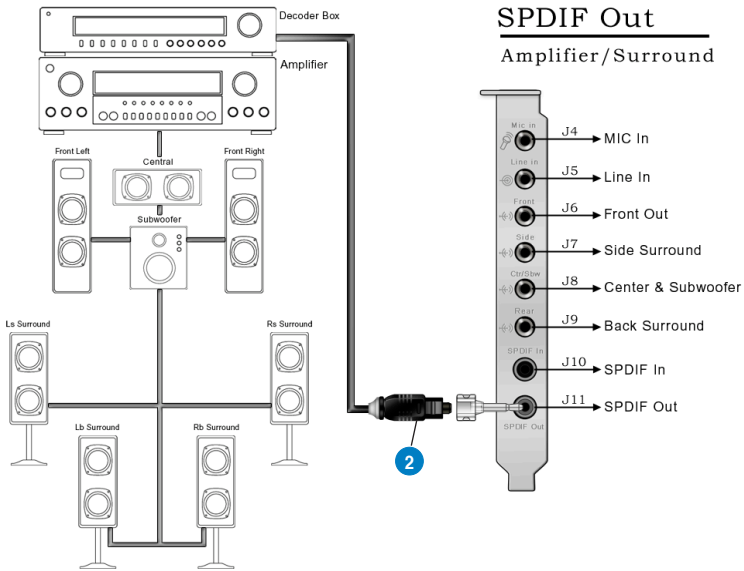

No	Item	Description
1	Optical adaptor	Plug the optical TOSLINK adaptor into the S/PDIF-Out combo connector
2	Optical cable	Connect your decoder's S/PDIF-In port to the optical adaptor with the TOSLINK optical cable



You can also use a coaxial cable for a S/PDIF connection. Just plug the coaxial RCA male connector to the S/PDIF-Out combo jack and connect the other end into the coaxial S/PDIF input on your decoder.



## 5.2 Connecting Headphones

### 5.2.1 Connecting Stereo Headphones

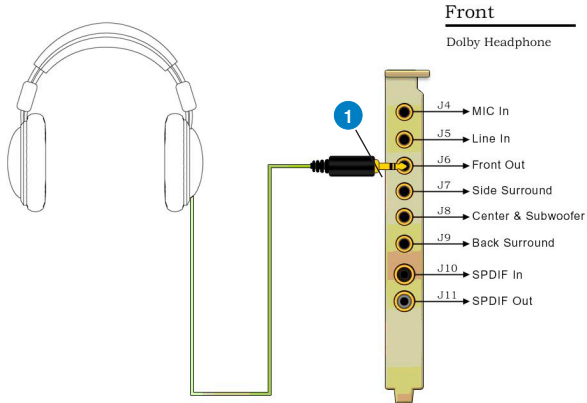

No	Item	Description
1	Front Out/Headphone Jack	The Front Out jack has a built-in high-quality amplifier to drive headphones. Please connect your stereo headphones directly to this jack.

## 5.2.2 Connecting 5.1 channel Headphones

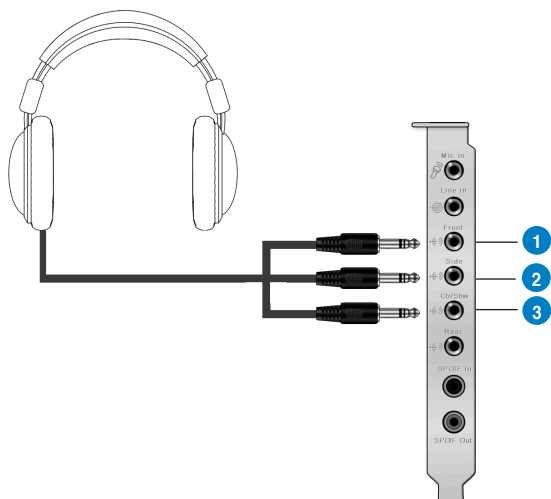

No	Item	Description
1	Front Out	Connect the front-channel 3.5mm plug of your 5.1 headphones into this jack.
2	Side Surround Out	Connect the surround-channel 3.5mm plug of your 5.1 headphone into this jack.
3	Center/Subwoofer Out	Connect the Center/Bass-channel 3.5mm plug of your 5.1 headphone into this jack.

## 5.3 Connecting Analog Speaker Systems

### 5.3.1 Connecting Analog Power Amplifier

#### Amplifier

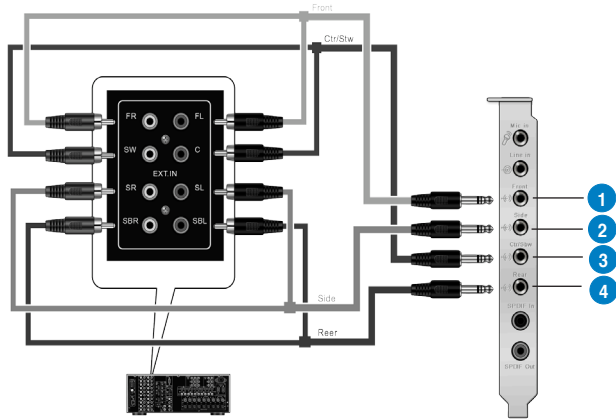

No	Item	Description
1	Front Out	Connects to the “left front” and “right front” input ports of the analog amplifier with the mini-jack to RCA cable.
2	Side Surround Out	Connects to the “left surround” and “right surround” input ports of the analog amplifier with the mini-jack to RCA cable.
3	Center/Subwoofer	Connects to the “Center” and “subwoofer” input ports of the analog amplifier with the mini-jack to RCA cable.
4	Back Surround Out	Connects to the “left back” and “right back” input ports of the analog amplifier with the mini-jack to RCA cable.

## 5.3.2 Connecting 2/2.1 Channel Speakers

### 2 Speakers

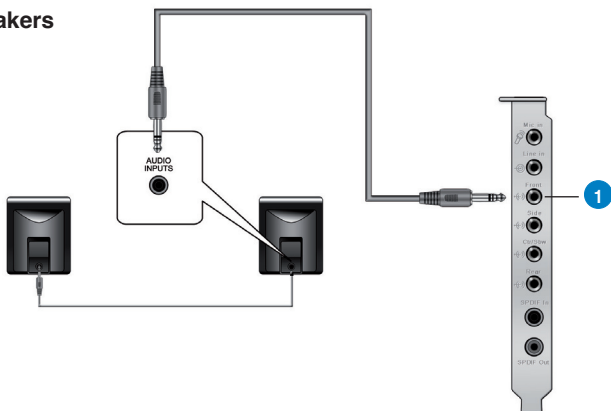

### 2.1 Speakers

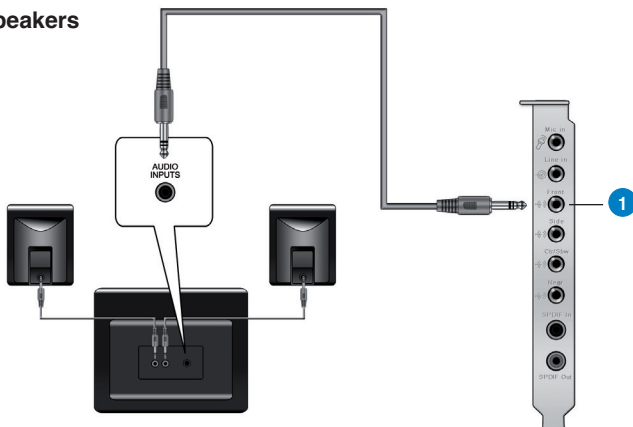

No	Item	Description
1	Front Out/Headphone Jack	Connect the 2/2.1 speaker set's 3.5mm plug into this Front Out jack.

### 5.3.3 Connecting 4/4.1 Channel Speakers

#### 4 Speakers

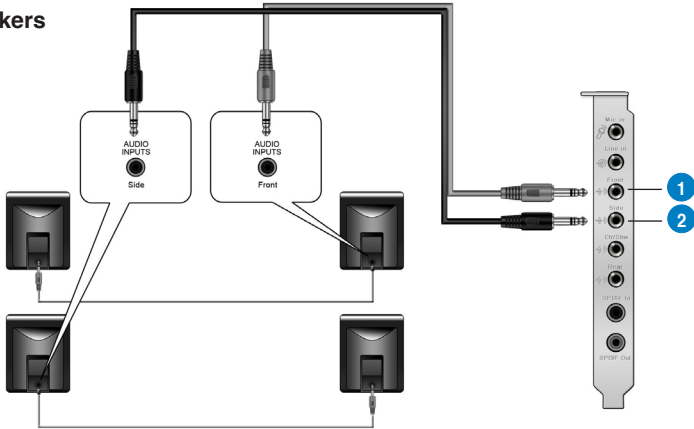

#### 4.1 Speakers

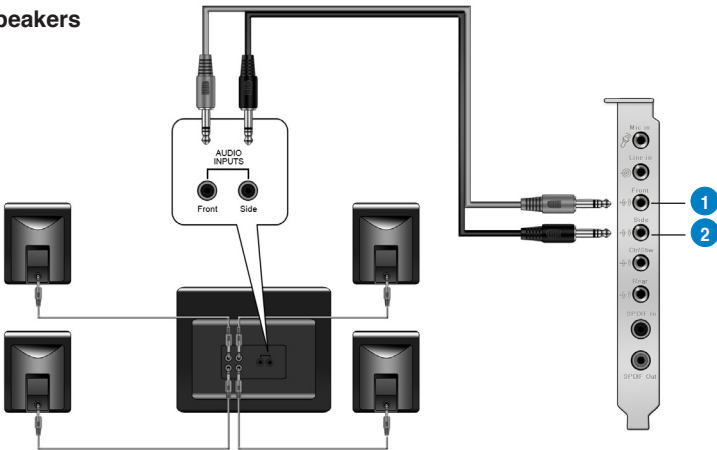

No	Item	Description
1	Front Out	Connects to the Front input port of the 4/4.1 speakers with the mini-jack cable.
2	Side Surround Out	Connects to the Surround input port of the 4/4.1 speakers with the mini-jack cable.

### 5.3.4 Connecting 5.1 Channel Speakers

#### 5.1 Speakers

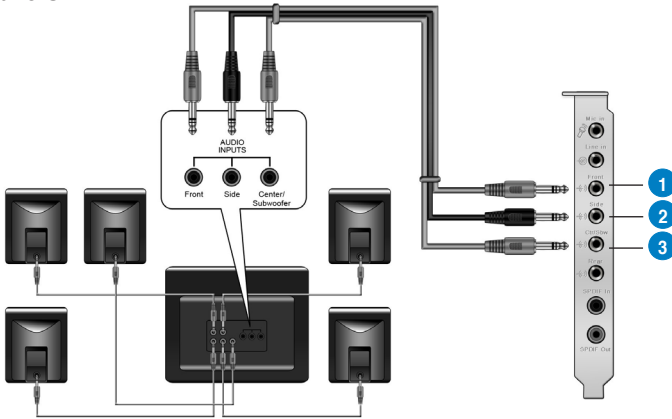

No	Item	Description
1	Front Out	Connects to the Front input port of the 5.1 speakers with the mini-jack cable.
2	Side Surround Out	Connects to the Surround input port of the 5.1 speakers with the mini-jack cable.
3	Center/Subwoofer	Connects to the Center/Subwoofer input port of the 5.1 speakers with the mini-jack cable..

### 5.3.5 Connecting 6.1/7.1 Channel Speakers

#### 6.1 Speakers

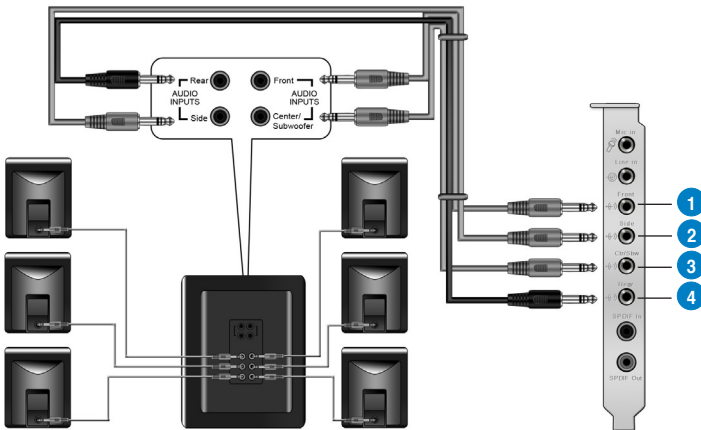

## 7.1 Speakers

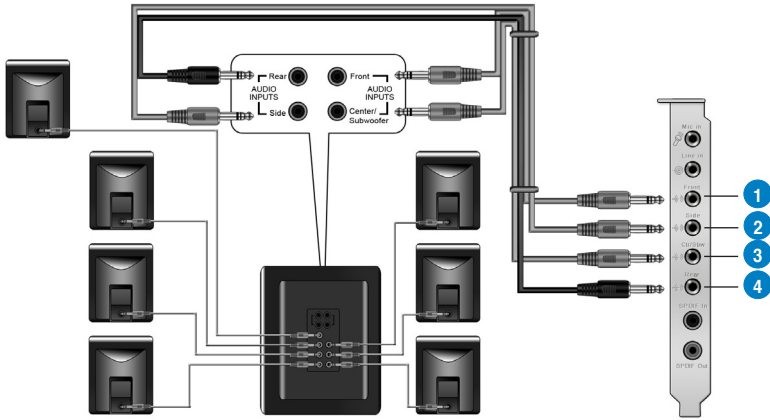

No	Item	Description
1	Front Out	Connects to the Front input port of the 6.1/7.1 speakers with the mini-jack cable.
2	Side Surround Out	Connects to the Surround input port of the 6.1/7.1 speakers with the mini-jack cable.
3	Center/Subwoofer	Connects to the Center/Subwoofer input port of the 6.1/7.1 speakers with the mini-jack cable.
4	Back Surround Out	Connects to the Back Surround input port of the 6.1/7.1 speakers with the mini-jack cable.

## 5.5 Connecting Microphone

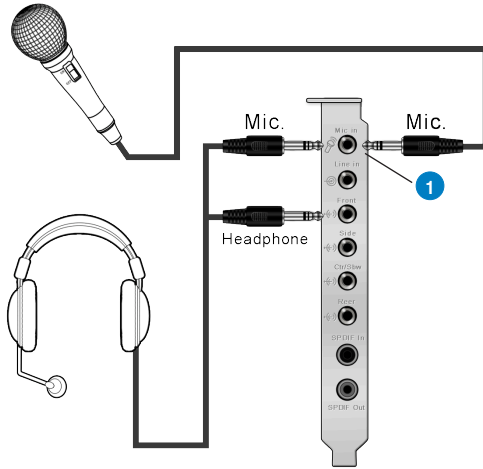

No	Item	Description
1	Microphone Input Jack	Connect the microphone's 3.5mm plug into this Mic-In jack for voice communication, recording, or karaoke.

## 5.6 Connecting Line-In Audio Sources

Line In

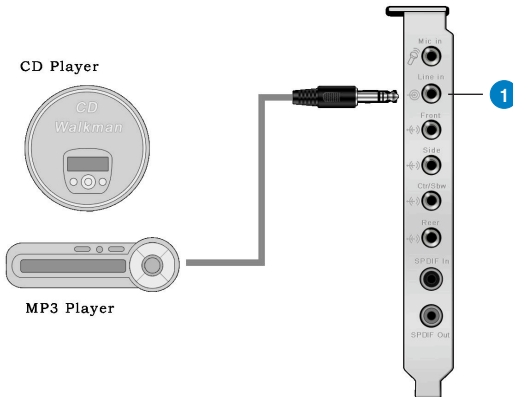

No	Item	Description
1	Line Input Jack	Connect the 3.5mm plug of the CD/MP3 Player or any other Line level analog audio sources into this Line-In jack for sound recording or real-time Dolby/DTS sound processing through the Monitoring path (See the "Mixer" section of the driver guide).



## 5.7 Connecting Digital Audio Sources

### SPDIF In CD/MD Player

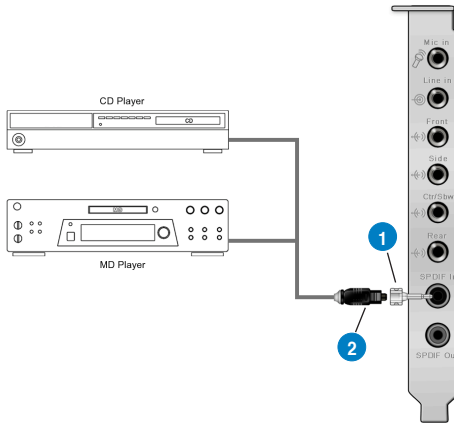

No	Item	Description
1	Optical adaptor	Plug the optical TOSLINK adaptor into the S/PDIF-In combo connector
2	Optical cable	Connect your MD/CD/DVD player's S/PDIF out port to the optical adaptor with the TOSLINK optical cable



You can also use a coaxial cable for a S/PDIF digital connection. Just plug the coaxial RCA male connector to the S/PDIF-In combo jack and connect the other end into the coaxial S/PDIF output on the player.

# 6. Xonar D2 Driver Guide

## 6.1 Introduction to the Xonar D2 Audio Center GUI

1. After the driver installation is complete and your computer has been rebooted, you will find the Xonar D2 Audio Center's icon in the system tray on the bottom right-hand corner of the screen. Double click this icon to open the Xonar Audio Center utility.



If the icon could not be found in the system tray, go to the Windows Control Panel and double click the "Xonar D2 Audio Center" icon.

2. The Xonar D2 Audio Center is the Graphic User Interface (GUI) for the Xonar D2 driver. You can control the functions and features of the Xonar D2 driver on the Audio Center. The following picture shows a basic overview of the Xonar D2 Audio Center. The following sections of this manual will describe its functions in more detail.



No	Item	Description
1	Display Area	This display area shows the 10-band signal meter, volume level, and the status of the Dolby/DTS technologies, EQ, and DSP modes. Note: this area just displays information, but is not used to alter settings.
2	Menu Open/Close	Clicking this button will move the display area and reveal the configuration area below. Clicking it again will move the display area back down.
3	Master Volume	This rotary knob controls the master playback volume. Drag the small circle inside it to change the volume level.
4	SVN Button	Click this button to enable the "Smart Volume Normalization" feature for constant volume from all playback sources. It will display a blue light when enabled.
5	Mute Button	Click this button to mute audio playback; it will display a red light when playback is muted.
6	DSP Mode	These 4 buttons give access to quick sound effects combinations for Music, Games, DVD Video, and effect-free (Hi-Fi) modes.
7	Application Links	These 4 buttons give quick access to ASUS PMP, PowerDVD, Sonar 6 LE, and Ableton Live.
8	Setting Menu Panel	This panel gives access to setting tabs, including Main Settings, Mixer/volume, Effects, Karaoke/MagicVoice, and FlexBass. (see the following details)
9	Information icon	Clicking this icon will pop up driver's Information window.

## 6.2 Main Setting

### 6.2.1 Sample Rate

The Sample rate determines the number of audio samples per second that the Digital-to-Analog Converters (DAC) and S/PDIF digital interface will output. The Xonar D2 audio card can support sample rates up to 192KHz (44.1K, 48K, 96K, 192KHz). Usually audio CDs and MP3 files are 44.1KHz; DVD-Video uses 48KHz; DVD-Audio or other HD media may contain 96KHz or 192KHz high-definition audio content. Please select the corresponding sample rate for your playback sources to get the best audio fidelity. Even if your setting differs from the audio source's sample rate, the Xonar D2 engine will do super high fidelity sample-rate-conversion with a double floating-point filter, which can reduce total harmonic distortion (THD+N) by -140dB.

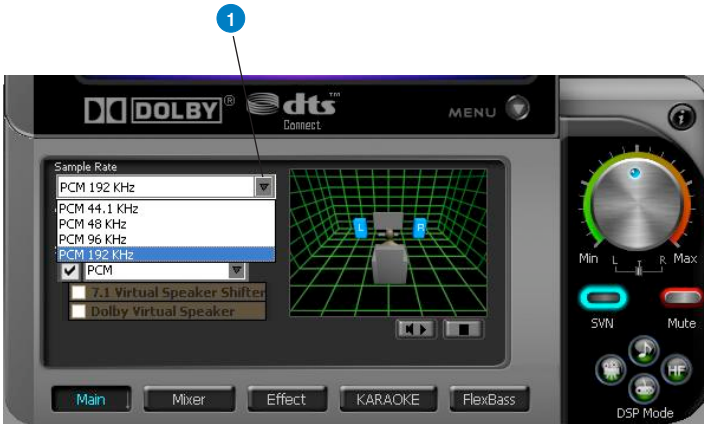

No	Item	Description
1	Sample Rate	<p>Please select the sample rate that corresponds to (or exceeds that of) your playback sources, for optimal audio fidelity. The Xonar D2 audio card supports sample rates up to 192KHz (44.1K, 48K, 96K, 192KHz). Typical values:</p> <ul style="list-style-type: none"><li>-Audio CD, MP3, WMA, Wave files are 44.1KHz;</li><li>-The audio of DVD-Video is 48KHz;</li><li>-DVD-Audio or other HD media may contain 96KHz or 192KHz high-definition audio content.</li></ul>

## 6.2.2 Analog Out/Speaker Test

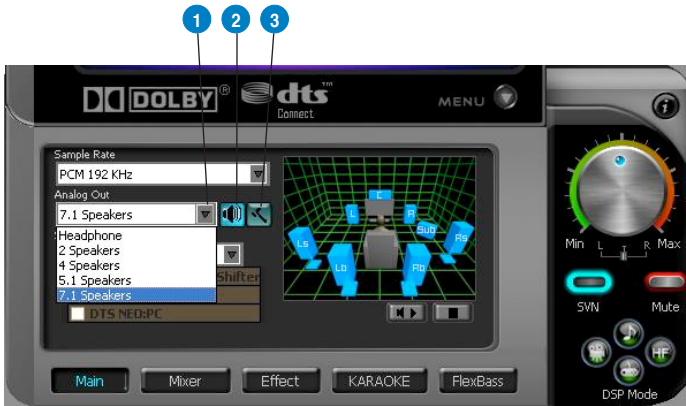

No	Item	Description
1	Analog Out	The Analog Out setting is used to match your actual speaker setting, such as headphones, 2 speakers (or 2.1), 4 speakers (or 4.1), 5.1 speakers, and 7.1 speakers. Xonar D2 will play the channels and do the proper 3D/Dolby/DTS sound processing accordingly. Please select the correct speaker type for your connected speakers.
2	Speaker Test	Click this button to show the speaker test window in the right pane. Click the “play” button to test each speaker one by one or click each speaker manually to test.  (note: the Speaker Test function is not available on Windows Vista due to a limitation in its audio stack.)
3	Speaker Swap	Clicking this button will pop up an advanced setting window to allow you to: <ul style="list-style-type: none"> <li>–Swap center/bass outputs for 5.1/7.1-speaker set ups</li> <li>–Swap Side/Surround outputs for 7.1-speaker set ups</li> </ul> Check the box if your speakers are outputting the incorrect channel. Otherwise, leave them blank.

### 6.2.3 SPDIF Out/DDL/DTS Interactive

Xonar D2 is capable of outputting Dolby Digital Live and DTS Interactive, which are real-time encoders that transcode any audio, including games and music, into industry-standard Dolby Digital or DTS 5.1 bit-streams on-the-fly. This is ideal for playback through a home theater system, creating an immersive and impressive cinema surround sound experience. It enables a single digital connection to carry high quality Dolby Digital or DTS 5.1 surround audio from your PC to digital speakers and AV Receivers.



No	Item	Description
1	S/PDIF Out enable/disable	Click this check box to enable S/PDIF output.
2	S/PDIF Output Formats/Functions	This pull-down menu allows you to select one of the following four formats: -PCM (Pulse Code Modulation, which is a typical raw audio data format.) -Dolby Digital Live real-time 5.1ch encoding -DTS Interactive real-time 5.1ch encoding -S/PDIF In Loopback to output (typically useful for coaxial/optical connection transformation)
3	Dolby Digital Live advanced upmixing option	This advanced setting will automatically upmix stereo (2ch) content to 5.1 channel surround with Dolby Pro-Logic II when using Dolby Digital Live output.

## 6.2.4 Audio Channels (For Vista only)

This setting only appears in Windows Vista. Vista will deliver the audio channels to the audio driver according to this setting, no matter what the original audio content is or how many channels they have. Therefore, you need to set this in accordance with your audio content before you play it. Please note that this setting is synchronized with Vista's system speaker configuration and changing the setting during playback will cease the audio playback program. You may have to restart the program after the change. It's recommended that you close all playing programs before you change the setting.

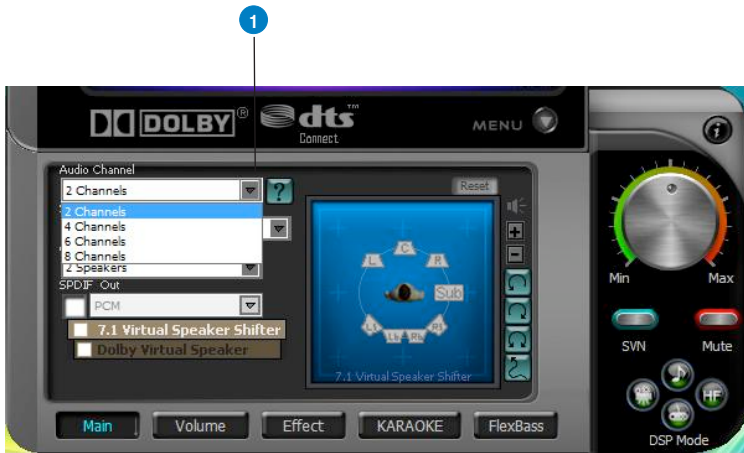

No	Item	Description
1	Audio Channels	Here are some typical suggestions: <ul style="list-style-type: none"><li>-MP3, WMA, AAC, CD, VCD, 2D games =&gt; 2 channels</li><li>-DVD-Video with Dolby Digital or DTS 5.1 =&gt; 6 channels</li><li>-DVD-Video with Dolby Digital EX or DTS ES =&gt; 8 channels</li><li>-3D games =&gt; 8 channels</li></ul>

## 6.2.5 7.1 Virtual Speaker Shifter

The 7.1 Virtual Speaker Shifter has the following major features:

- Expanding/upmixing audio to 7.1-channel surround sound
- Virtualizing 7.1 surround sound over any set of speakers
- Shiftable virtual speaker positioning allows you to adjust the best sound field easily without moving physical speakers and wires

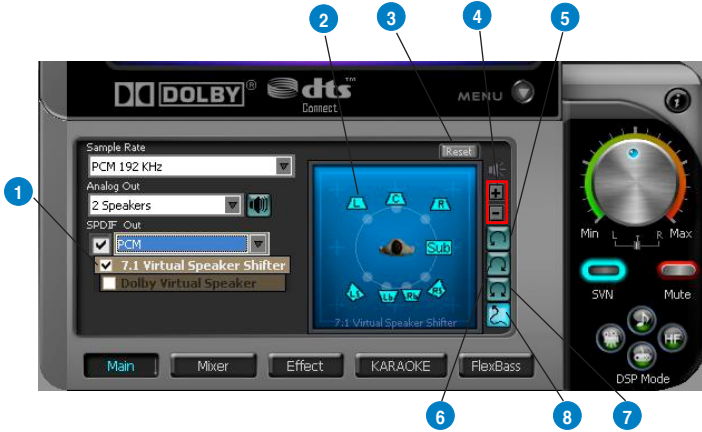

No	Item	Description
1	Shifter enable/disable	Click this check box to enable the 7.1 Virtual Speaker Shifter. Clicking the text bar will switch the right window to the Speaker Shifter page for manual adjustments.
2	Drag speaker or listener	You can drag each speaker or listener to a different relative position "virtually" using only your mouse. The Xonar D2 audio card will process it and virtualize each speaker position in real-time. The Subwoofer has no directional sounds, and hence can be moved only closer or further away.
3	Reset	Reset all Speaker Shifter settings to the defaults.
4	Increase/decrease volume	Click + to increase volume (move speakers closer); click - to decrease volume (move speakers further away)
5	Counter-clockwise	Make all speakers (except Subwoofer) rotate counter-clockwise
6	Clockwise	Make all speakers (except Subwoofer) rotate clockwise
7	Manual Rotation	Manually drag and rotate all speakers (except Subwoofer)
8	Manual Drag Mode	This is the default mode that allows you to manually drag each speaker or the listener with your mouse.



## 6.2.6 Dolby Pro-Logic IIx

Dolby Pro-Logic IIx is a 7.1 surround upmixing technology and is widely used in home theater systems, TVs, game consoles, and car audio systems. It can expand stereo audio, such as MP3, CD, and TV programs into immersive 5.1 or 7.1-channel surround.

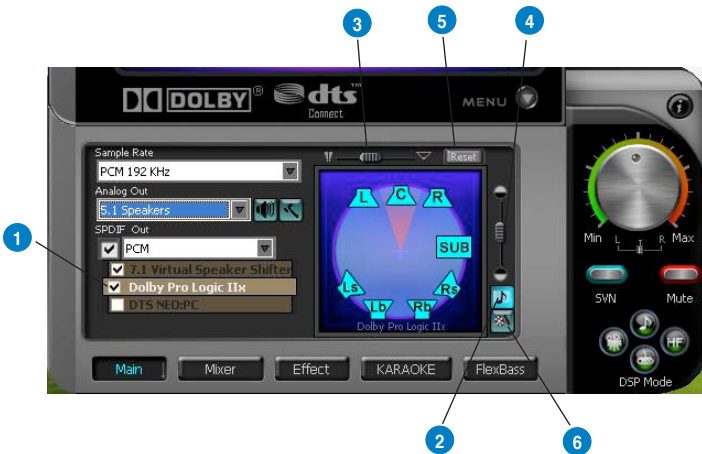

No	Item	Description
1	Dolby Pro-Logic IIx enable/disable	Click this check box to enable Dolby Pro-Logic IIx. Clicking the text bar will switch the right window to the Pro-Logic IIx page for manual adjustments.
2	Music Mode	Music mode is the default mode for regular music playback. In this mode, you can adjust the Center Width and Dimension parameters.
3	Center Width	This parameter is used to set the spread of the center, mainly for the vocal signals of songs and music. Drag the scroll bar to the left to centralize the vocal signal. Drag to the right side to widen the vocal sound range.
4	Dimension	The dimension parameter fades sounds to the front or rear of the listener.
5	Reset	Reset all settings to the defaults.
6	Movie Mode	Movie mode is a preset optimized for movie audio.

### 6.2.7 DTS Neo:PC

DTS Neo:PC is another 2-to-7.1 channel upmixing technology, using a sophisticated algorithm from DTS Labs. It can spread stereo audio such as MP3, CD, and TV programs into an immersive 5.1 or 7.1-channel surround sound environment.

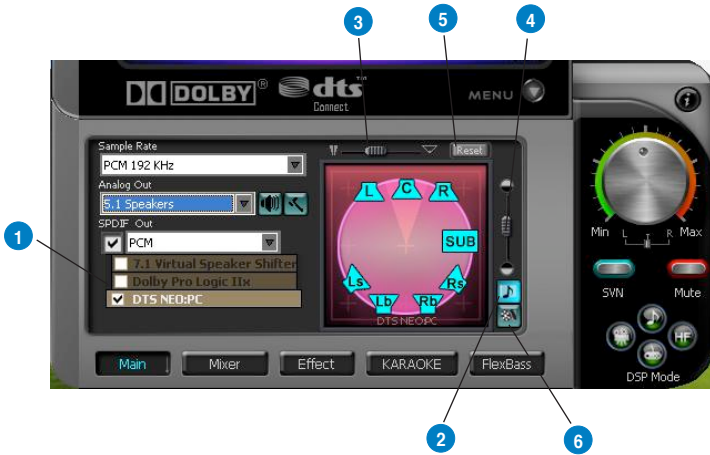

No	Item	Description
1	DTS Neo:PC enable/disable	Click this check box to enable DTS Neo:PC. Clicking the text bar will switch the right window to a DTS Neo:PC page for manual adjustments.
2	Music Mode	Music mode is the default mode for regular music playback. In this mode, you can adjust the Center Width and Dimension parameters.
3	Center Width	This parameter is used to set the spread of the center, mainly for the vocal signals of songs and music. Drag the scroll bar to the left to centralize the vocal signal. Drag to the right side to widen the vocal sound range.
4	Dimension	The dimension parameter fades sounds to the front or rear of the listener.
5	Reset	Reset all settings to the defaults.
6	Movie Mode	Movie mode is optimized for movie audio.

## 6.2.8 Dolby Headphone

Dolby Headphone creates a stunning multi-channel surround experience over ordinary stereo headphones for playing 3D games, watching 5.1 DVD movies, and listening to music. Dolby Headphone produces surround sound cues so realistic that you will believe you are listening over speakers in a well-controlled studio. Dolby Headphone can also improve listening comfort and reduce "listener fatigue" from long listening over headphones.





No	Item	Description
1	Dolby Headphone enable/disable	Click this check box to enable Dolby Headphone. Clicking the text bar will switch the right window to Dolby Headphone page for manual adjusting.
2	DH1	Dolby Headphone (DH) provides three room filters that may be used with any type of audio. They differ in the sense of the "spatial dimension" they impart.  DH1—Reference Room: Small, acoustically damped room.
3	DH2	DH2—Livelier Room: More acoustically live than DH1
4	DH3	DH3—Larger Room: Larger room than DH1; more distant and diffused effect.

## 6.2.8 Dolby Virtual Speaker

Dolby Virtual Speaker technology simulates a 5.1-speaker surround sound listening environment from as few as two speakers. Dolby Virtual Speaker also creates a wider two-channel environment during playback of stereo CDs and MP3 content, and when combined with Dolby Pro Logic® II processing, delivers a virtual 5.1-channel surround listening experience from any high-quality stereo source.



No	Item	Description
1	Dolby Virtual Speaker enable/disable	Click this check box to enable Dolby Virtual Speaker. Clicking the text bar will switch the right window to a Dolby Virtual Speaker page for manual adjusting.
2	Reference Mode	Dolby Virtual Speaker provides two modes of virtualization: The first is Reference mode, which virtualizes the missing speakers as in the following picture. 
3	Wide Mode	DH3—Larger Room: Larger room than DH1; more distant and diffused effect. 

## 6.3 Mixer/Volume

The mixer page is designed to control the volume for playback and recording on the Xonar D2. In addition, the Xonar D2 also provides a high-quality digital monitoring function for hearing the recorded audio from the speakers. You can also process the input signals with all playback sound effects such as Dolby and DTS technologies.

### 6.3.1 Playback Volume





No	Item	Description
1	Playback Volume Tab	Click this button to show the playback volume page.
2	Source/Path Name	This shows the source name for each volume control slider, including: <ul style="list-style-type: none"> <li>- WAVE: All digital audio sources except MIDI files</li> <li>- SW: Software Synthesizer; control the playback volume of the MIDI files</li> <li>- CD: CD-ROM digital playback (CD-DA) volume control</li> <li>- LEFT, RIGHT...: the volume control for each speaker/channel.</li> </ul> Note: Windows® Vista doesn't support WAVE, Synthesizer and CD-In volume controls.
3	Mute/Unmute button	Click this button to mute or unmute the audio channel.
4	Volume Slider	Drag this slider down to decrease the volume; drag it up to increase the volume. The tool-tip reveals the percentage number from 1 to 100 in terms of the full scale level.
5	Left/Right Balance	The horizontal slider controls the volume between the left and right channels.
6	Reset	Reset all volume controls to the default settings

### 6.3.2 Recording/Monitoring Volume



No	Item	Description
1	Recording Volume Tab	Click this button to show the recording volume page.
2	Source/Path Name	<p>This shows the source name for each volume control slider, including:</p> <p>S/PDIF-In: S/PDIF digital input source</p> <p>Mix: Stereo Mix which will record all analog inputs and digital wave audio you are playing on PC</p> <p>ALT: high-quality analog loop-back recording from front line-out</p> <p>CD-In: recording from CD-In for CD-ROM player</p> <p>Aux: recording from Aux-In for typically TV-tuner card audio or other sound sources</p> <p>Line-In: recording from Line-in jack for external audio devices</p> <p>WAVE: recording from digital wave audio you are playing on PC (Note: Windows Vista doesn't support WAVE recording.)</p>
3	Monitoring button	<p>Click this button to monitor and loopback recording audio to outputs (PC speakers). Therefore, the recording volume will influence the monitoring signals from speaker outputs. The audio will be mixed into the streams you are playing out from your PC and all DSP effects will be applied to the source, too. A typical benefit is to apply Dolby Pro-Logic IIx 7.1-ch spreading for your TV audio, CD, MP3, or stereo game console audio from Wii, Xbox, PS2/PS3/PSP, etc. To apply Dolby Virtual Speaker is suitable for two-speaker environment.</p>

4	<b>Recording Selector button</b>	Click this button to select the path/source you are going to record. Please note that the recording function on Windows is a one-path selector. So, you can select only one default recording source at a time. You may have to restart the recorder program if you switch to a different source. (Note: On Vista, some application programs may allow you to select the recording device/path in the recording programs themselves.)
5	<b>Recording Volume Slider</b>	Drag this slider down to decrease the recording volume; drag up to increase the recording volume. The tool-tip reveals the percentage number from 1 to 100 in terms of the full scale level.
6	<b>Left/Right Balance</b>	This horizontal slider controls the volume between the left and right channels.
7	<b>Reset</b>	Reset all volume controls to the default settings
8	<b>S/PDIF-In Advanced Setting</b>	<p>Click this button to open the advanced settings for the S/PDIF-In:</p>  <p>Enabling "Validity Check" will check out the PCM audio validity bit of S/PDIF input stream to prevent recording or monitoring non-PCM/not recordable audio (such as AC3, etc.), which will become unrecognizable sounds from your speakers.</p>
9	<b>Microphone-In Advanced Setting</b>	<p>Click this button to open the advanced settings for the Microphone-In:</p>  <p>Enabling "Microphone Boost" will increase a volume gain to boost microphone input signals. For typical low-cost PC microphone, it's recommended to enable this function.</p>

## 6.4 Effects

### 6.4.1 Environment Effects

Environment effects can be used to create realistic listening experiences that mimic different environments. There are a total of 27 environment options, which can be applied to all 2D sound sources, like music.



No	Item	Description
1	Default Environments	These four buttons activate Bathroom, Concert hall, Underwater, and Music Pub environments, respectively.
2	More Option	Clicking this button will apply the environment effect that you select from the pull-down menu on the right side. There are another 23 options in this menu.
3	Environment Size	There are three size settings for each environment: Large, Medium, and Small.



## 6.4.2 10-Band Equalizer

The equalizer can modify the audio output for different frequencies, and be used to compensate for deficiencies in your speakers/systems. There are 12 default patterns and you can also make your own settings.



No	Item	Description
1	Default Equalizer Options	There are 12 available equalizer patterns. Click one to apply it.
2	User Defined	You can click this button to apply your own defined parameters saved in the pull-down menu.
3	Equalizer Slider	Adjust the gain for each band (30~16KHz)
4	Save Name	Key in a name for your own "User Defined" equalizer setting
5	Add/Save	Click this + button to save the parameters into User Defined list
6	Delete	Click this - button to delete the parameters from User Defined list

## 6.5 Karaoke/Magic Voice

The Xonar D2 provides powerful features for VOIP and Karaoke, including Magic Voice, Microphone Echo, Key-Shifting, and Vocal Cancellation. Magic Voice is a great feature for disguising your voice (using monster/cartoon/male/female effects) for VOIP and online gaming applications. Microphone Echo can generate natural echo effects on your singing voice just like a karaoke machine. Key-Shifting can change the pitch of Karaoke background music, and Vocal Cancellation can reduce the original vocal in songs and keep the music and symphony for karaoke.



No	Item	Description
1	On/Off	The switch to turn on or off the functions on this page.
2	Mic Effect On/Off	Check the box to enable or disable mic effects including Microphone Echo for voice or Magic Voice for changing your voice's sound.
3	Mic Echo	Select the Mic Echo function and adjust the gain for echo signals (30~16KHz)
4	Magic Voice	Select Magic Voice and choose a mode from 5 options: default, Monster, Cartoon, Male, and Female styles.
5	Key-Shifting	Check the box to enable or disable the key shifting feature for music playback from 4 semitones below, to 4 semitones above.
6	Key-Shifting	Checkbox to enable or disable the vocal cancellation function and adjust the voice cancellation level from 0 to +100. +100 will eliminate most original vocals (default value is 50).
7	Reset	Reset all settings to the default.

## 6.6 FlexBass

FlexBass, an advanced bass management and enhancement mechanism, allows you to select each satellite speaker's type for optimal sound performance from the speakers. (Small: common speaker that cannot produce low frequencies; Large: wide-band speakers that can produce low frequencies well). It comes with an adjustable crossover frequency for the boundary of the bass signals. FlexBass will filter out the bass signals from small speaker channels and redirect them all to the subwoofer or Large speakers.

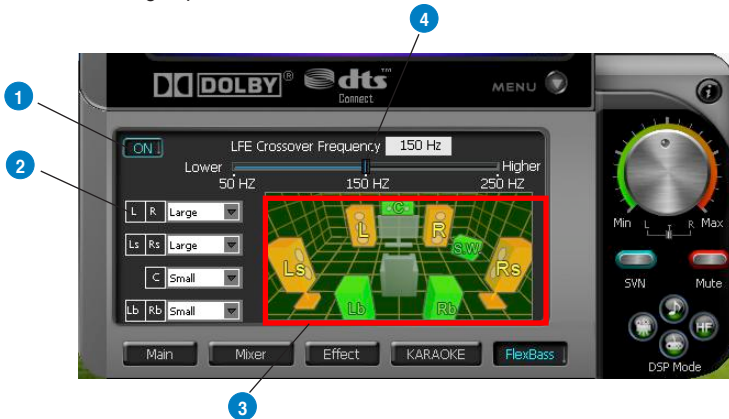

No	Item	Description
1	On/Off	The switch to turn on or off all functions on this FlexBass page.
2	Small/Large speaker option	Select the speaker type that you connected. If your speaker type cannot perform low-frequency signals (bass), please select "Small" speaker type and Xonar D2 will filter out the bass signals and send them to the subwoofer channel. If those speakers are full-range, you can select the "Large" speaker type.  Note: Common, cheap PC's 2-channel speakers are usually small-type speakers. Please refer to the speaker's specification. If you have any questions, please consult your speaker vendor. However, common 2.1 speakers with a subwoofer should be categorized as Large speakers because the subwoofer can redirect the bass signals inside the two channels to the subwoofer speaker automatically.
3	Picture for Small/ Large speaker	Colors for small/large speakers are different. Orange: large speakers Green: small speakers

4	LFE Crossover Frequency	Adjusts the cut-off frequency (50~250Hz) for LFE (low-frequency effects) signals. Xonar D2 will filter out the bass signals below the crossover frequency from small speaker channels and forward them to the subwoofer. The higher the crossover frequency, the more bass signals will be subtracted.
---	-------------------------	--

## 6.7 Smart Volume Normalization

Smart Volume Normalization™ (SVN) automatically keeps all music or video/TV audio output at a constant level to reduce manual adjustment hassles inherent with sound sources of different loudness. It allows you to listen to various content, like MP3, TV program, DVD video and even games with consistent sound level. The following graph shows how different signals 1 & 2 will become the same level (for example, 10dB below full scale) after you turn on SVN. Please note that for lower volume music 2, it will become louder when you turn on SVN; and for higher volume music 1, it will become quieter.

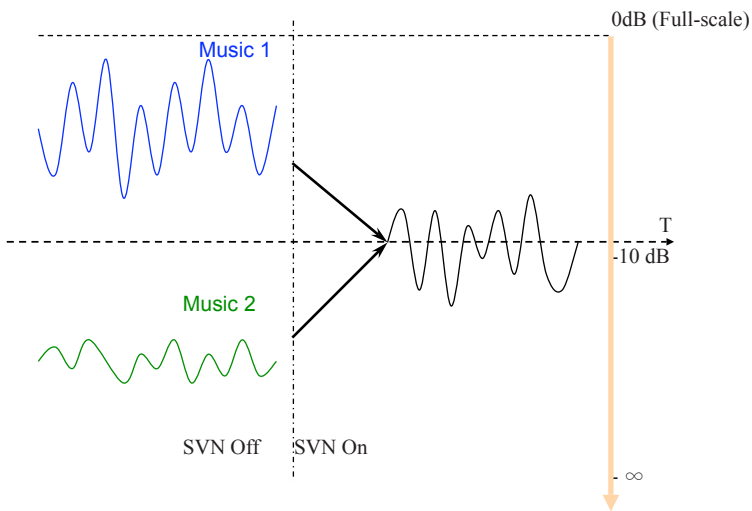



No	Item	Description
1	SVN On/Off	Click this button to enable SVN. This button is outlined blue when active.
2	SVN Display	When SVN is enabled, "Smart Volume" will be lit up at the bottom of the volume meter and the volume meter will show the level.
3	SVN Blue Light	When SVN is enabled, the master volume knob will be illuminated by a blue light. It will be lit red if the volume is muted.

## 6.8 DSP Modes

Besides the abundant sound effects described above, the Xonar D2 also provides quick Digital Sound Processing modes which are configured for typical applications including Music, Movies, and Games over different output speaker types. In addition, Xonar D2 also offers a Hi-Fi mode for hi-fidelity playback without any effect processing to keep the original audio fidelity. Every time you turn on Hi-Fi mode, Xonar D2 will clear all sound effects. It's also recommended to use Hi-Fi mode for audio quality tests (using RMAA software or another machine-based measurement). Use the DSP mode button as the quick setup if you don't wish to know the details of the effect setup. (note: no sound effects will be applied to high-definition 96KHz/192KHz content.)

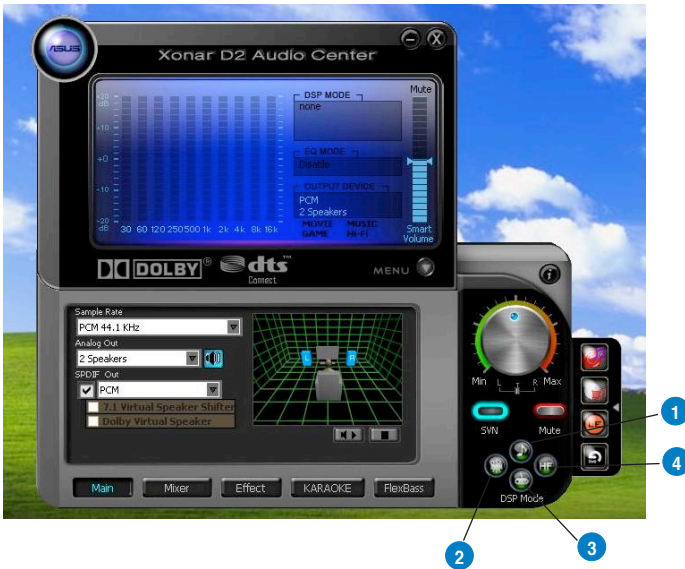

No	Item	Description
1	Music Mode	This mode is set for Music playback.
2	Movie Mode	This mode is set for DVD Movie playback.
3	Game Mode	This mode is set for Games.
4	Hi-Fi Mode	This mode is set for Hi-Fidelity playback, where all effects will be cleared to keep the original digital data and analog output quality as high as possible.

## 6.9 ASIO 2 Driver

ASIO™ (Audio Stream Input Output) is a proprietary audio driver architecture and a trademark of Steinberg Media Technologies GmbH. The Xonar D2 driver package has included an ASIO2 compatible driver for application programs that have ASIO or ASIO2 output. ASIO can ensure lower latency during playback and recording on PCs, which is very important for professional music creation and editing. The Xonar D2 package also provides Ableton Live and Sonar LE audio editing software, which all support ASIO output. The setup reference is described below.

### When Using Ableton Live...

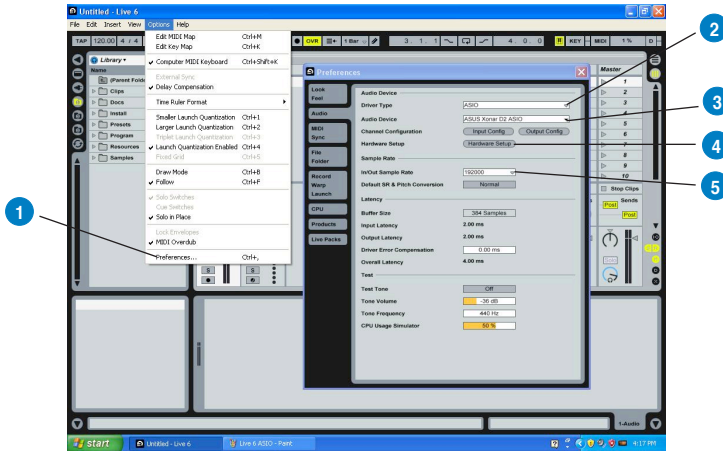

No	Item	Description
1	Preferences	Step 1 is to open the “Preferences” window from the Options tab.
2	Driver Type	Step 2 is to select “ASIO” as the driver type. (WDM and MME are other Windows driver types)
3	Audio Device	Step 3 is to choose “ASUS Xonar D2 ASIO” as the Audio Device.
4	Hardware Setup	Step 4 is to click the Hardware Setup to configure the Bit-depth (16/24bit) and latency (1ms~300ms).
5	Sample Rate	Step 5 is to select the sample rate from 44.1, 48, 96, 192KHz.



## When Using Sonar LE...

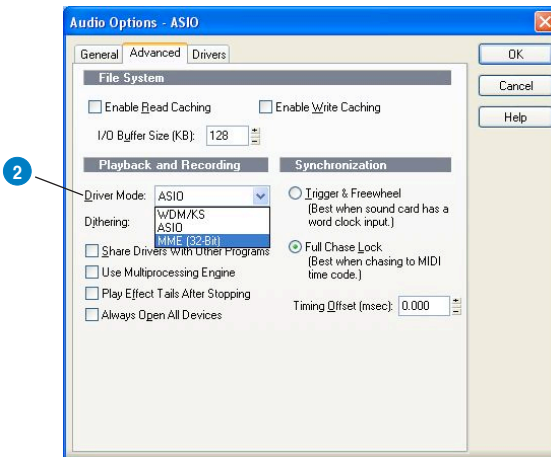
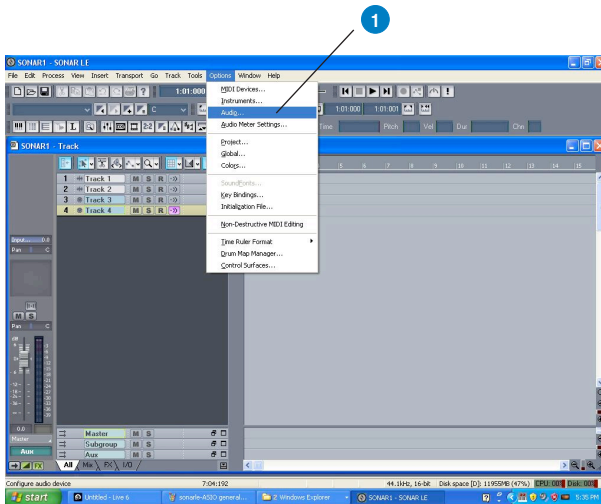



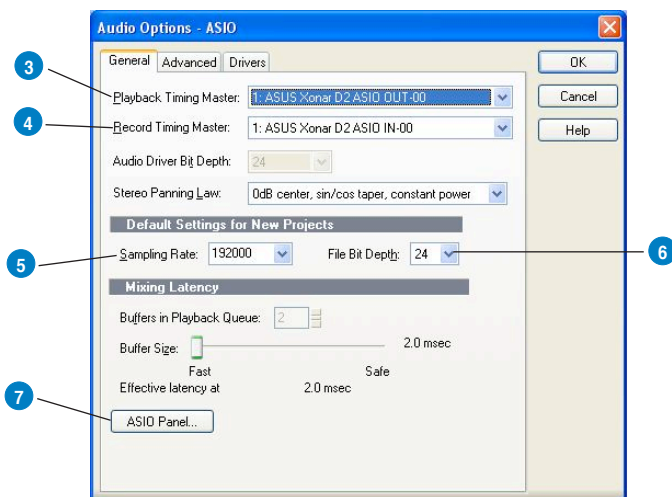

No	Item	Description
1	Audio Options	Step 1 is to open the "Audio Options" window from the Options tab.
2	Driver Mode	Step 2 is to select "ASIO" as the driver mode in Advanced tab. (WDM and MME are Windows driver types) The changes will take effect after you restart the program next time.
3	Playback Timing Master	After step 2, Sonar LE will display 4 output drivers: "ASUS Xonar D2 ASIO Out -00~06". Make sure you are using 00 or another one.
4	Recording Timing Master	After step 2, Sonar LE will display 1 input driver: "ASUS Xonar D2 ASIO In -00". Make sure you are using it.
5	Sample Rate	Step 5 is to select the default file sample rate (44.1, 48, 96, or 192KHz) for your Sonar project.
6	Bit-depth	Step 6 is to select the default file bit-depth (16/24bit) for your project.
7	ASIO Panel	If you would like to configure bit-depth (16/24bit) and latency (1ms~300ms) of the Xonar D2 ASIO driver, click this ASIO panel to reset them. The changes will take effect the next time you start the program.



For other applications that support ASIO, such as WaveLab, Cubase, Reason, Winamp, etc, the setup will be very similar to the above.

# 7. Portable Music Processor™ Soft-ware Guide

## 7.1 Introduction

Xonar D2 provides the Portable Music Processor™ (referred to as PMP hereafter) software tool that contains the following features:

- Converts MP3, WMA, AAC (iTunes required), Audio CD, WAVE into WMA or MP3 files with the same ID3 information and post processor effects
- Adds Dolby Headphone processing to regular music content for a better listening experience over stereo headphones
- Adds Dolby Virtual Speaker (w/ Pro-Logic II) effect to regular music for virtual 5.1 surround over stereo speakers
- Normalizes the volume level of your music collection with Smart Volume Normalization (SVN) effect
- Provides Analog Loopback Transformation (ALT) technology for high-quality (118dB SNR) accelerated analog recording
- Supports MP3 and WMA encoding formats for 128~320Kbps data rates (Windows Media Player 10 or later version and MP3, WMA codecs are required)
- Supports transformation speed up to a maximum of 40 times of the normal playback speed (High Speed mode). (The maximum speed is just for your reference because it's related to your PC's performance and the sound effects you choose to add. Using ALT recording technology will be limited up to 2X speed on Windows XP. On Vista, the speed will be currently limited to normal 1X all the time.)



- 
- As of this writing, iTunes is not available for Windows Vista. As a result, converting iTunes music on Vista is not supported.
  - If you are going to convert copyright protected music with ALT, you must have valid and legal right to access and play the content. PMP is just a software tool to record the playback analog output signal. Please be careful to abide by the agreement with your content provider.
- 

Before you use PMP software, make sure the following items have been completed:

1. Xonar D2 Audio Card has been installed in your PC
2. The Xonar D2 driver has been installed (Xonar D2 audio converter driver is installed for PMP utility)
3. Windows Media Player Ver. 10 or above has been installed on your PC (If it hasn't, Xonar D2 installer will provide a guide to downloading WMP 10)

- You will also need an MP3 encoder installed to encode music into MP3 format (If you don't have this already, the Xonar D2 installer will provide a guide message to download a free MP3 encoder)

After PMP is installed, you will find a PMP shortcut icon on the desktop. Double click the icon and PMP will show up as below.

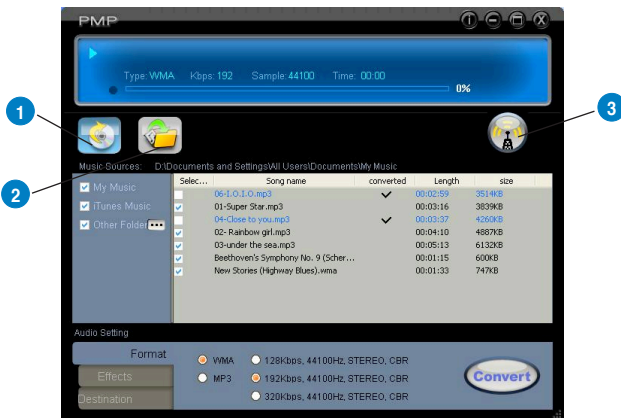



No	Item	Description
1	Main Setting page	Default page to setup and start the music conversion
2	PMP Music page	This page will display the converted music files saved in the "PMP Music" folder
3	Software Update	This button is used to check online for upgrades to the PMP software and download it for upgrade (make sure your computer is connected to the Internet before you click the button)

## 7.2 Converting music in “Main Setting” Page

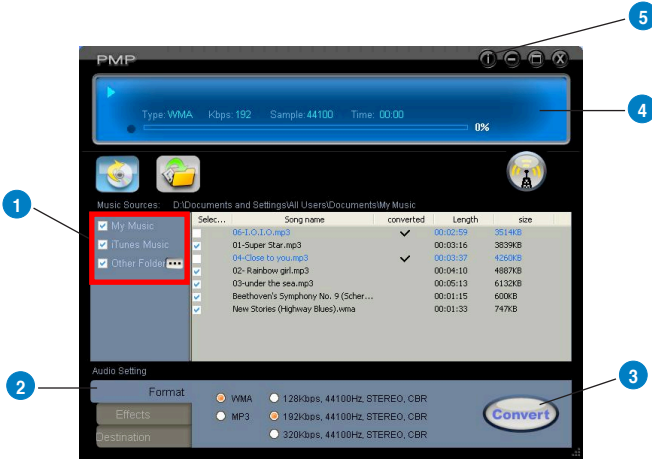
Click the main setting page to start the PMP music conversion process.



No	Item	Description
1	Select Music Sources	<p>Step 1 is to prepare the music sources that you are going to convert. You can select 3 music source folders which can be multiply checked:</p> <ol style="list-style-type: none"> <li>1) My Music – This path is locked and refers to C:\Documents and Settings\My Documents\My Music.</li> <li>2) iTunes Music – The path is locked and refers to C:\Documents and Settings\My Documents\iTunes Music.</li> <li>3) Others – The default path refers to C:\Documents and Settings\My Documents\My Music but can be designated to other folder by clicking .</li> </ol> <p>In the right side of the window, you will see all of the music files from the selected folders that can be converted by PMP. You can select all or click each check box to choose which file to be converted later. The files that have been converted during the process will show a check mark in the status column.</p>

2	Conversion settings	<p>Step 2 is to set the conversion settings you would like. There are three tabs for different settings:</p> <p>1) Format: select MP3 or WMA to be the converted format you would like to have. You can also choose the bitrate from 128Kbps, 192Kbps, and 320Kbps (the higher bitrate, the higher quality but bigger file size)</p> <p>2) Effect: You can choose to add three effects into the converted files: Smart Volume Normalization (to normalize all volume of your music files to a constant level), Dolby Headphone (natural spatial effect for headphones), and Dolby Virtual Speaker (with Pro-Logic II virtual surround effect for stereo speakers).</p> <p>3) Destination: This tab allows you to choose to save converted music to the default PMP Music folder, or to Other folder by clicking .</p>
3	Convert/Stop	<p>The final step is to click the button to start Converting. Clicking this button again while PMP is converting files will stop the process. Please note that the audio card will suspend operation while PMP is converting music to ensure conversion quality and stability. It's best to close other audio applications before you start converting.</p>
4	Display for converting status	<p>This display window will tell you the music being converted, file type, bitrate, spent time, converted percentage, and speed.</p>
5	Information page	<p>Clicking the information button will display the version of PMP that you have installed.</p>

## 7.2 Find Converted Music in “PMP Music” Page

The default conversion destination folder is C:\Program Files\ASUSPMP\PMP Music\. You can easily click the PMP Music page to find the converted music library. The new file name will be copied and suffixed with the data rate and DH (ie. Dolby Headphone) or DVS (ie. Dolby Virtual Speaker) if the effect is applied. For example:

Original file name: ABCD.mp3

Converted file name: ABCD\_192K\_DH.mp3 (meaning the data rate is 192Kbps with Dolby Headphone post-processing applied)



No	Item	Description
1	PMP Music page	This page shows the converted music library stored in the PMP Music folder.
2	Music Information	This window will display the song name and its artist, length, and size in the PMP Music folder.

## **8 Ableton Live Software Guide**

Please refer to the separate manual for Ableton Live.

## **9. Cakewalk Production Plus Pack Software Guide**

Please refer to the Help manual for these Cakewalk programs.

## 10. RMAA Test Guide

Xonar D2 driver CD includes RightMark Audio Analyzer (RMAA) v5.6, which is a popular software intended for testing the quality of analog and digital sound sections of any audio equipment, be it a sound card, portable MP3 player, consumer CD/DVD player, or a speaker system. The measurements are conducted by playing and recording test signals, as well as using frequency analysis algorithms. The following provides a step-by-step and easiest loop-back test guide for your Xonar D2 audio card.

### 10.1 Setting Up Xonar D2 Audio Card

Open Xonar D2 Audio Center. Do the settings below:

1. Select sample rate you will be using with RMAA (here we set 48KHz for testing 48KHz/24bit signals).
2. Set analog output to 2-speaker mode (to get rid of any channel processing over RMAA stereo signals in the driver)
3. Turn off all sound effects including Dolby, DTS, 7.1 speaker shifter, EQ, Environment, etc. A quick way to do so is to enable “Hi-Fi mode” button in the Audio Center.

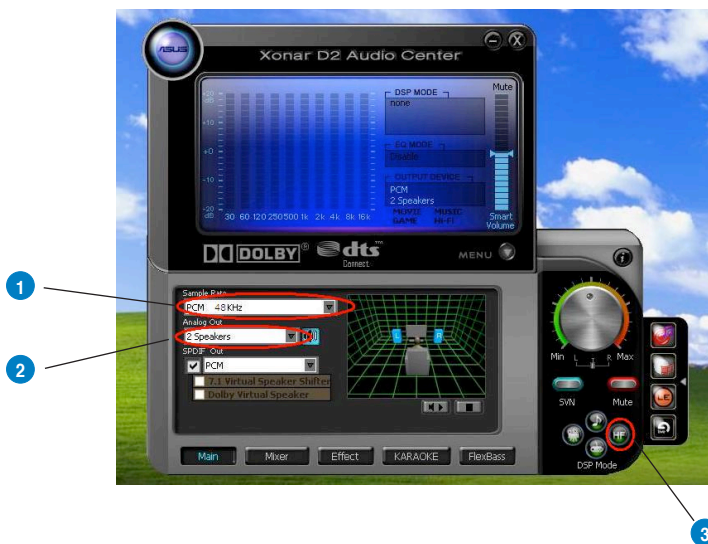



- Go to Mixer Recording page and select "ALT" as the recording source. Click "Reset" to make sure the recording volume is on the default highest level (0dB). This is actually a high-quality onboard path from the Line-Out directly to the Line-In. This allows you to get realistic output and input quality ratings for the Xonar D2 audio card.

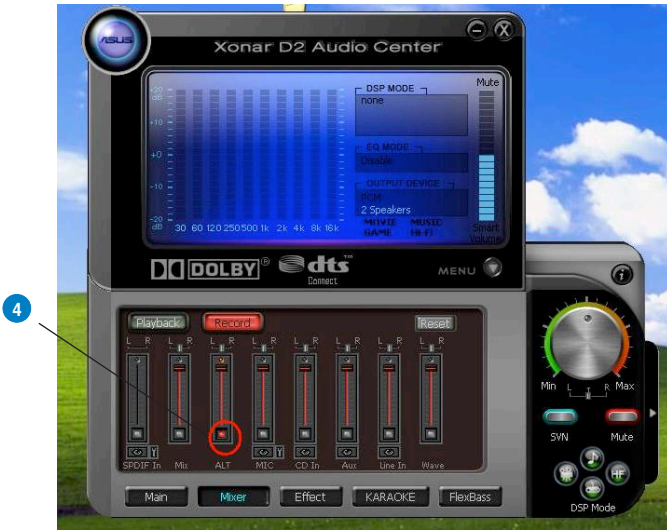

You may also choose to use an external 3.5mm line cable as follows (as short as possible) to connect the Front-Out jack to Line-In jack for loop-back testing. In that case, please select "Line In" as the recording source on the mixer page.



5. Click “Reset” on the playback volume mixer page to keep the volume setting on default.
6. Turn the master volume to the MAX level (0dB)



## 10.2 Configuration and Test with RMAA

Start RMAA and follow the setup procedure below.

1. Select both of the playback/recording devices as “ASUS Xonar D2 Audio”.
2. Select 24bit and 48kHz for the test signals. (If you change the format here, remember to go back to set the same sample rate output in the Xonar D2 Audio Center)

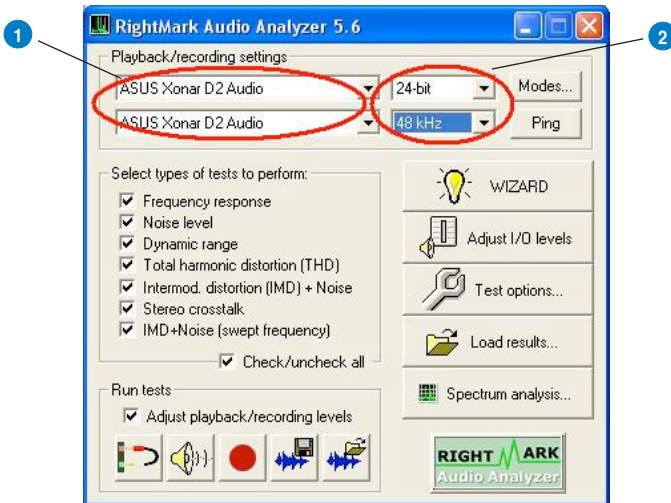

3. Click “Test options” button in RMAA and check “Analyze noise and distortion only in 20Hz-20kHz range” (audio in-band for human hearing) in the General tab.

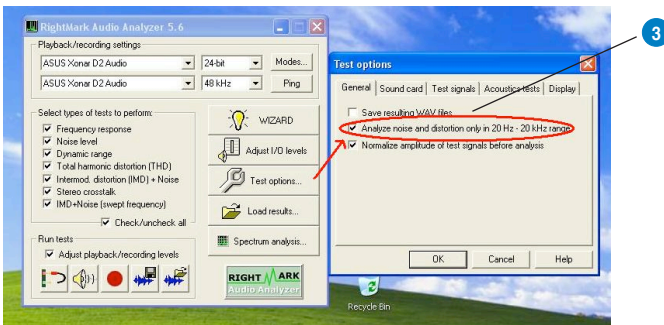

4. Go to the Sound Card tab and select "DirectSound" as the Driver Model (because Windows MME mode doesn't support high-resolution 24bit and 192KHz audio playback.)

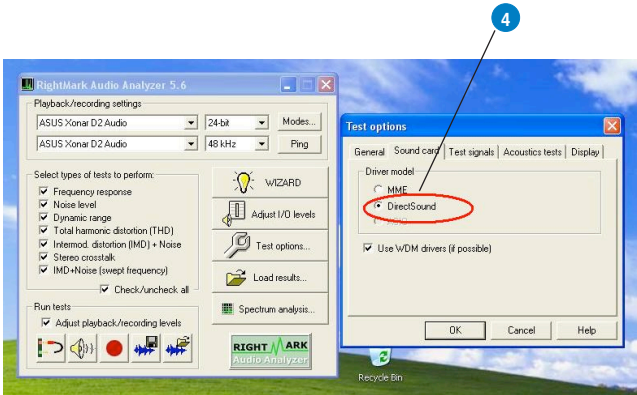

5. Click loop-back mode test button 

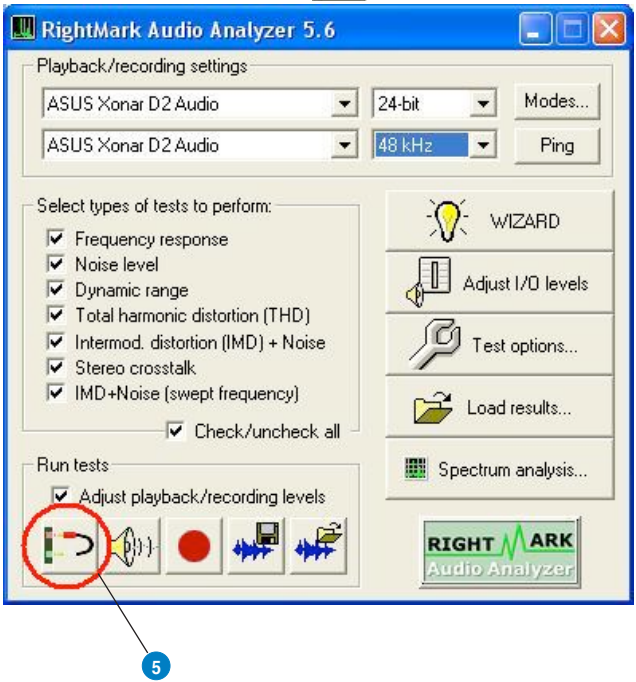

6. Check if the levels shown in the Adjusting level window are OK (the level meter will be green).

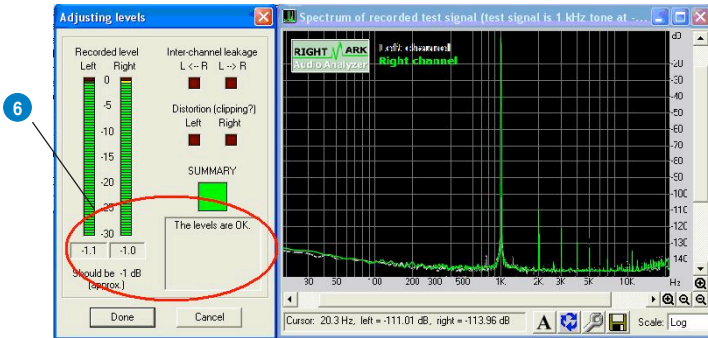

7. If the recording volume level is not enough, check and make the WAVE and Master volume have been at the maximum level; Instead, if the recording volume level is too high, lower the WAVE and Master volume gradually until the level is ok.



8. Begin the test by clicking the “Done” button. If you cannot get the level to be “ok” anyway, click “Done” anyway and proceed.

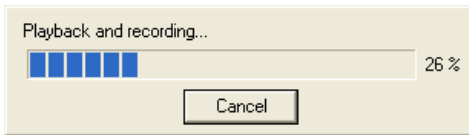
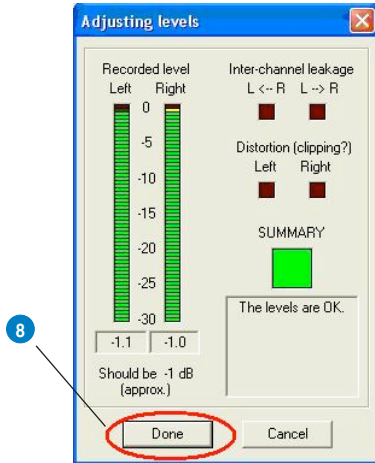

9. Enter “Xonar D2 Audio Card” in the New slot name and select one Empty slot. Then click “OK”.

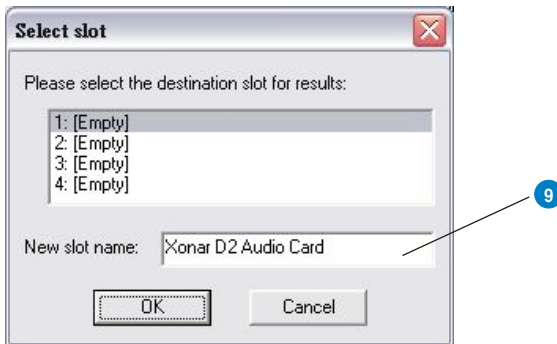

10. RMAA will pop up the Test results window. You can click “Select” checkbox and click  to make an HTML report.

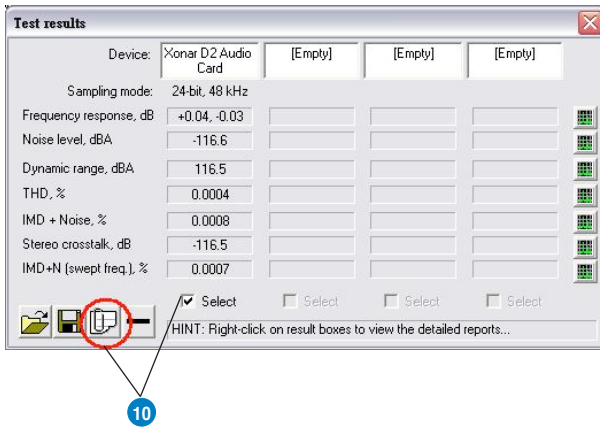

11. Check and key in the report name/options as follows. Then click “OK”.

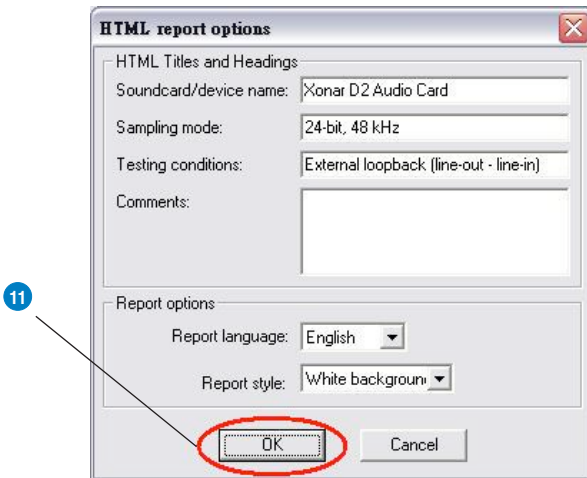

## 10.3 RMAA Testing Results

Open the html file you created and saved in the test above, then it will display the report with both data and plots in your browser. The following report is a sample and you can see how high-fidelity and crystal-clean Xonar D2 audio card is for both output and input (one of the world's finest sound cards, it has higher quality than most CE devices.) You can also try to test the performance for other sample rates and bit-depths with the same procedure.



# Xonar D2 Audio Card

## RightMark Audio Analyzer test

Testing chain: External loopback (line-out - line-in)

Sampling mode: 24-bit, 48 kHz

### Summary

Frequency response (from 40 Hz to 15 kHz), dB:	+0.04, -0.03	Excellent
Noise level, dB (A):	-116.6	Excellent
Dynamic range, dB (A):	-116.6	Excellent
THD, %:	0.0004	Excellent
IMD + Noise, %:	0.0008	Excellent
Stereo crosstalk, dB:	-116.5	Excellent
IMD at 10 kHz, %:	0.0007	Excellent

General performance: Excellent

### Frequency response

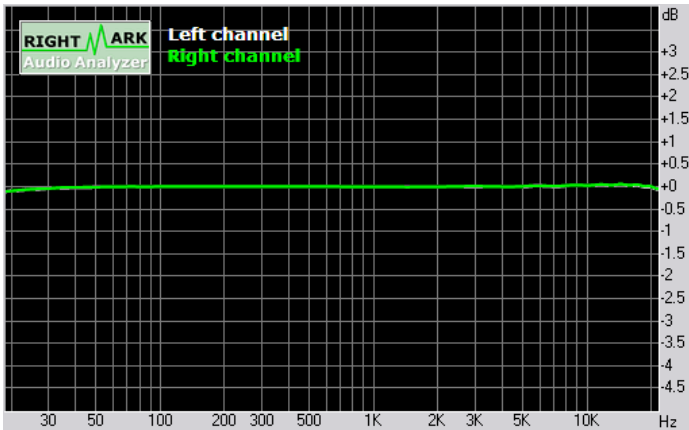

Frequency range	Response
From 20 Hz to 20 kHz, dB	-0.10, +0.04
From 40 Hz to 15 kHz, dB	-0.03, +0.04

## Noise level

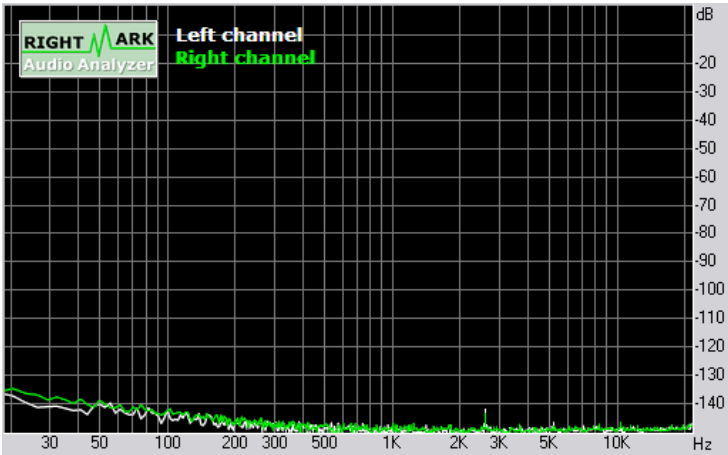

Parameter	Left	Right
RMS power, dB:	-115.5	-115.2
RMS power (A-weighted), dB:	-116.7	-116.5
Peak level, dB FS:	-92.9	-92.4
DC offset, %:	-0.00	-0.00

## Dynamic range

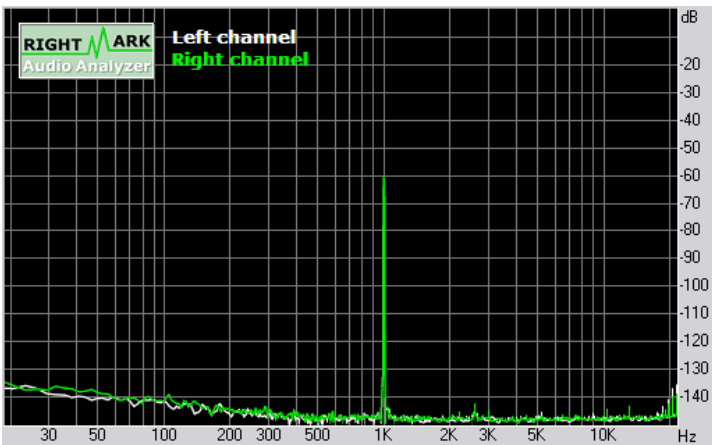

Parameter	Left	Right
Dynamic range, dB:	+115.4	+115.3
Dynamic range (A-weighted), dB:	+116.6	+116.4
Dynamic range (A-weighted), dB:	0.00	-0.00

### THD + Noise (at -3 dB FS)

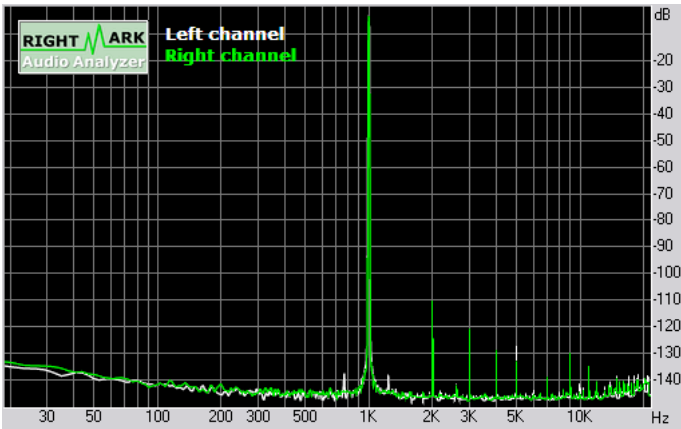

Parameter	Left	Right
THD, %:	0.0004	0.0005
THD + Noise, %:	0.0006	0.0007
THD + Noise (A-weighted), %:	0.0007	0.0008

### Intermodulation distortion

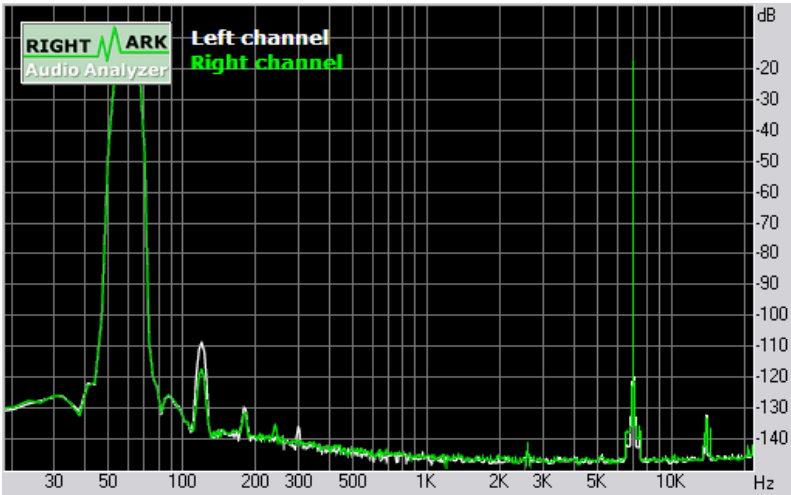

Parameter	Left	Right
IMD + Noise, %:	0.0009	0.0007
IMD + Noise (A-weighted), %:	0.0005	0.0005

### Stereo crosstalk

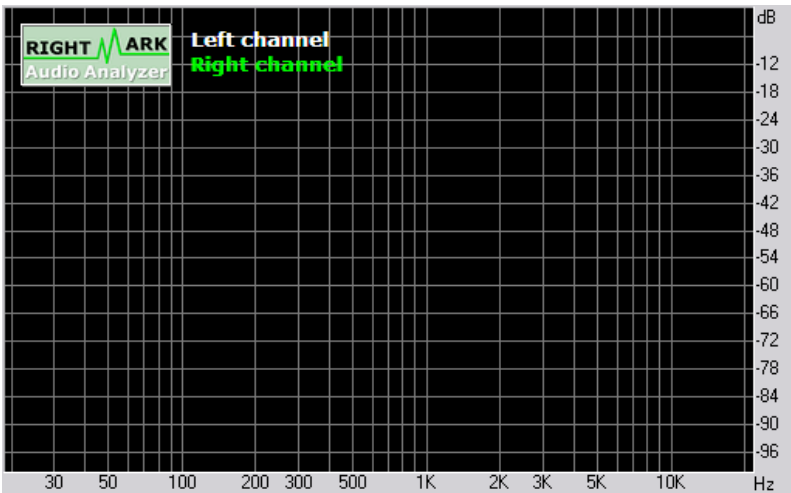

Parameter	Left	Right
Crosstalk at 100 Hz, dB:	-113	-114
Crosstalk at 1 kHz, dB:	-116	-115
Crosstalk at 10 kHz, dB:	-114	-113

### IMD (swept tones)

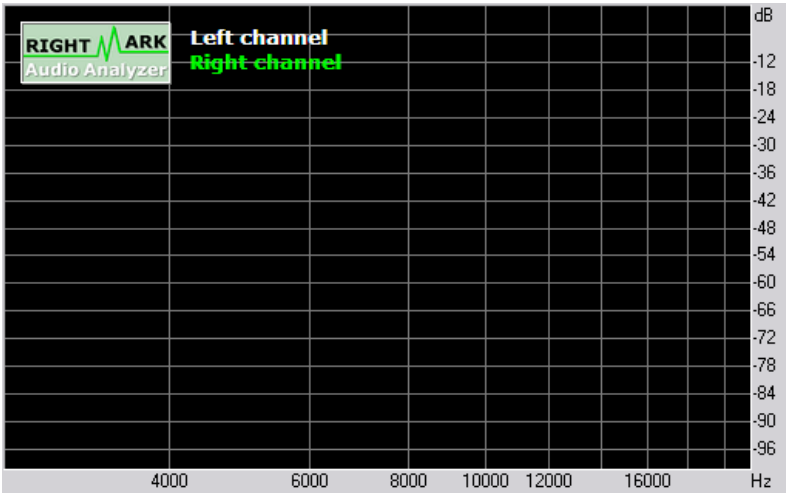

Parameter	Left	Right
IMD + Noise at 5 kHz, %:	0.0006	0.0008
IMD + Noise at 10 kHz, %:	0.0006	0.0006
IMD + Noise at 15 kHz, %:	0.0008	0.0006

\*This report was generated by RightMark Audio Analyzer 5.6

# 11. Troubleshooting and FAQs

## [Troubleshooting]

**The audio card driver could not be installed on my PC.**

**Instructions:**

1. Make sure that you have plugged the audio card in the PCI slot on your motherboard.
2. Check that the Windows hardware device manager has discovered a PCI audio device. If no device is found, please try scanning for new hardware or restart Windows.
3. Remove the card, plug it into another PCI slot, and try again.

**The PMP software could not be installed on my PC.**

**Instructions:**

Check the following points:

1. The Xonar D2 Audio Card has been installed in your PC.
2. The Xonar D2 audio card driver has been installed successfully.
3. Windows Media Player Ver. 10 or above has been installed in your PC (If it hasn't, the Xonar D2 installer will provide a guide to downloading WMP V.10. Please follow that guide and install WMP V.10 or above before you install PMP.)
4. PMP will also need an MP3 encoder installed to encode music into MP3 format (If you don't have it yet, the Xonar D2 installer will provide a guide message to download a free MP3 encoder)

**I couldn't find the Xonar D2 Audio Center**

**Instructions:**

1. Make sure you have installed the driver
2. Find the Xonar D2 Audio Center icon in the system tray on the bottom right-hand corner of the screen. Double click the icon to open the Xonar D2 Audio Center utility.



3. If the icon could not be found in the system tray, go to the Windows Control Panel and double click the "Xonar D2 Audio Center" icon to make it visible in the system tray again.
4. After the driver installation is complete, it's recommended that you reboot your computer to complete the setup. If the icon still doesn't appear, please try installing the driver package again.

## **I can't hear any sound from my analog speakers**

### **Instructions:**

1. Make sure that you have connected speakers properly and have powered on your speakers
2. Make sure that the device master volume or the software player has NOT been muted on the Xonar D2 Audio Center
3. If you are using Dolby Digital Live or DTS Interactive encoders through the S/PDIF output, the analog output will be muted to get rid of the interference between your digital speaker system and analog speakers or headphones. Check if this is the case.
4. Go to the sound and audio device of Windows Control Panel to check if the playback default device is set to Xonar D2 Audio Device, instead of other onboard AC97 or HDA codec device or Xonar D2 Audio Converter. (Xonar D2 Audio Converter is the driver for PMP music converting, not for normal playback) If it's not, please set it to Xonar D2 Audio Device and restart your applications.
5. Restart your Windows.

## **I can't hear any sound from the S/PDIF output**

### **Instructions:**

1. Ensure that you have enabled S/PDIF output in the Audio Center GUI (Main page)
2. Ensure that you are connecting the correct S/PDIF output jack on the card to the decoder's (AV receiver) S/PDIF input jack
3. You may need to select the correct input and mode of your decoder or AV receiver. For Dolby Digital or DTS output, you may have to double check that the AV receiver is in that decoding mode.
4. If you are using 192KHz PCM output, please make sure your decoder can support 192KHz decoding. Try changing it to 44.1K or 48KHz first.

## **I can't hear audio input (Mic, Line-in, CD-in, etc.) from my speakers**

### **Instructions:**

1. Go to the mixer recording page in the Audio Center and select the correct input as the recording source (Xonar D2 uses high-quality 118dB digital recording and monitoring to route the input signal through to the output.) If you are using Windows Vista, please also go to system audio control panel to see the current default recording/input device is right.
2. Remember to turn on the digital monitoring button for that recording source.

## **I can't hear the TV tuner audio from my speakers**

### **Instructions:**

1. If you are using a traditional TV tuner card which has analog audio output, please connect it to the Aux-In header on the audio card
2. Select Aux-In as the recording source and remember to turn on the digital monitoring button on the recording mixer page
3. If you are using a TV tuner card which has digital audio output instead of analog, please check that the sound is not muted and whether other applications can play sound out. If you still have problem, please read the TV tuner card's software user guide.

## **I don't see MIDI device (MPU-401) on Windows Vista. How could I use it?**

### **Instructions:**

Windows Vista doesn't show MPU-401 MIDI port on system. However, Xonar D2 did support MIDI I/O and you can directly use it to connect MIDI instruments on Vista without any setting.

## **I found no sound effects when playing 96K or 192KHz sound sources.**

### **Instructions:**

1. Currently Xonar D2 effects including Dolby/DTS support common 44.1K, 48KHz sound sources processing and will assure high-definition audio (96K/192KHz) in hi-fidelity playback. This is also usually the behavior that professional audiophiles and musicians prefer.
2. If you still want to have the effects, you can use some editing software (Ableton Live, Cakewalk, CoolEdit, Soundforge, etc.) to convert the sounds into 48KHz files.
3. Please note that the frequency meter on Xonar D2 Audio Center panel will not take effect either when the playback source is 96KHz or 192KHz sample rate to prevent any processing distortion.

## **Why couldn't PMP convert some music files successfully?**

### **Instructions:**

1. Please make sure you have installed Windows Media Player 10 or above version, and MP3 encoder in your PC. (following the pop-up downloading information to finish the installation. To download free MP3 encoder, go to: <http://www.elecard.com/download/#freeware/> )
2. PMP supports MP3, WMA, WAVE, CD source formats. AAC formats requires iTunes installed. Please check your source formats.
3. If you were converting DRM protected content, please make sure you have the valid digital right ownership.
4. Currently PMP only support common 16 bit audio sources. If you have 24 bit sources, please try converting it into 16bit formats first with some software editing tool (Ableton Live, Cakewalk, CoolEdit, Soundforge, etc.)



## [FAQ]

### **Q1: Does the Xonar D2 support Windows Vista?**

#### **Answer:**

Yes, the Xonar D2 driver package does support Windows Vista and most key features are available.

### **Q2: Why does the Xonar D2 support Dolby and DTS technologies?**

#### **Answer:**

Dolby & DTS are the ONLY brands and technologies recognized by the CE industry and available on a wide range of audio equipment. Xonar includes these features to make your PC a powerful media and entertainment center.

### **Q3: Why is Xonar D2 the best audio card for HTPC and multi-channel speakers?**

#### **Answer:**

The Xonar D2 supports Dolby Digital Live and DTS Connect, which allow a single digital connection to your AV receiver to carry Dolby Digital and DTS 5.1 audio. In addition, Xonar D2 also provides Dolby Pro-Logic IIx and DTS Neo:PC to upmix TV and other music to multi-channel surround sound in Home Theater environments. Xonar D2 also has Ultra High Fidelity SNR118dB on ALL 7.1 channel analog output at 192K/24bit, which is the best quality consumer audio card in the world. Therefore, it's also the best card to deliver the high quality audio through an analog connection to your home theater system or high-end multi-channel speakers.

### **Q4: Does the Xonar D2 support EAX on Vista?**

#### **Answer:**

Currently Xonar supports DS3D HW acceleration and EAX2.0 on Windows XP. Vista will be supported soon with an updated driver.

### **Q5: Why do I need Dolby and DTS for PC games?**

#### **Answer:**

1. Dolby Digital, Pro-Logic IIx, and DTS are available on the latest game consoles, like XBOX360, PS3, and Wii. Dolby and DTS can provide the best gaming sound experience and compatibility with home theater or TV systems.
2. Dolby Headphone and Dolby Virtual Speaker are the best 3D sound positioning, spatial modeling and 5.1-channel virtualization technology for regular stereo headphones and speakers

**Q6: What's the most important benefit of the Xonar D2 for musicians?**

**Answer:**

1. Ultimate Fidelity: Xonar D2 has the highest quality of audio in/out (118dB SNR, -108dB THD+N) for the cleanest sound production
2. Duplex HD: Supports audio sampling rates up to 24bit/192KHz for all inputs and outputs
3. ASIO 2.0: Xonar D2 includes an ASIO 2.0 driver for low-latency, low-distortion music creation application
4. Bundled Music Creation Software: Professional-grade Ableton Live and Cakewalk Production Plus Pack (Sonar LE, Dimension LE, Project5 LE)
5. Xonar D2 comes with an additional MIDI bracket board for music creators to connect dedicated MIDI devices
6. Xonar D2 contains the Portable Music Processor, to convert and process regular music with Dolby Headphone, Dolby Virtual Speaker, and Smart Volume Normalization effects.

**Q7: Does PMP software decrypt and violate the DRM of the copyright content? What's ALT technology in PMP software?**

**Answer:**

No, PMP software is not able nor intended to decrypt DRMed content. It's just a software tool used to record the analog output signal from the line-out and then convert it into WMA and MP3 files. If you have Windows Media Player 10 or iTunes DRMed music, you are required to have the valid digital rights to play it, so that PMP can record it from analog output just as any other software recorders. Xonar D2 provides Analog Loopback transformation (ALT) technology to accelerate the playback speed (2X, only on Windows XP) and record the accelerated analog signal. PMP will convert the signal back to the normal speed with very high-quality (118dB SNR), low distortion (-108dB) time-scaling algorithm. ALT technology can shorten the total conversion process. Please refer to the graph below:

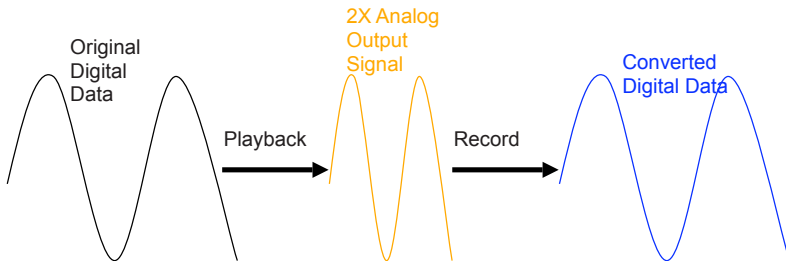

### **Q8: What's the application of "S/PDIF in loopback"?**

#### **Answer:**

"SPDIF in loopback" is the process of looping back the sound card's S/PDIF digital input signal directly to the S/PDIF output. It's useful mainly for two purposes:

- transforming electrical signals from coaxial cable to a fiber optical cable, or vice versa.
- using the PC as a SPDIF bridge (typically as a media center): for example, connect other devices like DVD players to the Xonar D2's S/PDIF input and then connect its SPDIF output to an AV receiver or decoder. When you would like to send the player device's audio to the AV receiver, you need to have the Xonar sound card's "S/PDIF in loopback" enabled to redirect the player's input signal to output to the AV receiver.

Since "SPDIF In Loopback" is the hardware's high-fidelity pass-through path, not all sound effects will be applied to the signals.

### **Q9: Will PCM sound output through S/PDIF be just 2 channels even with different analog output channels?**

#### **Answer:**

The S/PDIF protocol specification (IEC-60958) can only carry 2-channel PCM data or non-PCM AC3/DTS data. So, when a user selects PCM output for S/PDIF, the Xonar sound card will always deliver 2 channel PCM data through the S/PDIF output port. For attaining 5.1 channel surround sounds, you can select Dolby Digital Live or DTS Interactive encoding output from the S/PDIF out menu, which will allow the Xonar D2 to deliver 5.1 surround sound for games, DVD movies, and even stereo music.



## Free Manuals Download Website

<http://myh66.com>

<http://usermanuals.us>

<http://www.somanuals.com>

<http://www.4manuals.cc>

<http://www.manual-lib.com>

<http://www.404manual.com>

<http://www.luxmanual.com>

<http://aubethermostatmanual.com>

Golf course search by state

<http://golfingnear.com>

Email search by domain

<http://emailbydomain.com>

Auto manuals search

<http://auto.somanuals.com>

TV manuals search

<http://tv.somanuals.com>